

## Photometry Compendium

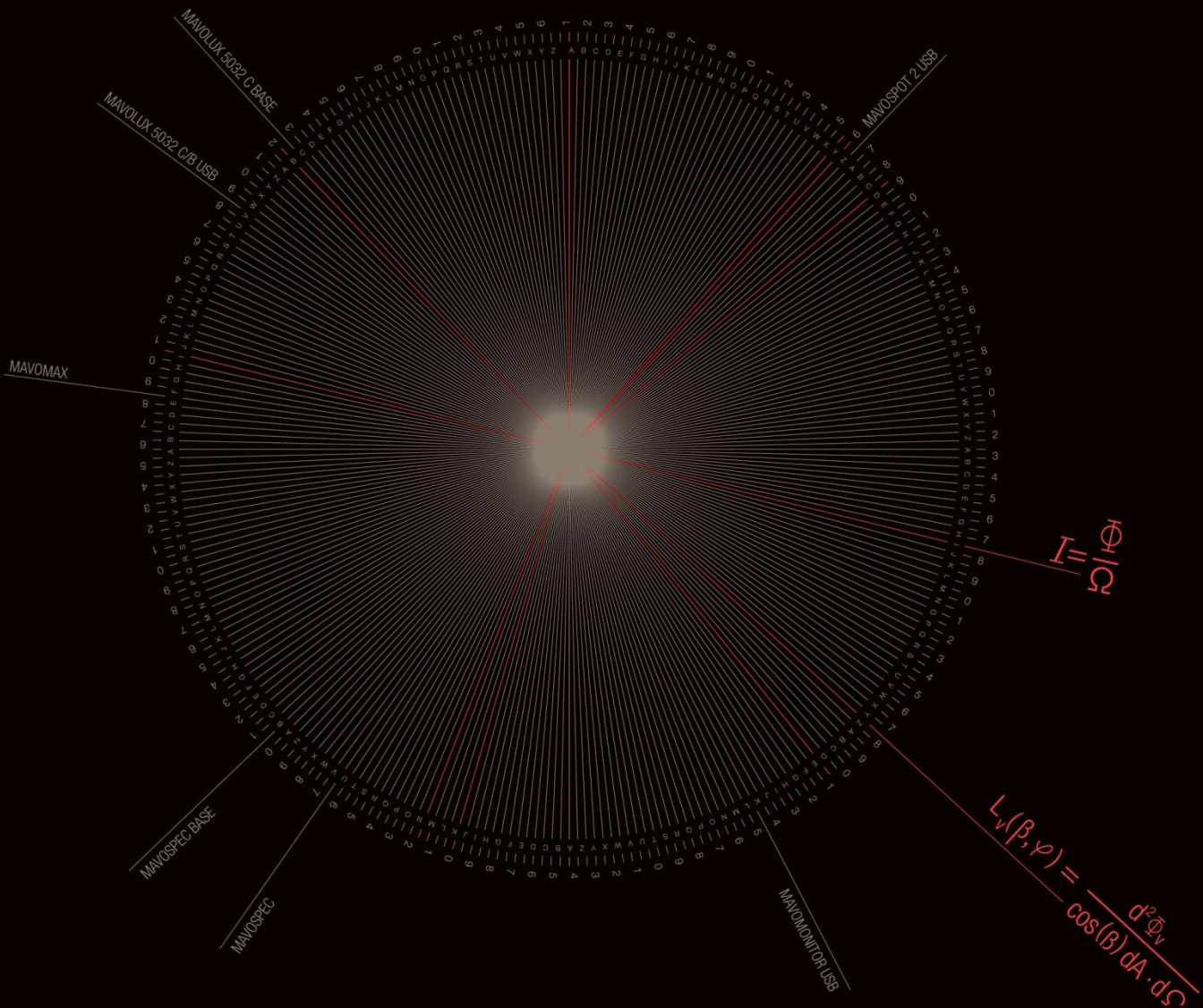

## Preface

Light is the basis of our life. It assures that plants and living organism develop, supplies us with nutrients and increases our quality of life. Over 80% of the information we gather from our environment is taken in by our eyes. Good lighting provides us with high levels of visual comfort, prevents fatigue and offers us safety and a sense of wellbeing. Creative light planning results in interesting accents in private homes, in architecture and in public areas. New knowledge concerning biologically effective lighting is leading to additional favorable effects, whose implementation has first been made inexpensively feasible by means of new LED lighting technology.



## LED – Light of the Future

In the field of lighting technology, a decisive change has taken place in recent years from the conventional light bulb to the modern LED. This development has been driven by the Europe-wide ban on conventional light bulbs with low energy efficiency, as well as an ever increasing energy-saving mentality and environmental awareness.

LED technology has experienced rapid growth in recent years thanks to the development of LEDs with very high luminous efficacy and thus outstanding energy efficiency. In combination with a long service life, impact resistance, minimal heat generation, the absence of an infrared component and fully non-toxic materials, this new technology has fully convinced the users.

The long service life makes it possible to install lamps permanently into light fixtures for the first time ever, and opens up entirely new levels of design freedom. This new generation of light fixtures is laid out in a targeted fashion for the radiant characteristics and the cooling requirements of LEDs. In place of the reflectors used as light guides with conventional round spotlights, optical systems made of plastic are frequently positioned in front of the LED today in order to direct the light efficiently. Because it's easy to control brightness and color, this artificial light can be adapted to changing

sunlight during the course of the day, thus increasing one's sense of wellbeing and improving one's performance. This biological effect of light is now being correctly understood for the first time.

LEDs have thus long since gone beyond their previous status as effects lighting and are being used for display illumination, LED displays and light fixtures. Modern means of transportation, signal systems and street lights, as well as indoor and outdoor lighting, are no longer conceivable without them.

### **New Challenges for Measuring Technology**

Whereas with conventional lighting technology it was sufficient to check illuminance and luminance, today it's also necessary to take spectrum, chromaticity, color temperature, color rendering index and flicker into consideration. The brightness and color of LEDs vary due to manufacturing processes, for which reason they have to be tested, classified and characterized during production and in their final applications.

Daylight, incandescent lightbulbs and halogen lamps all have one thing in common: excellent color rendering with the highest possible index of 100. Due to their spectra, LEDs and fluorescent tubes don't fare as well in this respect. Individual spectral ranges dominate in the case of fluorescent light, or certain spectral ranges are missing, which influences color vision.

The component manufacturers have tackled these new challenges and miniaturized spectral sensors to such a degree that these MOEMS (micro-opto-electro-mechanical systems) are permitting the development of easy-to-handle, and above all affordable spectral photometers.

GOSEN Foto- und Lichtmesstechnik GmbH offers a complete range of luxmeters and luminance meters, as well as spectrometers. As a calibration laboratory, GOSEN also issues factory calibration certificates for illuminance and luminance, as well as DAkkS calibration certificates for illuminance.

This photometry compendium explains the photometric quantities, terms and circumstances with which photometricians are frequently confronted. It offers tips for the selection of suitable measuring instruments and provides an overview of the various standards and regulations which have to be complied with when measuring photometric quantities.

Nuremberg, December 2015

Dipl.-Ing. (FH) Klaus-Peter Richter

**GOSEN** Foto- und Lichtmesstechnik GmbH

## Table of Contents

<i>What is Light?</i> .....	6
<i>Spectral Sensitivity of the Human Eye</i> .....	8
<i>Basic Photometric Terminology</i> .....	9
Luminous Flux $\Phi$ [lumen, lm] .....	9
The Ulbricht Integrating Sphere .....	9
Luminous Efficacy $\eta$ [lumen/Watt] .....	10
Solid Angle $\Omega$ [steradian, sr].....	10
Luminous Intensity $I$ [candela, cd] .....	11
Luminous Intensity Distribution Curve.....	11
Relationship Between Luminous Intensity $I$ and Illuminance $E$ .....	11
Illuminance $E$ [lx] .....	12
Mean Illuminance $\bar{E}$ .....	13
Illuminance Uniformity $U_o$ .....	13
Illuminance Irregularity $U_d$ .....	13
Horizontal Illuminance $E_h$ [lx] .....	14
Vertical Illuminance $E_v$ [lx] .....	14
Cylindrical Illuminance $E_z$ [lx] .....	15
Semi-Cylindrical Illuminance $E_{hz}$ [lx].....	16
Illuminance Maintenance Value $\bar{E}_m$ [lx].....	17
New Illuminance Value $\bar{E}_m$ [lx].....	17
Maintenance Factor .....	17
Inverse-Square Law .....	18
Light Striking a Surface at an Angle.....	19
Luminance $L$ [cd/m <sup>2</sup> ].....	20
Measurement Circle for Distance Measurement .....	20
Flicker .....	21
<i>Basic Colorimetry Terminology</i> .....	22
Spectral Power Distribution SPD [mW/m <sup>2</sup> /nm].....	22
Color Coordinates $x, y$ [CIE 1931] / $u, v$ [CIE 1960] / $u', v'$ [CIE 1976] .....	23
Color Rendering.....	23
Light Color .....	24
Color Rendering Index per DIN 6169.....	25
Lamp Color Designations.....	26

<b><i>Selection Criteria for Luxmeters and Luminance Meters.....</i></b>	<b>27</b>
Assignment to Classes.....	27
Advantageous Features .....	29
<b><i>Mandatory Calibration of Measuring Equipment.....</i></b>	<b>30</b>
<b><i>Which Measuring Instrument for Which Measured Quantity? .....</i></b>	<b>31</b>
<b><i>Which Measuring Instrument for Which Application?.....</i></b>	<b>34</b>
<b><i>Medical Technology Standard .....</i></b>	<b>36</b>
DIN 6868-157 – Acceptance and constancy test of image display systems .....	36
<b><i>Standards for Workplace Lighting .....</i></b>	<b>37</b>
DIN EN 12464-1 – Indoor Workplaces .....	37
DIN EN 12464-2 – Outdoor Workplaces .....	38
DIN EN 1838 – Emergency Lighting .....	38
German Ordinance on Workplaces (ArbStättV).....	39
Technical Rules for Workplaces – ASR .....	39
Trade Association Rules .....	40
<b><i>Bibliography .....</i></b>	<b>42</b>
<b><i>Index of Standards.....</i></b>	<b>43</b>



## What is Light?

When we speak of light we refer to the range of wavelengths from 380 nm to 780 nm from the much broader spectrum of electromagnetic radiation, which is designated visible radiation (VIS) and to which the human eye is sensitive.

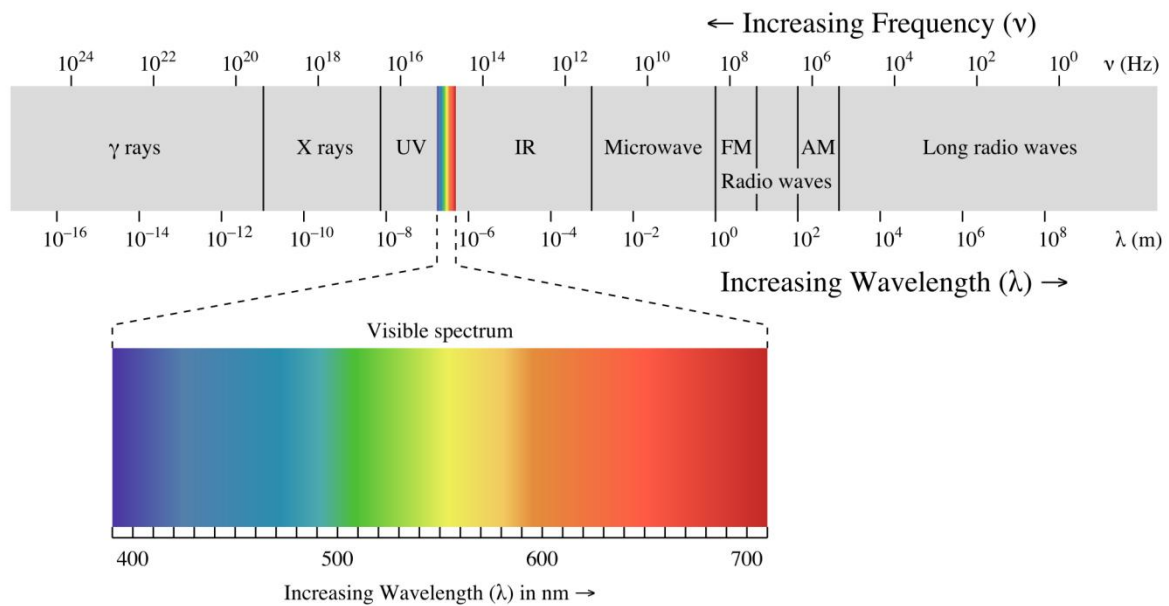

**Electromagnetic Radiation Wavelengths and Frequencies**  
(source: Wikimedia Commons - Zedh - EM spectrum.svg)

This is also frequently described as the range of optical radiation from 100 nm to 1 mm, which additionally includes the neighboring, non-visible ranges of ultraviolet and infrared radiation. Depending on the wavelength, ultraviolet radiation penetrates human skin and can tan us (UV-A), but it can also cause sunburn and conjunctivitis (UV-B, UV-C). The conversion of atmospheric oxygen into ozone and germicidal effects (UV-C) are further characteristics. Infrared radiation, which we perceive and take advantage of as warmth, is less dangerous for people.

Radiation Designation	Abbreviation	Wavelength Range
<b>Ultraviolet radiation</b>	<b>UV</b>	<b>100 nm ... &lt; 380 nm</b>
Vacuum UV	VUV UV-C	100 nm ... < 200 nm
Far UV	FUV UV-C	200 nm ... < 280 nm
Middle UV	UV-B	280 nm ... < 315 nm
Near UV	UV-A	315 nm ... < 380 nm
<b>Visible radiation, light</b>	<b>VIS</b>	<b>380 nm ... &lt; 780 nm</b>
	<i>Violet</i>	<i>380 nm ... &lt; 430 nm</i>
	<i>Blue</i>	<i>430 nm ... &lt; 490 nm</i>
	<i>Green</i>	<i>490 nm ... &lt; 570 nm</i>
	<i>Yellow</i>	<i>570 nm ... &lt; 600 nm</i>
	<i>Orange</i>	<i>600 nm ... &lt; 640 nm</i>
	<i>Red</i>	<i>640 nm ... &lt; 780 nm</i>
<b>Infrared radiation</b>	<b>IR</b>	<b>780 nm ... &lt; 1000 <math>\mu</math>m</b>
Near infrared	NIR IR-A	780 nm ... < 1.4 $\mu$ m
	NIR IR-B	1.4 $\mu$ m ... < 3.0 $\mu$ m
Middle infrared	MIR IR-C	3.0 $\mu$ m ... < 50 $\mu$ m
Far infrared	FIR IR-C	50 $\mu$ m ... < 1000 $\mu$ m

**Classification of Optical Radiation**

Wavelength  $\lambda$  is related to frequency and the speed of light in vacuum ( $c = 299,792.458 \text{ km/s}$ ).

$$\text{Wavelength } \lambda = \text{Speed of Light } c / \text{Frequency } f$$

The following SI prefixes for units of measure are usually used to designate very short wavelengths and very large frequencies.

Millimeter	1 mm = $10^{-3}$ m = 0.001 m	Thousandth
Micron	1 $\mu\text{m}$ = $10^{-6}$ m = 0.000,001 m	Millionth
Nanometer	1 nm = $10^{-9}$ m = 0.000,000,001 m	Billionth
Picometer	1 pm = $10^{-12}$ m = 0.000,000,000,001 m	Trillionth
Kilohertz	1 kHz = $10^3$ Hz = 1,000 Hz	Thousand
Megahertz	1 MHz = $10^6$ Hz = 1,000,000 Hz	Million
Gigahertz	1 GHz = $10^9$ Hz = 1,000,000,000 Hz	Billion
Terahertz	1 THz = $10^{12}$ Hz = 1,000,000,000,000 Hz	Trillion

#### SI Prefixes for Units of Measure

The spectrum, or more precisely spectral power distribution, represents the radiation power of a wavelength or a waveband. It provides us with information regarding the color characteristics of the light. We differentiate between continuous spectra which include all wavelengths and line spectra which include only individual wavelengths.

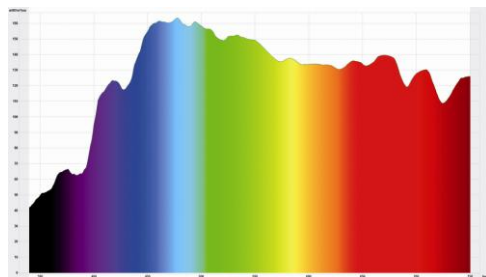

Continuous Spectrum  
Afternoon Daylight

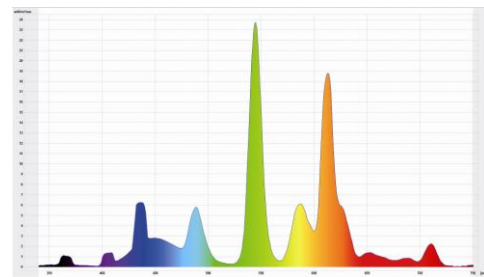

Line Spectrum  
TL8 840 Fluorescent Tube



The spectrum is measured with a spectral photometer. Additional colorimetric quantities can be calculated from the spectral power distribution.

## Spectral Sensitivity of the Human Eye

The sensitivity of the human eye to visible radiation varies depending on wavelength. Spectral sensitivity curves for the human eye have been established by the International Commission on Illumination (CIE) for the eyes of the standard observer and are standardized to a maximum value of 1. Non-standardized curves are also designated as the photometric radiation equivalent. Their maximum values are 683 lm/W for daytime vision and 1699 lm/W for night vision.

In the case of daytime vision or photopic vision, the eye is light-adapted (luminance  $> 30 \text{ cd/m}^2$ ) and a spectral sensitivity curve  $V(\lambda)$  with a maximum value in the 555 nm range (yellow-green) applies. Color-sensitive uvulae in the eyes make it possible for us to recognize colors unequivocally.

In the case of night vision or scotopic vision, the eye is dark-adapted (luminance  $< 10^{-3} \text{ cd/m}^2$ ) and a spectral sensitivity curve  $V'(\lambda)$  with a maximum value in the 507 nm range (blue-green) applies. Light-sensitive rods in the eye make it possible for us to see at these minimal levels of brightness, although we're no longer able to recognize colors.

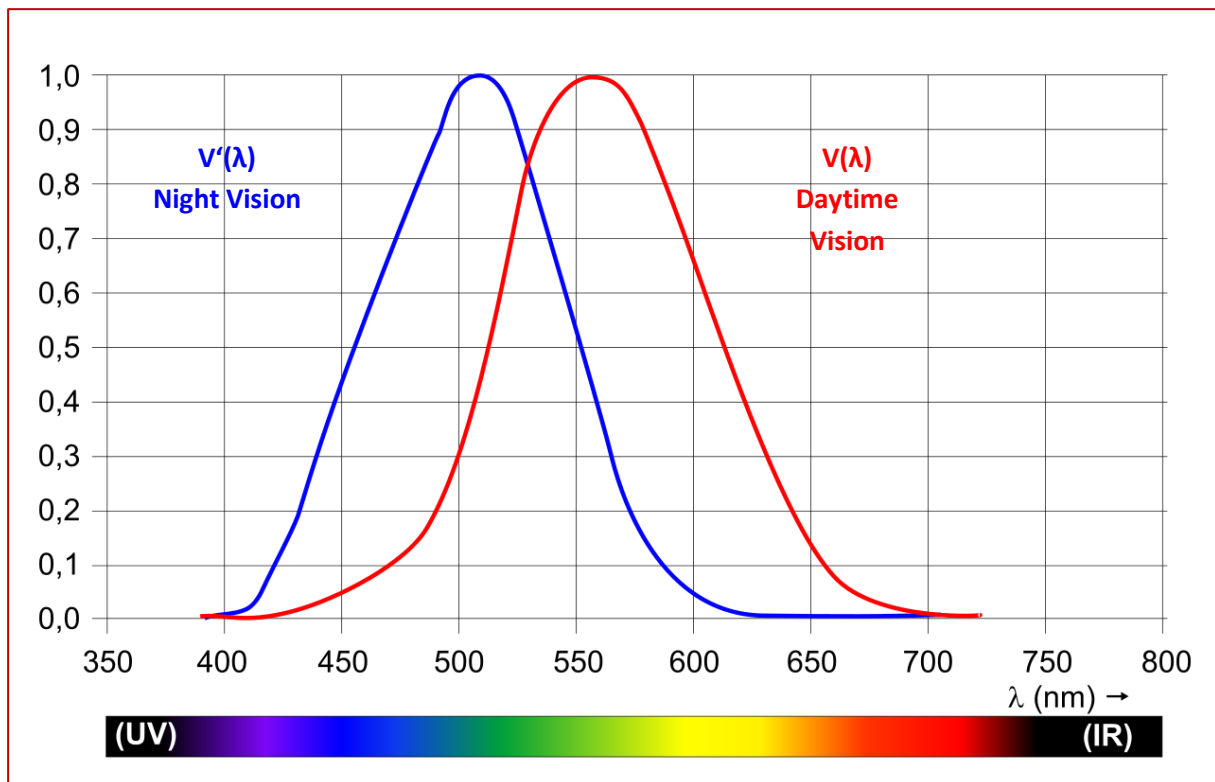

**Spectral Luminous Efficiency of the Human Eye**  
(source: Wikimedia Commons - H. Hahn - V-lambda-phot-scot.svg)

The spectral sensitivity of the human eye is taken into consideration during the photometric evaluation of light and helps determine the quantities luminous flux  $\Phi$  [lumen] and luminous intensity  $I$  [candela].



## Basic Photometric Terminology

### Luminous Flux $\Phi$ [lumen, lm]

Luminous flux  $\Phi$  is the unit of measure for the light power of a lamp and indicates total radiation power emitted from all sides of a light source, evaluated with the spectral sensitivity of the eye.



Luminous flux is integrated by means of an Ulbricht integrating sphere and illuminance is measured at the inside surface of the sphere with a luxmeter or a spectral photometer. The sphere constant, with which the measuring instrument converts illuminance into luminous flux, is determined by means of calibration with a standard light source.

Luminous flux serves as a basis for calculating further parameters and can be used to compare various light sources.

- Determination of the luminous efficacy of various luminaires
- Determination or examination of the energy efficiency of individual luminaires
- Determination or examination of the energy efficiency class of lamps and light fixtures

### The Ulbricht Integrating Sphere

An engineer named Richard Ulbricht developed one of the most important photometric procedures for measuring the luminous flux [lm] and the radiation power [mW] of a light source. The optical component required to this end was named after him.

The reflective coating on the inside surface of the hollow sphere uniformly distributes incident light over the entire inside surface of the sphere by means of diffuse reflection, thus functioning as an integrator. The measuring instrument is connected to a detector port, and as a rule it measures illuminance which is converted to luminous flux or radiation power via the sphere constant.



Light sources which only radiate into the front half-space ( $180^\circ$ ) are measured with  **$2\pi$  configuration**, i.e. they emit light through an opening into the sphere's interior. The measurement port is normally at a  $90^\circ$  angle to the input aperture and is protected against direct light irradiation by a shade. Light sources which emit in all directions ( $360^\circ$ ) are measured with  **$4\pi$  configuration**, i.e. they are mounted at the center of the sphere, thus necessitating a larger sphere diameter.

Barium sulfate ( $\text{BaSO}_4$ ) is used as the coating for large spheres for the UV/VIS range, and PTFE (Teflon) is used for smaller and medium sized spheres for the UV/VIS range. Gold is used for the NIR/IR range.

Self-absorption resulting from larger and/or darker test objects mounted inside the sphere can be compensated for with an auxiliary light source installed in the sphere's interior.

## Luminous Efficacy $\eta$ [lumen/Watt]

The quotient of **luminous flux  $\Phi$**  and **electrical power  $P$**  used to generate luminous flux is designated **luminous efficacy  $\eta$**  [lm/W]. It's the measure of the economic efficiency of a luminaire.

$$\eta = \Phi / P$$

In the case of luminaires which are operated with a ballast such as gas discharge lamps and LEDs, power consumption of the entire system is often taken into consideration. In this case we speak of system luminous efficacy. The lamp's individual luminous flux is also frequently specified, and then we speak of lamp luminous efficacy. The theoretical upper limit for luminous efficacy is 683 lm/W for monochromatic light.

**Example:** An LED lamp with power consumption amounting to 12 W emits a luminous flux of 850 lm. Luminous efficacy is thus  $850 \text{ lm} / 12 \text{ W} = 70.8 \text{ lm/W}$ .



Commercially available LED lamps for routine daily use currently have a luminous efficacy of 80 to 90 lm/W. Under laboratory conditions, values of up to 200 lm/W and more have been obtained. In contrast, very good halogen lamps are rated at roughly 20 lm/W, and efficient fluorescent lamps at 80 to 100 lm/W.

## Solid Angle $\Omega$ [steradian, sr]

Solid angle  $\Omega$  plays an important role in the spatial observation and definition of photometric quantities. It's defined as part of sphere surface  $A$ , limited by a cone with opening angle  $\alpha$ , divided by the square of sphere radius  $r$ .

$$\Omega = A / r^2 = 2 \cdot \pi \cdot (1 - \cos(\alpha / 2))$$

If we consider a unit sphere where  $r = 1 \text{ m}$ , the surface of the sphere is thus  $4 \cdot \pi \cdot r^2$ , i.e.  $4 \cdot \pi \text{ m}^2$ , and the full solid angle is  $4 \cdot \pi \text{ sr}$ . A solid angle of  $\Omega = 1 \text{ sr}$  cuts out a 1 square meter section of the surface of a sphere with a radius of 1 m.

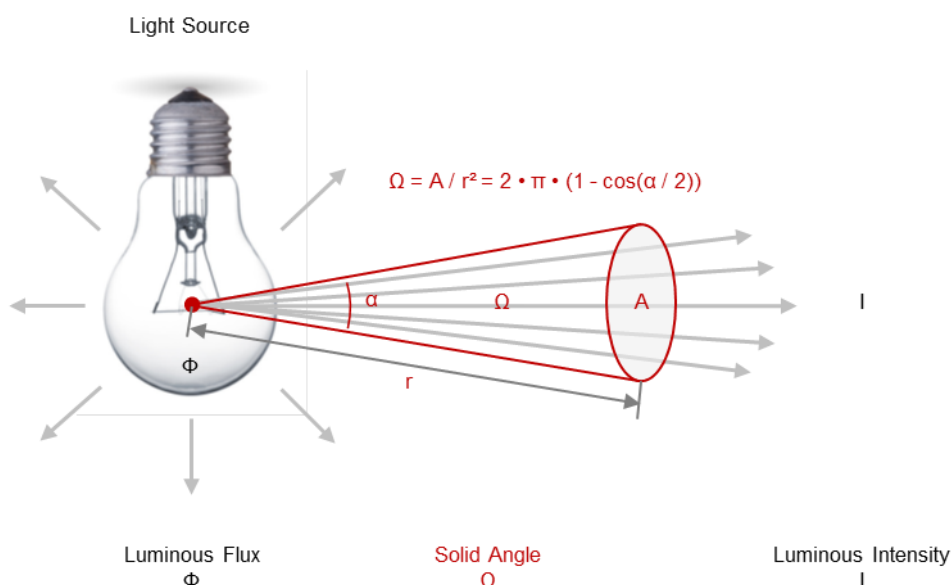

## Luminous Intensity I [candela, cd]

Luminous intensity I is luminous flux  $\Phi$  per solid angle  $\Omega$  and reflects the intensity of the luminous flux which is emitted in a given direction. As a rule, light sources emit their luminous flux at different intensities in the various individual directions.

$$I = \Phi / \Omega$$

## Luminous Intensity Distribution Curve

The luminous intensity distribution curve describes the photometric characteristic of a light source. It's frequently represented in the C-plane system where  $0^\circ$  is vertically underneath the light source. C-plane C0-C180 is aligned perpendicular, and plane C90-C270 parallel to the lamp.

The luminous intensity distribution curve makes it very quickly apparent whether the light source has a wide or a narrow light cone, whether or not there are any asymmetries and whether light is emitted in the upward or downward direction

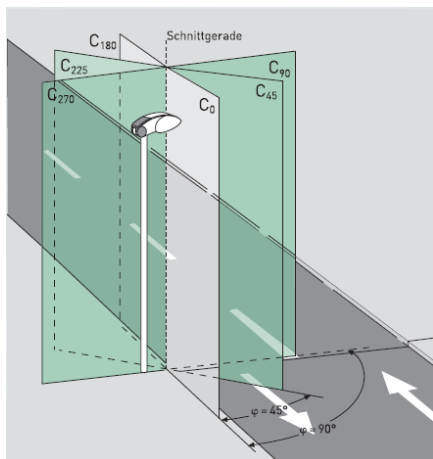

**C-Plane System**

(source: TRILUX Beleuchtungspraxis

Außenbeleuchtung wiki.watt24.com )

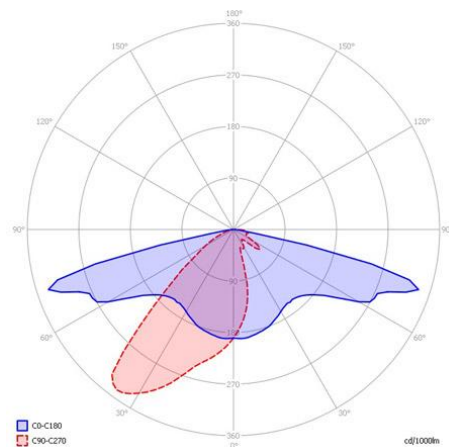

**LED Street Light  
ufm-6469, Asymmetric, Type 01**  
(source: silencilights)



As a rule, the luminous intensity distribution curve is ascertained by means of a goniophotometer consisting of a mechanical setup with horizontal and vertical axes for rotating the test object and a photometer for measuring luminous intensity.

## Relationship Between Luminous Intensity I and Illuminance E

Reformulating the inverse-square law results in the following relationship between luminous intensity I and illuminance E.

$$I = E * r^2$$

This makes it plainly apparent that at distance r of 1 meter the value of luminous intensity I in cd is the same as the value of illuminance E in lx.

**Examples:** A lamp radiates uniformly with a luminous flux  $\Phi$  of 1000 lm. Mean luminous intensity  $I$  of this lamp is thus  $1000 / 4\pi = 79.6$  cd. At a distance of 1 meter from the lamp, an average of 79.6 lx can be measured with a  $V(\lambda)$ -corrected luxmeter.

A lamp radiates uniformly over the entire solid angle  $4\pi$ , i.e. into the sphere's interior space. If uniform luminous intensity  $I = 1$  cd, the lamp's overall luminous flux  $\Phi = 4\pi$  lm = 12.57 lm.

## Illuminance E [lx]

**Illuminance E** is **luminous flux  $\Phi$**  relative to illuminated **surface A** and indicates with which intensity the surface is being illuminated.

$$\text{Illuminance } E = \text{Luminous Flux } \Phi / \text{Illuminated Surface } A$$

**Example:** If a light source emits a luminous flux amounting to one lumen and if this flux uniformly illuminates a surface of one square meter, illuminance is 1 lx. This corresponds roughly to a normal candle flame at a distance of one meter.

Illuminance is used for **planning interior lighting**. However, illuminance does not indicate the brightness impression of a room, because this depends to a great extent on the room's reflective characteristics. A white room gives a much brighter impression than a dark room.



Illuminance is measured with luxmeters.



GOSSEN Luxmeter – MAVOLUX 5032 B USB

## Mean Illuminance $\bar{E}$

As a rule, uniform light distribution is not achieved with normal lighting, for which reason **specifications in the standards** usually make reference to **mean illuminance  $\bar{E}$** . This value is calculated as the weighted **arithmetic mean** of all measured illuminance values in the room.

$$\bar{E} = (E_1 * A_1 + E_2 * A_2 + \dots + E_{n-1} * A_{n-1} + E_n * A_n) / (A_1 + A_2 + \dots + A_{n-1} + A_n)$$

If a **uniform evaluation grid** is used, the individual grid points don't have to be weighted with the sub-surfaces and mean illuminance is calculated as the **arithmetic mean** of all measured illuminance values in the room.

$$\bar{E} = (E_1 + E_2 + \dots + E_{n-1} + E_n) / n$$

## Illuminance Uniformity $U_o$

**Illuminance uniformity  $U_o$**  is the relationship of **lowest illuminance  $E_{min}$**  to **mean illuminance  $\bar{E}$**  on the evaluated surface.

$$U_o = E_{min} / \bar{E}$$

Work areas must be as uniformly illuminated as possible. Limit values for this parameter are included in the applicable standards and regulations.

## Illuminance Irregularity $U_d$

**Illuminance irregularity  $U_d$**  is the relationship of **lowest illuminance  $E_{min}$**  to **maximum illuminance  $E_{max}$**  on the evaluated surface.

$$U_d = E_{min} / E_{max}$$

## Horizontal Illuminance $E_h$ [lx]

**Horizontal illuminance**  $E_h$  is measured on horizontal or nearly horizontal planes and serves as an evaluation parameter for lighting levels in many regulations and standards.

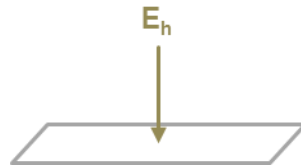

Generally speaking, horizontal illuminance is measured at a height of 0.85 m, for office workplaces (desks) at a height of 0.75 m and in traffic routes, staircases and driveways at a height of 0.2 m.

## Vertical Illuminance $E_v$ [lx]

**Vertical illuminance**  $E_v$  is measured on vertical planes and serves as an evaluation parameter for lighting levels of surfaces on room partitions, cabinets and shelves. It assures that labelling on ring binders, book bindings and storage boxes in offices, warehouses, libraries and archives is legible.

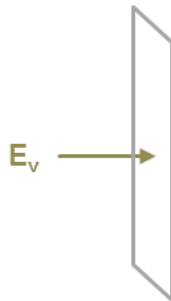

Vertical illuminance is measured at a height of 0.5 to 2.00 m for work areas involving “reading at cabinets and on shelves”. Mean vertical illuminance  $E_v$  should be at least 175 lux. For activities which are conducted frequently and for lengthy periods of time, for example in libraries and archives, mean vertical illuminance  $E_v$  should be at least 300 lux.



## Cylindrical Illuminance $E_z$ [lx]

**Cylindrical illuminance  $E_z$**  is used as an evaluation parameter for the lighting levels of vertical surface of 3D objects and is also a measure of a room's brightness impression. It's the mean value of all vertical illuminance values from all directions in space.

Bright faces, which result from adequate vertical illuminance, are a prerequisite for good visual communication. Due to the fact that the orientation of the faces changes, and because vertical illuminance in the various direction in space usually remains nearly constant where office lighting is concerned, cylindrical illuminance is a suitable evaluation parameter for this purpose.



Cylindrical illuminance can be measured directly with special luxmeters which include an integrated photometer head. Since these measuring instruments are not frequently available, vertically measuring luxmeters can be used to obtain approximate values.

**Cylindrical illuminance  $E_z$**  can be determined **roughly as the arithmetic mean** of the **vertical illuminance  $E_{v_i}$**  values measured in the four directions of space.

$$E_z = (E_{v1} + E_{v2} + E_{v3} + E_{v4}) / 4$$

This method can result in considerable deviations in comparison with photometers for lighting fixtures with point light sources.

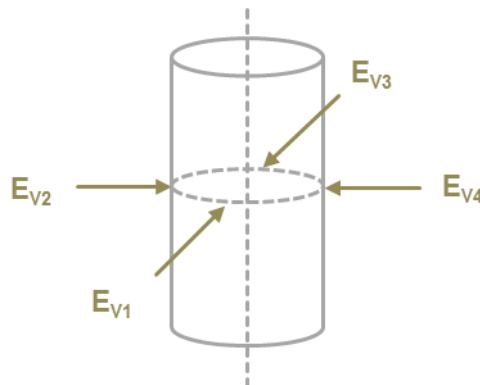

**i** Mean cylindrical illuminance  $E_z$  is measured at a height of 1.20 m. For work spaces involving "monitor screens and office work" as well as "conference rooms" with a mean horizontal illuminance  $E_h$  of up to 500 lx,  $E_z$  should amount to at least 175 lux. Above and beyond this, a mean cylindrical illuminance  $E_z$  of at least  $0.33 \times E_h$  is required. For surrounding areas with a mean horizontal illuminance of up to 300 lx,  $E_z$  should amount to at least 100 lux. Above and beyond this, a mean cylindrical illuminance  $E_z$  of at least  $0.33 \times E_h$  is required. Insofar as mean cylindrical illuminance is complied with at a height of 1.20 m, it can be assumed that it's also adequate for standing employees at a height of 1.65 m.

## Semi-Cylindrical Illuminance $E_{hz}$ [lx]

**Semi-cylindrical illuminance  $E_{hz}$**  is used as an evaluation parameter for good 3D vision out of doors, especially with regard to the ability to recognize faces. It's the mean value of all vertical illuminance values within an angle range of  $-90^\circ$  to  $+90^\circ$  around a vertical axis. Semi-cylindrical illuminance is measured at a height of 1.5 m for all viewing directions. As a rule, two main directions are adequate for the evaluation of pathways and four for open spaces. The semi-cylindrical measuring surface reflects the shape of the human face. An accordingly high semi-cylindrical illuminance value should counteract the subjective feeling of insecurity and the risk of criminality.



Semi-cylindrical illuminance can be measured directly with special luxmeters which include an integrated photometer head. Since these measuring instruments are not frequently available, vertically measuring luxmeters can be used to obtain approximate values.

**Semi-cylindrical illuminance  $E_{hz}$**  can be determined **roughly** based on **vertical illuminance  $E_{vi}$**  values measured in the three directions of space.

$$E_{hz} \sim 0.5 * E_{v1} + 0.25 * (E_{v2} + E_{v3})$$

This method can result in considerable deviations in comparison with photometers for lighting fixtures with point light sources.

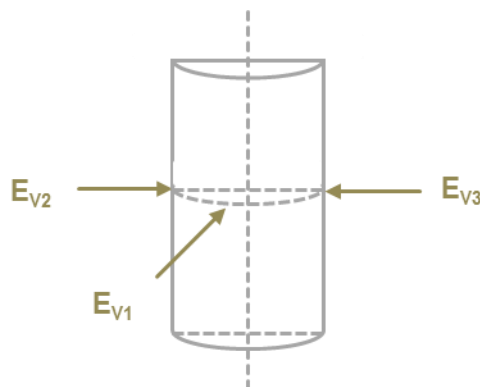

## Illuminance Maintenance Value $\bar{E}_m$ [lx]

The **illuminance maintenance value**  $\bar{E}_m$  is the value below which mean illuminance  $\bar{E}$  may not drop on a surface. If this value is fallen short of, maintenance is required.



For indoor workplaces, DIN EN 12462-1 includes entries regarding required maintenance values for illuminance in various rooms, as well as for various tasks or activities. DIN EN 12464-2 lists these values for outdoor workplaces.

## New Illuminance Value $\bar{E}_i$ [lx]

The **new illuminance value**  $\bar{E}_i$  is the mean illuminance  $\bar{E}$  of a new system. As a system becomes older, illuminance decreases due to ageing and contamination of lamps, light fixtures and rooms. In order to compensate for this decrease in illuminance during the service life of the system, a higher illuminance value is specified for new systems, namely **new illuminance value**  $\bar{E}_i$ . The lighting designer determines the relationship to the **illuminance maintenance value**  $\bar{E}_m$  via the **maintenance factor**.

$$\text{New Value } \bar{E}_i = \text{Maintenance Value } \bar{E}_m / \text{Maintenance Factor}$$

## Maintenance Factor

In accordance with DIN EN 12464-1 and DIN 12464-2, the designer must determine the maintenance factor individually in consideration of the lighting fixture, the environment and the specified maintenance schedule. The maintenance factor depends on how quickly the lamps, the ballast and the luminaires age, on the amount of dust and contamination in the environment and on the maintenance schedule. The maintenance schedule includes intervals for replacing the luminaires and cleaning the lamps and the room, as well as the cleaning method.

Operating influences are frequently not yet known when the lighting system is being planned. In this case, the designer will frequently make use of reference maintenance factors:

- 0.8 for very clean rooms and systems which are used for short periods of time
- 0.67 for clean rooms – 3-year maintenance cycle (normal office)
- 0.57 for indoor and outdoor lighting, normal contamination – 3-year maintenance cycle
- 0.50 for indoor and outdoor lighting, heavy contamination

As opposed to individual determination of the maintenance factor, this procedure involves the risk that lighting systems will be over-dimensioned.

**Example:** For an office workplace with an illuminance value of 500 lx in a room, a new value of 500 lx / 0.67 = 746.27 lx would be required for a 3-year maintenance cycle.



Detailed information concerning determination of the maintenance factor can be found in the free **Guide to DIN EN 12464-1, “Lighting of work places – Part 1: Indoor work places”** at [http://www.licht.de/fileadmin/Publikationen\\_Downloads/Guide\\_DIN-EN-12464-1.pdf](http://www.licht.de/fileadmin/Publikationen_Downloads/Guide_DIN-EN-12464-1.pdf).

## Inverse-Square Law

If a lamp emits a luminous flux  $\Phi$  from the center of a sphere into solid angle  $\Omega$  and the **radius of the sphere** is  $r$ , **illuminance E** of **surface A** can be ascertained by dividing incident **luminous flux  $\Phi$**  by **illuminated surface A**.

$$E = \Phi / A = (\Omega \cdot I) / (\Omega \cdot r^2) = I / r^2$$

where  $\Phi = \Omega \cdot I$  and  $A = \Omega \cdot r^2$

If the definitions “luminous flux  $\Phi =$  solid angle  $\Omega \cdot$  luminous intensity  $I$ ” and “surface  $A =$  solid angle  $\Omega \cdot$  the square of the sphere’s radius  $r^2$ ” are inserted into the equation, this results in the equation for the inverse-square law.

The inverse-square law says that illuminance decreases with the square of the distance between the light source and the illuminated surface.

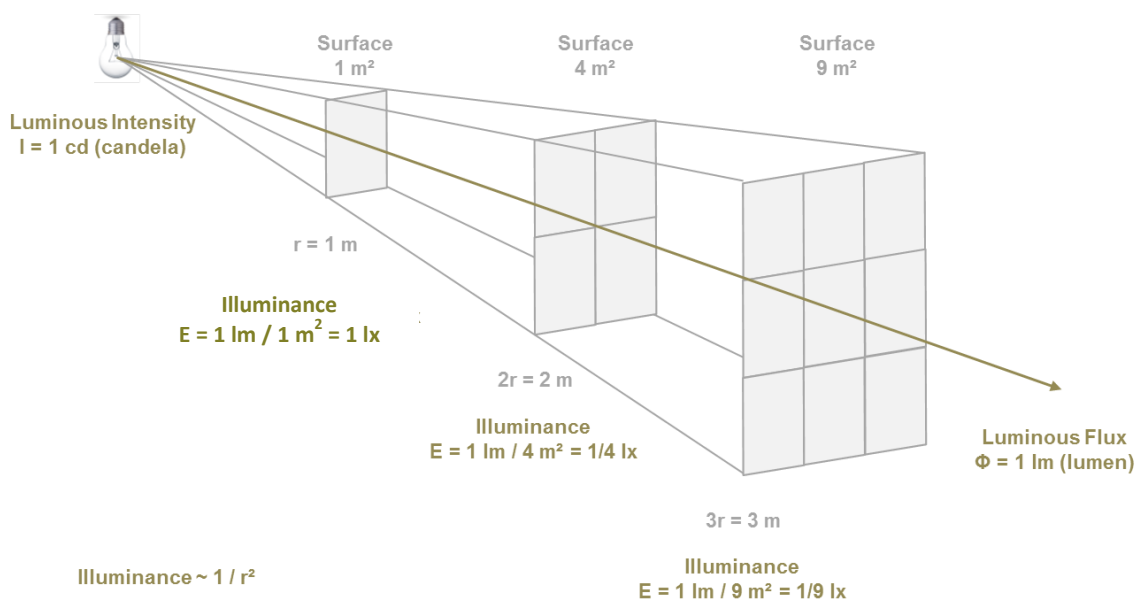

**i** In actual practice, the inverse-square law means that when the illumination distance is doubled the number of lamps must be increased quadratically in order to maintain the same level of illuminance.

**Example:** A lamp was calibrated by the German Federal Institute of Physics and Metrology (PTB) and consumes the nominal current specified in the test report for the desired color temperature of 2856 K. Luminous intensity  $I$  of the lamp at nominal current is 140 cd.

Which value for illuminance  $E$  results in a distance of 2.5 m perpendicular to the surface in the specified direction of radiation?

$$E = 140 \text{ cd} / (2.5\text{m})^2 = 140 \text{ cd} / 6.25 \text{ m}^2 = \mathbf{22.4 \text{ lx}}$$

Which value for illuminance  $E$  results in a distance of 1.25 m?

$$E = 140 \text{ cd} / (1.25\text{m})^2 = 140 \text{ cd} / 1.5625 \text{ m}^2 = \mathbf{89.6 \text{ lx}}$$

This makes it apparent that when distance is doubles, only  $\frac{1}{4}$  of the illuminance remains.

## Light Striking a Surface at an Angle

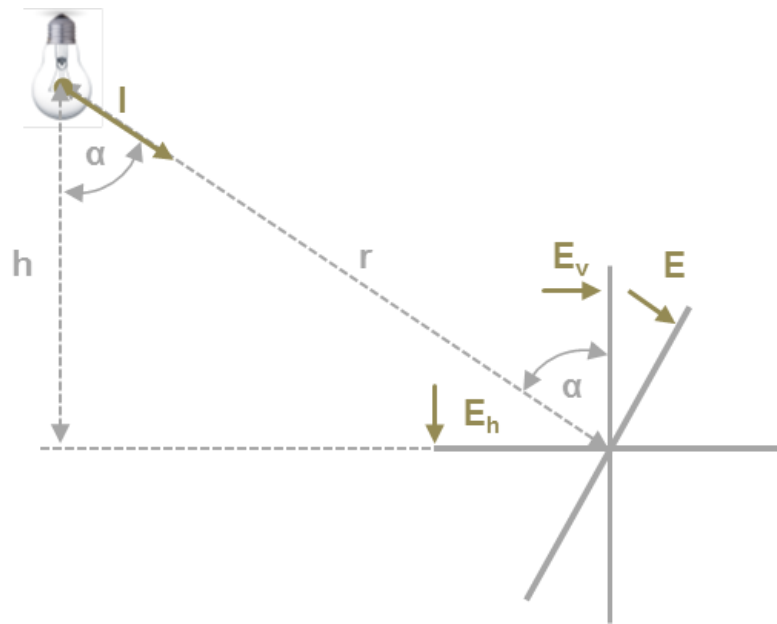

If the illuminated surface is laterally offset relative to the source of light, i.e. if the light does not strike the surface at a right angle, illuminance is reduced. If the light source is located at height  $h$  above the horizontal plane and angle of radiation  $\alpha$  makes reference to the vertical, horizontal illuminance  $E_h$  and vertical illuminance  $E_v$  are calculated as follows:

$$E_h = E * \cos \alpha$$

$$E_v = E * \sin \alpha = E_h * \sin \alpha / \cos \alpha = E_h * \tan \alpha$$

**i** In routine daily practice, installation height  $h$  above the horizontal plane, luminous flux  $I$  and angle of radiation  $\alpha$  are known.

Calculation of horizontal illuminance  $E_h$  on the basis of these figures necessitates reformulation of the above equation.

If  $E = I / r^2$  and  $r = h / \cos \alpha$ , then

$$E = I / (h / \cos \alpha)^2 = I * \cos^2 \alpha / h^2$$

$$E_h = E * \cos \alpha = I * \cos^3 \alpha / h^2$$

**Example:** A light source emits luminous flux  $I$  with a value of 200 cd at a radiation angle  $\alpha$  of  $10^\circ$  from the vertical onto a surface. Height  $h$  of the light source above the surface is 2 m. Horizontal illuminance  $E_h$  at the surface is:

$$E_h = I * \cos^3 \alpha / h^2 = 200 \text{ cd} * (\cos 10^\circ)^3 / 2^2 \text{ m}^2 = 200 \text{ cd} * 0.9551 / 4 \text{ m}^2 = 47.76 \text{ lx}$$

## Luminance L [cd/m<sup>2</sup>]

**Luminance L** indicates the brightness impression perceived by the eye when positioned in front of **self-luminous or illuminated surface A**.

$$\text{Luminance } L = \text{Luminous Intensity } I / \text{Surface } A$$

Luminance is used for **planning outdoor lighting**. It describes the physiological effect of light on the eye and is the only visible light quantity.



Luminance can be determined either by means of contact measurement in the case of self-luminous surfaces or by means of a distance measurement in the case of self-luminous or illuminated surfaces. Special luminance meters are used to this end, or a luxmeter with a luminance attachment can be used to obtain a ballpark measurement.

## Measurement Circle for Distance Measurement

In the case of the distance measurement, luminance meters with a tight measuring angle are used as a rule. They usually have an optical viewfinder making it possible to aim at the surface to be measured.

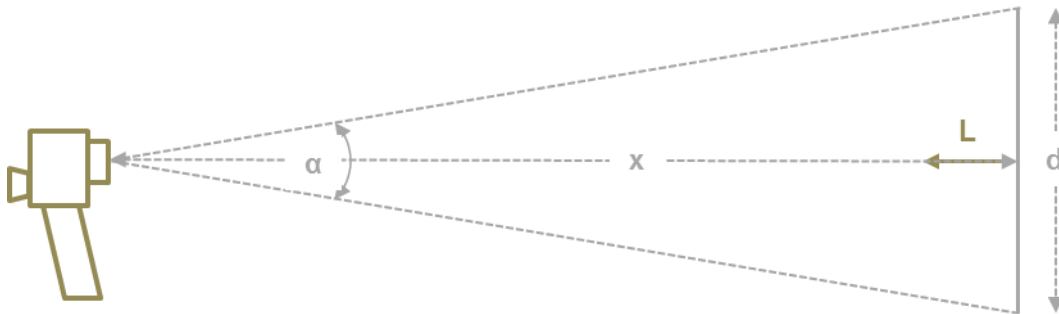

Diameter  $d$  of the measuring circle can be calculated from measuring angle  $\alpha$  and distance  $x$  with the help of the following trigonometric function:

$$d = 2 * \tan(\alpha / 2) * x$$

**Example:** A luminance meter has a measuring angle of  $1^\circ$  and can measure distance from 1 m to  $\infty$ . Smaller distances within a range of 51 to 100 cm are made possible with close-up lens 1, and within a range of 34 to 50 cm with close-up lens 2. Which measurement circle ranges result for the two close-up lenses?

$$d = 2 * \tan(\alpha / 2) * x = 2 * \tan(1^\circ / 2) * x = 2 * 0.00873 * x = 0.01746 * x$$

	Measuring Distance	Measuring Circle Diameter
Close-up lens 1	51 ... 100 cm	8.9 ... 17.46 mm
Close-up lens 2	34 ... 50 cm	5.94 ... 8.73 mm



## Flicker

**Flicker** is caused by supply voltage deviations which result in fluctuations in the brightness of the light. These fluctuations influence human health and may trigger epileptic seizures, migraine headaches, tiredness, constrained vision, distraction and impaired vision.

$$\text{Flicker as a Percentage} = 100\% \times (A-B) / (A+B)$$

$$\text{Flicker Index} = \text{Surface 1} / (\text{Surface 1} + \text{Surface 2})$$

$$\text{Flicker Frequency} = 1 / t$$

A good LED driver smooths out voltage fluctuation and prevents flicker. The **flicker value** is a **measure for the quality of the lamp or light fixture**, and should be as low as possible.

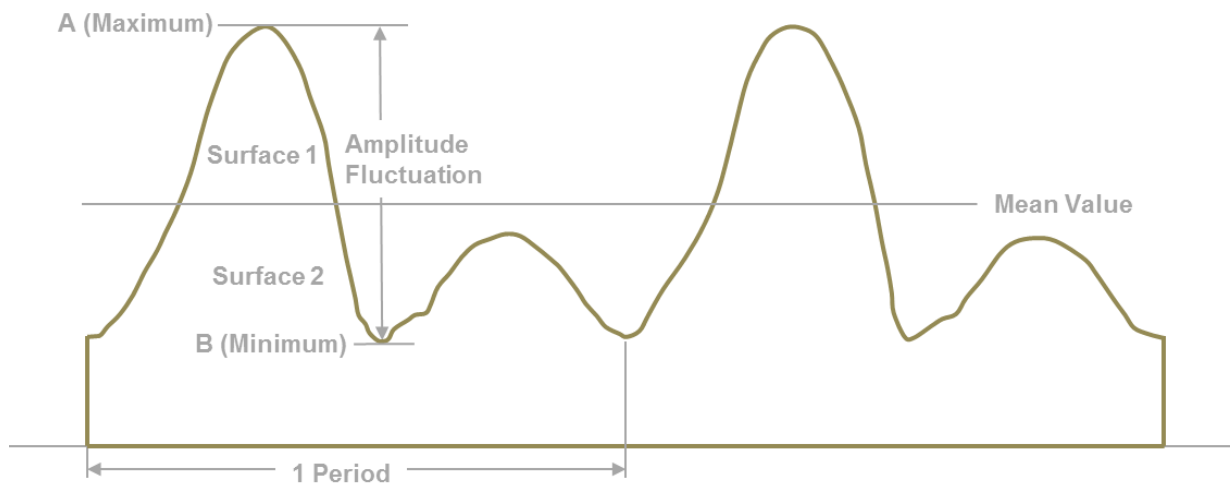

Flicker can be measured with special flicker meters, or with spectral photometers which are equipped with this function.

## Basic Colorimetry Terminology

### Spectral Power Distribution SPD [mW/m<sup>2</sup>/nm]

Spectral power distribution represents the radiant power of a light source for a wavelength or a waveband in the visible range. It provides us with information about the color characteristics of a light source, and can be used to compare the color temperatures of different light sources.

Examples of spectral power distribution are included below for various light sources.

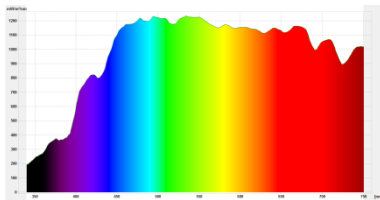

Afternoon daylight, CCT = 5319 K, Ra = 99.2

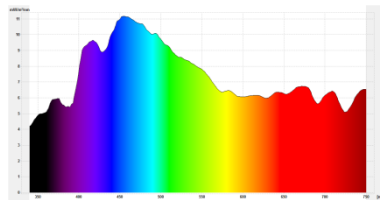

Evening daylight, CCT = 8819 K, Ra = 95.3

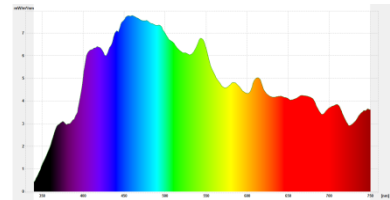

Evening daylight through a window, CCT = 8319 K, Ra = 98.3

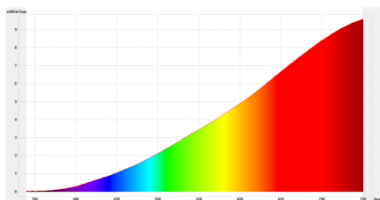

Halogen, CCT = 2714 K, Ra = 99.0

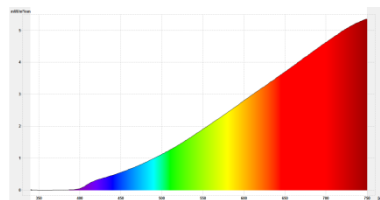

Halogen + UV stopper, CCT = 2646 K, Ra = 99.0

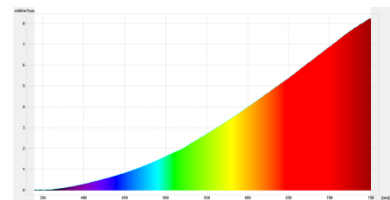

Light bulb, CCT = 2634 K, Ra = 99.8

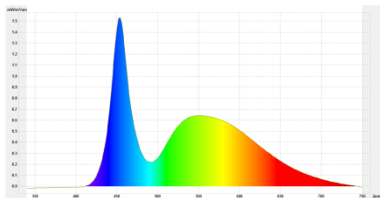

Cold white LED, CCT = 7439 K, Ra = 80.0

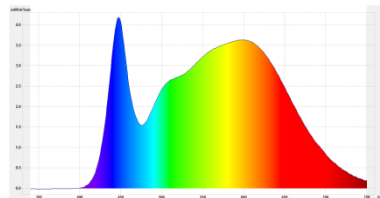

Neutral white LED, CCT = 4362 K, Ra = 89.9

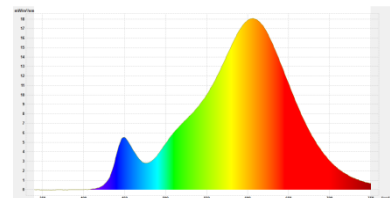

Warm white LED, CCT = 2707 K, Ra = 81.2

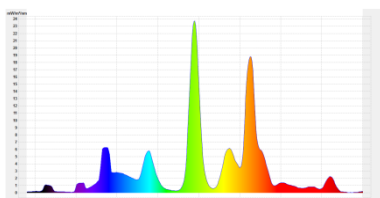

TL8 840, CCT = 3781 K, Ra = 82.9

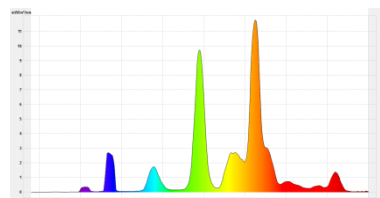

Energy-saving lamp, CCT = 2702 K, Ra = 82.2

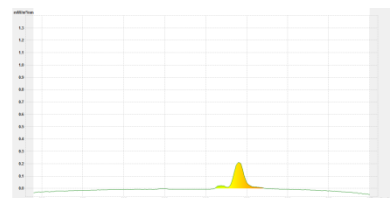

Street light, CCT = 1523 K, Ra = 2.2



Spectral power distribution is measured with a spectral photometer.

## Color Coordinates x, y [CIE 1931] / u, v [CIE 1960] / u', v' [CIE 1976]

Color coordinates are a means of precisely defining a color, i.e. a color's chromaticity as specified by the coordinates of the CIE diagram. The human eye is equipped with sensory cells for the perception of the three primary colors, namely red, green and blue. Photopic curves for the standard observer were ascertained in 1931 by the CIE and indicate sensitivity for the individual wavelength ranges. On the basis of this spectral value function, the CIE defined the standard XYZ color value system, by means of which each color is described by its standard color components x, y and z. Colors are represented in a two-dimensional diagram via the X and Y coordinates. The third component, Z, can be calculated by means of the relationship  $z = 1-x-y$ . Various CIE color systems include CIE 1931 (x,y), CIE 1960 (u,v) and CIE 1976 (u',v').

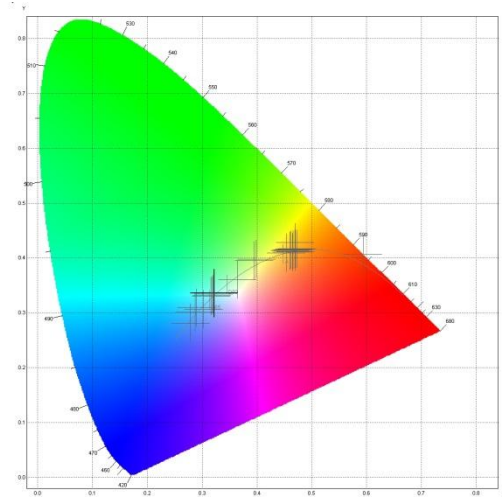

The color coordinates of individual light sources are measured for the various color systems with a spectral photometer.

## Color Rendering

The color of an object results from partial reflection of the spectrum emitted by the illuminating light source. If certain ranges are missing from this spectrum, the corresponding color components cannot be reflected or seen. If intensity is not uniform over the entire spectral range, color components with greater intensity are amplified, and those with lower intensity are attenuated. If the spectrum of the incident light is changed, for example through the use of other lamp technologies, the appearance of the colors of the observed object change as well.

The color rendering properties of a light source cannot be described by means of color temperature or color coordinates, because two different light sources can have identical values for both parameters, although the color appearance of the illuminated object differs. The color rendering properties of a light source can only be defined with the color rendering index  $R_a$ .

This quality feature is specified in the technical light standards depending on the viewing task. In the case of precision viewing tasks where color rendering is important, for example in the printing and graphics sectors, museums and galleries, the fashion and textile industries, in hair styling and cosmetics salons, at dental and dermatology treatment facilities, and at counters where meats, fruits and vegetables are sold, special attention must be allocated to the light spectrum of the light source.



The quality of color rendering, i.e. the color rendering index as well as chromaticity and color temperature, can be measured with a spectral photometer.

## Light Color

Color temperature is a unit of measure which is used to quantitatively specify the respective color impression of a light source. It's defined as the temperature of a black object, the so-called Planckian radiator, which belongs to a certain color of the light which is emitted by the source of radiation. In concrete terms, it's the temperature whose light effect is most similar to the color to be described at uniform brightness under specified observation conditions, i.e. the correlated color temperature.

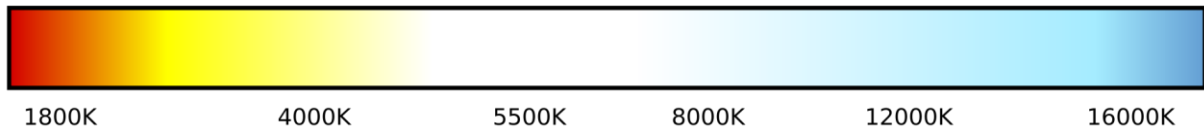

**Correlated Color Temperature**  
(source: Wikimedia Commons - Holec -Color temperature.svg)

The light color of a lamp is the result of its spectral composition and is characterized in simplified terms as the color temperature TCP of the emitted light. TCP is specified in Kelvin (K). The light color of daylight is designated white and includes all of the wavelengths within the visible range.

The following table includes examples showing the color temperature ranges of various light sources.

Light Source	Color Temperature [K]
Candles	1900 ... 2500
Lamps with tungsten filament	2700 ... 3200
Daylight fluorescent lamps	2700 ... 6500
High pressure sodium vapor lamps (SON)	2000 ... 2500
Halogen metal vapor lamps	3000 ... 5600
High pressure mercury lamps	3400 ... 4000
Moonlight	4100
Sunlight	5000 ... 5800
Daylight (sun with clear skies)	5800 ... 6500
Overcast skies	6000 ... 6900



The light color of sources of artificial light is categorized into three groups in accordance with DIN EN 12464, parts 1 and 2. Depending on the predominant spectral color components, differentiation is made amongst:

Light Color	Correlated Color Temperature TCP [K]	Color Component	Lamp Examples
Warm white (ww)	< 3300	Primarily red	Incandescent light bulbs, sodium vapor lamps, fluorescent lamps
Neutral white (nw)	3300 ... 5300	Balanced / red, blue, green	Halogen metal vapor lamps, fluorescent lamps
Daylight White (dw)	> 5300	Primarily blue	High pressure mercury lamps Fluorescent lamps

### Color Rendering Index per DIN 6169

Color rendering index  $R_a$  is a measure of the color rendering properties of lamps and has a theoretical maximum value of 100. The higher the color rendering index, the better the color rendering properties of the lamp. Color rendering which is as natural as possible is achieved through the use of lamps with an  $R_a$  value of greater than 90.  $R_a$  is the arithmetic mean value of color deviation demonstrated by test colors 1 through 8 in (DIN 6169).

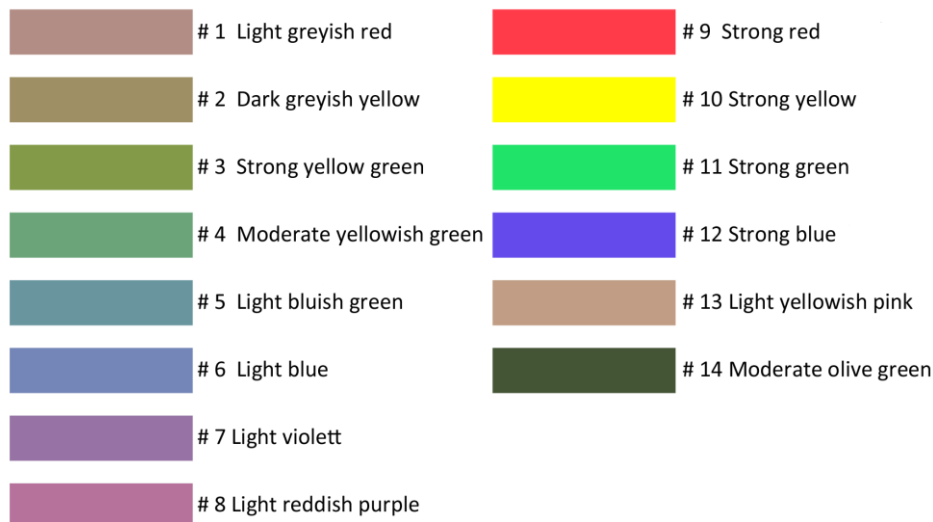

14 Colors per DIN 6169

(source: Wikimedia Commons – chris828 - DIN Test 6169.svg - modified)

Where LED lamps are concerned, color rendering index  $R_9$  for strong red is also frequently taken into consideration, because white LEDs demonstrate weaknesses within this spectrum.

**i** DIN EN 12464 specifies the color rendering properties of lamps used to illuminate various types of rooms and activities.

$R_a$	Color Rendering	Lamp Examples	Application
$\geq 90$	Excellent	Halogen metal vapor lamps, deluxe fluorescent lamps, tungsten halogen lamps, high-quality LEDs	Graphics trade, museums, textile and leather goods showrooms, hair styling and cosmetics salons, dental treatment facilities
80 ... 89	Good	Halogen metal vapor lamps, fluorescent lamps LEDs	Administration buildings, schools, industrial and sports facilities
70 ... 79	Medium	LEDs	
60 ... 69	Medium	Halogen metal vapor lamps, for road lighting	Road lighting
40 ... 59	Inadequate	High pressure mercury lamps	Rough industrial work
20 ... 39	Inadequate	High pressure sodium vapor lamps	Indoor areas in exceptional cases only

## Lamp Color Designations

Depending on the manufacturer, the color rendering properties of lamps are defined together with color temperature by means of a 3 digit code.

Color Rendering		Color Temperature	
1 <sup>st</sup> digit	$R_a$ range	2 <sup>nd</sup> and 3 <sup>rd</sup> digits	$T_n$
9	90 - 100	27	2700 K
8	80 - 89	30	3000 K
7	70 - 79	40	4000 K
6	60 - 69	50	5000 K
5	50 - 59	60	6000 K
4	40 - 49	65	6500 K

**Example:** An Osram fluorescent tube bears the designation “T8 L 18W/965 LUMILUX DE LUXE Daylight G13”. 965 specifies a color rendering property  $R_a$  from 90 to 100 and a color temperature of 6500 K.



## Selection Criteria for Luxmeters and Luminance Meters

### Assignment to Classes

DIN 5032, part 7, defines four classes of luxmeters and luminance meters, each with 16 characteristics and the associated error limits. Meters are assigned to classes as follows:

- Class L: Meters with highest possible accuracy (laboratory measurements)
- Class A: Meters with high levels of accuracy
- Class B: Meters with medium levels of accuracy
- Class C: Meters with low levels of accuracy (rough measurements)

The purpose of this standardization is to describe attainable levels of measuring accuracy by means of a value, thus making it easy to compare the quality of the meters. A classified meter must take all characteristics into consideration, and its individual errors and overall error may not exceed the error limits specified for its class. The sum of all permissible individual errors is greater than permissible overall error which, however, may not be exceeded and includes the measuring uncertainty of the standard utilized for calibration.

 Before buying a measuring instrument, it's advisable to determine whether or not classification applies to all 16 characteristics, or to individual characteristics only.

The following table includes several characteristics along with the associated error limits for the individual classes.

Feature	Designation	Error Limits for Measuring Instruments of the Respective Class			
		L	A	B	C
V( $\lambda$ ) matching	$f_1$	1.5%	3%	6%	9%
cos-like rating	$f_2$		1.5%	3%	6%
Linearity error	$f_3$	0.2%	1%	2%	5%
Adjustment error	$f_{11}$	0.1%	0.5%	1%	2%
Total error	$f_{tot}$	3%	5%	10%	20%

The individual terms, as well as the characteristics and their designations, are defined for photometers in DIN 5032, part 6.

### V( $\lambda$ ) Matching $f_1$

The spectral sensitivity of the receiver must correspond to the standardized spectral sensitivity of the human eye V( $\lambda$ ). This assures that the measuring instrument evaluates brightness as it's perceived by the human eye. In actual practice, this matching is accomplished by precision devices through the use of full or partial filtering.

Simpler measuring instruments work with correction factors for various types of light. This method only demonstrates sufficient accuracy when the spectrum of the respective type of light is known and remains constant.

 Good V( $\lambda$ ) matching with filters ensures that the measuring instrument is suitable for the measurement of all types of lamps – including fluorescent lamps and LEDs.

### Cos-Like Rating $f_2$

The luxmeter's receiver takes the fact into consideration that the brightness of a flat measuring surface is proportional to the cosine of the incident angle of light. Brightness is greatest in the case of vertical incident light, and brightness is 0 with an incident light angle of 90°.

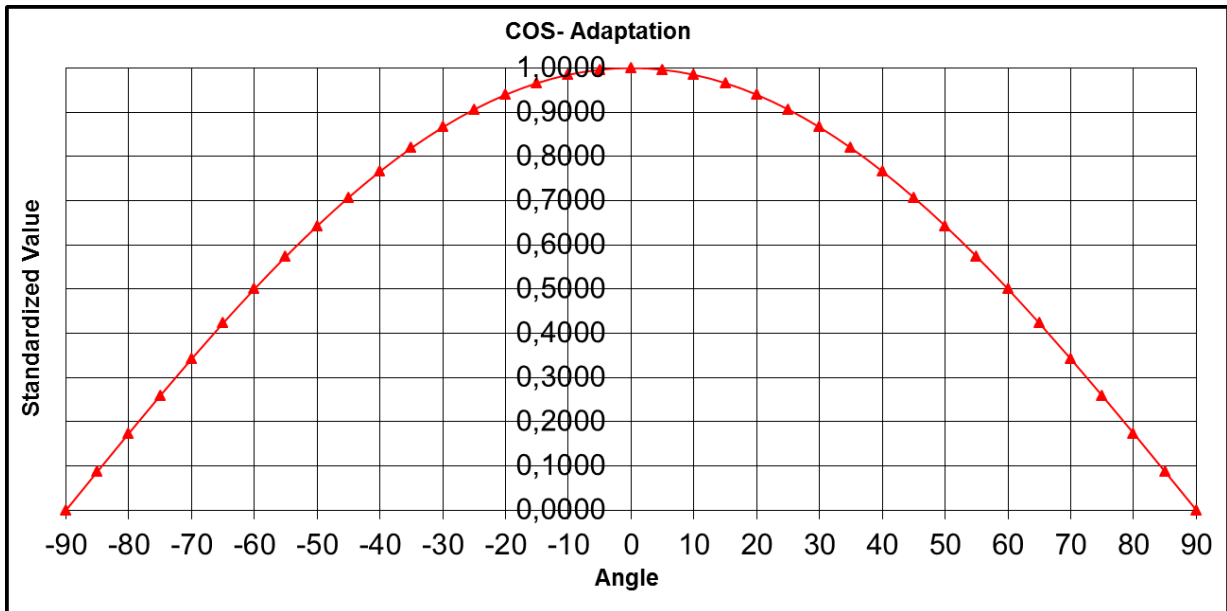

### Linearity Error $f_3$

The linearity of a luxmeter or a luminance meter results from the fact that the display value is proportional to the photometric quantity to be measured. The relationship between the two quantities is also known as the photometer's characteristic curve. Essentially, linearity depends on the utilized sensors, which are not always linear over the entire measuring range. In the case of up-to-date meters, this error is usually compensated for by device firmware.

### Adjustment Error $f_{11}$

Adjustment error is a systematic error which occurs when switching takes place from one measuring range to another and the display value changes. The cause of this error is usually a lack of care in balancing in the individual measuring ranges.

### Total Error $f_{tot}$

Total error is smaller than the sum of all permissible individual errors and includes the measuring uncertainty of the standard utilized for calibration.

## Measuring Range and Display Resolution

The measuring range is defined by the upper and lower range limits. The difference between the two is also known as the measuring span. As a rule, a guaranteed error limit is specified for the measuring range. In the case of measuring instruments with several measuring ranges, differing error limits are permissible for each measuring range.



The display resolution for the measuring range should be at least 100 times greater than the value to be measured, because resolution-related measuring uncertainty is thus limited to 1%.

## Advantageous Features

First of all, the quality of the measurement is assured by selecting a classified luxmeter or luminance meter. However, depending on the application, other features are also frequently advantageous and should be taken into consideration when buying a meter.

An **illuminated display** makes it easier to read measurement results in dark environments, but it should be switched off during measurement in order to avoid interference. This feature is especially helpful when measuring safety, anti-panic and stand-by lighting, as well as for use in the light lab.

A **tripod socket in the measuring probe or the meter** permits precise adjustment to specified distances and heights, as well as use in permanent setups.

A **luminance attachment** for luxmeters, or a **measuring probe for contact measurement** and a **reflectance standard for measuring illuminance** with a luminance meter for distance measurement expand the scope of functions of the measuring instruments in a simple manner.

A **USB port** permits computer-aided use and supplies power to the measuring instrument for continuous operation. Control of the measuring instrument, as well as acquisition, display and storage of measured values is made possible by **suitable software**, which should be included with the **meter**. An **open, documented interface protocol** with a sample application is advantageous for incorporating the measuring instrument into one's own applications.

A **calibration report** verifies, for example, that the measuring instrument has been balanced in observance of a quality assurance system per DIN EN ISO 9001, that the measuring equipment used for this purpose is subject to measuring equipment management and that the guaranteed specifications and tolerances were complied with at the time of shipment. It's also advantageous when a setpoint value can be entered and the associated actual value is documented.

## Mandatory Calibration of Measuring Equipment

If a measuring instrument is used for quality assurance, approvals and assessment, mandatory calibration applies as a rule. Detailed requirements are included in the respective technical standards.

As a standard for quality management systems, DIN EN ISO 9001:2008 stipulates essential requirements for monitoring measuring instruments in section 7.6, insofar as they are used to assure compliant results, and thus uniform product quality as well.

Measuring instruments must be retraced to national standards at regular intervals by means of calibration, and if necessary adjusted, and plainly labeled with their calibration status. If it's determined during calibration that the measuring instrument does not fulfill the specified requirements, the operating company must evaluate the validity of previously obtained measurement results and implement appropriate measures with regard to the measuring instrument itself, as well as all affected products.

Consequently, calibration at regular intervals assures the quality of the respective product or service on the basis of internationally comparable measurement results. This provides for legal security with respect to product liability, as well as for acceptance tests and audits. Due to its assured traceability to national test standards, DAkkS calibration is advisable for the recalibration of measuring instruments which, in turn, are used as test standards for monitoring other measuring and test equipment.

Detailed information is included in the technical article entitled "Calibration of Measuring Instruments" at [www.gossen-photo.de](http://www.gossen-photo.de) under Light Measuring – Service – Calibration. Information is also available there concerning sample calibration certificates, calibration ranges, DAkkS accreditation and DAkkS calibration quantities covered by the GOSSEN Light Lab.



GOSSEN Light Lab

## Which Measuring Instrument for Which Measured Quantity?

GOSSEN light meters are capable of acquiring a broad range of measured quantities. The individual measured quantities are matched up with the respective measuring instruments in the following table. Optional accessories are also listed, in case these are required in addition to the basic instrument.

### Luxmeters and Luminance Meters

Measured Quantity / Measuring Instrument	Illuminance [lx]	Luminance [cd/m <sup>2</sup> ] – Contact Measurement	Luminance [cd/m <sup>2</sup> ] – Distance Measurement
MAVOLUX 5032 C BASE	■ Class C		
MAVOLUX 5032 C USB	■ Class C	+ Luminance attachment, not recommended!	+ Luminance attachment, measuring angle: approx. 15°
MAVOLUX 5032 B USB	■ Class B	+ Luminance attachment, not recommended!	+ Luminance attachment, measuring angle: approx. 15°
MAVO-MONITOR USB		■ Class B	
MAVO-SPOT 2 USB	+ Reflectance standard	+ Probe for contact measurement	■ Class B

### GOSSEN Luminance Meters



MAVO-SPOT 2 USB



MAVO-MONITOR USB

## Spectral Photometers

Measuring Instrument / Measured Quantity	MAVOSPEC	MAVOSPEC BASE
Illuminance [lx]	■	■
Spectral power distribution SPD [mW/m <sup>2</sup> /nm]	■	■
Chromaticity, color coordinates x,y [CIE 1931]	■	■
Chromaticity, color coordinates u,v [CIE 1960]	■	■
Chromaticity, color coordinates u',v' [CIE 1976]	■	■
Color temperature [K] – CCT	■	■
Color rendering index Ra, R1...R14 – CRI	■	■ + R15
Flicker		■
Peak wavelength	■	■
Dominant wavelength	+ GL SpectroSoft	■
Purity	+ GL SpectroSoft	■
Luminance [cd/m <sup>2</sup> ] – contact measurement	+ MAVOPROBE 1.0	
Luminance [cd/m <sup>2</sup> ] – distance measurement	+ MAVOPROBE 1.0	
Luminous flux Φ [lumen, lm]	+ MAVOSPHERE	
Luminous intensity I [candela, cd]	+ GL SpectroSoft Pro	
Chromaticity error	+ GL SpectroSoft	
Binning of LEDs	+ GL SpectroSoft Pro	
Indices of metamerism	+ GL SpectroSoft Pro	
MacAdam ellipses	+ GL SpectroSoft Pro	
Transmission + reflection	+ GL SpectroSoft Pro, additional accessory	
Approval of color matching stations, ISO 3664	+ GL SpectroSoft Pro	

# GOSSEN Spectral Photometer



MAVOSPEC



MAVOSPEC BASE



## Which Measuring Instrument for Which Application?

GOSSEN light meters can be used in a wide variety of applications. The following table includes a number of these applications together with the respective standards and the requirements specified therein for measuring instruments.

<b>Medical technology – DIN 6868 – 157</b>	
<b>Acceptance and constancy test of image display systems in their environment per RÖV</b>	
<b>Acceptance testing for image display systems</b>	
Luminance Class B, DIN 5032-7, factory calibration	MAVO-SPOT 2 USB + factory calibration certificate
<b>Constancy testing for image display systems</b>	
Measuring procedure A – luminance Class B, DIN 5032-7, factory calibration	MAVO-SPOT 2 USB + factory calibration certificate
Measuring procedure B – illuminance, 1 ... 1000 lx Measuring uncertainty $\leq 10\%$ , repetition accuracy $\leq 5\%$	MAVOLUX 5032 B USB / C USB / C BASE
Measuring procedure B – luminance Class B, DIN 5032-7, factory calibration	MAVO-MONITOR USB + factory calibration certificate
Preservation of the status quo for DIN V 6868 – 57 Extension of the test interval for veiling luminance and maximum contrast from 3 to 6 months	MAVO-MAX
<b>Testing of room lighting (room classes)</b>	
Illuminance, 1 ... 1000 lx Measuring uncertainty $\leq 10\%$ , repetition accuracy $\leq 5\%$	MAVOLUX 5032 B USB / C USB / C BASE
Illuminance via luminance Class B, DIN 5032-7, reflectance standard	MAVO-SPOT 2 USB + reflectance standard
Continuous room lighting monitoring RC1, RC2, RC5	MAVO-MAX RK1 / RK2 / RK5
Requirements from DIN EN 12464-1 Light color (CCT), color rendering (Ra)	MAVOSPEC BASE / MAVOSPEC
<b>Lighting of work places – Indoor work places, DIN EN 12464-1</b>	
<b>Lighting of work places – Outdoor work places, DIN EN 12464-2</b>	
<b>Technical rules for workplaces</b>	
<b>– Lighting – ASR A3.4</b>	
<b>– Safety lighting, optical safety guidance systems – ASR3.4/3</b>	
Illuminance	MAVOLUX 5032 B USB / C USB / C BASE
Luminance, glare, contrast	MAVO-SPOT 2 USB
Light color (CCT), color rendering (Ra)	MAVOSPEC BASE / MAVOSPEC
<b>Emergency lighting – DIN EN 1838</b>	
Safety, anti-panic and stand-by lighting, at least 0.5 ... 1 lx, measuring uncertainty: $\leq 10\%$	MAVOLUX 5032 B USB
Safety signs – luminance + contrast Error tolerance $\leq 10\%$	MAVO-SPOT 2 USB
Color rendering (Ra)	MAVOSPEC BASE, MAVOSPEC



<b>Sports lighting – DIN EN 12193</b>	
Illuminance – homogenous illumination	MAVOLUX 5032 B USB / C USB / C BASE
Luminance – glare, light immission	MAVO-SPOT 2 USB
Light color (CCT), color rendering (Ra)	MAVOSPEC BASE, MAVOSPEC
<b>Road lighting – DIN EN 13201</b>	
Illuminance: horizontal, vertical, hemispherical, semi-cylindrical, calibrated measuring instrument	-
Luminance – 2' vertical measuring angle, 20' horizontal measuring angle, calibrated measuring instrument	-
Light color (CCT), color rendering (Ra)	MAVOSPEC BASE, MAVOSPEC
<b>Lighting of pedestrian crossings with additional lighting – DIN 67523</b>	
<b>Traffic control equipment – Warning and safety light devices – DIN EN 12352</b>	
Illuminance, calibrated measuring instrument	MAVOLUX 5032 B USB / C USB / C BASE + factory certificate
Luminance, calibrated measuring instrument	MAVO-SPOT 2 USB + factory certificate
Light color (CCT), color rendering (Ra)	MAVOSPEC BASE, MAVOSPEC
<b>Lighting of street tunnels and underpasses (DIN 67524) – DIN 67524</b>	
<b>Evacuation lighting in road tunnels – DIN EN 16276</b>	
Illuminance	MAVOLUX 5032 B USB / C USB / C BASE
Luminance	-
<b>Illumination of lock areas – DIN 67500</b>	
Illuminance	MAVOLUX 5032 B USB / C USB / C BASE
<b>Energy labelling of electrical lamps and luminaires – EU regulation no. 874/2012 – Energy labelling Ecodesign requirements for non-directional household lamps – EU regulation no. 244/2009 – Ecodesign Ecodesign requirements for directional lamps, light emitting diode lamps and related equipment – EU regulation no. 1194/2012 – Ecodesign</b>	
Light color (CCT), color rendering (Ra)	MAVOSPEC BASE, MAVOSPEC
Luminous Flux	MAVOSPEC + MAVOSPHERE
<b>Light immission – measurement and assessment – German federal immission control act</b>	
Room brightening– resolution: 0.01 lx Measuring uncertainty: ≤ 10%	MAVOLUX 5032 B USB
Glare – 0.01 to 106 cd/m <sup>2</sup> Class B, DIN 5032-7, overall error ≤ 15%	MAVO-SPOT 2 USB

## Medical Technology Standard

### DIN 6868-157 – Acceptance and constancy test of image display systems

#### DIN 6868-157: Image quality assurance in diagnostic X-ray departments – Part 157: X-ray ordinance acceptance and constancy test of image display systems in their environment

The image quality of image display systems is decisive for subsequent diagnostics. And thus image display systems must be subjected to acceptance testing after installation and to metrological constancy testing once every six months. Furthermore, ambient light in the room must be measured and it must be determined whether or not room class requirements are complied with. In the case of dimmable lighting, a display which indicates that ambient room light is within the permissible limits for diagnostics is advantageous.



A luminance meter and a luxmeter are required for acceptance and constancy testing. The respective luminance meter must be furnished with a factory calibration certificate for both measuring procedures, and the stipulated specification must be complied with for the luxmeter. A room light sensor for the respective room class is used for continuous monitoring of compliance with the specified range. It makes use of a green LED in order to indicate compliance.

Detailed requirements concerning the measuring instruments and measuring procedures to be used are included in DIN 6868-157. A summary of the required measuring instrument specifications can be found in the preceding section of this compendium.

GOSSEN offers a special **DIN 6868-157 measuring case** which includes the MAVO-SPOT 2 USB and the MAVOLUX 5032C BASE, as well as the respective factory certificates. The MAVO-MAX RK1 or RK5 can be used for continuous monitoring of ambient room light for compliance with the room classes.



DIN 6868-157 Case



MAVO-SPOT 2 USB



MAVOLUX 5032C BASE



MAVO-MAX RK1

## Standards for Workplace Lighting

The **DIN standards** (German industrial standards), which are national versions of European DIN EN standards, serve as the basis for laying out workplace lighting. They stipulate quantitative and qualitative requirements for the quality of the lighting system. As a rule, standards reflect the state-of-the-art, have an advisory character and are used as a basis for contracts and legal disputes. Standards are freely accessible and can be procured from Beuth Verlag at [www.beuth.de](http://www.beuth.de).

### DIN EN 12464-1 – Indoor Workplaces

This standard deals with the requirements for lighting in indoor workplaces with reference to visual performance and visual comfort for all common viewing tasks, including viewing tasks at monitor screens.

It specifies requirements for lighting with regard to quantity and quality for most workplaces and their associated surfaces. In order to allow planners the greatest possible degree of freedom for innovative lighting systems, no specific solutions are stipulated. Lighting can be provided by means of daylight, artificial light sources or a combination of both. In addition to illuminance, the standard also describes additional quantitative and qualitative quality characteristics for the implementation of a good lighting environment. These include luminance distribution, illuminance, glare, light direction, light color and color rendering, as well as flicker and daylight.



The tables in section 5 of the standard specify detailed lighting requirements for rooms (areas), tasks and activities. These include the maintenance value for illuminance, the UGR limit value for glare, the color rendering index and comments regarding exceptions and peculiarities.

For example, the following specifications apply to office workplaces:

Room, Task, Activity	$\bar{E}_m$	UGR <sub>L</sub>	R <sub>a</sub>	Comments
Filing, copying, traffic routes	300	19	80	
Writing, reading, data processing	500	19	80	Work at monitor screens, special rules
CAD workstation	500	19	80	Work at monitor screens, special rules
Conference and meeting rooms	500	19	80	It should be possible to regulate lighting
Reception counter	300	22	80	
Archive	200	25	80	

There are areas with special requirements for color rendering ( $R_a \geq 90$ ), which must be considered when using LED lighting.

## DIN EN 12464-2 – Outdoor Workplaces

This standard deals with the requirements for lighting in outdoor workplaces with reference to visual performance and visual comfort for all common viewing tasks.

It's laid out like DIN EN 12464-1 and stipulates comparable lighting requirements, but it concentrates in particular on nighttime viewing tasks.

The tables in section 5 of the standard specify detailed lighting requirements for areas, tasks and activities. These include the maintenance value for illuminance, the minimum value for illuminance uniformity  $U_0$ , the limit value for glare evaluation  $GR_L$ , the color rendering index and comments regarding exceptions and peculiarities.

## DIN EN 1838 – Emergency Lighting

Emergency lighting is activated when normal artificial lighting fails and must have an autonomous power supply for this reason. It's a generic term for stand-by lighting and safety lighting, which is subdivided into safety lighting for escape routes, anti-panic lighting and safety lighting for workplaces which are subject to extraordinary danger.



The objective of safety lighting is to enable personnel to reliably stop potentially dangerous work processes and avoid hazardous situations in the event of a general power failure, to get to a place at which an escape route can be clearly recognized as such and to use it in order to safely exit the building or leave the area. In contrast to this, stand-by lighting makes it possible to continue all necessary tasks in an unchanged fashion.

DIN EN 1838 specifies minimum values for planning and installing stand-by lighting, and for its entire service life.

As an example, the following table includes safety lighting requirements for illuminance. Further specifications regarding the width of the lamps and illumination uniformity can be found in the standard.

Safety Lighting	Illuminance	Color Rendering Index
First-aid stations	$E \geq 5 \text{ lx}^*$	$R_a > 40^{**}$
Fire fighting equipment and fire alarm systems	$E \geq 5 \text{ lx}^*$	$R_a > 40^{**}$
Escape routes	$E \geq 1 \text{ lx}^*$	$R_a > 40^{**}$
Anti-panic lighting	$E \geq 0.5 \text{ lx}^*$	$R_a > 40^{**}$
Workplace subjected to extraordinary danger	$E \geq 15 \text{ lx}$ and $E \geq 10\%$ of the maintenance value of the illuminance required for the task	$R_a > 40^{**}$

\* Measurement is taken on the floor up to a maximum height of 20 mm.

\*\* In order to be able to unequivocally recognize safety colors.

Cosine and  $V(\lambda)$ -corrected measuring instruments with an error tolerance of  $\leq 10\%$  are stipulated for on-site measurement of illuminance. Due to the lower illuminance values, a measuring instrument resolution with at least 2 places to the right of the decimal point is recommended.

## German Ordinance on Workplaces (ArbStättV)

The German ordinance of workplaces specifies which factors the employer must take into consideration when setting up and operating workplaces with reference to employee safety and occupational health. It can be downloaded free of charge from the website of the German Federal Ministry of Justice and Consumer Protection at [www.gesetze-im-internet.de](http://www.gesetze-im-internet.de).

The ordinance is in line with the regulatory framework of the European workplace guideline, by means of which safety goals and general requirements are set forth, although no detailed specifications are stipulated. And thus the respective company is allowed a given amount of leeway for individualized work safety measures.

The following requirements with reference to workplace lighting are included in the appendix, "Workplace Requirements":

### *3.4 Lighting and Visual Contact*

*(1) If at all possible, workplaces must receive adequate amounts of daylight and be equipped with fixtures which furnish suitable artificial light which is sufficient for assuring employee safety and occupational health.*

*(2) The lighting systems must be selected and arranged such that they cannot result in any accident safety risks or health hazards*

*(3) Workplaces at which employees are exposed to any danger of accident in the event that normal lighting should fail must be equipped with adequate safety lighting.*

Persons who intentionally or negligently violate any of the points included in paragraph 9 of the ordinance commit a regulatory offense, and persons who as a result of this intentionally endanger the lives and/or health of the respective employees are liable to prosecution.

## Technical Rules for Workplaces – ASR

In order to make it easier for companies and the responsible authorities to implement the workplace ordinance in actual practice, the "workplaces committee" prepares "workplace rules" (ASR) which are published by the German Federal Ministry of Labor and Social Affairs. If the employer complies with these technical rules, he can assume that the corresponding requirements set forth in the ordinance are fulfilled. The two following workplace rules are relevant with regard to workplace lighting. They can be downloaded free of charge from the website of the German Federal Institute for Occupational Safety and Health at [www.baua.de/en/Homepage.html](http://www.baua.de/en/Homepage.html).

## **ASR A3.4 – Lighting**

ASR A3.4 enumerates the requirements from section 3.4 of the appendix to the workplace ordinance and is based on the trade association rule set forth by German public accident insurance BGR 131-2: Natural and artificial lighting at workplaces – part 2: Guideline for planning and operating lighting systems. In isolated cases, ASR A3.4 deviates from DIN EN 12464 which establishes a basis for planning lighting systems, but without taking requirements for employee safety and occupational health into consideration.

The guideline specifies requirements for illuminance, the reduction of glare, color rendering, flicker and shadow with regard to illumination with daylight, as well as with artificial lighting in buildings and out of doors. Further instructions regarding the operation and maintenance of the lighting system, and regarding rough measurement with classified luxmeters (at least class 3), are also included.

Minimum values for illuminance and color rendering index Ra are specified in appendix 1 to ASR A3.4 for various work rooms, workplaces and activities. Adequate values for outdoor work areas, workplaces and activities can be found in appendix 2.

### **ASR A3.4/3 – Safety Lighting, Optical Safety Guidance Systems**

ASR A3.4/3 enumerates the requirements set forth in the workplace ordinance for setting up and operating safety lighting and optical safety guidance systems. In addition to general specifications, concrete values are also included for illuminance and uniformity of illumination, as well as its duration of availability and color rendering. Further instructions for operation, maintenance and inspection of the system are included as well.

## **Trade Association Rules**

The federal government and the trade associations establish specifications in Germany which are binding for companies and stipulate how lighting has to be laid out at workplaces. As opposed to the applicable standards which are used primarily for planning and installing lighting systems, they have a legally binding character. The trade association rules can be downloaded free of charge from the website of the German Federal Ministry of Justice and Consumer Protection at [www.gesetze-im-internet.de](http://www.gesetze-im-internet.de).

### **BGR 131 – Natural and Artificial Lighting at Workplaces**

This trade association rule is comprised of two parts in order to make it easier to understand for small and mid-sized businesses, and thus easier to implement. This is due to the complexity of the rule, because it doesn't make reference to any standards and describes the requirements explicitly. Requirements for lighting are only dealt with from the standpoint of employee safety and occupational health. Reference is only made to product or production related requirements when necessary.

## **Part 1: Procedural Guidelines for Companies**

This part of the rule addresses entrepreneurs who are laypersons in most cases, but who are nevertheless responsible for compliance with the rule. The fundamentals of good lighting are presented in simple, understandable terms, important core concepts regarding the planning and operation of lighting systems are explained and options for the implementation of practical lighting concepts are pointed out.

## **Part 2: Guideline for Planning and Operating Lighting Systems**

This part also addresses entrepreneurs, but in light of the utilized formulations and its regulatory depth, it's apparent that it's more suitable for the expert. It's used for the most part by internal or external specialists for work safety, lighting experts or lighting designers when implementing the guideline. Part 2 includes the latest ergonomic findings with regard to lighting and describes the implementation of the lighting concepts in part 1 in concrete terms.

The lighting concept ranges from formerly common room and work area specific lighting, right on up to sub-area specific lighting. Flexible combination of the individual concepts leads to practical adaptation of lighting for workplaces which can be matched to the eyesight and the individual needs of the employee.

Due to the fact that the guideline is limited to work safety and health protection aspects, it includes only a few specifications for required illuminance values. The work area and surrounding areas are dealt with on the basis of three maintenance values each. Other areas are broken down into 10 representative classes for each of which one maintenance value is stipulated.

Other requirements and recommendations for qualitative aspects of lighting include illumination uniformity, luminance distribution, limiting of glare and reflections, body rendering (shadow detail) and the avoidance of irritating shadows, light color and color rendering, as well as the absence of flicker.

The guideline is rounded out with a treatment of planning, setup and maintenance, as well as testing and measuring of lighting systems.

## Bibliography

### Books

**Beleuchtungstechnik für Praktiker: Grundlagen, Lampen, Leuchten, Planung, Messung**

Hans Rudolf Ris, VDE Verlag 2015, ISBN 978-3-8007-3617-1

**Beleuchtungstechnik für den Elektrofachmann Lampen, Leuchten und ihre Anwendung**

Zieseniß – Lindemuth - Schmits, Hüthig & Pflaum Verlag 2009, ISBN 978-3-8101-0273-7

### Free Leaflets

**GOSSEN technical article on “Calibration of Measurement Instruments”**

[www.gossen-photo.de/pdf/Kalibrierung\\_GB.pdf](http://www.gossen-photo.de/pdf/Kalibrierung_GB.pdf)

**Zumtobel Lichthandbuch**

[www.zumtobel.com/PDB/teaser/DE/Lichthandbuch.pdf](http://www.zumtobel.com/PDB/teaser/DE/Lichthandbuch.pdf)

**Schriftenreihe - Licht Wissen Antworten auf alle Fragen zu Licht und Beleuchtung**

[www.licht.de/de/service-info/publikationen-und-downloads/heftreihe-lichtwissen/](http://www.licht.de/de/service-info/publikationen-und-downloads/heftreihe-lichtwissen/)

**Schriftenreihe - Licht Wissen Antworten auf alle Fragen zu Licht und Beleuchtung**

Leitfaden zur DIN EN 12464-1



## Index of Standards

### Definitions and Measuring Technology

<b>DIN EN 12665</b>	2011-09	Light and lighting - Basic terms and criteria for specifying lighting requirements
<b>IEC 60050-845</b>	1987	International Electrotechnical Vocabulary. Lighting
<b>DIN 5032-7</b>	1985-12	Photometry; classification of illuminance meters and luminance meters
<b>CIE ISO 19476</b>	2014-06	Characterization of the Performance of Illuminance Meters and Luminance Meters
<b>DIN EN ISO 11664-1</b>	2011-07	Colorimetry – Part 1: CIE standard colorimetric observers
<b>DIN EN ISO 11664-2</b>	2011-07	Colorimetry – Part 2: CIE standard illuminants
<b>DIN EN ISO 11664-3</b>	2013-08	Colorimetry – Part 3: CIE tristimulus values
<b>DIN EN ISO 11664-4</b>	2011-07	Colorimetry – Part 4: CIE 1976 L*a*b* Color space
<b>DIN EN ISO 11664-5</b>	2011-07	Colorimetry - Part 5: CIE 1976 L*u*v* Color space and u', v' uniform chromaticity scale diagram
<b>CIE 015</b>	2004	Colorimetry, 3 <sup>rd</sup> edition
<b>DIN 5033 - 9</b>	2005-10	Colorimetry – Part 9: Reflectance standard for calibration in colorimetry and photometry (colorimetry section, partially replaced by ISO 11664)
<b>CIE 13.3</b>	1995	Method of measurement and specifying color rendering properties of light sources
<b>DIN 6169-1</b>	1976-01	Color rendering – Part 1: General terms
<b>DIN 6169-2</b>	1976-02	Color rendering – Part 2: Color rendering properties of light sources in the field of lighting

### Phosphorescent Pigments and Products

<b>DIN 67510-1</b>	2009-11	Phosphorescent pigments and products – Part 1: Measurement and marking at the producer
<b>DIN 67510-2</b>	2002-10	Photoluminescent pigments and products – Part 2: Measurement of phosphorescent products on site
<b>DIN 67510-3</b>	2011-04	Photoluminescent pigments and products – Part 3: Low location lighting system

### Daylight in interiors

<b>DIN 5034-1</b>	2011-07	Daylight in interiors – Part 1: General requirements
<b>DIN 5034-2</b>	1985-02	Daylight in interiors – Part 2: Principles
<b>DIN 5034-3</b>	2007-02	Daylight in interiors – Part 3: Calculation
<b>DIN 5034-4</b>	1994-09	Daylight in interiors – Part 4: Simplified determination of minimum window sizes for dwellings
<b>DIN 5034-5</b>	2010-11	Daylight in interiors – Part 5: Measurement
<b>DIN 5034-6</b>	2007-02	Daylight in interiors – Part 6: Simplified determination of suitable dimensions for rooflights
<b>VDI Guideline 6011</b>		Optimization of daylighting and artificial lighting
	2015-04	Sheet 1 – Fundamentals and basic requirements (draft)
	2006-04	Sheet 2 – Rooflights
	2006-04	Sheet 3 – Requirements for indoor greenery

## Lighting of Workplaces

<b>ISO 8995-1, CIE S 008</b>	2002-05	Lighting of work places – Part 1: Indoor
<b>ISO 8995-3, CIE S 016</b>	2006-10	Lighting of work places – Part 3: Lighting requirements for safety and security of outdoor work places
<b>DIN EN 12464-1</b>		Light and lighting – Lighting of work places – Part 1: Indoor workplaces
<b>DIN EN 12464-2</b>		Light and lighting – Lighting of workplaces – Part 2: Outdoor work places
<b>Addendum to DIN EN 12464-1:</b>		
<b>DIN 5035-3</b>	2006-07	Artificial lighting – Part 3: Lighting of healthcare premises
<b>DIN 5035-6</b>	2006-11	Artificial lighting – Part 6: Measurement and evaluation
<b>DIN 5035-7</b>	2004-08	Artificial Lighting – Part 7: Lighting of interiors with visual display work stations
<b>DIN 5035-8</b>	2007-07	Artificial lighting – Part 8: Workplace luminaires – Requirements, recommendations and proofing
<b>DIN EN ISO 9241-6</b>	2001-03	Ergonomic requirements for office work with visual display terminals (VDTs) – Part 6: Guidance on the work environment
<b>ArbStättV</b>	2010-07	Arbeitsstättenverordnung
<b>ASR A3.4</b>	2011-04	Technische Regeln für Arbeitsstätten – Beleuchtung (ersetzt 7/3 + 41/3)
<b>ASR A3.4/3</b>	2011-06	Technische Regeln für Arbeitsstätten - Sicherheitsbeleuchtung, optische Sicherheitsleitsysteme (ersetzt 7/4)
<b>BGR 131</b>		BG-Regel: Natürliche und künstliche Beleuchtung von Arbeitsstätten Erfordernisse hinsichtlich Arbeitssicherheit und Gesundheitsschutz
<b>BGI 856</b>	2005-03	Beleuchtung von Bildschirm- und Büroarbeitsplätzen (ergänzt BGR131)
<b>BGI 7007</b>	2009-02	Tageslicht am Arbeitsplatz - leistungsfördernd und gesund (ergänzt BGR131)

## Emergency Lighting

<b>DIN EN 1838</b>	2013-10	Lighting applications – Emergency lighting
<b>CIE S 020 / ISO 30061</b>	2007-11	Emergency Lighting
<b>DIN EN 13032-3</b>	2007-12	Light and lighting – Measurement and presentation of photometric data of lamps and luminaires – Part 3: Presentation of data for emergency lighting of work places

## Sports Lighting

<b>DIN EN 12193</b>	2008-04	Light and lighting – Sports lighting (previously DIN 67526-1)
<b>DIN 67526-3</b>	1976-08	Sports lighting; requirements of daylighting
<b>DIN 18032-1</b>	2003-09	Halls and rooms for sports and multi-purpose use – Part 1: Planning principles

## **Road lighting**

<b>DIN 13201-1</b>	2005-11	Road lighting – Part 1: Selection of lighting classes
<b>DIN EN 13201-2</b>	2004-04	Road lighting – Part 2: Performance requirements
<b>DIN EN 13201-2</b>	2013-09	Draft standard: Road lighting – Part 2: Performance requirements
<b>DIN EN 13201-3</b>	2004-04	Road lighting – Part 3: Calculation of performance
	2007-07	Amendment 1
<b>DIN EN 13201-3</b>	2013-09	Draft standard: Road lighting – Part 3: Calculation of performance
<b>DIN EN 13201-4</b>	2004-04	Road lighting – Part 4: Methods of measuring lighting performance
<b>DIN EN 13201-4</b>	2013-09	Draft standard: Road lighting – Part 4: Methods of measuring lighting performance
<b>DIN EN 13201-5</b>	2013-09	Draft standard: Road lighting – Part 5: Energy performance indicators
<b>DIN 67523</b>	2010-06	Lighting of pedestrian crossings with additional lighting
<b>IEC 60598-2-3</b>	2011-11	Luminaires – Particular requirements – Luminaires for road and street lighting

## **Traffic Control Equipment**

<b>DIN EN 12352</b>	2006-07	Traffic control equipment – Warning and safety light devices
<b>DIN EN 12352</b>	2015-02	Draft standard: Traffic control equipment – Warning and safety light devices
<b>ISO 16508</b>	1999-12	Road traffic lights – Photometric properties of 200 mm roundel signals

## **Lighting of Street Tunnels**

<b>DIN 67524-1</b>	2008-07	Lighting of street tunnels and underpasses – Part 1: General quality characteristics and guide values
<b>DIN 67524-2</b>	2011-06	Lighting of street tunnels and underpasses – Part 2: Calculation and measurement
<b>DIN EN 16276</b>	2013-04	Evacuation lighting in road tunnels

## **Illumination of Lock Areas**

<b>DIN 67500</b>	1987-12	Illumination of lock areas; requirements, design and measurement
------------------	---------	--

## **Medical Technology**

<b>DIN 6856-1</b>	2007-10	Radiological film viewing boxes and viewing conditions - Part 1: Requirements and measures of quality assurance in medical diagnostics
<b>DIN 6868-157</b>	2014-11	Image quality assurance in diagnostic X-ray departments – Part 157: X-ray ordinance acceptance and constancy test of image display systems in their environment (replacement for DIN V 6868-57)
<b>DIN EN 61223-2-5</b>	2004-09	Evaluation and routine testing in medical imaging departments – Parts 2 - 5: Constancy tests; Image display devices
<b>RöV</b>	2011-10	Röntgenverordnung - Qualitätssicherung bei Röntgeneinrichtungen zur Untersuchung (§16) und Behandlung (§17) von Menschen

**Notes**



**GOSSEN Foto- und Lichtmesstechnik GmbH** | Lina-Ammon-Str. 22 | 90471 Nürnberg | Germany  
Tel: + 49 (0) 911 8602 - 181 | Fax: +49 (0) 911 8602 - 142

[www.gossen-photo.de](http://www.gossen-photo.de)