

Printer for Measuring Instrument

DP-581H

midi LOGGER

GL240/GL840/GL980/GL2000

Setup Guide

601020011 GL-PRINTER-UM-8M2

Thank you for purchasing our printer. This Setup Guide provides basic instructions for connecting this printer and the measuring instrument. For detailed information on the printer and the connected measuring instrument, see the respective User's Manual. See also the manual of the printer functions in the accompanied CD for details of the print settings.

Check the exterior appearance of the printer.

After unpacking the printer, check the exterior appearance to ensure that there are no problems on it before use.

Check the printer accessories.

Check that the following accessories are included:

- AC adapter: 1 set ● AC cable: 1 ● Dedicated spacer: 2 (attached)
- Battery: 1 ● USB cable: 1 ● CD-ROM: 1 ● Recording paper: 1 roll
- Quick Start Guide: 1 (each English and Japanese) ● Setup Guide (this manual): 1

GRAPHTEC

Contents

Printer Parts Names.....	1
Setup of Printer.....	3
Setup of Measuring Instrument	3
Summary of Connection Method	4
How to Connect via Wireless LAN	6
How to Connect via USB	12
Printer DP-581H Q&A	13
Printer Specifications	14

Printer Parts Names

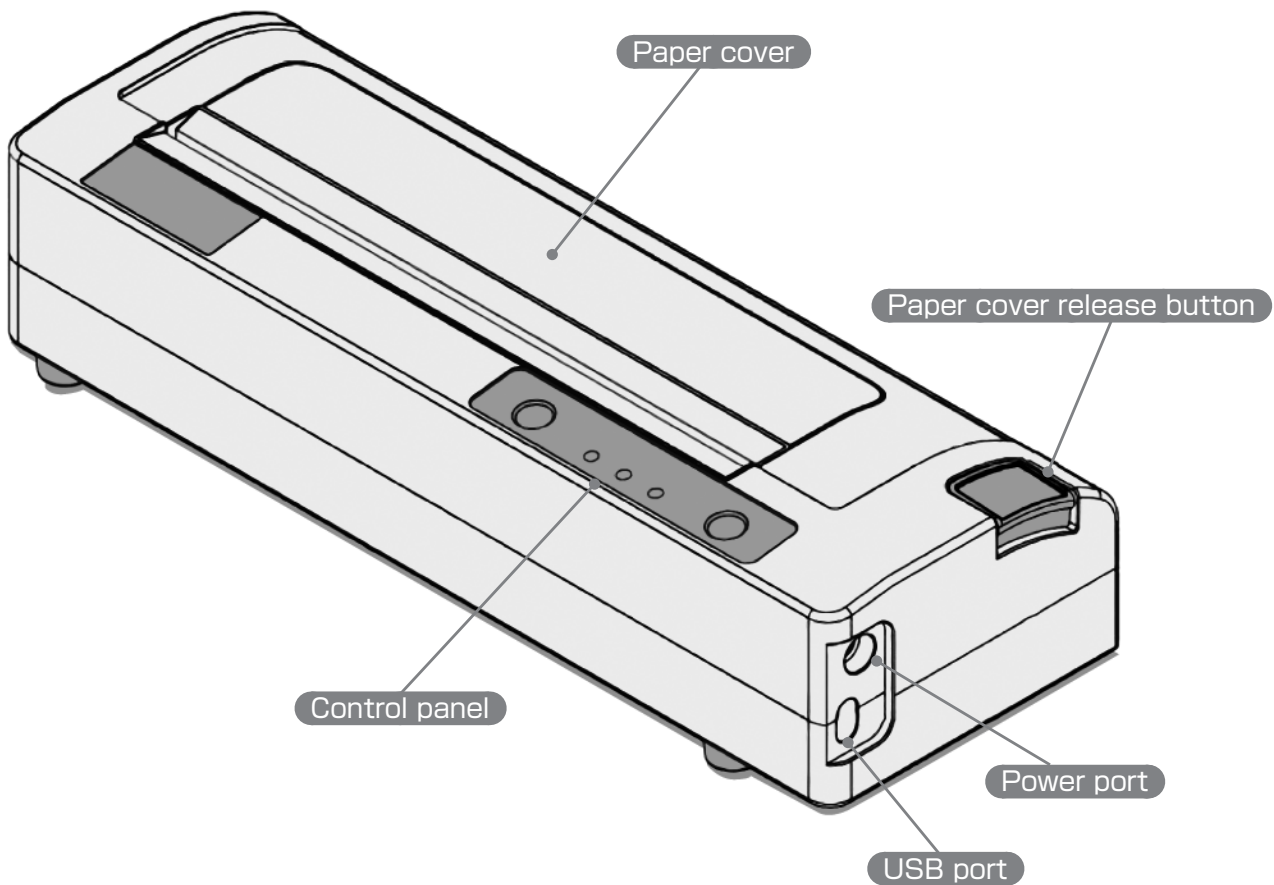

Rear side

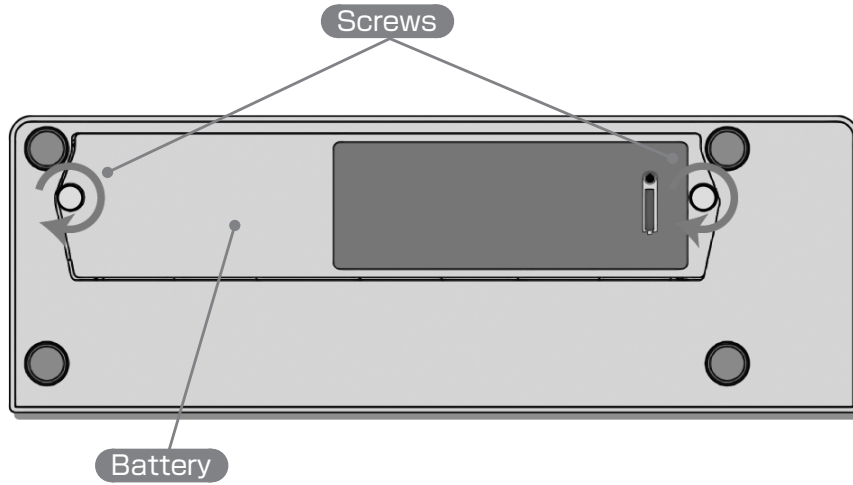

Control panel

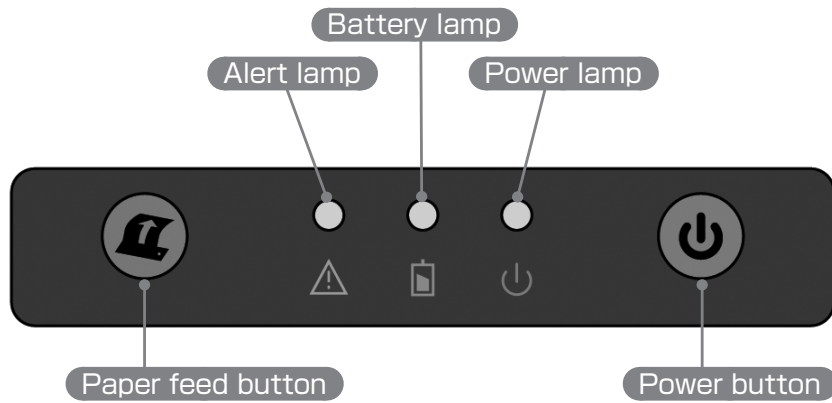

Battery

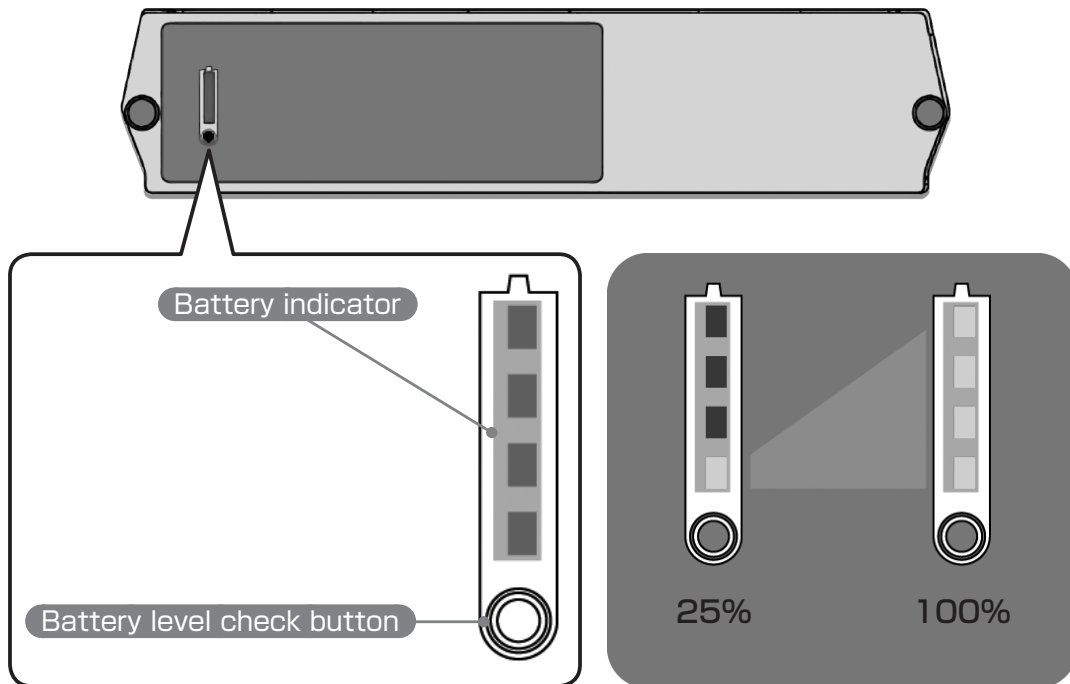

Setup of Printer

- Attach the battery on the rear side.
- Connect the AC adapter to the power port of the printer.
- Press the power button of the printer to turn on the printer.
The battery is charged when the printer is turned on.
The battery is not charged when the printer is turned off.
When the alert lamp goes off, printing is available.
(For details, see the User's Manual for DP-581H.)
- Open the paper cover and load the recording paper without slackness. Pull out the recording paper by approximately 5 cm.
Pay attention to the recording paper loading orientation.
(For details, see the Quick Start Guide for DP-581H.)
- Close the paper cover, and press the paper feed button twice consecutively to perform self-test printing. If the test printing is completed, the printer operates normally.

WARNING

Do not attach or remove the battery while printing is performed.
Doing so may cause a breakdown or malfunction of the printer.

CAUTION

Be sure to turn off the printer before attaching or removing the battery.
The battery of the printer is intended for use in a place where power source is not available. It is not intended to be used as a backup for AC power source loss.

Setup of Measuring Instrument

■ Checking firmware

The following devices can be connected with the printer. If you already use a device, firmware update for the device is required.

The firmware can be downloaded at our web site.

Download page:

<http://www.graphtec.com/support/software/instruments.html>

Supported models	Operable firmware version	Connection method
GL240	Ver. 1.50	Wireless LAN connection
GL840	Ver. 1.50	Wireless LAN connection, Wired LAN connection (*1)
GL980	Ver. 1.30	USB connection (*2), Wired LAN connection (*1)
GL2000	Ver. 1.30	USB connection (*2), Wired LAN connection (*1)

*1 To connect via wired LAN, prepare a commercially available wireless LAN router and LAN cable.

*2 USB hub is not supported. If it is used, operation may not be correctly performed.

Summary of Connection Method

■ Summary of connection

This section describes the summary of connection between the measuring instrument and the printer for each interface.

For instructions on how to connect, see also the manual of the printer functions in the accompanied CD, the manual of the measuring instrument, or the manual of the device you are using.

*1 When using wired LAN, prepare a commercially available wireless LAN router and LAN cable.

However, if a commercially available wireless LAN router is used, proper operation, printed data, etc. are not guaranteed.

*2 The optional B-568 is required when using wireless LAN for GL240/GL840.

■ Summary of connection procedure

Before connection, perform "Setup of Measuring Instrument" mentioned above.

Wireless LAN connection (For details, see E-6 to E-11.)

- Connect B-568 to GL240/GL840, and turn on the power.
For details, see the User's Manual of the product.
- Install the RNDIS driver of the printer that is included in the accompanied CD in the computer. (See E-7.)
- Connect the printer and the computer using the accompanied USB cable, and configure the printer. (See E-8.)
- Configure GL240/GL840 as the access point. (See E-9.)
- Search for GL240/GL840 to be connected on the printer Web screen.
- Connect the printer and GL240/GL840 and register.
- Perform test printing. Connection is completed.

USB connection (For details, see E-12.)

- Connect the Type-A side of the accompanied USB cable to the USB host port of GL980/GL2000 and connect the Type-C side to the printer. (See E-5.)
- By setting the printer function to USB on the menu screen when the USB cable is correctly connected, the printer icon becomes active and printing is available. (See E-12.)
- Perform test printing. If printing is properly performed, connection is completed.
No special installation procedures such as installing the printer driver that will be described later are necessary. You can use the printer immediately.

■ For reference: Summary of connection when using a wireless LAN router

To connect the measuring instrument and commercially available wireless router via wired connection (See E-5.)

- Connect the wireless LAN router and GL840/GL980/GL2000 by wire (wired connection), and specify the settings.
- Install the RNDIS driver of the printer that is included in the accompanied CD in the computer.
- Connect the printer and the computer using the accompanied USB cable, and display the printer Web screen.
- Search for the wireless LAN router to be connected on the printer Web screen.
- Connect the printer and the wireless LAN router, and register the printer.
- Perform test printing. Connection is completed.

To connect the measuring instrument and commercially available wireless router via wireless connection (See E-5.)

- Configure the wireless LAN router as the access point.
- Configure GL240/GL840 as the station, and connect GL240/GL840 with the wireless LAN router.
- Install the RNDIS driver of the printer.
- Display the printer Web screen.
- Search for the wireless LAN router to be connected on the printer Web screen.
- Connect the printer and the wireless LAN router, and register the printer.
- Perform test printing. Connection is completed.

Check for each connection image on E-5.

■ **Wireless LAN connection (Supported models: GL240/GL840)**

GL240/GL840 is configured as the access point.



The screen is for GL840.

Printer is configured as the station.

GL100 (WL sensor)

* If the setting above is specified, GL100 (WL sensor) cannot be connected to GL840.

■ **USB connection (Supported models: GL980/ GL2000)**

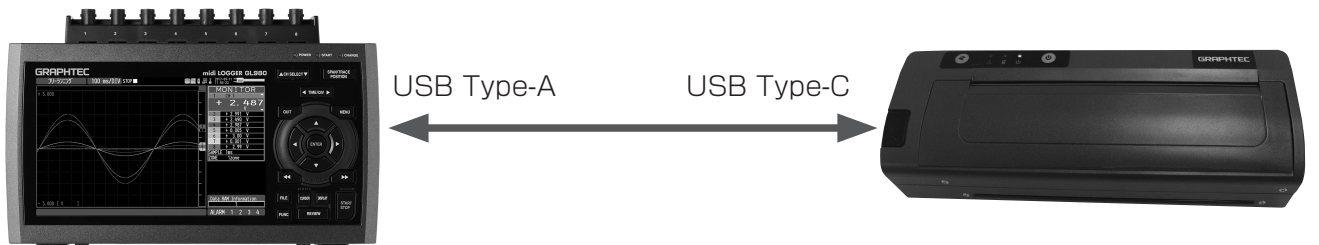

The screen is for GL980.

Printer

■ **For reference: Connection using a wireless LAN router**

To connect the measuring instrument and commercially available wireless router via wired connection (Supported models: GL840/GL980/GL2000):

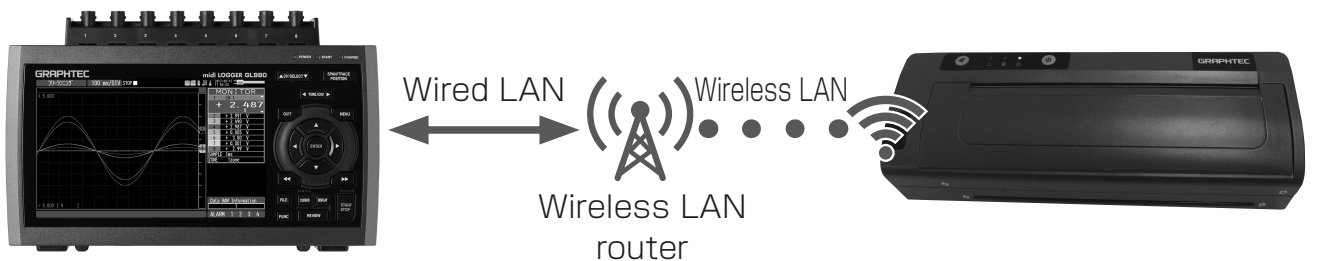

The screen is for GL980.

Printer is configured as the station.

To connect the measuring instrument and commercially available wireless router via wireless connection (Supported models: GL240/GL840):

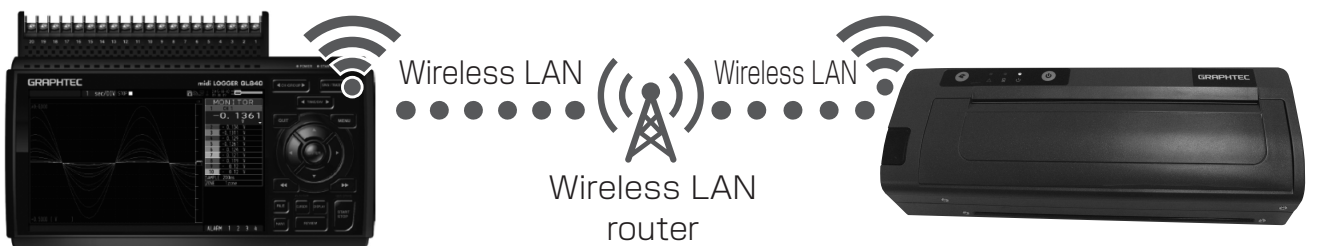

The screen is for GL840.
(Configured as the station)

Printer is configured as the station.

* If the settings are specified as described above, wired LAN on GL240/GL840 cannot be used.

* The above is for illustrative purposes only. If a commercially available wireless LAN router is used, proper operation, printed data, etc. are not guaranteed.

How to Connect via Wireless LAN

■ Wireless LAN settings

Specify the wireless connection settings on [LAN] on the menu of GL240, or specify on [WLAN] on GL840.

Specify the wireless LAN settings by the following procedure.
Set [Wireless LAN] from [Off] to [Access point].

For GL240



For GL840

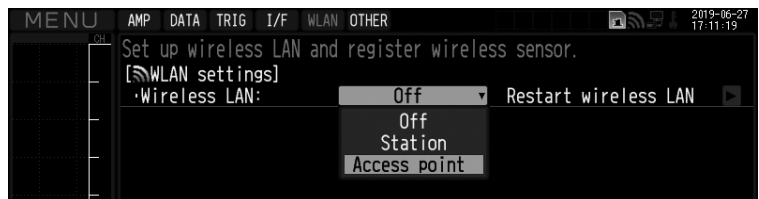
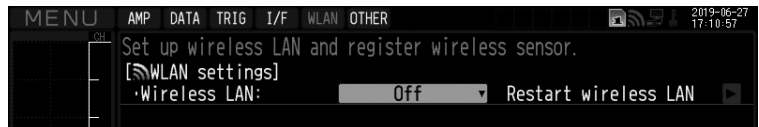

After setting to [Access point], restart the wireless LAN.

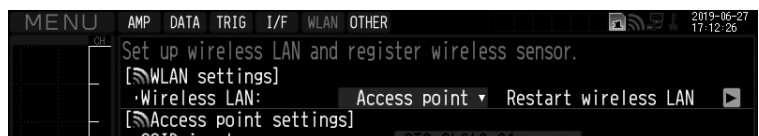
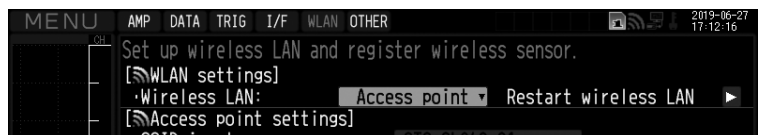

After restarting the wireless LAN, follow the instruction if turning the power on again is necessary.

Specify the necessary setting items such as SSID.

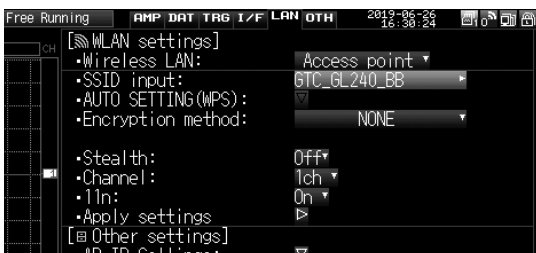

Specify the AP-IP setting, and reflect the setting.

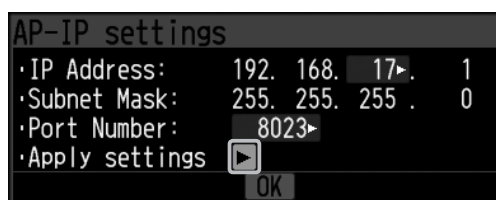
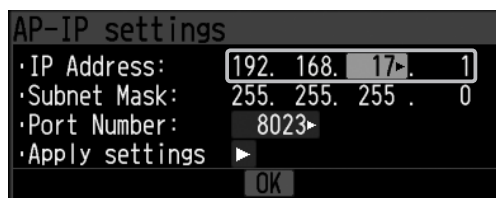
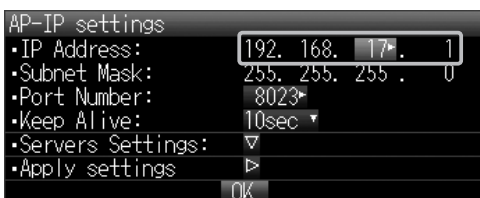

Specify the IP address.

Perform [Apply settings].

Next, specify the printer settings.

■ How to install printer driver

By connecting the computer and the printer using the accompanied USB cable, you can specify the various printer settings on a web browser of the computer.

To use the function that enables you to specify the setting on the Web, install the driver for Web setting in your computer.

1. Start "Install.exe" in "\Driver_Software\RNDIS_Driver\" folder in the accompanied CD.
2. The screen shown below is displayed. Click [Next].

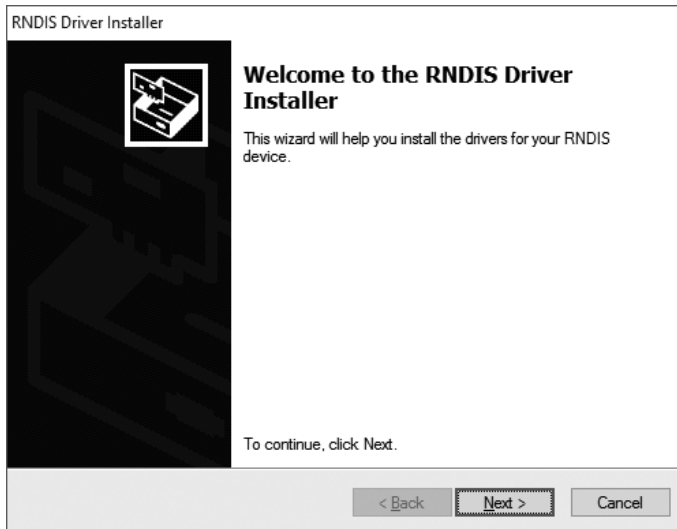

3. The screen shown below is displayed, and installation is completed. Click the [Finish] button to complete the installation.

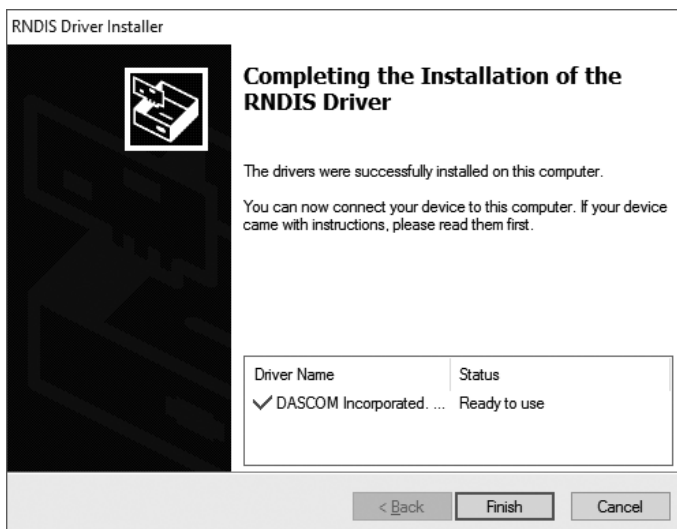

4. For the instruction on how to uninstall, see the User's Manual of the printer.

Next, display the printer Web screen.

■ How to display printer web screen

1. Turn on the printer.
2. Connect the printer and the computer using the accompanied USB cable.
3. Wait until the printer startup is complete, and the power lamp (green) lights up and the error lamp (red) goes off on the control panel.
4. Press the power button on the control panel twice consecutively.
5. The printer is in the setting mode, and the power lamp (green) and the error lamp (red) flash simultaneously.
6. After waiting for approximately 30 seconds, open a web browser (such as Internet Explorer) and enter 169.254.200.1 in the address bar. The login screen shown below is displayed.

* If the login screen is not displayed after entering the address, try again after a while. At the first connection or depending on computers, it may take a few minutes for the printer that is switched to Web setting mode to be recognized.

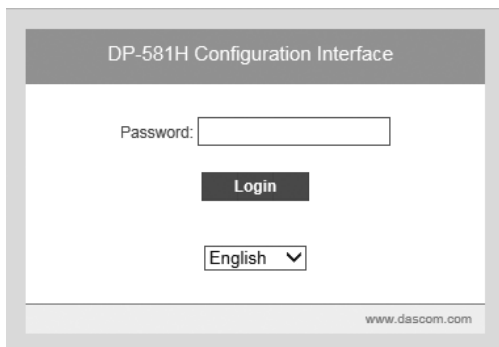

7. Enter 0000 for the password and press the [Enter] key. The Web screen as shown below will be displayed.

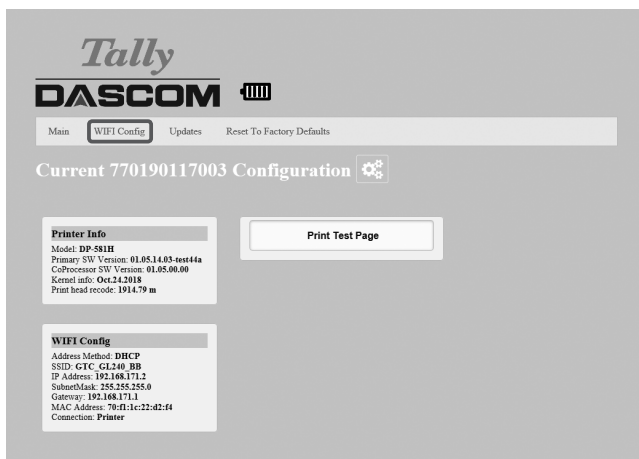

8. When the screen as shown above is displayed, specifying settings on the web is available.

To connect with the measuring instrument, select [WIFI Config] shown above. For other detailed settings, see the User's Manual of the printer.

9. Next, specify the Wi-Fi settings on the printer.

■ Wi-Fi settings on the printer

On the Wi-Fi setting screen, click [Add/Connect] for the measuring instrument that is specified on [Available Networks]. The following case is an example using GL240.

If no connected devices are displayed, specify the settings for the measuring instrument again.

Available Networks 

BSSID	Frequency	Signal Level	Flags	SSID	Add/Connect
██████████	2412	193	[WPS][ESS]	GTC_GL240_BB	<input type="button" value="Add/Connect"/>
██████████	2427	169	[WEP][ESS]	musen12345	<input type="button" value="Add/Connect"/>

Enter the same password as the one you entered for [Access point settings] in the wireless settings for the measuring instrument.

Password:

If the screen as shown below is displayed after connection, the settings are completed.

If wireless connection is not completed, specify the settings for the measuring instrument and the printer again.

On [Printer Name] shown below, the serial number is displayed initially.

The text can be edited within 15 characters.

Tally
DASCOM 

Main WiFi Config Updates Reset To Factory Defaults

Wireless Configuration 

IP Address	<input type="text" value="192"/> <input type="text" value="168"/> <input type="text" value="17"/> <input type="text" value="112"/>
SubnetMask	<input type="text" value="255"/> <input type="text" value="255"/> <input type="text" value="255"/> <input type="text" value="0"/>
Gateway	<input type="text" value="192"/> <input type="text" value="168"/> <input type="text" value="17"/> <input type="text" value="1"/>
Address Method	<input checked="" type="radio"/> Static <input type="radio"/> DHCP
Printer Name	<input type="text" value="DP-581H-BB"/>
Wifi Port	8023

Current Connection 

BSSID	SSID	ID	MODE	PAIRWISE_CIPHER	GROUP_CIPHER	KEY_MGMT	WPA_STATE	IP_ADDRESS
██████████	GTC_GL240_BB	0	station	NONE	NONE	NONE	COMPLETED	192.168.17.112

Previously Connected Networks 

Network ID	SSID	BSSID	Status	Connect/Disconnect	Remove
0	GTC_GL240_BB	any	CURRENT	<input type="button" value="Disconnect"/>	<input type="button" value="Remove"/>

After the Wi-Fi settings on the printer are completed, close the web browser. Disconnect the USB cable, restart the printer, and then specify the printer function settings on the measuring instrument.

■ Printer function settings

This section describes how to register the printer whose Wi-Fi setting is completed so that the printer is ready for printing.

In the following procedure, GL240 is used.

On the [OTH] menu, change the setting for [Printer function] from [Off] to [Wireless LAN].



By selecting [Wireless LAN] on [Printer function], [PRN] is added on the menu.



When wireless LAN is selected as the interface to be used, enter the printer name directly or search for the printer to be connected.

Printer search procedure

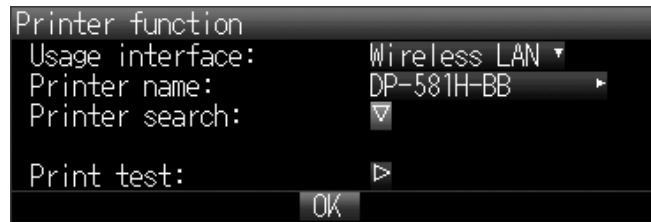
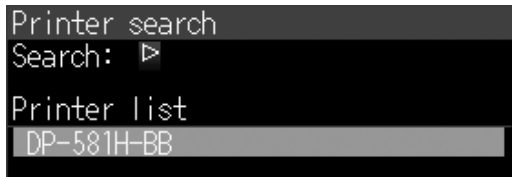
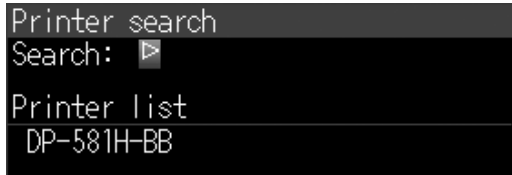

When printer name is directly entered:

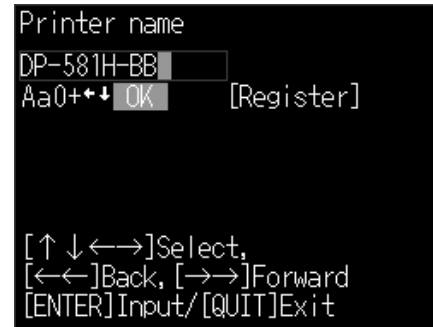

Press [OK] when the printer is registered.

If the test printing described above is successfully performed as shown below, the setting is completed.

GRAPHTEC

midi LOGGER GL240

The printer is displayed on the menu. Change the setting for [Printer] from [Off] to [On]. By setting to [On], printing is available when recording is performed.



Specify the settings for GL840 by following the same procedure.

How to Connect via USB

For GL980/GL2000, by specifying USB connection settings on [Printer function] on [OTHR], a printer icon is additionally displayed on the upper right of the screen, and the printer is added also on the menu.



Select [USB] for [Usage interface] on [Printer function]. The printer is additionally displayed on the upper right of the menu screen.



Icon displayed when [Printer] is [On].

If a printer available for printing is connected, the printer icon becomes active. This indicates that printing is available.



Icon displayed when [Printer] is [Off].

If the printer icon remains inactive, printing is not available. Check the connection again.

If test printing by [Print test] on [Printer function] is successfully performed, the connection is completed. Press [OK] to finish the connection setting. When the printer is displayed on the menu screen as shown below, configure the printer.



The printing functions are as follows:

For instructions on how to specify print settings, see the manual of the printer functions in the accompanied CD.

1. Direct Y-T printing
2. Hard copy printing
3. Memory out printing
4. List printing
5. Logging printing

Printer DP-581H Q&A

Q The green lamp blinks irregularly while printing.

A The green lamp blinks both when data is transferred to the printer and when printing is performed. This may cause irregular blinking.

Q While printing is performed, the yellow battery charging lamp blinks.

A The printer is charged intermittently when chart speed is 2 mm/s or slower. The lamp does not light up after charging is complete.

Q Can the battery be charged while printing?

A Charging is possible when chart speed is 2 mm/s or slower. However, charging time takes longer.

Q How many printouts can be output by one charge?

A Printing is possible for approximately 150 m under the following conditions: using a new battery, in a room, at chart speed 5 mm/s, and at low printing rate. This is equivalent to approximately 5 rolls of recording paper. Power source is retained for approximately 2 days after the printer is left turned on. Use this performance as a guide for printing in other chart speeds.

Q Is power source automatically switched by plugging and unplugging the AC adapter?

A This printer is designed for mobile or stationary use. Power source is not switched automatically. Be sure to turn off the printer before switching power source. If power source is switched while printing is performed, printing stops and the printer is also set to Off on the measuring instrument. The similar operations are performed when a power failure occurs or when recovering from a power failure. Be sure to check the printer settings on the measuring instrument.

Q A message indicating that printing cannot be performed is displayed on the measuring instrument.

A If an alert indicating that the recording paper runs out or the cover is open is displayed on the screen of the measuring instrument, refill the recording paper or close the cover. If the battery amount is below 25%, printing limit is applied to hard copy printing, if below 10%, the limit is applied to Y-T printing. Also, if the battery amount is below 15%, printing limit is applied to Y-T printing.

Q The printed waveform suddenly becomes thin during printing.

A When forced envelope is activated to protect the thermal head of the printer, the printed waveform looks like waves with only the upper and lower part left. Lower the printing rate if vertical lines such as square waves are not printed or printed thinly under high-temperature environment. These printer behaviors are not malfunctions but are intended to protect the thermal head. For details, see the descriptions on forced envelope in this manual.

Q How long is the recording paper?

A Approximately 30 m. Marker appears at approximately 1.5 m from the recording paper roll end. Use the marker as a guide for replacing the recording paper.

Q How is the recorded data treated when the recording paper runs out?

A Printing stops when the recording paper runs out. Data recording on the measuring instrument continues.

Q Cannot print after replacing the recording paper.

A The printer may be set to Off by the setting of the measuring instrument to retain the recorded data such as when the recording paper is replaced during recording/printing. If a message is displayed indicating that the printer is set to Off on the screen of the measuring instrument, set the printer to On again on the setting screen.

Q Does the recording paper shift to the right or left?

A There is 3 mm space in total on right and left side when the recording paper is loaded. Meandering width is approximately 3 mm.

Q Does the recording paper stick to the printer due to static electricity?

A Recording paper may stick to the printer in a low-temperature environment. Secure the recording paper output pathway depending on the output amount of the recording paper so that it may not stick to the printer.

Q For how many years is the recording paper usable? And for how many years can the printed paper be stored?

A The recording paper in unopened package can be used for approximately 1 year. The records on the printed paper can be kept for approximately 5 years in an environment in which the temperature is around 20° C and the relative humidity is around 65%.

* The state that light is blocked out means that the recording paper is wrapped with a file or paper and is stored in a place that is not exposed to light.

* The value above should be regarded as a reference because the storable years of the records drastically vary depending on environment where the paper is stored.

Q Can I use recording paper other than the dedicated recording paper?

A Using other recording paper may break the thermal head or other parts. Use the dedicated recording paper (PR-210X30).

Q Can memory logging printing be interrupted?

A You can stop printing by pressing the [QUIT] key on the measuring instrument.

Q Are there any points of attention for storing the printer for a prolonged time and for using the printer after storage?

A To store the printer for a prolonged time, charge the battery by approximately 50%. Storing with an almost empty battery shortens the lifetime. Also, avoid storing in a high-temperature environment. Doing so may deform the paper feed roller. When using the printer after long-period storage, printing for several meters as a test drive after charging the battery is recommended.

Printer Specifications

■ General configuration

Item	Specification
Supported models	GL240/GL840/GL980/GL2000
Accessories	1 set of AC adapter, 1 AC cable, 2 dedicated spacers (attached), 1 battery, 1 USB cable, 1 CD-ROM, 1 roll of recording paper, 1 copy of Quick Start Guide (each English and Japanese), 1 copy of Setup Guide (this manual)

■ Usage environment

Item	Specification
Usage environment	5° C to 35° C
Humidity	30% to 80% RH, no condensation
Storage environment temperature	-20°C to 60°C

■ Power source

Item	Specification	
Power source	AC adapter	100 - 240V
	Built-in battery pack	Dedicated 6-cell lithium-ion battery (11.1 V, 6000 mAh, 66.6 Wh)
Battery	Charging	Chargeable on main unit
	Remaining power	LED on main unit
Power consumption	125 W (Max)	
Battery run time	Printing approximately 150 m (at low printing rate)	

■ Applicable standards

Item	Specification
Radio wave interference/Safety standards	Japan, United States, Europe, China
Environmental standards	RoHS, PFOS
Radio law certification	Japan, United States, Europe, China

■ Dimensions/Weight

Item	Specification
External dimensions (approximate) [W × D × H]	312 × 109 × 66 mm (excluding protrusions)
Weight (approximate)	2.0kg (including dedicated battery)

■ Printer part

Item	Specification
Printing resolution	8 dots/mm
Paper feeding accuracy	± 2% ± 0.5 mm (with no environmental factors)
Paper feeding speed	Maximum 25 mm/s
Print width	Maximum 210 mm
Length of recording paper roll	30 m
Lifetime of head	50 km (when print density is 12.5%)
MTBF	20,000 hours
Sensor	End of paper, opened cover
Over current detection	Equipped

■ Control/indicator part

Item	Specification
Control part	Power key, paper feed key
Indicator part	3 status LEDs (for power, battery, and alert) Status of the product is indicated by lighting, blinking, or going off of the LEDs, and the combinations of these behaviors of the LEDs.

■ Option

Item	Specification
Print media	Dedicated recording paper: PR-210X30 (210 mm × 30 m, 6 rolls in 1 package)

GRAPHTEC

● Specifications are subject to change without notice.

GL-PRINTER Setup Guide
July 10, 2019

GRAPHTEC CORPORATION