









KNOCKOUTS

Since the day we invented the Knockout in 1928, we've made it our mission to build for the world's expert tradespeople. For decades, our manufacturing plants in Illinois have been building the widest range of high-quality holemaking products for trade professionals. Greenlee Knockouts are known as industry-leading products that allow professionals like you to complete any job more quickly and reliably. As the industry evolves and technology advances, we continue our 90-year legacy of providing optimal knockout solutions.

CONTENTS

Selection Guides	56
Slug-Buster® and Standard Round Kits, Sets and Parts	60
– Hydraulic Kits	60
– Ratchet Kits and Manual Sets	68
– Slug-Buster® Sets and Parts	71
– Standard Round Sets and Parts	72
– Draw Studs	74
Hydraulic C-Frame Kits	77
Slug Splitter® and Stainless Steel Kits, Sets and Parts	78
– Hydraulic Kits	78
– Slug Splitter® Sets and Parts	82
– Draw Studs	83
Slug-Buster® SPEED PUNCH® Kits, Sets and Parts	84
– Hydraulic Kits	84
Slug Splitter® SPEED PUNCH® Kits, Sets and Parts	88
– Hydraulic Kits	88
– Draw Studs	91
Special Application Punches	92
Stud Punches	98
Manual-Hydraulic Pumps and Accessories	101

GREENLEE KNOCKOUT DRIVERS SELECTION GUIDE

	DRIVER TYPE	CAPACITY		FEATURES	AVAILABLE IN KITS WITH THESE PUNCH TYPES	PAGE
		MILD STEEL	STAINLESS STEEL			
	LS100X Intelli-PUNCH™ Battery-Hydraulic Driver	4" conduit in 10 ga	4" conduit in 10 ga	<ul style="list-style-type: none"> • 6.1 lb with battery – 31% lighter than competition • 11 tons of punching force • Patent-pending auto-retract technology • 360° rotating head • Rugged neck • Punch faster, with a maximum cycle time of 8 seconds • Compact, ergonomic design • LED light illuminates dark work areas • i-press® software • Powerful, long-lasting Makita® 18V Li-Ion battery 	Slug-Buster® (up to 2" conduit) Standard Round (2-1/2" conduit and up) Slug Splitter® SPEED PUNCH®	60 – 61
		6" conduit in 14 ga				60
	LS50L2 Battery-Hydraulic Driver	4" conduit in 12 ga	2" conduit in 12 ga	<ul style="list-style-type: none"> • 4.6 lb with battery – 13% lighter than competition • 7 tons of punching force • Auto-stop feature • 360° rotating head • Rugged neck • Punch faster, with a maximum cycle time of 8 seconds • Compact, ergonomic design • LED light illuminates dark work areas • i-press® software • Powerful, long-lasting Makita® 18V Li-Ion battery 	Slug-Buster® (up to 2" conduit) Standard Round (2-1/2" conduit and up) SPEED PUNCH®	60 – 61
		3" conduit in 10 ga				60
	Manual-Hydraulic Ram and Pump Drivers	4" conduit in 10 ga	4" conduit in 10 ga	<ul style="list-style-type: none"> • 11 tons of punching force • Punches 10 times faster than wrench method • Compact, lightweight design for easy portability and fast, one-person operation • Available with hand pump or foot pump – allows for a variety of operation orientations 	Slug-Buster® Standard Round Slug Splitter® SPEED PUNCH®	62 – 63
		6" conduit in 14 ga				64 – 65
	Quick Draw® Manual-Hydraulic Driver	2" conduit in 10 ga	2" conduit in 10 ga	<ul style="list-style-type: none"> • 8 tons of punching force • Compact, portable design for easy, fast one-person operation • Available in 3 driver orientations: <ul style="list-style-type: none"> • Quick Draw 90° – right angle driver head rotations over 180° for maneuverability in tight work areas • Quick Draw® – fast, straight-on punching • Quick Draw Flex® – allows for maximum flexibility in tight work areas 	Slug-Buster® SPEED PUNCH®	66 – 67
		2" conduit in 10 ga				86 – 87
	C-Frame Hydraulic Driver	4" conduit in 10 ga	–	<ul style="list-style-type: none"> • Fast, one-shot punching – eliminates need for pilot hole 	Standard Round	77
		6" conduit in 14 ga				
	Manual Ratchet Wrench	2" conduit in 14 ga	–	<ul style="list-style-type: none"> • High-leverage wrench with a 5-degree ratcheting mechanism provides versatility and accessibility in tight work spaces • Long, overmold handle offers greater leverage, comfort and grip 	Slug-Buster® Standard Round	68 – 70
		2" conduit in 14 ga				68 – 69

GREENLEE KNOCKOUT PUNCH SELECTION GUIDE



KD-2

K2P-2

New Slug-Buster® and Standard Round Knockouts

- Knurled edge on punches for better grip
- New die design optimized for widest range of materials and drivers
- Laser markings for easy part identification
- Alignment markings for improved punching accuracy
- Draw studs with “dog-point” tip help eliminate cross threading and make threading easy. Hex key access for easy removal from tool.

Slug-Buster®

- Punch profile splits slugs for easy slug removal

SPECIFICATIONS – SLUG-BUSTER®		PAGE 60-63, 66-71
Size Range	0.49" – 2.52" dia. (12.5 mm – 64.0 mm)	
Capacity	Punch up to 10 ga mild steel Punch up to 12 ga stainless steel Also punches aluminum, metal studs, brass, copper, Quazite® enclosures, fiberglass, and plastics	
Driver Compatibility	Use with Greenlee hydraulic drivers or ratchet wrench	



KD-2

K3P-2

Standard Round

- Greenlee classic knockout, widest size selection available

SPECIFICATIONS – STANDARD ROUND		PAGE 64-65, 72-73, 77
Size Range	0.50" – 6.38" dia. (12.7 – 161.0 mm)	
Capacity	Punch up to 4" conduit in 10 ga mild and stainless steel Punch up to 6" conduit in 14 ga mild steel Also punches aluminum, brass, copper, fiberglass, and plastics	
Driver Compatibility	Use with Greenlee hydraulic drivers	



00626

00622

Slug Splitter® and Stainless Steel Punches

- Best solution for frequent use in stainless steel

SPECIFICATIONS – SLUG SPLITTER®		PAGE 78-82
Size Range	0.60" – 4.54" dia. (15.2 mm – 115.4 mm)	
Capacity	Punch up to 10 ga stainless and mild steel Also punches aluminum, brass, copper, fiberglass, and plastics	
Driver Compatibility	Use with Greenlee hydraulic drivers	



7212SP-2D

7212SP-2P

SPEED PUNCH®

- Threadless design for quicker knockout assembly/disassembly
- Laser markings for easy part identification
- Alignment markings for improved punching accuracy

SPECIFICATIONS – SPEED PUNCH®		PAGE 84-89
Size Range	0.89" – 4.54" dia. (28.3 mm – 115.4 mm)	
Capacity	Punch up to 10 ga mild steel Also punches aluminum, brass, copper, fiberglass, and plastics	
Driver Compatibility	Use with Greenlee hydraulic drivers or ratchet wrench	

NOTE: Check driver ratings before use.
Quarite is a registered trademark of Hubbell Inc.



4" CONDUIT
4.54"(115.4MM)

BATTERY-HYDRAULIC DRIVERS

Compact, fast, and powerful battery-hydraulic knockout drivers capable of punching up to 6-inch conduit sized holes in mild steel, stainless steel, aluminum, brass, copper, fiberglass and plastics.



LS100X

- 360° rotating head – rugged patent-pending swivel design to easily punch at any angle
- Rugged neck – increased durability and life of tool
- Timesaver – punch faster, with a maximum cycle time of 8 seconds
- Compact, ergonomic design – provides easy one-handed operation and an ergonomic tapered grip
- Compatibility – works with all Greenlee knockouts and other major brands designed for use with a hydraulic tool. Same draw studs used with the LS100X Intelli-PUNCH™, LS50L2 and 746A ram
- Battery platform – powerful long-lasting Makita® 18V Li-Ion battery, quickly charges in 30 minutes
- i-press® software – monitor tool performance and set service intervals via i-press® Bluetooth® communication. LS50L2 compatible with Gator Eye® desktop software.

LS100X Intelli-PUNCH™

- Patent-pending auto-retract technology – pressure-sensing technology accurately detects punch completion and automatically retracts the ram, helping to prevent damage to knockout parts

SPECIFICATIONS

Tonnage	11
Capacity	4" conduit up to 10 ga mild steel 4" conduit up to 10 ga stainless steel



LS50L2

LS50L2

- Auto-stop feature – detects punch completion and automatically stops, helping to prevent damage to knockout parts

SPECIFICATIONS

Tonnage	7
Capacity	4" conduit up to 12 ga mild steel 3" conduit up to 10 ga mild steel 2" conduit up to 12 ga stainless steel

BATTERY-HYDRAULIC KITS WITH SLUG-BUSTER® PUNCHES



LS100X11SB4

LS100X INTELLI-PUNCH™ 11-TON BATTERY-HYDRAULIC KNOCKOUT KITS

CAT NO.	UPC NO.	DESCRIPTION
LS100X11SB4	783310064848	Slug-Buster® 1/2" to 4" Conduit
LS100X11SB4X	783310064855	Slug-Buster® 1/2" to 3" and 4" Conduit
LS100X11SB	783310064831	Slug-Buster® 1/2" to 2" Conduit
LS100X11A	783310064824	Driver, Draw Studs, Batteries, Charger and Case
LS100XB	783310064817	Driver and Case Only
LS100X	783310088059	Driver Only



LS50L11B4

LS50L2 7-TON BATTERY-HYDRAULIC KNOCKOUT KITS

CAT NO.	UPC NO.	DESCRIPTION
LS50L11B4	783310037743	Slug-Buster® 1/2" to 4" Conduit
LS50L11B	783310049562	Slug-Buster® 1/2" to 2" Conduit
LS50L11A	783310049517	Driver, Draw Studs, Battery, Charger and Case
LS50LB	783310011316	Driver and Case Only
LS50L2	783310088042	Driver Only



7304



LARGE DIAMETER KNOCKOUT EXPANSION SET

CAT NO.	UPC NO.	DESCRIPTION
7304	783310028154	Standard Round 2-1/2", 3", 3-1/2" and 4" Conduit

Upgrade your knockouts and case to fit your existing manual-hydraulic ram and hand pump driver.



KCC4-LS

Fits Greenlee LS50L2 or LS100X tool, two batteries and a charger

KNOCKOUT UPGRADE SETS FOR BATTERY-HYDRAULIC DRIVERS

CAT NO.	UPC NO.	DESCRIPTION
KCC4-LS	783310088028	Slug-Buster® 1/2" to 4" Conduit
KCC2-LS	783310088004	Slug-Buster® 1/2" to 2" Conduit

PARTS LIST

CONDUIT SIZE	HOLE SIZE		CAT. NO.	DESCRIPTION	LS100X11SB4	LS100X11SB4X	LS100X11SB	LS50L11B4	LS50L11B	
	ACTUAL									
	IN	mm								
1/2"	7/8"	0.885	22.5	K2P-1/2	1/2" Slug-Buster® Punch	X	X	X	X	X
				KD-1/2	1/2" Knockout Die	X	X	X	X	X
3/4"	-	1.115	28.3	K2P-3/4	3/4" Slug-Buster® Punch	X	X	X	X	X
				KD-3/4	3/4" Knockout Die	X	X	X	X	X
1"	-	1.362	34.6	K2P-1	1" Slug-Buster® Punch	X	X	X	X	X
				KD-1	1" Knockout Die	X	X	X	X	X
1-1/4"	1-11/16"	1.701	43.2	K2P-1-1/4	1-1/4" Slug-Buster® Punch	X	X	X	X	X
				KD-1-1/4	1-1/4" Knockout Die	X	X	X	X	X
1-1/2"	1-15/16"	1.951	49.6	K2P-1-1/2	1-1/2" Slug-Buster® Punch	X	X	X	X	X
				KD-1-1/2	1-1/2" Knockout Die	X	X	X	X	X
2"	2-3/8"	2.416	61.5	K2P-2	2" Slug-Buster® Punch	X	X	X	X	X
				KD-2	2" Knockout Die	X	X	X	X	X
2-1/2"	2-7/8"	2.914	74.0	K3P-2-1/2	2-1/2" Standard Round Punch	X	X	-	X	-
				KD-2-1/2	2-1/2" Knockout Die	X	X	-	X	-
3"	3-1/2"	3.539	89.9	K3P-3	3" Standard Round Punch	X	X	-	X	-
				KD-3	3" Knockout Die	X	X	-	X	-
3-1/2"	4"	4.011	102.7	K3P-3-1/2	3-1/2" Standard Round Punch	X	-	-	X	-
				KD-3-1/2	3-1/2" Knockout Die	X	-	-	X	-
4"	4-1/2"	4.544	115.4	K3P-4	4" Standard Round Punch	X	X	-	X	-
				KD-4	4" Knockout Die	X	X	-	X	-
				DSH-7/16	7/16" Hydraulic Draw Stud	X	X	X	X	X
				DSH-3/4	3/4" Hydraulic Draw Stud	X	X	X	X	X
				DSH-1-1/8	1-1/8" Hydraulic Draw Stud	X	X	-	X	-
				LS50L2	7-Ton Battery-Hydraulic Driver	-	-	-	X	X
				LS100X	LS100X Intelli-PUNCH™ 11-Ton Battery-Hydraulic Driver	X	X	X	-	-
				52190	18V Li-ion 2.0Ah Battery	-	-	-	X	X
				52189	18V Li-ion 3.0Ah Battery	-	-	-	-	-
				52186	120V AC Charger	X	X	X	X	X
				KCC-LS2	Case for 1/2" - 2" Battery-Hydraulic Kits	-	-	X	-	X
				KCC-LS4	Case for 1/2" - 4" Battery-Hydraulic Kits	-	X	X	X	-

MANUAL-HYDRAULIC RAM & PUMP KITS WITH SLUG-BUSTER® PUNCHES



7310SB

- 11 tons of punching force
- Time Saver – punches 10 times faster than wrench method
- Compact, lightweight design for easy portability and fast, one-person operation
- Foot operation frees both hands to position punch
- Punch 4" conduit up to 10 ga mild steel and 12 ga stainless steel
- Also punches brass, copper, aluminum, fiberglass and plastics

11-TON HYDRAULIC KNOCKOUT KITS WITH HAND PUMP

CAT. NO.	UPC NO.	DESCRIPTION
7310SB	783310343615	Slug-Buster® 1/2" to 4"
7309SB	783310088325	Slug-Buster® 1/2", 3" and 4"
7306SB	783310343608	Slug-Buster® 1/2" to 2"
7646	783310159063	Ram and Hand Pump Group, Draw Studs, and Case Only



7610SB

11-TON HYDRAULIC KNOCKOUT KITS WITH FOOT PUMP

CAT. NO.	UPC NO.	DESCRIPTION
7610SB	783310071747	Slug-Buster® 1/2" to 4"
7606SB	783310071730	Slug-Buster® 1/2" to 2"
7625	783310250975	Ram/Foot Pump Group, Draw Studs, and Case Only



7304



LARGE DIAMETER KNOCKOUT EXPANSION SET

CAT. NO.	UPC NO.	DESCRIPTION
7304	783310028154	Standard Round 2-1/2", 3", 3-1/2" and 4" Conduit

Upgrade your knockouts and case to fit your existing manual-hydraulic ram and hand pump driver.





Fits Greenlee 746A Ram and 767 Hand Pump

KCC4-767



KNOCKOUT UPGRADE SETS FOR RAM AND HAND PUMP

CAT. NO.	UPC NO.	DESCRIPTION
 KCC4-767	783310088011	Slug-Buster® 1/2" to 4" Conduit
 KCC2-767	783310087991	Slug-Buster® 1/2" to 2" Conduit

PARTS LIST

CONDUIT SIZE	HOLE SIZE		CAT. NO.	DESCRIPTION	7310SB	7309SB	7306SB	7610SB	7606SB	
	ACTUAL									
	IN	mm								
1/2"	7/8"	0.885	22.5	K2P-1/2	1/2" Slug-Buster® Punch	X	X	X	X	X
				KD-1/2	1/2" Knockout Die	X	X	X	X	X
3/4"	-	1.115	28.3	K2P-3/4	3/4" Slug-Buster® Punch	X	X	X	X	X
				KD-3/4	3/4" Knockout Die	X	X	X	X	X
1"	-	1.362	34.6	K2P-1	1" Slug-Buster® Punch	X	X	X	X	X
				KD-1	1" Knockout Die	X	X	X	X	X
1-1/4"	1-11/16"	1.701	43.2	K2P-1-1/4	1-1/4" Slug-Buster® Punch	X	X	X	X	X
				KD-1-1/4	1-1/4" Knockout Die	X	X	X	X	X
1-1/2"	1-15/16"	1.951	49.6	K2P-1-1/2	1-1/2" Slug-Buster® Punch	X	X	X	X	X
				KD-1-1/2	1-1/2" Knockout Die	X	X	X	X	X
2"	2-3/8"	2.416	61.5	K2P-2	2" Slug-Buster® Punch	X	X	X	X	X
				KD-2	2" Knockout Die	X	X	X	X	X
2-1/2"	2-7/8"	2.914	74.0	K3P-2-1/2	2-1/2" Slug-Buster® Punch	X	-	X	X	-
				KD-2-1/2	2-1/2" Knockout Die	X	-	X	X	-
3"	3-1/2"	3.539	89.9	K3P-3	3" Slug-Buster® Punch	X	-	X	X	-
				KD-3	3" Knockout Die	X	-	X	X	-
3-1/2"	4"	4.011	102.7	K3P-3-1/2	3-1/2" Slug-Buster® Punch	X	-	X	-	-
				KD-3-1/2	3-1/2" Knockout Die	X	-	X	-	-
4"	4-1/2"	4.544	115.4	K3P-4	4" Slug-Buster® Punch	X	-	X	X	-
				KD-4	4" Knockout Die	X	-	X	X	-
				DSH-7/16	7/16" Hydraulic Draw Stud	X	X	X	X	X
				DSH-3/4	3/4" Hydraulic Draw Stud	X	X	X	X	X
				DSH-1-1/8	1-1/8" Hydraulic Draw Stud	X	X	-	X	-
				746A	(A) Ram	X	X	X	-	-
				746ATC	(F) Ram	-	-	-	X	X
				767	(B) Hydraulic Hand Pump	X	X	X	-	-
				06302	(C) High Pressure Hose - 1/4" x 3'	X	X	X	-	-
				1725	(D) Hydraulic Foot Pump (includes 1 ea. - 54167 Female Coupler and 54168 Dust Plug)	-	-	-	X	X
				37728	(E) High Pressure Hose Unit - 1/4" x 10'; filled with hydraulic oil; (includes 2 ea. - 54169 coupler and 54170 dust cap)	-	-	-	X	X
				KCC-7672	Case for 1/2" - 2" Ram and Hand Pump Kits	-	-	X	-	-
				KCC-7674	Case for 1/2" - 4" Ram and Hand Pump Kits	X	X	-	-	-
				KCC-17254	Steel Case for 1/2" - 4" Ram and Foot Pump Kits	-	-	-	X	X

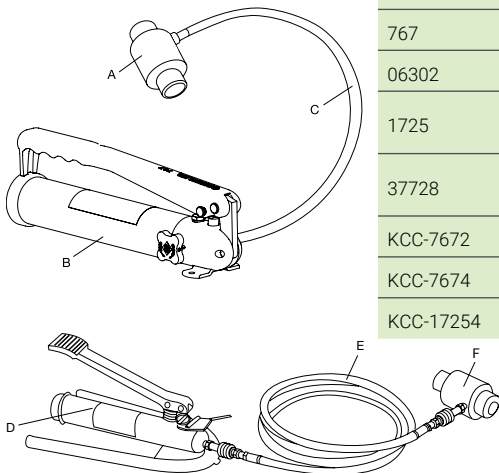

MANUAL-HYDRAULIC RAM & PUMP KITS WITH STANDARD ROUND PUNCHES



7310

- 11 tons of punching force
- Time Saver – punches 10 times faster than wrench method
- Compact, lightweight design for easy portability and fast, one-person operation
- Foot operation frees both hands to position punch
- Punch 4" conduit up to 10 ga mild steel and 12 ga stainless steel
- Also punches brass, copper, aluminum, fiberglass and plastics

11-TON MANUAL-HYDRAULIC KNOCKOUT KITS WITH HAND PUMP

CAT. NO.	UPC NO.	DESCRIPTION
7310	783310159100	Standard Round 1/2" to 4" Conduit
7309	783310088318	Standard Round 1/2" to 3" and 4" Conduit
7306	783310159094	Standard Round 1/2" to 2" Conduit
7646	783310159063	Ram and Hand Pump Group, Draw Studs, and Case Only



7304



LARGE DIAMETER KNOCKOUT EXPANSION SET

CAT. NO.	UPC NO.	DESCRIPTION
7304	783310028154	Standard Round 2-1/2", 3", 3-1/2" and 4" Conduit

PARTS LIST

CONDUIT SIZE	HOLE SIZE		CAT. NO.	DESCRIPTION	7310	7309	7306	
	ACTUAL							
	IN	mm						
1/2"	7/8"	0.885	22.5	K3P-1/2	1/2" Standard Round Punch	X	X	X
				KD-1/2	1/2" Knockout Die	X	X	X
3/4"	-	1.115	28.3	K3P-3/4	3/4" Standard Round Punch	X	X	X
				KD-3/4	3/4" Knockout Die	X	X	X
1"	-	1.362	34.6	K3P-1	1" Standard Round Punch	X	X	X
				KD-1	1" Knockout Die	X	X	X
1-1/4"	1-11/16"	1.701	43.2	K3P-1-1/4	1-1/4" Standard Round Punch	X	X	X
				KD-1-1/4	1-1/4" Knockout Die	X	X	X
1-1/2"	1-15/16"	1.951	49.6	K3P-1-1/2	1-1/2" Standard Round Punch	X	X	X
				KD-1-1/2	1-1/2" Knockout Die	X	X	X
2"	2-3/8"	2.416	61.5	K3P-2	2" Standard Round Punch	X	X	X
				KD-2	2" Knockout Die	X	X	X
2-1/2"	2-7/8"	2.914	74.0	K3P-2-1/2	2-1/2" Standard Round Punch	X	X	-
				KD-2-1/2	2-1/2" Knockout Die	X	X	-
3"	3-1/2"	3.539	89.9	K3P-3	3" Standard Round Punch	X	X	-
				KD-3	3" Knockout Die	X	X	-
3-1/2"	4"	4.011	102.7	K3P-3-1/2	3-1/2" Standard Round Punch	X	-	-
				KD-3-1/2	3-1/2" Knockout Die	X	-	-
4"	4-1/2"	4.544	115.4	K3P-4	4" Standard Round Punch	X	X	-
				KD-4	4" Knockout Die	X	X	-
				DSH-7/16	7/16" Hydraulic Draw Stud	X	X	X
				DSH-3/4	3/4" Hydraulic Draw Stud	X	X	X
				DSH-1-1/8	1-1/8" Hydraulic Draw Stud	X	X	-
				746A	(A) Ram	X	X	X
				767	(B) Hydraulic Hand Pump	X	X	X
				06302	(C) High Pressure Hose - 1/4" x 3'	X	X	X
				KCC-7672	Case for 1/2" - 2" Ram and Hand Pump Kits	-	-	X
				KCC-7674	Case for 1/2" - 4" Ram and Hand Pump Kits	X	X	-

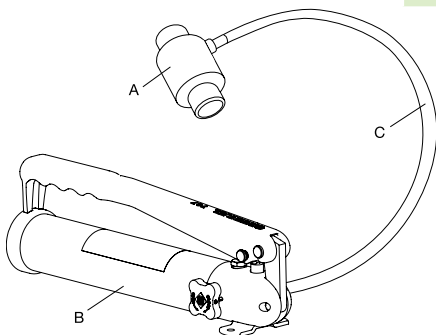

QUICK DRAW® MANUAL-HYDRAULIC KITS WITH SLUG-BUSTER® PUNCHES



Quick Draw® 8-Ton Manual-Hydraulic Drivers

- 8 tons of punching force
- Compact Design – for portability and fast, easy one-person operation
- Punch 2" conduit up to 10 ga mild steel and 12 ga stainless steel
- Also punches brass, copper, aluminum, fiberglass and plastics



Quick Draw 90°®

- 180° Rotating Head – Right angle driver head rotates over 180° for maneuverability in tight work areas

QUICK DRAW 90° 8-TON HYDRAULIC KNOCKOUT KITS

CAT. NO.	UPC NO.	DESCRIPTION
7906SB	783310343004	Slug-Buster® 1/2" to 2"
7904SB	783310337942	Driver, Draw Studs and Case Only



Quick Draw®

- Fast, straight-on punching

QUICK DRAW® 8-TON HYDRAULIC KNOCKOUT KITS

CAT. NO.	UPC NO.	DESCRIPTION
7806SB	783310342939	Slug-Buster® 1/2" to 2"
7804SB	783310342922	Driver, Draw Studs and Case Only



Quick Draw® Flex

- Flex head allows for maximum flexibility in tight working areas

QUICK DRAW® FLEX 8-TON HYDRAULIC KNOCKOUT KITS

CAT. NO.	UPC NO.	DESCRIPTION
7706SB	783310104766	Slug-Buster® 1/2" to 2"
7704SB	783310104759	Driver, Draw Studs and Case Only

Upgrade your knockouts and case to fit your existing Quick Draw 90° or Quick Draw drivers.



KCC2-QD

Fits Greenlee Quick Draw® or Quick Draw c90° Driver

KNOCKOUT UPGRADE SETS FOR QUICK DRAW DRIVERS

CAT. NO.	UPC NO.	DESCRIPTION
KCC2-QD	783310087984	Slug-Buster® 1/2" to 2" Conduit

PARTS LIST

CONDUIT SIZE	HOLE SIZE		CAT. NO.	DESCRIPTION	7906SB	7806SB	7706SB	
	ACTUAL							
	IN	mm						
1/2"	7/8"	0.885	22.5	K2P-1/2	1/2" Slug-Buster® Punch	X	X	X
				KD-1/2	1/2" Knockout Die	X	X	X
3/4"	-	1.115	28.3	K2P-3/4	3/4" Slug-Buster® Punch	X	X	X
				KD-3/4	3/4" Knockout Die	X	X	X
1"	-	1.362	34.6	K2P-1	1" Slug-Buster® Punch	X	X	X
				KD-1	1" Knockout Die	X	X	X
1-1/4"	1-11/16"	1.701	43.2	K2P-1-1/4	1-1/4" Slug-Buster® Punch	X	X	X
				KD-1-1/4	1-1/4" Knockout Die	X	X	X
1-1/2"	1-15/16"	1.951	49.6	K2P-1-1/2	1-1/2" Slug-Buster® Punch	X	X	X
				KD-1-1/2	1-1/2" Knockout Die	X	X	X
2"	2-3/8"	2.416	61.5	K2P-2	2" Slug-Buster® Punch	X	X	X
				KD-2	2" Knockout Die	X	X	X
				DSH-S7/16	7/16" Short Hydraulic Draw Stud	X	X	X
				DSH-S3/4	3/4" Short Hydraulic Draw Stud	X	X	X
				33786	Quick Draw 90® Hydraulic Driver	X	-	-
				34288	Quick Draw® Hydraulic Driver	-	X	-
				10383	Quick Draw Flex® Hydraulic Driver	-	-	X
				KCC2-QD	Case for 1/2" - 2" Quick Draw 90® and Quick Draw® Kits	X	X	-
				KCC2-QDF	Case for 1/2" - 2" Quick Draw Flex® Kits	-	-	X

RATCHET KITS AND MANUAL SETS



- New and improved high-leverage wrench with five-degree ratcheting mechanism provides versatility and accessibility in tight spaces
- The long, over-mold handle offers greater leverage, comfort and grip
- Punch 1/2" to 2" conduit size holes in 10 ga mild steel
- punches aluminum, brass, copper, fiberglass and plastics



New High-Leverage Ratchet Wrench

RATCHET WRENCH KITS

CAT. NO.	UPC NO.	DESCRIPTION
7238SB	783310347576	Slug-Buster® 1/2" to 2"
7240SB	783310028604	Slug-Buster® 1/2", 3/4" Conduit, 30.5 mm



MANUAL KNOCKOUT SETS

CAT. NO.	UPC NO.	DESCRIPTION
7237BB	783310320142	Slug-Buster® 1-1/2" to 2" Conduit
737BB	783310199748	Standard Round 1-1/2" to 2" Conduit
7235BB	783310320135	Slug-Buster® 1/2" to 1-1/4" Conduit
735BB	783310199731	Standard Round 1/2" to 1-1/4" Conduit



RATCHET WRENCH KITS – METRIC

CAT. NO.	UPC NO.	DESCRIPTION
36690	783310366904	Slug-Buster® Pg-9 to Pg-21 and 30.5 mm
36691	783310366911	Slug-Buster® Pg-9 to Pg-48 and 30.5 mm
36692	783310366928	Slug-Buster® ISO-16 to ISO-40
36693	783310366935	Slug-Buster® ISO-16 to ISO-63

PARTS LIST

CONDUIT SIZE	HOLE SIZE		CAT NO.	DESCRIPTION	7238SB	7240SB	7237BB	737BB	7235BB	735BB	
	ACTUAL										
	INCHES	MM									
1/2"	7/8"	0.885	22.5	K2P-1/2	1/2" Slug-Buster® Punch	X	X	-	-	X	-
				K3P-1/2	1/2" Standard Round Punch	-	-	-	-	-	X
				KD-1/2	1/2" Knockout Die	X	X	-	-	X	X
3/4"	-	1.115	28.3	K2P-3/4	3/4" Slug-Buster® Punch	X	X	-	-	X	-
				K3P-3/4	3/4" Standard Round Punch	-	-	-	-	-	X
				KD-3/4	3/4" Knockout Die	X	X	-	-	X	X
-	1-7/32"	1.219	30.5	K2PM-0305	30.5 mm Slug-Buster® Punch	-	X	-	-	-	-
				KDM-0305	30.5 mm Knockout Die	-	X	-	-	-	-
1"	-	1.362	34.6	K2P-1	1" Slug-Buster® Punch	X	-	-	-	X	-
				K3P-1	1" Standard Round Punch	-	-	-	-	-	X
				KD-1	1" Knockout Die	X	-	-	-	X	X
1-1/4"	1-11/16"	1.701	43.2	K2P-1-1/4	1-1/4" Slug-Buster® Punch	X	-	-	-	X	-
				K3P-1-1/4	1-1/4" Standard Round Punch	-	-	-	-	-	X
				KD-1-1/4	1-1/4" Knockout Die	X	-	-	-	X	X
1-1/2"	1-15/16"	1.951	49.6	K2P-1-1/2	1-1/2" Slug-Buster® Punch	X	-	X	-	-	-
				K3P-1-1/2	1-1/2" Standard Round Punch	-	-	-	X	-	-
				KD-1-1/2	1-1/2" Knockout Die	X	-	X	X	-	-
2"	2-3/8"	2.416	61.5	K2P-2	2" Slug-Buster® Punch	X	-	X	-	-	-
				K3P-2	2" Standard Round Punch	-	-	-	X	-	-
				KD-2	2" Knockout Die	X	-	X	X	-	-
				DSBB-7/16	7/16" Manual Draw Stud for 1/2" Conduit Size Knockouts	X	X	X	X	X	X
				DSBB-3/4	3/4" Manual Draw Stud for 3/4" - 2" Conduit Size Knockouts	X	X	X	X	X	X
				KRW-1	1" Ratchet Wrench	X	X	-	-	-	-
				KCC-RW2	Case for 1/2" - 2" Ratchet Wrench Kits	X	X	-	-	-	-
				KCC-BB2	Case for 1-1/2" - 2" Manual Sets	-	-	X	X	-	-
				KCC-BB1-1/4	Case for 1/2" - 1-1/4" Manual Sets	-	-	-	-	X	X

RATCHET KITS PARTS LIST – METRIC

HOLE SIZE			CAT. NO.	DESCRIPTION	36690	36691	36692	36693	
IN	mm	PG/ISO							
-	0.598	15.2	Pg-9	721E-15.2	Pg-9 Slug-Buster® Punch	X	X	-	-
				32002	Pg-9 Knockout Die	X	X	-	-
-	0.638	16.2	ISO-16	35163	ISO-16 Slug-Buster® Punch	-	-	X	X
				35162G	ISO-16 Knockout Die	-	-	X	X
-	0.732	18.6	Pg-11	721E-18.6	Pg-11 Slug-Buster® Punch	X	X	-	-
				32003	Pg-11 Knockout Die	X	X	-	-
-	0.803	20.4	Pg-13.5 / ISO-20	721E-20.4	Pg-13 Slug-Buster® Punch	X	X	X	X
				32004	Pg-13 Knockout Die	X	X	X	X
7/8	0.885	22.5	Pg-16	721E-22.5	Pg-16 Slug-Buster® Punch	X	X	-	-
				14722	Pg-16 Knockout Die	X	X	-	-
1	1.000	25.4	ISO-25	35165	ISO-25 Slug-Buster® Punch	-	-	X	X
				35164	ISO-25 Knockout Die	-	-	X	X
-	1.115	28.3	Pg-21	721E-28.3	Pg-21 Slug-Buster® Punch	X	X	-	-
				32006	Pg-21 Knockout Die	X	X	-	-
1-7/32	1.219	30.5	-	36284	30.5 mm Slug-Buster® Punch	X	X	-	-
				36279	30.5 mm Knockout Die	X	X	-	-
-	1.280	32.5	ISO-32	35169	ISO-32 Slug-Buster® Punch	-	-	X	X
				35168	ISO-32 Knockout Die	-	-	X	X
-	1.457	37.0	Pg-29	721E-37.0	Pg-29 Slug-Buster® Punch	-	X	-	-
				32008	Pg-29 Knockout Die	-	X	-	-
-	1.595	40.5	ISO-40	35158	ISO-40 Slug-Buster® Punch	-	-	X	X
				35159	ISO-40 Knockout Die	-	-	X	X
-	1.850	47.0	Pg-36	721E-47.0	Pg-36 Slug-Buster® Punch	-	X	-	-
				32009	Pg-36 Knockout Die	-	X	-	-
2	2.000	50.8	ISO-50	35160	ISO-50 Slug-Buster® Punch	-	-	-	X
				35161	ISO-50 Knockout Die	-	-	-	X
-	2.362	60.0	Pg-48	721E-60.0	Pg-48 Slug-Buster® Punch	-	X	-	-
				32011	Pg-48 Knockout Die	-	X	-	-
2-1/2	2.520	64.0	ISO-63	35167G	ISO-63 Slug-Buster® Punch	-	-	-	X
				35166	ISO-63 Knockout Die	-	-	-	X
				00042	Ball-Bearing Drive Nut with 1" Hex Head – 3/8" x 3"	X	X	X	X
				249AVBB	Draw Stud – 3/4" x 2-1/8"	-	-	X	-
				304AVBB	Draw Stud – 3/4" x 2-15/16"	-	X	-	X
				KRW-1	1" Ratchet Wrench	X	X	X	X
				KCC-RWM	Case for Metric Ratchet Wrench Kits	X	X	X	X

SLUG-BUSTER® SETS AND PARTS

CONDUIT SIZE	HOLE SIZE			CAPACITY MILD STEEL		CAT. NO.				
	ACTUAL		PG/ISO	ga	mm	SET	PUNCH	DIE	MANUAL DS	
	IN	mm								
-	0.492	-	12.5	-	16	1.5	06727	06728	06729	1675AV
-	0.598	-	15.2	Pg 9	14	2.0	7211EBB-15.2	721E-15.2	32002	00042
-	0.638	-	16.2	ISO-16	14	2.0	35177	35163	35162G	00042
-	0.732	-	18.6	Pg 11	14	2.0	7211EBB-18.6	721E-18.6	32003	00042
-	0.750	3/4"	19.1	-	14	2.0	12307	12306	12305	00042
-	0.803	-	20.4	Pg 13.5 / ISO-20	14	2.0	7211EBB-20.4	721E-20.4	32004	00042
1/2"	0.885	-	22.5	Pg 16	10	3.5	K2BB-1/2	K2P-1/2	KD-1/2	DSBB-7/16
-	0.937	15/16"	23.8	-	14	2.0	12338	12340	1761AV	00042
-	1.000	1"	25.4	ISO-25	14	2.0	35178	35165	35164	00042
-	1.063	1-1/16"	27.0	-	14	2.0	12341	12343	1764AV	00042
3/4"	1.115	-	28.3	Pg 21	10	3.5	K2BB-3/4	K2P-3/4	KD-3/4	DSBB-3/4
3/4"	1.115	-	28.3	Pg 21	14	2.0	7211EBB-28.3	721E-28.3	32006	00042
-	1.219	1-7/32"	30.5	-	10	3.5	K2BBM-0305	K2PM-0305	KDM-0305	DSBB-3/4
-	1.219	1-7/32"	30.5	-	14	2.0	36508	36284	36279	00042
-	1.250	1-1/4"	31.8	-	16	1.5	12308	12309	12310	00042
-	1.280	-	32.5	ISO-32	10	3.5	35179	35169	35168	249AVBB
1"	1.362	-	34.6	-	10	3.5	K2BB-1	K2P-1	KD-1	DSBB-3/4
-	1.457	-	37.0	Pg 29	10	3.5	7211EBB-37	721E-37.0	32008	249AVBB
-	1.500	1-1/2"	38.1	-	10	3.5	12313	12312	3208AV	249AVBB
-	1.595	-	40.5	ISO-40	10	3.5	35180G	35158	35159	249AVBB
-	1.625	1-5/8"	41.3	-	10	3.5	12347	12349	1793AV	249AVBB
1-1/4"	1.701	-	43.2	-	10	3.5	K2BB-1-1/4	K2P-1-1/4	KD-1-1/4	DSBB-3/4
-	1.750	1-3/4"	44.5	-	10	3.5	12316	12315	1815AV	249AVBB
-	1.850	-	47.0	Pg 36	10	3.5	7211EBB-47.0	721E-47.0	32009	304AVBB
-	1.875	1-7/8"	47.6	-	10	3.5	12350	12354	1792AV	304AVBB
1-1/2"	1.951	-	49.6	-	10	3.5	K2BB-1-1/2	K2P-1-1/2	KD-1-1/2	DSBB-3/4
-	2.000	2"	50.8	ISO-50	10	3.5	35181	35160	35161	304AVBB
-	2.125	2-1/8"	54.0	-	10	3.5	36171	36172	36173	304AVBB
-	2.250	2-1/4"	57.2	-	10	3.5	12351	12355	438AV	304AVBB
-	2.362	-	60.0	Pg 48	10	3.5	7211EBB-60.0	721E-60.0	32011	304AVBB
2"	2.416	-	61.4	-	10	3.5	K2BB-2	K2P-2	KD-2	DSBB-3/4
-	2.520	-	64.0	ISO-63	10	3.5	35182G	35167	35166	304AVBB

STANDARD ROUND SETS AND PARTS

CONDUIT SIZE	HOLE SIZE			CAPACITY MILD STEEL		CAT. NO.				
	ACTUAL		PG/ISO	ga	mm	SET	PUNCH	DIE	MANUAL DS	
	IN	mm								
-	0.500	1/2"	12.7	-	16	1.5	730-1/2	1760AV	1759AV	1675AV
-	0.563	9/16"	14.3	-	16	1.5	730-9/16	1754AV	1753AV	1675AV
-	0.598	-	15.2	Pg 9	14	2.0	21115	21316	32002	00042
-	0.625	5/8"	15.9	-	16	1.5	730-5/8	1742AV	1743AV	1675AV
-	0.638	-	16.2	ISO-16	14	2.0	35192G	35193	35162G	00042
-	0.688	11/16"	17.5	-	14	2.0	730BB-11/16	1752AV	1751AV	00042
-	0.732	-	18.6	Pg 11	14	2.0	730EBB-18.6	17700	32003	00042
-	0.750	3/4"	19.1	-	14	2.0	730BB-3/4	113AV	12305	00042
-	0.803	-	20.4	Pg 13.5 / ISO-20	14	2.0	730EBB-20.4	17697	32004	00042
-	0.812	13/16"	20.6	-	14	2.0	730BB-13/16	1745AV	1744AV	00042
1/2"	0.885	-	22.5	Pg 16	10	3.5	K3BB-1/2	K3P-1/2	KD-1/2	DSBB-7/16
-	0.937	15/16"	23.8	-	14	2.0	730BB-15/16	1762AV	1761AV	00042
-	1.000	1"	25.4	ISO-25	14	2.0	730BB-1	87AV	35164	00042
-	1.063	1-1/16"	27.0	-	14	2.0	730BB-1-1/16	1763AV	1764AV	00042
3/4"	1.115	-	28.3	Pg 21	10	3.5	K3BB-3/4	K3P-3/4	KD-3/4	DSBB-3/4
3/4"	1.115	-	28.3	Pg 21	14	2.0	36910	36882	32006	00042
-	1.125	1-1/8"	28.6	-	14	2.0	730BB-1-1/8	91AV	92AV	00042
-	1.219	1-7/32"	30.5	-	16	1.5	36506	36282	36279	00042
-	1.250	1-1/4"	31.8	-	16	1.5	730BB-1-1/4	117AV	12310	00042
-	1.280	-	32.5	ISO-32	10	3.5	24476	24459	35168	249AVBB
-	1.313	1-5/16"	33.4	-	16	1.5	730BB-1-5/16	1747AV	1746AV	00042
1"	1.362	-	34.6	-	10	3.5	K3BB-1	K3P-1	KD-1	DSBB-3/4
-	1.375	1-3/8"	34.9	-	10	3.5	730BB-1-3/8	3205AV	3206AV	249AVBB
-	1.457	-	37.0	Pg 29	10	3.5	730EBB-37	18331	32008	249AVBB
-	1.500	1-1/2"	38.1	-	10	3.5	730BB-1-1/2	3207AV	3208AV	249AVBB
-	1.595	-	40.5	ISO-40	10	3.5	24477	24462	35159	249AVBB
-	1.625	1-5/8"	41.3	-	10	3.5	730BB-1-5/8	1794AV	1793AV	249AVBB
1-1/4"	1.701	-	43.2	-	10	3.5	K3BB-1-1/4	K3P-1-1/4	KD-1-1/4	DSBB-3/4
-	1.750	1-3/4"	44.5	-	10	3.5	730BB-1-3/4	1816AV	1815AV	249AVBB
-	1.850	-	47.0	Pg 36	10	3.5	730EBB-47.0	17687	32009	304AVBB
-	1.875	1-7/8"	47.6	-	10	3.5	730BB-1-7/8	1791AV	1792AV	304AVBB
1-1/2"	1.951	-	49.6	-	10	3.5	K3BB-1-1/2	K3P-1-1/2	KD-1-1/2	DSBB-3/4
-	2.000	2"	50.8	ISO-50	10	3.5	730BB-2	1756AV	35161	304AVBB
-	2.125	2-1/8"	54.0	-	10	3.5	730BB-2-1/8	1783AV	36173	304AVBB
-	2.250	2-1/4"	57.2	-	10	3.5	730BB-2-1/4	437AV	438AV	304AVBB
-	2.362	-	60.0	Pg 48	10	3.5	730EBB-60.0	17690	32011	304AVBB
2"	2.416	-	61.4	-	10	3.5	K3BB-2	K3P-2	KD-2	DSBB-3/4
-	2.500	2-1/2"	63.5	-	10	3.5	730BB-2-1/2	1758AV	1757AV	304AVBB
-	2.520	-	64.0	ISO-63	-	-	-	-	-	304AVBB

STANDARD ROUND SETS AND PARTS (CONT'D)

CONDUIT SIZE	HOLE SIZE			CAPACITY MILD STEEL		CAT. NO.						
	ACTUAL		PG/ISO	ga	mm	SET	PUNCH	DIE	MANUAL DS	BB NUT	BUSHING	
	SIZE	mm										
-	2.625	2-5/8"	66.7	-	10	3.5	730PBB-2-5/8	1795AV	1796AV	1434AV	1433AVBB	-
-	2.750	2-3/4"	69.9	-	10	3.5	730BB-2-3/4	1790AV	1789AV	1434AV	1433AVBB	-
-	2.781	-	70.6	-	10	3.5	730MBB	730101A	730100A	1434AV	1433AVBB	-
2-1/2"	2.914	-	74.0	-	10	3.5	K3BB-2-1/2	K3P-2-1/2	KD-2-1/2	DSBB-1-1/8	3036AVBB	-
-	3.000	3"	76.2	-	10	3.5	730BB-3	1821AV	1820AV	1434AV	1433AVBB	-
-	3.125	3-1/8"	79.4	-	10	3.5	730TBB	1798AV	1797AV	1434AV	1433AVBB	-
-	3.228	-	82.0	-	10	3.5	730EBB-82	18905	18906	1434AV	1433AVBB	-
3"	3.539	-	89.9	-	10	3.5	K3BB-3	K3P-3	KD-3	DSBB-1-1/8	3036AVBB	-
-	3.750	3-3/4"	95.3	-	10	3.5	730PBB-3-3/4	4640AV	4641AV	1434AV	1433AVBB	3037AV
3-1/2"	4.011	-	102.7	-	10	3.5	K3BB-3-1/2	K3P-3-1/2	KD-3-1/2	DSBB-1-1/8	3036AVBB	3037AV
4"	4.544	-	115.4	-	10	3.5	K3BB-4	K3P-4	KD-4	DSBB-1-1/8	3036AVBB	3037AV
-	4.724	-	120.0	-	10	3.5	730EBB-120	21489	21491	DSBB-1-1/8	3036AVBB	3037AV
5"	5.675	-	144.1	-	10	3.5	743BB	5135AV	5136AV	DSBB-1-1/8	3036AVBB	3037AV
6"	6.375	-	161.9	-	10	3.5	744BB	5137AV	5138AV	DSBB-1-1/8	3036AVBB	3037AV

REPLACEMENT THREADED DRAW STUDS FOR HYDRAULIC DRIVERS

Use with LS100X, LS50L2, 746A Ram

3/8"-24 x 4-13/16"



20963 / 783310209638

7/16"-20 x 5"



 DSH-7/16 / 783310090632

3/4"-16 x 5-5/8"



 DSH-3/4 / 783310090663

1 1/8"-12 x 6"



 DSH-1-1/8 / 783310090670

Use with Quick Draw®, LS50L

3/4"-x 3/8"
internal



33967 / 783310339670

3/8"-24 x 2-13/16"



1614SS / 783310300434

7/16-20"-x 4-1/4"



 DSH-S7/16 / 783310090649

3/4"-16 x 4-13/16"



 DSH-S3/4 / 783310090656

REPLACEMENT DRAW STUDS FOR MANUAL USE

• For proper size selection, see page 71 – 73

3/8"-24 x 1-3/4"



00042 / 783310000426

1/4"-28 x 1-1/2"



1675AV / 783310042181

7/16"-20 x 3"

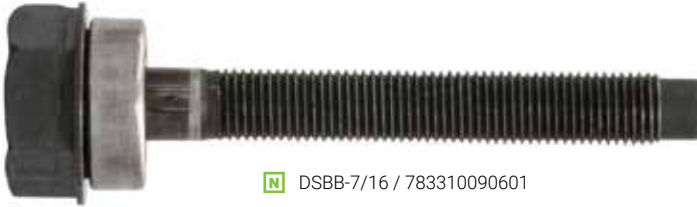

N DSBB-7/16 / 783310090601

3/4"-16 x 3-3/8"



N DSBB-3/4 / 783310090625

3/4"-16 x 2-1/8"



249AVBB / 783310040408

3/4"-16 x 2-15/16"



304AVBB / 783310040422

Use with KRW-1

REPLACEMENT DRAW STUDS FOR MANUAL USE

• For proper size selection, see page 73



1433AVBB / 783310041870
1"-12 UNF, 1-1/2" hex



1434AV / 783310041870
3/4" -15 x 5-3/8"



 DSBB-1-1/8 / 783310090687
1-1/8"-16 x 8-3/8"



3036AVBB / 783310046851
1-3/8"-12, 2" hex



3037AV / 783310046868
1.125" x 1.87"

HYDRAULIC C-FRAME KITS



1731

- Fast, one-shot punching – eliminates need for pilot hole
- Throat measures 8" (203 mm) deep
- Punch up to 10 ga mild steel

1731 HYDRAULIC C-FRAME KITS

- Great for punching junction boxes and small enclosures
- Punch can be used with ram inside or outside of the junction box
- For use with 1/2" – 1" conduit size and accessory sizes only

1732 HYDRAULIC C-FRAME KIT

- Use with Greenlee 1/2" – 4" conduit size standard round punches and dies only

HYDRAULIC C-FRAME KITS

CAT. NO.	UPC NO.	DESCRIPTION
1731	783310159117	Hydraulic C-Frame Kit
1731H767	783310204862	Hydraulic C-Frame Kit with Hand Pump
1732	783310273615	Hydraulic C-Frame Kit with Hand Pump



1732

CAT. NO.	DESCRIPTION	1731	1731H767	1732
12079	C-Frame (1731)	X	X	-
11903	C-Frame (1732)	-	-	X
15631	Ram (1731)	X	X	-
13577	Ram (1732)	-	-	X
06301	Hydraulic Hose – 1/4" x 3'	-	X	-
767	Hydraulic Hand Pump	-	X	-
13266	Punch Adapter – 3/8"	X	X	X
13267	Punch Adapter – 3/4"	X	X	X
13268	Punch Adapter – 1-1/8"	-	-	X
13261	Pilot Pin 1/2"	X	X	X
13262	Pilot Pin 3/4"	X	X	X
11791	Die Adapter – 3/4" x 3/8"	-	-	X
11790	Die Adapter – 3/4" x 3/4"	-	-	X
11789	Die Adapter – 3/4" x 1-7/8"	-	-	X
121AV	1/2" Conduit Size Standard Round Punch	X	X	-
12087	1/2" Conduit Size C-Frame Knockout Die	X	X	-
K3P-3/4	3/4" Conduit Size Standard Round Punch	X	X	-
12086	3/4" Conduit Size C-Frame Knockout Die	X	X	-
K3P-1	1" Conduit Size Standard Round Punch	X	X	-
12085	1" Conduit Size C-Frame Knockout Die	X	X	-
07714	Carrying Case	X	X	-
27335	Carrying Case	-	-	X

BATTERY-HYDRAULIC KITS WITH SLUG SPLITTER® PUNCHES



- Slug Splitter® punches are the best solution for frequent usage in stainless steel
- Premium-grade tool steel for longer life in stainless steel
- Over 11 tons of punching force
- Punch 4" conduit up to 10 ga stainless and mild steel

LS100X INTELLI-PUNCH™ 11-TON BATTERY-HYDRAULIC KNOCKOUT KITS

CAT NO.	UPC NO.	DESCRIPTION
LS100X11SS4	783310064879	Slug Splitter® 1/2" to 4" Conduit
LS100X11SS4X	783310064886	Slug Splitter® 1/2" to 3" and 4" Conduit
LS100X11SS	783310064862	Slug Splitter® 1/2" to 2" Conduit



LARGE DIAMETER KNOCKOUT EXPANSION SET

CAT NO.	UPC NO.	DESCRIPTION
7308	783310006176	Stainless Steel 2-1/2", 3", 3-1/2" and 4" Conduit

PARTS LIST

CONDUIT SIZE	HOLE SIZE			CAT. NO.	DESCRIPTION	LS100X1SS4	LS100X1SS4X	LS100X1SS
	ACTUAL		mm					
	IN							
1/2"	7/8"	0.885	22.5	28154	1/2" Slug Splitter® Punch	X	X	X
				28155	1/2" Knockout Die	X	X	X
3/4"	-	1.115	28.3	28156	3/4" Slug Splitter® Punch	X	X	X
				28157	3/4" Knockout Die	X	X	X
1"	-	1.362	34.6	28158	1" Slug Splitter® Punch	X	X	X
				28159	1" Knockout Die	X	X	X
1-1/4"	1-11/16"	1.701	43.2	28160	1-1/4" Slug Splitter® Punch	X	X	X
				28161	1-1/4" Knockout Die	X	X	X
1-1/2"	1-15/16"	1.951	49.6	28162	1-1/2" Slug Splitter® Punch	X	X	X
				28163	1-1/2" Knockout Die	X	X	X
2"	2-3/8"	2.416	61.5	28164	2" Slug Splitter® Punch	X	X	X
				28165	2" Knockout Die	X	X	X
2-1/2"	2-7/8"	2.914	74.0	00622	2-1/2" Stainless Steel Punch	X	X	-
				00626	2-1/2" Knockout Die	X	X	-
3"	3-1/2"	3.539	89.9	00623	3" Stainless Steel Punch	X	X	-
				00627	3" Knockout Die	X	X	-
3-1/2"	4"	4.011	102.7	00624	3-1/2" Stainless Steel Punch	X	-	-
				00629	3-1/2" Knockout Die	X	-	-
4"	4-1/2"	4.544	115.4	00625	4" Stainless Steel Punch	X	X	-
				00630	4" Knockout Die	X	X	-
				29451	7/16" x 4-1/4" Hydraulic Draw Stud	X	X	X
				29452	3/4" x 5-1/2" Hydraulic Draw Stud	X	X	X
				1557SS	Sleeve Adapter, SS	X	X	-
				15908	Spacer Group (Includes 1 of each of the following 3 items)	X	-	-
				1924AA	Spacer-Short	X	-	-
				1925AA	Spacer-Medium	X	-	-
				1926AA	Spacer-Long	X	X	-
				LS100X	LS100X Intelli-PUNCH™ 11-Ton Battery-Hydraulic Driver	X	X	X
				52189	18V Li-ion 3.0Ah Battery	2	2	2
				52186	120V AC Charger	X	X	X
				LS100XCC	Case for Battery-Hydraulic Kits	X	X	X

MANUAL-HYDRAULIC RAM AND PUMP KITS WITH SLUG SPLITTER® PUNCHES



7506

SLUG SPLITTERS

- Slug Splitter® punches are the best solution for frequent usage in stainless steel
- Premium-grade tool steel for longer life in stainless steel
- Unique punch profile splits slugs for easy slug removal
- 1/2" – 2" conduit size punches feature a self-centering design – aligns itself on pilot hole - no need to draw crosshairs
- 11 tons of punching force
- Punch 4" conduit up to 10 ga stainless and mild steel

11-TON HYDRAULIC KNOCKOUT KITS WITH HAND PUMP

CAT NO.	UPC NO.	DESCRIPTION
7506	783310303855	Slug Splitter® 1/2" to 2" Conduit



744
(driver not included)

KNOCKOUT SETS

CAT NO.	UPC NO.	DESCRIPTION
744	783310296195	Slug Splitter® 1/2" to 1-1/4" Conduit
7307	783310295280	Slug Splitter® 1/2" to 2" Conduit, 30.5 mm
7308	783310006176	Stainless Steel 2-1/2", 3", 3-1/2" and 4" Conduit



7307
(driver not included)



7308
(driver not included)

PARTS LIST

CONDUIT SIZE	HOLE SIZE		CAT. NO.	DESCRIPTION	7506	744	7307	7308	
	ACTUAL								
	IN	mm							
1/2"	7/8"	0.885	22.5	28154	1/2" Slug Splitter® Punch	X	X	X	-
				28155	1/2" Knockout Die	X	X	X	-
3/4"	-	1.115	28.3	28156	3/4" Slug Splitter® Punch	X	X	X	-
				28157	3/4" Knockout Die	X	X	X	-
-	1/7/32"	1.219	30.5	36490	30.5 mm Slug Splitter® Punch	-	-	X	-
				36489	30.5 mm Knockout Die	-	-	X	-
1"	-	1.362	34.6	28158	1" Slug Splitter® Punch	X	X	X	-
				28159	1" Knockout Die	X	X	X	-
1-1/4"	1-11/16"	1.701	43.2	28160	1-1/4" Slug Splitter® Punch	X	X	X	-
				28161	1-1/4" Knockout Die	X	X	X	-
1-1/2"	1-15/16"	1.951	49.6	28162	1-1/2" Slug Splitter® Punch	X	-	X	-
				28163	1-1/2" Knockout Die	X	-	X	-
2"	2-3/8"	2.416	61.5	28164	2" Slug Splitter® Punch	X	-	X	-
				28165	2" Knockout Die	X	-	X	-
2-1/2"	2-7/8"	2.914	74.0	00622	2-1/2" Stainless Steel Punch	-	-	-	X
				00626	2-1/2" Knockout Die	-	-	-	X
3"	3-1/2"	3.539	89.9	00623	3" Stainless Steel Punch	-	-	-	X
				00627	3" Knockout Die	-	-	-	X
3-1/2"	4"	4.011	102.7	00624	3-1/2" Stainless Steel Punch	-	-	-	X
				00629	3-1/2" Knockout Die	-	-	-	X
4"	4-1/2"	4.544	115.4	00625	4" Stainless Steel Punch	-	-	-	X
				00630	4" Knockout Die	-	-	-	X
				29451	7/16" x 4-1/4" Hydraulic Draw Stud	X	X	X	-
				29452	3/4" x 5-1/2" Hydraulic Draw Stud	X	X	X	X
				1557SS	Sleeve Adapter, SS	-	-	-	X
				15908	Spacer Group (includes 1 of ea. - 1924AA, 1925AA, 1926AA)	X	-	-	-
				746A	Ram	X	-	-	-
				767	Hydraulic Hand Pump	X	-	-	-
				06302	High Pressure Hose - 1/4" X 3"	X	-	-	-
				29529	Metal Case (7307)	-	-	X	-
				19193	Metal Case (744)	-	X	-	-
				31068	Metal Case (7506)	X	-	-	-
				08659	Metal Case (7308)	-	-	-	X

SLUG SPLITTER® SETS AND PARTS



745H-2-1/2

- Slug Splitter® punches are the best solution for frequent usage in stainless steel
- Premium-grade tool steel for longer life in stainless steel
- Unique punch profile splits slugs for easy slug removal
- Heavy-duty dies and stainless steel draw studs for longer life
- Patent Pending self-centering punch aligns itself on pilot hole – no need to draw crosshairs or line up die alignment marks

CONDUIT SIZE	HOLE SIZE			CAPACITY		CAT NO.				
	ACTUAL					ga	mm	SET	PUNCH	DIE
	IN	mm	PG/ISO							
-	0.638	16.2	ISO-16	12	2.5	745M-16.2	04599	04598	29451	-
-	0.732	18.6	Pg 11	12	2.5	-	31119	31128	29451	-
-	0.803	20.4	ISO-20	12	2.5	745M-20.4	31120G	31129	29451	-
1/2"	0.885	22.5	Pg 16	10	3.5	745H-1/2 *	28154 *	28155	29451	-
-	1.000	25.4	ISO-25	10	3.5	745M-25.4	04602	04601	29451	-
3/4"	1.115	28.3	Pg 21	10	3.5	745H-3/4 *	28156 *	28157	29452	-
-	1.219	30.5	-	10	3.5	740H-1-7/32 *	36490 *	36489	29452	-
-	1.280	32.5	ISO-32	10	3.5	745M-32.5	04605	04603	29452	-
1"	1.362	34.6	-	10	3.5	745H-1 *	28158 *	28159	29452	-
-	1.457	37.0	Pg 29	10	3.5	-	31122	31135	29452	-
-	1.595	40.5	ISO-40	10	3.5	745M-40.5	04608	04607	29452	-
1-1/4"	1.701	43.2	-	10	3.5	745H-1-1/4 *	28160 *	28161	29452	-
-	1.850	47.0	Pg 36	10	3.5	-	31123	31131	29452	-
1-1/2"	1.951	49.6	-	10	3.5	745H-1-1/2 *	28162 *	28163	29452	-
-	2.000	50.8	ISO-50	10	3.5	745M-50.8	04611	04609	29452	-
-	2.125	54.0	-	10	3.5	-	31124	31132	29452	-
-	2.362	60.0	Pg 48	10	3.5	-	31125G	31133	29452	-
2"	2.416	61.5	-	10	3.5	745H-2 *	28165 *	28166	29452	-
-	2.520	64.0	ISO-63	10	3.5	745M-64	04614	04613	29452	-
2-1/2"	2.914	74.0	-	10	3.5	745H-2-1/2	00622	00626	29452	-
3"	3.539	89.9	-	10	3.5	745H-3	00623	00627	29452	-
3-1/2"	4.011	102.7	-	10	3.5	745H-3-1/2	00624	00629	29452	1557SS
4"	4.544	115.4	-	10	3.5	745H-4	00625	00630	29452	1557SS

*Self-Centering Punch Design

REPLACEMENT THREADED DRAW STUDS FOR HYDRAULIC DRIVERS – STAINLESS STEEL

- For proper size selection, see page 82

Use with LS100X, LS50L2, 746A Ram

7/16"-20 x 4-1/4"



29451 / 783310294511

3/4"-16 x 5-1/2"



29452 / 783310294528

1-1/8"-12 x 2.64"



1557SS / 783310007852

BATTERY-HYDRAULIC KITS WITH SLUG BUSTER® SPEED PUNCH® PUNCHES

- Available in 1/2" to 4" conduit sizes
- Punch up to 10 ga mild steel
- Knockouts Made in the USA



LS100X11SBSP4X

LS100X INTELLI-PUNCH™ 11-TON BATTERY-HYDRAULIC KNOCKOUT KITS

CAT NO.	UPC NO.	DESCRIPTION
LS100X11SBSP4	783310064954	SPEED PUNCH® 1/2" to 4" Conduit
LS100X11SBSP4X	783310064961	SPEED PUNCH® 1/2" to 3" and 4" Conduit
LS100X11SBSP	783310064893	SPEED PUNCH® 1/2" to 2" Conduit

LS50L2 7-TON BATTERY-HYDRAULIC KNOCKOUT KITS

CAT NO.	UPC NO.	DESCRIPTION
LS50L11SBSP	783310022572	SPEED PUNCH® 1/2" to 2" Conduit

PARTS LIST

CONDUIT SIZE	HOLE SIZE		CAT. NO.	DESCRIPTION	LS100X11SBSP4	LS100X11SBSP4	LS100X11SBSP	LS50L11SBSP	
	ACTUAL								
	IN	mm							
1/2"	7/8"	0.885	22.5	7212SP-1/2P	1/2" SPEED PUNCH® Punch	X	X	X	X
				7212SP-1/2D	1/2" SPEED PUNCH® Die	X	X	X	X
3/4"	-	1.115	28.3	7212SP-3/4P	3/4" SPEED PUNCH® Punch	X	X	X	X
				7212SP-3/4D	3/4" SPEED PUNCH® Die	X	X	X	X
1"	-	1.362	34.6	7212SP-1P	1" SPEED PUNCH® Punch	X	X	X	X
				7212SP-1D	1" SPEED PUNCH® Die	X	X	X	X
1-1/4"	1-11/16"	1.701	43.2	7212SP-1-1/4P	1-1/4" SPEED PUNCH® Punch	X	X	X	X
				7212SP-1-1/4D	1-1/4" SPEED PUNCH® Die	X	X	X	X
1-1/2"	1-15/16"	1.951	49.6	7212SP-1-1/2P	1-1/2" SPEED PUNCH® Punch	X	X	X	X
				7212SP-1-1/2D	1-1/2" SPEED PUNCH® Die	X	X	X	X
2"	2-3/8"	2.416	61.5	7212SP-2P	2" SPEED PUNCH® Punch	X	X	X	X
				7212SP-2D	2" SPEED PUNCH® Die	X	X	X	X
2-1/2"	2-7/8"	2.914	74.0	7212SP-2-1/2P	2-1/2" SPEED PUNCH® Punch	X	X	-	-
				7212SP-2-1/2D	2-1/2" SPEED PUNCH® Die	X	X	-	-
3"	3-1/2"	3.539	89.9	7212SP-3P	3" SPEED PUNCH® Punch	X	X	-	-
				7212SP-3D	3" SPEED PUNCH® Die	X	X	-	-
3-1/2"	4"	4.011	102.7	7212SP-3-1/2P	3-1/2" SPEED PUNCH® Punch	X	-	-	-
				7212SP-3-1/2D	3-1/2" SPEED PUNCH® Die	X	-	-	-
4"	4-1/2"	4.544	115.4	7212SP-4P	4" SPEED PUNCH® Punch	X	X	-	-
				7212SP-4D	4" SPEED PUNCH® Die	X	X	-	-
				7212SP12	SPEED PUNCH® Draw Stud 3/4" x 5.64"	X	X	X	X
				7212SP13	SPEED PUNCH® Draw Stud 3/8" x 4.70"	X	X	X	X
				SP-LOCK	Speed Lock, 3/4"	X	X	X	X
				SP-LOCK2	Speed Lock, 3/8"	X	X	X	X
				7212AA2	Sleeve Adapter, LS Tools	2	2	-	-
				34403	Step Bit, 7/8"	X	X	X	X
				LS100X	LS100X Intelli-PUNCH™ 11-Ton Battery-Hydraulic Driver	X	X	X	-
				LS50L2	7-Ton Battery-Hydraulic Knockout Driver	-	-	-	X
				52189	18V 3.0Ah Li-ion Battery	2	2	2	-
				52190	18V 2.0Ah Li-ion Battery	-	-	-	X
				52186	120V Charger	X	X	X	X
				LS100XCC	Case for LS100X Kits	X	X	X	-
				KK50LFLEX	Case for LS50L2 Kits	-	-	-	X

MANUAL-HYDRAULIC KITS WITH SLUG-BUSTER® SPEED PUNCH® PUNCHES



7310SBSP

- 11 tons of punching force
- Time Saver – punches 10 times faster than wrench method
- Compact, lightweight design for easy portability and fast, one-person operation
- Punch 4" conduit up to 10 ga mild steel and 12 ga stainless steel
- Also punches brass, copper, aluminum, fiberglass and plastics

SPEED PUNCH® 11-TON HYDRAULIC KNOCKOUT KITS WITH HAND PUMP

CAT NO.	UPC NO.	DESCRIPTION
7310SBSP	783310017165	SPEED PUNCH® 1/2" to 4" Conduit
7304SP	783310017158	SPEED PUNCH® 2-1/2" to 4" Conduit



7908SBSP

QUICK DRAW 90® 8-TON HYDRAULIC KNOCKOUT KIT

CAT NO.	UPC NO.	DESCRIPTION
7908SBSP	783310022589	SPEED PUNCH® 1/2" to 2" Conduit

PARTS LIST

CONDUIT SIZE	HOLE SIZE			CAT. NO.	DESCRIPTION	7310SBSP	7904SP	7908SBSP
	ACTUAL		mm					
	IN							
1/2"	7/8"	0.885	22.5	7212SP-1/2P	1/2" SPEED PUNCH® Punch	X	-	X
				7212SP-1/2D	1/2" SPEED PUNCH® Die	X	-	X
3/4"	-	1.115	28.3	7212SP-3/4P	3/4" SPEED PUNCH® Punch	X	-	X
				7212SP-3/4D	3/4" SPEED PUNCH® Die	X	-	X
1"	-	1.362	34.6	7212SP-1P	1" SPEED PUNCH® Punch	X	-	X
				7212SP-1D	1" SPEED PUNCH® Die	X	-	X
1-1/4"	1-11/16"	1.701	43.2	7212SP-1-1/4P	1-1/4" SPEED PUNCH® Punch	X	-	X
				7212SP-1-1/4D	1-1/4" SPEED PUNCH® Die	X	-	X
1-1/2"	1-15/16"	1.951	49.6	7212SP-1-1/2P	1-1/2" SPEED PUNCH® Punch	X	-	X
				7212SP-1-1/2D	1-1/2" SPEED PUNCH® Die	X	-	X
2"	2-3/8"	2.416	61.5	7212SP-2P	2" SPEED PUNCH® Punch	X	-	X
				7212SP-2D	2" SPEED PUNCH® Die	X	-	X
2-1/2"	2-7/8"	2.914	74.0	7212SP-2-1/2P	2-1/2" SPEED PUNCH® Punch	X	X	-
				7212SP-2-1/2D	2-1/2" SPEED PUNCH® Die	X	X	-
3"	3-1/2"	3.539	89.9	7212SP-3P	3" SPEED PUNCH® Punch	X	X	-
				7212SP-3D	3" SPEED PUNCH® Die	X	X	-
3-1/2"	4"	4.011	102.7	7212SP-3-1/2P	3-1/2" SPEED PUNCH® Punch	X	X	-
				7212SP-3-1/2D	3-1/2" SPEED PUNCH® Die	X	X	-
4"	4-1/2"	4.544	115.4	7212SP-4P	4" SPEED PUNCH® Punch	X	X	-
				7212SP-4D	4" SPEED PUNCH® Die	X	X	-
				7212SP11	SPEED PUNCH® Draw Stud 3/4" x 4.77"	-	-	X
				7212SP12	SPEED PUNCH® Draw Stud 3/4" x 5.64"	X	X	-
				7212SP13	SPEED PUNCH® Draw Stud 3/8" x 4.70"	X	-	-
				7212SP14	SPEED PUNCH® Draw Stud 3/8" x 3.83"	-	-	X
				SP-LOCK	Speed Lock, 3/4"	X	X	X
				SP-LOCK2	Speed Lock, 3/8"	X	-	X
				7212AA1	Sleeve Adapter, 746A	2	2	-
				7212AA2	Sleeve Adapter, LS Tools	-	2	-
				34403	Step Bit, 7/8"	X	X	X
				746A	Hydraulic Ram	X	-	-
				06302	High Pressure Hose - 1/4" x 3'	X	-	-
				767	Hydraulic Hand Pump	X	-	-
				33786G	Quick Draw 90° Driver	-	-	X
				05387	Case for 7310 Sets	X	-	-
				02868	Case (7908SBSP)	-	-	X

SLUG SPLITTER® SPEED PUNCH® KITS AND SETS

- Punch up to 10 ga stainless and mild steel
- Use with hydraulic knockout drivers

SLUG SPLITTER® SPEED PUNCH® KITS AND SETS

CAT NO.	UPC NO.	DESCRIPTION
LS100X11SSSP	783310064978	SPEED PUNCH®, Stainless Steel, 1/2" to 2" Conduit
7307SP	783310017202	SPEED PUNCH® Set, Stainless Steel, 1/2" to 2" Conduit



PARTS LIST

CONDUIT SIZE	HOLE SIZE			CAT. NO.	DESCRIPTION	LS100X11SSP	7307SP
	ACTUAL						
	IN		mm				
1/2"	7/8"	0.885	22.5	745SP-1/2P	1/2" SPEED PUNCH®, SS Punch	X	X
				745SP-1/2D	1/2" SPEED PUNCH®, SS Die	X	X
3/4"	-	1.115	28.3	745SP-3/4P	3/4" SPEED PUNCH®, SS Punch	X	X
				745SP-3/4D	3/4" SPEED PUNCH®, SS Die	X	X
1"	-	1.362	34.6	745SP-1P	1" SPEED PUNCH®, SS Punch	X	X
				745SP-1D	1" SPEED PUNCH®, SS Die	X	X
1-1/4"	1-11/16"	1.701	43.2	745SP-1-1/4P	1-1/4" SPEED PUNCH®, SS Punch	X	X
				745SP-1-1/4D	1-1/4" SPEED PUNCH®, SS Die	X	X
1-1/2"	1-15/16"	1.951	49.6	745SP-1-1/2P	1-1/2" SPEED PUNCH®, SS Punch	X	X
				745SP-1-1/2D	1-1/2" SPEED PUNCH®, SS Die	X	X
2"	2-3/8"	2.416	61.5	745SP-2P	2" SPEED PUNCH®, SS Punch	X	X
				745SP-2D	2" SPEED PUNCH®, SS Die	X	X
				7212SP22	SPEED PUNCH® Draw Stud 3/4" x 4.77"	X	X
				7212SP21	SPEED PUNCH® Draw Stud 3/4" x 5.83"	X	X
				SP-LOCK	Speed Lock, 3/4"	X	X
				SP-LOCK2	Speed Lock, 3/8"	X	X
				LS100X	LS100X Intelli-PUNCH™ Battery-Hydraulic Driver	X	-
				52189	18V 3.0Ah Li-ion Battery	2	-
				52186	120V Charger	X	-
				LS100XCC	Case for Battery-Hydraulic Kits	X	-
				02868	Case (7307SP)	-	X

SPEED PUNCH® PARTS

CONDUIT SIZE	HOLE SIZE				CAT. NO.			
	IN		mm	PG/ISO	MILD STEEL		STAINLESS STEEL	
					PUNCH	DIE	PUNCH	DIE
-	0.638	-	16.2	ISO-16	7212SP-M16P	7212SP-M16D	-	-
-	0.803	-	20.4	Pg 13.5 / ISO-20	7212SP-M20P	7212SP-M20D	-	-
1/2"	0.885	-	22.5	Pg 16	7212SP-1/2P	7212SP-1/2D	745SP-1/2P	745SP-1/2D
-	1.000	1"	25.4	ISO-25	7212SP-M25P	7212SP-M25D	-	-
3/4"	1.115	-	28.3	Pg 21	7212SP-3/4P	7212SP-3/4D	745SP-3/4P	745SP-3/4D
-	1.219	1-7/32"	30.5	-	7212SP-1-7/32P	7212SP-1-7/32D	745SP-1-7/32P	745SP-1-7/32D
-	1.280	-	32.5	ISO-32	7212SP-M32P	7212SP-M32D	-	-
1"	1.362	-	34.6	-	7212SP-1P	7212SP-1D	745SP-1P	745SP-1D
-	1.595	-	40.5	ISO-40	7212SP-M40P	7212SP-M40D	-	-
1-1/4"	1.701	-	43.2	-	7212SP-1-1/4P	7212SP-1-1/4D	745SP-1-1/4P	745SP-1-1/4D
1-1/2"	1.951	-	49.6	-	7212SP-1-1/2P	7212SP-1-1/2D	745SP-1-1/2P	745SP-1-1/2D
-	2.000	2"	50.8	ISO-50	7212SP-M50P	7212SP-M50D	-	-
2"	2.416	-	61.4	-	7212SP-2P	7212SP-2D	745SP-2P	745SP-2D
2-1/2"	2.914	-	74.0	-	7212SP-2-1/2P	7212SP-2-1/2D	-	-
3"	3.539	-	89.9	-	7212SP-3P	7212SP-3D	-	-
3-1/2"	4.011	-	102.7	-	7212SP-3-1/2P	7212SP-3-1/2D	-	-
4"	4.544	-	115.4	-	7212SP-4P	7212SP-4D	-	-

REPLACEMENT SPEED PUNCH® DRAW STUDS

Use with LS100X, LS50L2, 746A Ram



Use with Quick Draw®, LS50L



SPECIAL APPLICATION PUNCHES

Oiltight Punches with Notches

Oiltight sizes also available without notches. Standard, Slug-Buster® and Slug Splitter® designs.

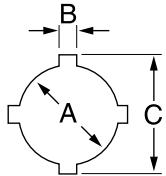

CAT./UPC NO

HOLE SIZE						MAXIMUM CAPACITY MILD STEEL		OPERATION TYPE	SET (INCLUDES PUNCH, DIE DRAW STUD AND NUTS)	PUNCH	DIE	DRAW STUD	BB DRIVE NUT	COUNTER NUT	MINIMUM PILOT HOLE		WEIGHT		OPTIONAL ADAPTER FOR HYDRAULIC DRIVERS
IN			mm			ga	mm								IN	mm	LB	KG	
.875	.125	1.000	22.5	3.2	25.4	14	2.0	Hand/Hydr.	60238	60239	60250	60117	60165	60258	.625	15.9	2.1	.95	601670
1.210	.190	1.380	30.5	4.8	36.0	10	3.5	Hand/Hydr.	60242	60243	60249	60117	60165	60258	.625	15.9	2.7	1.2	601670

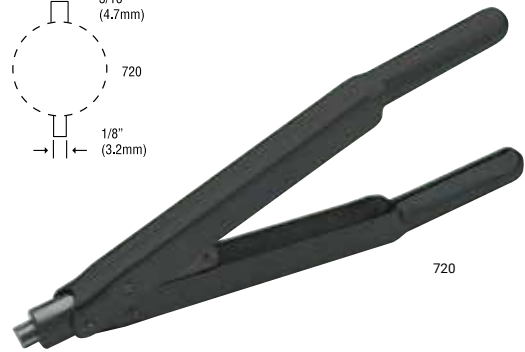
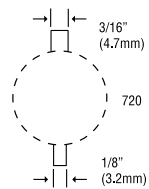

720 Keyway Punch

- Eliminates time-consuming hand sawing and filing when making keyways for push-button switches
- Use as a nibbler to make wider or deeper keyways in up to 10 ga mild steel
- Punches 1/8" (3.2 mm) or 3/16" (4.8 mm) keyways for 7/8" (22.5 mm) or 1-7/32" (30.5 mm) push-button holes

REPLACEMENT DRAW STUDS FOR RATCHET WRENCH

CAT NO.	UPC NO.	DESCRIPTION	WEIGHT	
			LB	KG
720	783310265344	Keyway Punch	2.8	1.27
R 26536	783310265368	Punch	-	-
R 26538	783310265382	Die	-	-

NOTE: Not for Stainless Steel

∅For use with any Greenlee Hydraulic Driver or Battery-Powered Driver

For maximum draw stud life, Greenlee recommends the use of battery or hydraulic drivers

**Sold as Unit only

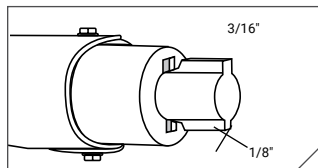

1. Locate proper cutting notch on the cutting head.

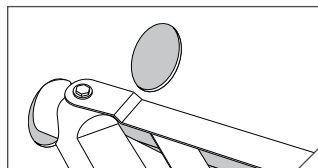

2. Place cutting notch inside edge of hole and cut keyway.

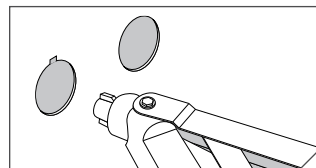

3. Withdraw the punch.

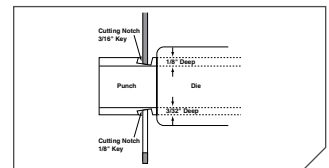

4. Use as a nibbler to make wider or deeper keyways.

Key Punches

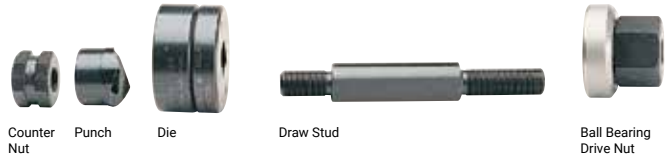
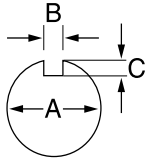

CAT. NO

HOLE SIZE						MAXIMUM CAPACITY MILD STEEL		OPERATION TYPE	SET (INCLUDES PUNCH, DIE DRAW STUD AND NUTS)	PUNCH	DIE	DRAW STUD	BB DRIVE NUT	COUNTER NUT	MINIMUM PILOT HOLE		WEIGHT		OPTIONAL ADAPTER FOR HYDRAULIC DRIVERS
IN			mm			ga	mm								IN	mm	LB	KG	
A	B	C	A	B	C														
0.481	0.055	.030	12.2	1.4	.8	16	1.5	Hand/Hydr.	60101	60102	60103	60115	60120	2046AV	.375	9.5	.88	.4	60114*
1.171	0.123	.097	29.7	3.1	2.5	14	2.0	Hand/Hydr.	60104	60105	60106	60166	60165	60258	.875	23.8	2.3	1.0	60167*
1.265	0.156	.097	32.1	4.0	2.5	14	2.0	Hand/Hydr.	60107	60108	60109	60166	60165	60258	.875	23.8	2.4	1.1	60167*
1.328	0.102	.097	33.7	2.6	2.5	14	2.0	Hand/Hydr.	60110	-	-	60166	60165	60258	.875	23.8	2.4	1.1	60167*

*For use with any Greenlee 746/746A Hydraulic Driver or Battery-Hydraulic Driver. For maximum draw stud life, Greenlee recommends the use of battery or hydraulic drivers

"D" Punches

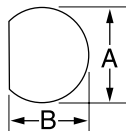

CAT. NO.

HOLE SIZE				MAXIMUM CAPACITY MILD STEEL		OPERATION TYPE	SET (INCLUDES PUNCH, DIE DRAW STUD AND NUTS)	PUNCH	DIE	DRAW STUD	BB DRIVE NUT	COUNTER NUT	MINIMUM PILOT HOLE		WEIGHT		OPTIONAL ADAPTER FOR HYDRAULIC DRIVERS
IN		mm		ga	mm								IN	mm	LB	KG	
A	B	A	B														
0.500	0.469	12.7	11.9	16	2.0	Hand/Hydr.	60077	60078	60079	60115	60120	2046AV	.375	9.5	.9	.41	60114◇
0.625	0.594	15.9	15.1	14	2.0	Hand/Hydr.	61080**	-	-	34421	34733G	2929AV	.500	12.7	1.1	.50	33967◇
0.750	0.703	19.1	19.1	14	2.0	Hand/Hydr.	61083**	-	-	34421	34733G	2929AV	.500	12.7	1.2	.50	33967◇

◇For use with any Greenlee Hydraulic Driver or Battery-Powered Driver
 For maximum draw stud life, Greenlee recommends the use of battery or hydraulic drivers
 **Sold as Unit only

Double "D" Punches

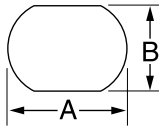

CAT. NO

HOLE SIZE				MAXIMUM CAPACITY MILD STEEL		OPERATION TYPE	SET (INCLUDES PUNCH, DIE DRAW STUD AND NUTS)	DRAW STUD	BB DRIVE NUT	COUNTER NUT	MINIMUM PILOT HOLE		WEIGHT		OPTIONAL ADAPTER FOR HYDRAULIC DRIVERS
IN		mm		ga	mm						IN	mm	LB	KG	
A	B	A	B												
0.769	0.642	19.5	16.3	14	2.0	Hand/Hydr.	61086**	34421	34733G	2929AV	.500	12.7	1.1	.50	339670
0.795	0.697	20.2	17.6	14	2.0	Hand/Hydr.	61089**	34421	34733G	2929AV	.500	12.7	1.1	.50	339670
0.913	0.756	23.2	19.2	14	2.0	Hand/Hydr.	61092**	34421	34733G	2929AV	.500	12.7	1.2	.54	339670
0.913	0.795	23.2	20.2	14	2.0	Hand/Hydr.	61095**	34421	34733G	2929AV	.500	12.7	2	.9	339670
1.375	1.125	34.9	28.6	14	2.0	Hand/Hydr.	60098**	60166	60165	60258	.875	23.8	2.5	1.1	601670

∅For use with any Greenlee Hydraulic Driver or Battery-Powered Driver
 For maximum draw stud life, Greenlee recommends the use of battery or hydraulic drivers
 **Sold as Unit only

Square and Special Square Punches

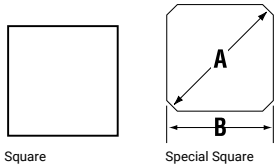

CAT. NO

HOLE SIZE				MAXIMUM CAPACITY MILD STEEL		OPERATION TYPE	SET (INCLUDES PUNCH, DIE DRAW STUD AND NUTS)	PUNCH	DIE	DRAW STUD	BB DRIVE NUT	COUNTER NUT	MINIMUM PILOT HOLE		WEIGHT		OPTIONAL ADAPTER FOR HYDRAULIC DRIVERS
IN		mm		ga	mm								IN	mm	LB	KG	
1/2"	0.500 x 0.500	12.7 x 12.7	16	1.5	∅Hand/Hydr.	60001	-	-	60115	60120	2046AV	.375	9.5	1.1	.50	601140	
5/8"	0.625 x 0.625	15.9 x 15.9	14	2.0	∅Hand/Hydr.	61004	-	-	34421	34733G	2929AV	.500	12.7	1.5	.68	339670	
3/4"	0.750 x 0.750	19.1 x 19.1	14	2.0	∅Hand/Hydr.	61007**	-	-	34421	34733G	2929AV	.500	12.7	1.5	.68	339670	
7/8"	0.882 x 0.882	22.4 x 22.4	14	2.0	∅Hand/Hydr.	61010**	-	-	34421	34733G	2929AV	.500	12.7	1.8	.82	339670	
-	0.945 x 0.945	24.0 x 24.0	14	2.0	∅Hand/Hydr.	61013**	-	-	34421	34733G	2929AV	.500	12.7	2.3	1.0	339670	
1"	1.000 x 1.000	25.4 x 25.4	14	2.0	∅Hand/Hydr.	60016	60017	60018	60117	60165	60258	.625	15.9	2.4	1.1	601670	
-	1.772 x 1.772	45.0 x 45.0	10	3.5	∅Hydr. Only	60287	60288	60289	60118	-	60235	1.188	30.2	6.0	2.7	∅	
1-13/16"	1.811 x 1.811	46.0 x 46.0	10	3.5	∅Hydr. Only	60019	60020	60021	60118	-	60235	1.188	30.2	6.2	2.8	∅	
2"	2.000 x 2.000	50.8 x 50.8	10	3.5	∅Hydr. Only	60168	60169	60170	60118	-	60235	1.188	30.2	6.9	3.1	∅	
2-11/16"	2.677 x 2.677	68.0 x 68.0	10	3.5	∅Hydr. Only	60171	60172	60173	60118	-	60235	1.188	30.2	10.1	4.6	∅	
3-5/8"	3.622 x 3.622	92.0 x 92.0	10	3.5	*Hydr. Only	60174	60175	60176	60118	-	60235	1.188	30.2	14.8	6.7	*	
4-1/8"	4.125 x 4.125	104.8 x 104.8	10	3.5	*Hydr. Only	60177	60178	60179	60118	-	60235	1.188	30.2	18.8	8.5	*	
-	5.433 x 5.433	138.0 x 138.0	14	2.0	*Hydr. Only	60234	60023	60024	60118	-	60235	1.188	30.2	20	9.1	*	

Special Square

0.886(A)	0.791(B)	22.5 ∅(A) 20.1(B)	14	2.0	Hand/Hydr.	61125**	-	-	34421	34733G	2929AV	.500	12.7	.7	.3	33967
----------	----------	-------------------	----	-----	------------	---------	---	---	-------	--------	--------	------	------	----	----	-------

*For use with with Hand and Foot Pump Hydraulic Drivers with Ram. For use with any Greenlee Hydraulic Driver or Battery-Powered Driver. ** Sold as Unit only
 ∅For use with any Greenlee Hydraulic Driver or Battery-Powered Driver. For maximum draw stud life, Greenlee recommends the use of battery or hydraulic drivers

Rectangular Punches

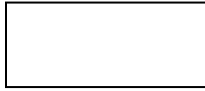

Rectangle



Counter Nut



Punch



Die

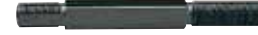

Draw Stud



Ball Bearing Drive Nut

CAT. NO

HOLE SIZE		MAXIMUM CAPACITY MILD STEEL		OPERATION TYPE	SET (INCLUDES PUNCH, DIE DRAW STUD AND NUTS)	PUNCH	DIE	DRAW STUD	BB DRIVE NUT	COUNTER NUT	MINIMUM PILOT HOLE		WEIGHT		OPTIONAL ADAPTER FOR HYDRAULIC DRIVERS
IN	mm	ga	mm								IN	mm	LB	KG	
A	A														
0.437 x 0.875	11.1 x 22.2	16	1.5	∅Hand/Hydr.	60025	60026	60027	60115	60120	2046AV	.375	9.5	1.2	.5	60114∅
0.670 x 0.749	17.0 x 19.0	14	2.0	∅Hand/Hydr.	61028	-	-	34421	34733G	2929AV	.500	12.7	1.5	.68	33967∅
0.750 x 1.140	19.1 x 29.0	14	2.0	∅Hand/Hydr.	60031	60032	60033	60117	60165	60258	.625	15.9	2.3	1.0	60167∅
0.750 x 1.310	19.1 x 33.3	14	2.0	∅Hand/Hydr.	60034	60035	60036	60117	60165	60258	.625	15.9	2.3	1.0	60167∅
0.861 x 1.018	21.9 x 25.9	14	2.0	∅Hand/Hydr.	60037	60038	60039	60117	60165	60258	.625	15.9	2.3	1.0	60167∅
0.866 x 1.181	22.0 x 30.0	14	2.0	∅Hand/Hydr.	60040	60041	60042	60117	60165	60258	.625	15.9	2.4	1.1	60167∅
0.866 x 1.654	22.0 x 42.0	14	2.0	∅Hand/Hydr.	60043	60045	60046	60117	60165	60258	.625	15.9	2.9	1.3	60167∅
0.990 x 1.140	25.1 x 29.0	14	2.0	∅Hand/Hydr.	60047	60048	60049	60117	60165	60258	.625	15.9	2.6	1.2	60167∅
1.250 x 1.380	31.8 x 35.1	14	2.0	∅Hand/Hydr.	60050	60051	60052	60117	60165	60258	.625	15.9	3.1	1.4	60167∅
1.312 x 2.625	33.3 x 67.9	10	3.5	∅Hand/Hydr.	60053	60054	60055	60118	-	60235	1.188	30.2	5.1	2.3	∅
1.378 x 2.047	35.0 x 52.0	10	3.5	∅Hand/Hydr.	60056	60057	60058	60118	-	60235	1.188	30.2	6.1	2.8	∅
1.378 x 2.559	35.0 x 65.0	10	3.5	∅Hand/Hydr.	60059	60060	60061	60118	-	60235	1.188	30.2	6.8	3.1	∅
1.378 x 3.228	35.0 x 82.0	14	2.0	∅Hand/Hydr.	60062	60063	60064	60118	-	60235	1.188	30.2	7.7	3.5	*
1.378 x 4.409	35.0 x 112.0	14	2.0	∅Hand/Hydr.	60065	60066	60067	60118	-	60235	1.188	30.2	9.2	4.2	*
1.811 x 3.622	46.0 x 92.0	10	3.5	∅Hand/Hydr.	60068	60069	60070	60118	-	60235	1.188	30.2	8.9	4.0	*
2.250 x 3.500	57.2 x 88.9	10	3.5	∅Hand/Hydr.	60071	60072	60073	60118	-	60235	1.188	30.2	10.1	4.6	*
2.677 x 5.433	68.0 x 138.0	14	2.0	∅Hand/Hydr.	60074	60075	60076	60118	-	60235	1.188	30.2	16.1	7.3	*

*For use with with Hand and Foot Pump Hydraulic Drivers with Ram
 For maximum draw stud life, Greenlee recommends the use of battery or hydraulic drivers
 ∅For use with any Greenlee Hydraulic Driver or Battery-Powered Driver

Electronic Connector Panel Punches

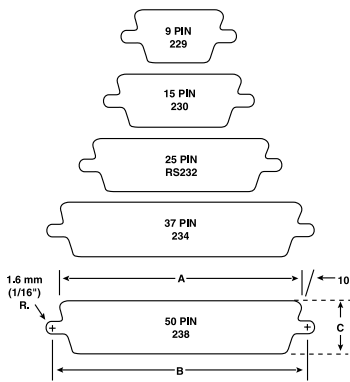

- Cut-out and mounting slots are punched in one operation
- Drill only one 7/16" (11.1 mm) pilot hole (see page 118 for Kwik Stepper® step bits)
- Fast, accurate panel punching with no sawing or filing required
- Universal size punches for front or back mount of TRW Cinch and ITT Cannon-type or equivalent connectors in 9, 15, 25, 37 or 50-pin configurations

SPECIFICATIONS

Capacity	16 ga (1.5 mm) mild steel; 10 ga (3.5 mm) aluminum
Operation	Manual with a wrench; Quick Draw® and Quick Draw 90® hydraulic drivers, Battery Driver, Ram and Pump hydraulic drivers aluminum

SET			DIMENSIONS			WEIGHT				
CAT NO.	UPC NO.	NO. OF PINS	A	B	C	DRAW STUD	BB DRIVE NUT	SQUARE COUNTER NUT	LB	KG
229	783310344360	9	.787" (20.0 mm)	.982" (24.9 mm)	.469" (11.9 mm)	34421	34733G	2929AV	1.4	.64
231	783310344377	15	1.127" (28.6 mm)	1.309" (33.3 mm)	.469" (11.9 mm)	34421	34733G	2929AV	1.5	.68
RS232	783310344209	25	1.6555" (42.0 mm)	1.853" (47.1 mm)	.469" (11.9 mm)	34421	34733G	2929AV	2.0	.91
234	783310344292	37	2.296" (58.3 mm)	2.497" (58.3 mm)	.469" (11.9 mm)	34421	34733G	2929AV	2.0	.91
238	783310344445	50	2.201" (55.9 mm)	2.402" (61.0 mm)	.579" (14.7 mm)	34421	34733G	2929AV	2.0	.91

*For maximum draw stud life, Greenlee recommends the use of battery or hydraulic drivers

REPLACEMENT DRAW STUDS FOR SPECIAL SHAPE PUNCHES

- Refer to the ACTUAL SIZE images and information below when ordering a replacement draw stud. Sizes given are diameter X working length
- For maximum draw stud life, Greenlee recommends the use of hydraulic drivers



60118 / 783310601180
3/4" x 6-3/4"



60166 / 783310601661
1/2" x 4-5/8"



60117 / 783310601173
1/2" x 4-5/8"



60167 / 783310601678
(Adapter) - 3/4" x 1/2" internal



34421 / 783310344216
3/8" x 3-1/2"

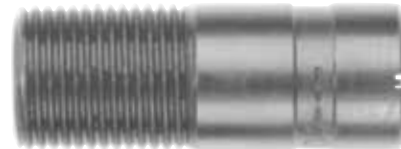

33967 / 7883310339670
(Adapter) - 3/4" x 3/8" internal



60115 / 783310601159
1/4" x 3-7/16"



60114 / 783310601142
(Adapter) - 3/4" x 1/4" internal

STUD PUNCHES



ESP710L11

Battery-Hydraulic Stud Punch

- Quickly and easily punches 1-11/32" (34.1 mm) diameter holes in 16 and 18 ga structural studs
- 4" throat depth from center of punch

CAT NO.	UPC NO.	DESCRIPTION
ESP710L11	783310521655	Punch, 3.0Ah 18V, Li-Ion Battery, 120V Charger

SPECIFICATIONS

Actual Hole Size	1-11/32" (34.1 mm)
Weight	9.2 lb (4.2 kg)
Length	15" (381 mm)
Height	11-3/4" (298 mm)
Capacity	16 ga (1.5 mm)







Plumber Stud Punch

- Punches 2-5/8" (66.7 mm) diameter hole in metal studs for installation of 2" water, vent, and waste pipes
- Two-speed lever action for fast, easy punching of 24 to 20 ga thick metal studs
- 2-1/8" (54 mm) throat width fits over most studs and channels
- High strength alloy aluminum c-frame and handle provide lightweight tool for easy handling—10.6 lb (4.8 kg)
- Lever action punch retraction strips punch out of metal stud fast and easy

SPECIFICATIONS

Actual Hole Size	2-5/8" (66.7 mm)
Weight	10.6 lb (4.8 kg)
Length	23-1/2" (596 mm)
Height	9-3/4" (247 mm)
Capacity	24-20 ga (0.9 mm)

CAT NO.	UPC NO.	DESCRIPTION
713	783310064305	Plumber Stud Punch
 08377	783310083771	Punch for 713
 08379	783310083795	Die for 713
 08375	7833100835757	Link
 55316	783310553168	Pin, Groove .31 x 1.75

KNOCKOUTS

Metal Stud Punches



- Punch up through 20 ga (0.9 mm) steel studs in one stroke
- Aluminum head provides strength with minimum weight, reducing operator fatigue
- Contoured handle design gives better operator leverage and makes it possible to punch in tight places
- Self-stripping design eliminates punch hang-ups
- Automatically centers holes on standard studs
- Conversion kit available to upgrade early models from 24 ga to 20 ga maximum capacity

SPECIFICATIONS

Capacity	709 – 1-5/8" (41.3 mm) and wider studs. 20 ga (0.9 mm) steel studs 710 – 2-1/2" (63.4 mm) and wider studs. 20 ga (0.9 mm) steel studs
-----------------	--

CAT NO.	UPC NO.	DESCRIPTION
709	783310222804	7/8" (22.2 mm) Diameter Stud Punch
710	783310212850	1-11/32" (34.1 mm) Diameter Stud Punch
30968G	783310309680	Conversion Kit – upgrades early model 709 or 710 from 24 to 20 ga maximum capacity
R 121AV	783310040064	Punch for 709
R 22286	783310222866	Die for 709
R 24823	783310248231	Punch for 710
R 21297	783310212973	Die for 710
06015	783310060154	Pin Kit
05932	783310059325	Link and Pin Kit (709/710)
21557	783310215578	Compression Spring

Bushings for Metal Stud Punches



712A1000



711C

- Triple lock design holds bushing securely
- Locks securely into 24-ga – 12-ga (0.6 mm – 2.5 mm) metal studs
- Helps protect wire insulation from sharp edges of metal studs
- Makes pulling smooth and easy by preventing cable hang-ups on raw metal edges

CAT NO.	UPC NO.	DESCRIPTION
711C	783310222880	100 Bushings for Hole Punched by 709 for 7/8" (22.2 mm) Diameter Hole
711M	783310222897	1,000 Bushings for Hole Punched by 709 for 7/8" (22.2 mm) Diameter Hole
712A100	783310059271	100 Bushings for Pre-Punched Hole or 1-11/32" (34.1 mm) Diameter Hole Punched by 710
712A1000	783310059288	1,000 Bushings for Pre-Punched Hole or 1-11/32" (34.1 mm) Diameter Hole Punched by 710





724

Manual Stud Punch

- Punch up through 20 ga (0.9 mm) steel studs in one stroke
- Unique patented punch rolls the edge over for smooth installation of armored cable; cable won't hang up
- Contoured handle design gives better operator leverage and makes it possible to punch in tight places
- Automatically centers holes on standard studs

SPECIFICATIONS

Actual Hole Size	1-1/4" (31.7 mm)
Weight	4.0 lb (1.8 kg)
Length	16-3/4" (426 mm)
Height	4-1/2" (247 mm)
Capacity	24-20 ga (0.9 mm)

CAT NO.	UPC NO.	DESCRIPTION
724	783310104155	Manual Stud Punch
 10419	783310104193	Punch for 724

MANUAL – HYDRAULIC PUMPS



767

Hydraulic Hand Pump

- Lightweight and portable, for use with Greenlee Punch Drivers
- Versatile, operates in any position
- Rugged steel pump body/reservoir with cast aluminum handle
- Has mounting holes for easy, permanent mounting

SPECIFICATIONS

Operation	Manual – Hand
Capacity	6,500 psi (448 bar), .0823 in ³ (13 mm ³) per stroke
Length	13" (330 mm)
Width	4" (102 mm)
Height	4" (102 mm)

CAT NO.	UPC NO.	DESCRIPTION
767	783310132844	Hydraulic Hand Pump
R 04343	783310043430	Seal Kit Repair for Serial Code ABM
R 13800	783310138006	*Seal Kit Repair for Serial Code 55D & Up
R 30242	783310302421	*Seal Kit Repair for Serial Code 68BG to BG33181628, BG331816 & Up
R 30241	783310302414	Reservoir Follower

***NOTE:** Must also purchase 30241 Follower

NOTE: See next page to select the proper hydraulic hose for this pump.

Hydraulic Foot Pump

- Free both hands to position and hold the working tool
- Foot activated release lever
- Hold-down pin keeps pedal down for storage and transport
- Angled base bar keeps the pump upright and stable
- Includes 1/4" (6.4 mm) female coupler with dust cap



1725

SPECIFICATIONS

Operation	Manual – Foot
Capacity	6,500 psi (448 bar), .117 in ³ (19 mm ³) per stroke
Length	16" (406 mm)
Width	8" (203 mm)
Height	Pedal down 6" (152 mm), Pedal up 12" (305 mm)

CAT NO.	UPC NO.	DESCRIPTION
1725	783310313533	Hydraulic Foot Pump
R 33336	783310333364	Seal Kit w/ VK Serial Code

NOTE: See next page to select the proper hydraulic hose for this pump.

HYDRAULIC PUMP ACCESSORIES

Hydraulic Hose Selection Guide

TOOL CAT. NO.	DESCRIPTION	TOOL COUPLER	PUMP CAT. NO.	HOSE CAT. NO.
750	Cable Cutter	1/4" Female Coupler	767	38316
750	Cable Cutter	1/4" Female Coupler	1725	37729
750	Cable Cutter	1/4" Female Coupler	755 or EHP700	17707
777	Bender	3/8" Female Coupler	755, 975, or 980	11289
782	Bender	3/8" Female Coupler	755 or 975	11289
800	Cable Bender	1/4" Female Coupler	1725	37729
880	Bender	3/8" Female Coupler	755 or 975	11289
882	Bender	3/8" Female Coupler	755 or 975	11289
884	Bender	3/8" Female Coupler	980	11289
885	Bender	3/8" Female Coupler	980	11289
1731	C-Frame Driver	1/4" Female Coupler	767	06302
1731	C-Frame Driver	1/4" Female Coupler	1725	37729
1731	C-Frame Driver	1/4" Female Coupler	755 or 975	11289
SDK2021GL	Remote Crimping Tool	3/8" Male Coupler	EHP700, 7475H, 975 or 980	05850, 05851
RK06AT, RK06FT	Remote Crimping Tool	3/8" Male Coupler	EHP700, 7475H, 975 or 980	05850, 05851
RK1240,	Remote Crimping Tool	3/8" Male Coupler	EHP700, 7475H, 975 or 980	05850, 05851
RK1550	Remote Crimping Tool	3/8" Male Coupler	EHP700, 7475H, 975 or 980	05850, 05851



Hydraulic Hoses

- High pressure hydraulic hose units for use with Greenlee hydraulic pumps
- Equipped with couplers and dust caps

CAT NO.	UPC NO.	DESCRIPTION
05850*	783310058502	10' X 1/4" Hose with (1) 3/8" Male Coupler and (1) 3/8" Female Coupler
05851*	783310058519	10' X 1/4" Non-Conductive Hose with (1) 3/8" Male Coupler and (1) 3/8" Female Coupler
11289*	783310112891	6' X 3/8" Hose with (2) 3/8" Male Couplers
17707*	783310177074	10' X 1/4" Hose with (1) 3/8" Male Coupler and (1) 1/4" Male Coupler
37729*	783310377290	10' X 1/4" Hose with (2) 1/4" Male Couplers
38316	783310383161	3' X 1/4" Hose with (1) 1/4" Male Coupler and (1) 1/4" NPT Swivel Threaded Fitting
06302	783310063025	3' X 1/4" Hose with (1) 1/4" NPT Male Threaded Fitting and (1) 1/4" NPT Swivel Threaded Fitting

*Filled with hydraulic oil.

CAT NO.	UPC NO.	DESCRIPTION	HOSE UNIT CAT. NO.							COUPLER SET CAT. NO.		
			05850	05851	11289	17707	37729	38316	20573	37614	3548GB/ 20573	
54167G	783310541677	1/4" (6.4 mm) Female Coupler without Dust Cap	-	-	-	-	-	-	-	-	1	-
54168	783310541684	1/4" (6.4 mm) Dust Cap for Female Coupler	-	-	-	-	-	-	-	-	1	-
54169	783310541691	1/4" (6.4 mm) Male Coupler without Dust Cap	-	-	-	-	1	2	1	1	1	-
54170	783310541707	1/4" (6.4 mm) Dust Cap for Male Coupler	-	-	-	-	1	2	1	1	1	-
4018GB	783310508076	3/8" (9.6 mm) Female Coupler with Dust Cap	-	-	-	-	-	-	-	-	-	1
4033GB	783310508236	3/8" (9.6 mm) Male Coupler with Dust Cap	-	-	2	1	-	-	-	-	-	1
F021627	783310418771	3/8" (9.6 mm) Female Coupler without Dust Cap	1	1	-	-	-	-	-	-	-	-
F022061	783310419419	3/8" (9.6 mm) Male Coupler without Dust Cap	1	1	-	-	-	-	-	-	-	-
F021406	783310418344	3/8" (9.6 mm) Dust Cap for 41941/41877 Couplers	2	2	-	-	-	-	-	-	-	-

Bluetooth is a registered trademark of Bluetooth SIG, INC.
 Makita is a registered trademark of Makita Corporation
 Quarite is a registered trademark of Hubbell Inc.