

VOLTMETER/PHASER

and ACCESSORIES

Operating & Instruction Manual



VOLTMETER/PHASER

and ACCESSORIES

Operating & Instruction Manual

IMPORTANT SAFETY INFORMATION	4
GENERAL DESCRIPTION	5
MODELS and SPECIFICATIONS	6-9
Voltmeters - Analog Meters	6
Voltmeters & Phasers - Analog Meters	6-7
Voltmeters & Phasers - Digital Meters	8-9
DigiVolt 25T	8
DigiVolt 80 Series	9
OPERATING INSTRUCTIONS	10-11
Pre-Use Inspection	10
Voltage and Phasing Measurements - Line-to-Line	10
Voltage Measurements - Line-to-Ground	11
Test Point Measurements	11
Care and Maintenance	11
PROBES AND ACCESSORIES	12-15
Overhead and Underground Probes	12
Proof Tester® Voltmeter Tester	12
Cable Fault Tester	13-15
REPAIRS	15
CALIBRATION AND MAINTENANCE LOG	15
TERMS AND CONDITIONS OF SALE	16

MANUFACTURING LOCATION

HD Electric • Southaven, MS, 38672 USA

IMPORTANT SAFETY INFORMATION

Read and understand these instructions prior to use. These operating instructions are not a substitute for proper training in the use of this equipment. High voltage systems present serious hazards, including the risk of death or serious injury due to arcing, thermal burns and electrocution. HD Electric's products are intended solely for use by professionals with knowledge, training and experience in the use of the equipment and its accessories in and around high voltage systems.

All applicable federal, state, company and OSHA work practices must be followed. If you are unfamiliar with the work practices required, **DO NOT PROCEED**. Call HD Electric if you have any questions regarding this equipment.

IMPORTANT LABELS SUCH AS THESE ARE AFFIXED TO VARIOUS PRODUCTS. READ AND UNDERSTAND EACH OF THEM BEFORE PROCEEDING.



DANGER
ELECTRIC SHOCK HAZARD
ELECTRICAL ARC HAZARD

READ INSTRUCTIONS AND OPERATIONS MANUAL BEFORE USE

Always wear personal protective equipment including eye and face protection, insulating gloves and FR clothing.
All OSHA and company work practices must be followed.
Always maintain proper working clearances.
Use only HD Electric probes appropriate and intended for the work to be performed.
This product is designed for use by professionals trained in its use and application in and around high voltage electrical equipment. If you are not trained in the work methods required for safe operation, **DO NOT PROCEED** until you obtain the proper training.
Failure to follow these recommended practices may result in severe burns, serious injury or death.

HD Electric Company
www.hdelectriccompany.com Phone: (847) 473-4980



NOTICES - CAUTIONS - WARNINGS

NOTICES - This product is designed for use by professionals trained in its use and application in and around high voltage electrical equipment. If you are not trained in the work methods required for safe operation, do not proceed until you obtain the training.

CAUTIONS - This product was tested before leaving the factory but it must be inspected prior to and after each use for proper working condition. All fiberglass was tested per OSHA at 100kV/1.5 min. Be aware that dirt, moisture, mechanical fatigue and other factors reduce the dielectric strength of the product. If any defect or condition is noted, do not use this product. Remove from service and arrange for repair.

WARNINGS - Rigorous hot stick work precautions and all OSHA and company work practices must be followed. Always wear approved cover-up and safety equipment. Read and understand instructions prior to use. Misuse and abuse of this product can lead to severe injury or death.

HD ELECTRIC COMPANY
1475 LAKESIDE DRIVE
WAUKEGAN IL 60085 USA
©NLS 1/21

HDE www.hdelectriccompany.com

All meters require the use of accessory hot sticks, which may or may not be supplied with the meter. The minimum hot stick length required for safe use depends upon the particular operation; consult federal, state, company and OSHA specifications for the proper hot stick length for the intended operation.

The users of this meter should always be equipped with personal protective equipment including high voltage gloves, flame retardant clothing, eye and face protection. Some applications may require additional protective equipment.

Accessory probes are available for all meters. Always use the proper probe(s) for your application.

Failure to follow these and other warnings and safety precautions may result in severe injury or death.

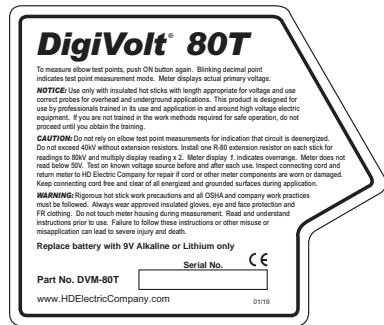

DigiVolt® 80T

To measure elbow test points, push ON button again. Blinking decimal point indicates test point measurement mode. Meter displays actual primary voltage.

NOTICE: Use only with insulated hot sticks with length appropriate for voltage and use correct probes for overhead and underground applications. This product is designed for use by professionals trained in its use and application in and around high voltage electrical equipment. If you are not trained in the work methods required for safe operation, do not proceed until you obtain the training.

CAUTION: Do not rely on elbow test point measurements for indication that circuit is deenergized. Do not exceed 48kV without extension resistors. Install one F-80 extension resistor on each stick for readings to 80kV and multiply display reading x 2. Meter display 0 indicates overvoltage. Meter does not read below 50V. Test on known voltage source before and after each use. Inspect connecting cord and return meter to HD Electric Company for repair if cord or other meter components are worn or damaged. Keep connecting cord free and clear of all energized and grounded surfaces during operation.

WARNING: Rigorous hot stick work precautions and all OSHA and company work practices must be followed. Always wear approved insulated gloves, eye and face protection and FR clothing. Do not touch meter housing during measurement. Read and understand instructions prior to use. Failure to follow these instructions or other misuse or misapplication can lead to severe injury or death.

Replace battery with 9V Alkaline or Lithium only

Serial No.

Part No. DVM-80T

www.HDElectricCompany.com 0119

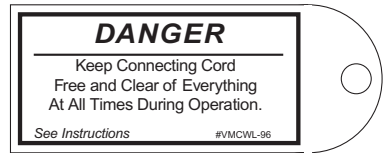

DANGER

Keep Connecting Cord
Free and Clear of Everything
At All Times During Operation.

See Instructions #VMCWL-96



W A R N I N G
HOT STICK REQUIRED
W A R N I N G

GENERAL DESCRIPTION

All HD Electric voltmeters and phasers are constructed with epoxy encapsulated high voltage resistors, a connecting cord and a meter display. The meter display may be digital or analog. The major elements are shown here:

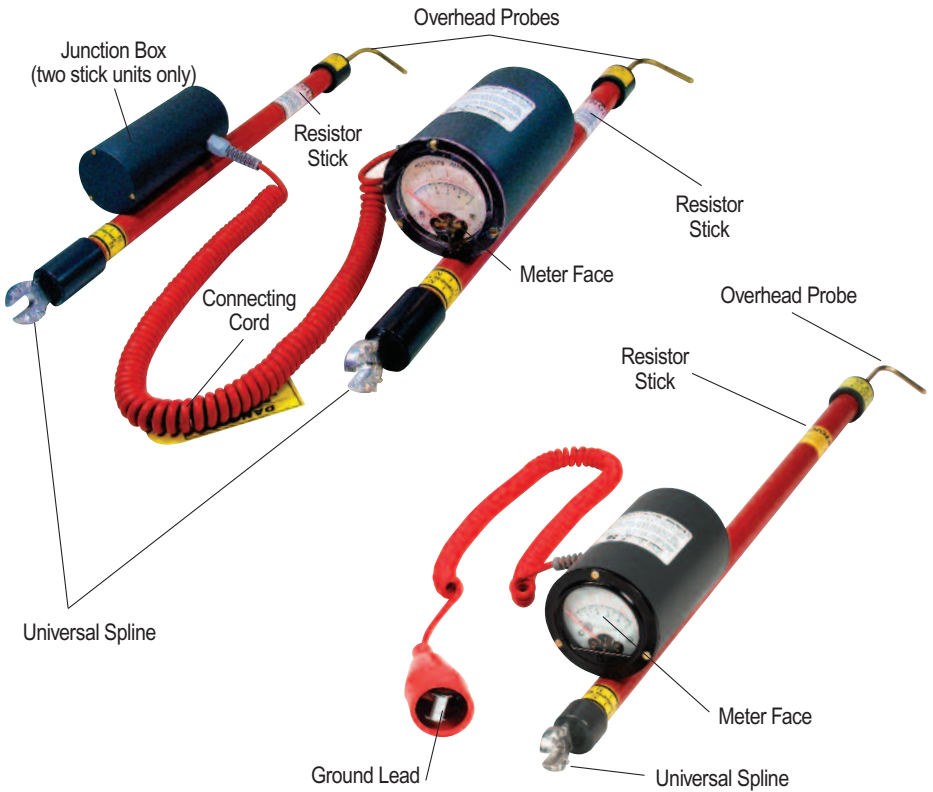

The high voltage resistors limit the current through the connecting cord to a maximum of about one milliamp. Although the connecting cord is insulated for voltage up to 10kV, it should always be kept free and clear from you, ground and any other conductors. These instruments will measure DC through 1000Hz RMS AC.

WARNING: Single stick voltmeters can be used for line-to-ground measurements only. The alligator clip on the end of the coil cord must always be connected to ground prior to making high voltage measurements and should be removed from ground only after high voltage measurements are completed. Two stick voltmeters can be used for both line-to-ground and line-to-line voltage measurements.

WARNING: Some models have range switches or require add-on resistor sticks for higher voltage ranges. Always completely remove the voltmeter from the live circuit before changing the range switch position or adding or removing add-on resistor sticks. Always use add-on resistor sticks in pairs, one on each voltmeter stick.

MODELS AND SPECIFICATIONS

VOLTMETERS – Analog Meters

LINE-TO-GROUND MEASUREMENTS ONLY

ALL ANALOG MODELS MEASURE DC THROUGH 1000HZ AC

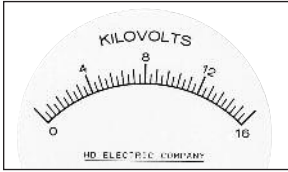

EM-1 Scale

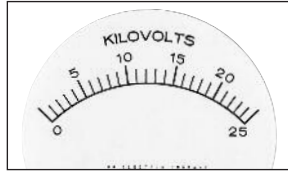

EM-2 Scale

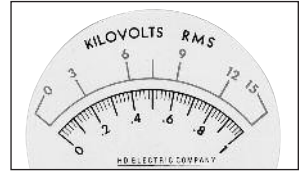

EM-3 Scale

EM-1 – Single stick, single range: 0 - 16kV, line-to-ground only

- The alligator clip on the cord must be connected only to ground or system neutral.

EM-2 – Single stick, single range: 0 - 25kV, line-to-ground only

- The alligator clip on the cord must be connected only to ground or system neutral.

EM-3 – Single stick, dual range: 0 - 1kV and 0 - 15kV line-to-ground only

- The alligator clip on the cord must be connected only to ground or system neutral.
- Measure on the 1kV scale with the selector switch set for LO range.
- Measure on the 15kV scale with the selector switch set for HI range.

VOLTMETERS & PHASERS – Analog Meters

LINE-TO-GROUND AND LINE-TO-LINE MEASUREMENTS

ALL ANALOG MODELS MEASURE DC THROUGH 1000HZ AC

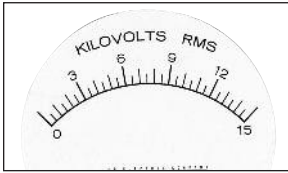

MARK I Scale

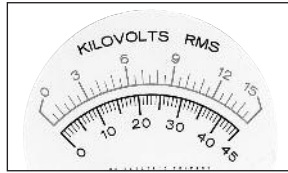

MARK II Scale

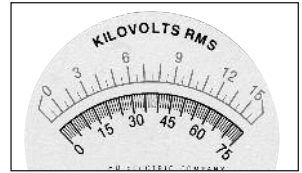

MARK III Scale

MARK I – Dual stick, single range: 0 - 15kV

MARK II – Dual stick, dual range: 0 - 15kV and 0 - 45kV

- Measure on the 15kV scale with the selector switch set for LO range.
- Measure on the 45kV scale with the selector switch set for HI range.

MARK III – Dual stick, dual range: 0 - 15kV & 0 - 75kV with included R-75 add-on resistor sticks

- Measure on the 15kV scale with the selector switch set for LO range and without the add-on resistor sticks.
- Measure on the 75kV scale with the selector switch set for HI range and with the add-on resistor sticks installed, one on each meter stick.

MODELS AND SPECIFICATIONS *continued*

VOLTMETERS & PHASERS – Analog Meters (continued)

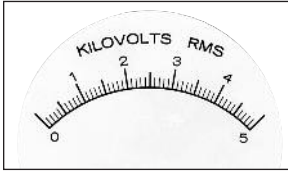

MARK IV Scale

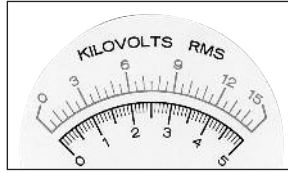

MARK V Scale

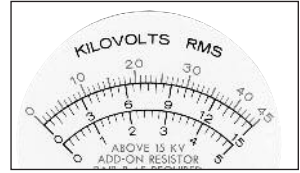

MARK VI Scale

MARK IV – Dual stick, single range: 0 - 5kV

MARK V – Dual stick, dual range: 0 - 5kV and 0 - 15kV

- Measure on the 5kV scale with the selector switch set for LO range.
- Measure on the 15kV scale with the selector switch set for HI range.

MARK VI – Dual stick, triple range: 0 - 5kV, 0 - 15kV and 0 - 45kV

with included R-45 add-on resistor sticks

- Measure on the 5kV scale with the selector switch set for LO range and without the add-on resistor sticks.
- Measure on the 15kV scale with the selector switch set for HI range and without the add-on resistor sticks.
- Measure on the 45kV scale with the selector switch set for HI range and with the add-on resistor sticks installed, one on each meter stick.

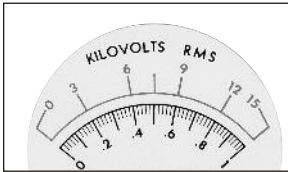

MARK VII Scale

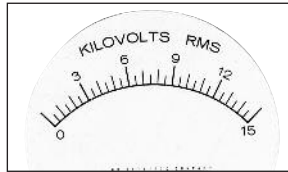

MARK VIII Scale

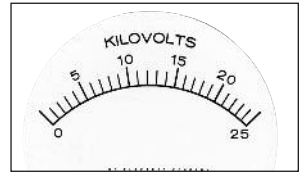

MARK IX Scale

MARK VII – Dual stick, dual range: 0 - 1kV and 0 - 15kV

- Measure on the 1kV scale with the selector switch set for LO range.
- Measure on the 15kV scale with the selector switch set for HI range.

MARK VIII – Single stick/dual stick, single range: 0 - 15kV

- Can be used for line-to-ground measurements only with single stick and connecting cord with alligator clip. Convert from one stick voltmeter to two stick voltmeter/phaser for both line-to-ground and line-to-line measurements by removing the coil cord with alligator clip and installing cord connected to second resistor stick.

MARK IX – Dual stick, single range: 0 - 25kV

MARK XI – Dual stick, dual range: 0 - 5kV and 0 - 25kV

- Measure on the 5kV scale with the selector switch set for LO range.
- Measure on the 25kV scale with the selector switch set for HI range.

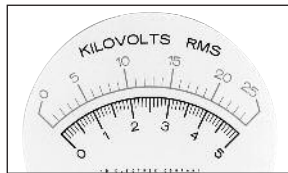

MARK XI Scale

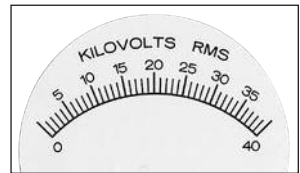

MARK XII Scale

MARK XII – Dual stick, single range: 0 - 40kV

VOLTMETER – Digital Meters

DigiVolt® Model 25T



The DVM-25T is a compact, single stick version of the DigiVolt® voltmeters. It requires one 9V lithium or alkaline battery, which powers the unit and activates the backlight. The meter will shut off automatically a few minutes after the display reads zero, but not while voltage measurements are being made. The DVM-25T includes an elbow test point reading feature, which is displayed by a blinking decimal point (>×). The backlight is always on when the unit is powered on. The low battery feature will simply shut off or will not turn on the meter when the battery is low. The unit has a 0.4" LCD display that indicates 3-1/2 digits. The DVM-25T measures RMS AC and DC.

DVM 25T – Single stick, dual range, auto ranging:

50V – 19.99kV and 20.0kV – 25.0kV line-to-ground only

- The alligator clip on the cord must be connected only to ground or system neutral.
- Includes Test Point Measurement. Press the ON button again to activate this feature and once again to shut it off. A blinking decimal point (>×) confirms Test Point mode.

VOLTMETERS & PHASERS – Digital Meters
DigiVolt Model 80 Series



The DVM-80 is a compact digital voltmeter/phasing set. It requires one 9V lithium or alkaline battery, which powers the unit and activates the backlight. The meter will shut off automatically a few minutes after the display reads zero, but not while voltage measurements are being made. The DVM-80T includes an elbow test point reading feature, which is displayed by a blinking decimal point (\times). The backlight is always on when the unit is powered on. The low battery feature will simply shut off or will not turn on the meter when the battery is low. The unit has a 0.4" LCD display that indicates 3-1/2 digits. The DVM-80 measures RMS AC and DC.

DVM 80 – Dual stick, dual range, auto ranging: 50V – 19.99kV and 20.0kV – 40.0kV
Can be used up to 80kV with optional R-80 add-on resistor sticks.

- To take readings above 40.0kV, install one R-80 add-on resistor stick on each meter stick, and then multiply the reading on the display by two (for example, if the display reads 30kV with add-on resistor sticks installed, multiply 30 times 2 = 60.0kV).

DVM 80T – Dual stick, dual range, auto ranging: 50V - 19.99kV and 20.0kV - 40.0kV
Can be used up to 80kV with optional R-80 add-on resistor sticks.

- Includes Test Point Measurement. Press the ON button again to activate this feature and once again to shut it off. A blinking decimal point (\times) confirms Test Point mode.
- To take readings above 40.0kV, install one R-80 add-on resistor stick on each meter stick, and then multiply the reading on the display by two (for example, if the display reads 30kV with add-on resistor sticks installed, multiply 30 times 2 = 60.0kV).

DVM 80T-0 – Dual stick, dual range, auto ranging: 0V - 19.99kV and 20.0kV - 40.0kV
Can be used up to 80kV with optional R-80 add-on resistor sticks.

- Includes Test Point Measurement. Press the ON button again to activate this feature and once again to shut it off. A blinking decimal point (\times) confirms Test Point mode.
- To take readings above 40.0kV, install one R-80 add-on resistor stick on each meter stick, and then multiply the reading on the display by two (for example, if the display reads 30kV with add-on resistor sticks installed, multiply 30 times 2 = 60.0kV).

OPERATING INSTRUCTIONS

Pre-Use Inspection

WARNING: Before using the instrument be sure to test and inspect the equipment to ensure that it is functioning properly and is in safe, working condition. Failure to do so may cause serious injury or death and may result in erroneous test measurements.

Before making any high voltage measurements, test and inspect the voltmeter/phaser as follows:

- 1) Make certain the instrument is clean, dry and waxed to a clear shiny surface.
- 2) Inspect the cord for cracked insulation.
- 3) Be sure that you are using hot sticks of the appropriate length, and examine each hot stick to ensure that it is clean, dry and waxed to a clear shiny surface.
- 4) Attach the appropriate probes for overhead or underground applications (see page 12) and ensure that the probes are properly installed and tightened (do not overtighten).
- 5) If you are using a multi-range meter, confirm that the range switch is in the proper position.
- 6) Install add-on resistor sticks if necessary for the range being tested.
- 7) Test the voltmeter/phaser with a Proof Tester[®] Voltmeter Tester such as the HD Electric PT-5000B (see page 12).

Voltage and Phasing Measurements – Line-to-Line

We recommend that two person crews perform all line-to-line voltage measurements and phasing operations. Since the operation is occurring near two energized conductors, the use of two person crews allows each person to operate one meter stick and maintain high safety standards.

In order to make line-to-line measurements, each probe must contact an energized line. Be sure that only those probes intended for the particular application are used (see page 12). Always keep the connecting cord free and clear of energized phases and ground.

For phasing applications, the probes will be placed on opposite sides of an open point, typically a switch. The phasing operation will indicate if two sides of a line are in-phase before closing a switch.

To check all phases, proceed as follows:

- 1) Measure voltage on each phase from line-to-ground to verify all phases are live and at the same voltage.
- 2) Place one of the probes on a conductor on one side of the switch.
- 3) Place the other probe on one of the three phases on the other side of the switch.
- 4) If the conductors are out-of-phase, the meter will read line-to-line voltage. If they are in-phase, the meter will read near zero but may read up to 15% of the line-to-line voltage.
- 5) Continue this procedure with all three phases on both sides of the switch.

If an intermediate reading is found, the phasing cannot be determined by this method and the switch should not be closed until other means are used for phasing.

OPERATING INSTRUCTIONS *continued*

Voltage Measurements – Line-to-Ground

To use a one-stick voltmeter with ground lead, first clip the ground lead on either a ground or system neutral. The resistor stick probe can then be connected to the energized source to be measured. Keep the connecting cord free and clear while testing and disconnect the ground clip only after removing the meter probe from the voltage source.

To use a two-stick voltmeter/phaser, first connect one of the probes to either a ground or system neutral, making sure the resistor stick is making contact at all times during measurement. The other probe should be connected to the energized source to be measured.

Maintain contact only long enough to read the meter. Always remove the probe from the energized source first before removing the ground connection.

TEST POINT MEASUREMENTS

Some of the digital voltmeters include a Test Point feature for measuring voltage from elbow test points. To activate Test Point mode on the DVM-25T and DVM-80T simply push the ON button again. Test Point mode is indicated by a blinking decimal point. To turn Test Point mode off, push the ON button once again and the decimal point will stop blinking. When using a digital voltmeter to phase between test points, the important measurement is whether high voltage is present or not. The proper procedure for phasing between elbow test points is as follows:

- 1) Both elbows must be energized. Follow the proper safety practices for removing the test point protective caps and exposing the live test points. Treat all exposed electrodes as energized high voltage. Measure from both elbow test points to ground. These measurements should show that both elbows are energized and, if both elbows are of the same type and manufacture, should measure the approximate line voltage.
- 2) Measure from one elbow test point to the other. This reading will show either a high voltage reading indicating the elbows are out-of-phase or a zero or low voltage reading indicating the elbows are connected to the same phase. The out-of-phase measurement will likely not show the higher voltage expected from a phase-to-phase measurement but will be closer to the line-to-ground voltage. The in-phase voltage measurement can be between zero and 15% of the nominal line-to-ground voltage. If both elbows are of different type and manufacture, then a higher reading may occur.

CARE AND MAINTENANCE

Periodic regular maintenance is required to keep the voltmeter in proper operating condition. Digital models will require periodic battery replacement. Keep the voltmeter clean and dry and always store it in its case. The fiberglass sticks should be kept clean and free of dirt, contamination and marking. Examine the cord for cracking or other damage prior to each use. Although we do not specify a calibration cycle, we recommend you test, measure and calibrate your instrument annually. The Calibration and Maintenance Log provided on page 15 can be used to record these events. Contact HD Electric for details.

PROBES AND ACCESSORIES

WARNING: ALWAYS use probes appropriate to your application. NEVER use overhead probes in underground applications. Failure to use the correct probe can result in arcing or electrical contact and may cause serious injury or death. If you are not trained in the particular operation or are not sure about the appropriate probe for your application **DO NOT PROCEED**.

Overhead Probes

- 025-OLPS-5 brass hook probe
- 025-OLPS-6 brass pigtail probe



Underground Dead Front Bushing Probes

- ASP-15/25 for use in 15kV and 25kV loadbreak bushings
- ASP-35U for use in 35kV loadbreak bushings

Underground Elbow Probe

- EA-15/25 for insertion in loadbreak elbows.
- NOTE:** The elbow must be firmly supported when using this probe.

Insulated Underground Probe

- GCP-1 for general underground use on grounded terminals, exposed high voltage terminals or elbow test points.



Add-On Resistor Sticks

Resistor sticks are used with the specific HD Electric voltmeters indicated in this manual.

Always completely remove the voltmeter from the live circuit before adding or removing add-on resistor sticks. Always use the add-on resistor sticks in pairs, one on each voltmeter stick, then attach the appropriate overhead or underground probe to be used. Do not exceed the indicated voltmeter high end voltage with the resistor sticks attached.



Resistor Stick

Proof Tester® Voltmeter Tester

The PT-5000B Proof Tester Voltmeter Tester will produce 5kVDC at the test leads to confirm proper operation of voltmeters and phasers. This tester should be used only with voltmeters/phasers that measure DC voltage. It will not confirm operation of voltmeters/phasers that measure AC voltage only. The PT-5000B operates from one 9V lithium or alkaline battery and produces approximately 5kVDC at the connecting leads. To use:

- 1) Connect both tester leads to the voltmeter/phasers probes or, for single stick voltmeters, one lead to the probe and one to the alligator clip on the end of the coil cord.
- 2) Press and hold both TEST buttons.
- 3) Confirm a good battery by checking the red light on the Tester. If the red light does not come on, replace the battery with a 9V lithium or alkaline only.
- 4) Verify the voltmeter/phasers reads approximately 5kV.
- 5) Release the TEST buttons and disconnect the Tester from the voltmeter/phasers.



PT-5000B

WARNING: Do not use the voltmeter/phaser if proper operation is not confirmed.

WARNING: Do not use this tester except as directed. Do not use to test equipment other than voltmeters/phasers. Do not apply to energized circuits or equipment. Refer all servicing to the factory. Failure to follow these instructions may lead to electric shock, severe injury or death.

Cable Fault Tester

The CFT-35 Cable Fault Tester is for use only with two stick voltmeters for testing leakage current in underground primary voltage cables.



The CFT-35 can be used on underground cables with grounded neutrals with a maximum line-to-ground voltage of 21.1kV or maximum line-to-line voltage of 36.6kV. Operation at higher voltages may damage the CFT-35 and provide erroneous test results.

The CFT-35 is used with a voltmeter/phaser for testing installed or repaired underground cable prior to energizing it. Only cable with extruded dielectric such as rubber or polyethylene can be tested with the CFT-35. Using the CFT-35 on paper insulated cable may provide erroneous test results caused by higher leakage currents typical for this type of cable.

The CFT-35 contains a high voltage rectifier and is connected to test underground primary cable as shown in this circuit:

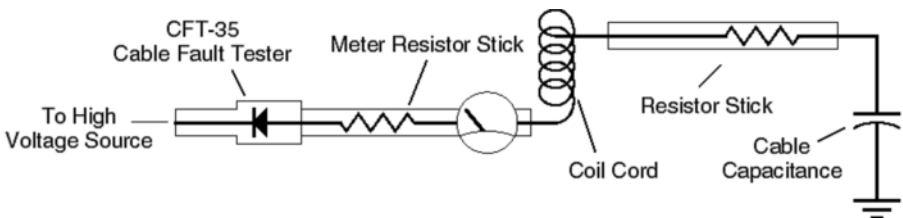

In practice, the CFT-35 rectifies the high voltage from the source, usually a transformer primary, and charges up the cable, shown as a capacitor above. When a connection is first made, the DC from the CFT-35 will charge up the cable capacitance through the resistors in the meter sticks. If the cable is good, current will stop flowing when the cable is charged up. If the cable is not good, the cable will not charge and current will continue to flow, as indicated by a higher meter indication.

The following equipment is required for testing cable with a CFT-35:

- 1) An HD Electric two-stick voltmeter/phaser.
- 2) The CFT-35 Cable Fault Tester.
- 3) For deadfront applications, ASP bushing probe(s) or, for live front applications, GCP-1 probe(s). An EA-15/25 elbow probe may also be used for deadfront applications.
- 4) For deadfront applications, a feed-through bushing may also be used.

PROBES AND ACCESSORIES *continued*

Shown here is a typical application of the CFT-35 and associated equipment for testing underground cable from a pad-mount dead front transformer:

Before using the CFT-35, read and understand all of the instructions and precautions for live testing with voltmeters/phasers (pages 10 & 11). In addition, be sure to consult your company's work practices and any information provided by the manufacturers of the apparatus that you are testing.

Testing using the CFT-35 should be performed as follows:

- 1) If using a multi-range voltmeter/phaser, select the appropriate range and install add-on resistor sticks if required.
- 2) Test the cable with the HDE voltmeter/phaser to ensure that it is not energized and that it is discharged.
- 3) Ensure that the cable to be tested is completely isolated; that both ends have no other connection to voltage or to a transformer winding and are properly terminated.
- 4) Assemble the CFT-35 with appropriate probe on the voltmeter/phaser stick **with the meter**.
- 5) Assemble the appropriate probe on the voltmeter/phaser stick **without the meter**.
- 6) Connect the voltmeter/phaser stick **without the meter** to the cable to be tested.
- 7) Connect the voltmeter/phaser stick **with the CFT-35** to the voltage source.
- 8) Read the display on the voltmeter/phaser. The reading will be initially high. For example, when testing a 12kV phase-to-phase cable, the line-to-ground voltage is approximately 7.2kV. The rectifier causes HALF that voltage to be displayed on the meter (3.6kV). For a short cable, the reading should return quickly to near zero. For a longer cable, it may take a few seconds for the reading to return to near zero.
- 9) If the reading does not return to near zero after several seconds, the cable is leaking or shorted and the test should be discontinued. Remember that all HDE voltmeters/phasers are intermittent duty devices and should be connected only as long as necessary to obtain a reading.
- 10) Discharge the cable by removing the voltmeter/phaser from the line, removing the CFT-35 from the voltmeter/phaser and connecting the voltmeter/phaser from cable to ground.

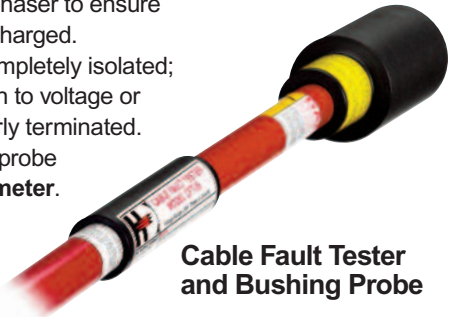
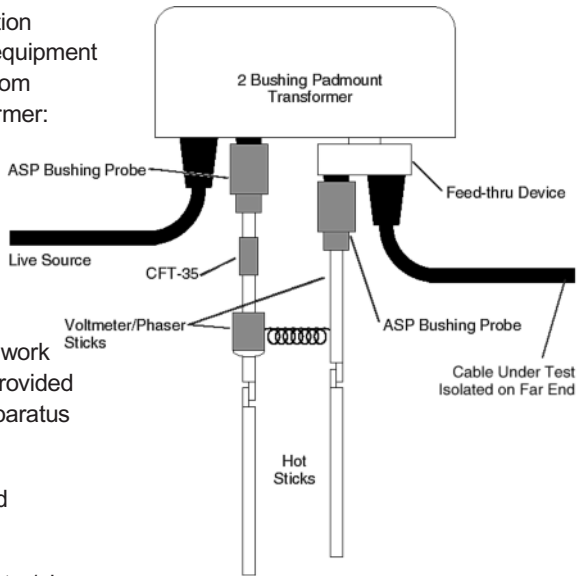

PROBES AND ACCESSORIES *continued*

USE of CFT-35 WITH DIGITAL vs. ANALOG METERS

Using the CFT-35 with digital voltmeters is not as intuitive as it is when used with analog meters. With a digital meter, if the cable is completely shorted the meter will read the line voltage times 0.71. This is different from the usual 50% voltage reading on an analog meter because the digital voltmeter is RMS reading. For a nominal 7.2kV circuit the meter will read approximately 5.1kV.

With an analog meter, if the cable is completely shorted the meter will read 50% of the applied voltage. For a nominal 7.2kV circuit the meter will read approximately 3.6kV. Listed here are the actual cable leakage currents for voltage readings on the DVM-80 digital meter and the MARK-V and MARK-IX analog meters.

Digital DVM-80

- Meter reading of 0.5kV = 8uA
- Meter reading of 1.0kV = 16uA
- Meter reading of 2.0kV = 31uA

Analog MARK-V, 15kV Scale

- Meter reading of 0.5kV = 38uA
- Meter reading of 1.0kV = 77uA
- Meter reading of 2.0kV = 153uA

Analog MARK-IX, 25kV Scale

- Meter reading of 0.5kV = 19uA
- Meter reading of 1.0kV = 38uA
- Meter reading of 2.0kV = 77uA

REPAIRS

If any damage is found please contact us at 800-435-0786 to arrange for service.

CALIBRATION AND MAINTENANCE LOG

DATE	CALIBRATED BY

TERMS AND CONDITIONS OF SALE

HD Electric Company is herein referred to either as "HDE" or "Seller" and the customer or person or entity purchasing goods or services (hereinafter collectively referred to as "Goods") is referred to as the "Buyer". These Terms and Conditions, any price list or schedule, quotation, acknowledgment or invoice from HDE relevant to the sale of the Goods and all documents incorporated by specific reference therein, constitute the complete and exclusive statement of the terms of the agreement governing the sale of Goods by HDE to Buyer. Buyer's acceptance of the Goods will manifest Buyer's assent to these terms and conditions without variation or addition. Any different or additional terms in Buyer's purchase order or other Buyer documents are hereby objected to. HDE reserves the right in its sole discretion to refuse orders.

1. PRICES AND TAXES: Unless a fixed price is quoted, the price at which the order is accepted is subject to adjustment to HDE's price in effect at the time of order. Any current or future tax or governmental charge (or increase in same) affecting Seller's costs or production, sale or delivery at which Seller is otherwise required to pay or collect in connection with the sale, purchase, delivery, storage, processing, use or consumption of Goods (but excluding any tax on Seller's net income or profit) shall be for Buyer's account and shall be added to the price.

2. TERMS OF PAYMENT: Terms are stated on HDE's invoice in U.S. currency. HDE shall have the right, among other remedies, either to terminate this agreement or to suspend further performance under this and/or other agreements with the Buyer in the event Buyer fails to make any payment when due, which other agreements Buyer and Seller hereby amend accordingly, or HDE otherwise deems itself insecure. Buyer shall be liable for all expenses, including attorney's fees, relating to the collection of just due amounts. Should Buyer's financial position become unsatisfactory to HDE, cash payments or security satisfactory to HDE may be required by HDE for future deliveries and for the goods thereafter delivered. If such cash payment or security is not provided, in addition to HDE's other rights and remedies, HDE may discontinue deliveries. HDE may apply a finance charge for payments made by credit card.

3. SHIPMENT AND DELIVERY: Unless otherwise expressly provided, shipments are made F.O.B. HDE's shipping point. Risk of loss or damage and responsibility shall pass from HDE to Buyer upon delivery to and receipt by common carrier. Any claims for shortages or damages suffered in transit are the responsibility of Buyer and shall be submitted by the Buyer directly to the carrier. Shortages or damages must be acknowledged and signed for at the time of delivery. While HDE will use all reasonable commercial efforts to maintain the delivery date(s) acknowledged or quoted by HDE, all shipping dates are approximate and not guaranteed. HDE reserves the right to make partial shipments. HDE, at its option, shall not be bound to tender delivery of any Goods or to provide shipping instructions. If the shipment of Goods is postponed or delayed by any reason, Buyer agrees to reimburse HDE for any and all handling and storage costs and other additional expenses resulting therefrom. All claims for shipping errors, lost shipments or any other discrepancies must be made within ninety (90) days or they will be disallowed and deemed waived.

4. HDE LIMITED WARRANTY: HDE covers its products with a manufacturer's warranty against defects in material or workmanship for a period of ten years in the case of Capacitor Controls and in all other circumstances for a period of one year, unless otherwise stated by HDE in writing. To take advantage of this warranty, the complete product must be delivered prepaid to HDE or any HDE Authorized Service Center. This warranty shall not apply to any Goods including but not limited to products which: (a) Have been repaired or altered outside HDE's factory (or Authorized Service Center) or in any manner so as, in HDE's judgment, to affect its serviceability or proper operation; (b) have been subjected by persons other than HDE (or Authorized Service Center) to improper handling, operation, maintenance, repair or alteration; and, (c) have been subjected to normal wear and tear and misuse, neglect, improper use, or accident. HDE's limited warranty shall be void if the Goods are repaired or altered by anyone other than HDE or its authorized service center. HDE's obligation to repair or replacement of any allegedly defective Goods or issuance of credit. HDE requires the return of any allegedly defective Goods, transportation prepaid, before honoring any claim. All returned Goods are subject to inspection, and if examination does not disclose any defect covered by this warranty, replacement of such Goods or issuance of credit for same will not be approved. THE FOREGOING CONSTITUTES HDE'S SOLE WARRANTY RESPONSIBILITY AND BUYER'S EXCLUSIVE REMEDY WHETHER SOUNDING IN TORT, CONTRACT, STRICT LIABILITY OR OTHERWISE, EXCEPT AS OTHERWISE EXPRESSLY SET FORTH IN THIS AGREEMENT. THERE ARE NO OTHER WARRANTIES, EXPRESS OR IMPLIED, WHETHER OF MERCHANTABILITY, FITNESS FOR A PARTICULAR PURPOSE, OR OTHERWISE. No employee, agent, dealer, or other person is authorized to give any warranty on behalf of HDE. This warranty extends only to persons or organizations who purchase the Goods from HDE for resale.

5. LIMITATION OF REMEDY AND LIABILITY; THE SOLE AND EXCLUSIVE REMEDY FOR BREACH OF ANY WARRANTY HEREUNDER SHALL BE LIMITED TO REPAIR, CORRECTION, REPLACEMENT OR CREDIT UNDER SECTION 4. HDE SHALL NOT BE LIABLE FOR DAMAGES CAUSED BY DELAY IN PERFORMANCE, AND IN NO EVENT, REGARDLESS OF THE FORM OF THE CLAIM OR CAUSE OF ACTION (WHETHER BASED IN CONTRACT, INFRINGEMENT, NEGLIGENCE, STRICT LIABILITY, OTHER TORT OR OTHERWISE), SHALL HDE'S LIABILITY TO BUYER AND/OR ITS CUSTOMERS EXCEED THE PRICE PAID BY BUYER FOR THE SPECIFIC GOODS GIVING RISE TO THE CLAIM OR CAUSE OF ACTION, AND BUYER SHALL INDEMNIFY HDE FOR ANY DAMAGES IN EXCESS THEREOF. BUYER AGREES THAT IN NO EVENT SHALL HDE'S LIABILITY TO BUYER AND/OR ITS CUSTOMERS INCLUDE SPECIAL, INDIRECT, INCIDENTAL, CONSEQUENTIAL OR PUNITIVE DAMAGES OF ANY CHARACTER IN CONNECTION WITH THE SALE, RESALE OR USE OF THE GOODS, WHICH ARE WAIVED BY BUYER AND AS TO WHICH BUYER SHALL INDEMNIFY HDE. The term "consequential damages" shall include, but not be limited to, loss of anticipated profits, business interruption, loss of use of revenue, cost of capital or loss of or damage to property, equipment, or data, or loss of reputation. Further, Buyer shall indemnify and hold HDE harmless from any liability to Buyer, Buyer's employees, workers, contractors or any other persons arising out of Buyer's, and any other persons', use of the Goods. All instructions and warnings supplied by HDE will be passed on to those persons who use the Goods. HDE's Goods are to be used in their recommended applications and all warning labels adhered to the Goods by HDE shall be left intact. It is impossible to eliminate all risks associated with the use of the Goods. Risks of serious injury or death, including risks associated with electrocution, arc flash and formal burn, are inherent in work in and around energized electrical systems. Such risks arise from the wide variety of electrical systems and equipment to which Goods have no applicability, the manner of use or application, weather and environmental conditions or other unknown factors, all of which are beyond the control of HDE. HDE does not agree to be an insurer of these risks, and shall have no liability for any claims arising from such risks. WHEN YOU BUY OR USE THESE PRODUCTS, YOU AGREE TO ACCEPT THESE RISKS.

6. EXCUSE OF PERFORMANCE (FORCE MAJEURE): HDE shall not be liable for delays in performance or for non-performance due to acts of God; acts of Buyer; war; fire; flood; weather; sabotage; strikes, labor disputes, civil disturbances or riots; governmental restrictions, restrictions, allocations, laws, regulations, orders or actions; unavailability of or delays in transportation; default of suppliers; or unforeseen circumstances or events beyond HDE's reasonable control. Deliveries or other performance may be suspended for an appropriate period or cancelled by HDE upon notice to Buyer in the event of any of the foregoing, but the balance of this agreement shall otherwise remain unaffected. If HDE determines that its ability to supply the total demand for the Goods, or to obtain material used directly or indirectly in the manufacture of the Goods, is hindered, limited or made impracticable due to causes set forth herein, HDE may allocate its available supply of the Goods or such material (without obligation to acquire other supplies of any such Goods or materials) among itself and its purchasers on such basis as HDE determines to be equitable without liability for any failure of performance which may result therefrom.

7. CHANGES: HDE reserves the right to change designs and specifications for standard Goods without prior notice to Buyer, but not with respect to custom Goods being made for Buyer. HDE shall have no obligation to install or make such change in any Goods manufactured prior to the date of such change.

8. ASSIGNMENT: Buyer shall not assign its rights or delegate its duties hereunder or any interest herein without the prior written consent of HDE, and any such assignment, without such consent, shall be void.

9. INSTALLATION: Buyer shall be responsible for receiving, inspecting, testing, storing, installing, starting up and maintaining all Goods.

10. INSPECTION/TESTING: Buyer, at its expense, agrees that it will promptly inspect the Goods upon receipt thereof, and in no event later than thirty (30) days from the date of receipt of the Goods. Buyer shall deliver to HDE within fifteen (15) days of inspection, but in no event later than forty-five (45) days from the date of receipt of the Goods, written notice of any and all deficiencies, defects, variations from specifications or complaints of any kind with respect to the quantity, quality, condition, shipment, performance, price or appearance of the Goods so received by Buyer, and the extent of such written notice as received by HDE. Buyer shall be deemed conclusively to have inspected and accepted all such Goods unconditionally and to have waived any and all rights and claims, including without limitation any right to reject the Goods or to claim damages in respect thereof. Buyer may not return goods without first advising HDE of the reasons therefor, obtaining from HDE a material authorization number and observing such instructions as HDE may give in authorizing such return. In the event a return is authorized by HDE, a restocking for any Goods requiring repackaging or maintenance a twenty percent (20%) restocking fee shall be assessed to Buyer in the final credit amount.

11. SERVICES: If this agreement requires HDE to perform or provide any services, HDE (including without limitation its successors, assigns, agents or any person or entity acting at HDE's direction) shall not be responsible for any damages, claims, liabilities or expenses of any nature arising out of such services.

12. U.S. EXPORT CONTROL LAWS: All Goods sold to Buyer by HDE hereunder are subject to U.S. Export Control Laws. Buyer hereby agrees not to re-sell or divert any goods contrary to such laws.

13. COMPLIANCE: Seller/Contractor shall comply with all applicable federal, state or local laws, rules, regulations, or orders. Seller/Contractor shall comply with Executive Order 11246, as amended by Executive Order 11375, and the applicable provisions of the Office of Federal Contract Compliance Programs (OFCCP), 41 CFR Part 60, which are incorporated herein by this reference. Buyer shall comply with all applicable federal, state, or local laws, rules, regulations or orders including but not limited to the Foreign Corrupt Practices Act of 1977, as amended. HDE reserves the right to delay or refuse delivery if requests for reasonable assurances of Buyer's compliance are not tendered as requested.

14. MISCELLANEOUS: These terms and conditions supersede all other communications, negotiations and prior oral or written statements regarding the subject matter hereof. No change, modification, rescission, discharge, abandonment, or waiver of these terms and conditions shall be binding upon HDE unless made in writing and signed on its behalf by its duly authorized representative. No conditions, usage or trade, course of dealing or performance, understanding or agreement purporting to modify, vary, explain, or supplement these terms and conditions shall be binding unless hereafter made in writing and signed by Seller. No modification shall be effected by HDE's receipt or acceptance of Buyer's purchase orders, shipping instruction forms, or other documentation containing terms at variance with or in addition to those set forth herein, all of which are objected to by HDE. Any such modifications or additional terms are specifically rejected by HDE. No waiver by HDE with respect to any breach or default of any right or remedy and no course of dealing, shall be deemed to constitute a continuing waiver of any other breach or default of any other right or remedy, unless such waiver be expressed in writing and signed by HDE. All typographical or clerical errors made by HDE in any quotation, acknowledgment or publication are subject to correction. Validity and performance relating to the interpretation and effect of this agreement shall be governed by the laws of the state of Illinois without regard to its conflict of law principles.

15. DISPUTE RESOLUTION: In the event of any dispute INCLUDING, BUT NOT LIMITED TO, BREACH OF CONTRACT, BREACH OF WARRANTY, CLAIMS BASED IN TORT, NEGLIGENCE, PRODUCT LIABILITY, FRAUD, MARKETING, STATE OR FEDERAL REGULATIONS, ANY CLAIMS REGARDING THE ENFORCEABILITY OF THIS LIMITED WARRANTY, AND THE WAIVER OF CLASS ACTION TRIALS between Buyer and Seller, either may choose to resolve the dispute by binding arbitration, as described below, instead of in court. THIS MEANS IF EITHER BUYER OR SELLER CHOOSE BINDING ARBITRATION, NEITHER PARTY SHALL HAVE THE RIGHT TO LITIGATE SUCH CLAIM IN COURT OR HAVE A JURY TRIAL. DISCOVERY AND APPEAL RIGHTS ARE LIMITED IN BINDING ARBITRATION. Buyer and Seller agree that the proper venue of Arbitration is not to be chosen by Buyer or Seller of all actions arising in connection herewith shall be only in the state of Illinois and the parties agree to submit to such jurisdiction. No action, regardless of form, arising out of transactions relating to the agreement, may be brought by either party more than two (2) years after the cause of action has accrued. The U.N. Convention on Contracts for the International Sales of Goods shall not apply to this agreement.

16. CLASS ACTION WAIVER: BINDING ARBITRATION MUST BE ON AN INDIVIDUAL BASIS. THIS MEANS NEITHER BUYER NOR SELLER MAY JOIN OR CONSOLIDATE CLAIMS IN ARBITRATION BY OR AGAINST OTHERS, OR LITIGATE IN COURT OR ARBITRATE ANY CLAIMS AS A REPRESENTATIVE OR MEMBER OF A CLASS OR IN A PRIVATE ATTORNEY GENERAL CAPACITY. ADMINISTRATION OF ARBITRATION: The binding arbitration shall be administered by the American Arbitration Association ("AAA") in accordance with its Commercial Arbitration Rules and/or Supplementary Procedures for Consumer-Related Disputes (including proceedings to mitigate costs of AAA). This binding arbitration is governed by the Federal Arbitration Act ("FAA") (9 USC §1, et. seq.) and will govern the interpretation and enforcement. The binding arbitration shall be held at a location determined by AAA, or at such other location as mutually agreed. In addition to the terms stated above, the following will apply to the binding arbitration: (1) the arbitrator, and not any federal, state, or local court or agency, will have exclusive authority to resolve any dispute relating to the interpretation, applicability, enforceability or formation of this Agreement including any claim that all or any part of this Agreement is void or voidable; (2) the arbitrator shall apply Illinois law consistent with the FAA.

HD Electric Company is committed to ongoing review and improvement of its product lines, and thus reserves the right to modify product design and specifications without notice.

HD Electric Company® products are available through HDE® sales representatives worldwide.

HD Electric products receive final assembly and shipment from HDE's production facility at

Suite 400 - 4320 Executive Drive, Southaven, MS 38672.

HD Electric Company is ISO 9001:2015 certified

Printed in U.S.A. © HD Electric Company 2020 • Bulletin No. VOLTMETER IM-600A