

V-WATCH®

PERSONAL VOLTAGE DETECTOR

Operating & Instruction Manual



U.S. Patents 6,329,924, 9,265,331,
and D622,956

Making the Invisible Visible™

HDE® HD ELECTRIC COMPANY
A Textron Company



1475 Lakeside Drive • Waukegan, Illinois 60085 U.S.A. • 847.473.4980
fax 847.473.4981 • website: www.HDElectricCompany.com



Call Us 1.877.571.7901

V-WATCH®

PERSONAL VOLTAGE DETECTOR

Operating & Instruction Manual

GENERAL DESCRIPTION	4
POINTS TO UNDERSTAND BEFORE PROCEEDING	4
SAFETY	5
WARNINGS	5
HOW IT WORKS	5
HOW TO WEAR IT	6
WHEN AND HOW TO USE IT	6
A WORD ABOUT ELECTRIC FIELDS	7-8
LIMITATIONS FOR USE	9
V-WATCH PERSONAL VOLTAGE DETECTOR MODELS	10
INSTRUCTIONS FOR USE	10-11
TECHNICAL SPECIFICATIONS	11-12
WARNING DISTANCES	12-13
ACCESSORIES	14
LIMITATION OF WARRANTY AND LIABILITY	16

For the latest information on V-Watch Personal Voltage Detectors including product updates and technical information, visit our website at www.HDElectricCompany.com



GENERAL DESCRIPTION

The V-Watch Personal Voltage Detectors detect the strong electric fields surrounding high voltage conductors and power distribution equipment. It is a small pocket size device worn on the outside of the clothing or other protective gear by users operating near power lines or high voltage equipment. It provides an extra level of safety for personnel trained in the use and application while working on or near high voltage systems.



The V-Watch Personal Voltage Detector detects electric fields. Make sure you understand these points before proceeding:

- Electric fields surround every energized AC conductor.
- The closer you are to a conductor, the stronger the field will be.
- Higher voltage means a stronger electric field and a greater warning distance. Lower voltage means a reduced warning distance.
- Electric fields are NOT blocked by plastics, dry wood or clothing.
- Electric fields ARE blocked by ANY conductor such as a metal cabinet or door, wet wood, metal fences, green trees, a growing shrub or hedge and tall wet grass.
- The detector will not find cables buried under the ground. The ground is a conductor and will block electric fields.
- Insulation on a wire does not block the electric field and does not affect warning distances.
- Underground primary cables are both insulated AND shielded. The shield is a conductor, is grounded, and will block the electric field.
- Molded cable terminators such as elbows are, like the cables they are installed on, both insulated and shielded and will block electric fields.
- Your body will block electric fields. Wear the detector front and center and do not walk backwards.
- Do not use the detector while holding it in your hand. Wrapping your fingers around the device will block electric fields, preventing it from working properly.

SAFETY

- Always use proper high voltage procedures, including personal protective equipment, when working near or around high voltage equipment or conductors.
- Do not rely on the detector as your sole source of high voltage detection. Risk of electrocution is inherent in or around high voltage.
- Never contact high voltage with the detector.
- Always use proper high voltage procedures for testing and grounding.
- Because the human body is a good electrical conductor, electric fields are distorted or blocked by the body. Thus, positioning of the detector on the body and its location relative to the voltage source can have a large effect on its sensitivity to electric fields.
- Grounded equipment can appear to be live in close proximity to energized conductors.
- The V-Watch Personal Voltage Detector is not sensing electric fields when it is inside its closed carrying case.

WARNINGS



All V-Watch Personal Voltage Detector carrying cases are electrically shielded, therefore, the device does not work when inside its closed carrying case.



NOT FOR USE BELOW 2400 VOLTS AC.

OPERATIONAL IMPAIRMENT

If the detector is used in a manner not described in this instruction manual, the protection and effective operation of this equipment may be impaired.

The detector will not detect DC voltage or stored charge such as in charged capacitors or underground cable. When the detector is inside its closed case, it will not detect or warn of nearby high voltage. Always use proper high voltage procedures, including personal protective equipment, when working near or around high voltage equipment or conductors. Never contact high voltage. Always use proper high voltage procedures for testing and grounding. Do not rely on the V-Watch Personal Voltage Detector as your sole source of high voltage detection. Risk of electrocution is inherent in or around high voltage.

HOW IT WORKS

The V-Watch Personal Voltage Detector works by sensing the presence of the electric field surrounding anything that potentially conducts high voltage electricity and sounds an alarm. It measures the strength of the electric field; a higher voltage or stronger field will cause the detector to alarm from a greater distance.

It emits a series of loud beeps and flashing lights when an electric field is first detected. The beeps and flashing lights increase in frequency as the user approaches the source of the high voltage electric field. A steady tone indicates very close proximity to high voltage and the need for extreme caution. This variable beeping rate helps the user to determine if they are approaching the high voltage source or moving away from it to safety.

The detector has a self-test button to verify battery power and proper functioning of the device. It will also sound an alarm to warn the user of a low battery. Whenever the detector is being used, it is always on, checking for the presence of high voltage electric fields. A standard 9-volt alkaline battery powers the unit for about one year.

For more information, refer to the A Word About Electric Fields section on page 7.

HOW TO WEAR IT

The V-Watch Personal Voltage Detector should always be worn mid-torso on the front of the body and face in the direction of movement. Because it is sensitive to electric fields in front of the user, and to a lesser extent on either side, proper positioning is important.

V-Watch Personal Voltage Detectors can be worn in three different ways:

1. When using the detector with the C-10 Case Lanyard, fully unzip the carrying case so that the case opens downward and the detector is now facing forward. Extend the lanyard from the top of the case and hang it around your neck. Adjust the lanyard so the detector in the case is located at mid-torso and facing forward.
2. When using the detector with the VW-LAN Lanyard, remove the detector from its case and securely affix it using the metal clip on the back of the detector to the hanging loop on the front of the lanyard. Hang the lanyard around your neck and adjust by using the Velcro so the detector is located at mid-torso and facing forward.
3. The last option is using the detector with the metal mounting clip and securing it on clothing or other devices such as fall protection gear so it is located at mid-torso and facing forward.

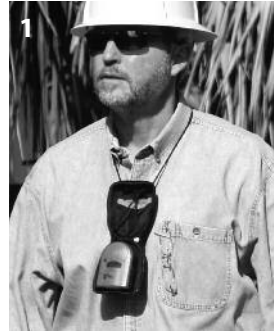

WHEN AND HOW TO USE IT

The V-Watch Personal Voltage Detector can be used anytime, anywhere and for any reason. The decision of when to use it is made by the user and by your company's safety and work practices.

When used properly, the detector can provide an additional warning to users exposed or working around energized high voltage electricity and equipment. Awareness of the presence of a high voltage electric field allows the user to take additional precautions against accidental contact with energized equipment. The variable frequency beeping gives the user an indication of the source and direction of the high voltage.

The detector provides an early warning of the proximity of potentially hazardous high voltage electricity and equipment. It will start to beep slowly as an electric field is first detected and will then beep faster, increasing to a steady tone if the user continues to approach the source of the high voltage electric field. A steady tone indicates the need for extreme caution, as the source of the high voltage electric field is close.



A WORD ABOUT ELECTRIC FIELDS

Electric fields surround every energized conductor. The V-Watch Personal Voltage Detector measures the strength of these electric fields to warn the user when fields are strong enough to indicate the presence of nearby voltage conductors.

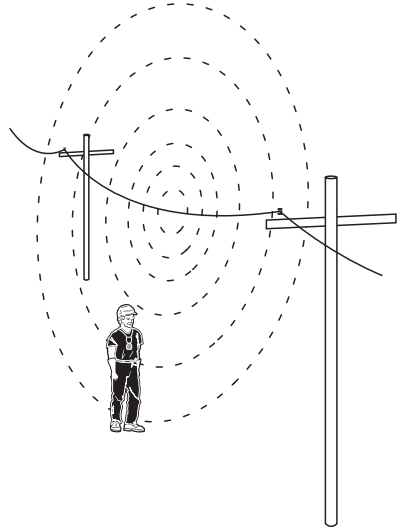

A downed power line is a typical hazardous situation where the detector can provide a warning. This power line lying on the ground sets up a high voltage field surrounding the conductor that the detector will sense and warn the user.

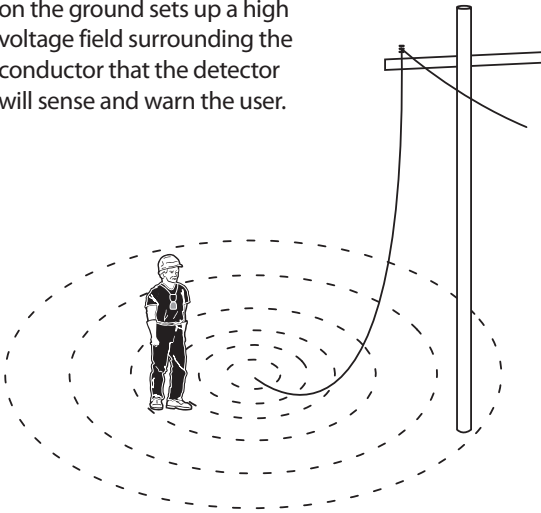

The detector is designed to be worn on the body and it measures the electrical fields typically found in close proximity to the body. Because the human body is a good electrical conductor, electric fields are distorted or even blocked by the body. Thus, positioning of the detector on the body and its location relative to the voltage source can have a large effect on its sensitivity to electric fields.

When properly worn on the front of the body, as shown, and with the user facing a waist height energized conductor, such as a terminal on a pad mount transformer or switch, the detector will start to alarm about 10 feet from a 7kV conductor. If the user were to approach this energized terminal by backing up to it, the warning distance may be reduced to 3 feet or less.

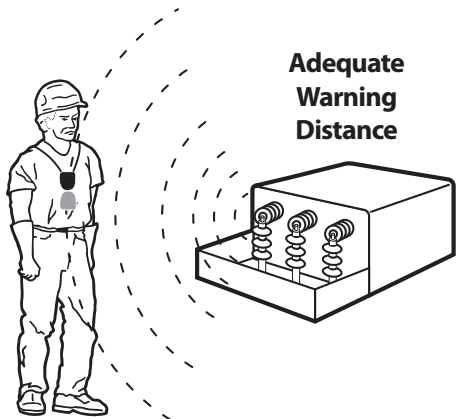

If the user bends over from the waist to reach towards an energized high voltage terminal, the warning distance may also be significantly reduced. In both cases, the high conductivity of the body acts as a shield to conduct the electric field around the detector.

The V-Watch Personal Voltage Detector measures only the strength of the electric field. It cannot directly measure distance to the source of the electric field such as an energized conductor. The higher the voltage, the stronger the

field and the greater the alarm distance. The reverse is also true; the detector may alarm due to the very close proximity of low voltage when the user walks past a typical factory machine such as a running drill press, an office computer terminal or a desk lamp. It may even alarm if it is placed up against a typical 120 volt wall outlet.

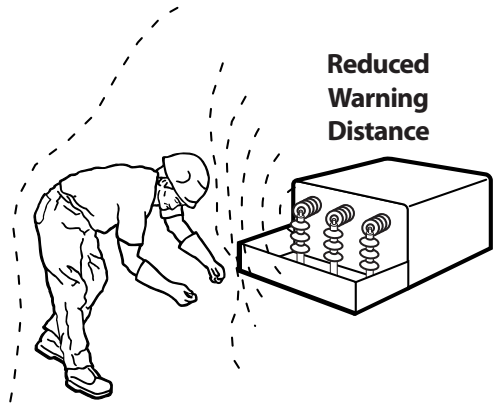

Electrically conductive objects located underneath power lines can appear to be live. A metal fence or a growing hedge can cause a distortion of the electric field under these lines and result in high electric field strength near the ground. The V-Watch Personal Voltage Detector will provide an early warning of high electric fields, but not all fields are directly caused by nearby energized objects. To prevent the detector from issuing too many false alarms, it should not be used or worn in typical office or factory environments where all the equipment is low voltage and there is no danger of contacting energized high voltage conductors.

As an additional protection against false alarms from transient voltages, the detector has a built-in time delay and may take up to one second to emit an alarm warning of high voltage. For this reason, a user running towards an energized high voltage source may find the warning distance reduced.

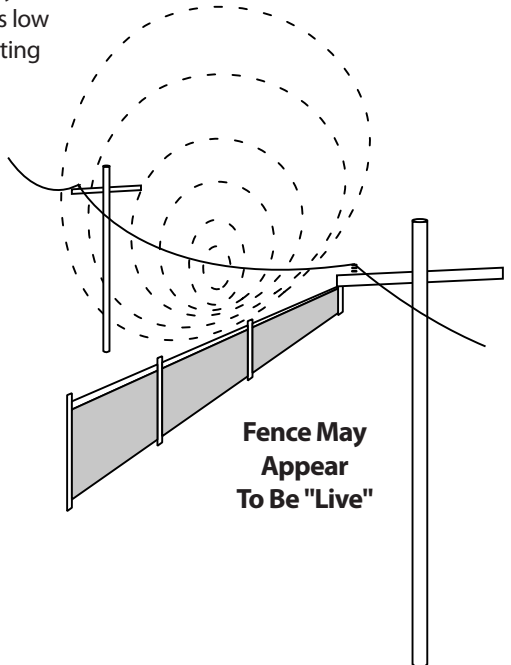

LIMITATIONS FOR USE



WARNING: Conductors lying on the ground or very close to it will result in reduced warning distances.

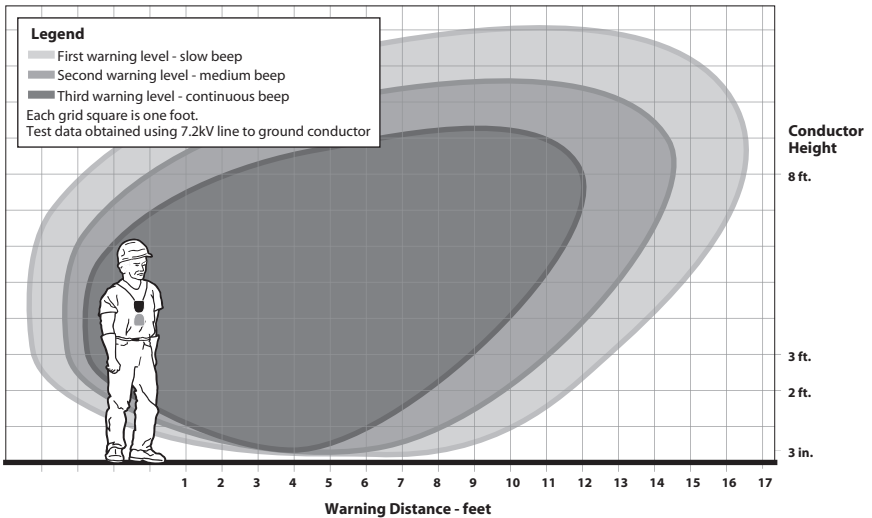
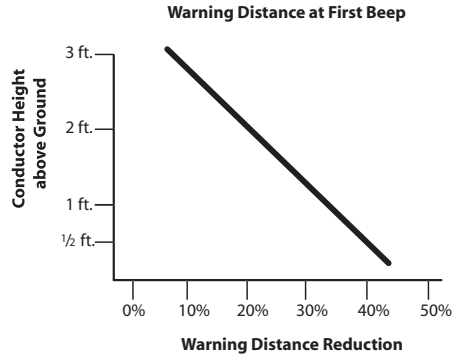

Conductors of different phases in close proximity will also reduce warning distances due to field cancellation effects.

Wearing the V-Watch Personal Voltage Detector in environments such as substations or under transmission lines may result in the detector alarming continuously.



Be aware of unique conditions that may be present around three phase delta systems. Unlike grounded Y systems, a single phase of a delta system can become grounded without causing an outage and the delta system can continue to operate with this grounded phase. If this phase is grounded as a result of a downed conductor or other storm damage, it may be grounded only temporarily and could become reenergized if moved or disturbed. **The V-Watch Personal Voltage Detector will not detect any grounded conductor, whether it is a grounded delta phase conductor, a guy wire or a pole ground.**



WARNING: Treat all conductors as live unless or until there is a visible break from a live source and a ground is in place.

V-WATCH PERSONAL VOLTAGE DETECTOR MODELS

There are two models available of the V-Watch Personal Voltage Detector. Both feature audible and visual alarms, a low battery indicator, built-in self-test, field replaceable 9V battery, ruggedized housing, belt clip and carrying case.

The Pro version includes all of the same features, but also includes a Mute button which temporarily silences the beeper. The Mute feature may be used when it is necessary to work for a prolonged period in or around high voltage electricity while wearing the detector.

INSTRUCTIONS FOR USE



NOT FOR USE BELOW 2400 VOLTS AC.

Before using, read the instruction manual, review product labeling and both sides of the instruction card located in the case. Do not proceed if the instruction card is missing. Make certain that the detector is equipped with a 9-volt battery. Press the Test button on the front of the detector before and after each use. The test circuitry generates an internal voltage which the detector then detects by turning on the lights and sounding the beeper. DO NOT USE the detector if the Test button fails to activate the lights and beeper. Remove from service and contact the factory to arrange for repair.





CAUTION – Press and hold the Test button before and periodically during as well as after each use to ensure proper operation.

The detector should always be worn facing any potential high voltage electricity. Wear the detector in the center of the front of your body as shown in the illustration and always wear in the direction of movement or work. Do not walk backwards or sideways when wearing the detector as it will not detect high voltage behind you or as effectively to the sides. Wear on the outside of all clothing. Keep it away from all other large metal objects such as belt buckles, tool belts or electronic items such as radios, pagers, cell phones or any other electrical devices which may interfere with the detector.

The detector will emit a series of beeps and flashing lights when it detects high voltage. It will beep and flash faster as it gets closer to high voltage. Very rapid beeping and flashing or a steady tone and lights indicates close proximity to high voltage and requires extreme caution. For more details, refer to Warning Distances beginning on page 12.

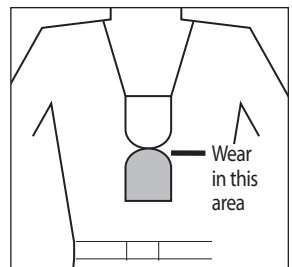
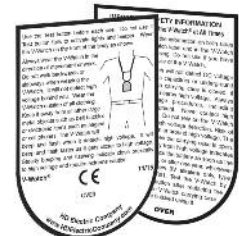
Instruction Cards - Front & Back



V-Watch  **Electric Field Detector**
Read instructions before use. Use Test button before each use. Do not use if Test button fails to activate lights and beeper. Short beeping away from high voltage indicates low battery. Wear outside of all clothing and away from metal objects. Place on front of body in direction of work, this side towards body. Mute button temporarily silences beeper. Use with extreme caution as high voltage is nearby.
WARNING: Do not rely on this device as your only indication of high voltage.
DANGER: Lights and beeper indicate proximity to high voltage and associated risks of arcing and electrocution.
©2-11-17H
www.HDElectricCompany.com US Pat 6,329,924 Made in USA

V-Watch Pro  **Electric Field Detector**
Read instructions before use. Use Test button before each use. Do not use if Test button fails to activate lights and beeper. Short beeping away from high voltage indicates low battery. Wear outside of all clothing and away from metal objects. Place on front of body in direction of work, this side towards body. Mute button temporarily silences beeper. Use with extreme caution as high voltage is nearby.
WARNING: Do not rely on this device as your only indication of high voltage.
DANGER: Lights and beeper indicate proximity to high voltage and associated risks of arcing and electrocution.
www.HDElectricCompany.com US Pat 6,329,924 Made in USA

The V-Watch Pro model includes an added mute feature. The Mute button temporarily silences the beeper. This feature may be used when it is necessary to work for a prolonged period in or around high voltage conductors. The Mute will operate only if activated during a warning beep or a few seconds after a warning beep has occurred. While the beeper is Muted, the lights will continue to flash. The Mute can be canceled by pressing the Test button. Use the Mute with extreme caution as high voltage is nearby. After 3 to 5 minutes, the Mute function is canceled and the detector returns to normal alarm operation.

When the V-Watch Personal Voltage Detector is in use with a good working battery, it is always on, always ready to warn of potentially hazardous high voltage. The battery life is approximately one year on the job or two years in storage. When the job requiring the protection of the detector for the user is completed, the detector should be closed inside its protective carrying case. The carrying case is electrically shielded and turns the V-Watch detector off when it is stored inside.



CAUTION: The V-Watch Personal Voltage Detector is not sensing electric fields when it is inside its closed carrying case.

The V-Watch Personal Voltage Detector will indicate if it has a low battery. When the battery gets low the beeper and lights are activated. The beeper will give a constant tone and the lights remain lit indicating the battery needs to be replaced (the same indication as pressing the Test button). The low battery signal will continue until the battery is completely discharged or removed. When this happens, the detector is no longer operational until the 9-volt battery is replaced.

To replace the battery, completely remove the detector from the case and access the battery through the door on the back. Disconnect and dispose of the old battery, replacing it with a fresh, new 9-volt alkaline battery. Be sure to connect the proper battery polarity and carefully manage the wire leads to avoid pinching between the battery door and the body while replacing the cover. Press and hold the Test button to confirm proper operation. If after changing the battery the test button fails to confirm proper operation, DO NOT USE. Remove it from service and contact the factory to arrange for repair.

CLEANING

To clean, wipe with a damp cloth with water. Do not use harsh chemicals or solvents.

TECHNICAL SPECIFICATIONS

SENSITIVITY: Factory set at 50/60 Hz sensing threshold (first beep). The detector will only detect AC voltage. Do not use below 2400 Volts.

TYPICAL WARNING DISTANCE: 7 feet (2.13m) from a 4kV AC conductor. For more details, refer to Warning Distances beginning on page 12.

OPERATING FREQUENCY: 50Hz/60Hz

BATTERY: 9V alkaline 1604A, IEC 6LR61. Life 2 years in storage, one year typical usage.

BEEPER SOUND PRESSURE LEVEL: 100 db.

WEIGHT WITH BATTERY: 5.2 oz (147g)

DIMENSIONS: 3.5" (8.89cm) x 2.8" (7.32cm) x 1.2" (3.18cm)

VOLTAGE RANGE: 2400VAC and above.

ENCLOSURE MATERIAL: ABS UL 94-HB

PRINTED CIRCUIT BOARDS: FR-4 UL94V-0

ENVIRONMENTAL CONDITIONS

CONDITIONS: Indoor and outdoor use

ALTITUDE: Up to 6,566 ft. (2000M)

OPERATING TEMPERATURE: -20°F to +120°F (-29°C to +49°C)

HUMIDITY: 95% to 49°C (non-condensing)

OVERVOLTAGE CATEGORY: II Non-contact

POLLUTION DEGREE: PD4

MANUFACTURING LOCATION

HD Electric Company • Waukegan, IL. 60085, USA

WARNING DISTANCES

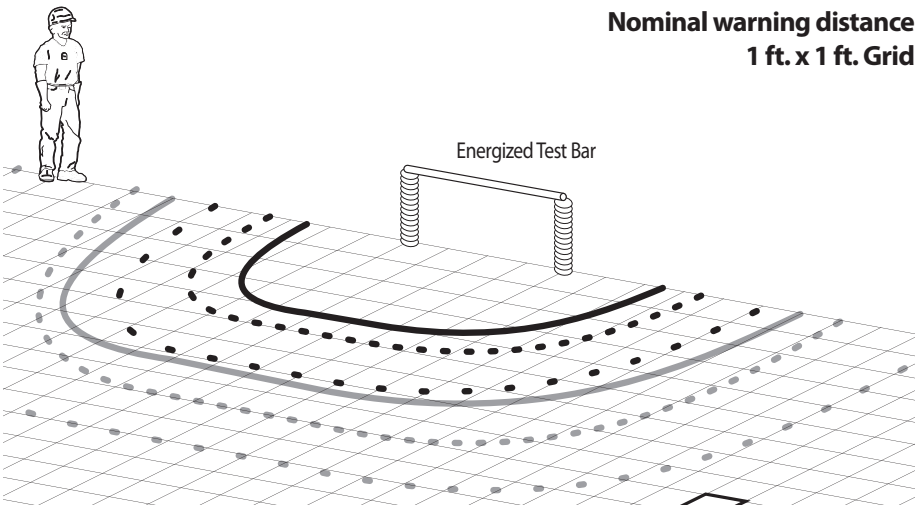

Test Details

All of the warning distances are shown on a 1 foot grid and all distances are to scale.

The energized bar is 4 feet long and 30 inches above the ground on insulators. It is energized from behind and the indicated voltage is line to ground.

Voltage: 2.4kV Line-Ground			
Location	Slow Beep	Fast Beep	Continuous
Side of Bar	7 ft.	5 ft.	4 ft.
End of Bar	5 ft.	3.5 ft.	2.5 ft.

Test Voltage 7.2kV Line-Ground			
Location	Slow Beep	Fast Beep	Continuous
Side of Bar	11 ft.	9 ft.	7 ft.
End of Bar	10 ft.	7 ft.	6 ft.

For this test, the V-Watch Personal Voltage Detector VW-20/VWP-20 was worn on the shirt front as pictured. Warning distances will be reduced slightly if it is worn on the belt and will be reduced substantially if an arm is extended toward the energized source or if the user approaches the energized source backwards.

WARNING DISTANCES

Nominal warning distance 1 ft. x 1 ft. Grid

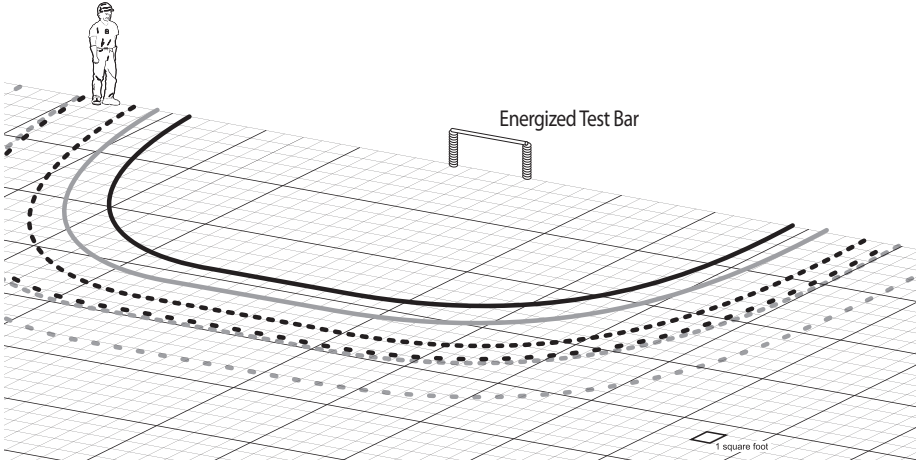

Test Details

All of the warning distances are shown on a 1 foot grid and all distances are to scale.

The energized bar is 4 feet long and 30 inches above the ground on insulators. It is energized from behind and the indicated voltage is line to ground.

For this test, the V-Watch Personal Voltage Detector model VW-20/VWP-20 was worn on the shirt front as pictured. Warning distances will be reduced slightly if it is worn on the belt and will be reduced substantially if an arm is extended toward the energized source or if the user approaches the energized source backwards.

Voltage: 14.4kV Line-Ground				
Location	Slow Beep	Fast Beep	Continuous	
Side of Bar	20 ft.	18 ft.	14 ft.	
End of Bar	20 ft.	18 ft.	14 ft.	

Test Voltage 19.9kV Line-Ground				
Location	Slow Beep	Fast Beep	Continuous	
Side of Bar	23 ft.	20 ft.	16 ft.	
End of Bar	23 ft.	20 ft.	16 ft.	

ACCESSORIES

V-Watch Personal Voltage Detectors come standard with a C-10 Case Lanyard, a 9-volt battery, instruction card and instruction manual.

VW-LAN Lanyard and Neck Strap

Adjustable lanyard allows the detector to be worn around the neck and positions unit at mid-chest level. Color is safety orange.

VW-K-BAG Carrying Bag

Safety orange zippered carrying bag (included in kits). Holds detector in case, VW-LAN lanyard and instruction manual.

Carrying Case Lanyards

Two versions available – can be used with any model

- C-10FR Carrying Case Lanyard – high-visibility safety green shielded material with an outer layer of flame resistant material
- C-10 Carrying Case Lanyard – black shielded material

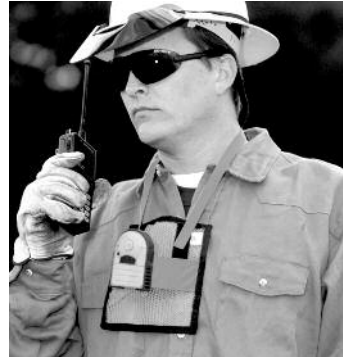

VW-LAN LANYARD AND NECK STRAP



VW-K-BAG CARRYING BAG

C-10 CARRYING CASE LANYARDS





Call Us 1.877.571.7901

LIMITED WARRANTY AND LIMITATION OF LIABILITY

This warranty applies to all products sold by HD Electric Company (the "Products"); provided, however, that the term Products does not include any third party products purchased through HD Electric Company, for which no warranties are made (the "Third Party Products"). Third Party Products may be subject to a separate manufacturer's warranty; [should you have any question regarding whether a separate warranty applies, please contact HD Electric Company].

NOTICE: READ THIS LIMITATION OF WARRANTY AND LIABILITY BEFORE BUYING OR USING THE PRODUCTS CONTAINED HEREIN.

It is impossible to eliminate all risks associated with the use of the Products. Risks of serious injury or death, including risks associated with electrocution, arcing and thermal burns, are inherent in work in and around energized electrical systems. Such risks arise from the wide variety of electrical systems and equipment to which Products may be applied, the manner of use or application, weather and environmental conditions or other unknown factors, all of which are beyond the control of HD Electric Company.

HD Electric Company does not agree to be an insurer of these risks, and shall have no liability for any claims arising from such risks.

WHEN YOU BUY OR USE THESE PRODUCTS, YOU AGREE TO ACCEPT THESE RISKS.

HD Electric Company warrants to the original purchaser that the Products (excluding any third party products purchased through HD Electric Company, for which no warranties are made) will be free from defects in material and workmanship, under normal use and regular service, and preventative maintenance for a period of one (1) year (ten (10) years for HDE Capacitor Controls) from the date of shipment (the "Warranty Period"). Should any failure to conform with this warranty be found during the Warranty Period, you must notify HD Electric Company of your claim within thirty (30) days of discovery, and within the Warranty Period. Your failure to give notice of claims of breach of warranty within the Warranty Period shall be deemed an absolute and unconditional waiver of claims for such defects. HD Electric Company will have no responsibility to honor claims received after the date the applicable Warranty Period expires.

Upon notice of your claim, HD Electric Company will provide a return authorization number, and further instructions on how to return the product for service. You must follow HD Electric Company's instruction. You are responsible for all Product removal, handling, re-installation, and shipping (both to and from HD Electric Company). Products returned for repair, as well as repaired or replacement Products shall be sent postage / freight prepaid. After receipt of a product which HD Electric Company determines is defective, HD Electric will, at its option, either (1) repair (or authorize the repair of) the Product or (2) replace the Product, subject to the following: The Products are made using parts sourced from a variety of manufacturers. Due to the rapidly changing technology environment, parts may become obsolete / unavailable over time (end of life). In the event that a Product cannot be repaired or replaced due to unavailability of parts, HD Electric Company will use commercially reasonable efforts to obtain substitute parts or conduct work around design, but cannot guarantee its ability to do so.

Items not found defective will be returned at your expense, or failing receipt of instruction from you on return of such items within five (5) business days of our notice to you that the product is not defective, HD Electric may dispose of the product at its discretion and with no liability to you. HD Electric Company's determination of defects is final. Products repaired or replaced during the Warranty Period shall be covered by the foregoing warranties for the remainder of the original Warranty Period or ninety (90) days from the date of delivery of the repaired or replaced Products, whichever is longer.

LIMITATIONS:

This warranty is void in the event of misuse, alteration, faulty installation, or misapplication of the product.

This warranty does not cover failure of product or components due to any ACT OF NATURE; lightning, floods, hurricanes, tornadoes or any other such catastrophic events.

HD Electric Company does not warrant any third party products or associated hardware or their performance or suitability for use and application. Such items are provided "as-is".

All repairs must be authorized by HD Electric Company. Unauthorized repairs will not be reimbursed under any circumstances.

HD Electric Company is not required to make replacement or loaner equipment available while Products are being repaired or replaced, or to compensate you for any in/out labor charges or expenses associated with removal, handling or re-installation of the Products.

TO THE MAXIMUM EXTENT PERMITTED BY LAW, THIS WARRANTY AND THE REMEDIES SET FORTH ABOVE ARE EXCLUSIVE AND IN LIEU OF ALL OTHER WARRANTIES, REMEDIES AND CONDITIONS, WHETHER ORAL OR WRITTEN, EXPRESS OR IMPLIED. HD ELECTRIC EXPRESSLY DISCLAIMS ALL OTHER WARRANTIES OF ANY KIND, EXPRESS OR IMPLIED, INCLUDING WITHOUT LIMITATION IMPLIED WARRANTIES OF FITNESS FOR A PARTICULAR PURPOSE, MERCHANTABILITY AND NON-INFRINGEMENT.

IN NO EVENT SHALL HD ELECTRIC COMPANY BE LIABLE FOR ANY INDIRECT, INCIDENTAL, CONSEQUENTIAL OR SPECIAL DAMAGES RESULTING FROM THE USE OR HANDLING OF THESE PRODUCTS. THIS SHALL INCLUDE BUT, NOT LIMITED TO, LOST PROFITS OR REVENUE, LOSS OF USE OF THE PRODUCTS, COST OF SUBSTITUTE PRODUCTS, FACILITIES OR SERVICES, OR DOWNTIME.

IN NO EVENT SHALL HD ELECTRIC COMPANY HAVE ANY LIABILITY FOR ANY THIRD PARTY PRODUCTS OR ASSOCIATED HARDWARE, OR CUSTOMER-OWNED SYSTEMS, EQUIPMENT OR SOFTWARE.

HD Electric Company must have prompt notice of any claim so that an immediate product inspection and investigation can be made. Buyer and all users shall promptly notify HD Electric Company of any claims, whether based on contract, negligence, strict liability, or other tort or otherwise be barred from any remedy.

HD Electric Company is committed to ongoing review and improvement of its product lines, and thus reserves the right to modify product design and specifications without notice.

HD Electric Company® products are available through HDE® sales representatives worldwide.

Printed in U.S.A. © HD Electric Company 2017 • Bulletin No. VWATCH IM-600h