

VOLTMETER/PHASER

and ACCESSORIES

Operating & Instruction Manual



Call Us 1.877.571.7901



HDE HD ELECTRIC COMPANY
A Textron Company

1475 Lakeside Drive • Waukegan, Illinois 60085 U.S.A. • 847.473.4980
fax 847.473.4981 • website: www.HDElectricCompany.com

VOLTMETER/PHASER

and ACCESSORIES

Operating & Instruction Manual

IMPORTANT SAFETY INFORMATION	3
GENERAL DESCRIPTION	4
MODELS and SPECIFICATIONS	5-9
Voltmeters - Analog Meters	5
Voltmeters & Phasers - Analog Meters	5-6
Voltmeters & Phasers - Digital Meters	7-9
DigiVolt I through DigiVolt V	7
DigiVolt 25T	8
DigiVolt 80	9
OPERATING INSTRUCTIONS	10-11
Pre-Use Inspection	10
Voltage and Phasing Measurements: Line-to-Line	10
Voltage Measurements: Line-to-Ground	11
Test Point Measurements	11
Care and Maintenance	11
PROBES AND ACCESSORIES	12-15
Probes	12
Proof Tester	12
Cable Fault Tester	13-15
REPAIRS	15
CALIBRATION AND MAINTENANCE LOG	15
WARRANTY AND LIABILITY	16

IMPORTANT SAFETY INFORMATION

Read and understand these instructions prior to use. These operating instructions are not a substitute for proper training in the use of this equipment. High voltage systems present serious hazards, including the risk of death or serious injury due to arcing, thermal burns and electrocution. HD Electric's products are intended solely for use by professionals with knowledge, training and experience in the use of the equipment and its accessories in and around high voltage systems.

All applicable federal, state, company and OSHA work practices must be followed. If you are unfamiliar with the work practices required, **DO NOT PROCEED**. Call HD Electric Company if you have any questions regarding this equipment.

**THESE IMPORTANT LABELS ARE AFFIXED TO VARIOUS PRODUCTS.
READ AND UNDERSTAND EACH OF THEM BEFORE PROCEEDING.**

DigiVolt™
Meter Display HV

NOTICE: Use only with insulated hot sticks and use correct probes for overhead and underground applications. This product is designed for use by professionals trained in its use and application in and around high voltage electric equipment. If you are not trained in the work methods required for safe operation, do not proceed until you obtain the training.

CAUTION: Do not exceed 400V without extension resistors. Install one R-80 extension resistor on each stick for readings to 80kV and multiply display reading x 2. Test on known voltage source before and after each use. Inspect connecting cord and return meter to HD Electric Company for repair if cord or other meter components are worn or damaged. Keep connecting cord free and clear of all obstructions and grounded surfaces during application.

WARNING: Regional hot stick work practices and all OSHA and company work practices must be followed. Always wear approved insulated gloves, eye and face protection and PPE clothing. Do not touch meter housing during measurement. Read and understand instructions prior to use. Failure to follow these instructions or other misuse or misapplication can lead to severe injury or death.

Replace battery with 9V Alkaline only

Part No. DVM-80 Serial No.

www.HDElectricCompany.com

DigiVolt™ 80

NOTICE: Use only with insulated hot sticks and use correct probes for overhead and underground applications. This product is designed for use by professionals trained in its use and application in and around high voltage electric equipment. If you are not trained in the work methods required for safe operation, do not proceed until you obtain the training.

CAUTION: Do not exceed 400V without extension resistors. Install one R-80 extension resistor on each stick for readings to 80kV and multiply display reading x 2. Test on known voltage source before and after each use. Inspect connecting cord and return meter to HD Electric Company for repair if cord or other meter components are worn or damaged. Keep connecting cord free and clear of all obstructions and grounded surfaces during application.

WARNING: Regional hot stick work practices and all OSHA and company work practices must be followed. Always wear approved insulated gloves, eye and face protection and PPE clothing. Do not touch meter housing during measurement. Read and understand instructions prior to use. Failure to follow these instructions or other misuse or misapplication can lead to severe injury or death.

Replace battery with 9V Alkaline only

Part No. DVM-80 Serial No.

www.HDElectricCompany.com

DANGER
ELECTRIC SHOCK HAZARD
ELECTRICAL ARC HAZARD

READ INSTRUCTIONS AND OPERATIONS MANUAL BEFORE USE

Always wear personal protective equipment including eye and face protection, including gloves and PPE clothing. All OSHA and company work practices must be followed. Always maintain proper working clearances. Use only HD Electric probes appropriate and intended for the work to be performed.

This product is designed for use by professionals trained in the use and application in and around high voltage electrical equipment. If you are not trained in the work methods required for safe operation, DO NOT PROCEED until you obtain the proper training. Failure to follow these recommended practices may result in severe burns, serious injury or death.

HD Electric Company
www.hdelectriccompany.com Phone: (847) 473-4982

WARNING
HOT STICK REQUIRED
WARNING

DANGER

Keep Connecting Cord
Free and Clear of Everything
At All Times During Operation.

See Instructions #VMCWL-96

All meters require the use of accessory hotsticks, which may or may not be supplied with the meter. The minimum hotstick length required for safe use depends upon the particular operation; consult federal, state, company and OSHA specifications for the proper hotstick length for the intended operation.

The users of this meter should always be equipped with personal protective equipment including high voltage gloves, flame retardant clothing, eye and face protection. Some applications may require additional protective equipment.

Accessory probes are available for all meters. Always use the proper probe(s) for your application.

Failure to follow these and other warnings and safety precautions may result in severe injury or death.

GENERAL DESCRIPTION

All HD Electric voltmeters and phasers are constructed with epoxy encapsulated high voltage resistors, a connecting cord and a meter display. The meter display may be digital or analog. The major elements are shown here:

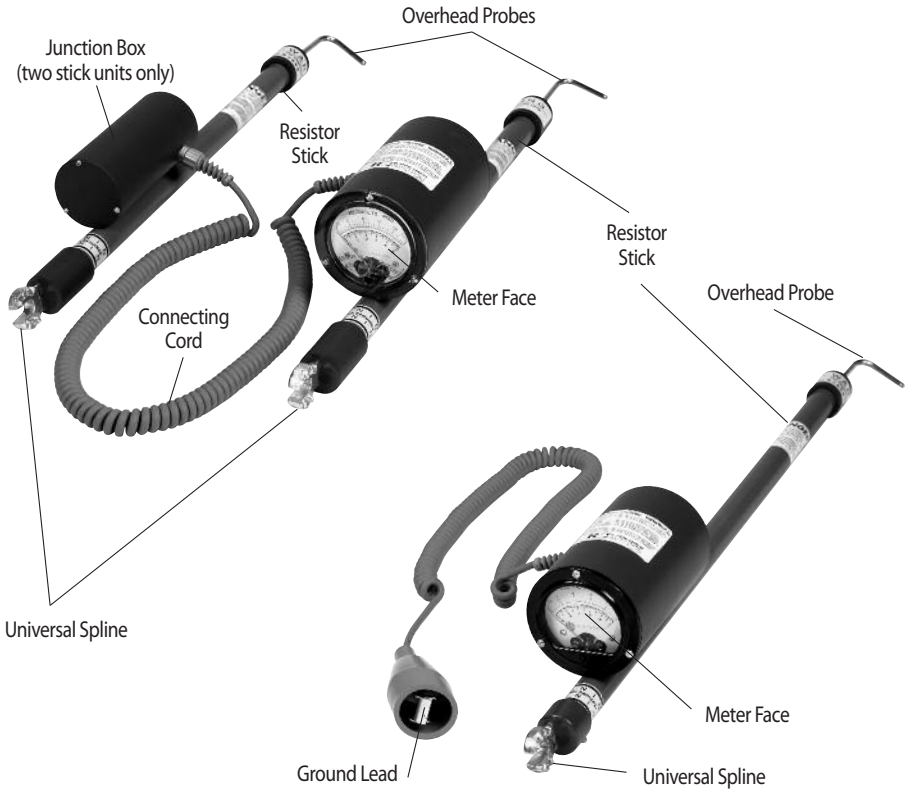

The high voltage resistors limit the current through the connecting cord to a maximum of about one milliamp. Although the connecting cord is insulated for voltage up to 10kV, it should always be kept free and clear from you, ground and any other conductors. These instruments will measure DC through 1000Hz RMS AC.

WARNING: Single stick voltmeters can be used for line-to-ground measurements only. The alligator clip on the end of the coil cord must always be connected to ground prior to making high voltage measurements and should be removed from ground only after high voltage measurements are completed. Two stick voltmeters can be used for both line-to-ground and line-to-line voltage measurements.

WARNING: Some models have range switches or require add-on resistor sticks for higher voltage ranges. Always completely remove the voltmeter from the live circuit before changing the range switch position or adding or removing add-on resistor sticks. Always use add-on resistor sticks in pairs, one on each voltmeter stick.

MODELS AND SPECIFICATIONS

VOLTMETERS – Analog Meters

LINE-TO-GROUND MEASUREMENTS ONLY

ALL ANALOG MODELS MEASURE DC THROUGH 1000HZ AC.

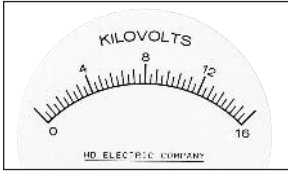

EM-1 Scale

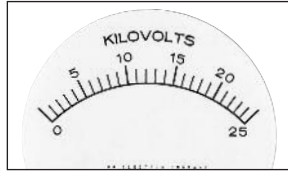

EM-2 Scale

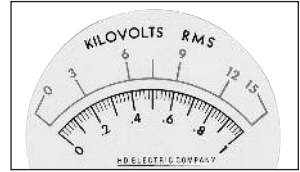

EM-3 Scale

EM-1 – Single stick, Single range: 0 - 16kV, line-to-ground only

- The alligator clip on the cord must be connected only to ground or system neutral.

EM-2 – Single stick, Single range: 0 - 25kV, line-to-ground only

- The alligator clip on the cord must be connected only to ground or system neutral.

EM-3 – Single stick, Dual range: 0 - 1kV and 0 - 15kV line-to-ground only

- The alligator clip on the cord must be connected only to ground or system neutral.
- Measure on the 1kV scale with the selector switch set for LO range.
- Measure on the 15kV scale with the selector switch set for HI range.

VOLTMETERS & PHASERS – Analog Meters

LINE-TO-GROUND AND LINE-TO-LINE MEASUREMENTS

ALL ANALOG MODELS MEASURE DC THROUGH 1000HZ AC.

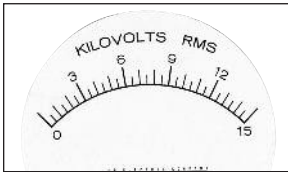

Mark I Scale

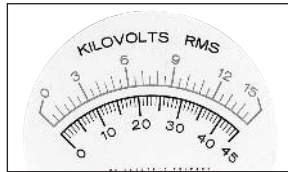

Mark II Scale

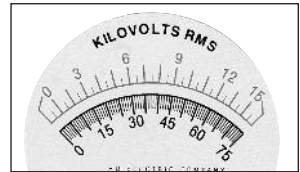

Mark III Scale

MARK I – Dual stick, Single range: 0 - 15kV

MARK II – Dual stick, Dual range: 0 - 15kV and 0 - 45kV

- Measure on the 15kV scale with the selector switch set for LO range.
- Measure on the 45kV scale with the selector switch set for HI range.

MARK III – Dual stick, Dual range: 0 - 15kV & 0 - 75kV with included R-75 add-on resistor sticks

- Measure on the 15kV scale with the selector switch set for LO range and without the add-on resistor sticks.
- Measure on the 75kV scale with the selector switch set for HI range and with the add-on resistor sticks installed, one on each meter stick.

MODELS AND SPECIFICATIONS *continued*

VOLTMETERS & PHASERS – Analog Meters (continued)

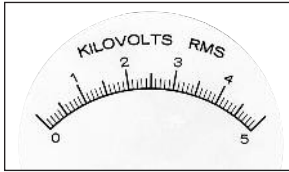

Mark IV Scale

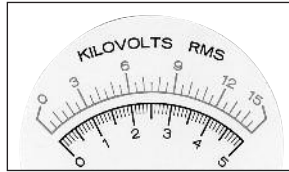

Mark V Scale

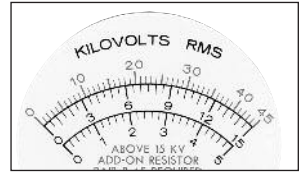

Mark VI Scale

MARK IV – Dual stick, Single range: 0 - 5kV

MARK V – Dual stick, Dual range: 0 - 5kV and 0 - 15kV

- Measure on the 5kV scale with the selector switch set for LO range.
- Measure on the 15kV scale with the selector switch set for HI range.

MARK VI – Dual stick, Triple range: 0 - 5kV, 0 - 15kV and 0 - 45kV

with included R-45 add-on resistor sticks

- Measure on the 5kV scale with the selector switch set for LO range and without the add-on resistor sticks.
- Measure on the 15kV scale with the selector switch set for HI range and without the add-on resistor sticks.
- Measure on the 45kV scale with the selector switch set for HI range and with the add-on resistor sticks installed, one on each meter stick.

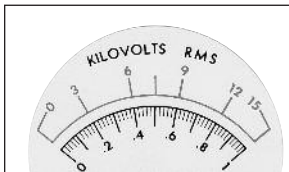

Mark VII Scale

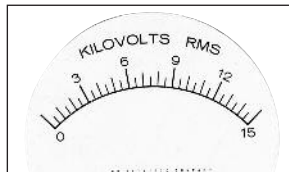

Mark VIII Scale

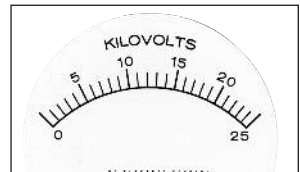

Mark IX Scale

MARK VII – Dual stick, Dual range: 0 - 1kV and 0 - 15kV

- Measure on the 1kV scale with the selector switch set for LO range.
- Measure on the 15kV scale with the selector switch set for HI range.

MARK VIII – Single stick/dual stick, Single range: 0 - 15kV

- Can be used for line-to-ground measurements only with single stick and connecting cord with alligator clip. Convert from one stick voltmeter to two stick voltmeter/phasor for both line-to-ground and line-to-line measurements by removing the coil cord with alligator clip and installing cord connected to second resistor stick.

MARK IX – Dual stick, Single range: 0 - 25kV

MARK XI – Dual stick, Dual range: 0 - 5kV and 0 - 25kV

- Measure on the 5kV scale with the selector switch set for LO range.
- Measure on the 25kV scale with the selector switch set for HI range.

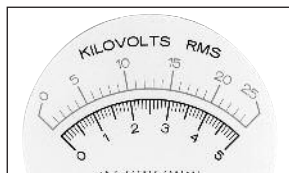

Mark XI Scale

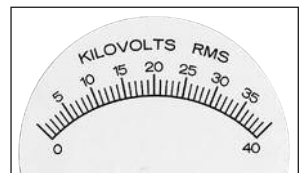

Mark XII Scale

MARK XII – Dual stick, Single range: 0 - 40kV

MODELS AND SPECIFICATIONS *continued*

VOLTMETERS & PHASERS – Digital Meters **DigiVolt Models I, II, III, IV and V**

The DVM Models I through V require two 9V lithium or alkaline batteries, which should be replaced at the same time when the battery indication icon (🔋) appears on the display. The DVM I through V have a single button to turn the unit on. This button is pressed again to toggle the backlight on and off. The backlight and



Front



Back

meter will shut off automatically after a few minutes, but not while voltage measurements are being made. Some models include a peak hold feature, which is displayed as a blinking decimal point ($\langle \times \rangle$). The display will hold the maximum voltage reading until it is reset. The meter will not shut-off if it is holding a reading. These models have a large 0.75" LCD display that indicates 3-1/2 digits. All models measure DC through 1000Hz RMS AC.

DVM I – Single stick, Single range: 150V - 19.99kV line-to-ground only

- The alligator clip on the cord must be connected only to ground or system neutral.
- Includes Peak Hold. Press the Peak Hold button once to activate this feature and once again to clear the reading. A blinking decimal point ($\langle \times \rangle$) confirms activation of Peak Hold.
NOTE: The meter will not shut off while a peak reading is being displayed.

DVM II – Dual stick, Dual range, auto ranging: 150V - 19.99kV and 20.0 - 50.0kV

- Includes Peak Hold. Press the Peak Hold button once to activate this feature and once again to clear the reading. A blinking decimal point ($\langle \times \rangle$) confirms activation of Peak Hold.
NOTE: The meter will not shut off while a peak reading is being displayed.

DVM III – Single stick, Single range: 150V - 19.99kV line-to-ground only

- The alligator clip on the cord must be connected only to ground or system neutral.
- Includes Peak Hold. Press the Peak Hold button once to activate this feature and once again to clear the reading. A blinking decimal point ($\langle \times \rangle$) confirms activation of Peak Hold.
NOTE: The meter will not shut off while a peak reading is being displayed.
- Includes Test Point Measurement. Press the Test Point button once to activate this feature and once again to shut it off. A display icon (⚠) confirms Test Point mode.

DVM IV – Dual stick, Dual range, auto ranging: 150V - 19.99kV and 20.0 - 50.0kV

- Includes Peak Hold. Press the Peak Hold button once to activate this feature and once again to clear the reading. A blinking decimal point ($\langle \times \rangle$) confirms activation of Peak Hold.
NOTE: The meter will not shut off while a peak reading is being displayed.
- Includes Test Point Measurement. Press the Test Point button once to activate this feature and once again to shut it off. A display icon (⚠) confirms Test Point mode.

DVM V – Dual stick, Single range: 150V - 19.99kV

MODELS AND SPECIFICATIONS *continued*

VOLTMETER – Digital Meters **DigiVolt Model 25T**



The DVM-25T is a compact, single stick version of the DigiVolt voltmeters. It requires one 9V lithium or alkaline battery, which powers the unit and activates the backlight. The meter will shut off automatically a few minutes after the display reads zero, but not while voltage measurements are being made. The DVM-25T includes an elbow test point reading feature, which is displayed by a blinking decimal point (>.). The backlight is always on when the unit is powered on. The low battery feature will simply shut off or will not turn on the meter when the battery is low. The unit has a 0.4" LCD display that indicates 3-1/2 digits. The DVM-25T measures RMS AC and DC.

DVM 25T – Single stick, Dual range, auto ranging:

50V – 19.99kV and 20.0kV – 25.0kV line-to-ground only

- The alligator clip on the cord must be connected only to ground or system neutral.
- Includes Test Point Measurement. Press the ON button again to activate this feature and once again to shut it off. A blinking decimal point (>.) confirms Test Point mode.



Call Us 1.877.571.7901

MODELS AND SPECIFICATIONS *continued*

VOLTMETERS & PHASERS – Digital Meters **DigiVolt Model 80**



The DVM-80 is the compact version of the DigiVolt voltmeters. It requires one 9V lithium or alkaline battery, which powers the unit and activates the backlight. The meter will shut off automatically a few minutes after the display reads zero, but not while voltage measurements are being made. The DVM-80T includes an elbow test point reading feature, which is displayed by a blinking decimal point (\times). The backlight is always on when the unit is powered on. The low battery feature will simply shut off or will not turn on the meter when the battery is low. The unit has a 0.4" LCD display that indicates 3-1/2 digits. The DVM-80 measures RMS AC and DC.

DVM 80 – Dual stick, Dual range, auto ranging: 50V – 19.99kV and 20.0kV – 40.0kV

Can be used up to 80kV with optional R-80 add-on resistor sticks.

- To take readings above 40.0kV, attach one R-80 on each meter stick, and then multiply the reading on the display by two (for example, if the display reads 30kV with add-on resistor sticks installed, multiply 30 times 2 = 60.0kV).

DVM 80T – Dual stick, Dual range, auto ranging: 50V - 19.99kV and 20.0kV - 40.0kV

Can be used up to 80kV with optional R-80 add-on resistor sticks.

- Includes Test Point Measurement. Press the ON button again to activate this feature and once again to shut it off. A blinking decimal point (\times) confirms Test Point mode.
- To take readings above 40.0kV, attach one R-80 on each meter stick, and then multiply the reading on the display by two (for example, if the display reads 30kV with add-on resistor sticks installed, multiply 30 times 2 = 60.0kV).

OPERATING INSTRUCTIONS

Pre-Use Inspection

WARNING: Before using the instrument be sure to test and inspect the equipment to insure that it is functioning properly and is in safe, working condition. Failure to do so may cause serious injury or death and may result in erroneous test measurements.

Before making any high voltage measurements, test and inspect the voltmeter/phaser as follows:

- 1) Make certain the instrument is clean, dry and waxed to a clear shiny surface.
- 2) Inspect the cord for cracked insulation.
- 3) Be sure that you are using hotsticks of the appropriate length, and examine each hotstick to insure that it is clean, dry and waxed to a clear shiny surface.
- 4) Attach the appropriate probes for overhead or underground applications (see page 12) and ensure that the probes are properly installed and tightened (do not overtighten).
- 5) If you are using a multi-range meter, confirm that the range switch is in the proper position.
- 6) Install add-on resistor sticks if necessary for the range being tested.
- 7) Test the voltmeter/phaser with a proof tester such as the HD Electric PT-5000B (see page 12).

Voltage and Phasing Measurements – Line-to-Line

We recommend that two person crews perform all line-to-line voltage measurements and phasing operations. Since the operation is occurring near two energized conductors, the use of two person crews allows each person to operate one meter stick and maintain high safety standards.

In order to make line-to-line measurements, each probe must contact an energized line. Be sure that only those probes intended for the particular application are used (see page 12). Always keep the connecting cord free and clear of energized phases and ground.

For phasing applications, the probes will be placed on opposite sides of an open point, typically a switch. The phasing operation will indicate if two sides of a line are in-phase before closing a switch.

To check all phases proceed as follows:

- 1) Measure voltage on each phase from line-to-ground to verify all phases are live and at the same voltage.
- 2) Place one of the probes on a conductor on one side of the switch.
- 3) Place the other probe on one of the three phases on the other side of the switch.
- 4) If the conductors are out-of-phase, the meter will read line-to-line voltage. If they are in-phase, the meter will read near zero but may read up to 15% of the line-to-line voltage.
- 5) Continue this procedure with all three phases on both sides of the switch.

If an intermediate reading is found, the phasing cannot be determined by this method and the switch should not be closed until other means are used for phasing.

OPERATING INSTRUCTIONS *continued*

Voltage Measurements – Line-to-Ground

To use a one-stick voltmeter with ground lead, first clip the ground lead on either a ground or system neutral. The resistor stick probe can then be connected to the energized source to be measured. Keep the connecting cord free and clear while testing and disconnect the ground clip only after removing the meter probe from the voltage source.

To use a two-stick voltmeter/phaser, first connect one of the probes to either a ground or system neutral making sure the resistor stick is making contact at all times during measurement. The other probe should be connected to the energized source to be measured.

Maintain contact only long enough to read the meter. Always remove the probe from the energized source first before removing the ground connection.

TEST POINT MEASUREMENTS

Some of the digital voltmeters include a Test Point feature for measuring voltage from elbow test points. On DigiVolt Models DVM III and DVM IV a button on the back of the housing turns this feature on and is shown as (⚠) on the display. To activate Test Point mode on the DVM-25T and DVM-80T simply push the ON button again. Test Point mode is indicated by a blinking decimal point. To turn Test Point mode off, simply push the ON button once again and the decimal point will stop blinking. When using a DigiVolt to phase between test points, the important measurement is whether high voltage is present or not. The proper procedure for phasing between elbow test points is as follows:

- 1) Both elbows must be energized. Follow the proper safety practices for removing the test point protective caps and exposing the live test points. Treat all exposed electrodes as energized high voltage. Measure from both elbow test points to ground. These measurements should show that both elbows are energized and, if both elbows are of the same type and manufacture, should measure the approximate line voltage.
- 2) Measure from one elbow test point to the other. This reading will show either a high voltage reading indicating the elbows are out-of-phase or a zero or low voltage reading indicating the elbows are connected to the same phase. The out-of-phase measurement will likely not show the higher voltage expected from a phase-to-phase measurement but will be closer to the line-to-ground voltage. The in-phase voltage measurement can be between zero and 15% of the nominal line-to-ground voltage. If both elbows are of different type and manufacture, then a higher reading may occur.

CARE AND MAINTENANCE

Periodic regular maintenance is required to keep the voltmeter in proper operating condition. Digital models will require periodic battery replacement. Keep the voltmeter clean and dry and always store it in its case. The fiberglass sticks should be kept clean and free of dirt, contamination and marking. Examine the cord for cracking or other damage prior to each use. Although we don't specify a calibration cycle, we recommend you test, measure and calibrate your instrument annually. The Calibration and Maintenance Log provided on page 15 can be used to record these events. Contact HD Electric Company for details.

PROBES AND ACCESSORIES

WARNING: ALWAYS use probes appropriate to your application. NEVER use overhead probes in underground applications. Failure to use the correct probe can result in arcing or electrical contact and may cause serious injury or death. If you are not trained in the particular operation or are not sure about the appropriate probe for your application **DO NOT PROCEED.**

Overhead Probes

- OLPS-5 brass hook probe
- OLPS-6 brass pigtail probe



Underground Dead Front Bushing Probes

- ASP-15/25 for use in 15kV and 25kV loadbreak bushings
- ASP-35U for use in 35kV loadbreak bushings

Underground Elbow Probe

- EA-15/25 for insertion in loadbreak elbows.

NOTE: The elbow must be firmly supported when using this probe.

Insulated Underground Probe

- GCP-1 for general underground use on grounded terminals, exposed high voltage terminals or elbow test points.

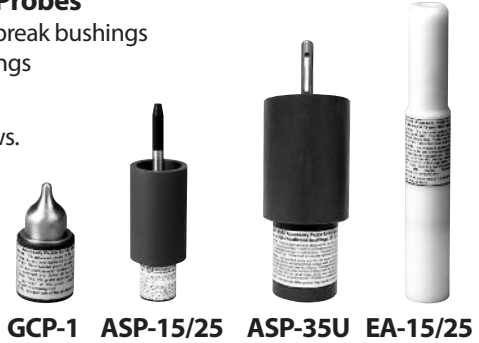

PROOF TESTER

The PT-5000B Proof Tester will produce 5kVDC at the test leads to confirm proper operation of voltmeters and phasers. This tester should be used only with voltmeters/phasers that measure DC voltage. It will not confirm operation of voltmeters/phasers that measure AC voltage only. The PT-5000B operates from one 9V lithium or alkaline battery and produces approximately 5kVDC at the connecting leads. To use:

- 1) Connect both tester leads to the voltmeter/phaser probes or, for single stick voltmeters, one lead to the probe and one to the alligator clip on the end of the coil cord.
- 2) Press and hold both TEST buttons.
- 3) Confirm a good battery by checking the red light on the Tester. If the red light does not come on, replace the battery with a 9V lithium or alkaline only.
- 4) Verify the voltmeter/phaser reads approximately 5kV.
- 5) Release the TEST buttons and disconnect the Tester from the voltmeter/phaser.



PT-5000B Proof Tester

WARNING: Do not use the voltmeter/phaser if proper operation is not confirmed.

WARNING: Do not use this tester except as directed. Do not use to test equipment other than voltmeters/phasers. Do not apply to energized circuits or equipment. Refer all servicing to the factory. Failure to follow these instructions may lead to electric shock, severe injury or death.

PROBES AND ACCESSORIES *continued*

The CFT-35 is for use only with two stick voltmeters for testing leakage current in underground primary voltage cables.



The CFT-35 can be used on underground cables with grounded neutrals with a maximum line-to-ground voltage of 21.1kV or maximum line-to-line voltage of 36.6kV. Operation at higher voltages may damage the CFT-35 and provide erroneous test results.

The CFT-35 is used with a voltmeter/phaser for testing installed or repaired underground cable prior to energizing it. Only cable with extruded dielectric such as rubber or polyethylene can be tested with the CFT-35. Using the CFT-35 on paper insulated cable may provide erroneous test results caused by higher leakage currents typical for this type of cable.

The CFT-35 contains a high voltage rectifier and is connected to test underground primary cable as shown in this circuit:

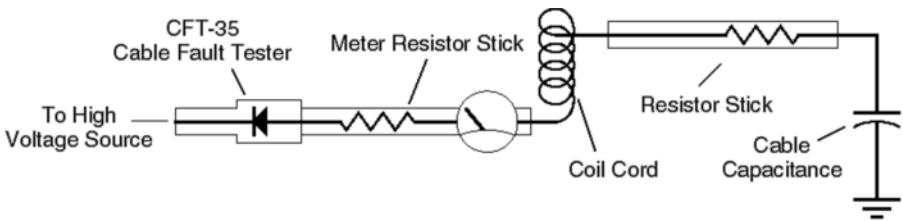

In practice, the CFT-35 rectifies the high voltage from the source, usually a transformer primary, and charges up the cable, shown as a capacitor above. When a connection is first made, the DC from the CFT-35 will charge up the cable capacitance through the resistors in the meter sticks. If the cable is good, current will stop flowing when the cable is charged up. If the cable is not good, the cable will not charge and current will continue to flow, as indicated by a higher meter indication.

The following equipment is required for testing cable with a CFT-35:

- 1) An HD Electric two-stick voltmeter/phaser.
- 2) The CFT-35 Cable Fault Tester.
- 3) For deadfront applications, ASP bushing probe(s) or, for live front applications, GCP-1 probe(s). An EA-15/25 elbow probe may also be used for deadfront applications.
- 4) For deadfront applications, a feed-through bushing may also be used.

PROBES AND ACCESSORIES *continued*

Shown here is a typical application of the CFT-35 and associated equipment for testing underground cable from a pad-mount dead front transformer:

Before using the CFT-35, read and understand all of the instructions and precautions for live testing with voltmeters/phasers (pages 10 & 11). In addition, be sure to consult your company's work practices and any information provided by the manufacturers of the apparatus that you are testing.

Testing using the CFT-35 should be performed as follows:

- 1) If using a multi-range voltmeter/phaser, select the appropriate range and install add-on resistor sticks if required.
- 2) Test the cable with the HD voltmeter/phaser to insure that it is not energized and that it is discharged.
- 3) Insure that the cable to be tested is completely isolated; that both ends have no other connection to voltage or to a transformer winding and are properly terminated.
- 4) Assemble the CFT-35 with appropriate probe on the voltmeter/phaser stick **with the meter**.
- 5) Assemble the appropriate probe on the voltmeter/phaser stick **without the meter**.
- 6) Connect the voltmeter/phaser stick **without the meter** to the cable to be tested.
- 7) Connect the voltmeter/phaser stick **with the CFT-35** to the voltage source.
- 8) Read the display on the voltmeter/phaser. The reading will be initially high. For example, when testing a 12kV phase-to-phase cable, the line-to-ground voltage is approximately 7.2kV. The rectifier causes HALF that voltage to be displayed on the meter (3.6kV). For a short cable, the reading should return quickly to near zero. For a longer cable, it may take a few seconds for the reading to return to near zero.
- 9) If the reading does not return to near zero after several seconds, the cable is leaking or shorted and the test should be discontinued. Remember that all HD voltmeters/phasers are intermittent duty devices and should be connected only as long as necessary to obtain a reading.
- 10) Discharge the cable by removing the voltmeter/phaser from the line, removing the CFT-35 from the voltmeter/phaser and connecting the voltmeter/phaser from cable to ground.

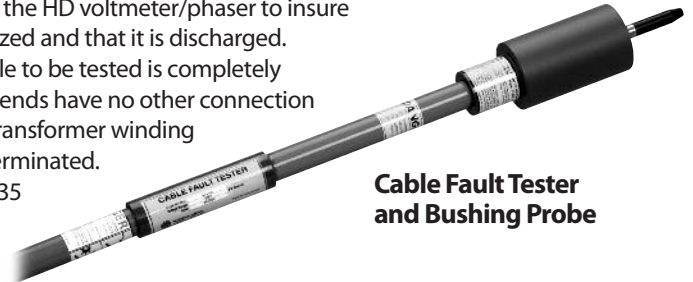
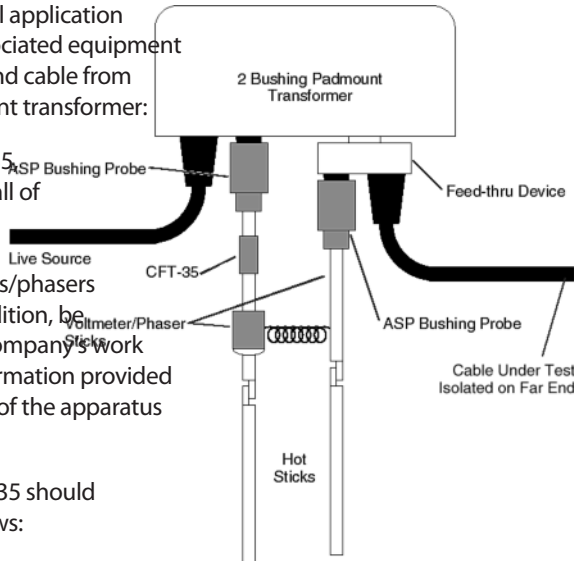

Cable Fault Tester and Bushing Probe

PROBES AND ACCESSORIES *continued*

USE of CFT-35 WITH DIGITAL vs. ANALOG METERS

Using the CFT-35 with digital voltmeters is not as intuitive as it is when used with analog meters. With a digital meter, if the cable is completely shorted the meter will read the line voltage times 0.71. This is different from the usual 50% voltage reading on an analog meter because the digital voltmeter is RMS reading. For a nominal 7.2kV circuit the meter will read approximately 5.1kV.

With an analog meter, if the cable is completely shorted the meter will read 50% of the applied voltage. For a nominal 7.2kV circuit the meter will read approximately 3.6kV. Listed here are the actual cable leakage currents for voltage readings on the DVM-80 digital meter and the MARK-V and MARK-IX analog meters.

Digital DVM-80

Meter reading of 0.5kV = 8uA

Meter reading of 1.0kV = 16uA

Meter reading of 2.0kV = 31uA

Analog MARK-V, 15kV Scale

Meter reading of 0.5kV = 38uA

Meter reading of 1.0kV = 77uA

Meter reading of 2.0kV = 153uA

Analog MARK-IX, 25kV Scale

Meter reading of 0.5kV = 19uA

Meter reading of 1.0kV = 38uA

Meter reading of 2.0kV = 77uA

REPAIRS

All repairs and calibration are performed at HD Electric Company. If any damage is found please contact HD Electric Company at 847-473-4980 to arrange for service.

CALIBRATION AND MAINTENANCE LOG

DATE	CALIBRATED BY

LIMITED WARRANTY AND LIMITATION OF LIABILITY

This warranty applies to all products sold by HD Electric Company (the "Products"); provided, however, that the term Products does not include any third party products purchased through HD Electric Company, for which no warranties are made (the "Third Party Products"). Third Party Products may be subject to a separate manufacturer's warranty; [should you have any question regarding whether a separate warranty applies, please contact HD Electric Company].

NOTICE: READ THIS LIMITATION OF WARRANTY AND LIABILITY BEFORE BUYING OR USING THE PRODUCTS CONTAINED HEREIN.

It is impossible to eliminate all risks associated with the use of the Products. Risks of serious injury or death, including risks associated with electrocution, arcing and thermal burns, are inherent in work in and around energized electrical systems. Such risks arise from the wide variety of electrical systems and equipment to which Products may be applied, the manner of use or application, weather and environmental conditions or other unknown factors, all of which are beyond the control of HD Electric Company.

HD Electric Company does not agree to be an insurer of these risks, and shall have no liability for any claims arising from such risks.

WHEN YOU BUY OR USE THESE PRODUCTS, YOU AGREE TO ACCEPT THESE RISKS.

HD Electric Company warrants to the original purchaser that the Products (excluding any third party products purchased through HD Electric Company, for which no warranties are made) will be free from defects in material and workmanship, under normal use and regular service, and preventative maintenance for a period of one (1) year (ten (10) years for HDE Capacitor Controls) from the date of shipment (the "Warranty Period"). Should any failure to conform with this warranty be found during the Warranty Period, you must notify HD Electric Company of your claim within thirty (30) days of discovery, and within the Warranty Period. Your failure to give notice of claims of breach of warranty within the Warranty Period shall be deemed an absolute and unconditional waiver of claims for such defects. HD Electric Company will have no responsibility to honor claims received after the date the applicable Warranty Period expires.

Upon notice of your claim, HD Electric Company will provide a return authorization number, and further instructions on how to return the product for service. You must follow HD Electric Company's instruction. You are responsible for all Product removal, handling, re-installation, and shipping (both to and from HD Electric Company). Products returned for repair, as well as repaired or replacement Products shall be sent postage / freight prepaid. After receipt of a product which HD Electric Company determines is defective, HD Electric will, at its option, either (1) repair (or authorize the repair of) the Product or (2) replace the Product, subject to the following: The Products are made using parts sourced from a variety of manufacturers. Due to the rapidly changing technology environment, parts may become obsolete / unavailable over time (end of life). In the event that a Product cannot be repaired or replaced due to unavailability of parts, HD Electric Company will use commercially reasonable efforts to obtain substitute parts or conduct work around design, but cannot guarantee its ability to do so.

Items not found defective will be returned at your expense, or failing receipt of instruction from you on return of such items within five (5) business days of our notice to you that the product is not defective, HD Electric may dispose of the product at its discretion and with no liability to you. HD Electric Company's determination of defects is final. Products repaired or replaced during the Warranty Period shall be covered by the foregoing warranties for the remainder of the original Warranty Period or ninety (90) days from the date of delivery of the repaired or replaced Products, whichever is longer.

LIMITATIONS:

This warranty is void in the event of misuse, alteration, faulty installation, or misapplication of the product.

This warranty does not cover failure of product or components due to any ACT OF NATURE; lightning, floods, hurricanes, tornadoes or any other such catastrophic events.

HD Electric Company does not warrant any third party products or associated hardware or their performance or suitability for use and application. Such items are provided "as-is".

All repairs must be authorized by HD Electric Company. Unauthorized repairs will not be reimbursed under any circumstances.

HD Electric Company is not required to make replacement or loaner equipment available while Products are being repaired or replaced, or to compensate you for any in/out labor charges or expenses associated with removal, handling or re-installation of the Products.

TO THE MAXIMUM EXTENT PERMITTED BY LAW, THIS WARRANTY AND THE REMEDIES SET FORTH ABOVE ARE EXCLUSIVE AND IN LIEU OF ALL OTHER WARRANTIES, REMEDIES AND CONDITIONS, WHETHER ORAL OR WRITTEN, EXPRESS OR IMPLIED. HD ELECTRIC EXPRESSLY DISCLAIMS ALL OTHER WARRANTIES OF ANY KIND, EXPRESS OR IMPLIED, INCLUDING WITHOUT LIMITATION IMPLIED WARRANTIES OF FITNESS FOR A PARTICULAR PURPOSE, MERCHANTABILITY AND NON-INFRINGEMENT.

IN NO EVENT SHALL HD ELECTRIC COMPANY BE LIABLE FOR ANY INDIRECT, INCIDENTAL, CONSEQUENTIAL OR SPECIAL DAMAGES RESULTING FROM THE USE OR HANDLING OF THESE PRODUCTS. THIS SHALL INCLUDE BUT, NOT LIMITED TO, LOST PROFITS OR REVENUE, LOSS OF USE OF THE PRODUCTS, COST OF SUBSTITUTE PRODUCTS, FACILITIES OR SERVICES, OR DOWNTIME.

IN NO EVENT SHALL HD ELECTRIC COMPANY HAVE ANY LIABILITY FOR ANY THIRD PARTY PRODUCTS OR ASSOCIATED HARDWARE, OR CUSTOMER-OWNED SYSTEMS, EQUIPMENT OR SOFTWARE.

HD Electric Company must have prompt notice of any claim so that an immediate product inspection and investigation can be made. Buyer and all users shall promptly notify HD Electric Company of any claims, whether based on contract, negligence, strict liability, or other tort or otherwise be barred from any remedy.

HD Electric Company is committed to ongoing review and improvement of its product lines, and thus reserves the right to modify product design and specifications without notice.

HD Electric Company® products are available through HDE® sales representatives worldwide.

Printed in U.S.A. © HD Electric Company 2016 • Bulletin No. VOLTMETER IM-400d