

Davis® Wind Speed and Direction Smart Sensor (S-WCF-M003) Manual



The Davis Wind Speed and Direction smart sensor is designed to work with HOBO® stations. The smart sensor has a plug-in modular connector that allows it to be added easily to a HOBO station. All sensor parameters are stored inside the smart sensor, which automatically communicates configuration information to the logger without the need for any programming or extensive setup. **Note:** This sensor has been modified to work with Onset station loggers only.

Wind Speed & Direction Smart Sensor

S-WCF-M003

Items required:

- Weather-resistant cable ties
- Electrical tape
- Handheld compass, local area map, or handheld GPS

If mounting on tripod or mast:

- Stainless steel hose clamps
- Small screwdrivers
- Adjustable wrench

If mounting on wooden surface:

- Drill with 5 mm (3/16 inch) drill bit

Accessories:

- Grounding kit (M-GKA)

Specifications

	Wind Speed/Gust	Wind Direction
Measurement Range	0 to 76 m/sec (0 to 170 mph)	0 to 355 degrees
Accuracy	±1.1 m/sec (±2 mph) or ±5% of reading, whichever is greater	±7 degrees
Resolution	0.5 m/sec (1.1 mph)	1 degrees (0 to 355 degrees)
Starting Threshold	≤1 m/sec (2.2 mph)	1 m/sec (2.2 mph)
Measurement Definition	Cup revolutions are accumulated every three seconds for the duration of the logging interval Wind speed: Average speed for the entire logging interval Gust speed: The highest three-second wind recorded during the logging interval See <i>Measurement Operation</i> .	Unit vector averaging used; vector components for each wind measurement are calculated every three seconds for duration of logging interval (see <i>Measurement Operation</i>)
Operating Temperature Range	-40°C to 70°C (-40°F to 158°F)	
Environmental Rating	Weatherproof	
Housing	Polycarbonate wind cups	UV-resistant ABS wind vane and black-anodized aluminum anemometer arm
Bearing Type	Sealed stainless steel	
Turning Radius	108 mm (4.25 in.)	Approximately 135 mm (5.25 in.)
Dimensions	470 x 191 x 121 mm (18.5 x 7.5 x 4.75 in.)	
Weight	1.332 kg (2 lb, 15 oz)	
Bits per Sample	8 for each channel, 24 total	
Number of Data Channels*	3	
Measurement Averaging Option	Automatic averaging (see <i>Measurement Operation</i>)	
Cable Length Available	3 m (9.8 ft)	
Length of Smart Sensor Network Cable*	0.5 m (1.6 ft)	



The CE Marking identifies this product as complying with all relevant directives in the European Union (EU).

* A single HOBO station can accommodate 15 data channels and up to 100 m (328 ft) of smart sensor cable (the digital communications portion of the sensor cables).

Components

The smart sensor includes the components shown below.

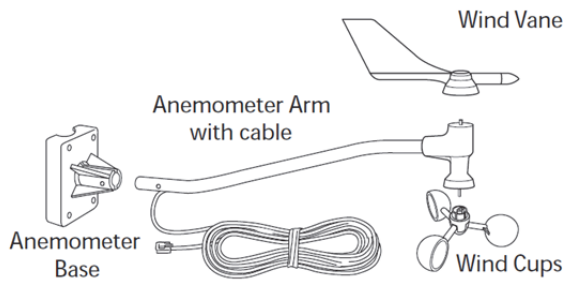

The smart sensor also includes a hardware kit with the items most commonly needed for installation. The items you use from the kit depend on where you install the sensor. You may need to adapt or purchase additional hardware to fit your individual requirements.

Mounting

Mounting Considerations

Use the following guidelines to determine the best location for installing the sensor.

- The smart sensor should be mounted securely to a vertical surface and installed in a location where wind flow is unobstructed by trees and nearby buildings.
- For the most accurate readings, the smart sensor should be mounted at least 1.2 m (4 ft) above the roof line or at a distance of at least five times the height of the nearest tree, building, or other obstruction. You may do this by mounting the smart sensor on a television antenna mast, a wooden post, or a metal pipe.
- The tripod or mounting mast must be properly grounded. For field installations, you can use Onset's Grounding Kit (M-GKA).
- If you live in an area subject to frequent thunderstorms, installing a lightning rod nearby can reduce the risk of damage.
- Be sure to secure the sensor cable with cable ties to protect it from damage.
- Secure the mast the wind sensor is mounted on so that it does not vibrate. If you are using Onset masts or tripods, secure them with guy wires.
- The sensor can be damaged with improper handling. Store the sensor in its shipping box until you are ready to install it.
- To minimize measurement errors due to ambient RF, use the shortest possible probe cable length and keep the probe cable as far as possible from other cables carrying high frequency or high current signals.
- To provide long-term protection from moisture entry, the smart sensor adapter must be mounted horizontally and with the cable wires routed with drip loops so that water drains away from the cable entry point as shown in the

example below. When mounted properly, the housing is weatherproof (but not waterproof).

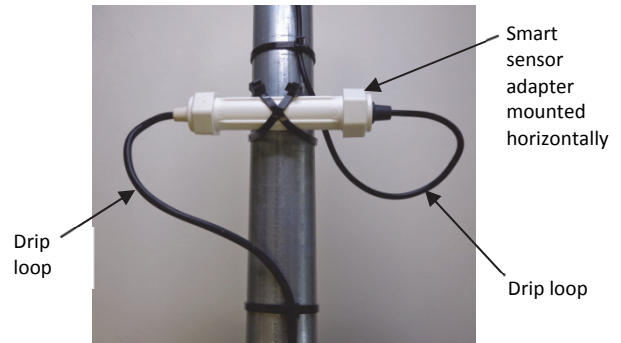

Attaching the Wind Cups

Before installing the smart sensor, you must first attach the wind cups.

1. Push the wind cups onto the smaller of the two stainless steel shafts.

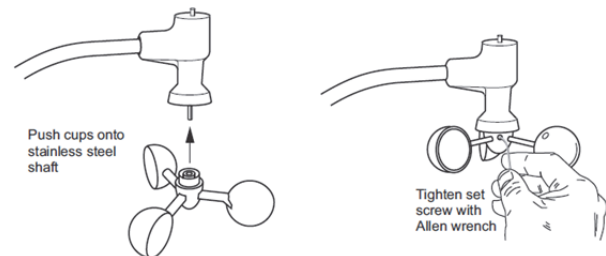

2. Slide the wind cups as far up the shaft as possible.
3. Use the Allen wrench provided to tighten the set screw on the side of the wind cups.
4. Spin the wind cups. If they do not spin freely, loosen the set screw, lower the cups slightly, then retighten the set screw.
5. Repeat step 4 until the wind cups spin freely.

Install the sensor as described in the next sections before attaching the wind vane.

Checking the Anemometer Base Orientation

To obtain accurate readings, the wind vane must be correctly oriented and the entire sensor must point towards north. By default, the wind vane reports the correct wind direction if the anemometer arm points true north. To ensure correct orientation of the wind vane, you will need to mount the anemometer base so that the arm points true north when it is installed in the base.

To check which way to orient the base:

1. Insert the anemometer arm into the base.
2. Attempt to push the #3-40 x 1-1/4 inch pan head screw through the holes in the arm and the base.
3. If the screw does not slide easily through the holes, rotate the base 180 degrees to line up the opposite holes and then try again.
4. Remove the anemometer arm.

See *North Alignment* for steps on finding true north.

Mounting on Masts Larger than 32 mm (1 1/4 inches)

Follow these instructions for mounting the sensor on a tripod or mast with an outside diameter greater than 32 mm (1 1/4 inches):

1. Use two stainless steel hose clamps to attach the mounting base to masts or pipes larger than 1 1/4 inch diameter, large enough to fit around the mast or pipe and the anemometer base.
2. Hold the anemometer base against the pipe and fasten the hose clamps over the anemometer base and around the metal mast or pipe.

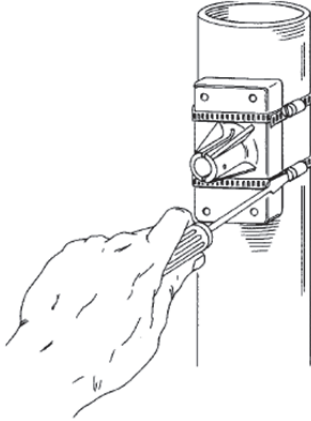
**Mounting on Masts Smaller than 32 mm (1 1/4 inches)**

Follow these instructions for mounting the sensor on a tripod or mast with an outside diameter of 22 to 32 mm (7/8 to 1 1/4 inches):

1. Hold the anemometer base against the pipe and insert the two U-bolts through the back of the base so that the U-bolts wrap around the pipe.
2. Place a 1/4 inch washer and a 1/4-20 hex nut over each end of the U-bolts and use a wrench to tighten the hex nuts.

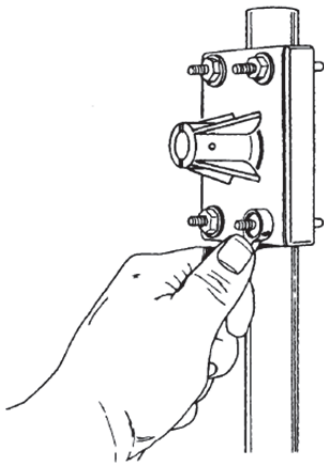
**Mounting on a Wooden Post or Surface**

1. Hold the anemometer base against the wood surface and use a pencil to mark the location of the four holes on the base.
2. Use a drill with a 5 mm (3/16 inch) drill bit to make pilot holes in these locations.
3. Drive the lag screws through the holes in the anemometer base and into the wood.

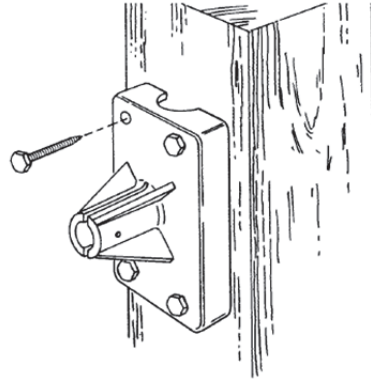
**Attaching Arm to Base**

1. Insert the anemometer arm into the anemometer base. Guide the anemometer cable through the slot as you insert the arm.

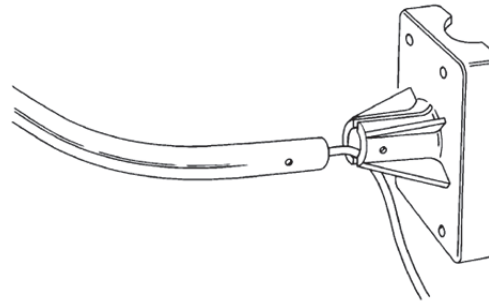

2. Insert the pan head screw into one of the holes in the base and slide it through the arm.
3. Secure the pan head screw using the flat washer, lock washer, and hex nut as shown.

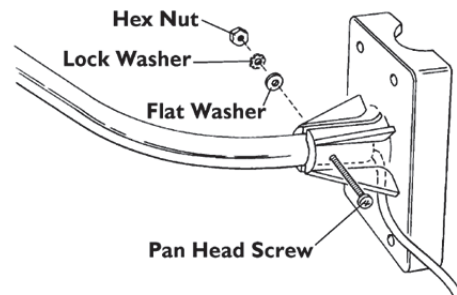

Installing the Wind Vane

1. Slide the wind vane down onto the shaft as far as it will go. (Because of the shape of the shaft, the vane will only go on one way.)
2. Use the Allen wrench provided to tighten the set screw on the side of the wind vane.
3. Test your assembly by pointing the wind vane in any direction and (using the compass or map as a guide) making sure the software status displays the correct wind direction. Readjust the cups if necessary. **Note:** For U30-NRC or Micro Stations, select Status in HOBOWare® to get the current reading. For RX3000 Stations, use the RX3000 Manager in HOBOWare to view the latest conditions. You can also check the latest reading in HOBOLink®, but the data is only updated when the station connects to HOBOLink. Refer to the software user's guide or online help for details on operating HOBOWare or HOBOLink.

Secure the Cables

To prevent fraying or cutting the anemometer cables where it is exposed to weather, secure it so it does not whip about in the wind. Use electrical tape or weather resistant cable ties to secure the cable. Place tape or cable ties approximately every 1 to 1.6 m (3 to 5 ft). Do not use metal staples to secure cables as they can cut the cables. Make sure there are drip loops on both sides of the smart sensor housing, which must also be mounted horizontally as described under *Mounting Considerations*.

Connecting the Sensor to a Station

To connect the sensor to a station, stop the station from logging and insert the smart sensor's modular jack into an available smart sensor port on the station. See the station manual for details on operating stations with smart sensors.

Measurement Operation

Wind direction measurements are averaged over the logging interval or a 3-second timeframe (whichever is greater). If you set up the sensor to log faster than every 3 seconds, the same sensor reading will be recorded until a new 3-second average is calculated. For example, if the sensor is logging at a 1-second interval, the sensor will report the same wind direction (its calculated average) for three samples before calculating and reporting a new value for another three samples. Measurement averaging for this sensor is independent of the logger's measurement averaging. Therefore the automatic measurement averaging for this sensor is not affected by any sampling intervals entered for averaging on other sensors.

Direction Averaging

Unit vector averaging is used to determine wind direction because traditional averaging would produce inaccurate results. For example, three measurements of 350, 11, and 12 degrees—which are all winds from the north—averaged together would result in 126 degrees, which incorrectly indicates a southeasterly wind. Instead, the vector components (North/South and East/West) for each wind measurement are calculated every three seconds for the duration of the logging interval. At the conclusion of the logging interval, the North/South and East/West components are averaged and

then re-combined to calculate the average wind direction for the logging interval.

North Alignment

The sensor must be oriented to true north to obtain meaningful data. There are two methods to align the sensor:

- Compass Alignment
- Global Positioning Satellite (GPS) alignment

Note: The magnetic declination must be known to align the direction sensor to true north using a magnetic compass. Worldwide declination information is available from the National Space Science Data Center at: <http://nssdc.gsfc.nasa.gov/space/cgm/cgm.html>.

Compass Alignment

Tools required:

- Compass
- Binoculars
- Tape (such as electrical, packing, or duct tape)

Two people are required to complete this procedure.

1. Position the wind vane so that it points in the same direction as the mounting arm. Secure the vane on the arm with a piece of tape so that the vane cannot rotate.
2. While standing 150 to 200 feet south of the sensor, use the compass to determine magnetic north. If true north is the same as magnetic north, align yourself so the compass points north and directly at the sensor. If you are in an area with an east variation, align yourself so that the station is that number of degrees to the east of magnetic north. If you are in an area with a west variation, align yourself so that the station is that number of degrees to the west of magnetic north.
3. While viewing the sensor through binoculars, instruct another person to rotate the arm to point the vane north. The vane should seem to disappear from sight when properly aligned.
4. Once you've obtained the correct position, secure the sensor base and remove the tape.

GPS Alignment

Tools required:

- Handheld GPS with WAAS-enabled receiver or any similar high accuracy GPS device
- Flag, orange cone, or other temporary marker
- Laptop computer with logger software installed

This procedure requires only one person, but is easier to complete with two people. In this procedure, you will be using the GPS receiver first to create an arbitrary waypoint and then to determine the bearing from the sensor to that waypoint. You will then align the sensor so that when the vane is pointed at the waypoint, the direction reported by the logger software matches the GPS receiver's bearing to the waypoint.

1. Connect the sensor to the station and connect the station to a laptop with HOBOWare installed.

2. Pick a visible location that is at least 100 meters (110 yards) away from the sensor and walk to it. Establish a waypoint with the handheld GPS receiver. You may want to use averaging to minimize the waypoint position error if your GPS receiver is so equipped. (For best results, the estimated position error of the waypoint should be less than 10 feet if the distance to the sensor is 100 meters, and less than 20 feet for a distance of 200 meters. Mark the waypoint with a flag, orange cone, or other suitable marker. Walk back to the sensor and determine the bearing to the waypoint you just created with the GPS receiver. Again you may need to determine the average value of the bearing to keep the errors to a minimum.
3. View the current sensor readings in the software while positioning the arm. For U30-NRC or Micro Stations, select Status in HOBOWare to get the current reading. For RX3000 Stations, use the RX3000 Manager in HOBOWare to view the latest conditions. You can also check the latest reading in HOBOLink, but the data is only updated when the station connects to HOBOLink. Refer to the software user's guide or online help for details on operating HOBOWare or HOBOLink.
4. Point the sensor vane directly at the waypoint flag or marker and rotate the sensor mounting arm until the wind direction sensor value in the logger software matches the angle obtained with the GPS receiver.
5. Once the vane is in position, secure the mounting base and then double-check that the reported angle is correct.

Maintenance

The sensor does not normally require any maintenance other than an occasional cleaning. If the vane becomes dirty, rinse it with mild soap and fresh water. Do not immerse the sensor in water or use any organic solvents to clean the unit. Do not attempt to lubricate the wind cup shaft or bearings or the wind vane shaft. Natural or synthetic lubricants will inhibit the normal operation of the anemometer.

Verifying Sensor Accuracy

It is recommended that you check the accuracy of the sensor annually. The sensor cannot be calibrated. If the smart sensor is not providing accurate data, then it is damaged or possibly worn out if it has been in use for several years.