



HS-8247

Long Flush Precision Cut 45°
Angle Tapered Head Oblique
Cutter 0.2 mm-1 mm







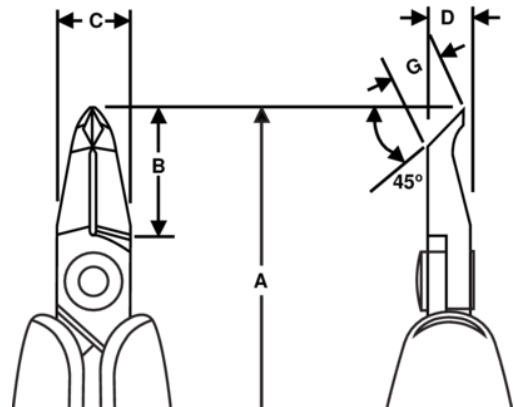

PRODUCT DETAILS

- Long, foam covered handles provide added leverage, an ergonomic grip, and reduced fatigue
- HS handle option can be applied to any standard 80 Series cutters or Supreme Series cutters and pliers
- All HS cutters and pliers are ESD safe, using static dissipative foam grips over conductive spring holders



PRODUCT ATTRIBUTES

Product: **HS-8247**

	Angle 45°		L	A	149.8 mm
A	5.90 in	B	18 mm	B	0,71 in
C	10 mm	C	0.39 in	D	8 mm
D	0,31 inch	G	6,7 mm	G	0,26 in
	0.2-1.0 mm		0.01-0.04 in		Flush
	99 g	Ω	Dissipative		