



HAKKO FM-203 SOLDERING STATION

High-output, temperature controlled
Soldering station

Instruction Manual



Thank you for purchasing the HAKKO FM-203 soldering station.
Please read this manual before operating the HAKKO FM-203.
Keep this manual readily accessible for reference.



TABLE OF CONTENTS

1. PACKING LIST AND PART NAMES	1
2. SPECIFICATIONS	2
3. WARNINGS, CAUTIONS, NOTES AND EXAMPLES	3
4. INITIAL SETUP	4
5. OPERATION	6
6. PARAMETER SETTINGS	12
7. MAINTENANCE	16
8. CHECKING PROCEDURE	17
9. ERROR MESSAGES	18
10. TROUBLE SHOOTING GUIDE	19
11. PARTS LIST	21
12. TIP STYLES	23
13. OPTIONAL PARTS LIST	25
14. WIRING DIAGRAM	27

1. PACKING LIST AND PART NAMES

Please check to make sure that all items listed below are included in the package.

HAKKO FM-203 soldering station	1	Iron holder with tip cleaner	1
HAKKO FM-2027	1	Connecting cable	1
Power cord	1	Tip tray	1
Control card	1	Instruction manual	1
Heat resistant pad	1		

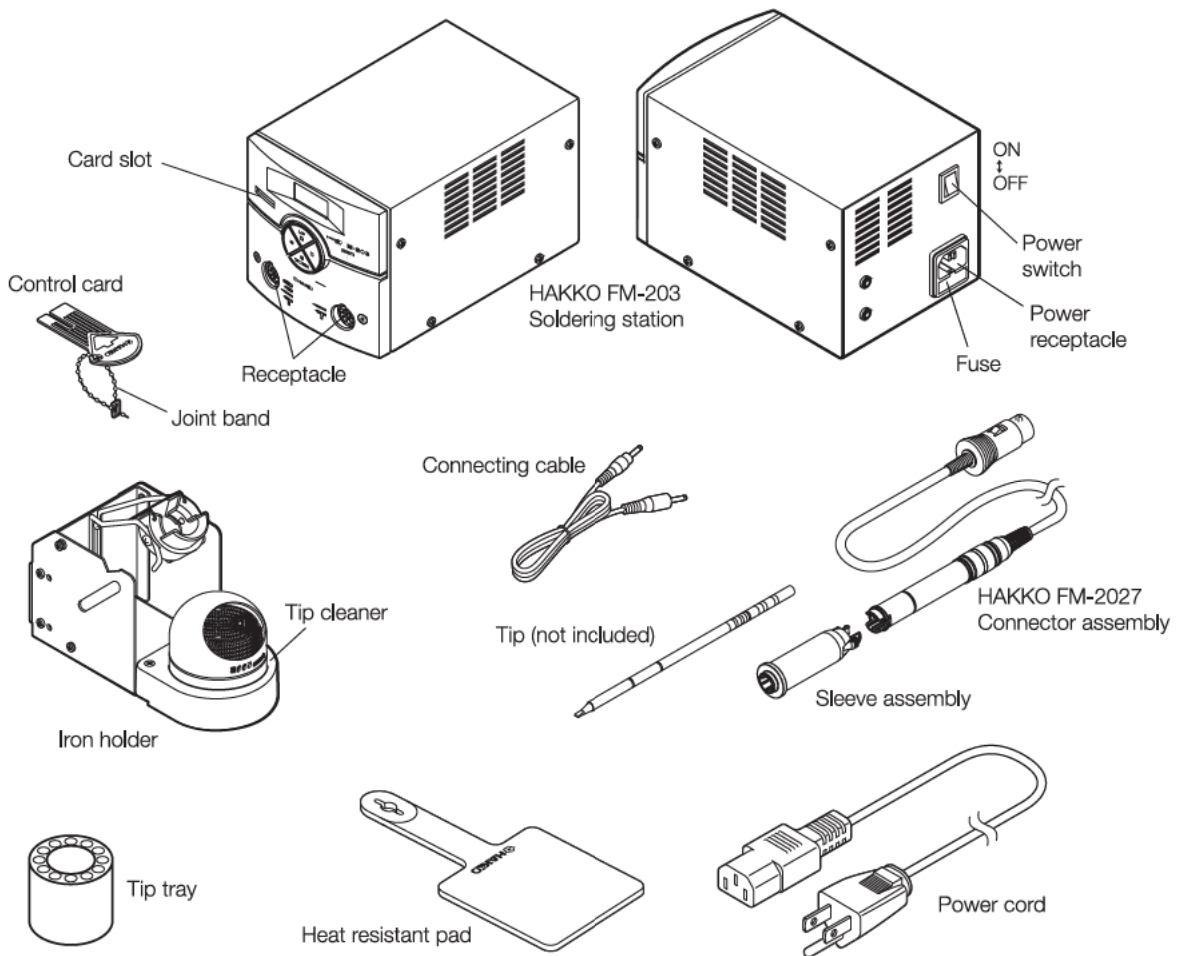

2. SPECIFICATIONS

Power Consumption	140W
Temperature Range	HAKKO FM-2026/2027 200-450°C(400-840°F)
	HAKKO FM-2022/2023 200-400°C(400-750°F)
	HAKKO FM-2024 350-450°C(660-840°F)
	HAKKO FM-2030/2031 200-500°C(400-930°F)
Temperature Stability	±5°C(±9°F)at idle temperature

● Station

Output	24 V
Dimensions(W x H x D)	120 x 120 x 190 mm(4.7 x 4.7 x 7.5 in.)
Weight	2.7 kg (5.9 lb.)

● HAKKO FM-2027

Power Consumption	70 W (24 V)
Tip to Ground Resistance	< 2Ω
Tip to Ground Potential	< 2 mV
Total Length (w/o cord)	188 mm (7.4 in.) with 2.4D tip
Weight (w/o cord)	30 g (0.067 lb. /1.07 oz.)with 2.4D tip
Cord	1.2 m (4 ft)

* The temperature was measured using the FG-101 thermometer.

* This product is protected against electrostatic discharge.

⚠ CAUTION

This product includes such features as electrically conductive plastic parts and grounding of the handpiece and station as measures to protect the device to be soldered from the effects of static electricity. Be sure to observe the following instructions:

1. The handle and other plastic parts are not insulators, they are conductors. When replacing parts or repairing, take sufficient care not to expose live electrical parts or damage insulation materials.
2. Be sure to ground the unit during use.

* Specifications and design are subject to change without notice.

中國RoHS: 產品中有毒有害物質或元素的名稱及含量

部件名稱	有毒有害物質或元素					
	鉛 (Pb)	汞 (Hg)	鎘 (Cd)	六價鉻 (Cr(VI))	多溴聯苯 (PBB)	多溴二苯醚 (PBDE)
電路板	×	○	○	○	○	○
焊鐵部 (吸錫槍部分)	×	○	○	○	○	○
插頭	×	○	○	○	○	○
插座	×	○	○	○	○	○
焊鐵座	×	○	○	○	○	○

○：表示該有毒有害物質在該部件所有均質材料中的含量均在SJ/T 11363-2006 標準規定的限量要求以下。
 ×：表示該有毒有害物質至少在該部件的某一均質材料中的含量超出SJ/T 11363-2006 標準規定的限量要求。

3. WARNINGS, CAUTIONS, NOTES AND EXAMPLES

Warnings, cautions and notes are placed at critical points in this manual to direct the operator's attention to significant items. They are defined as follows:

 **WARNING:** Failure to comply with a WARNING may result in serious injury or death.

 **CAUTION** Failure to comply with a CAUTION may result in injury to the operator, or damage to the items involved.

NOTE: A NOTE indicates a procedure or point that is important to the process being described.

EXAMPLE: An EXAMPLE is given to demonstrate a particular procedure, point or process.

CAUTION

When power is ON, tip temperatures will be between 200 and 500°C. To avoid injury or damage to personnel and items in the work area, observe the following:

- Do not touch the tip or the metal parts near the tip.
- Do not allow the tip to come close to, or touch, flammable materials.
- Inform others in the area that the unit is hot and should not be touched.
- Turn the power off when not in use, or left unattended.
- Turn the power off when connecting the HAKKO FM-2027 or storing the HAKKO FM-203.
- This appliance is not intended for use by persons (including children) with reduced physical, sensory or mental capabilities, or lack of experience and knowledge, unless they have been given supervision or instruction concerning use of the appliance by a person responsible for their safety.
- Children should be supervised to ensure that they do not play with the appliance.

CAUTION

To prevent accidents or damage to the HAKKO FM-203, be sure to observe the following:

- Do not use the HAKKO FM-203 for applications other than soldering.
- Do not strike the iron against hard objects to remove excess solder. This will damage the iron.
- Do not modify the HAKKO FM-203.
- Use only genuine Hakko replacement parts.
- Do not allow the HAKKO FM-203 to become wet, or use it with wet hands.
- Do not bend or damage the control card. If the card does become damaged, do not force the card into the station slot.
- Remove power and iron cords by holding the plug – not the wires.
- Be sure the work area is well ventilated. Soldering produces smoke.
- While using HAKKO FM-203, don't do anything which may cause bodily harm or physical damage.

4. INITIAL SETUP

A. Iron holder

- Loosen the adjusting screws to change the angle of the iron receptacle as you like, then tighten the screws.

1. Assemble as shown:

- Insert the holder assembly securely into the Iron holder base.

2. Operation:

First, remove any excess solder from the tip by thrusting the tip into the cleaning wire.

(Do not wipe the tip against the wire. This may cause molten solder to spatter.)

When the wire becomes dirty or loaded with solder, turn the wire until a clean surface is presented.

When changing the cleaning wire, lift the case top vertically to prevent solder debris from falling out.

3. Place the spare tips in the tip tray.

- Use of the sleep function

When using the sleep function, insert one end of the connecting cable into the jack at the back of the iron holder and the other end into the jack at the back of the soldering station to connect them.

⚠ CAUTION

- Be sure to turn off the power before connecting or disconnecting the connecting cable.
- Securely insert the connecting cable all the way in to the jack.

B. Connector cord

- Pass the connector cord through the hole in the heat resistant pad.

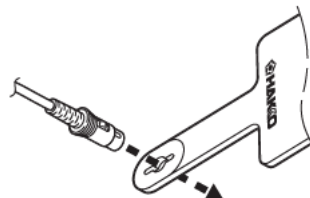
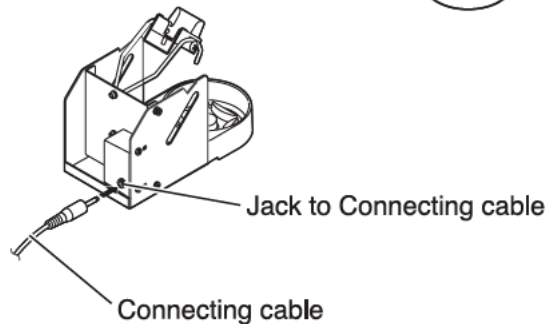
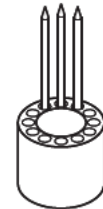
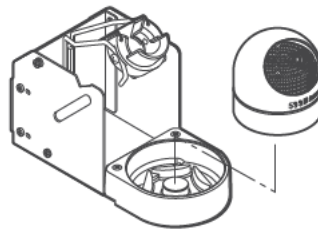
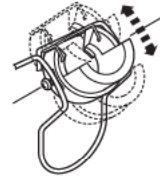

C. Soldering station

⚠ CAUTION

Be sure to unplug the cord by holding the plug.

- The HAKKO FM-203 detects when the iron is removed from the iron holder and sends this data to the station via the connecting cable. That data is then used for various functions.

NOTE:

The channel for connecting the connecting cable to the station must be the same as the channel for connecting the iron set in the iron holder.

⚠ CAUTION

Securely insert the connecting cable all the way into the jack.

1. Connect the power cord to the power receptacle on the rear of the station.
2. Connect the connector cord to the receptacle.
3. Set the iron in the iron holder.
4. Plug the power cord into a grounded wall socket.

⚠ CAUTION

This unit is protected against electrostatic discharge and must be grounded for full efficiency.

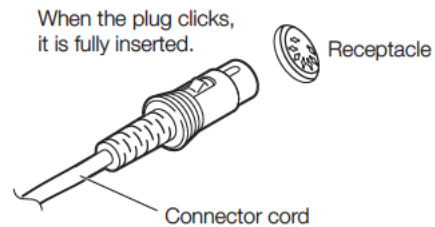
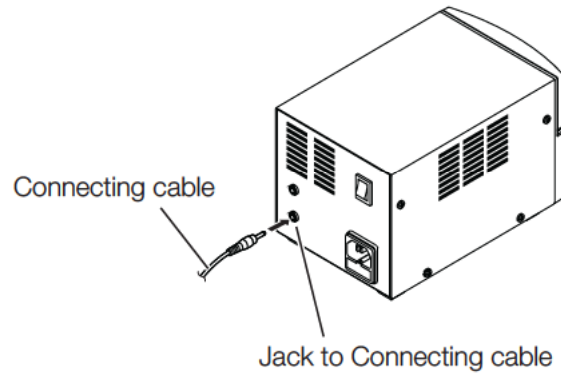

Push the plug in as far as it will go, and try to remove it without pressing the release pin. If it stays in the receptacle, it is properly seated.

5. OPERATION

Controls and displays

Controls

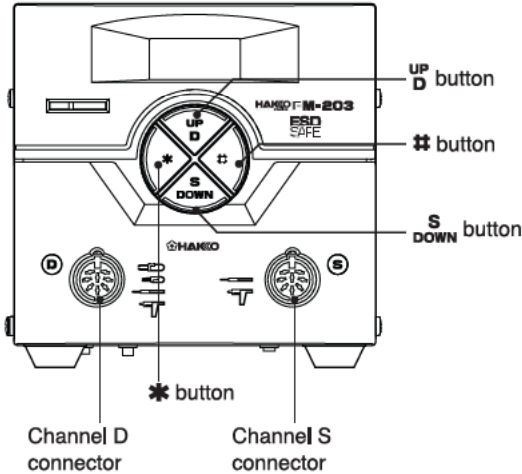

The front panel of the HAKKO FM-203 has four controls.

- *.....** End of sequence signal (terminates a phase of a data entry mode). When pressed for less than one second, displays settings already stored.
- #.....** Initiates a data entry mode.
- UP/D.....** Changes the display to channel D.
 - Press and hold to turn ON or OFF the temperature display for channel D and the power to the iron tip.
 - Increases the displayed value when a setting is changed.
- S/DOWN ...** Changes the display to channel S.
 - Press and hold to turn on or off the temperature display for channel S and the power to the iron tip.
 - Decreases the displayed value when a setting is changed.

Displays

The HAKKO FM-203 has a three-digit display element.

Depending on the selected mode, it will display:

- Sensor temperature (of the iron tip)
- Data entry:
 - Selected quantity (See the data entry procedures.)
- Temperature scale:
 - °C or °F, depending on selection
- Error detection (See ERROR MESSAGES.)

An audible buzzer is provided to alert the operator:

- When the station has reached the set temperature, the buzzer will sound once. (Default setting)
- When the low temperature threshold has been crossed, the buzzer will sound continuously. This buzzer will shutoff when the sensed temperature returns to the acceptable range.
- When a foreign substance, an incompatible tip, or the soldering end of the tip is inserted into the HAKKO FM-2027, the display will blink and the buzzer will sound continuously.
- When the auto-power shutoff function is activated and power to the heater is shut off, the buzzer sounds three times.

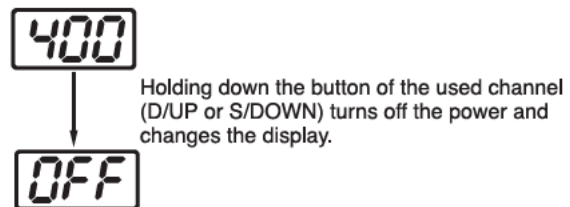

Holding down the button again turns on the power.

NOTE:
Holding down the button of the unused channel changes the display only.

Channel operation

You can connect the HAKKO FM-2027/FM-2030/FM-2031 or MODEL FM-2022/2023/2024 to the channel D connector, and the HAKKO FM-2027 or MODEL FM-2024 to the channel S connector.

Model	Channel D	Channel S
FM-2022	○	—
FM-2023	○	—
FM-2024	○	○
FM-2026	○	○
FM-2027	○	○
FM-2030	○	—
FM-2031	○	—

The displays of the channel display lamps differ depending on the use of the channels.

Model (Ch. D)	Channel	Dual channel control	
		On	Off
FM-2022	Display side	Lights	Lights
	Non-display side	Off	Off
FM-2023	Display side	Lights	Lights
	Non-display side	Off	Off
FM-2024	Display side	Blinks	Lights
	Non-display side	Lights	Off
FM-2026	Display side	Blinks	Lights
	Non-display side	Lights	Off
FM-2027	Display side	Blinks	Lights
	Non-display side	Lights	Off
FM-2030	Display side	Lights	Lights
	Non-display side	Off	Off
FM-2031	Display side	Lights	Lights
	Non-display side	Off	Off

* When dual channel control is off, one channel (either channel D or S) is controlled. The other channel (not being displayed) automatically enters sleep mode. The setting can be switched between on and off in the parameter setting.

When MODEL FM-2022/2023/HAKKO FM-2030/FM-2031 is connected to the channel D connector, the other channel automatically enters sleep mode regardless of on/off setting of dual channel control.

When the **UP D** button or **S DOWN** button is pressed, or when the iron is removed from the iron holder, the channel for temperature control is switched to that channel (Factory default setting).

The lamp on the grip operates as follows.

In use Lights
 Sleep mode..... Blinks slowly
 Off mode Off
 Error Blinks quickly

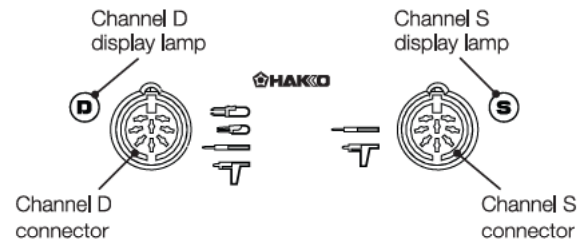

NOTE:

When the temperature rises for one channel and a grip is connected to the other channel, it may take time to correctly determine the temperature. This is not a malfunction.

Dual channel control is On

FM-2024/2026/2027

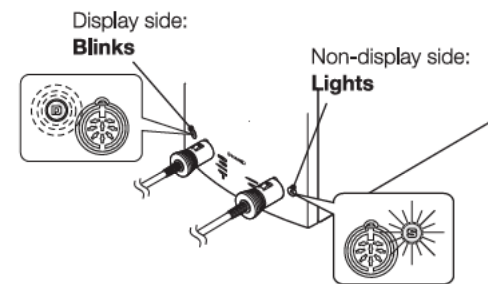

FM-2022/2023/2030/2031

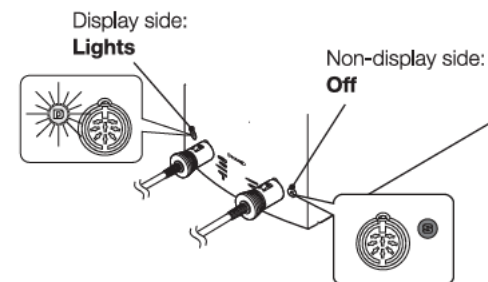

Dual channel control is Off

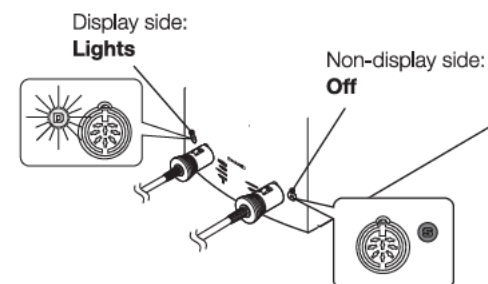

● **When the HAKKO FM-2027/MODEL 2024 is reconnected to the channel D connector**

When the MODEL FM-2022 / 2023 / HAKKO FM-2030 / FM-2031 is disconnected from the channel D connector and the HAKKO FM-2027 / MODEL FM-2024 is reconnected, temperature control starts for both channels, and the channel display lamp blinks for the channel being displayed in the temperature display and lights for the channel not being displayed.

Operation

1. Turn the power switch ON.

 **CAUTION**

When not in use, set the iron in the iron holder. The MODEL FM-2024 does not function properly if the power is turned on with the trigger pressed. Release the trigger and then turn the power ON.

2. By default, when the set temperature is reached, the buzzer sounds, indicating that the unit is ready.

When using only one soldering iron:

Example:

When not using channel S

NOTE:



When the MODEL FM-2022 / 2023 / HAKKO FM-2030 / FM-2031 is disconnected and reconnected, the operation mode may change automatically. In this case, the unit is reset to a new operation mode, thereby cancelling sleep mode. This is not a malfunction.

 **CAUTION**

By default, the temperature is set to 750°F (350°C). You can confirm the set temperature by pressing the * button. The set temperature will be displayed for two seconds.

 **CAUTION**

When not in use, set the iron in the iron holder.

1. Press the  button to select channel S.
2. Press and hold down the  button again until OFF is displayed.

NOTE:

Power is not supplied to channel S.

3. Press the  button to display channel D. This data is recorded to the internal memory, and the setting remains effective even if the power is turned off.

● Setting/changing the temperature

● HAKKO FM-2027

Temperature setting range

°C.....200 to 450°C

°F400 to 840°F

* Regarding the temperature range of the handpiece other than HAKKO FM-2027, refer to "2. SPECIFICATIONS".

Example: Changing the temperature for channel D from 350°C to 400°C

1. Check that the current temperature display is set to channel D.

See "Channel operation" (preceding pages).

- If the temperature for channel S is displayed, press the **UP** **D** button to change the channel.

2. Insert the control card into the station.

- The hundreds digit of the display begins to flash. This indicates that the unit has entered the temperature setting mode and data may be entered.

3. Enter the hundreds digit.

- Press the **UP** **D** or **S** **DOWN** button to set the hundreds digit. When the desired figure is displayed, press the ***** button. The tens digit begins to flash.

4. Enter the tens digit.

- Press the **UP** **D** or **S** **DOWN** button to set the tens digit. When the desired figure is displayed, press the ***** button. The units digit begins to flash.

5. Enter the units digit.

- Set the desired units digit in the same way as for the tens digit, and then press the ***** button. The temperature is recorded to the internal memory, and heater control begins after the new set temperature is displayed.

To change the set temperature with the control card in the station:

- Press and hold the ***** button for at least one second.

The current temperature setting is displayed, and then the hundreds digit begins to flash one second later. This indicates that the station has entered the temperature setting mode. Follow steps 3-5 above to set the temperature.

Channel D displayed.

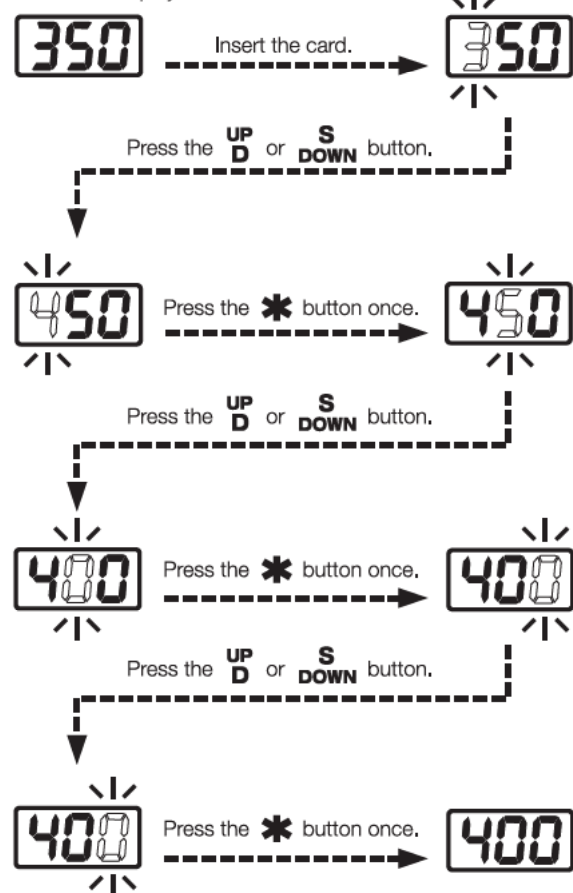

⚠ CAUTION

If the power is turned off without completing the temperature setting, the new set temperature will not be recorded.

NOTE:

When operating in Fahrenheit mode the temperature can not be set above 840°F. If you enter a value outside the allowable range, the display returns to the hundreds digit, and you have to enter a correct value.

NOTE:

If the ***** button is not pressed and held for at least one second, the current set temperature is displayed, and then the tip temperature is displayed.

The temperature accuracy of iron tips is $\pm 15^{\circ}\text{C}$ ($\pm 27^{\circ}\text{F}$) (except for designated tips) when using the default offset values. If a higher temperature accuracy is required, use the following offset function:

● Entering the tip offset value

Example:

When the set temperature for channel D is 400°C and the actual tip temperature is 410°C : The difference in temperature is 10°C , so enter -10 as the current offset value.

1. Check that the current temperature display is set to channel D.

- If the temperature for channel S is displayed, press the $\overset{\text{UP}}{\text{D}}$ button to change the channel.

2. Insert the control card into the station.

- The station enters the temperature setting mode.

3. Press the # button.

- The station enters the offset entry mode. Press the $\overset{\text{UP}}{\text{D}}$ or $\overset{\text{S}}{\text{DOWN}}$ button to set the hundreds digit. The values that can be entered in $^{\circ}\text{C}$ or $^{\circ}\text{F}$ are 0 (for positive values) and - (for negative values).

4. Select 000 or -00 and press the * button.

The tens digit begins to flash. Enter the offset value.

The values that can be entered are 0 to 5 in $^{\circ}\text{C}$ (0 to 9 in $^{\circ}\text{F}$).

The tens and units digits are set with the offset value range.

Allowable offset value range

$^{\circ}\text{C}$ -50 to $+50^{\circ}\text{C}$
 $^{\circ}\text{F}$ -90 to $+90^{\circ}\text{F}$

If you enter a value outside the allowable offset value range, the display returns to the hundreds digit, and you have to enter a correct value.

⚠ CAUTION

In the offset entry mode (when the display is flashing), the tip temperature is controlled by the current offset value.

5. Verify the tip temperature.

Channel D temperature setting mode

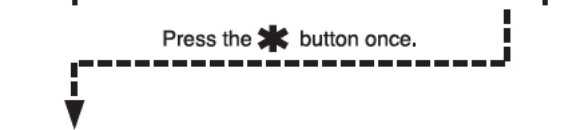
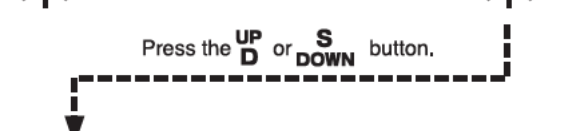
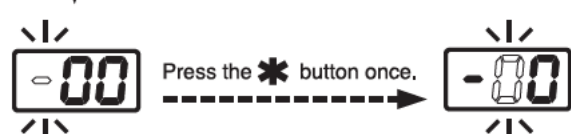
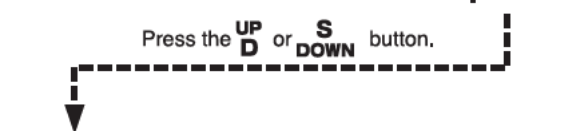

NOTE:

- The station stores the offset values for each tip type. For example, connect the HAKKO FM-2027 to the station and enter the offset value (-10°C). Next, change to the MODEL FM-2023 and enter the offset value (-20°C). When you reconnect the HAKKO FM-2027, the offset value is set to -10°C automatically.
- The station stores the offset values for each channel. For example, connect two HAKKO FM-2027 units to channels D and S and enter the offset values. Now both HAKKO FM-2027 units will be controlled using separate offset values. However, when a HAKKO FM-2027 unit set to an offset value on channel D is connected to channel S instead, the offset value of channel D is not applied to channel S.

To change the offset value with the control card in the station:

- Press and hold the **#** button for at least one second.

The current offset value is displayed, and then the hundreds digit begins to flash one second later. This indicates that the station has entered the offset entry mode.

Follow steps 3 and 4 of page 10 for setting the offset value of the tip temperature.

NOTE:

- If the **#** button is not pressed and held for at least one second, the current set temperature is displayed, and then the tip temperature is displayed.
- The default offset value is 0.

● Replacing the tip

⚠ CAUTION

The tip may be hot. Avoid holding the hot tip for a long time even if using the heat-resistant pad. Otherwise burns may result.

Removing the tip:

- Hold down the lock release buttons in the sleeve assembly, pull out the tip together with the sleeve assembly from the connector.

⚠ CAUTION

- Be sure to keep the lock release buttons held down while pulling out the sleeve assembly. Failure to do so will damage the locking mechanism.
- Be sure to pull out the tip only after separating the sleeve assembly from the connector. Otherwise, the sleeve assembly may fall down and break.

- While holding the front end of the sleeve assembly, pull out the tip.

Inserting the tip:

- Holding the front end of the tip, insert it into the sleeve assembly.

⚠ CAUTION

Insert the tip into the sleeve assembly until it clicks into place. When you hear it clicks, avoid forcing the tip into the sleeve assembly.

- Insert the tip securely into the connector.

NOTE:

Improper insertion of the tip will cause **S-E** to appear on the display.

Remove the tip from the connector while pressing this part.

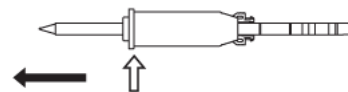
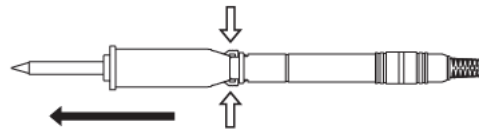

Hold the front part of the sleeve assembly to remove the tip.

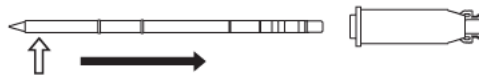

Hold this part to insert the tip into the sleeve assembly.

⚠ CAUTION

When holding the head of the tip, there is a danger of burn. Be sure to use the heat-resistant pad.

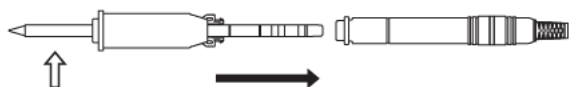

Hold this part to insert the tip into the connector.

6. PARAMETER SETTINGS

● Parameter entry mode process

Select the parameter entry mode using the following operation.

Be sure to insert the control card before opening.

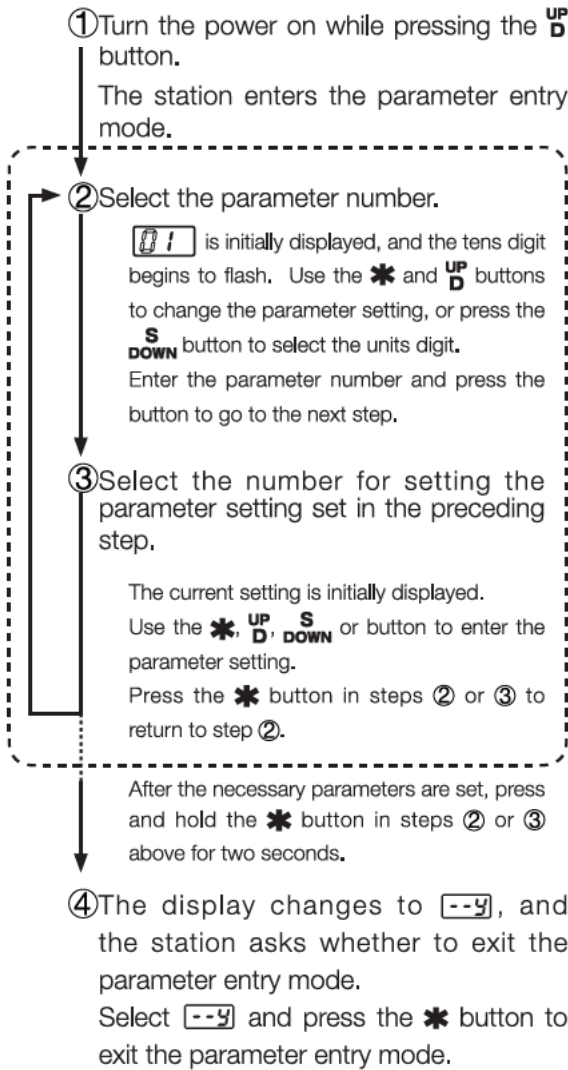

The HAKKO FM-203 has the following parameters.

	Number	LED display	Setting	Default setting	
				For USA	For others
Temperature display	01	F or C	F: °F display C: °C display	°F display	°C display
Auto sleep time setting	02	Tens digit entry	Sleep time	Dch: 6 min. Sch: 6 min.	Dch: 6 min. Sch: 6 min.
Low temperature error setting	03	Hundreds digit entry	Low temperature threshold entry	270°F	150°F
Custom input setting	04	0 or 1	0: Off 1: On	Off (0)	Off (0)
Buzzer setting (C-E sound, S-E sound)	05	0 or 1	0: Off 1: On	On (1)	On (1)
Buzzer setting (Set temperature alert)	06	0 or 1	0: Off 1: On	On (1)	On (1)
Auto sleep on/off setting	07	0 or 1	0: Off 1: On	On (1)	On (1)
Auto shutoff on/off setting	08	0 or 1	0: Off 1: On	Off (0)	Off (0)
Auto channel switching on/off setting	09	0 or 1	0: Off 1: On	On (1)	On (1)
Dual channel control setting	10	0 or 1	0: Off 1: On	On (1)	On (1)

NOTE:

Auto sleep can be set separately for channels D and S.

NOTE:

- Each time the **UP/D** or **S/DOWN** button is pressed, the display toggles between the following displays: **--y** and **--n**.
- When **--n** is selected, the parameter number selection screen in step 2 is displayed.

CAUTION

Do not leave the HAKKO FM-203 for a long time with the auto shutoff function activated. Turn the power off when you do not use the HAKKO FM-203 for a long time.



● 01 : Temperature display (°C or °F)

- When the display changes to **F** and **C**, the station enters the mode for changing the temperature display.
- Press the **UP/D** or **S/DOWN** button to switch the display alternately between **F** (Fahrenheit) and **C** (Celsius).

● 02 : Auto sleep setting



Set the time until the auto sleep function activates after the soldering iron is set on the iron holder.

Auto sleep examples:

-  Sleep (immediately after the iron is set on the iron holder)
-  Sleep (10 minutes after the iron is set on the iron holder)

NOTE:

- The auto sleep time can be set in units of minutes (up to 29 minutes).
- The auto sleep time can be set separately for channels D and S. The channel that can be set is the channel for which the channel display lamp is lighting during parameter entry.

- The tip temperature is reduced to approximately 200°C during sleep mode. The tip temperature varies significantly, depending on the ambient environment, tip type and iron types. 200°C (400°F) should only be used as a guide.
- When the display is , press the  or  button, or remove the soldering iron from the iron holder to resume power to the heater.

● 03 : Lower temperature error setting

Lower temperature error

- When the temperature drops below a set limit, an error is displayed and the buzzer sounds. When the temperature returns within the allowable range, the buzzer stops.

Low temperature setting range

for Celsius: 30 to 150°C
for Fahrenheit: 50 to 300°F

Example:

When the set temperature is 350°C and the low temperature error setting is 100°C, a warning buzzer sounds when the temperature drops to 250°C.

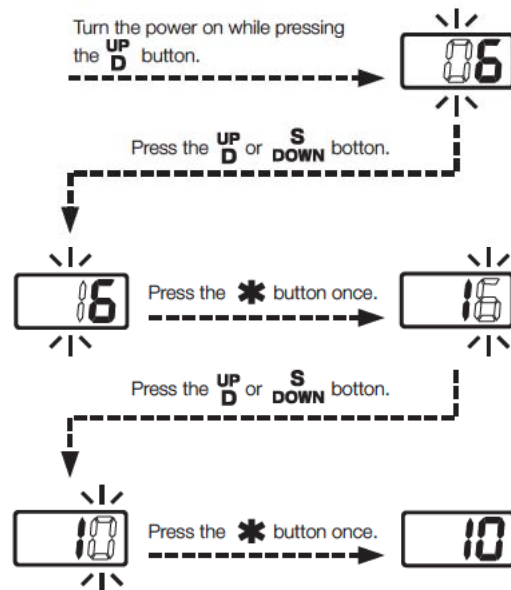

The channel D setting is completed as shown in the preceding diagram. Repeatedly pressing the  button moves to the channel S setting. (The process is the same as that for channel D.)

CAUTION

- When the setting temperature is 300°C (570°F) or less, the sleep function cannot be set to Sleep even if the sleep function is set to ON.
- The tip temperature rises to the setting temperature once at power on even if the sleep time is set to "0". The tip temperature will be reduced to the sleep temperature after the temperature reaches the set temperature.

- The hundreds digit begins to flash when entering the low temperature setting. Use the method for setting the temperature to enter and set the low temperature setting.
- If you enter a value outside the low temperature setting range (see the table on the left), the display returns to the hundreds digit, and you have to enter a correct value.
- After the low temperature setting is set, the display returns to the parameter number selection screen.

● 04 : Offset-free mode

● 05 : S-E, C-E buzzer sound setting mode

● 06 : Set temperature alert setting mode

● 07 : Auto sleep function setting mode

NOTE:

When the auto sleep function is on, removing the iron from the iron holder or pressing the **UP** or **S** **DOWN** button resumes operations.

● 08 : Auto shutoff function setting mode

When the auto shutoff function is set to on and no operation is performed for 30 minutes after the iron is set in the iron holder, the buzzer sounds three times and the auto shutoff function will be enabled. Leaving the iron in the iron holder as it is, the buzzer sounds every 30 minutes.

- When the station is in the offset-free mode, either 0 or 1 is displayed.

0 : The offset value cannot be entered without the control card inserted into the station.

1 : The offset value can be entered without the control card inserted into the station.

Select **UP** **D** or **S** **DOWN** and press the * button.

- In the buzzer sound setting mode, which sets whether to sound the buzzer when a sensor error 0 or 1 soldering iron error occurs, either 0 or 1 is displayed.

0 : The buzzer does not sound.

1 : The buzzer sounds.

Select **UP** **D** or **S** **DOWN** and press the * button.

- In the set temperature alert setting mode, either 0 or 1 is displayed.

0 : The buzzer does not sound when the soldering iron reaches the set temperature.

1 : The buzzer sounds when the soldering iron reaches the set temperature.

Select **UP** **D** or **S** **DOWN** and press the * button.

- In the auto sleep setting mode, either 0 or 1 is displayed.

0 : The auto sleep function is off, regardless of the auto sleep set time.

1 : The auto sleep function is on, and the auto sleep time is activated.

Select **UP** **D** or **S** **DOWN** and press the * button.

- In the auto shutoff setting mode, either 0 or 1 is displayed.

0 : The auto shutoff function is off, regardless of the auto sleep function set time.

1 : The auto shutoff function is on, and the auto shutoff time is activated.

Select **UP** **D** or **S** **DOWN** and press the * button.

NOTE:

When the auto shutoff function is on, removing the iron from the iron holder or pressing the **UP** **D** or **S** **DOWN** button resumes operations.

● **09 : Auto channel switching setting mode**

Auto channel switching

- This turns on and off the function for automatically switching the display channel and control channel when the iron is removed from the iron holder.

● **10 : Dual channel control setting mode**

Dual channel control setting mode

- When two HAKKO FM-2027/MODEL FM-2024 units are connected to channels D and S, these channels are controlled as follows, according to this setting.

On: Channel D and S are controlled simultaneously.

Off: One channel (either channel D or S) is controlled, and the other channel enters sleep mode.

NOTE:

- If the MODEL FM-2022/FM-2023/HAKKO FM-2030/FM-2031 is connected to channel D, dual channel temperature control is not available.
- When the dual channel control is off, regardless of the type of grip (FM-2022, FM-2023, FM2024, FM2027), the station lamp lights for the channel in use (the channel being displayed) and turns off for the channel not in use (the channel not being displayed).

- In the auto channel switching setting mode, either **0** or **1** is displayed.

0 : Auto channel switching is off.

1 : Auto channel switching is on.

Select **UP** **D** or **S** **DOWN** and press the ***** button.

- In the dual channel control setting mode, either **0** or **1** is displayed.

0 : Dual channel control is off.

1 : Dual channel control is on.

Select **UP** **D** or **S** **DOWN** and press the ***** button.

7. MAINTENANCE

● Tip maintenance

1 Tip temperature

High temperatures shorten tip life and may cause thermal shock to components. Always use the lowest possible temperature when soldering. The excellent thermal recovery characteristics of the HAKKO FM-203 ensure effective soldering at low temperatures.

2. Cleaning

Always clean the soldering tip before use, to remove any residual solder or flux adhering to it. Use the 599B tip cleaner (provided with the HAKKO FM-203) or use a clean and moist cleaning sponge (part no. A1536). Contaminants on the tip have many deleterious effects, including reduced heat conductivity, which contribute to poor soldering performance.

3. After use

Always clean the tip and coat it with fresh solder after use. This guards against oxidation.

4. When the unit is not being used and the auto power shutoff is not active.

Never allow the unit to idle at a high temperature for extended periods. This will allow the tip to become oxidized. Turn the power switch OFF. If it is to be out of service for several hours, it is advisable to pull the power plug as well.

5. Inspecting and cleaning the tip

This procedure, if followed daily, will materially add to tip life.

- a. Set the temperature to 250°C (482°F).
- b. When the temperature stabilizes, clean the tip (see 2, above) and check the condition of the tip. If the tip is badly worn or deformed, replace it.
- c. If the solder plated part of the tip is covered with black oxide, apply fresh solder, containing flux, and clean the tip again. Repeat until all the oxide is removed, then coat the tip with fresh solder.



CAUTION

NEVER file the tip to remove oxides!

- d. Turn the power OFF and remove the tip, using the heat resistant pad. Set the tip aside to cool.
- e. Remaining oxides, such as the yellow discoloration on the tip shaft, are not harmful but can be removed with isopropyl alcohol.

8. CHECKING PROCEDURE

⚠ WARNING

Unless otherwise directed, carry out these procedures with the power switch OFF and the power UNPLUGGED.

■ Check for a broken heater or sensor

1. Check for a broken heater or sensor

Measure the resistance across this position.



Verify the electrical integrity of the heater and sensor.

Measure the resistance of the heater and sensor while at room temperature (15 to 25°C; 59 to 77°F). It should be $8\Omega \pm 10\%$. If the resistance exceeds these limits, replace the tip.

■ Check the grounding line

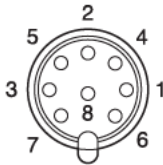

1. Unplug the connection cord from the station.
2. Measure the resistance value between Pin 2 and the tip.
3. If the value exceeds 2Ω (at room temperature), perform the tip maintenance described on p.16. If the value still does not decrease, check the connection cord for breakage.

■ Checking the connection cord for breakage

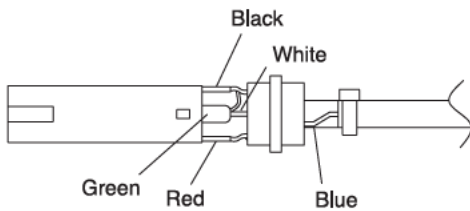

1. Remove the soldering tip and the sleeve assembly.
2. Turn the front piece of the HAKKO FM-2027 clockwise and remove the cover.
3. Measure the resistance values between the connector and the lead wires at the socket as follows:

Pin 1 – Red Pin 2 – Green

Pin 3 – Black Pin 5 – White

If any value exceeds 0Ω or is ∞ , replace the HAKKO FM-2027.

■ Replacing the fuse

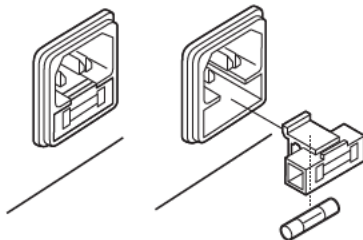

1. Unplug the power cord from the power receptacle.
2. Remove the fuse holder.
3. Replace the fuse.
4. Put the fuse holder back in place.

9. ERROR MESSAGES

● Sensor Error



● Low-temperature alarm tolerance error

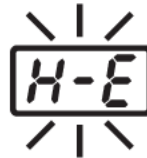

EXAMPLE:

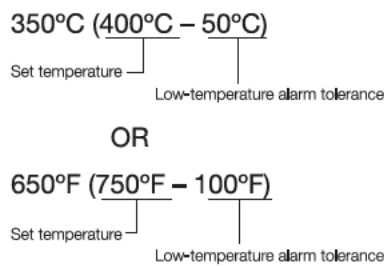

● Heater terminal short circuit error



● Soldering iron error



● Detection error



When there is the possibility that a failure has occurred in the sensor or heater (including the sensor circuit), **S-E** is displayed and the power is shut down.

NOTE:

The sensor error also occurs if the tip is not inserted properly.

S-E may be displayed for a moment when the grip is connected. This is not an error.

If the sensor temperature falls below the difference between the current temperature setting and the low-temperature alarm tolerance, **H-E** is displayed and the warning buzzer sounds. When the tip temperature rises to a value within the set tolerance, the buzzer will stop sounding.

EXAMPLE:

Assume that the temperature setting is 400°C/750°F and the tolerance 50°C/100°F. If the temperature continues to decrease and finally falls below the value indicated below while the heating element is on, the displayed value starts blinking to indicate that the tip temperature has dropped.

HSE will flash, and the buzzer will sound continuously, when the tip is inserted incorrectly, an incompatible tip is inserted, or a foreign object has found its way into the connector.

I-E will be displayed if the connector cord is not attached to the station OR the wrong soldering iron is connected.

d-E appears on the display when turning the power on after connecting the MODEL FM-2022/2023 with a hot tip.

This is not an error.

Wait for approximately 10 seconds until the model functions properly.

10. TROUBLE SHOOTING GUIDE

WARNING

Before checking the inside of the HAKKO FM-203 or replacing parts, be sure to disconnect the power plug. Failure to do so may result in electric shock.

- The unit does not operate when the power switch is turned on.

CHECK : Is the power cord and/or the connection plug disconnected?

ACTION : Connect it.

CHECK : Is the fuse blown?

ACTION : Investigate why the fuse blew and then replace the fuse. If the cause can not be determined, replace the fuse. If the fuse blows again, send the unit in for repair.

- The tip does not heat up.

• The sensor error  is displayed.

CHECK : Is the tip inserted properly?

ACTION : Insert the tip completely.

CHECK : Is the connection cord and/or the heater/sensor broken?

ACTION : See the appropriate section of this manual regarding how to check the connection cord and/or the heater/sensor for breakage.

- Solder does not wet the tip.

CHECK : Is the tip temperature too high?

ACTION : Set the appropriate temperature.

CHECK : Is the tip contaminated with oxide?

ACTION : Remove the oxide (see "Tip maintenance" on P. 16).

- The tip temperature is too high.

CHECK : Is the connection cord broken?

ACTION : See "Checking the connection cord for breakage" on P. 17.

- The tip temperature is too low.

CHECK : Is the tip contaminated with oxide?

ACTION : Remove the oxide (see "Tip maintenance" on P. 16).

- The soldering iron error  is displayed.

CHECK : Is the other soldering iron connected? Or the HAKKO FM-2027 plug disconnected?

ACTION : Connect the HAKKO FM-2027 soldering iron.

-
- **The low-temperature alarm tolerance error `H-E` occurs frequently.**

CHECK : Is the tip too small for the items to be soldered?

ACTION : Use a tip with a larger thermal capacity.

CHECK : Is the setting value for the low-temperature alarm tolerance too low?

ACTION : Increase the setting value.

- **Heater terminal short circuit error `HSE` is displayed.**

CHECK : Is the tip for HAKKO FM-2027?

ACTION : Turn the power switch OFF and insert the genuine HAKKO FM-2027 tip. Turn the power switch ON.

- **Power to the heater is shut off and the tip does not heat up.**

- `OFF` is displayed for the channel that loses power.

ACTION : Hold down the button (either D/UP or S/DOWN) on the display. Holding down the button turns the power on.

11. PARTS LIST

NOTE:

Spare or repair parts do not include mounting screws, if they are not listed on the description. Screws must be ordered separately.

● **HAKKO FM-203 soldering station**

Item No.	Part No.	Part Name	Specifications
①	B2852	Power switch	
②	B2384	Power receptacle	
③	B2419	Power cord, 3 wired cord & American plug	
	B2421	Power cord, 3 wired cord but no plug	
	B2422	Power cord, 3 wired cord & BS plug	India
	B2424	Power cord, 3 wired cord & European plug	220V KTL 230V CE
	B2425	Power cord, 3 wired cord & BS plug	230V CE
	B2426	Power cord, 3 wired cord & Australian plug	
	B2436	Power cord, 3 wired cord & Chinese plug	China
④	B2743	Transformer	120V
	B2855	Transformer	100V
	B2856	Transformer	110V
	B2857	Transformer	220V
	B2858	Transformer	230V
	B2863	Transformer	240V
⑤	B2972	Card	
⑥	B2761	Fuse/250V-3A	100-220V
	B2864	Fuse/125V-1.6A	220-240V
⑦	B3397	Cover	
⑧	B3398	Chassis	With rubber feet
⑨	B3399	Front panel A	
⑩	B3400	Front panel B	With LED lens, D.S
⑪	B3401	Display	
⑫	B3402	Button set	4pcs.

Item No.	Part No.	Part Name	Specifications
⑬	B3403	P.W.B	
⑭	B3404	Heat sink	
⑮	B3405	Clip (Large size)	
⑯	B3406	Clip (Small size)	
⑰	B3253	Connecting cable	

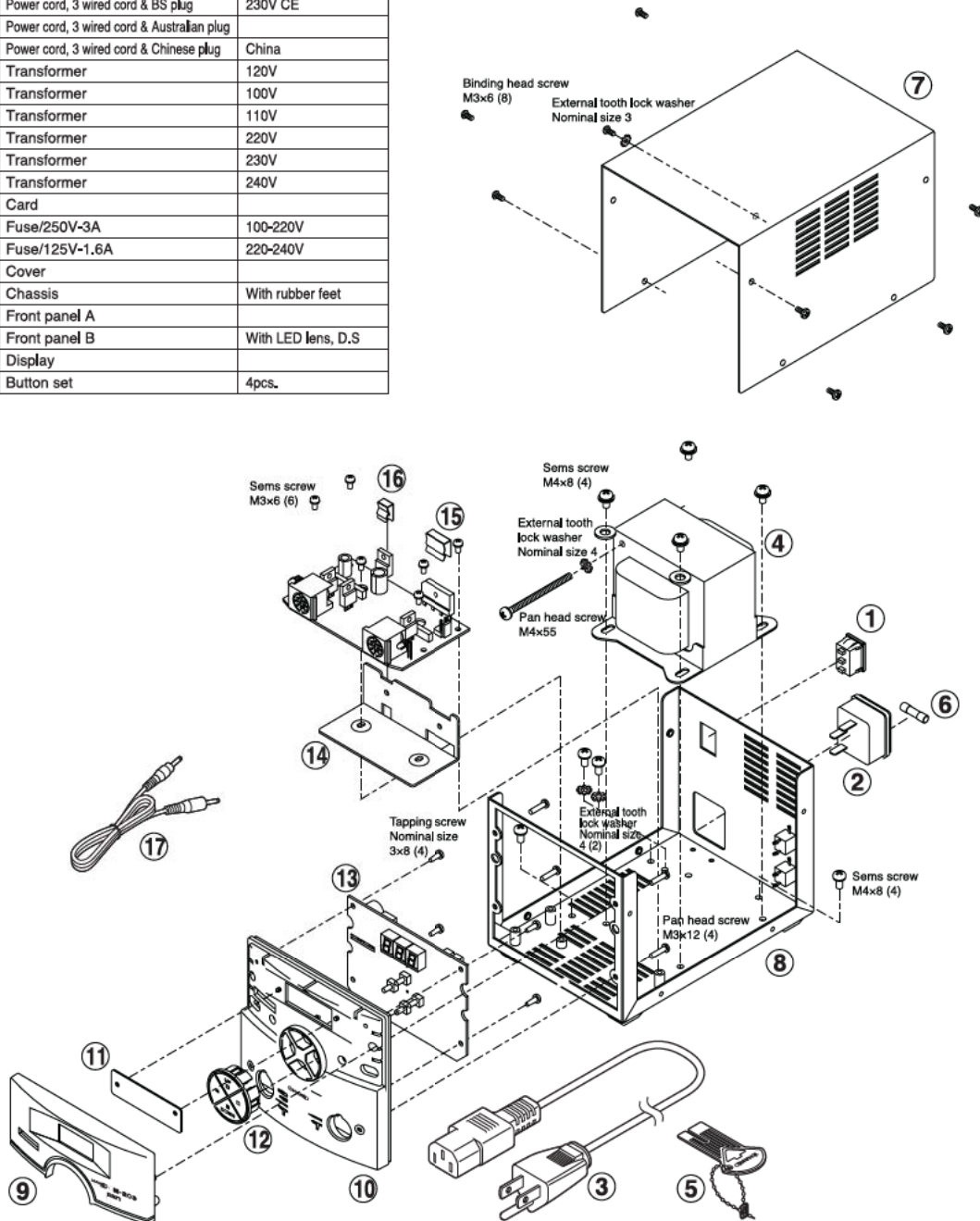

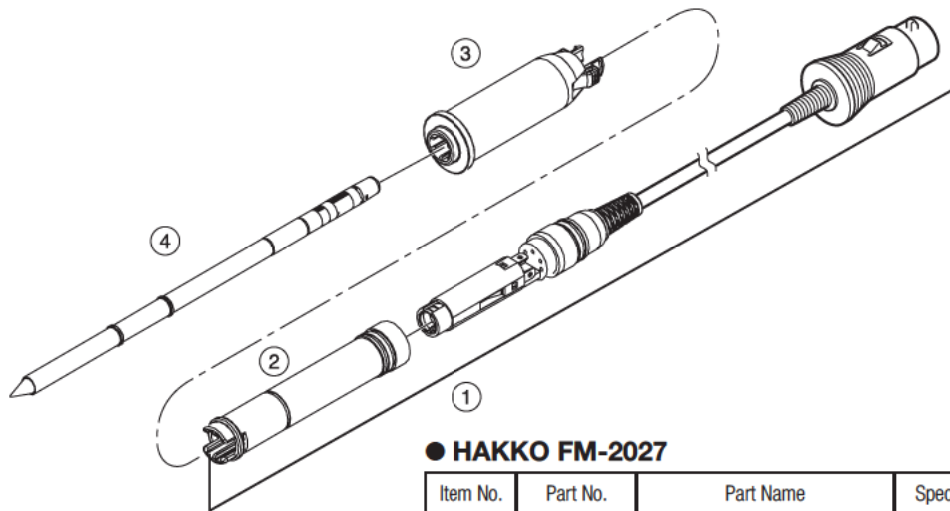

● HAKKO FM-2027

Item No.	Part No.	Part Name	Specifications
①	FM2027-02	Connector assembly	
②	B3215	Connector cover	
③	B3216	Sleeve assembly	Yellow
	B3217		Orange
	B3218		Blue
	B3219		Green
④		Tip	See section '11. TIP STYLES'
⑤	B2300	Heat resistant pad	

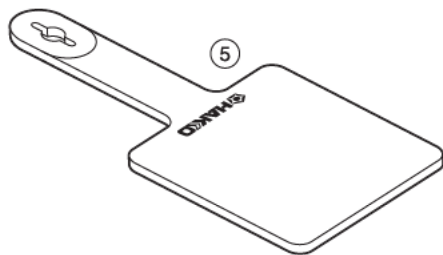

● Iron Holder

Item No.	Part No.	Part Name	Specifications
① - ⑨	FH200-01	Iron holder	

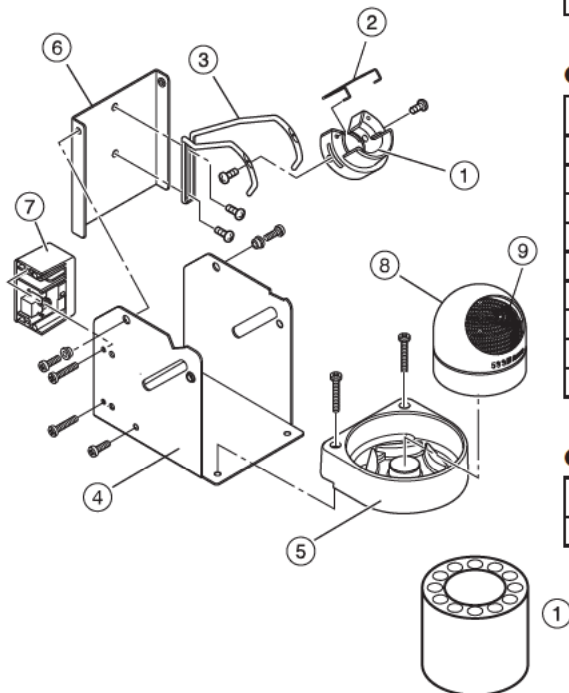

● Iron Holder Parts

Item No.	Part No.	Part Name	Specifications
①	B3001	Iron receptacle	With screws
②	B2791	Tip fixing spring	
③	B3248	Retaining clip	
④	B3251	Iron holder base	With rubber feet
⑤	B3249	Cleaner base	With rubber feet
⑥	B3250	Stay	
⑦	B3252	Switch case assembly	
⑧	599B-02	Tip cleaner	
⑨	599-029	Cleaning wire	

● Optional Parts

Item No.	Part No.	Part Name	Specifications
①	B2756	Tip tray	

12. TIP STYLES

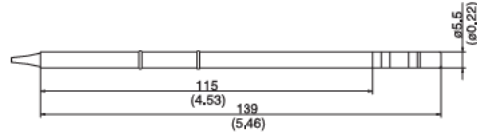

Unit: mm (in.)

SHAPE	T15-B SHAPE-B	T15-B2 SHAPE-0.5B	T15-B3 SHAPE-0.7B	T15-B4 SHAPE-0.4B	T15-BLL SHAPE-BL LONG
SHAPE B					
SHAPE BC	T15-BC1 SHAPE-1BC T15-BCF1* 	T15-BC2 SHAPE-2BC T15-BCF2* 	T15-BC3 SHAPE-3BC T15-BCF3* 	T15-BC12 SHAPE-1.2BC 	T15-BC15 SHAPE-1.5BC
SHAPE C	T15-C1 SHAPE-1C 	T15-CF2* SHAPE-2C 	T15-CF3* SHAPE-3C 	T15-C4 SHAPE-4C T15-CF4* 	
SHAPE D	T15-D08 SHAPE-0.8D 	T15-D12 SHAPE-1.2D 	T15-D16 SHAPE-1.6D 	T15-D2 SHAPE-2D 	T15-D24 SHAPE-2.4D
	T15-D32 SHAPE-3.2D 	T15-D4 SHAPE-4D 	T15-D52 SHAPE-5.2D 	T15-DL32 SHAPE-3.2D LONG 	
	T15-DL52 SHAPE-5.2D LONG 	T15-XD15 SHAPE-1.5XD 		T15-DL4 SHAPE-4D LONG 	
SHAPE I	T15-I SHAPE-I 	T15-IL SHAPE-IL 	T15-ILS SHAPE-ILS 		
SHAPE J	T15-J02 SHAPE-0.2J 	T15-JD14 SHAPE-1.4JD 	T15-JD16 SHAPE-1.6JD 	T15-JL02 SHAPE-0.2JL 	T15-JS02 SHAPE-0.2JS

SHAPE K	T15-K SHAPE-K	T15-KF SHAPE-KF	T15-KL SHAPE-KL	T15-KU SHAPE-KU		
SHAPE R	T15-R20 SHAPE-2.0R	T15-R23 SHAPE-2.3R	T15-R27 SHAPE-2.7R	T15-R34 SHAPE-3.4R	T15-R48 SHAPE-4.8R	
SHAPE SB	T15-SB02 SHAPE-0.2SB	T15-SB03 SHAPE-0.3SB	T15-SB05 SHAPE-0.5SB	T15-SB08 SHAPE-0.8SB	T15-SBC04 SHAPE-0.4SBC	
	T15-SBS04 SHAPE-0.4SBS	T15-SBS07 SHAPE-0.7SBS				
TUNNEL	T15-1001** TUNNEL 5.1x 4.6	T15-1002** TUNNEL 5.1x 10.4	T15-1003** TUNNEL 9.5x 18.3	T15-1004** TUNNEL 9.5x 15.8	T15-1005** TUNNEL 9.5x 13.2	
	T15-1006** TUNNEL 6.9x 11.4	T15-1007** TUNNEL 7.9x 18.8	T15-1008** TUNNEL 19.5x 10.2	T15-1009** TUNNEL 13.4x 20.5	T15-1010** TUNNEL 19.5x 12	
	QUAD	T15-1201** QUAD 13.6x 8.5	T15-1202** QUAD 10.3x 10.3	T15-1203** QUAD 12.8x 12.8	T15-1204** QUAD 17.9x 17.9	T15-1205** QUAD 23.4x 17.3
T15-1206** QUAD 22.5x 16.5		T15-1207** QUAD 15.5x 15.5	T15-1208** QUAD 15.8x 15.8	T15-1209** QUAD 8.4x 8.4	T15-1210** QUAD 15.4x 12.8	
SPATULA		T15-1401** SPATULA 10,4	T15-1402** SPATULA 15,7	T15-1403** SPATULA 21,2	T15-1406** SPATULA 40	
	SPECIAL APPLICATIONS TYPE	T15-1603** SHAPE-LONG REACH CHISEL	T15-1605** SHAPE-LONG REACH BENT CHISEL			

* Tinned on the soldering surface only.

The iron tips marked with double asterisks () have a temperature accuracy of $\pm 25^{\circ}\text{C}$ ($\pm 45^{\circ}\text{F}$) when used with the default offset. Others have a temperature accuracy of $\pm 15^{\circ}\text{C}$ ($\pm 27^{\circ}\text{F}$) when used with the default offset.

13. OPTIONAL PARTS LIST

● Optional Parts

Part No.	Part Name	Specifications
FM2022-05	Conversion kit	*1
FM2023-05	Conversion kit	For USA*1
FM2023-06	Conversion kit	For Europe*2
FM2024-21	Conversion kit	3 wired cord & American plug *3
FM2024-33	Conversion kit	3 wired cord & European Plug CE *3
FM2024-34	Conversion kit	3 wired cord & European plug CE (France) *3
FM2024-35	Conversion kit	3 wired cord & BS plug CE
FM2026-06	Conversion kit	*2
FM2027-03	Conversion kit	*2
FM2030-01	Handpiece only	
FM2030-02	Conversion kit	*4
FM2031-01	Handpiece only	
FM2031-02	Conversion kit	*4
FH200-03	Iron holder / FM-2022	With cleaning sponge
FH200-04	Iron holder / FM-2023	With cleaning sponge
FH200-05	Iron holder / FM-2024	With cleaning wire

*1 : With a sleep mode iron holder, connecting cable, heat resistant pad, cleaning sponge

*2 : With a sleep mode iron holder, connecting cable, heat resistant pad, 599B

*3 : With a sleep mode iron holder, connecting cable, 599B

*4 : With a sleep mode iron holder, connecting cable, heat resistant pad, 599B

● Tip Parts for HAKKO FM-2022

Part No.	Part Name	Specifications
T16-1001	Tip / CHIP 0.5I	
T16-1002	Tip / CHIP 0.5C	
T16-1003	Tip / CHIP 1L	
T16-1004	Tip / CHIP 2L	
T16-1005	Tip / SOP 6L	
T16-1006	Tip / SOP 8L	
T16-1007	Tip / SOP 10L	
T16-1008	Tip / SOP 13L	
T16-1009	Tip / SOP 16L	
T16-1010	Tip / SOP 20L	
T16-1011	Tip / SOP 25L	
T16-1012	Tip / SOP 18L	
T16-1013	Tip / CHIP 3L	

● Tip Parts for HAKKO FM-2023

Part No.	Part Name	Specifications
T9-I	Tip / CHIP I	
T9-L1	Tip / CHIP 1L	
T9-L2	Tip / CHIP 2L	

● Nozzle Parts for HAKKO FM-2024

Part No.	Part Name	Specifications
N3-06	Nozzle / 0.6mm (0.02 in.)	
N3-08	Nozzle / 0.8mm (0.03 in.)	
N3-10	Nozzle / 1.0mm (0.04 in.)	
N3-13	Nozzle / 1.3mm (0.05 in.)	
N3-16	Nozzle / 1.6mm (0.06 in.)	
N3-20	Nozzle / 2.0mm (0.08 in.)	
N3-23	Nozzle / 2.3mm (0.10 in.)	
N3-L10	Long Nozzle / 1.0mm (0.04 in.)	

● **Tip Parts for HAKKO FM-2026**

Part No.	Part Name	Specifications
T17-B2	SHAPE-0.5B Conical	
T17-BC1	SHAPE-1BC Bevel	
T17-BC2	SHAPE-2BC Bevel	
T17-BC3	SHAPE-3BC Bevel	
T17-BCF1	SHAPE-1BC Bevel	Tinned on the soldering surface only
T17-BCF2	SHAPE-2BC Bevel	Tinned on the soldering surface only
T17-BCF3	SHAPE-3BC Bevel	Tinned on the soldering surface only
T17-BL	SHAPE-B Long Shape Conical	
T17-D08	SHAPE-0.8D Chisel	
T17-D16	SHAPE-1.6D Chisel	
T17-D24	SHAPE-2.4D Chisel	
T17-J02	SHAPE-0.2J Bent	
T17-KF	SHAPE-KF Knife	
T17-KR	SHAPE-KR Knife	
T17-KU	SHAPE-KU Knife	

● **Tip Parts for HAKKO FM-2030/FM-2031**

Part No.	Part Name	Specifications
T22-BC2	SHAPE-2BC Bevel	
T22-BL	SHAPE-BL Long Shape Conical	
T22-BL2	SHAPE-2BL Long Shape Conical	
T22-C3	SHAPE-3C Bevel	
T22-C5	SHAPE-5C Bevel	
T22-C6	SHAPE-6C Bevel	
T22-D08	SHAPE-0.8D Chisel	
T22-D12	SHAPE-1.2D Chisel	
T22-D16	SHAPE-1.6D Chisel	
T22-D24	SHAPE-2.4D Chisel	
T22-D32	SHAPE-3.2D Chisel	
T22-D45	SHAPE-4.5D Chisel	
T22-D52	SHAPE-5.2D Chisel	
T22-J02	SHAPE-0.2J Bent	
T22-JD08	SHAPE-0.8JD Bent Chisel	
T22-K	SHAPE-K Knife	

● **Iron Holder Parts**

Part No.	Part Name	Specifications
B3411	Iron holder assembly / FM-2022	With screw
B3412	Iron holder assembly / FM-2023	With screw
B3413	Iron holder assembly / FM-2024	With screw

14. WIRING DIAGRAM

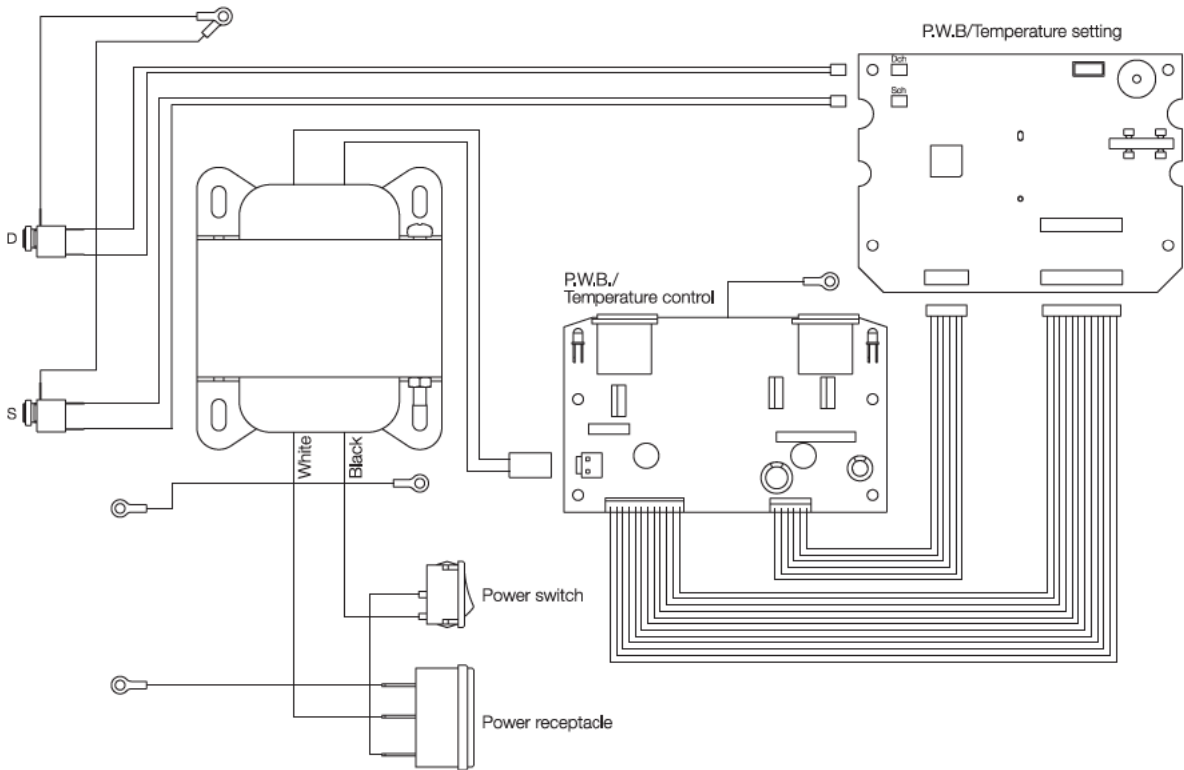

HAKKO CORPORATION

HEAD OFFICE

TEL:+81-6-6561-3225 FAX:+81-6-6561-8466

<http://www.hakko.com> E-mail:sales@hakko.com

OVERSEAS AFFILIATES

U.S.A.: AMERICAN HAKKO PRODUCTS, INC.

TEL: (661) 294-0090 FAX: (661) 294-0096

Toll Free (800)88-HAKKO

<http://www.hakkousa.com>

HONG KONG: HAKKO DEVELOPMENT CO., LTD.

TEL: 2811-5588 FAX: 2590-0217

<http://www.hakko.com.hk>

E-mail:info@hakko.com.hk

SINGAPORE: HAKKO PRODUCTS PTE., LTD.

TEL: 6748-2277 FAX: 6744-0033

<http://www.hakko.com.sg>

E-mail:sales@hakko.com.sg

Please access to the following address for the other Sales affiliates.

<http://www.hakko.com>