

Thank you for purchasing the HAKKO FM-2032 Soldering Iron.
Please read this manual before operating the HAKKO FM-2032.
Keep this manual readily accessible for reference.

CAUTION

The HAKKO FM-2032 cannot be operated by itself. Please refer to the instruction manual of the compatible stations when used in conjunction with the HAKKO FM-2032.

1. PACKING LIST AND PART NAMES

Please check to make sure that all items listed below are included in the package.

HAKKO FM-2032	1	Iron holder	1
Heat resistant pad	1	Connecting cable	1
Instruction Manual	1		

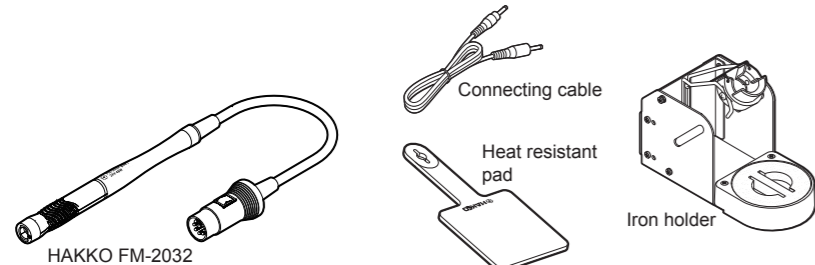

2. SPECIFICATIONS

● HAKKO FM-2032

Power Consumption	48W (24V)
Tip to Ground Resistance	< 2 Ω
Tip to Ground Potential	< 2 mV
Length of cord	1.3 m (4.3 ft.)
Length (w/o cord)	170 mm (6.7 in.) with 1D tip
Weight (w/o cord)	14 g (0.03lb) with 1D tip

* Specifications and design are subject to change without notice.

* This product is protected against electrostatic discharge.

■ Electrostatic Protection

This product includes such features as electrically conductive plastic parts and grounding of the handpiece and station as measures to protect the device to be soldered from the effects of static electricity. Be sure to observe the following instructions:

1. The handle and other plastic parts are not insulators, they are conductors. When replacing parts or repairing, take sufficient care not to expose live electrical parts or damage insulation materials.
2. Be sure to ground the unit during use.

※ 各言語（日本語、英語、中国語、フランス語、ドイツ語、韓国語）の取扱説明書は以下のURL、HAKKO Document Portalからダウンロードしてご覧いただけます。
（商品によっては設定の無い言語がありますが、ご了承ください）
• 各言語（日本語、英語、中文、法語、ドイツ語、韓国語）の使用説明書は以下のURLのHAKKO Document Portal からダウンロード可能。
（有一部分の產品沒有設定外語對應，請見說明書）
• Instruction manual in the language of Japanese, English, Chinese, French, German and Korean can be downloaded from the HAKKO Document Portal.
(Please note that some languages may not be available depending on the product.)

<https://doc.hakko.com>

4. WARNINGS, CAUTIONS, NOTES AND EXAMPLES

Warnings, cautions and notes are placed at critical points in this manual to direct the operator's attention to significant items. They are defined as follows:

- ⚠ **WARNING:** Failure to comply with a WARNING may result in serious injury or death.
- ⚠ **CAUTION:** Failure to comply with a CAUTION may result in injury to the operator, or damage to the items involved.

NOTE: A NOTE indicates a procedure or point that is important to the process being described.
EXAMPLE: An EXAMPLE is given to demonstrate a particular procedure, point or process.

WARNINGS

When power is ON, tip temperatures will be between 200 and 450°C. To avoid injury or damage to personnel and items in the work area, observe the following:

- Do not touch the tip or the metal parts near the tip.
- Do not allow the tip to come close to, or touch, flammable materials.
- Inform others in the area that the unit is hot and should not be touched.
- Turn the power off when not in use, or left unattended.
- Turn the power off when changing parts or storing the HAKKO FM-2032.
- This appliance is not intended for use by persons (including children) with reduced physical, sensory or mental capabilities, or lack of experience and knowledge, unless they have been given supervision or instruction concerning use of the appliance by a person responsible for their safety.
- Children should be supervised to ensure that they do not play with the appliance.

● To prevent accidents or damage to the HAKKO FM-2032, be sure to observe the followings:

CAUTION

- Do not use the HAKKO FM-2032 for applications other than soldering.
- Do not strike the iron against hard objects to remove excess solder. This will damage the iron.
- Do not modify the unit.
- Use only genuine HAKKO replacement parts.
- Do not allow the HAKKO FM-2032 to become wet, or use it when hands are wet.
- Be sure to hold the plug when inserting or removing the iron cord.
- Since smoke is produced when using the HAKKO FM-2032, be sure the work area is well ventilated.
- While using the HAKKO FM-2032, do not do anything which may cause bodily harm or physical damage.

5. INITIAL SETUP

CAUTION

- The tip may be hot. Avoid holding the hot tip for a long time even if using the heat resistant pad. Otherwise burns may result.
- Applying excessive force can cause a bend of the tip. Do not strike or press the tip on the P.W.B.

● Connection

A. Insert the tip:

Hold the head part of the tip with the heat resistant pad and insert the tip into the handpiece. Push until the tip stops. (Fig.1)

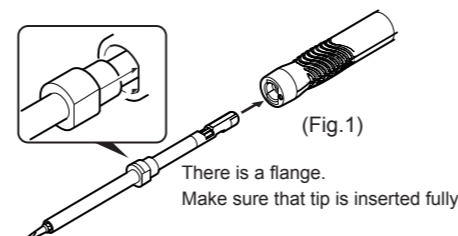

NOTE:
Please use only T30 Series Tips.

B. Soldering iron

Pass the iron cord through the hole in the heat resistant pad. (Fig.2)

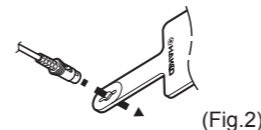

C. Station

Connect the cord assembly to the receptacle of the compatible stations. (Fig.3)

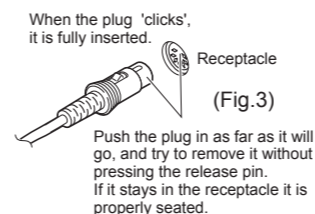

CAUTION

- When connecting or disconnecting the cord assembly, hold the plug.
- Be sure to turn off the power switch before connecting or disconnecting the cord assembly to and from the receptacle to avoid damaging the unit.

D. Use of the sleep function

When using the sleep function, insert one end of the connecting cable into the jack at the back of the handpiece holder and the other end into the jack at the back of the station to connect them. (Fig.4)

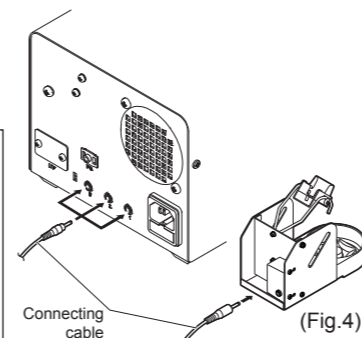

CAUTION

- Please make sure the power is off when you plug in cables.
- Please make sure to hook up the connector cable and the iron holder on the same channel and not to place the iron in a holder connected to a differing channel when using the HAKKO FM-203 or FM-206.

6. OPERATION

● For operation

Please refer to the instruction manual of the compatible stations when used in conjunction with the HAKKO FM-2032.

7. CHECKING PROCEDURE

CAUTION

Unless otherwise directed, carry out these procedures with the power switch OFF and the power UNPLUGGED.

● Check for a broken heater or sensor

Measure the resistance while at room temperature (15 to 25°C ; 59 to 77°F). It should be 12Ω±10%. If the resistance exceeds these limits, replace the tip.

Measure the resistance across the tip as shown.

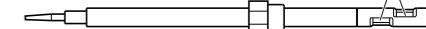

● Check the grounding line

1. Unplug the connection cord from the station.
2. Measure the resistance value between pin 2 and the tip (both tips).
3. If the resistance value is higher than 2Ω (at room temperature), clean the tip to remove oxidation or replace the tip with a new one. If the resistance value still does not decrease, check the connection cord for breakage.

● Checking the connection cord for breakage

Measure the resistance value between two pins.

Pin 1 - Pin 3 11.5 - 12.5Ω

If the measured value exceeds above values, replace the HAKKO FM-2032.

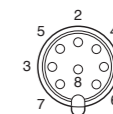

8. PARTS LIST

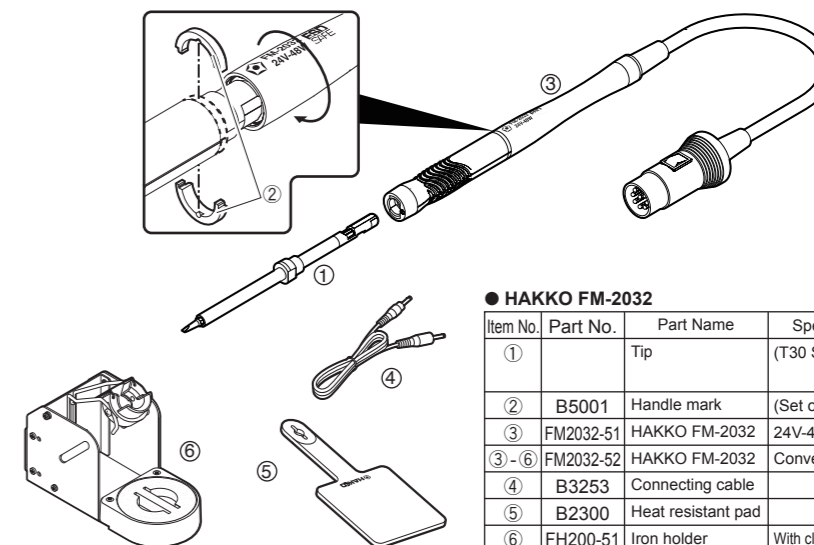

● HAKKO FM-2032

Item No.	Part No.	Part Name	Specifications
①		Tip	(T30 Series)
②	B5001	Handle mark	(Set of 2)
③	FM2032-51	HAKKO FM-2032	24V-48W
③-⑥	FM2032-52	HAKKO FM-2032	Conversion kit
④	B3253	Connecting cable	
⑤	B2300	Heat resistant pad	
⑥	FH200-51	Iron holder	With cleaning sponge

● Iron Holder Parts

Item No.	Part No.	Part Name	Specifications
①	B5000	Iron receptacle	With screws
②	B2791	Tip fixing spring	
③	B3248	Retaining clip	
④	B3251	Iron holder base	With rubber feet
⑤	A1536	cleaning sponge	
⑥	B3249	Cleaner base	With rubber feet
⑦	B3250	Stay	
⑧	B3252	Switch case assembly	