

HAKKO FR-803B SMD REWORK STATION

SMD Rework Station with Vacuum Pickup

Instruction Manual



Thank you for purchasing the HAKKO FR-803B SMD Rework Station.

This unit features:

- Digital control and display of time and temperature
- Display of air-flow rate
- Manual and automatic modes
- Built-in vacuum pickup

Please read this manual before operating the HAKKO FR-803B.

Keep this manual readily accessible for reference.



TABLE OF CONTENTS

1. PACKING LIST	1
2. SPECIFICATIONS	1
3. WARNINGS, CAUTIONS, AND NOTES	2
4. PART NAMES	3
5. PREPARATION: ASSEMBLY AND ELECTRICAL CONNECTION	5
6. OPERATION	8
7. PARAMETERS	17
8. OFFSET SETTING METHOD	18
9. MAINTENANCE / INSPECTION	19
10. ERRO MESSAGE	20
11. TROUBLESHOOTING	20
12. OPTINAL PARTS	21
13. PARTS LIST / STATION	23
13. PARTS LIST / HANDPIECE	25
14. WIRING DIAGRAM	26

1. PACKING LIST

Check the contents of the Hakko 852 package and confirm that all the items listed below are included.

HAKKO FR-803B station.....	1
Power cord	1
Handpiece holder	1
Pads (ø3 mm (0.12 in.), ø5 mm (0.20 in.), ø7.6 mm (0.3 in.).....)	2 each
Vacuum pipe control knob (L).....	1
Control card.....	1

Connecting cord	1
Instruction manual	1

* This product does not include a nozzle. A large selection of nozzles are available for the HAKKO FR-803B. Select the nozzle or nozzles suitable for the work to be performed.

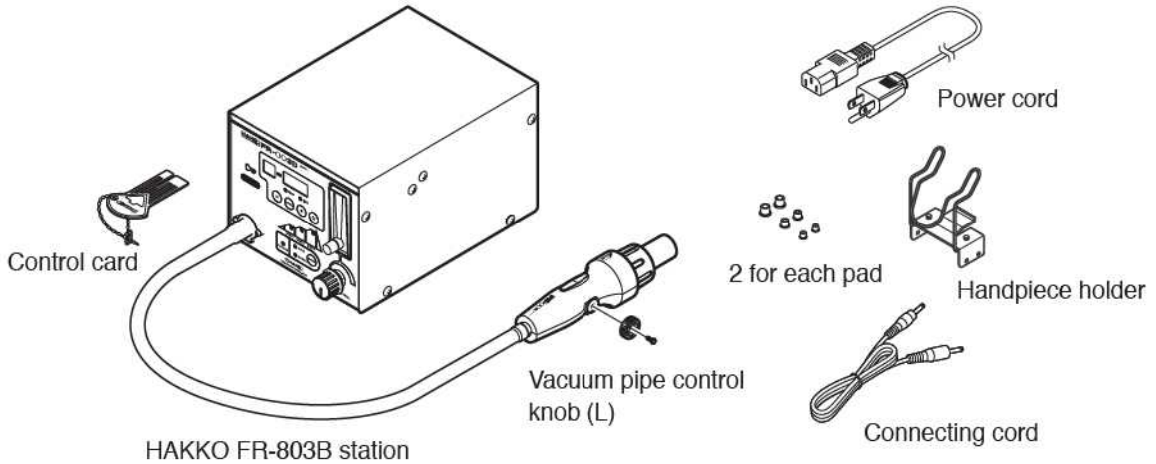

2. SPECIFICATIONS

Name	HAKKO FR-803B
Power consumption	100V-310W 110V-370W 120V-440W 220V-590W 230V-650W 240V-700W

● Station

Power consumption	100V 30 W 110-120V 40W 220-240V 50W (Standby, 100-120V 4W, 220-240V 4W)
Capacity	5 ℓ/min to more than 20 ℓ/min
Control temperature	100 ~ 500°C/200 ~ 930°F (sensor)
Modes	Manual/Auto
Timer	50 file/step
External dimensions	160 (W) × 145 (H) × 230 (D) mm/ 6.3 × 5.7 × 9.1 in.
Weight	5 kg (11.02 lb.)

● Handpiece

Power consumption	100V-280W 110V-330W 120V-400W 220V-540W 230V-600W 240V-650W
Total length (w/o cord)	200mm/7.9 in.
Weight (w/o cord)	200 g/0.44 lb.

NOTE:

- * This product is protected against electrostatic discharge.
- * This product meets China RoHS requirements.
- * Specifications and design are subject to change without notice.

■ Electrostatic Protection

This product includes such features as electrically conductive plastic parts and grounding of the handpiece and station as measures to protect the device to be soldered from the effects of static electricity. Be sure to observe the following instructions:

1. The handle and other plastic parts are not insulators, they are conductors. When replacing parts or repairing, take sufficient care not to expose live electrical parts or damage insulation materials.
2. Be sure to ground the unit during use.

中國RoHS: 產品中有毒有害物質或元素的名稱及含量

部件名稱	有毒有害物質或元素					
	鉛(Pb)	汞(Hg)	鎘(Cd)	六價鉻 (Cr(VI))	多溴聯苯 (PBB)	多溴二苯醚 (PBDE)
插頭	×	○	○	○	○	○
排氣噴嘴	×	○	○	○	○	○

○ : 表示該有毒有害物質在該部件所有均質材料中的含量均在SJ/T 11363-2006 標準規定的限量要求以下。
 × : 表示該有毒有害物質至少在該部件的某一均質材料中的含量超出 SJ/T 11363-2006 標準規定的限量要求。

注有「附帶BS插頭」之時，表示「插頭」為含有有害物質的部件。

3. WARNINGS, CAUTIONS, AND NOTES

WARNING

Warnings and cautions are placed at critical points in this manual to direct the operator's attention to significant items. They are defined as follows:

 **WARNING** : Failure to comply with a WARNING may result in serious injury or death.

 **CAUTION** : Failure to comply with a CAUTION may result in injury to the operator, or damage to the items involved.

NOTE : A NOTE indicates a procedure or point that is important to the process being described.

EXAMPLE : An EXAMPLE is given to demonstrate a particular procedure point or process.

WARNING

To avoid damage to the unit, do not turn the power switch OFF until the pump stops automatically by cooling down (until  appears on the display) after use.

CAUTION

When the power is ON, the temperature of the hot air and the nozzle ranges from 100 to 500°C (200 to 930°F.). To avoid injury to personnel or damage to items in the work area, observe the following:

- Do not direct the hot air toward personnel or touch the metal parts near the nozzle.
- Do not use the product near combustible gases or flammable materials.
- Advise those in the work area that the unit can reach very high temperatures and should be considered potentially dangerous.
- Turn the power OFF when no longer using the HAKKO FR-803B or when leaving it unattended.
- Before replacing parts or storing the unit, allow the unit to cool and then turn the power OFF.
- Do not use the product for a long time at the same place.

Observe the following precautions to prevent accidents or damage to the unit.

- Do not strike the handpiece against hard surface or otherwise subject it to physical shock.
- Be sure the unit is grounded. Always connect power to a grounded receptacle.
- Do not disassemble the pump or the vacuum pump.
- Do not modify the unit.
- Use only genuine HAKKO replacement parts.
- Do not wet the unit or use the unit with wet hands.
- Remove power cord by holding the plug – not the wires.
- Do not leave the vacuum pump on for long periods of time.
- Make sure the work area is well ventilated.
- While using the HAKKO FR-803B, don't do anything which may cause bodily harm or physical damage.

4. PART NAMES

Station

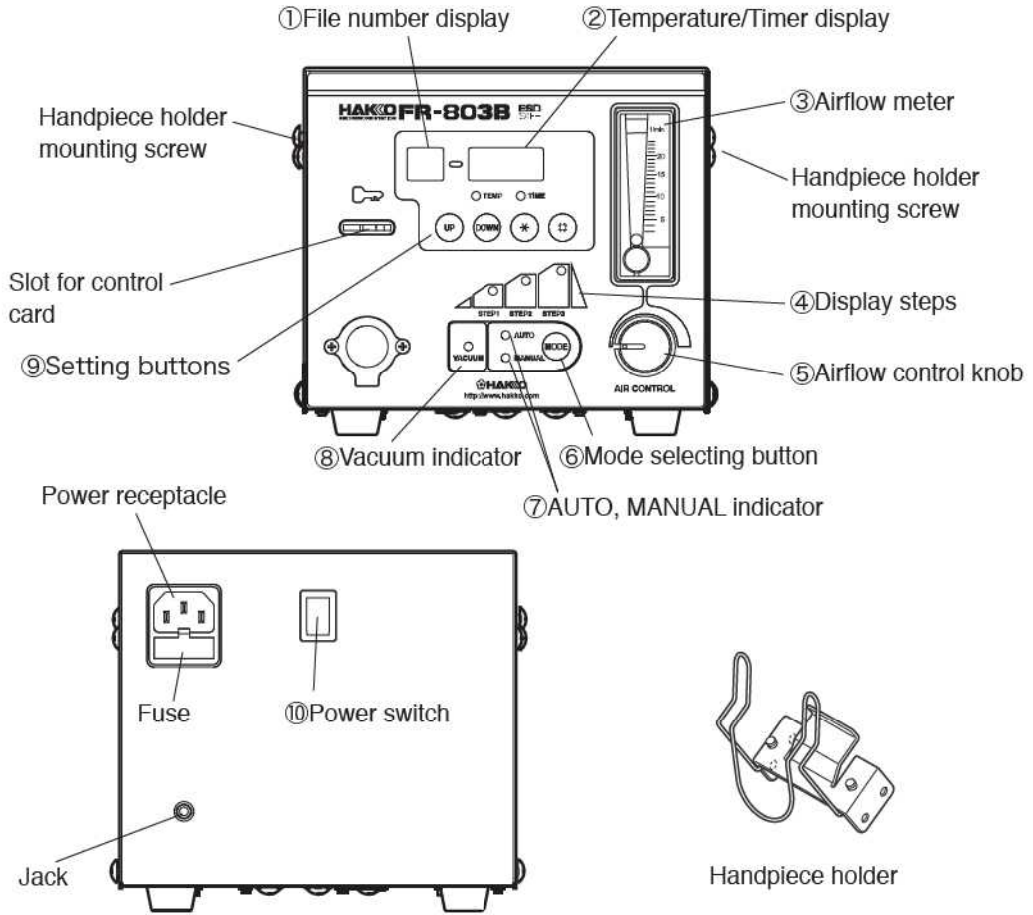

Handpiece

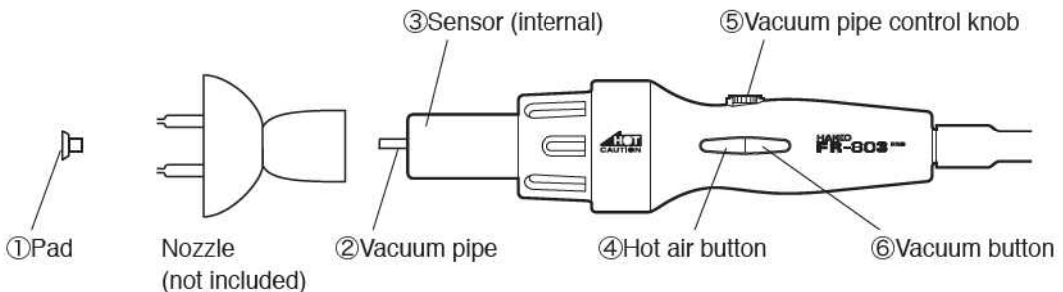

Station

- ① File number display
- ② Temperature/timer display

- ③ Airflow meter
- ④ Display steps
- ⑤ Airflow control knob

- ⑥ Mode selection button
- ⑦ AUTO/MANUAL indicator
- ⑧ Vacuum indicator
- ⑨ Setting button

- ⑩ Power switch

Handpiece

- ① Pad
- ② Vacuum pipe
- ③ Sensor (internal)
- ④ Hot air button

- ⑤ Vacuum pipe control knob
- ⑥ Vacuum button

This section displays files 1 to 50 in Auto mode.

This section displays a temperature and timer setting time for each step in AUTO mode.

CAUTION

The displayed and set temperature indicates the temperatures at the sensor.

This meter indicates the airflow rate.

This section will be lit during every step in AUTO mode.

This knob controls the airflow. The airflow can be set in the range of 5 to 20 l/min.

This button displays and selects the MANUAL and AUTO modes.

This indicator lights the selected mode.

This indicator lights when the vacuum pump is in operation.

Use this button for setting, determining and checking the file number, temperature, timer, etc.

This switch turns the power ON and OFF.

The pad absorbs parts.

The pad is mounted on the tip of the vacuum pipe.

This sensor detects the temperature of the hot air.

● MANUAL Mode

When the Start button is pressed, the unit begins blowing hot air. When the Start button is pressed again, the unit begins cooling and stops blowing hot air after reaching 100°C (200°F).

● AUTO Mode

When the Start button is pressed again, the selected AUTO program begins.

This knob controls the length of the vacuum pipe.

This button turns the vacuum pump ON and OFF.

5. PREPARATION: ASSEMBLY AND ELECTRICAL CONNECTION

A. Station Assembly

- **Attach the handpiece holder.**
Remove the handpiece holder mounting screw from the side of the station. Attach the handpiece holder to the station. (Figure 1)
(The handpiece holder can be installed on either the left or right side.)

B. Handpiece Assembly

NOTE:

The handpiece can be used with the provided vacuum pipe control knob (L). (See figure 2.)

- **Using vacuum function operative nozzle (see page 21.)**
 - 1. Attach the nozzle.**
 - a. Extend the vacuum pipe using the vacuum pipe control knob. (Figure 3)
 - b. Remove the inside screw (M3 × 5) of the nozzle. (Figure 4)
 - c. Loosen the nozzle mounting screw. Pass the vacuum pipe through the nozzle hole and attach the nozzle. (Figure 5)
 - d. Tighten the nozzle mounting screw.
 - 2. Attach the pad.**
 - a. Attach the pad. (Figure 7)
 - b. Adjust the pad to an appropriate position. Adjust the vacuum pipe so that the pipe and pad protrude as little as possible.

CAUTION

The nozzle and pad will be heated at high temperature. Cool them before replacement.

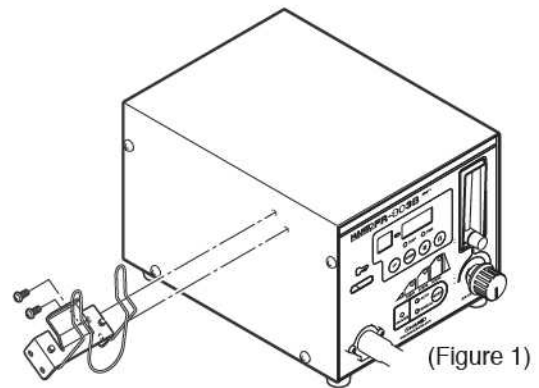

(Figure 1)

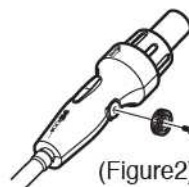

(Figure 2)

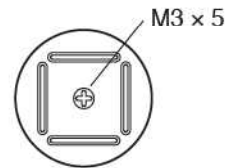

(Figure 4)

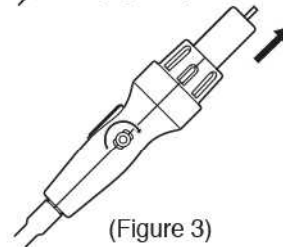

(Figure 3)

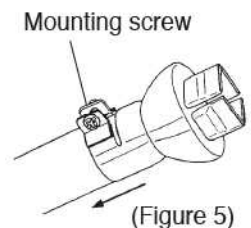

(Figure 5)

CAUTION

● Vacuum pipe

Do not use excessive force.

When not using a nozzle, retract the vacuum pipe to the shortest length. (Figure 6)



(Figure 6)

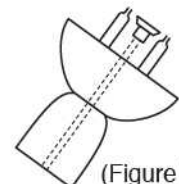

(Figure 7)

CAUTION

● Pad

The pad does not last indefinitely. When it becomes deteriorated, replace it. Since exposure to high temperatures causes it to deteriorate faster, Hakko recommends it be cooled after use.

- Using vacuum function inoperative nozzle (see page 22.)

■ Attach the nozzle.

- Retract the vacuum pipe to the shortest length using the vacuum pipe control knob. (See page 5, Figure 6)
- Loosen the nozzle mounting screw. Attach the nozzle. (See page 5, Figure 5)
- Tighten the nozzle mounting screw.

CAUTION
The pad cannot be used with this type of nozzle.

- Connection with FR-820

FR-820 can be connected to FR-803B with the junction cord, which permits FR-820 to be used along with FR-803B running in AUTO mode.

CAUTION
Make sure the power to FR-803B is OFF before connecting FR-820 to FR-803B.

C. Electrical Connection and Power ON

1. Connect the power cord to the power receptacle on the back panel of the station. (Figure 8)
2. Place the handpiece on the holder. (Figure 9)
3. Plug the power cord into a grounded wall socket.
4. Turn the power switch ON.

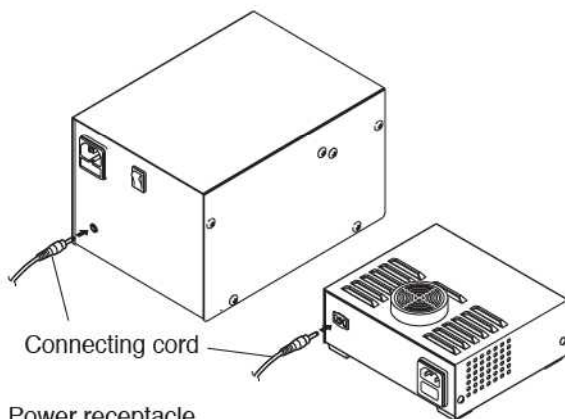

Connecting cord

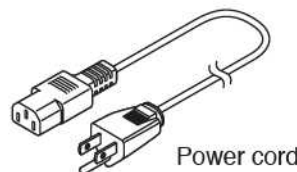
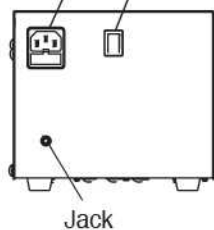

Jack

Power cord

(Figure 8)

CAUTION
This product is ESD-protected. Be sure to use a grounded wall socket.

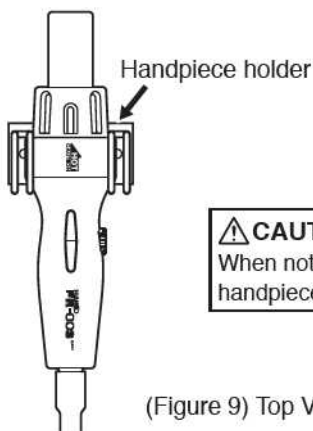

Handpiece holder

CAUTION
When not in use, place the handpiece on the holder.

(Figure 9) Top View

6. OPERATION

A. Mode Selection

Insert the control card into the card slot and select your desired mode using the mode selection button. (Figure 10)

The HAKKO FR-803B provides the following two modes. The AUTO mode consists of the INSTALL and REMOVE modes.

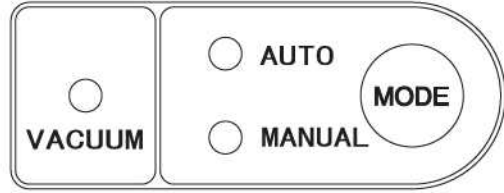

(Figure 10)

- **Manual Mode**

In this mode, air and vacuum pump operation are controlled entirely by manual operation.

NOTE:
The timer cannot be set when using MANUAL mode.

- **AUTO mode**

- **Install Mode (AUTO) (See page 14.)**

This mode is used when installing parts. The vacuum pump will be automatically turned OFF.

- **Remove Mode (AUTO) (See page 13.)**

This mode is used when removing parts. The vacuum pump will be automatically turned ON.

In INSTALL mode, turn ON the vacuum function manually and align the component on the PWB. Vacuum function automatically will turn OFF 5 seconds after starting selected the profile.

In REMOVE mode, the vacuum function automatically turns ON during the last 10 seconds of the selected profile. Set the temperature profile shown in the following figure in advance.

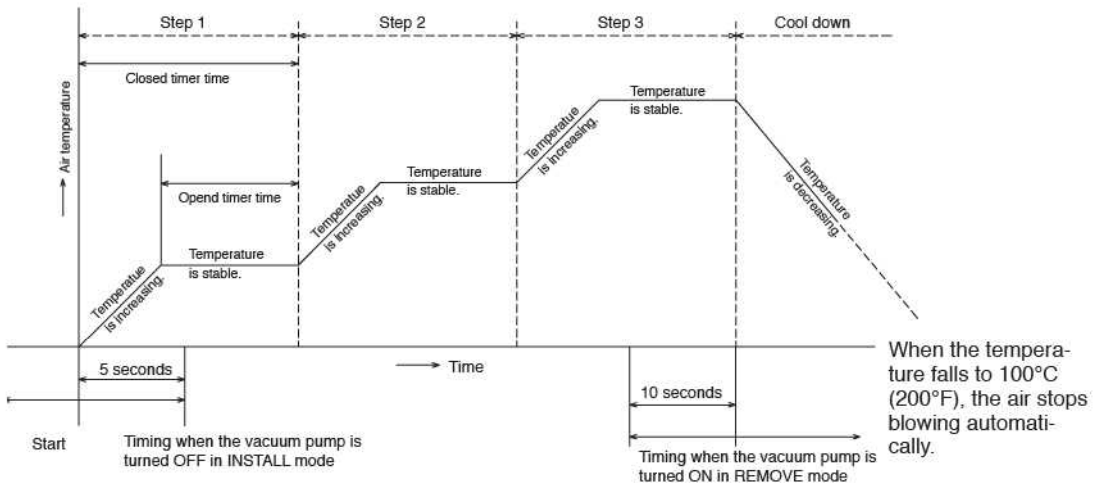

* In REMOVE mode, turn OFF the vacuum pump manually.

6. OPERATION

B. Selecting Manual Mode

The temperature/timer is displayed by **P-5**.
The HAKKO FR-803B is preset at 300°C at the factory, see page 9.

● Air Blow

1. Start

Press the HOT AIR button on the hand-piece to start the flow of air. The hot air blows from the tip of the nozzle, and the temperature is controlled according to the temperature setting.

2. Stop

Press the HOT AIR button again. Power to the heater is shut off and cooling begins. When the temperature falls to 100 °C. (200°F.), the air stops blowing and the temperature display reads **P-5**.

NOTE:

When the forced air shutoff function is enabled (ON), pressing the HOT AIR button again stops blowing air provided that the temperature readout is lower than 380°C.

● Vacuum Function

This function is used to hold the component securely to the pads.

1. Start

Press the Vacuum button on the hand-piece. The vacuum pump turns ON and the part is held by suction.

2. Stop

Press and hold the Vacuum button. The vacuum pump turns OFF.

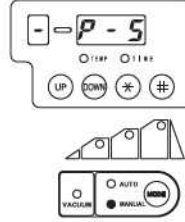

To check the set temperature, press the ***** button.

⚠ CAUTION

To avoid damage to the equipment, do not turn the power switch OFF until **P-5** appears on the display.

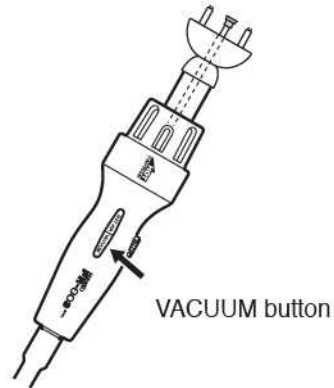
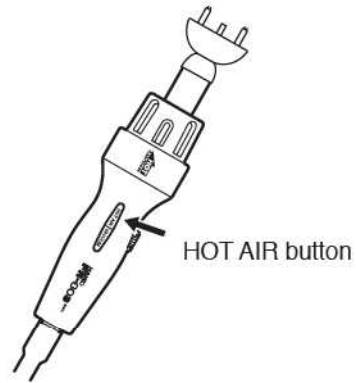

⚠ CAUTION

Parts held by the pads are very hot. Be careful when removing them from the pads.

6. OPERATION

C. Temperature change method in MANUAL mode

⚠ CAUTION

Be sure to insert the control card into the card slot and set the mode to MANUAL before changing.

Setting change in temperature

⚠ CAUTION

The temperature setting range is 100 to 500°C (200 to 930°F).

Example: Change the temperature setting from 300 to 450°C.

1. Press the **✳** button on the temperature setting section for 1 sec. or more.
 - The HUNDREDS digit flashes on the display, indicating that the HUNDREDS digit can be entered.
2. Enter the HUNDREDS digit.
 - Use the **UP** or **DOWN** buttons to select your desired value for the HUNDREDS digit. When your desired value is displayed, press the **✳** button. The TENS digit begins to flash.
3. Enter TENS digit.
 - Use the **UP** or **DOWN** buttons to select your desired value for the TENS digit. When your desired value is displayed, press the **✳** button. The UNITS digit begins to flash.
4. Enter the UNITS digit.
 - Select your desired value for the UNITS digit in the same manner as for the TENS digit. When your desired value is displayed, press the **✳** button. **SET** displays and indicates that the temperature setting procedure is completed.

⚠ CAUTION

If the power is turned OFF before the temperature setting procedure is completed (**SET** is not displayed), the new setting value will not be stored in memory.



- Attempting to enter a value outside the setting range will cause the display to begin flashing the HUNDREDS digit again. Reenter a correct value.
- Both the display temperature and the temperature setting are the temperature at the sensor. (Even with the same temperature setting, the temperature of the hot air differs depending on the nozzle size.)

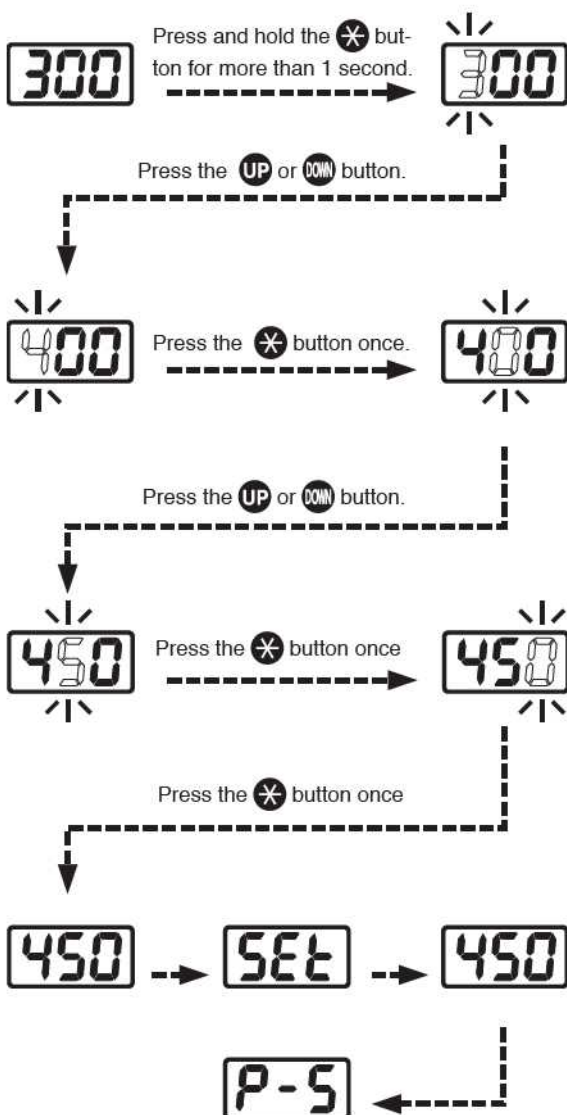

D. Setting method in AUTO mode

⚠ CAUTION



Be sure to press the  button and set the mode to AUTO.

The temperature profiles from 1 to 3 have been initially set. If it is necessary to change, see page 13.

1. Opening up a file

⚠ CAUTION

Be sure to insert the control card before opening.

Display a file number using the  or  button.

NOTE:

If the file number is not changed, it is unnecessary to insert the control card.

When a desired file number appears, press the  button. The file number is changed.

2. Pressing the HOT AIR button on the handpiece causes the unit to begin to blow, and setting the temperature profile causes it to start the file program.

NOTE:

When FR-820 has been connected to FR-803B with the junction cord, pressing the HOT AIR button also starts FR-820 blowing air. In such a case, the cool down timing is also synchronized in both the products.

3. When all the steps are completed, the unit will be automatically stopped.

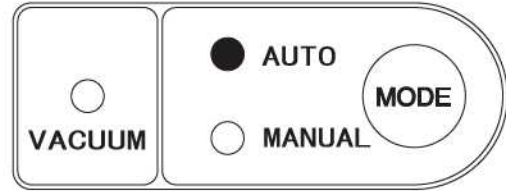

Press the  or  button.



Press the  button.



Step 1



Step 2

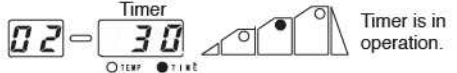
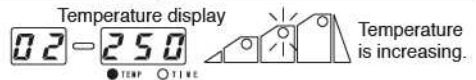

Step 3

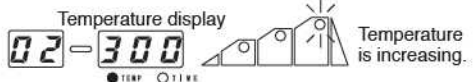

Cool down

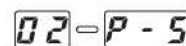
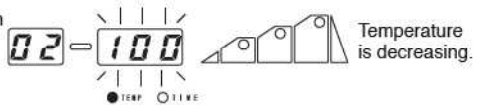

6. OPERATION

D-1 Setting method in AUTO/INSTALL mode

● Operations in INSTALL mode

This mode has the following sequence:

- ① Vacuum ON (Manual)
- ② Start/hot air blow (Manual)(Step/start)
- ③ Vacuum OFF after 5 seconds
- ④ Step 1 operation
- ⑤ Step 2 operation
- ⑥ Step 3 operation
- ⑦ Cool down operation

NOTE:

The operation can be set from 1 to 50.

● Installation

• Advance preparation of P.W.B.
Apply an appropriate amount of solder paste to the P.W.B.)

① Part suction and positioning

Press the VACUUM button on the handpiece. Have the part sucked by the pads and position the part on the P.W.B. (Figure 1)

② Start (heating)

Press the HOT button on the handpiece. Hot air blows from the nozzle to melt the solder. The station operates based on the preprogrammed temperature profile. (Figure 2)

⚠ CAUTION

To stop the program, press the HOT AIR button. Cooling begins.

③ Vacuum stop

After 5 seconds, the vacuum turns OFF and the part is released from suction. (Figure 3)

④ Stop

When the step operation is completed, cooling begins. Make sure the solder has hardened before lifting the handpiece. (Figure 4)

In INSTALL mode, press the HOT AIR button after turning the vacuum function ON manually and aligning the component on the PWB. Vacuum function automatically will turn OFF 5 seconds after starting selected the profile.

To check the temperature setting, press the * button. To change the temperature setting, see "Setting method in AUTO mode" on page 13.

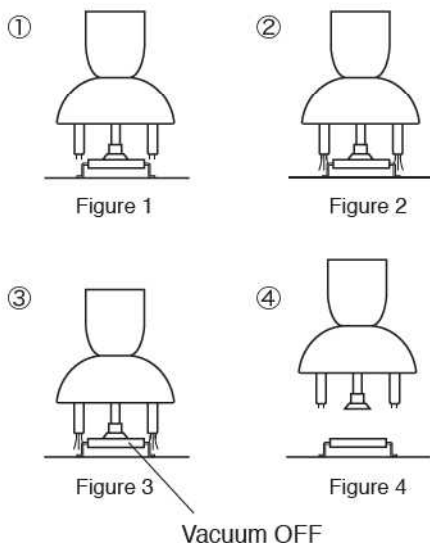

D-2 Setting method in AUTO/REMOVE mode

● Operations in REMOVE mode

This mode has the following sequence:

- ① Start/hot air blow (manual)
- ② Step 1 operation
- ③ Step 2 operation
- ④ Step 3 operation
- ⑤ Ten seconds before the last step is completed, the vacuum automatically turns ON and then a single sound lasting 1 second is generated. Two seconds before completion, a continuous sound is generated.
- ⑥ Vacuum OFF (manual)
- ⑦ Cool down

NOTE:

The operation can be set from 1 to 50.

● Removal

• Parts mounting

Mount the nozzle and pads on the part to be removed. (Figure 1)

① Start (heating)

Press the HOT AIR button on the handpiece. Hot air blows from the nozzle and melts the solder. The station operates based on the preprogrammed temperature profile. (Figure 2)

⚠ CAUTION

To stop the program, press the HOT AIR button. Cooling begins.

② Part suction

When the timer runs down to 10 sec., the vacuum automatically turns ON and the part is sucked. Lift the handpiece and remove the part from the P.W.B. (Figure 3)

③ Releasing the sucked part

To release the sucked part, press the VACUUM button. (Figure 3)

④ Stop

After that, when the step operation is completed, cooling begins and the airflow stops as soon as the temperature reaches 100°C (200°F). (Figure 4)

In REMOVE mode, the vacuum function automatically turns ON during the last 10 seconds of the selected profile.

To check the set temperature, press the  button. To change the set temperature, see “Setting mode in AUTO mode” on page 13.

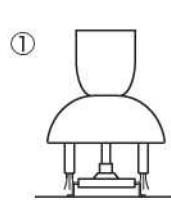

Figure 1

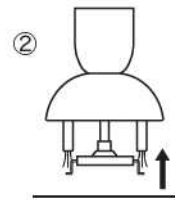

Figure 2

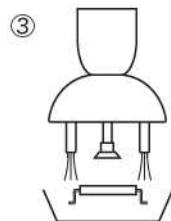

Figure 3

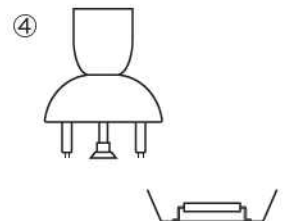

Figure 4

⚠ CAUTION

If the vacuum button is pressed before the timer runs down to 10 seconds, the vacuum pump turns ON. Press the vacuum button again to stop the air blowing.

6. OPERATION

E. File changing method in AUTO mode

⚠ CAUTION

Be sure to insert the control card into the card slot before changing.

File initial setting

Mode		INSTALL
Step 1	Setting temperature	200
	timer time	30
Step 2	Setting temperature	250
	timer time	30
Step 3	Setting temperature	300
	timer time	30



Example: When file 2 is changed as follows:

Mode		File 2
		REMOVE
Step 1	Setting temperature	250
	timer time	25
Step 2	Setting temperature	250
	timer time	30
Step 3	Setting temperature	320
	timer time	25

1. If the **✖** button is pressed for 1 second or more, the file number display section flashes. Select the file number using the **UP** or **DOWN** button. If your desired file number is displayed, press the **✖** button. The mode will be shifted to the **INSTALL or REMOVE selection mode**.
2. Use the **UP** or **DOWN** button to display . Then, press the **✖** button to select and shift to the **step selection mode**.
3. Select your desired step using the **UP** or **DOWN** button. Display your desired step and press the **✖** button to select. After that, the mode will be shifted to **temperature setting mode in step 1**.

NOTE:



The temperature setting range:
100°C - 500°C (200°F - 930°F).
The time setting range:
0 sec. - 300 sec. (0 min. - 5 min.)

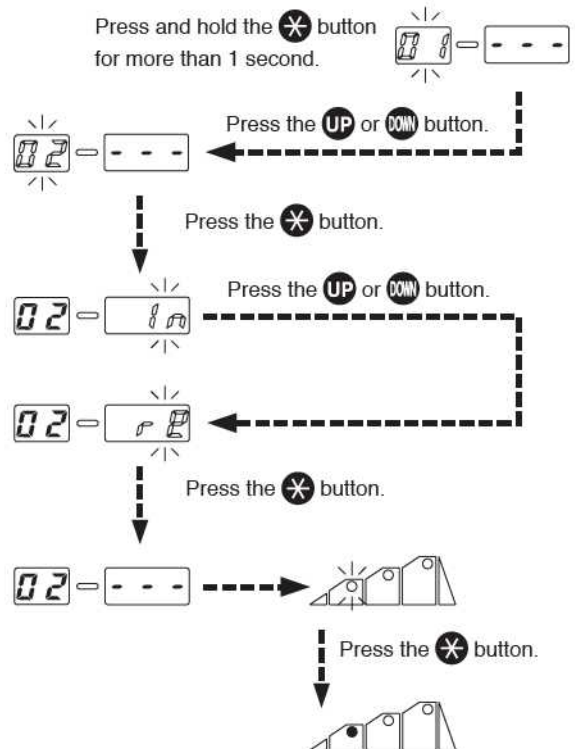



- Attempt to enter a value outside the setting range will cause the display to begin flashing the HUNDREDS digit again. Reenter a correct value.
- Both the display temperature and the temperature setting are the temperature at the sensor. (Even with the same temperature setting, the temperature of the hot air differs depending on the nozzle size.)
- If the time setting is set to 0 sec., the step can be cancelled.









6. OPERATION

7. a. The HUNDREDS digit on the temperature/ timer display section flashes. Press the  button to select. The TENS digit begins to flash.
 - b. Enter the TENS digit.

Use the  or  button to select your desired value for the TENS digit. If your desired value is displayed, press the  button. The UNITS digit begins to flash.
 - c. Enter UNITS digit.

Use the  or  button to select your desired value for the UNITS digit. When your desired value is displayed, press the  button. The mode will be shifted to **the timer time setting mode in step 3.**
8. a. The HUNDREDS digit on the temperature/ timer display section flashes. Press the  button to select. The TENS digit begins to flash.
 - b. Enter the TENS digit.

Use the  or  button to select your desired value for the TENS digit. If your desired value is displayed, press the  button. The UNITS digit begins to flash.
 - c. Enter UNITS digit.

Use the  or  button to select your desired value for the UNITS digit. If your desired value is displayed, press the  button. The temperature and timer setting in step 3 will be completed and shifted to **the step selection mode.**

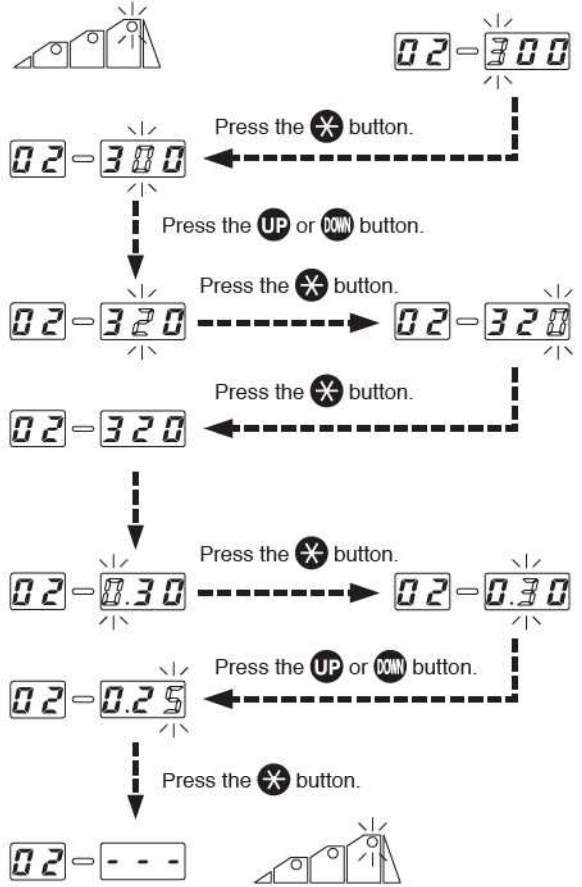

9. File writing

Press the **✳** button for 1 second or more to shift into the file writing mode. Use the **UP** or **DOWN** buttons to display **--y** and press the **✳** button. The file writing will be completed.

NOTE:

If **--n** is selected, the data will be returned to the data before change and the mode will be shifted to the file number selection mode.

* In **AUTO** mode, files are not selected. Select the file to be used and start it.

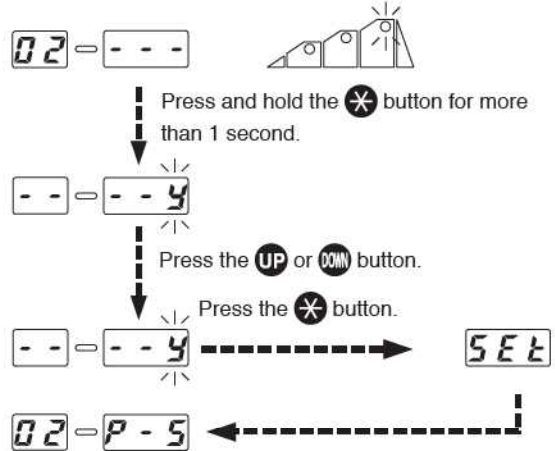

F. Airflow adjustment

Adjust the flow rate of the hot air while watching the airflow meter. The adjustment range is 5 ℓ/min to 20 ℓ/min .

CAUTION

Do not apply excessive force when turning the airflow control knob.

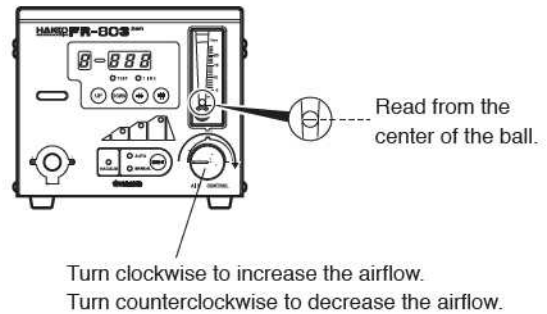

G. Set data checking method

Setting in Auto mode

Select your desired file No. in advance.

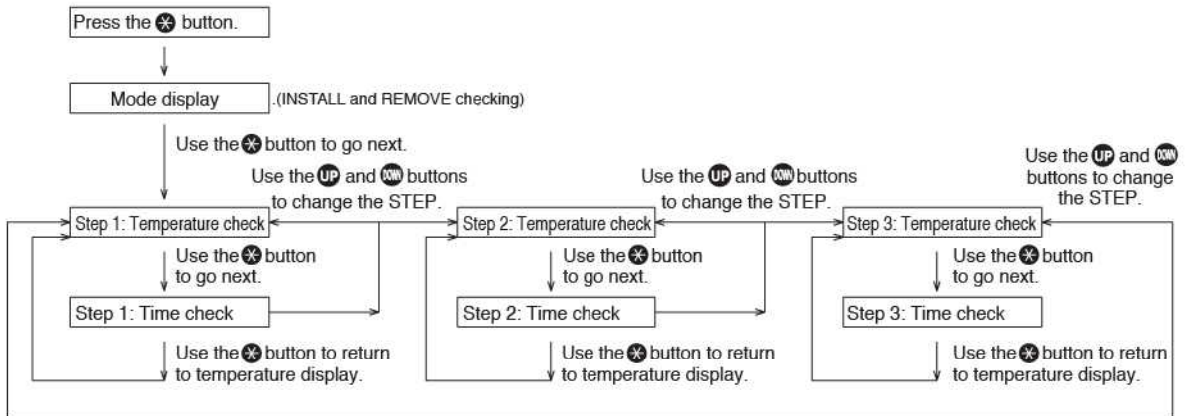

* If no button is input for 2 seconds or more in any condition, the unit will be returned to normal conditions.

7. PARAMETERS

Parameter	Parameter display	Initial setting
°C/°F change	°C or °F	C (°C)
Power saving time (30 min/60 min/∞)	30, 60 or ∞	30 (30 min)
Timer display unit (min/sec)	n or S	n (min)
Change of count-down method (Opened timer/closed timer)	o or c	o (opened timer)
Change of control card lock function (Normal/single lock)	1 or 2	1 (normal)
Change of forced air shutoff function (ON (Enable)/OFF (Disable))	0 or 1	0 (OFF)

* In case of simple lock, the change of file number in AUTO mode can be changed without inserting the control card.

* The forced air shutoff function is inoperative when the temperature readout is 380°C or higher, even if the function is set to be enabled.

● Parameter change method

To enter in Parameter Change mode, turn on the power switch while pressing the **UP** and **DOWN** buttons simultaneously.

1. °C/°F change

Press the **UP** or **DOWN** button, select "C" (Celsius) or "F" (Fahrenheit) and press the **✖** button to enter.

2. Change of power save time

Press the **UP** or **DOWN** select 30 min, 60 min or ∞ and press the **✖** button to enter.

3. Change of timer display unit

Press the **UP** or **DOWN** button, select "n" (min) or "S" (sec) and press the **✖** button to enter.

4. Change of countdown method

Press the **UP** or **DOWN** select "o" (Opened timer) or "c" (Closed timer) and press the **✖** button to enter. (See the table on page 7.)

5. Change of card-lock function

Press the **UP** or **DOWN** button, select 1 or 2 and press the **✖** button to enter.

The parameter input mode is completed, **SET** is displayed and then returned to the normal mode.

● Initial resetting method

⚠ CAUTION

Be sure to insert the control card into the card slot before initial resetting.

Turn the power switch ON while simultaneously pressing the **UP**, **DOWN** and **✖** buttons to reset to the initial set values upon shipment from the factory. The mode is displayed in MANUAL.

⚠ CAUTION

Be sure to insert the control card into the card slot before changing.

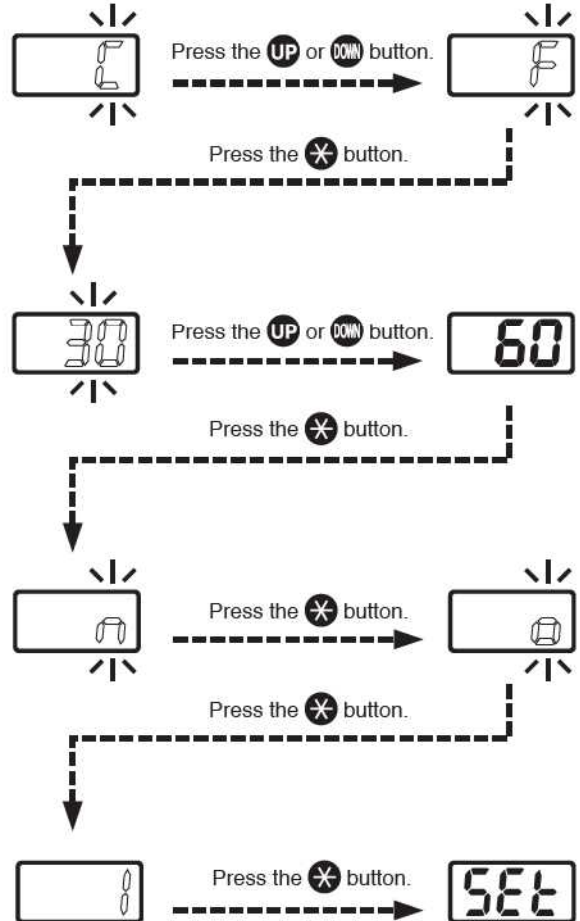

⚠ CAUTION

If the power is turned OFF before the parameter setting procedure is completed (**SET** is not displayed), the new setting value will not be stored in memory.



● Factory setting

⚠ CAUTION

Be sure to insert the control card into the card slot before initial resetting.

Turn the power switch ON while simultaneously pressing the **UP**, **DOWN** and **✖** buttons to reset the initial set values upon shipment from the factory. The mode is displayed in MANUAL.

Upon shipment from the factory, the data are set to the values as shown in the right tables.

<In MANUAL mode>

Temperature	300°C
Offset value	0

<In AUTO mode>

Mode	INSTALL	
Step 1	Setting temp.	200°C
	Timer time	30
Step 2	Setting temp.	250°C
	Timer time	30
Step 3	Setting temp.	300°C
	Timer time	30

8. OFFSET SETTING METHOD

NOTE:

The temperature at the blowout port varies depends on the nozzle size. The offset temperature can be selected.

⚠ CAUTION

Change the mode to MANUAL before setting. The operations cannot be performed in AUTO mode.

Be sure to insert the control card.

1. Press the **#** button for 1 second or more.

The mode will be shifted to the offset inputting mode.

2. Input the offset value.

The input range is -50 to +50°C (In °F mode, from -90 to +90°F)

Enter the HUNDREDS digit.

- Use the **UP** or **DOWN** buttons to select your desired value for the HUNDREDS digit. Only 0 (in case of positive) and – (in case of negative) can be input (the same as in °F mode). Select 0 or – and press the **✖** button. The TENS digit begins to flash.

Enter the TENS digit.

- Use the **UP** or **DOWN** buttons to select your desired value for the TENS digit. When your desired value is displayed, press the **✖** button. The UNITS digit begins to flash.

Enter the UNITS digit.

- Select your desired value for the UNITS digit in the same manner as for the TENS digit. When your desired value is displayed, press the **✖** button. **SET** displays and indicates that the temperature setting procedure is completed.

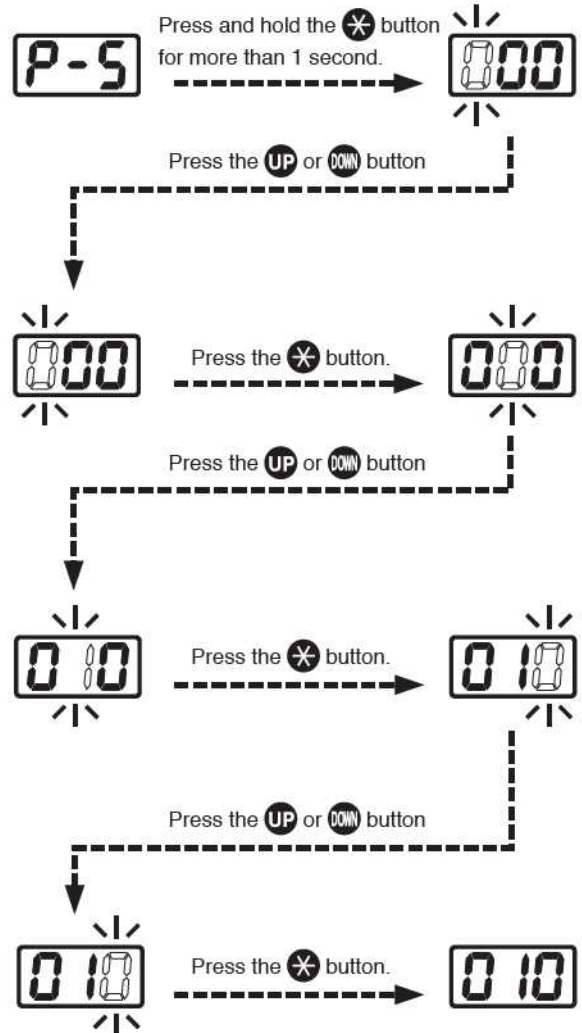

9. MAINTENANCE / INSPECTION

● Broken Heater or Sensor

① Open the handpiece.

1. Retract the vacuum pipe to its shortest length.
2. Move the tube downward.
3. Remove the three screws holding the handpiece together.
4. Remove the pipe from the protruding portion of the handle.

⚠ CAUTION

Quartz glass and heat insulation are inside the pipe. Be careful not to drop or lose these items.

5. Disconnect the heater sensor connector and remove the heater.

⚠ CAUTION

Do not apply excessive force to the vacuum pipe.

② Measure the resistance value.

1. Measure the resistance value (a) of the sensor. The normal value is 0Ω .
2. Measure the resistance value (b) of the heater. The normal values are approximately $33\Omega (\pm 10\%)$ (100-120V), $85\Omega (\pm 10\%)$ (220-240V) at room temperature. If the resistance value is abnormal, replace the part.
(Refer to the instructions included with the replacement part.)

● Replacing the Fuse

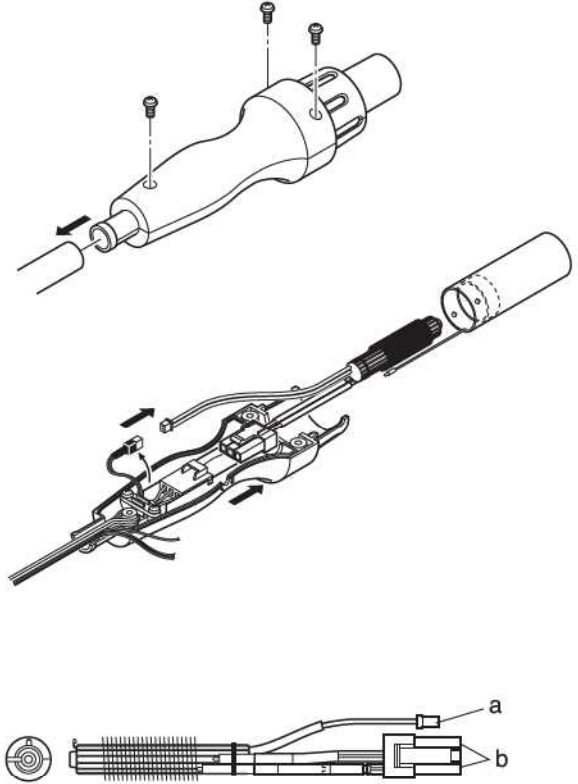
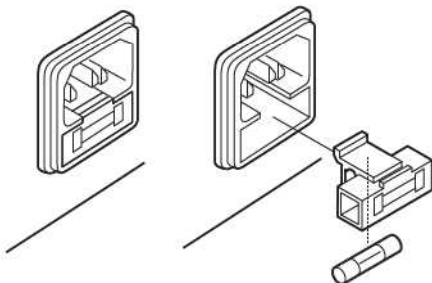

⚠ CAUTION

Since there are various hazards with replacing the heating element, be sure to turn off the power and replace them according to the above procedure.

1. Unplug the power cord from the power receptacle.
2. Remove the fuse holder.
3. Replace the fuse with new one.
4. Put the fuse holder back in place.

10. ERROR MESSAGE

When the error detection software in the HAKKO FR-803B detects an error, a message is displayed to alert the operator. See “Troubleshooting” for procedures to correct the error.

Sensor Error



This error occurs when there is the possibility of a sensor failure (or a failure in the sensor circuit).

S-E flashes and the power is shut down.

Heater Error



This error occurs when the temperature of the hot air is falling even though the heater is on. The **H-E**

flashes to indicate the possibility of a heater failure.

11. TROUBLESHOOTING

⚠ WARNING

- Before checking the inside of the HAKKO FR-803B or replacing parts, be sure to disconnect the power plug. Failure to do so may result in electric shock.

- The unit does not operate when the power switch is turned ON.

CHECK : Is the power cord or connection plug disconnected?

ACTION : Connect it.

- **S-E** flashes, indicating a sensor error.

CHECK : Is the fuse blown?

ACTION : Investigate why the fuse blew and then replace the fuse.

- **H-E** flashes, indicating a heater error.

CHECK : Is the sensor broken?

ACTION : Measure the resistance value of the sensor. The normal value is 0 Ω. If the resistance value is abnormal, replace the parts with new parts.

- The profile cannot be set.

CHECK : Is the heater broken?

ACTION : Measure the resistance value of the sensor. The normal value is 33 Ω (±10%) (100-120V), 85Ω (±10%) (220-240V) at room temperature. If the resistance value is abnormal, replace the parts with new parts.

- The vacuum pump does not stop when the vacuum button is pressed.

CHECK : Is the station in Auto mode?

ACTION : Put the station into Auto mode.

CHECK : Is the value outside the setting range?

ACTION : Enter a value that is within the setting range.

CHECK : Is the VACUUM button being pressed?

ACTION : Press the VACUUM button.

12. OPTINAL PARTS

CAUTION
The size in Name/Specification indicates the size of IC package.

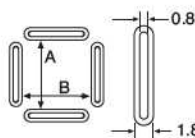
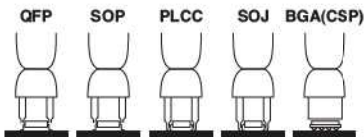

Air nozzle (common to all nozzles)

	C0.8 D1.8	C1.0 D2.0	C0.8 D2.0
No.	A1125B~A1129B A1131~A1141B A1180B~A1189B A1203B~A1266B	A1191	A1192

● Vacuum function operative nozzles.

*HAKKO FR-801 and FR-802 are not equipped with the vacuum function.

Unit: mm (inch)

A1125B QFP 10 × 10 (0.39 × 0.39) A:10.2 (0.4) B:10.2 (0.4)	A1126B QFP 14 × 14 (0.55 × 0.55) A:15.2 (0.6) B:15.2 (0.6)	A1127B QFP 17.5 × 17.5 (0.68 × 0.68) A:19.2 (0.76) B:19.2 (0.76)	A1128B QFP 14 × 20 (0.55 × 0.78) A:15.2 (0.6) B:21.2 (0.83)	A1129B QFP 28 × 28 (1.1 × 1.1) (0.68 × 0.68) A:29.7 (1.17) B:29.7 (1.17)	A1135B PLCC 17.5 × 17.5 (0.68 × 0.68) (44 Pins) A:18.5 (0.73) B:18.5 (0.73)
A1136B PLCC 20 × 20 (0.78 × 0.78) (52 Pins) A:21 (0.83) B:21 (0.83)	A1137B PLCC 25 × 25 (0.98 × 0.98) (68 Pins) A:26 (1.02) B:26 (1.02)	A1138B PLCC 30 × 30 (1.18 × 1.18) (84 Pins) A:31 (1.22) B:31 (1.22)	A1139B PLCC 12.5 × 7.3 (0.49 × 0.29) (18 Pins) A: 9 (0.35) B:14 (0.55)	A1140B PLCC 11.5 × 11.5 (0.45 × 0.45) (28 Pins) A:13 (0.51) B:13 (0.51)	A1141B PLCC 11.5 × 14 (0.45 × 0.55) (32 Pins) A:15 (0.59) B:13 (0.51)
A1181B BQFP 19 × 19 (0.75 × 0.75) A:19.2 (0.76) B:19.2 (0.76)	A1182B BQFP 24 × 24 (0.94 × 0.94) A:24.2 (0.95) B:24.2 (0.95)	A1184B SOJ 18 × 8 (0.71 × 0.31) A:19 (0.75) B:10 (0.39)	A1185B TSOL 13 × 10 (0.51 × 0.39) A:11.9 (0.47) B:10 (0.39)	A1186B TSOL 18 × 10 (0.71 × 0.39) A:18.2 (0.72) B:10 (0.39)	A1187B TSOL 18.5 × 8 (0.73 × 0.31) A:18.5 (0.73) B:10 (0.39)
A1188B PLCC 9 × 9 (0.35 × 0.35) (20 Pins) A:11 (0.43) B:11 (0.43)	A1189B PLCC 34 × 34 (1.34 × 1.34) (100 Pins) A:36.5 (1.44) B:36.5 (1.44)	A1203B QFP 35 × 35 (1.38 × 1.38) A:35.2 (1.39) B:35.2 (1.39)	A1214B SOJ 10 × 26 (0.39 × 1.02) A:25.9 (1.02) B:12 (0.47)	A1215B QFP 42.5 × 42.5 (1.67 × 1.67) A:42.5 (1.67) B:42.5 (1.67)	A1257B SOP 11 × 21 (0.43 × 0.83) A:11.7 (0.46) B:8.2 (0.32)
A1258B SOP 7.6 × 12.7 (0.3 × 0.5) A:7.6 (0.3) B:12.7 (0.5)	A1259B SOP 13 × 28 (0.51 × 1.1) A:13.5 (0.53) B:28 (1.1)	A1260B SOP 8.6 × 18 A:8.6 (0.34) B:18 (0.71)	A1261B QFP 20 × 20 A:20.2 (0.8) B:20.2 (0.8)	A1262B QFP 12 × 12 A:12.2 (0.48) B:12.2 (0.48)	A1263B QFP 28 × 40 A:27.7 (1.09) B:39.7 (1.56)
A1264B QFP 40 × 40 A:40.2 (1.58) B:40.2 (1.58)	A1265B QFP 32 × 32 A:32.2 (1.27) B:32.2 (1.27)	A1470 BGA 8 × 8 A:8 (0.31) B:8 (0.31)	A1471 BGA 12 × 12 A:13 (0.51) B:13 (0.51)	A1472 BGA 13 × 13 A:14 (0.55) B:14 (0.55)	A1473 BGA 15 × 15 A:16 (0.63) B:16 (0.63)
A1474 BGA 18 × 18 A:19 (0.75) B:19 (0.75)	A1475 BGA 27 × 27 A:28 (1.10) B:28 (1.10)	A1476 BGA 35 × 35 A:36 (1.42) B:36 (1.42)	A1477 BGA 38 × 38 A:39 (1.54) B:39 (1.54)	A1478 BGA 40 × 40 A:41 (1.61) B:41 (1.61)	

● Vacuum function inoperative nozzles.

Unit: mm (inch)

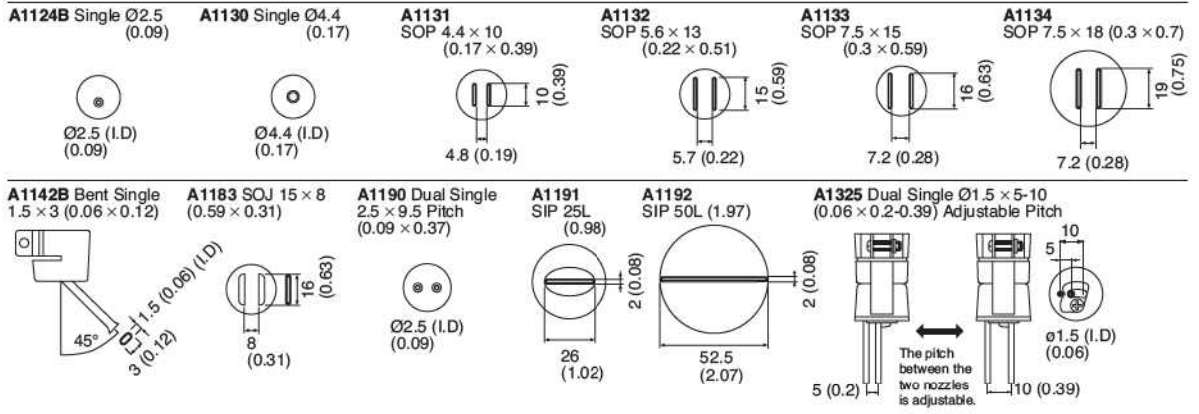

CAUTION

Do not use **No. A1124B** Single $\varnothing 2.5$ (0.09) and **No. A1142B** Bent Single 1.5×3 (0.06 \times 0.12) nozzle with the HAKKO FR-803B. These nozzles do not have space to blow hot air, using them with the HAKKO FR-803B may result in danger.

13. PARTS LIST / STATION

NOTE:

Spare or repair parts do not include mounting screws, if they are not listed on the specifications. Screws must be ordered separately.

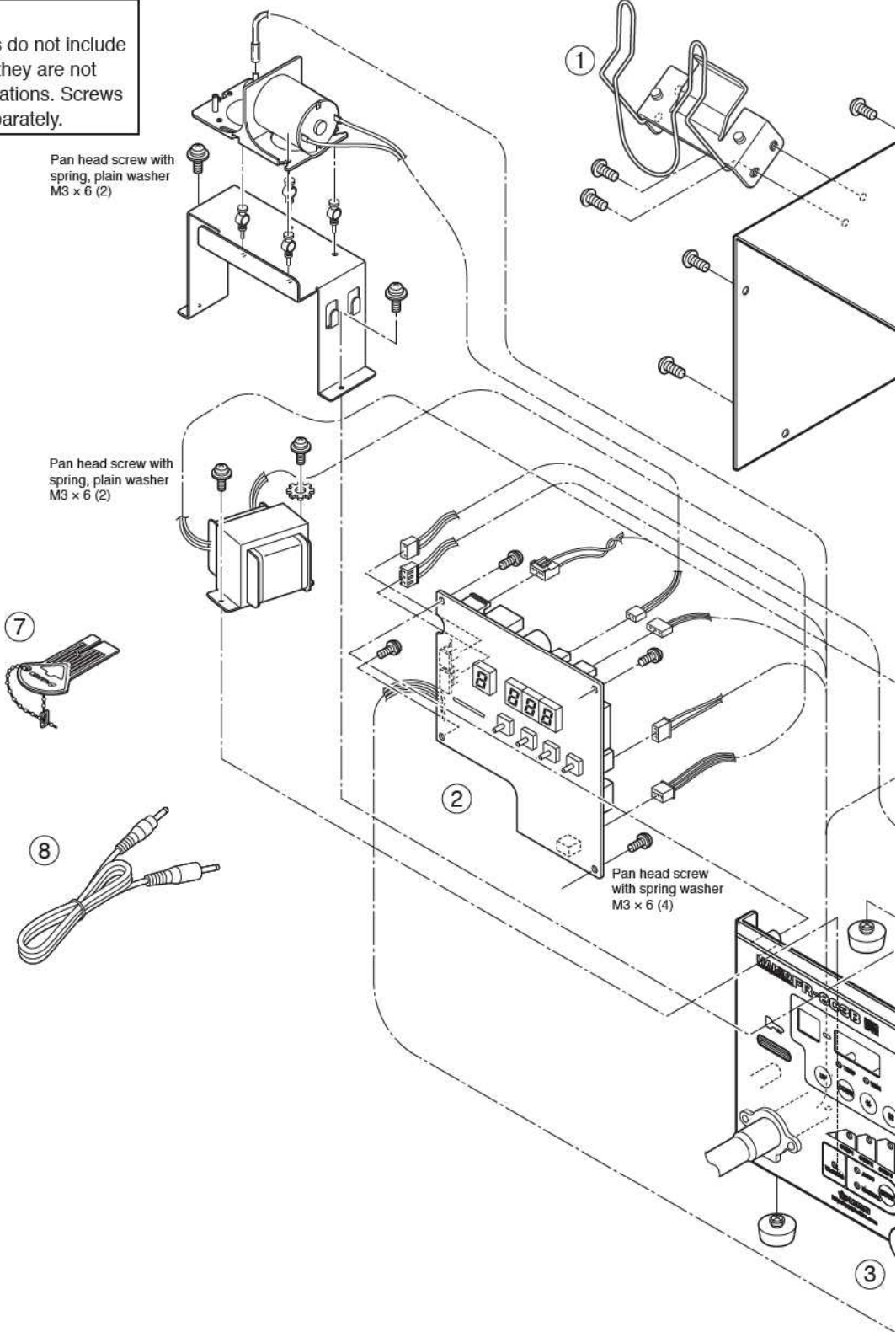

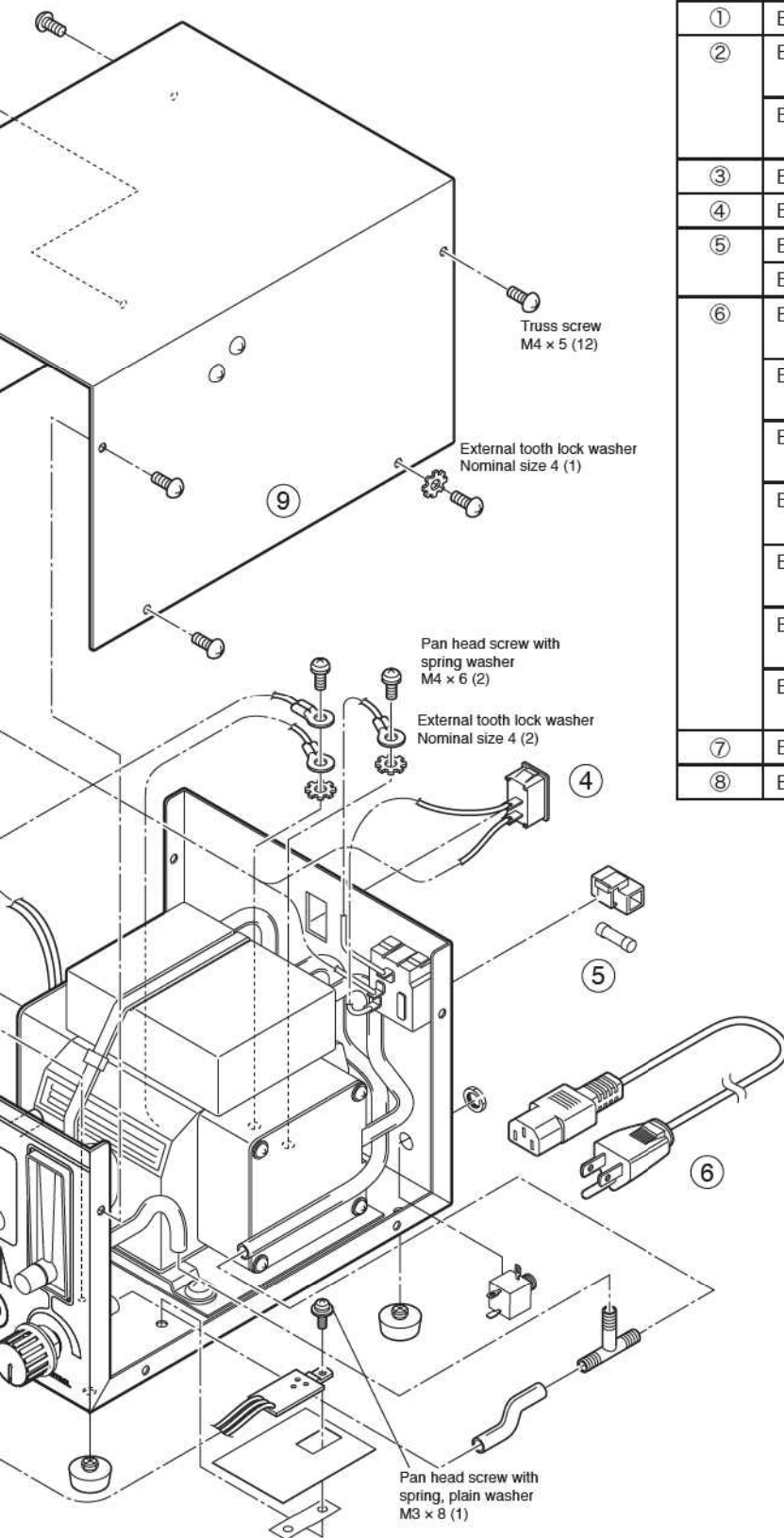

Item No.	Part No.	Part Name	Specifications
①	B3442	Handpiece holder	
②	B3380	P.W.B./for temperature control	100~120V, with triac
	B3381	P.W.B./for temperature control	220~240V, with triac
③	B1028	Knob	With screw
④	B1084	Power switch	
⑤	B2468	Fuse/125V-5A	100~120V
	B1258	Fuse/250V-3.15A (S)	220~240V
⑥	B2419	Power cord, 3 wired cord & American plug	100~120V
	B2421	Power cord, 3 wired cord but no plug	220~240V
	B2422	Power cord, 3 wired cord & BS plug	India
	B2424	Power cord, 3 wired cord& European plug	220V KTL, 230V CE
	B2425	Power cord, 3 wired cord & BS plug	230V CE, U.K.
	B2426	Power cord, 3 wired cord & Australian plug	
	B2436	Power cord, 3 wired cord & Chinese plug	China
⑦	B2972	Control card	
⑧	B3410	Connecting cord	

13. PARTS LIST / HANDPIECE

NOTE:

Spare or repair parts do not include mounting screws, if they are not listed on the specifications. Screws must be ordered separately.

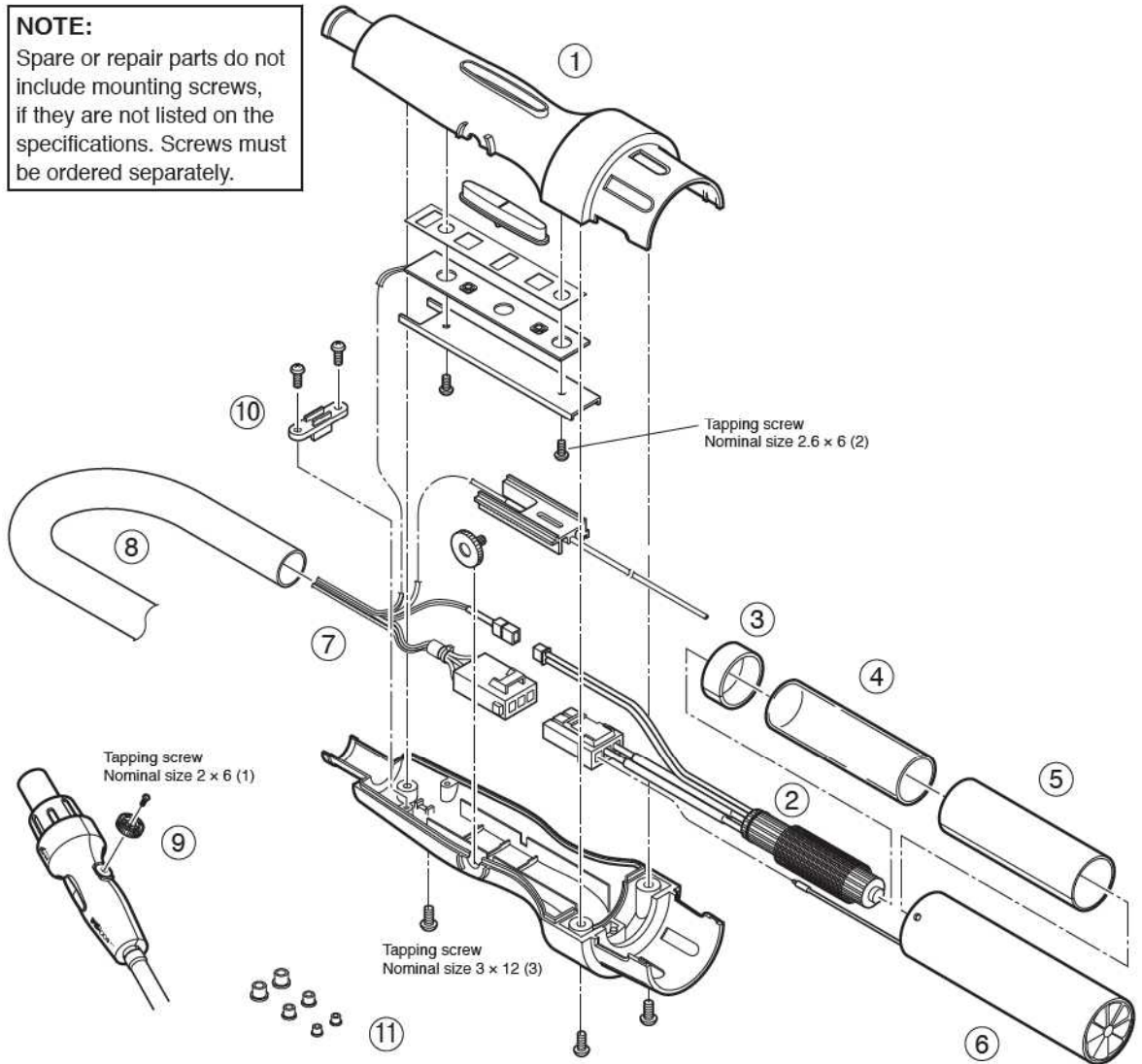

Item No.	Part No.	Part Name	Specifications
①	B3015	Handle	With screws
②	A1523	Heating element	100~120V
	A1524	Heating element	220~240V
③	B3009	Mica B	
④	B2995	Quartz glass pipe	For support heating element
⑤	B3008	Mica A	
⑥	B3095	Pipe assembly	
⑦	B3018	Cord assembly	With silicone tube
⑧	B1188	Silicone hose	

Item No.	Part No.	Part Name	Specifications
⑨	B3023	Vacuum pipe adjustment knob (L)	With screw
⑩	B1354	Cord stopper/for handle	
⑪	A1520	Pad ø3 mm (0.12 in.)	Set of 5
	A1439	Pad ø5 mm (0.20 in.)	Set of 5
	A1438	Pad ø7.6 mm (0.30 in.)	Set of 5

14. WIRING DIAGRAM

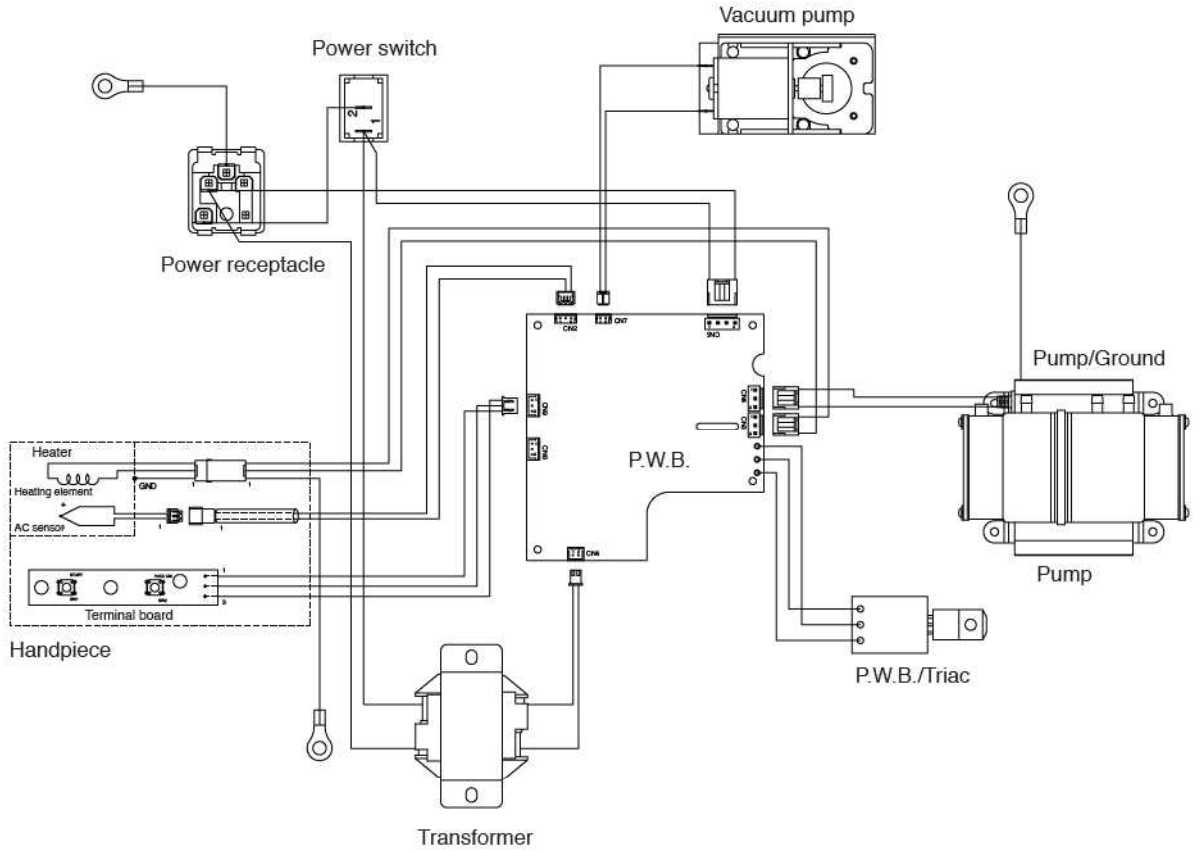



HAKKO CORPORATION

HEAD OFFICE

TEL: +81-6-6561-3225 FAX: +81-6-6561-8468
<http://www.hakko.com> E-mail: sales@hakko.com

OVERSEAS AFFILIATES

U.S.A.: AMERICAN HAKKO PRODUCTS, INC.
TEL: (661) 294-0090 FAX: (661) 294-0096
Toll Free (800)88-HAKKO

<http://www.hakkousa.com>

HONG KONG: HAKKO DEVELOPMENT CO., LTD.
TEL: 2811-6588 FAX: 2590-0217

<http://www.hakko.com.hk>

E-mail: info@hakko.com.hk

SINGAPORE: HAKKO PRODUCTS PTE., LTD.

TEL: 6748-2277 FAX: 6744-0033

<http://www.hakko.com.sg>

E-mail: sales@hakko.com.sg

Please access to the following address for the other Sales affiliates.

<http://www.hakko.com>