

# **HAKKO FX-801**

**SOLDERING STATION**

## **Soldering Station**

# **Instruction Manual**



Thank you for purchasing the HAKKO FX-801 Soldering Station.  
Please read this manual before operating the HAKKO FX-801.  
Keep this manual readily accessible for reference.



## **TABLE OF CONTENTS**

1. PACKING LIST .....	1
2. SPECIFICATIONS .....	1
3. WARNINGS, CAUTIONS AND NOTES .....	2
4. PART NAMES .....	3
5. INITIAL SETUP .....	4
6. OPERATION .....	5
7. PARAMETER SETTING .....	10
8. MAINTENANCE .....	16
9. CHECKING PROCEDURE .....	17
10. ERROR MESSAGES .....	18
11. TROUBLE SHOOTING GUIDE .....	19
12. PARTS LIST .....	21
13. WIRING DIAGRAM .....	23

# 1. PACKING LIST

Please check to make sure that all items listed below are included in the package.

HAKKO FX-801 Station .....	1	Power cord .....	1
HAKKO FX-8002 Soldering iron .....	1	Heat resistant pad .....	1
Iron holder (with cleaning wire) .....	1	Instruction manual .....	1
Connecting cable .....	1		

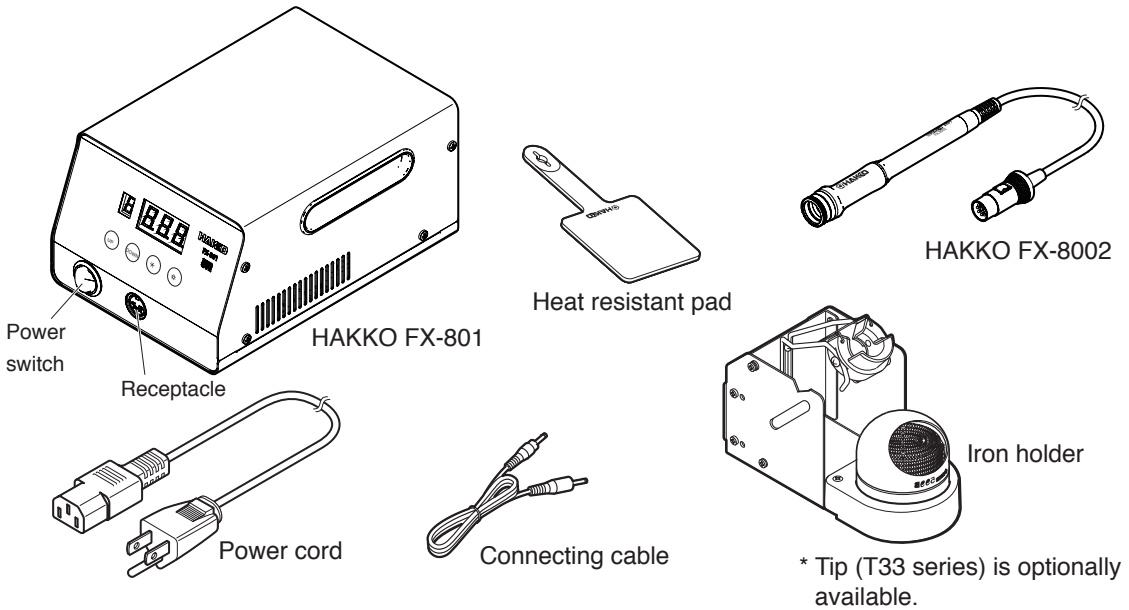

# 2. SPECIFICATIONS

## ● HAKKO FX-801

Power consumption	300W
Temperature range	50 - 500°C (120 - 940°F)
Temperature stability	± 5°C (± 9°F) at idle temperature
Output Voltage	AC 29V
Dimensions	145(W)×107(H)×211(D) mm (5.7 × 4.2 × 8.3 in.)
Weight	3.9 kg (8.6 lb.)

- \* The temperature was measured using the FG-100 thermometer.
- \* This product is protected against electrostatic discharge.
- \* Specifications and design are subject to change without notice.

## ● HAKKO FX-8002

Power Consumption	260W (29V)
Tip to Ground Resistance	< 2 Ω
Tip to Ground Potential	< 2 mV
Cord	1.2 m (4 ft)
Total Length (w/o cord)	228 mm (9.0 in.) with 4BC tip
Weight (w/o cord)	50 g (0.11 lb.) with 4BC tip

### ⚠ CAUTION

This product includes such features as electrically conductive plastic parts and grounding of the handpiece and station as measures to protect the device to be soldered from the effects of static electricity. Be sure to observe the following instructions:

1. The handle and other plastic parts are not insulators, they are conductors. When replacing parts or repairing, take sufficient care not to expose live electrical parts or damage insulation materials.
2. Be sure to ground the unit during use.

# 3. WARNINGS, CAUTIONS AND NOTES

Warnings, cautions and notes are placed at critical points in this manual to direct the operator's attention to significant items. They are defined as follows:

**⚠ WARNING:** Failure to comply with a WARNING may result in serious injury or death.

**⚠ CAUTION :** Failure to comply with a CAUTION may result in injury to the operator, or damage to the items involved.

## **⚠ WARNING**

When power is ON, the tip will be hot.

To avoid injury or damage to personnel and items in the work area, observe the following:

- Do not touch the tip or the metal parts near the tip.
- Do not allow the tip to come close to, or touch, flammable materials.
- Inform others in the area that the unit is hot and should not be touched.
- Turn the power off when not in use, or left unattended.
- Turn the power off when changing parts or storing the HAKKO FX-801.
- This appliance can be used by children aged from 8 years and above and persons with reduced physical, sensory or mental capabilities or lack of experience and knowledge if they have been given supervision or instruction concerning use of the appliance in safe way and understand the hazards involved.
- Children shall not play with the appliance.
- Cleaning and user maintenance shall not be made by children without supervision.
- The unit is for a counter or workbench use only.

To prevent accidents or damage to the HAKKO FX-801, be sure to observe the following:

## **⚠ CAUTION**

- Do not use the HAKKO FX-801 for applications other than soldering.
- Do not strike the iron against hard objects to remove excess solder.  
This will damage the iron.
- Do not modify the HAKKO FX-801.
- Use only genuine Hakko replacement parts.
- Do not allow the HAKKO FX-801 to become wet, or use it with wet hands.
- Remove power and iron cords by holding onto the plug.
- Be sure the work area is well ventilated. Soldering produces smoke.
- Be sure the cooling fan at the rear of the station is unrestricted.
- While using the HAKKO FX-801, don't do anything which may cause bodily harm or physical damage.

# 4. PART NAMES

---

## ● HAKKO FX-801

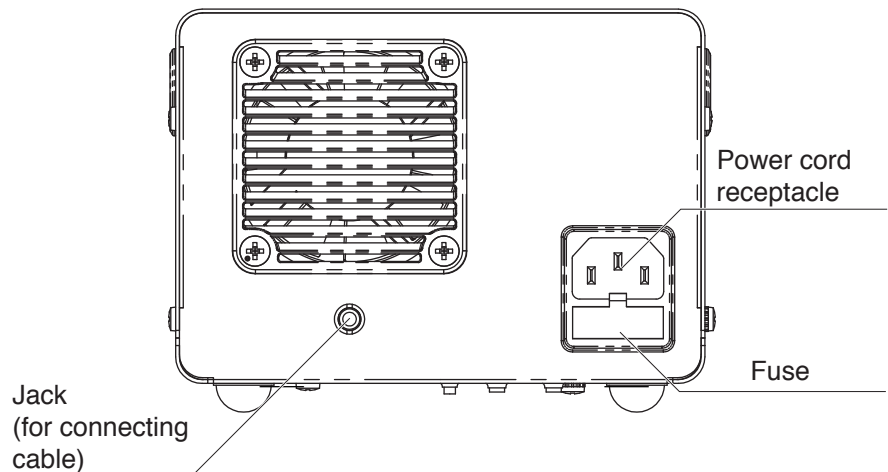
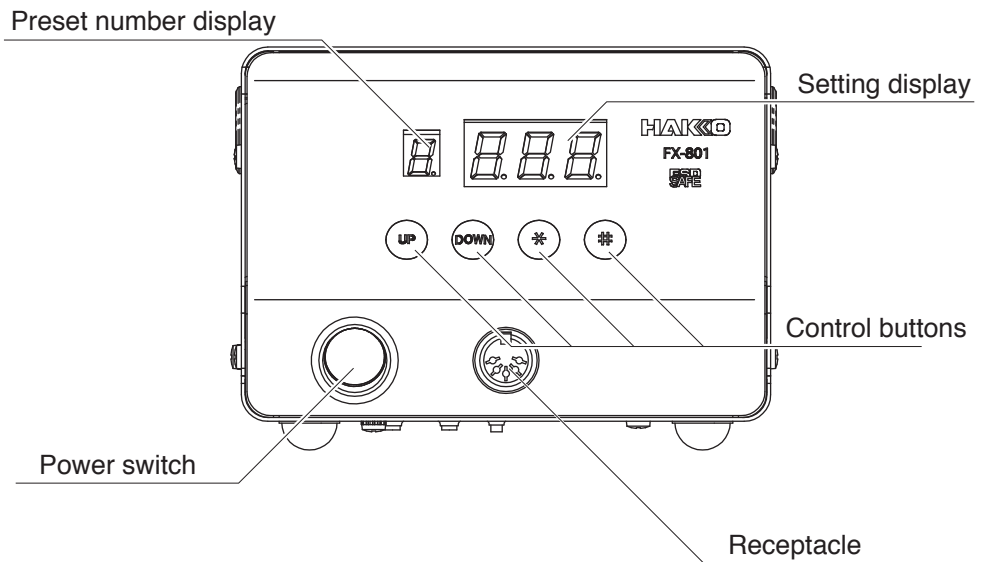

# 5. INITIAL SETUP

## A. Iron holder

- Loosen the adjusting screws to change the angle of the iron receptacle as you like, then tighten the screws.

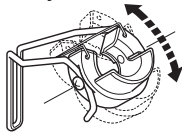

**CAUTION**  
Do not set up the iron receptacle too high, the temperature of the soldering iron will become very hot.

1. Assemble as shown:
  - Insert the tip cleaner securely into the Iron holder base.

### 2. Operation:

First, remove any excess solder from the tip by thrusting the tip into the cleaning wire. (Do not wipe the tip against the wire. This may cause molten solder to spatter.) When the wire becomes dirty or loaded with solder, turn the wire until a clean surface is presented. When changing the cleaning wire, lift the case top vertically to prevent solder debris from falling out.

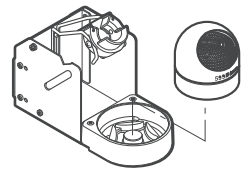

- Use of the sleep function.

When using the sleep function, insert one end of the connecting cable into the jack at the back of the iron holder and the other end into the jack at the back of the soldering station to connect them.

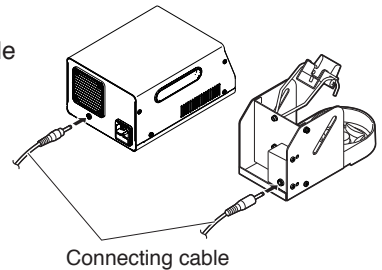

**CAUTION**  
Be sure to turn off the power before connecting or disconnecting the connecting cable.

## B. Handpiece cord assembly

Pass the iron cord through the hole in the heat resistant pad.

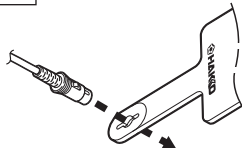

## C. Soldering station

**CAUTION**  
Be sure the power switch is OFF before connecting or disconnecting the soldering iron cord. Failure to do so may result in damage to the circuit board.

1. Insert the power cord into the receptacle at the back of the station. Insert the soldering iron cord into the receptacle at the front of the station.
2. Set the iron in the iron holder.
3. Plug the power cord into a grounded wall socket.

Insert the plug into the receptacle until it clicks.



To disconnect, pull the plug from the receptacle while pressing down the tab on the plug.

**CAUTION**  
The HAKKO FX-801 is protected against electrostatic discharge and must be grounded for full efficiency.

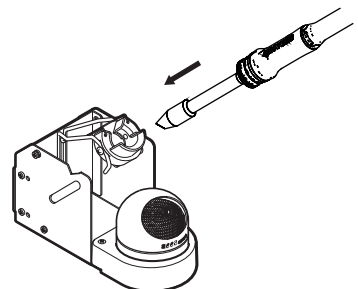

The iron receptacle has two grooves. If the edge of the iron tip is likely to come into contact with the iron holder or the iron holder becomes hot, use the alternate groove to attach the iron receptacle.

Normal conditions



If the iron holder becomes hot

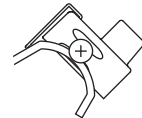

# 6. OPERATION

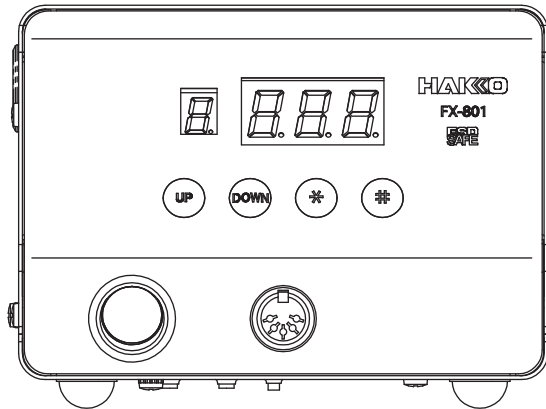

The HAKKO FX-801 has the following four control buttons.

- UP** — Press for less than one second to enter preset number selection screen.  
Press and hold for at least one second to enter preset temperature changing screen.  
Use to increase the value in the appropriate display window.
- DOWN** — Use to decrease the value in the appropriate display window.
- \*** — Press for less than one second to display the current set temperature.  
Press and hold for at least one second to enter temperature setting mode.  
Use to end the current operation.
- #** — Press for less than one second to display the current offset value.  
Press and hold for at least one second to enter offset mode.

## **CAUTION**

An audible buzzer is provided to alert the operator when:

- The station has reached the set temperature, a buzzer will sound once.
- The low temperature threshold has been crossed, a buzzer will sound continuously.  
This buzzer will shutoff when the sensed temperature returns to the acceptable range.
- There is the possibility that a failure has occurred in the sensor or heater, a buzzer will sound continuously.

## Operation

1. Turn on the power switch.
2. Once the set temperature is reached, a buzzer sounds once.

By default, the temperature is set to 350°C (750°F for US model).

Check the temperature setting by pressing the \* button.

The set temperature will be displayed for two seconds.

## **WARNING**

Place soldering iron in iron holder when not in use.

## Changing temperature setting

### ⚠ CAUTION

The temperature setting range is from 50°C to 500°C. (120°F to 940°F)

● If you enter a value outside the temperature setting range, the display returns to the hundreds digit, and you have to enter a correct value.

Example : Changing set temperature from 350 to 400°C

1. Press and hold the  button for at least one second.  
The hundreds digit will begin to flash.

2. Entering the value.

Press the  or  to set the value of the digit that is flashing.

Only values from 0 to 5 can be selected when entering the hundreds digit.  
(In °F mode, values from 1 to 9 can be selected.)

Values from 0 to 9 can be selected when entering the tens or ones digit.  
(The same values can be selected in °F mode.)

When desired figure is displayed, press the  button to accept the value.

The next digit will begin to flash. After entering the ones digit, press the  button to save the value to the system memory and begin heater control with new setting temperature.

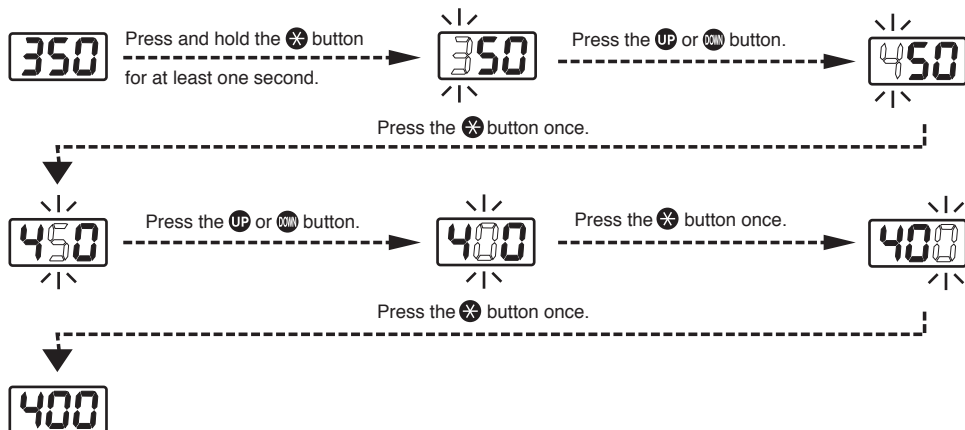

### ⚠ CAUTION

If power is switched off or lost during the execution of this procedure, no data will be entered. The entire procedure must be repeated from step 1.

## Selecting the preset number

You can quickly select one of six user programmable preset temperatures.

Initial preset temperatures are: 0 : 300°C, 1 : 350°C, 2 : 375°C, 3 : 400°C, 4 : 450°C and 5 : 500°C.

Example : Changing preset No. 0 (300°C) to No. 3 (400°C)

1. Press the **UP** button once.  
Preset number display will begin to flash.
2. Press the **UP** button three times to change the preset number display to **3**.
3. Press the **✖** to set the value.



## Changing the preset temperature

You can change any of the six available preset temperatures. (Preset No. 0 to No. 5)

Example : Changing Preset No. 3 temperature from 400°C to 410°C.

1. Press and hold the **UP** button for at least one second.  
Both preset number display and setting display will begin to flash.
2. Press the **UP** button three times to change the preset number display to **3**.
3. Press the **✖** button to set the value.
4. Use the method for setting the temperature to enter and set the preset temperature.

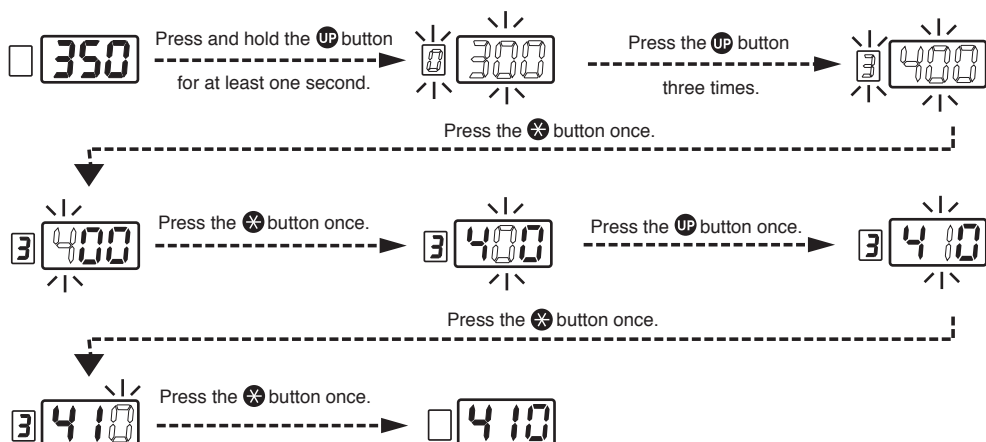



## Entering the tip offset value

Example : If the measured temperature is 410°C and set temperature is 400°C, the difference is -10°C (need to decrease by 10°C). So enter a value so 10 is deducted from present offset value.

1. Press and hold the **#** button for at least one second.  
The hundreds digit will begin to flash, the unit will enter the offset mode.
2. Enter the offset value (-10) which is the difference between tip temperature and set temperature.

The allowable ranges for offset values are from -50 to +50°C (In °F mode, from -90 to +90°F)  
If you enter a value outside the offset value range, the display returns to the hundreds digit, and you have to enter a correct value.

3. Entering the value.  
Press the **UP** or **DOWN** button to set the desired figure.

The hundreds digit can display 0 (for positive value) or minus sign (for negative value)  
(Same values can be selected in °F mode.)

Values from 0 to 5 can be selected when entering the tens digit.  
(In °F mode, values from 0 to 9 can be selected.)

Values from 0 to 9 can be selected when entering the ones digit.  
(Same values can be selected in °F mode.)

After entering the ones digit, press the **✱** button to save the value to the system memory and begin heater control with the new offset value.

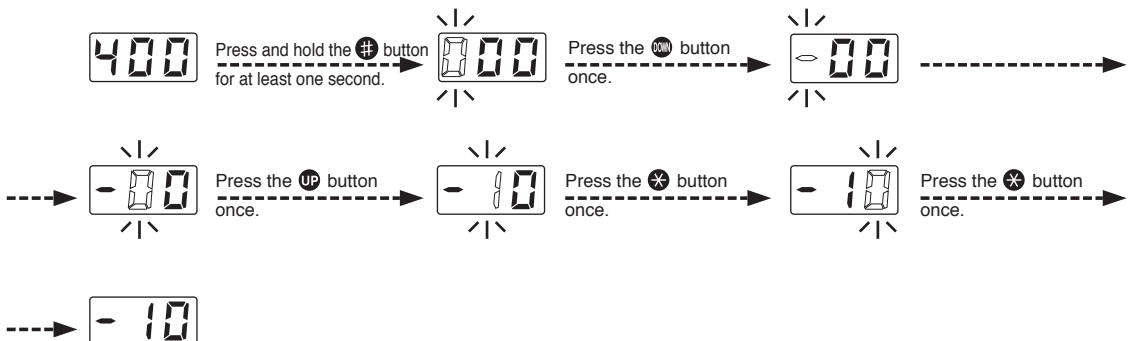

### **⚠ CAUTION**

Do not enter an offset that allows the tip to exceed 500 °C.

## Restriction on setting changes (Password function)

It is possible to restrict certain setting changes to the unit.

There are three choices for the password setting. (The factory default is "0 : Open")

	0 : Open	1 : Partial	2 : Restricted
Parameter setting mode	○	×	×
Temperature setting mode	○	△	×
Preset selection mode	○	△	×
Offset mode	○	△	×

○ : You can make changes without entering a password.

△ : You can choose whether or not a password is needed to make changes.

×

Select and input three letters for the password from six letters on the right.



Example : The procedure for changing the set temperature when the unit is restricted by a password. (Password is "AbC")

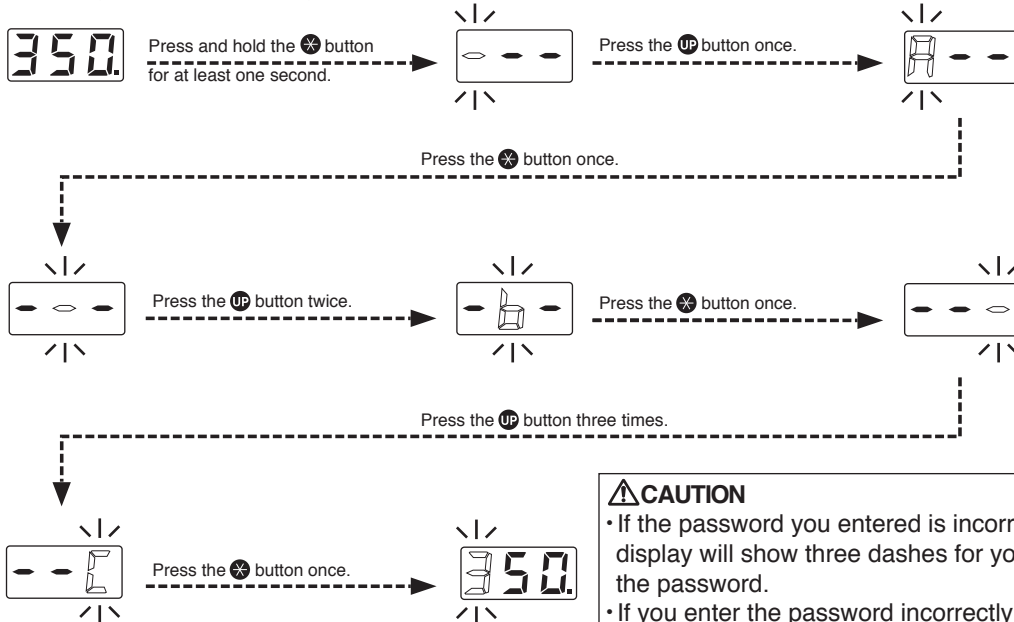

### ⚠ CAUTION

- If the password you entered is incorrect, the display will show three dashes for you to re-enter the password.
- If you enter the password incorrectly twice in a row, the display will return to the previous screen.

The unit will enter the change setting screen for each mode after entering the password.

Please change the setting for each mode according to the procedure.

(In the above example, please refer to the procedure for setting the temperature.)

**Enter the parameter setting to change the mode. (Please refer to [7. PARAMETER SETTING])**

# 7. PARAMETER SETTING

Parameter name	Parameter number	Settings	Initial value
Temperature display	01	°F( F ) / °C( C )	°C (°F**)
Auto sleep time setting	02	0 - 29 min.	6 min.
Low temperature error setting	03	30 - 300°C (54 - 540°F)	300°C (540°F**)
Buzzer setting (S-E sound , C-E sound)	05	OFF( 0 ) / ON( 1 )	ON ( 1 )
Buzzer setting (set temperature achieving alert)	06	OFF( 0 ) / ON( 1 )	ON ( 1 )
Auto sleep on/off setting	07	OFF( 0 ) / ON( 1 )	ON ( 1 )
Auto shutoff on/off setting	08	OFF( 0 ) / ON( 1 )	OFF ( 0 )
Power-mode setting	12	High power( 0 ) / Normal power( 1 )	High power( 0 )
Auto sleep temperature setting	13	200 - 300°C (390 - 580°F)	200°C (400°F**)
Password lock setting	14	Open ( 0 ) / Partial ( 1 ) / Restricted ( 2 )	Open( 0 )
Changing the set temperature		1 0 : 0* / 1 1 : x*	1 1
Changing the preset number		2 0 : 0* / 2 1 : x*	2 1
Changing the offset value		3 0 : 0* / 3 1 : x*	3 0
Password		A b C d E F Select three letters	
Auto shutoff time setting	18	30 - 60 min.	30 min.

\* 0 : Password not required    x : Password required

\*\* For U.S.A.

Turn on the power switch while pressing the **UP** button, the station will enter the parameter setting mode. (When the display shows 01 flashing, the station is in the parameter setting mode.)

Use the **UP** or **DOWN** button to select parameter number and press the **ENTER** button to move to next step. Use the **UP** or **DOWN** button to select and press the **ENTER** button to set the desired parameter value. After the necessary parameters are set, press and hold the **ENTER** button for at least one second. The display changes to **Y** (Yes) and press the **ENTER** button to exit the parameter entry mode. If you press the **UP** or **DOWN** button to select **N** (No), you will return to previous screen.

## **⚠ CAUTION**

If the power is switched off or lost during the execution of this procedure, no data will be entered.

## ● 01 : °C or °F temperature display selection

1. In display setting mode, either  or  is displayed

 : The display shows temperatures in Celsius



 : The display shows temperatures in Fahrenheit

2.  and  will be switched alternately if you press the **UP** ( **DOWN** ) button.

3. The display will return to  if you press the **✖** button after selection.

## ● 02 : Auto sleep time setting

Set the time until the auto sleep function activates after the soldering iron is set on the iron holder.

**Auto sleep examples:**  Sleep activated (immediately after the iron is set on the iron holder)  
 Sleep activated (10 minutes after the iron is set on the iron holder)

**NOTE:** The auto sleep time can be set in units of minutes (up to 29 minutes).

When the display is , press the **UP** or **DOWN** button, or remove the soldering iron from the iron holder to resume power to the heater.

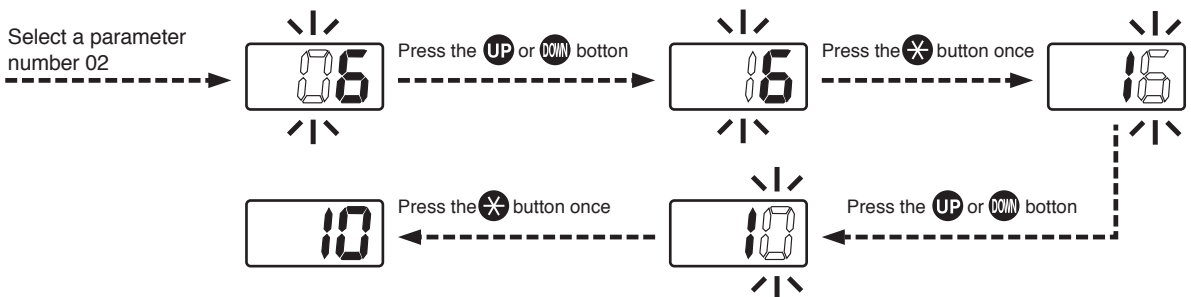

The display will return to  if you press the **✖** button after selection.

### ⚠ CAUTION

- When the temperature setting is 300°C (570°F) or less, the sleep function will not activate. Sleep even if the sleep function is turned ON.
- The tip temperature will rise to the set temperature during the initial power up even if the sleep time is set to "0". The tip temperature will be reduced to the sleep temperature after the temperature reaches the set temperature.

## ● 03 : Low temperature error setting



When the temperature drops below a set limit, an error is displayed and the buzzer sounds. When the temperature returns within the allowable range, the buzzer stops.

**Low temperature setting range** : for Celsius: 30 to 300°C  
for Fahrenheit: 54 to 540°F



**Example** : When the set temperature is 350°C and the low temperature error setting is 100°C, a warning buzzer sounds when the temperature drops to 250°C.

1. The hundreds digit begins to flash when entering the low temperature setting.
2. If you enter a value outside the low temperature setting range (see the acceptable range above), the display returns to the hundreds digit, and you have to enter a correct value.
3. The display will return to  if you press the  button after selection.

## ● 05 : S-E, C-E Buzzer sound setting mode



1. In the buzzer sound setting mode, either  or  is displayed.  
 : The buzzer does not sound if a sensor or connector error occurs.  
 : The buzzer sounds if a sensor or connector error occurs.
2.  and  will be switched alternately if you press the  (  ) button.
3. The display will return to  if you press the  button after selection.

## ● 06 : Set temperature alert setting mode

1. In the set temperature alert setting mode, either  or  is displayed.  
 : The buzzer does not sound when the soldering iron reaches the set temperature.  
 : The buzzer sounds when the soldering iron reaches the set temperature.
2.  and  will be switched alternately if you press the  (  ) button.
3. The display will return to  if you press the  button after selection.

## ● 07 : Auto sleep on/off setting

**NOTE:** When the auto sleep function is on, removing the iron from the iron holder or pressing the button resumes operations.

1. In the auto sleep setting mode, either  or  is displayed.  
 : The auto sleep function is off, regardless of the auto sleep set time.  
 : The auto sleep function is on, and the auto sleep time is activated.
2.  and  will be switched alternately if you press the  (  ) button.
3. The display will return to  if you press the  button after selection.

## ● 08 : Auto shutoff on/off setting

When the auto shutoff function is set to on and no operation is performed for 30 minutes (Initial value) after the iron is set in the iron holder, the buzzer sounds and the auto shutoff function will be enabled. Leaving the iron in the iron holder as it is, the buzzer sounds every 30 minutes.

1. In the auto shutoff setting mode, either  or  is displayed.  
 : The auto shutoff function is off, regardless of the auto sleep function set time.  
 : The auto shutoff function is on, and the auto shutoff time is activated.
2.  and  will be switched alternately if you press the **UP** ( **DOWN** ) button.
3. The display will return to  if you press the **✖** button after selection.

## ● 12 : Power-mode setting

**NOTE:** High-power mode is mainly suited for applications that require large heat capacity such as quick soldering of ground patterns or cast metal products.

1. In the Power-mode setting mode, either  or  is displayed.  
 : Selects High power mode.  
 : Selects Normal power mode.
2.  and  will be switched alternately if you press the **UP** ( **DOWN** ) button.
3. The display will return to  if you press the **✖** button after selection.

### **⚠ CAUTION**

If the tip is overloaded, it may cause overshooting.

## ● 13 : Auto sleep temperature setting

Sets the auto sleep temperature. Setting a high sleep temperature enables shorter start up time when the unit recovers from sleep mode.

### **⚠ CAUTION**

Setting the sleep temperature too high will shorten tip life.

**Auto sleep temperature setting range :** for Celsius: 200°C to 300°C  
for Fahrenheit: 390°F to 580°F

1. When the unit enters auto sleep temperature setting mode, the hundreds digit starts flashing. Enter a desired value within the auto sleep temperature setting range.
2. If the entered value exceeds the auto sleep temperature setting range (see acceptable values above), the hundreds digit starts flashing again. If this happens, enter a correct value.
3. The display will return to  if you press the **✖** button after selection.

## ● 14 : Password setting

If selecting Restricted, perform the setting for password. If selecting Partial, choose whether or not the password function is needed when changing the set temperature, the preset number and the offset value and set the password.

1. Either  ,  or  will be displayed if you press the **✳** button when  is displayed.
2. If you press the **UP** ( **DOWN** ) button,  (Open),  (Partial) and  (Restricted) will be switched alternately.
3. The display will return to  if you press the **✳** button after selection.\*1, 2

**\*1 The display will move to the following selection screen if you select  (Partial).**

4. After pressing the **✳** button, you will be asked whether or not the password function is needed when moving to the temperature setting mode.
5. Either  (without password) or  (with password) will be displayed if you press the **UP** ( **DOWN** ) button.
6. If you press the **✳** button after selecting, you will be asked whether or not the password function is needed when moving to the preset selection mode.
7. Either  (without password) or  (with password) will be displayed if you press the **UP** ( **DOWN** ) button.
8. If you press the **✳** button after selecting, you will be asked whether or not the password function is needed when moving to the offset mode.
9. Either  (without password) or  (with password) will be displayed if you press the **UP** ( **DOWN** ) button.
10. The display will return to 14 after pressing the **✳** button.



**\*2 If you select  (Restricted), the display will move to the following password setting screen.  
If you select  (Partial), the display will move to the following the password setting screen after completing ✳ 1 .**

11. The hundreds digits in the display will begin to flash. It indicates that you can enter the letter.  
Press the **UP** ( **DOWN** ) button to enter the letter you required.
12. The tens digits in the display will begin to flash if you press the **✳** button after entering.  
Use the same procedure to enter the letters for tens and ones digit.
13. The display will return to  if you press the **✳** button after entering the ones digit.

---

## ● 18 : Auto shutoff time setting

Set auto shutoff time. The setting is possible within 30 to 60 minutes, in one minute increments.

1. Auto shutoff time (Initial value is 30 minutes) will be displayed if you press the \* button when  is displayed.
2. Press the UP (DOWN) button, you can change to the desired value. Enter a value from 30 to 60 (minutes).
3. The display will return to  if you press the \* button after selection.



# 8. MAINTENANCE

---

Performing proper and periodic maintenance extends product life and contributes to the quality of soldering work. Efficient soldering depends upon the temperature, the quality and quantity of the solder and flux. Apply the following service procedure as dictated by the conditions of the usage.

## WARNING

Since the soldering iron can reach a very high temperature, please work carefully. Except where indicated, always turn the power switch OFF and disconnect the power plug before performing any maintenance procedure.

### ● Tip maintenance

#### 1. Tip temperature

High temperatures shorten tip life and may cause thermal shock to components. Always use the lowest possible temperature when soldering. The excellent thermal recovery characteristics of the HAKKO FX-801 ensures effective soldering at low temperatures.

#### 2. Cleaning

Always clean the soldering iron tip before use, to remove any residual solder or flux adhering to it by using a tip cleaner. Contaminants on the tip have many deleterious effects, including reduced heat conductivity, which contribute to poor soldering performance.

#### 3. After use

Always clean the tip and coat it with fresh solder after use. This guards against oxidation.

#### 4. When the unit is not being used

Never allow the unit to idle at a high temperature for extended periods. This will cause the tip to become oxidized. Turn the power switch OFF. If it is to be out of service for several hours, it is advised to disconnect the power plug as well.

#### 5. Inspecting and cleaning the tip

If followed daily, this procedure will materially add to tip life.

- a. Set the temperature to 250°C (482°F).
- b. When the temperature stabilizes, clean the tip and check the condition of the tip.  
If the tip is badly worn or deformed, replace it.
- c. If the solder plated part of the tip is covered with black oxide, apply fresh solder, containing flux, and clean the tip again. Repeat until all the oxide is removed, then coat the tip with fresh solder.
- d. Turn the power OFF and remove the tip, using the heat resistant pad. Set the tip aside to cool. Remaining oxides can be removed with isopropyl alcohol.

## CAUTION

**NEVER** file or use abrasive materials on the tip to remove oxides!

# 9. CHECKING PROCEDURE

## WARNING

Unless otherwise directed, carry out these procedures with power switch OFF and the power UNPLUGGED.

### ■ Check for a broken heater or sensor

Verify the electrical integrity of the heater and sensor.

Measure the resistance of the heater and sensor while at room temperature (15°C to 25°C; 59°F to 77°F)

It should be  $3.4\Omega \pm 10\%$ . If the resistance exceeds these limits, replace it.

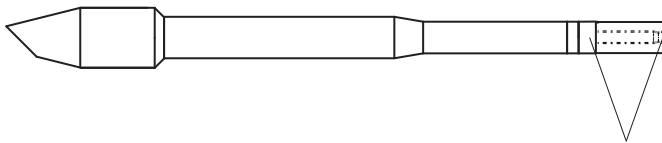

Measure the heater/sensor resistance between these points.

### ■ Check the grounding line

1. Unplug the iron cable from the station.
2. Measure the resistance between pin #2 and the soldering iron tip (with iron cable connected to the HAKKO FX-8002).
3. If the value exceeds  $2\Omega$  (at room temperature), perform the tip maintenance in page 16.  
If the value still does not decrease, check the connection cord for breakage.

### ■ Check the iron cable for breakage

Measure the resistance of the connector pin.

Between Pin #1 to Pin #3 -  $3.0$  to  $3.8\Omega$

If the resistance exceeds these limits, replace the iron cable.

Contact your HAKKO representative.

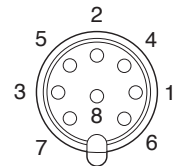

### ■ Replace the fuse

1. Unplug the power cord from the power receptacle.
2. Remove the fuse holder.
3. Replace the fuse.
4. Put the fuse holder back in place.

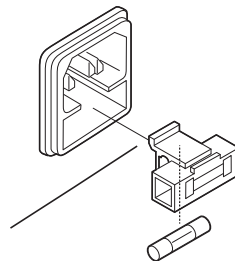

# 10. ERROR MESSAGES

## ● Sensor error



When there is a possibility that a failure has occurred in the sensor or heater (including the sensor circuit), **S-E** is displayed and a buzzer sounds.

## ● Soldering iron error



**I-E** is displayed and a buzzer sounds if the iron cable is not attached to the station or a wrong soldering iron is connected.

## ● Low-temperature alarm tolerance error



If the tip temperature falls below the low-temperature alarm limit, **H-E** is displayed and a buzzer sounds. When the tip temperature rises above the low-temperature alarm limit, the buzzer will stop.

**Example :** 350°C (400°C – 50°C)

Set temperature      Low-temperature alarm tolerance

## ● Heater terminal short circuit error



**HSE** is displayed and a buzzer sounds when the tip is inserted incorrectly, an incompatible tip is inserted, or when a foreign object has found its way into the connector.

## ● System error

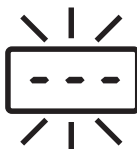

When a system error occurs such as data flash, the soldering iron is immediately de-energized and **---** is displayed.

# 11. TROUBLE SHOOTING GUIDE

---

## ● The unit does not operate when the power switch is turned ON.

**CHECK** : Is the power cord and/or the connection plug disconnected?

**ACTION** : Correctly connect the power cord.

**CHECK** : Is the fuse down?

**ACTION** : Investigate why the fuse blew and then replace the fuse.  
If the fuse blows again, send the unit in for repair.

## ● The tip does not heat up.

• The sensor error **5-E** is displayed.

**CHECK** : Is the tip inserted properly?

**ACTION** : Insert the tip completely.

**CHECK** : Check the iron cable and/or the heater/sensor for breakage.

**ACTION** : See “■ Checking the iron cable for breakage” and “■ Check for a broken heater or sensor” in page 17. Replace any faulty part.

## ● Solder does not wet the tip.

**CHECK** : Is the tip temperature too high?

**ACTION** : Set the appropriate temperature.

**CHECK** : Is the tip contaminated with oxide?

**ACTION** : Remove the oxide.

(See “● Tip maintenance” in page 16.)

## ● The tip temperature is too high

**CHECK** : Is the iron cable broken?

**ACTION** : See “■ Checking the iron cable for breakage” in page 17.

**CHECK** : Is the entered offset value correct?

**ACTION** : Enter the correct offset value.

## ● The tip temperature is too low.

**CHECK** : Is the tip contaminated with oxide?

**ACTION** : Remove the oxide.

(See “● Tip maintenance” in page 16.)

**CHECK** : Is the entered offset value correct?

**ACTION** : Enter the correct offset value.

## ● The soldering iron error **7-E** is displayed.

**CHECK** : Is the proper soldering iron connected? Or, is the iron cable properly connected?

**ACTION** : Re-connect the HAKKO FX-8002 iron cable to the station.

---

●The low-temperature alarm tolerance error **H-E** is displayed frequently.

**CHECK** : Is the tip too small for the work being soldered?

**ACTION** : Use a tip with a larger thermal capacity.

**CHECK** : Is the setting value for the low-temperature alarm tolerance too low?

**ACTION** : Increase the setting value.

●Heater terminal short circuit error **HSE** is displayed.

**CHECK** : Is the tip for the HAKKO FX-8002?

**ACTION** : Turn the power switch OFF and insert the genuine HAKKO FX-8002 tip. Turn the power switch ON.

●System error **---** is displayed.

**ACTION** : Contact your HAKKO representative.

※ 各言語（日本語、英語、中国語、フランス語、ドイツ語、韓国語）の取扱説明書は以下のURL、HAKKO Document Portalからダウンロードしてご覧いただけます。  
(商品によっては設定の無い言語がありますが、ご了承ください)  
\* 各國語言(日語,英語,中文,法語,德語,韓語)的使用說明書可以通過以下網站的HAKKO Document Portal 下載參閱。  
(有一部分的產品沒有設定外語對應,請見諒)  
\* Instruction manual for the language, Japanese, English, Chinese, French, German and Korean can be downloaded from the following URL, HAKKO Document Portal.  
(Please note that some language may not be available depending on the product.)



<https://doc.hakko.com>

# 12. PARTS LIST

For more information about replacement parts or latest information, please visit our website (<http://www.hakko.com>) or HAKKO Document Portal. (see below)

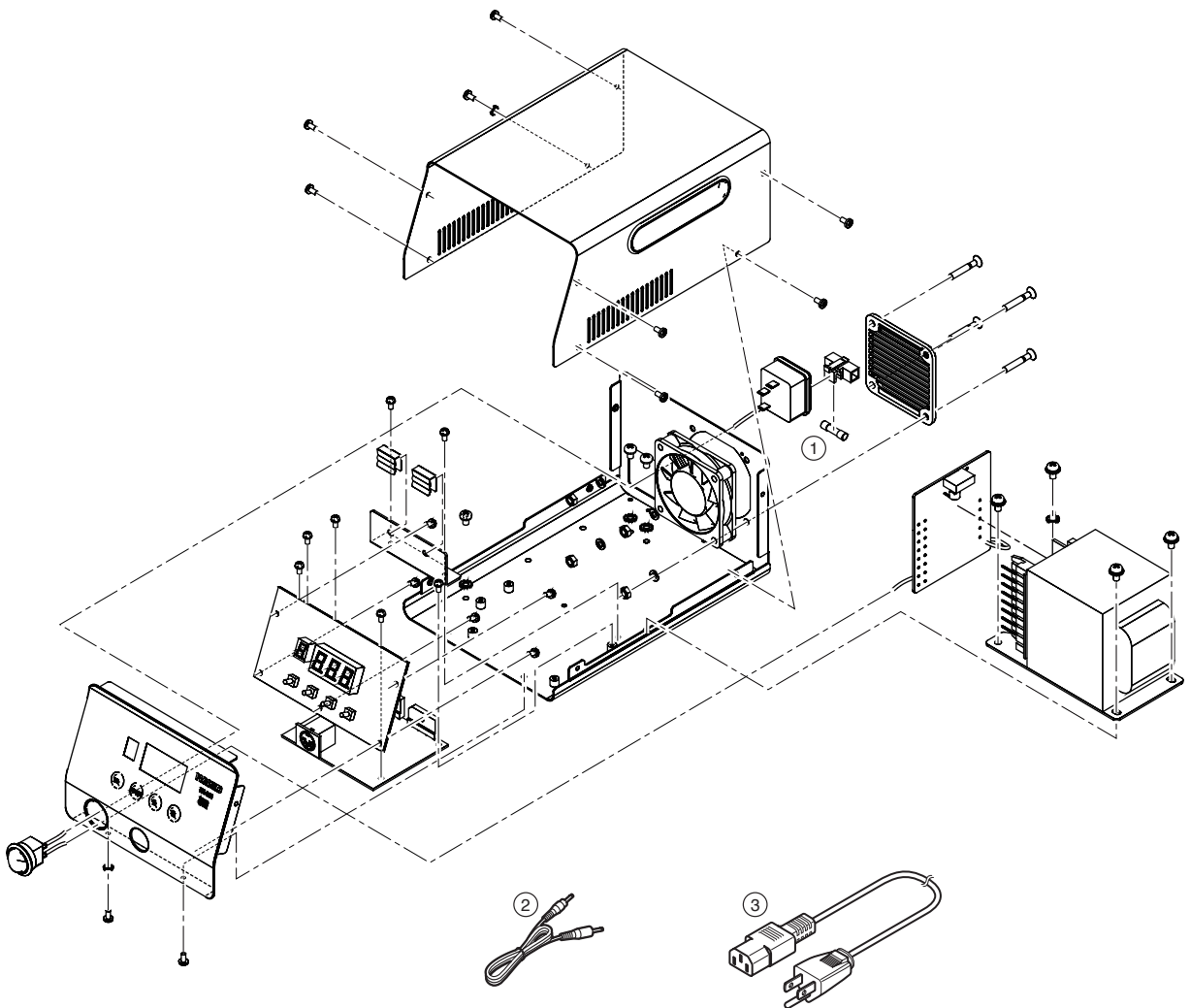

## ● HAKKO FX-801

Item No.	Part No.	Part Name	Specifications
①	B3674	Fuse/250V-7A	100 - 120V
	B3675	Fuse/250V-4A	220 - 240V
②	B3253	Connecting cable	
③	B2419	Power cord, 3-wire cord & American plug	120V USA
	B2421	Power cord, 3-wire cord but no plug	
	B2422	Power cord, 3-wire cord & BS plug	India

Item No.	Part No.	Part Name	Specifications
③	B2424	Power cord, 3-wire cord & European plug	220V KTL 230V CE
	B2425	Power cord, 3-wire cord & BS plug	230V CE
	B2436	Power cord, 3-wire cord & Chinese plug	China
	B2426	Power cord, 3-wire cord & Australian plug	
	B3508	Power cord, 3-wire cord & American plug (B)	
	B3550	Power cord, 3-wire cord & SI plug	

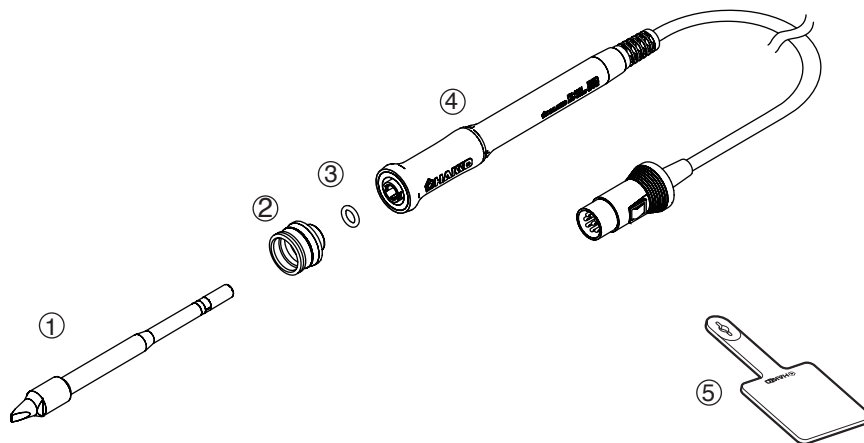

### ● HAKKO FX-8002

Item No.	Part No.	Part Name	Specifications
①		Tip	See section "TIP STYLE"
②~④	FX8002-81	HAKKO FX-8002	29V-260W
② ③	B5071	Nipple	With O-ring
③	B2578	O-ring	
⑤	B2300	Heat resistant pad	

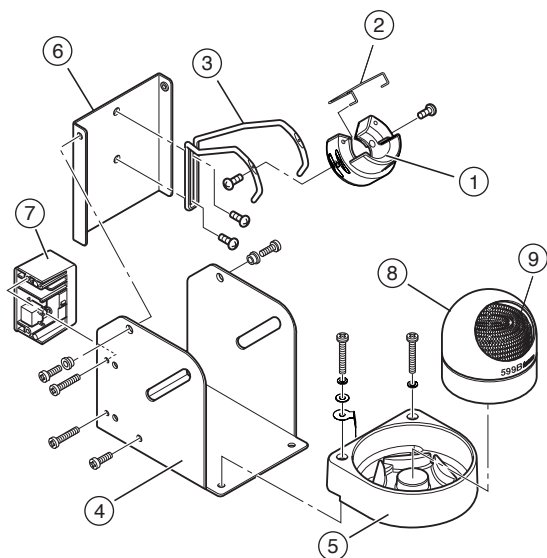

### ● Iron holder

Item No.	Part No.	Part Name	Specifications
①~⑨	FH200-83	HAKKO FH-200	with Cleaning wire

### ● Iron holder parts

Item No.	Part No.	Part Name	Specifications
①	B5083	Iron receptacle	With Screws
②	B2791	Tip fixing spring	
③	B5084	Holder for iron receptacle	With Screws
④	B3251	Iron holder base	With Rubber foot
⑤	B3249	Cleaner base	With Rubber foot
⑥	B3250	Stay	
⑦	B3252	Switch case assembly	
⑧	599B-02	Tip cleaner	
⑨	599-029	Cleaning wire	

# 13. WIRING DIAGRAM

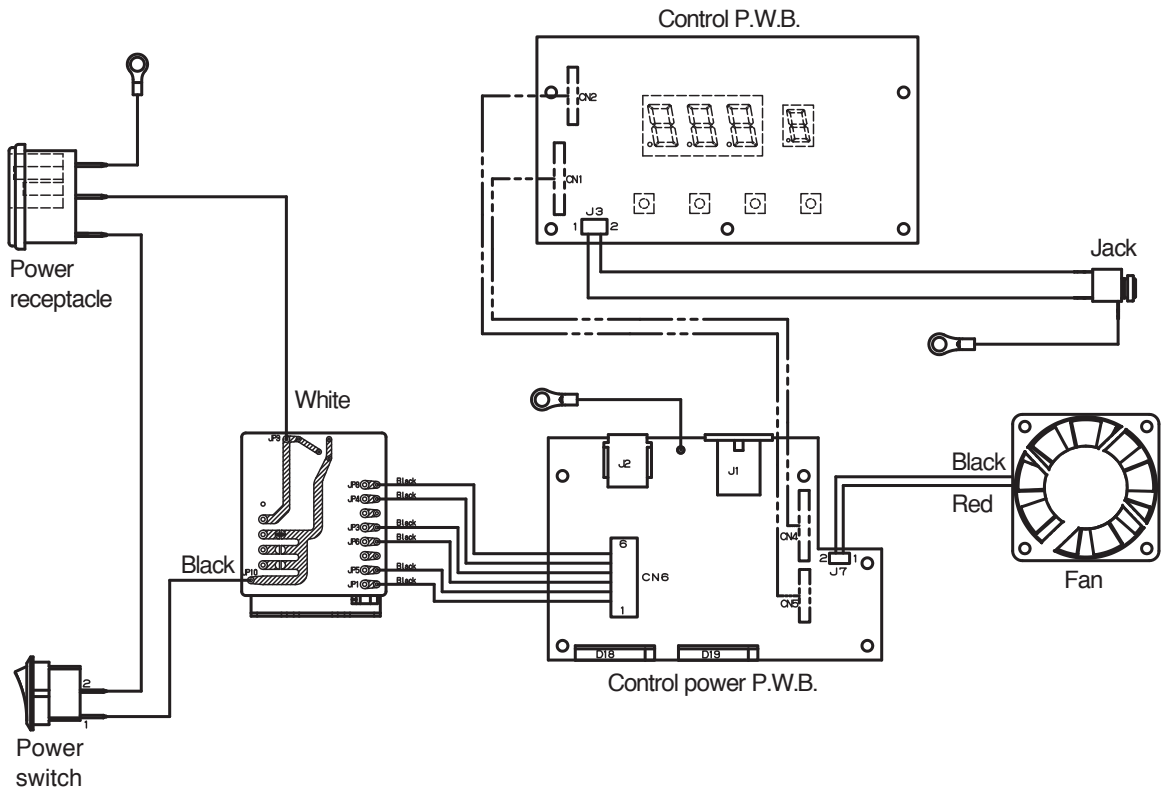



# TIP STYLES

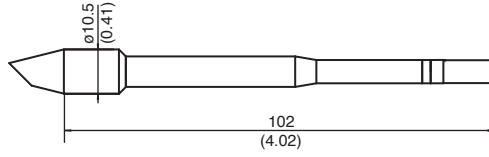

Unit : mm (in.)

T33-BC2 SHAPE-2BC

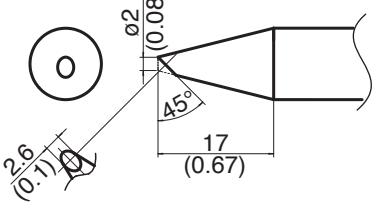

T33-BC3 SHAPE-3BC

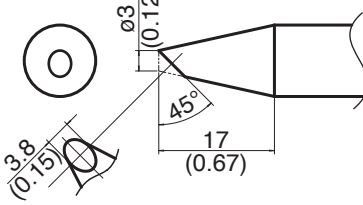

T33-BC4 SHAPE-4BC

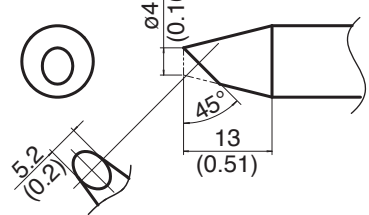

T33-BC5 SHAPE-5BC

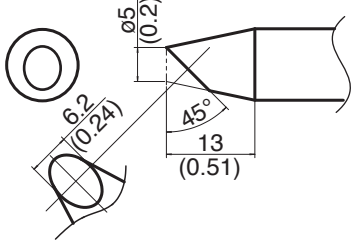

T33-BC6 SHAPE-6BC

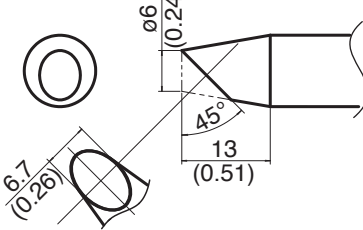

T33-D24 SHAPE-2.4D

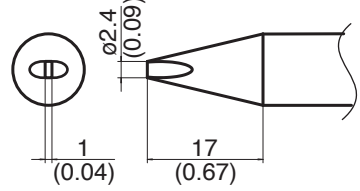

T33-D32 SHAPE-3.2D

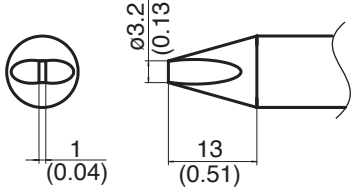

T33-D5 SHAPE-5D

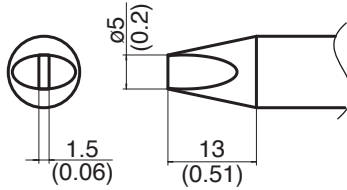

T33-D6 SHAPE-6D

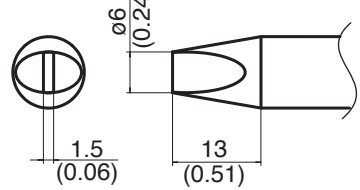

中國RoHS: 產品中有毒有害物質或元素的名稱及含量

部件名稱	有毒有害物質或元素					
	鉛(Pb)	汞(Hg)	鎘(Cd)	六價鉻 (Cr(VI))	多溴聯苯 (PBB)	多溴二苯醚 (PBDE)
焊鐵部	×	○	○	○	○	○
插頭	×	○	○	○	○	○
電路板	×	○	○	○	○	○
<p>○：表示該有毒有害物質在該部件所有均質材料中的含量均在SJ/T 11363-2006標準規定的限量要求以下。</p> <p>×：表示該有毒有害物質至少在該部件的某一均質材料中的含量超出SJ/T 11363-2006標準規定的限量要求。</p>						



**HAKKO CORPORATION**  
**HEAD OFFICE**

4-5, Shiokusa 2-chome, Naniwa-ku, Osaka 556-0024 JAPAN  
TEL:+81-6-6561-3225 FAX:+81-6-6561-8466  
<http://www.hakko.com> E-mail:sales@hakko.com

**OVERSEAS AFFILIATES**

**U.S.A.: AMERICAN HAKKO PRODUCTS, INC.**

TEL: (661) 294-0090 FAX: (661) 294-0096

Toll Free (800)88-HAKKO

<http://www.hakkousa.com>

**HONG KONG: HAKKO DEVELOPMENT CO., LTD.**

TEL: 2811-5588 FAX: 2590-0217

<http://www.hakko.com.hk>

E-mail:info@hakko.com.hk

**SINGAPORE: HAKKO PRODUCTS PTE LTD.**

TEL: 6748-2277 FAX: 6744-0033

<http://www.hakko.com.sg>

E-mail:sales@hakko.com.sg

Please access to the following address for the other Sales affiliates.

<http://www.hakko.com>