

ISOMETRIC VIEW

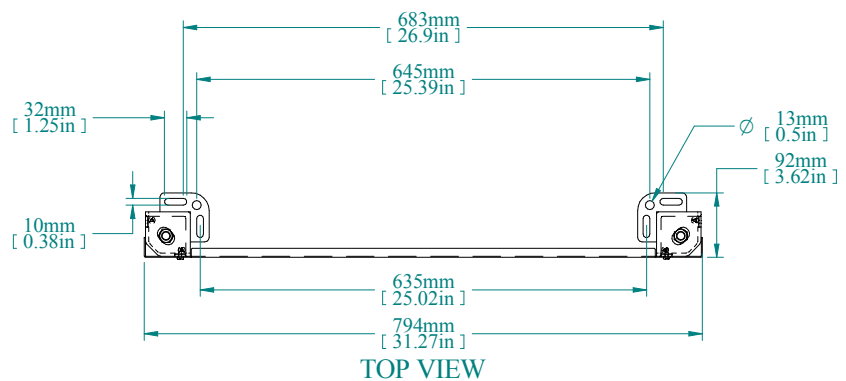

TOP VIEW

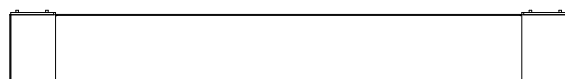

REAR VIEW



L.S. VIEW

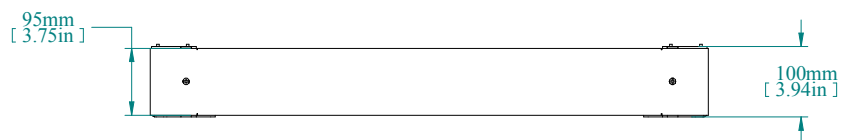

FRONT VIEW

PART NUMBERS	
HPLW18	PAINTED TEXTURED BLACK

NOTES
HPLW contains 4 corner supports along with corresponding front and rear panels. See Hammond Website for Additional Accessories.

Data subject to change without notice. Isometric drawing not to scale.



**HAMMOND  
MANUFACTURING™**  
www.hammondmfg.com  
PART NO. HPLW18