



Inline Ratchet Clamps

Adjustable, heavy-duty, center-mount cable management

MADE FOR REAL 

Bundling and Securing

Ratchet Clamps

Inline Ratchet Clamps

Bolt Mount Ratchet Clamp

The Bolt Mount Ratchet Clamp offers versatility when managing conduit, wires, cables and hoses. It is specially designed for locations with space constraints or where offset mounting options are not ideal. Available with a compression limiter for crush resistance in high-torque applications, or in all-plastic for low- to medium-torque applications. The robust design and durable materials make it ideal for heavy duty applications, both indoors and out. The adjustable clamp can be closed by hand to the desired diameter. The release feature allows easy and nondestructive removal or addition of cables simply by inserting a flat-head screwdriver. In this way, the clamp can be reused without removing it from the mounting surface.

Features and Benefits

- Smaller footprint for applications where space is constrained.
- Attach using a bolt in an existing threaded hole, or bolt and nut for a non-threaded hole, for versatile mounting options.
- One-piece ratchet closure allows for fast and easy installation.
- Clamp interior is designed to guide and center bundles to reduce pinching.

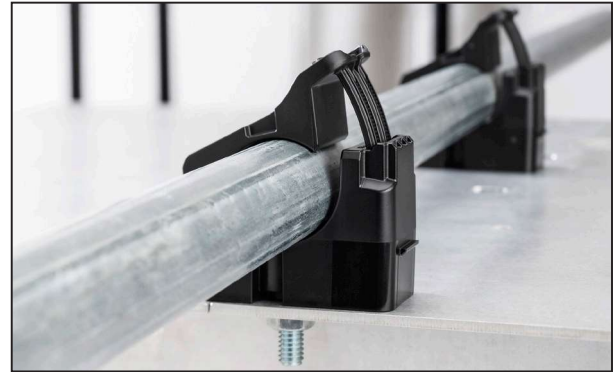

MATERIAL	Polyamide 6.6 high impact modified, heat and UV stabilized (PA66HIRHSUV)
Operating Temperature	-40°F to +221°F (-40°C to +105°C)
Flammability	UL 94 HB
Color	Black (BK)

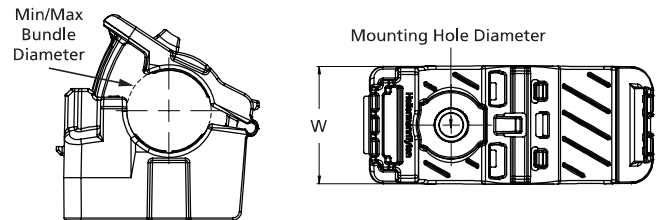

PART NO.	TYPE	Mounting Hole Dia. in. (mm) Mounting Hole Ø	Bolt Size in. (mm)	Min. Bundle Diameter in. (mm)	Max. Bundle Diameter in. (mm)	Min. Tensile Strength lbs. (N)	Width (W) in. (mm)	Pkg. Qty.
Low Torque								
151-03540*	CMRCBLM6	0.248 (6.3)	0.2 (6.0)	0.5 (12.7)	0.8 (19.6)	200.0 (889.0)	1.4 (35.1)	150
151-04005*		0.248 (6.3)	0.2 (6.0)	0.5 (12.7)	0.8 (19.6)	200.0 (889.0)	1.4 (35.1)	25
151-03541*	CMRCBLM8	0.327 (8.3)	0.3 (8.0)	0.5 (12.7)	0.8 (19.6)	200.0 (889.0)	1.4 (35.1)	150
151-04006*		0.327 (8.3)	0.3 (8.0)	0.5 (12.7)	0.8 (19.6)	200.0 (889.0)	1.4 (35.1)	25
151-03550*	CMRCCLM6	0.248 (6.3)	0.2 (6.0)	0.8 (19.3)	1.4 (36.1)	250.0 (1112.0)	1.4 (35.1)	150
151-04007*		0.248 (6.3)	0.2 (6.0)	0.8 (19.3)	1.4 (36.1)	250.0 (1112.0)	1.4 (35.1)	25
151-03551*	CMRCCLM8	0.327 (8.3)	0.3 (8.0)	0.8 (19.3)	1.4 (36.1)	250.0 (1112.0)	1.4 (35.1)	150
151-04008*		0.327 (8.3)	0.3 (8.0)	0.8 (19.3)	1.4 (36.1)	250.0 (1112.0)	1.4 (35.1)	25
151-03552*	CMRCCLM10	0.405 (10.3)	0.4 (10.0)	0.8 (19.3)	1.4 (36.1)	250.0 (1112.0)	1.4 (35.1)	150
151-04009*		0.405 (10.3)	0.4 (10.0)	0.8 (19.3)	1.4 (36.1)	250.0 (1112.0)	1.4 (35.1)	25
151-03561	CMRCCLM6	0.248 (6.3)	0.2 (6.0)	1.4 (36.1)	2.0 (50.8)	250.0 (1112.0)	1.4 (35.1)	150
151-03562	CMRCCLM8	0.327 (8.3)	0.3 (8.0)	1.4 (36.1)	2.0 (50.8)	250.0 (1112.0)	1.4 (35.1)	150

Dimensions are approximate and subject to technical changes. Use Part No. for ordering and Type for specification purposes.

*This product meets UL standards. Please go to hellermannityton.us for specific file numbers.

Inline Ratchet Clamps

Bolt Mount Ratchet Clamp

PART NO.	TYPE	Mounting Hole Dia. in. (mm) Mounting Hole Ø	Bolt Size in. (mm)	Min. Bundle Diameter in. (mm)	Max. Bundle Diameter in. (mm)	Min. Tensile Strength lbs. (N)	Width (W) in. (mm)	Pkg. Qty.
151-03563	CMRCCLM10	0.405 (10.3)	0.4 (10.0)	1.4 (36.1)	2.0 (50.8)	250.0 (1112.0)	1.4 (35.1)	150
High Torque								
151-03538	CMRCBHM6	0.276 (7.0)	0.2 (6.0)	0.5 (12.7)	0.8 (19.6)	200.0 (889.0)	1.4 (35.1)	150
151-03539	CMRCBHM8	0.354 (9.0)	0.3 (8.0)	0.5 (12.7)	0.8 (19.6)	200.0 (889.0)	1.4 (35.1)	150
151-03547	CMRCCHM6	0.276 (7.0)	0.2 (6.0)	0.8 (19.3)	1.4 (36.1)	250.0 (1112.0)	1.4 (35.1)	150
151-03548	CMRCCHM8	0.354 (9.0)	0.3 (8.0)	0.8 (19.3)	1.4 (36.1)	250.0 (1112.0)	1.4 (35.1)	150
151-03549	CMRCCHM10	0.441 (M10)	0.4 (10.0)	0.8 (19.3)	1.4 (36.1)	250.0 (1112.0)	1.4 (35.1)	150
151-03558	CMRCDHM6	0.276 (7.0)	0.2 (6.0)	1.4 (36.1)	2.0 (50.8)	250.0 (1112.0)	1.4 (35.1)	150
151-03559	CMRCDHM8	0.354 (9.0)	0.3 (8.0)	1.4 (36.1)	2.0 (50.8)	250.0 (1112.0)	1.4 (35.1)	150
151-03560	CMRCDHM10	0.441 (M10)	0.4 (10.0)	1.4 (36.1)	2.0 (50.8)	250.0 (1112.0)	1.4 (35.1)	150

Dimensions are approximate and subject to technical changes. Use Part No. for ordering and Type for specification purposes.

*This product meets UL standards. Please go to hellermann-tyton.com for specific file numbers.



Please note - not all products listed on this page may have this approval. Please see www.Hellermann.Tyton.com for the latest approvals.

Bundling and Securing

Ratchet Clamps

Inline Ratchet Clamps

Stud Mount Ratchet Clamps

The Stud Mount Ratchet Clamp offers versatility when managing wires, cables and hoses. It is specially designed for locations with space constraints or where offset mounting options are not ideal. Easily attaches to existing studs or bolts without the need for additional hardware. The robust design and durable materials make it ideal for heavy duty applications, both indoors and out. The adjustable clamp can be closed by hand to the desired diameter. The release feature allows easy and nondestructive removal or addition of cables simply by inserting a flat-head screwdriver. In this way, the clamp can be reused without removing it from the mounting surface.

Features and Benefits

- Smaller footprint for applications where space is constrained.
- Easily attaches to existing bolts or studs, eliminating the need for additional hardware.
- Cover/stopper inside the clamp prevents stud from touching the cable bundle, minimizing chafing and protecting bundle from damage.
- One-piece ratchet closure design allows for easy installation during pre- or final assembly.
- Clamp interior is designed to guide and center bundles to reduce pinching.

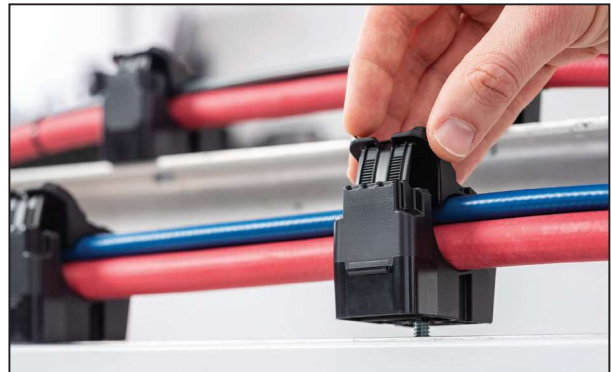

MATERIAL	Polyamide 6.6 high impact modified, heat and UV stabilized (PA66HIRHSUV)
Operating Temperature	-40°F to +221°F (-40°C to +105°C)
Flammability	UL 94 HB
Color	Black (BK)

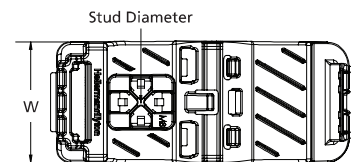
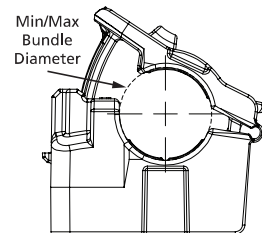

PART NO.	TYPE	Stud Size in. (mm)	Min. Bundle Diameter in. (mm)	Max. Bundle Diameter in. (mm)	Min. Tensile Strength lbs. (N)	Width (W) in. (mm)	Pkg. Qty.
151-03544	CMRCBSMM6	0.236 (6.0)	0.5 (12.7)	0.8 (19.6)	200.0 (889.0)	1.4 (35.1)	150
151-03545	CMRCBSMM8	0.315 (8.0)	0.5 (12.7)	0.8 (19.6)	200.0 (889.0)	1.4 (35.1)	150
151-03546	CMRCBSMM10	0.394 (10.0)	0.5 (12.7)	0.8 (19.6)	200.0 (889.0)	1.4 (35.1)	150
151-03555	CMRCCSMM6	0.236 (6.0)	0.8 (19.3)	1.4 (36.1)	250.0 (1112.0)	1.4 (35.1)	150
151-03556	CMRCCSMM8	0.315 (8.0)	0.8 (19.3)	1.4 (36.1)	250.0 (1112.0)	1.4 (35.1)	150
151-03557	CMRCCSMM10	0.394 (10.0)	0.8 (19.3)	1.4 (36.1)	250.0 (1112.0)	1.4 (35.1)	150
151-03566	CMRCDMM6	0.236 (6.0)	1.4 (36.1)	2.0 (50.8)	250.0 (1112.0)	1.4 (35.1)	150
151-03567	CMRCDMM8	0.315 (8.0)	1.4 (36.1)	2.0 (50.8)	250.0 (1112.0)	1.4 (35.1)	150
151-03568	CMRCDMM10	0.394 (10.0)	1.4 (36.1)	2.0 (50.8)	250.0 (1112.0)	1.4 (35.1)	150

Dimensions are approximate and subject to technical changes. Use Part No. for ordering and Type for specification purposes.

Inline Ratchet Clamps

Threaded Rod Ratchet Clamps

The Threaded Rod Mount Ratchet Clamp offers versatility when managing conduit, wires, cables and hoses. Specially designed for locations with space constraints or where offset mounting options are not ideal. Easily twists onto existing threaded rods, eliminating the need for additional hardware. The robust design and durable materials make it ideal for heavy duty applications, both indoors and out. The adjustable clamp can be closed by hand to the desired diameter. The release feature allows easy and nondestructive removal of cables simply by using a flat-head screwdriver. In this way, the clamp can be reused or serviced without removing it from the mounting surface.



Features and Benefits

- Smaller footprint for applications where space is constrained.
- Can be hand-twisted onto a threaded rod, allowing for quick installation, adjustment or removal.
- Clamp interior is designed to guide and center bundles to reduce pinching.

MATERIAL	Polyamide 6.6 high impact modified, heat and UV stabilized (PA66HIRHSUV)
Operating Temperature	-40°F to +221°F (-40°C to +105°C)
Flammability	UL 94 HB
Color	Black (BK)

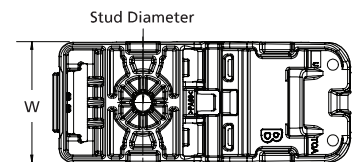
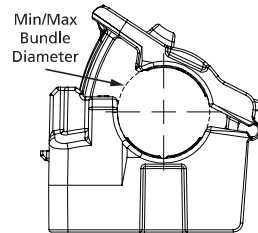

PART NO.	TYPE	Fixation Method	Min. Bundle Diameter in. (mm)	Max. Bundle Diameter in. (mm)	Min. Tensile Strength lbs. (N)	Width (W) in. (mm)	Pkg. Qty.
151-03542*	CMRCBTR14	1/4" Threaded Rod	0.5 (12.7)	0.8 (19.6)	200.0 (889.0)	1.4 (35.1)	150
151-03979*		1/4" Threaded Rod	0.5 (12.7)	0.8 (19.6)	200.0 (889.0)	1.4 (35.1)	25
151-03543*	CMRCBTR38	3/8" Threaded Rod	0.5 (12.7)	0.8 (19.6)	200.0 (889.0)	1.4 (35.1)	150
151-03980*		3/8" Threaded Rod	0.5 (12.7)	0.8 (19.6)	200.0 (889.0)	1.4 (35.1)	25
151-03553*	CMRCCTR14	1/4" Threaded Rod	0.8 (19.3)	1.4 (36.1)	250.0 (1112.0)	1.4 (35.1)	150
151-03984*		1/4" Threaded Rod	0.8 (19.3)	1.4 (36.1)	250.0 (1112.0)	1.4 (35.1)	25
151-03554*	CMRCCTR38	3/8" Threaded Rod	0.8 (19.3)	1.4 (36.1)	250.0 (1112.0)	1.4 (35.1)	150
151-03985*		3/8" Threaded Rod	0.8 (19.3)	1.4 (36.1)	250.0 (1112.0)	1.4 (35.1)	25
151-03564	CMRCDTR14	1/4" Threaded Rod	1.4 (36.1)	2.0 (50.8)	250.0 (1112.0)	1.4 (35.1)	150
151-03989		1/4" Threaded Rod	1.4 (36.1)	2.0 (50.8)	250.0 (1112.0)	1.4 (35.1)	25
151-03565	CMRCDTR38	3/8" Threaded Rod	1.4 (36.1)	2.0 (50.8)	250.0 (1112.0)	1.4 (35.1)	150
151-03990		3/8" Threaded Rod	1.4 (36.1)	2.0 (50.8)	250.0 (1112.0)	1.4 (35.1)	25

Dimensions are approximate and subject to technical changes. Use Part No. for ordering and Type for specification purposes.

*This product meets UL standards. Please go to hellermannTyton.com for specific file numbers.



Please note - not all products listed on this page may have this approval. Please see www.Hellermann.Tyton.com for the latest approvals.

Bundling and Securing

Bolt Mount Ratchet Clamp Installation Guide

STEP 1: Locate threaded mounting hole.



STEP 2: Position clamp, insert a bolt through the center of the clamp's base and tighten until secure.



If using 1/2" RMC, you must add soft inserts, part number: 151-01532



STEP 3: With rigid tubing in place, close clamp and press until tightly locked. Refer to chart for secure closure.

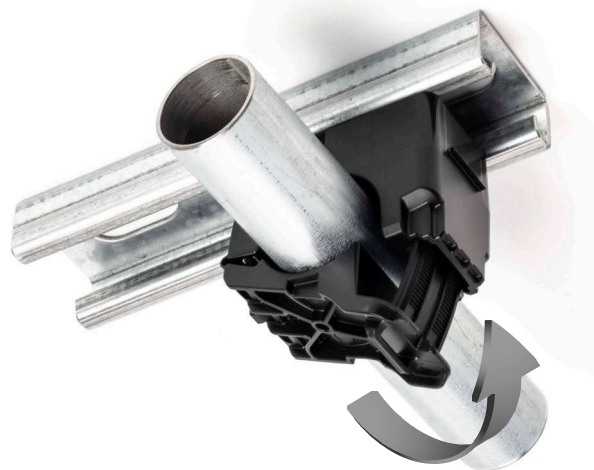

UL2239
Conduit & Cable Hanger
E523406

Product		Electrical metallic tubing (EMT)	Rigid metal conduit (RMC), Intermediate metal conduit (IMC)	Load Rating Safety Factor X3	Additional clicks for secure closure	
		Trade Size	Trade Size			
Low Torque	151-03540	CMRCBLM6	1/2"	3/8" RMC Only	50 lb	2
	151-03541	CMRCBLM8				
	151-03550	CMRCCLM6	3/4" and 1"	1/2" - 50 lb 3/4" - 50 lb 1" - 60 lb	4 (2 for 1" RMC)	
	151-03551	CMRCCLM8				
	151-03552	CMRCCLM10				

Bundling and Securing

Threaded Rod Ratchet Clamp Installation Guide

STEP 1: Press clamp base against threaded rod and rotate clockwise until secure.



If using 1/2" RMC, you must add soft inserts, part number: 151-01532



STEP 2: With rigid tubing in place, close clamp and press until tightly locked. Refer to chart for secure closure.



Threaded Rod Installation

CMRCBTR14 & CMRCBTR38

Min installation depth: 0.51" (13mm)
Max installation depth: 0.56" (14.3mm)

CMRCCTR14 & CMRCCTR38

Min installation depth: 0.51" (13mm)
Max installation depth: 0.66" (16.8mm)



UL2239
Conduit & Cable Hanger
E523406

Product			Electrical metallic tubing (EMT)	Rigid metal conduit (RMC), Intermediate metal conduit (IMC)	Load Rating Safety Factor X3	Additional clicks for secure closure
			Trade Size	Trade Size		
Threaded Rod	151-03542	CMRCBTR14	1/2"	3/8" RMC Only	50 lb	2
	151-03543	CMRCBTR38				
	151-03553	CMRCCTR14	3/4" and 1"	1/2", 3/4" and 1"	1/2" - 50 lb 3/4" - 50 lb 1" - 60 lb	4
	151-03554	CMRCCTR38				



HellermannTyton North American Corporate Headquarters

7930 N. Faulkner Rd, PO Box 245017
Milwaukee, WI 53224-9517
Phone: (414) 355-1130, (800) 537-1512
Fax: (414) 355-7341, (800) 848-9866
email: corp@htamericas.com
www.hellermann.tyton.com

IATF 16949, AS9100, ISO 9001 and ISO 14001 certified

Warranty Policy – HellermannTyton products are warranted to be free from defects in material and workmanship at the time sold by us; but our obligation under this warranty and that of the seller is limited to the replacement of the product, and neither we nor the seller are bound by any other warranty, expressed, implied or statutory. Under no circumstances are we or the seller liable for any loss, damage, expenses or consequential damages of any kind arising out of the use or inability to use these products. All are sold with the understanding that the user will test them in actual use and determine their adaptability for the intended uses.

HellermannTyton Canada

Unit #4, 205 Industrial Parkway North
Aurora, Ontario L4G 4C4 Canada
Phone: (800) 661-2461
Fax: (800) 390-3904
email: sales@hellermanntyton.ca

HellermannTyton Mexico

Anillo Periferico Sur 7980 Edificio 6A
Parque Industrial Tecnológico II
Santa María Tequepexpan
Tlaquepaque, Jalisco, Mexico 45601
Phone: 011-52-33-3-133-9880
Fax: 011-52-33-3-133-9861
email: info-mx@hellermanntyton.com

ISO 9001 certified