

LOCTITE[®]

PRINTED ELECTRONICS

INKS AND COATINGS

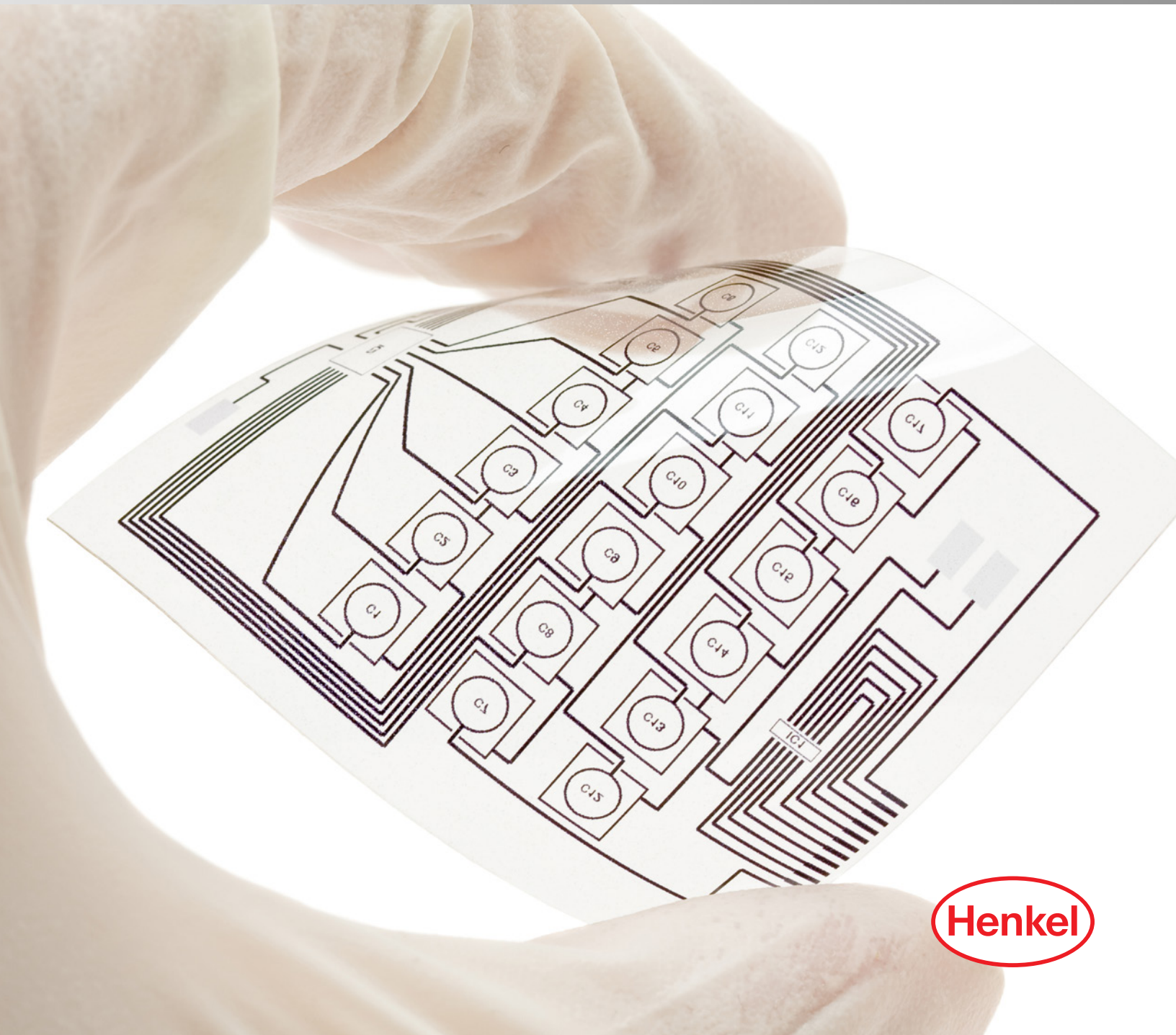

Henkel



INTRODUCTION

Countless devices rely on printed electronic technologies for function, form and flexibility. One of the most efficient production methods, printed electronics, allows for high-volume, high-throughput, cost-effective manufacturing for many of the products we rely on every day. Henkel is a leader in specialized and cross-functional ink formulations for printed electronics and its line of LOCTITE® brand electronic inks has been enabling leading-edge printed electronics for well over three decades.

With a broad portfolio of silver, carbon, dielectric and clear conductive inks, Henkel is making today's medical solutions, in-home conveniences, handheld connectivity and automotive advances reliable and effective. Our inks serve multiple markets including consumer, displays, medical and automotive and RFID. They are also used in the manufacture of:

- Flexible circuits for membrane touch switches
- Keyboards for desktop and notebook PCs
- Heating elements
- Automotive sensors
- Biosensors, EKG/ECG electrodes, TENS pads and Iontophoresis pads

- Antennas for contactless SmartCards and RFID labels
- Touch screens
- Lighting
- Printed circuit boards and potentiometers
- Household appliances

Like most things in electronics, the majority of applications that incorporate printed electronics are getting finer in dimension and more complex in functionality. Henkel's ability to formulate inks that address the demands of fine-line printing, while maintaining robust conductive and other functional properties, sets us apart from the competition, and has led to technology leadership within our comprehensive portfolio of inks for printed electronics.

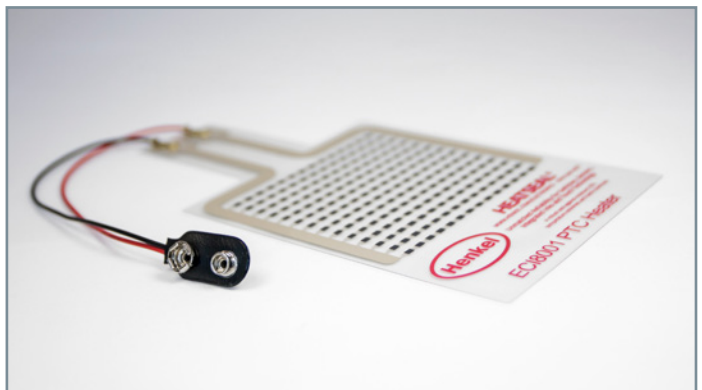

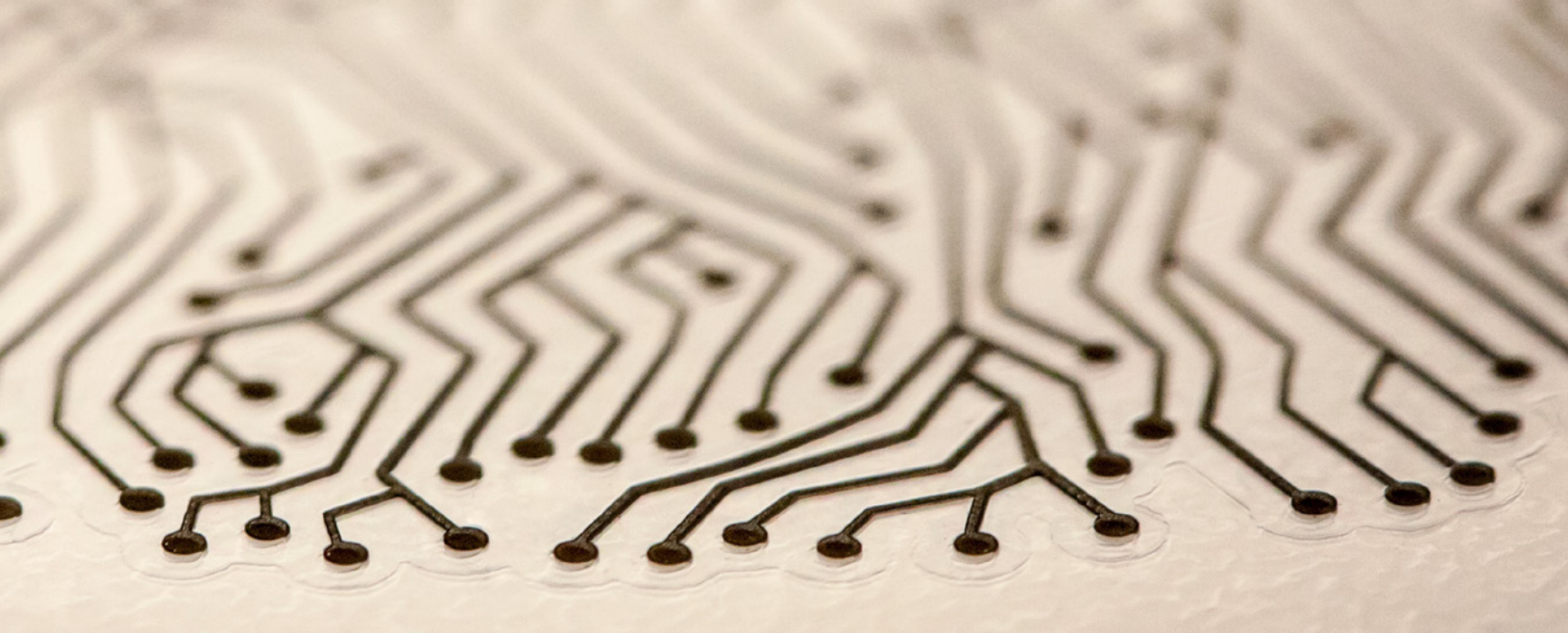

CONTENTS

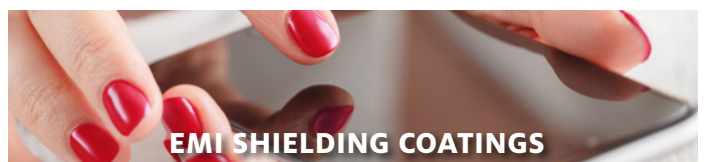
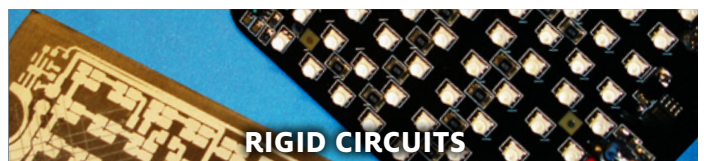
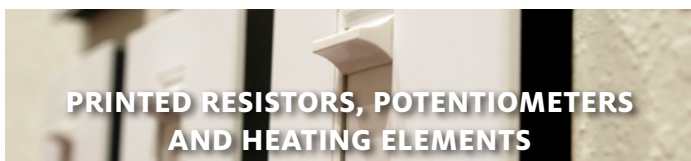
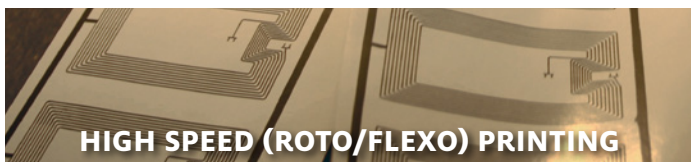
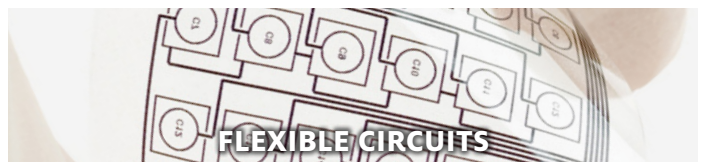
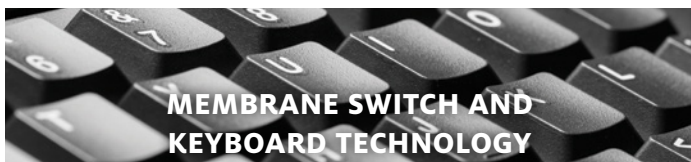



PRINTED ELECTRONIC INKS AND COATINGS APPLICATIONS

As consumers demand smaller and less expensive products, manufacturers must incorporate high-volume, low-cost solutions. Printing is one of the most cost-effective production methods for certain applications and printed electronics is helping to address this high throughput, reduced cost scenario. For current applications in printed electronics, Henkel has developed ink solutions for the three most commonly used technologies: flatbed (screen/stencil), flexographic and rotogravure printing.

Taking a total solutions approach, Henkel formulates ink sets that work together to provide customers completed systems with the functionality and environmental robustness for today's demanding applications.

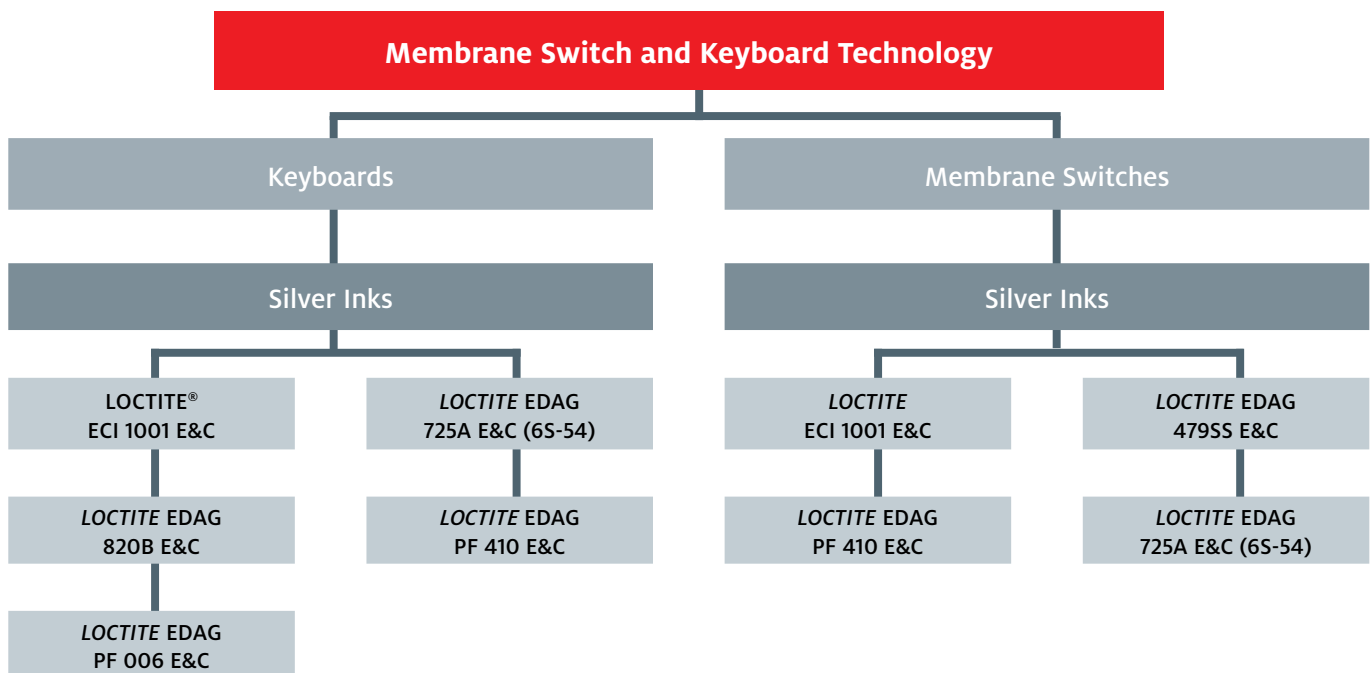

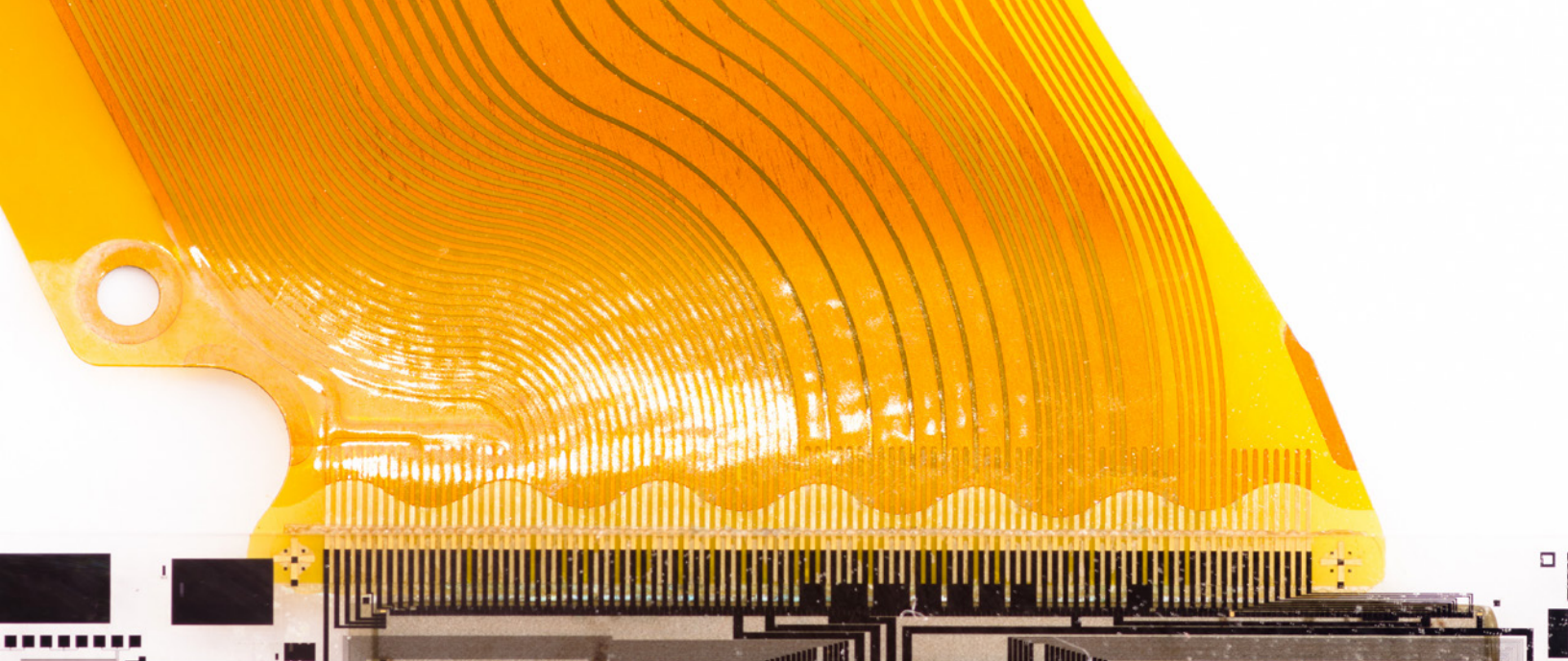

FLEXIBLE CIRCUITS

One of the largest and most diverse areas for conductive ink use is flex circuitry. The ability to easily construct circuits or change form factor through printing makes flex circuitry an ideal application for conductive inks. Henkel offers a wide selection of inks formulated for specific applications, cure requirements and substrates. Some of the latest ink technologies incorporate new functionality such as thermal forming capabilities and ink sets designed to measure forces applied to them.

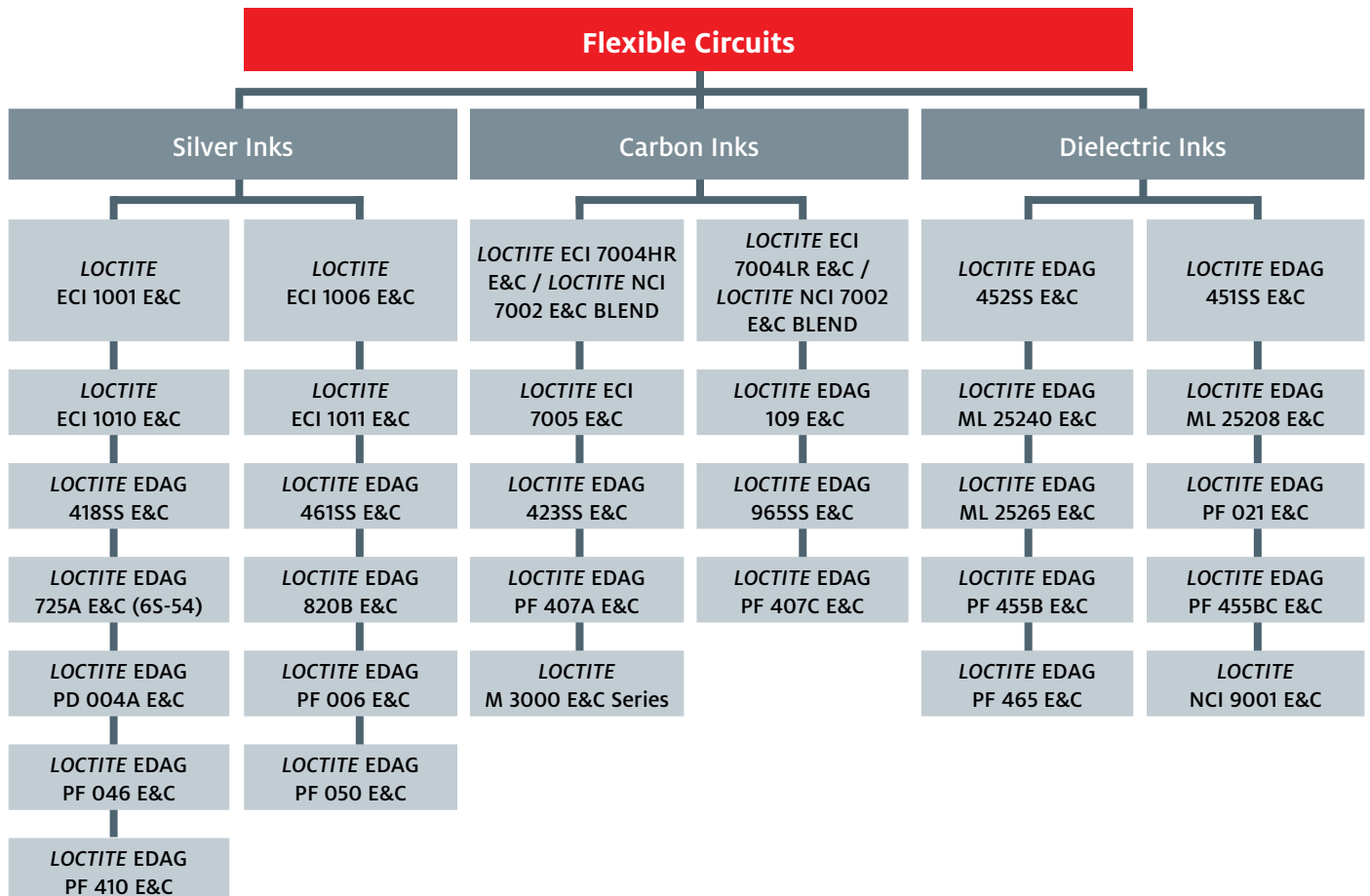



HIGH SPEED (ROTO/FLEXO) PRINTING

Flexo and Gravure printing technologies have seen many advances in ink development, process changes and press designs. Over the last ten years, these techniques have advanced high speed printing capabilities for printed electronics and circuitry. Developments range from changes in flexo plate designs and materials to improved anilox designs, drying capabilities and the press platforms themselves.

With continuous roll to roll processing, newer flexo machines are capable of running at speeds that cannot be matched with current flatbed printing. Henkel has developed a line of inks that can be effectively processed, deposited and cured at the thicknesses needed for today's functional inks.

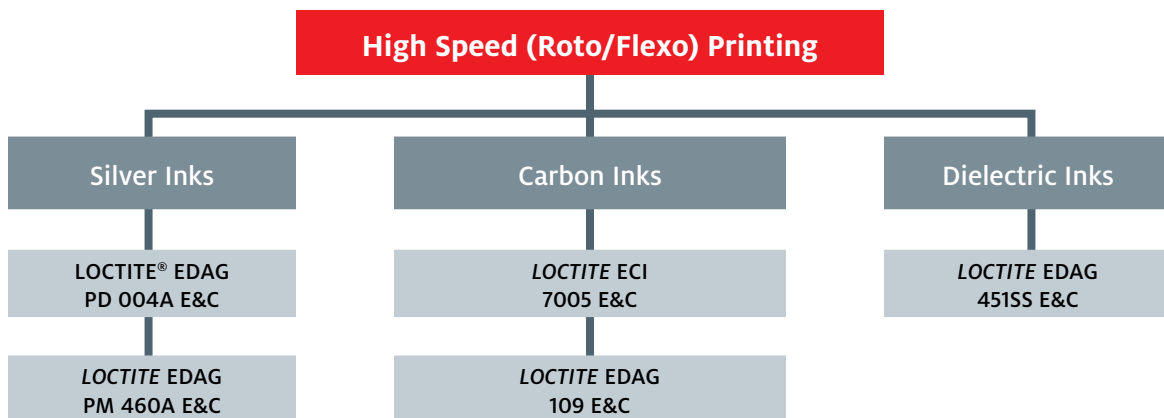



MEDICAL ELECTRODES AND BIOSENSORS

For medical electronics products, reliability and dependability are critical. Patient comfort, less invasiveness, disposable products and remote diagnostics are driving development in medical electronics. Biosensors such as glucose test strips, EKG/ECG electrodes, TENS pads for muscle stimulation, iontophoresis pads for drug delivery and countless other medical electronics applications depend on Henkel inks to provide accuracy, reliability and compatibility. Formulated to be compatible with the human body and various interactive medical gels and chemicals, Henkel's advanced inks are making modern medical devices possible.

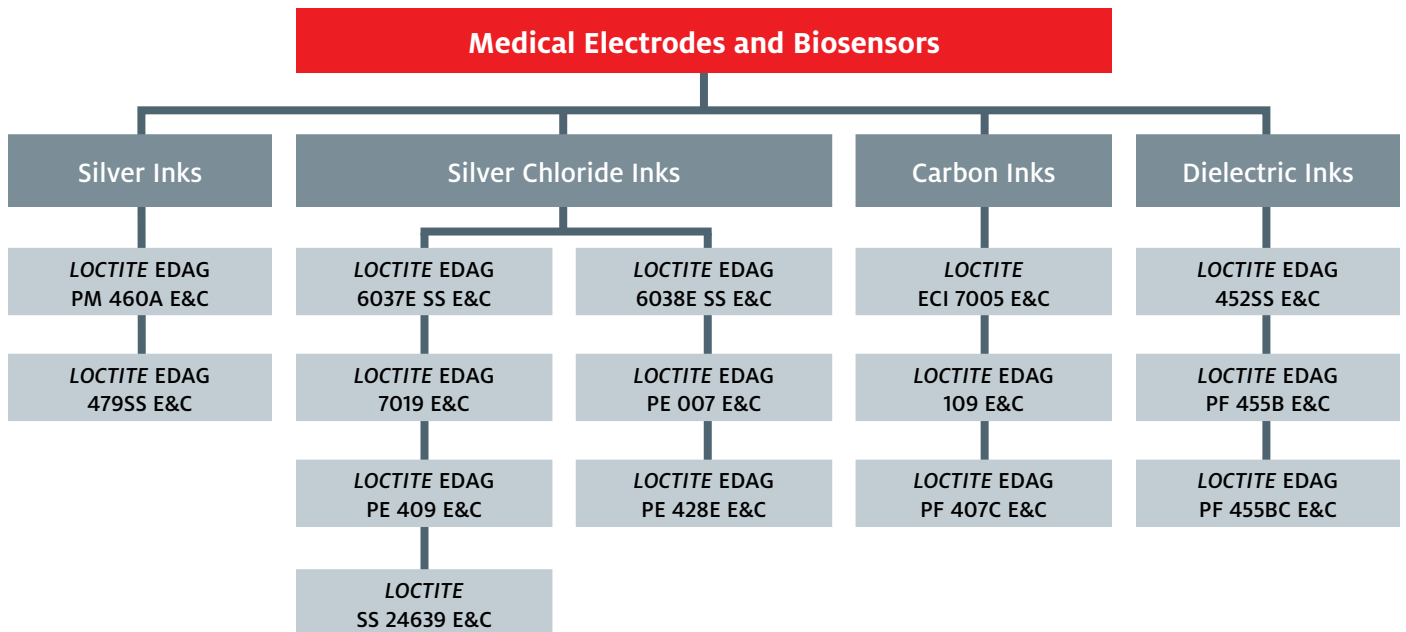

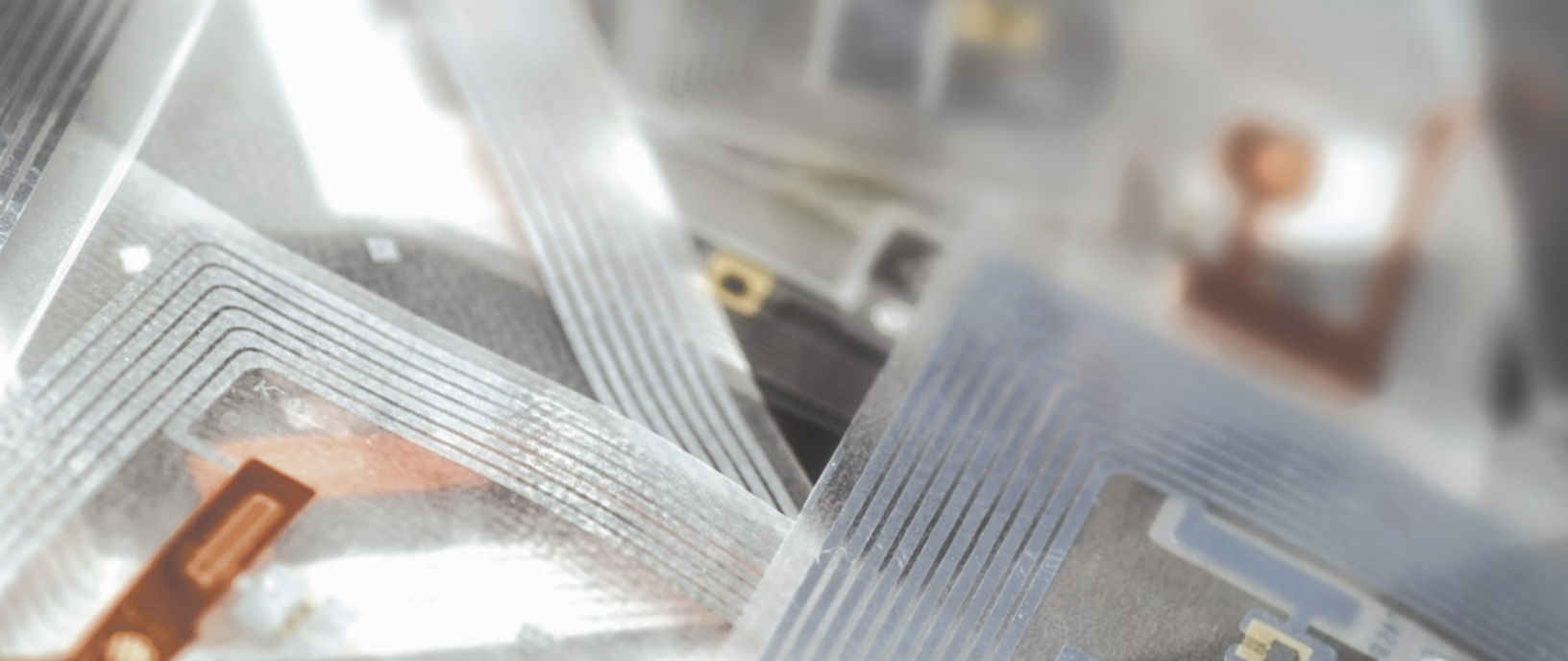

PHOTOVOLTAIC CELLS

Photovoltaic cells are used to convert solar energy to direct current electricity. With the increased push for sustainability and renewable energy, this market has high potential. Conductive inks can be used on flexible and rigid substrates for grid line applications in thin film and photovoltaics.

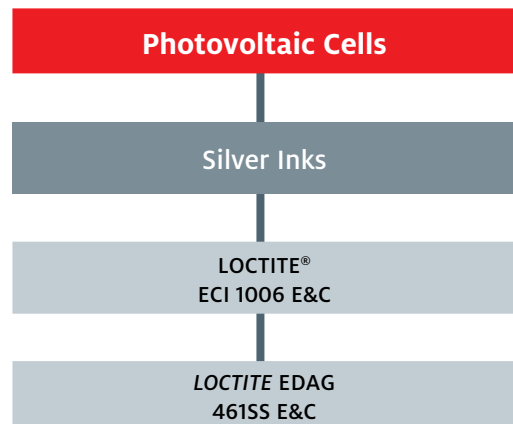



RFID AND SMARTCARDS

RFID technology is found in a variety of devices including SmartCards, passports, credit cards, various transportation payment systems and more. In addition to flexibility, adhesion and compatibility requirements, electronic inks used for RFID products have to be capable of transmitting and receiving specific radio frequencies. All of the elements within the ink system have to be formulated to interact effectively with RF fields and this requires materials that offer good permeability, surface roughness and low impedance. Henkel has a long and successful history developing inks for RFID devices and this knowledge base is enabling the next generation of these popular ID products.

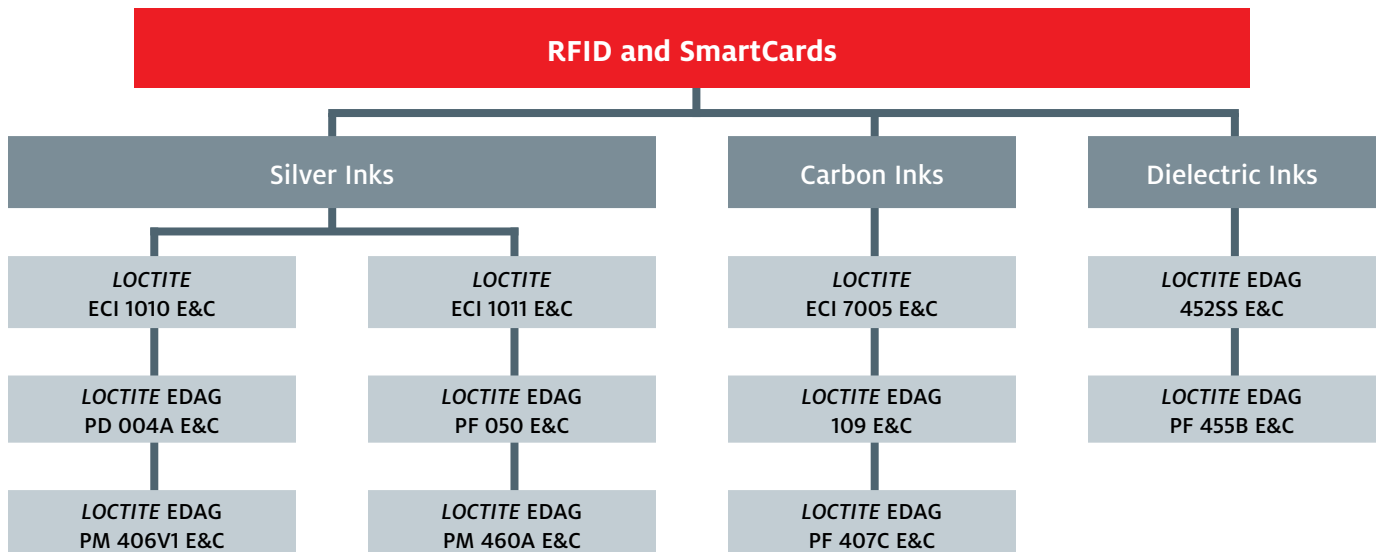



PRINTED RESISTORS, POTENTIOMETERS AND HEATING ELEMENTS

Using inks to print sensors has been a proven method of electronics printing for some time. Inks for printing sensors and resistors vary widely in resistance values and compositions and are used for a variety of applications from seat sensors for airbag deployment, to potentiometers for the automotive and consumer markets.

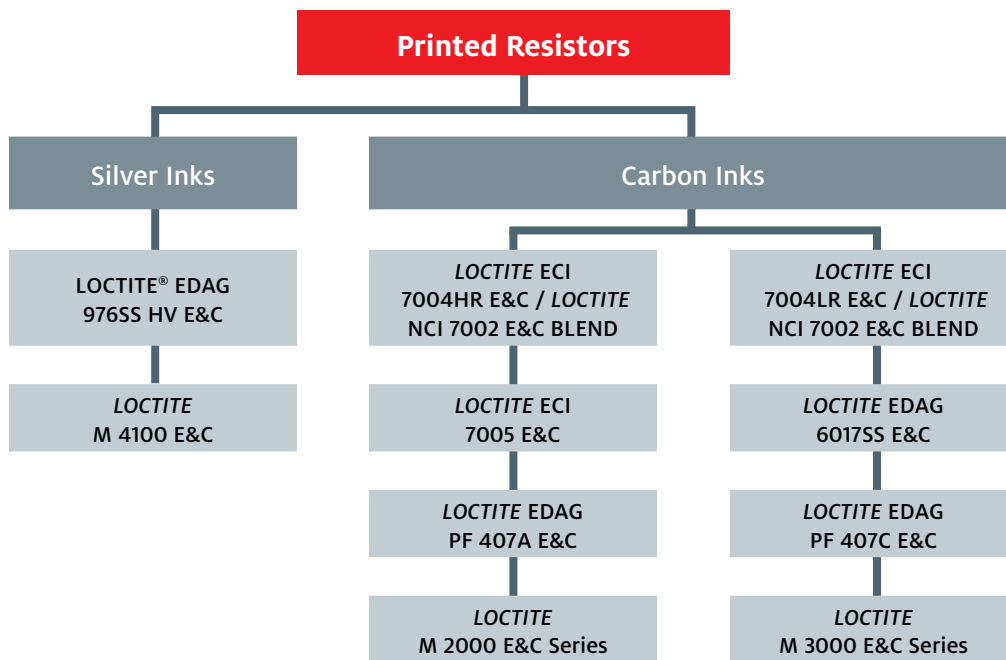

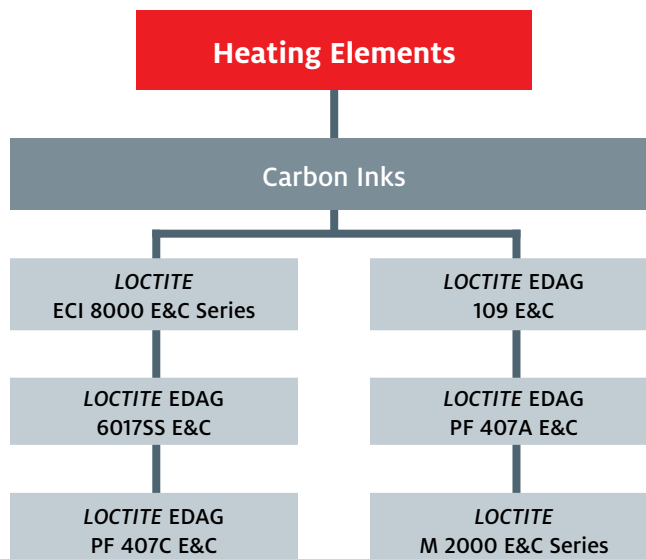
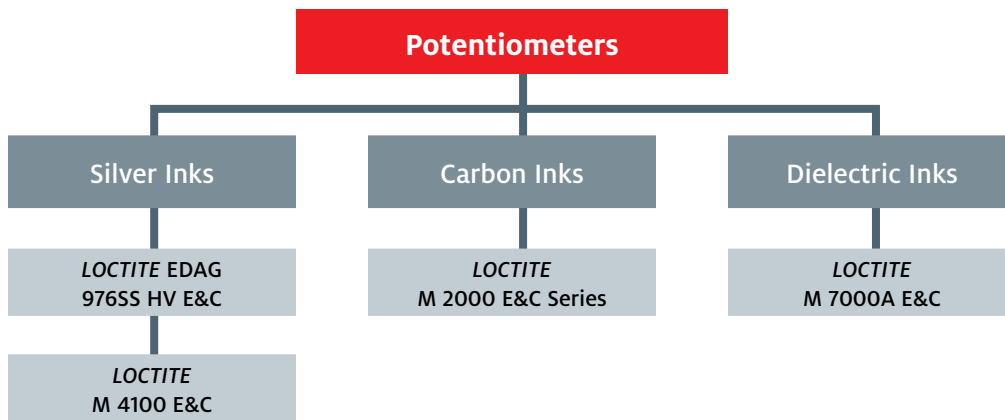

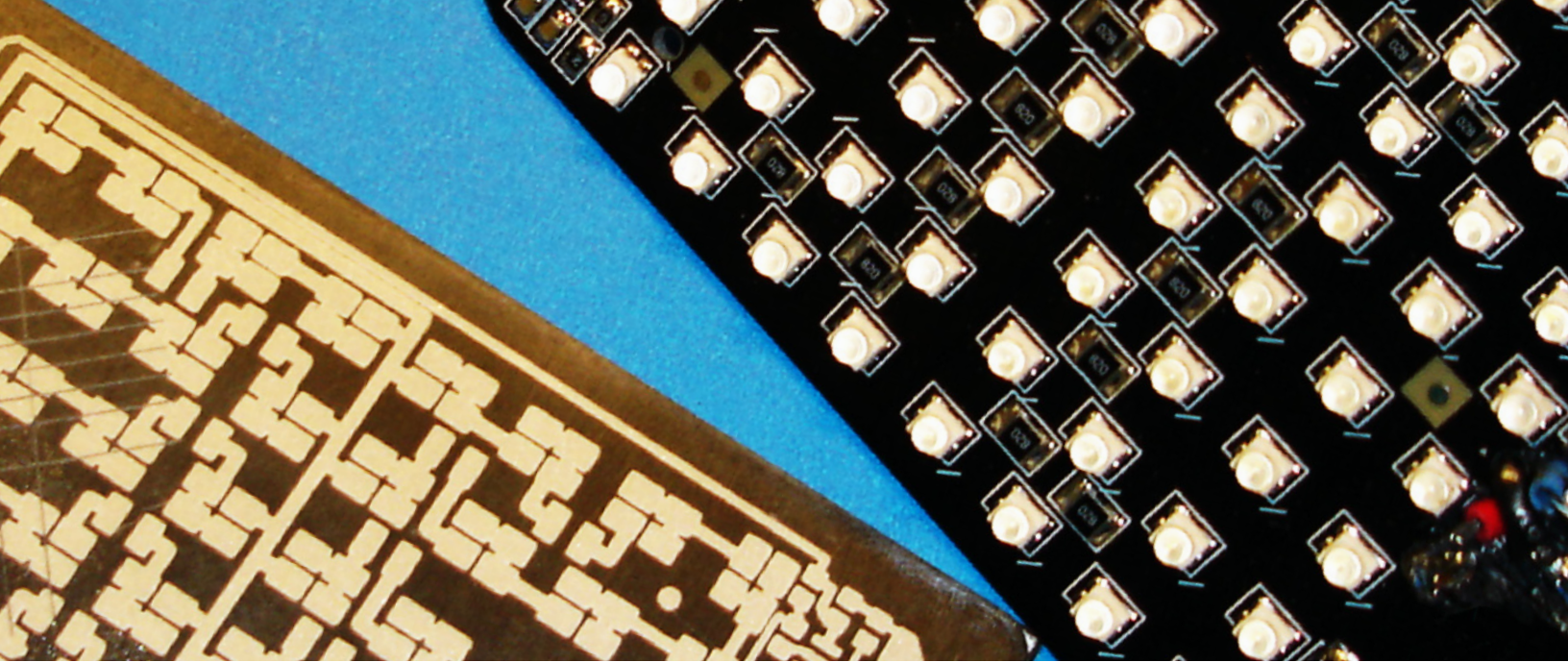

RIGID CIRCUITS

Inks are used on printed circuit boards as a way to maximize connections and functionality while minimizing space. Inks can be utilized as crossovers, copper contact protection, resistors, and through-hole connections on printed circuit boards and ceramics.

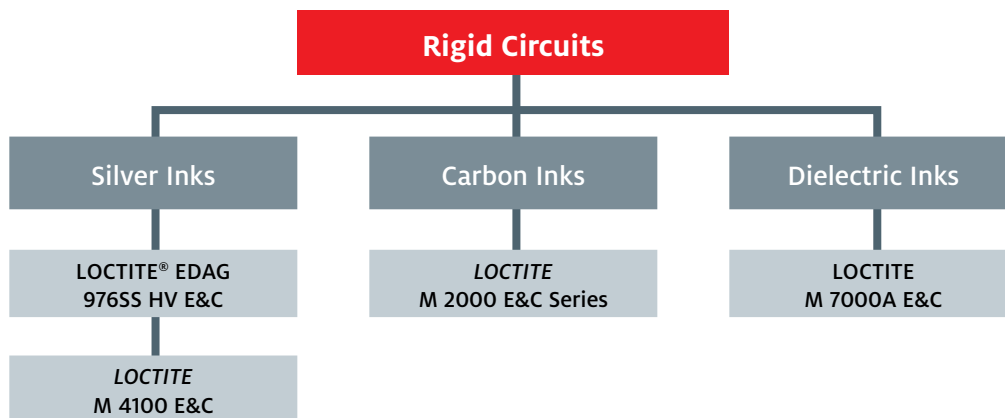



TOUCH SCREENS

Display technologies rely on many different printed solutions to help make the devices function properly and under very diverse conditions. Henkel has developed materials specifically for these applications including transparent conductors and protective top coats, printable dot spacers, UV dielectrics and fine line silver inks for busbar support. Henkel solutions provide an additive, adaptable and cost-effective alternative for many types of display devices. These inks, in combination with protective top layers, are delivering outstanding results for industrial touch screens as well as membrane touch switches, automotive touch screens, backlight switches, keyless entry devices, luminescent displays, printed LED lighting and shielding.

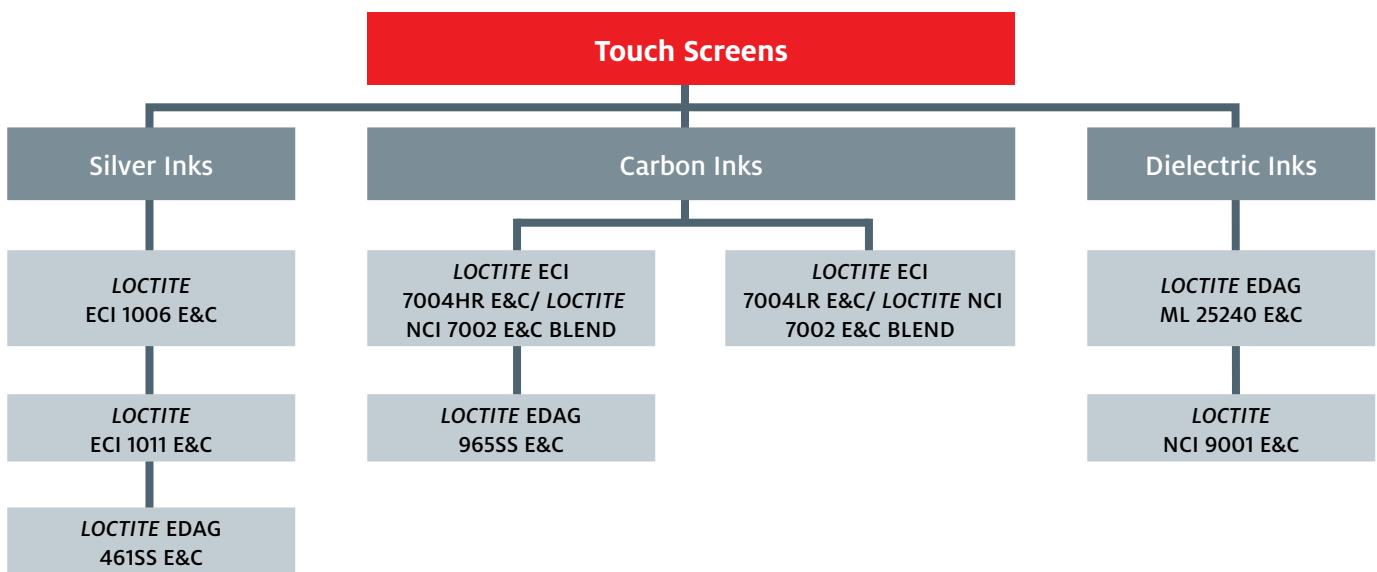

Henkel's printed electronics inks product portfolio includes silver, carbon, dielectric and specialty inks such as positive temperature coefficient (PTC), transparent conductive and silver plated copper (SPC) inks.

INKS PRODUCT PORTFOLIO

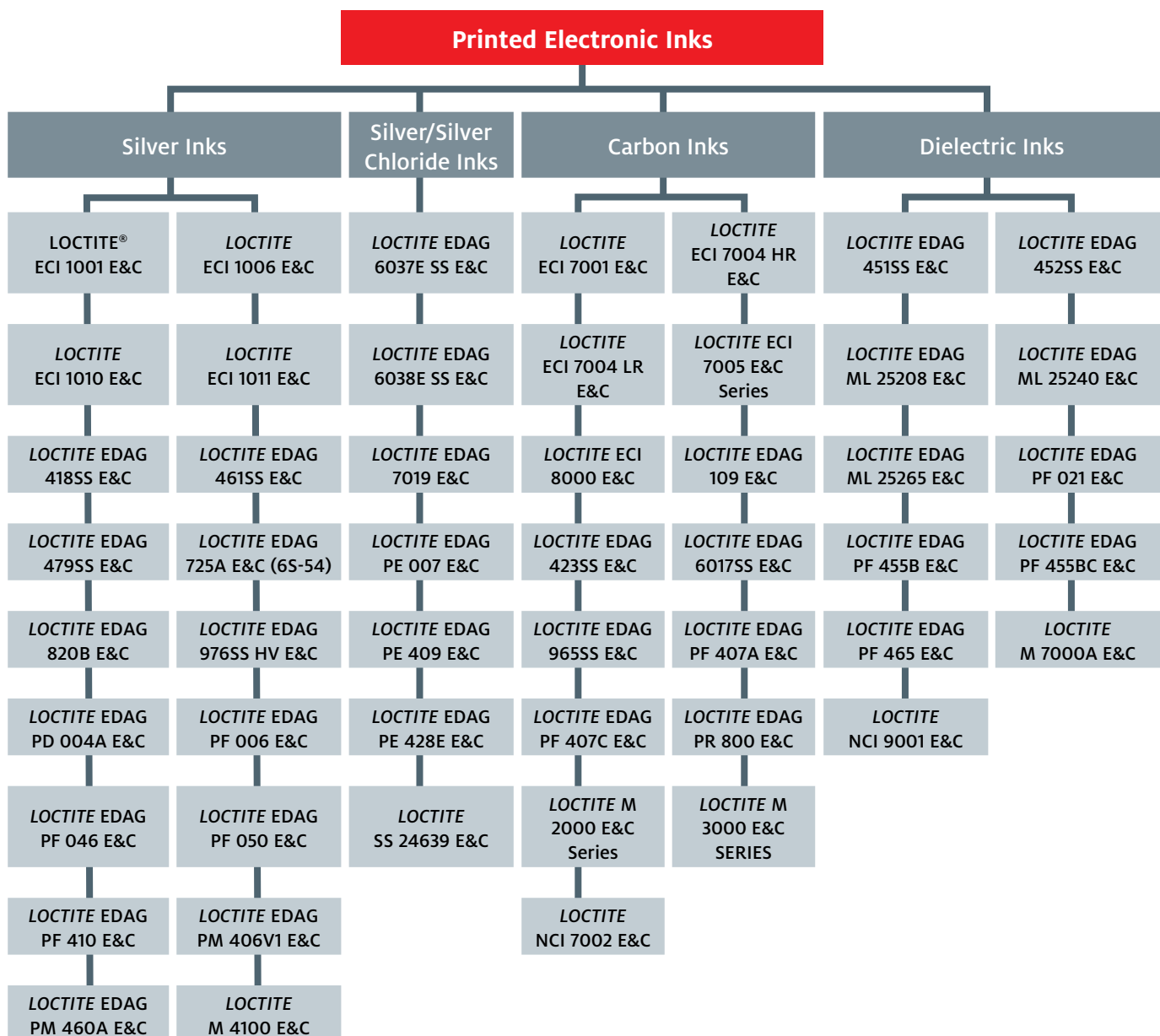

Ink Classifications

Utilizing different ink pigments, such as silver and carbon, Henkel materials experts have formulated robust carrier and resin systems to allow for outstanding ink performance within a variety of ink classifications.

Silver – Silver is the most electrically and thermally conductive of all metals and is used as the basis for many of Henkel’s conductive ink products. When combined with specific resin systems, Henkel silver inks can deliver better flexibility, crease resistance and longevity. These inks find uses in many different applications within numerous market sectors and are available in UV and solvent formulations.

Product Name	Application	Key Features	Flex	Rigid	Sheet Resistance ($\Omega/\text{sq}/25\ \mu\text{m}$)	Processing	Substrates	Cure
LOCTITE ECI 1001 E&C	<ul style="list-style-type: none"> Flexible circuits Membrane switches Keyboards 	<ul style="list-style-type: none"> Low cost ink Excellent balance of flexibility, hardness and adhesion 	X		< 0.030	Screenprint	Treated and untreated PET	10 min. at 120°C
LOCTITE ECI 1006 E&C	<ul style="list-style-type: none"> Busbar support for ITO films Digitizers Flexible circuits Membrane switches Photovoltaic Touch screens 	<ul style="list-style-type: none"> Halogen-free Excellent fine-line and high resolution — printability 50 μm lines and spaces attainable Excellent adhesion to sputtered ITO and PET Good electrical conductivity 	X		< 0.030	Screenprint	Treated and untreated PET, Kapton®, ITO film	10 min. at 130°C
LOCTITE ECI 1010 E&C	<ul style="list-style-type: none"> Flexible circuits RFID SmartCards 	<ul style="list-style-type: none"> Highly conductive with optimum mechanical performance Compatible with LOCTITE EDAG 440A E&C, LOCTITE EDAG 440B E&C and LOCTITE EDAG PF 455B E&C 	X		< 0.007	Screenprint	Treated and untreated PET, Kapton	10 min. at 120°C
LOCTITE ECI 1011 E&C	<ul style="list-style-type: none"> Flexible circuits RFID SmartCards 	<ul style="list-style-type: none"> Appearance of the coating is very smooth and shiny 	X		< 0.003	Screenprint, Flexographic	Treated and untreated PET, Kapton, ITO film	10 min. at 120°C
LOCTITE EDAG 418SS E&C	<ul style="list-style-type: none"> Flexible circuits 	<ul style="list-style-type: none"> Developed for solvent sensitive substrates like ABS and polycarbonate, but also a good choice for crossovers on UV dielectrics 	X		< 0.030	Screenprint, Flexographic	PC, PET, ABS	30 min. at 90°C
LOCTITE EDAG 461SS E&C	<ul style="list-style-type: none"> Flexible circuits Touch screens Photovoltaic cells flexible 	<ul style="list-style-type: none"> Halogen-free Good adhesion to sputtered ITO films and difficult to adhere to substrates Low temp cure for heat sensitive substrates 	X		< 0.020	Screenprint	Sputtered ITO, PET, ABS	30 min. at 71°C
LOCTITE EDAG 479SS E&C	<ul style="list-style-type: none"> Flexible circuits Keyboards Membrane switches Medical electrodes Biosensor 	<ul style="list-style-type: none"> Halogen-free Good flexibility 	X		< 0.020	Screenprint	Treated and untreated PET, Kapton, PEN, ABS, paper	15 min. at 93°C
LOCTITE EDAG 725A E&C (6S-54)	<ul style="list-style-type: none"> Flexible circuits Keyboards Membrane switches 	<ul style="list-style-type: none"> Excellent flexibility with good pencil hardness High conductivity Low viscosity 	X		< 0.014	Screenprint	Treated and untreated PET, Kapton, PEN, ABS, paper	10 min. at 120°C
LOCTITE EDAG 820B E&C	<ul style="list-style-type: none"> Flexible circuits Membrane keyboard printing 	<ul style="list-style-type: none"> Untreated substrates 	X		< 0.015	Screenprint	Treated and untreated polyester	20 min. at 120°C

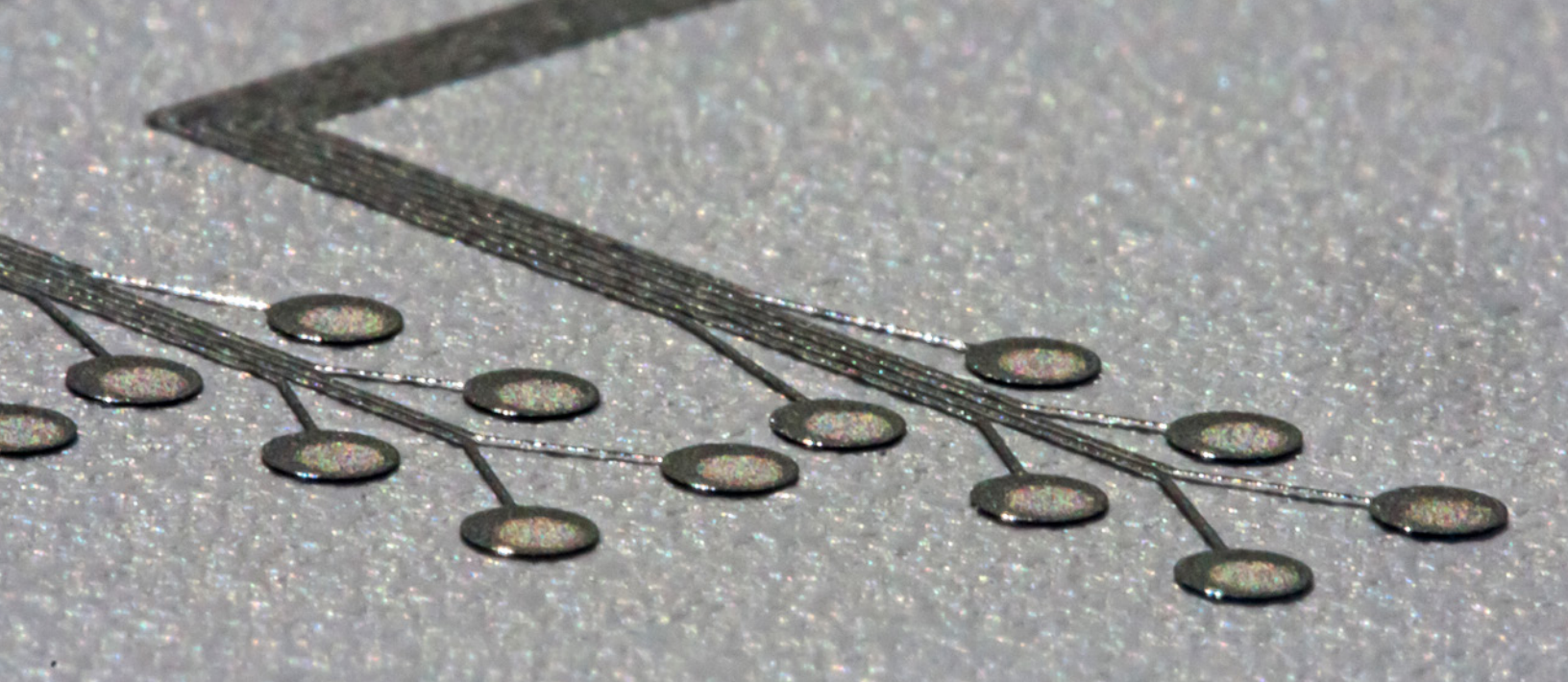

SILVER

Product Name	Application	Key Features	Flex	Rigid	Sheet Resistance ($\Omega/\text{sq}/25 \mu\text{m}$)	Processing	Substrates	Cure
LOCTITE® EDAG 976SS HV E&C	<ul style="list-style-type: none"> Potentiometers Printed resistors Rigid circuits 	<ul style="list-style-type: none"> Excellent adhesion on plain and copper laminated substrate Resistant to wave soldering Used in peelable solder masks Resistant to cleaning solvents commonly used in the printed circuit board industry 		X	< 0.025	Screenprint	Rigid printed circuit boards on substrates such as phenolic paper, epoxy paper, glass epoxy	30 min. at 160°C
LOCTITE EDAG PD 004A E&C	<ul style="list-style-type: none"> Flexible circuits Flexo high speed RFID SmartCards 	<ul style="list-style-type: none"> UV cure Low volatile organic compounds (VOC) Designed for solvent sensitive substrates 	X		< 0.100	Flexographic, Rotogravure	Treated and untreated PET, ABS, paper, polycarbonate	1.4 J/cm ² + 60 sec. at 150°C
LOCTITE EDAG PF 006 E&C	<ul style="list-style-type: none"> Flexible circuits 	<ul style="list-style-type: none"> Excellent flexibility and adhesion Very low silver migration 	X		< 0.020	Screenprint	Treated and untreated PET, ABS, paper	5 min. at 120°C
LOCTITE EDAG PF 046 E&C	<ul style="list-style-type: none"> Flexible circuits 	<ul style="list-style-type: none"> Outstanding flexibility High conductivity Excellent adhesion to the wide variety of substrates 	X		< 0.010	Screenprint	Treated and untreated PET, Kapton®, ITO film	5 min. at 120°C
LOCTITE EDAG PF 050 E&C	<ul style="list-style-type: none"> Flexible circuits RFID SmartCards 	<ul style="list-style-type: none"> Very high conductivity Developed for RFID with good line definition 	X		< 0.010	Screenprint	PET, ABS, PVC, paper	15 min. at 121°C
LOCTITE EDAG PF 410 E&C	<ul style="list-style-type: none"> Flexible circuits Keyboards Membrane switches 	<ul style="list-style-type: none"> Halogen-Free Good flexibility 	X		< 0.025	Screenprint	Treated and untreated PET, Kapton, PEN, ABS, paper	10 min. at 120°C
LOCTITE EDAG PM 406V1 E&C	<ul style="list-style-type: none"> RFID SmartCards 	<ul style="list-style-type: none"> High conductivity High solids content 	X		< 0.015	Screenprint	PET, PVC, paper	30 min. at 90°C
LOCTITE EDAG PM 460A E&C	<ul style="list-style-type: none"> Biosensors Flexo high speed Medical electrodes RFID SmartCards 	<ul style="list-style-type: none"> Can be applied to plastic or paper substrates Maintain low resistance even after heat exposure, cold and humid conditions 	X		< 0.010	Flexographic, Rotogravure	Plastics, paper	15 min. at 70°C
LOCTITE M 4100 E&C	<ul style="list-style-type: none"> Rigid circuits Potentiometers Printed resistors 	<ul style="list-style-type: none"> Untreated substrates 		X	< 0.040	Screenprint	FR-4, ceramic, Kapton	20 min. at 200°C



Silver/silver chloride – Silver/silver chloride ink formulations provide excellent conductivity and allow interaction with organic interface gels to measure electronic signals on the human body for medical applications.

Product Name	Application	Key Features	Flex	Rigid	Sheet Resistance ($\Omega/\text{sq}/25 \mu\text{m}$)	Processing	Substrates	Cure
LOCTITE EDAG 6037E SS E&C	<ul style="list-style-type: none"> Medical electrodes Biosensors 	<ul style="list-style-type: none"> Silver/silver chloride ratio 3:2 Blend with LOCTITE EDAG 6038E SS E&C 	X		< 0.12	Screenprint	Polyester, paper	15 min. at 120°C.
LOCTITE EDAG 6038E SS E&C	<ul style="list-style-type: none"> Medical electrodes Biosensors 	<ul style="list-style-type: none"> Silver/silver chloride ratio 9:1 Blend with LOCTITE EDAG 6038E SS E&C 	X		< 0.04	Screenprint	Polyester, paper	15 min. at 120°C
LOCTITE EDAG 7019 E&C	<ul style="list-style-type: none"> Medical electrodes Biosensors 	<ul style="list-style-type: none"> Excellent adhesion Silver/silver chloride ratio 4:1 	X		< 0.05	Screenprint	Polyester, paper, ABS, PVC	10 min. at 107°C
LOCTITE EDAG PE 007 E&C	<ul style="list-style-type: none"> Medical electrodes Biosensors 	<ul style="list-style-type: none"> Compatible with LOCTITE EDAG silver and carbon inks Meets ANSI/AAMI standards for pre-gelled ECG disposable electrodes 	X		< 0.10	Rotogravure	Polyester, paper	2 min. at 107°C
LOCTITE EDAG PE 409 E&C	<ul style="list-style-type: none"> Medical electrodes Biosensors 	<ul style="list-style-type: none"> Silver/silver chloride ratio of 9:1 	X		< 0.05	Screenprint, Rotary screen	Polyester	15 min. at 120°C
LOCTITE EDAG PE 428E E&C	<ul style="list-style-type: none"> Medical electrodes Biosensors 	<ul style="list-style-type: none"> Meets ANSI/AAMI standards for pre-gelled ECG disposable electrodes (when used with appropriate gel) 	X		< 0.17	Flexographic, Rotogravure	Polyester, paper	15 min. at 70°C
LOCTITE SS 24639 E&C	<ul style="list-style-type: none"> Medical electrodes Biosensors 	<ul style="list-style-type: none"> Compatible with LOCTITE EDAG silver and carbon inks Meets ANSI/AAMI standards for pre-gelled ECG disposable electrodes 	X		< 0.15	Flexographic, Rotogravure	Polyester, paper	5 min. at 121°C

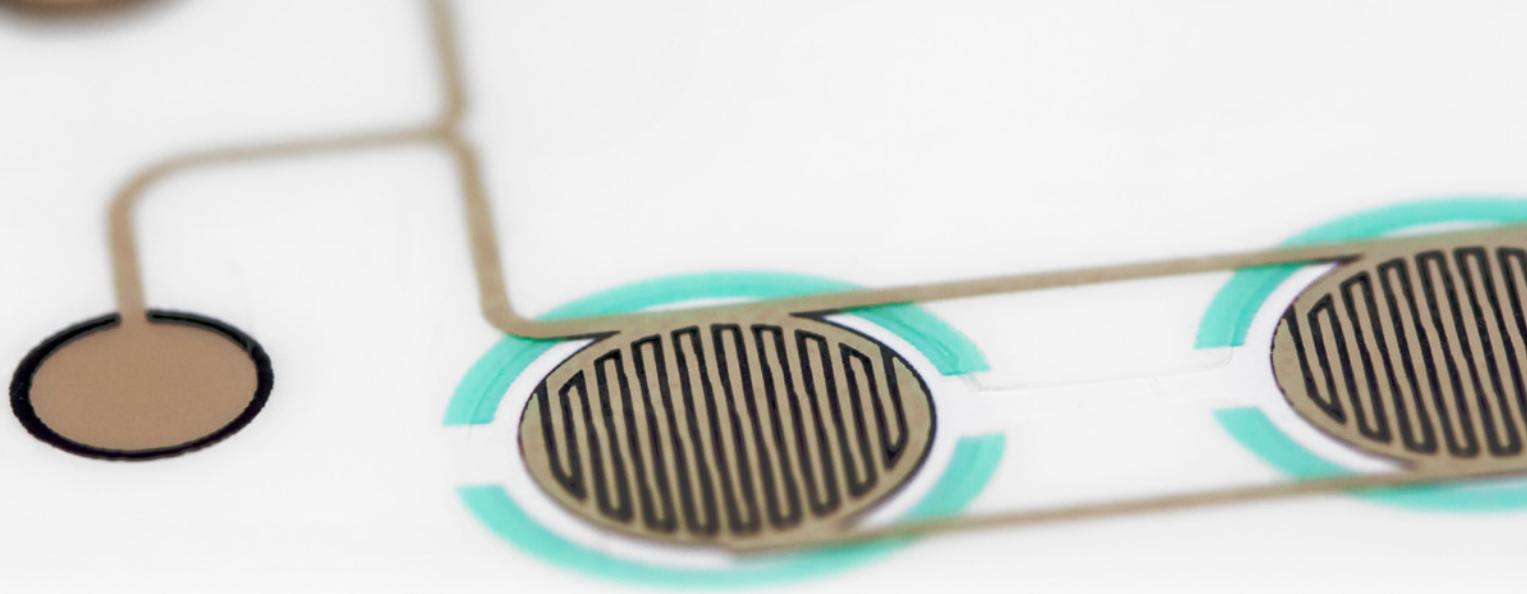

Carbon – Carbon inks typically complement silver inks, providing lubricity, protection of the silver surface and prevention of silver migration. When functional resistance is required, carbon inks offer excellent performance. Henkel's portfolio includes products for a variety of PET films, paper substrates, membrane switches and rigid printed circuit boards.

Product Name	Application	Key Features	Flex	Rigid	Sheet Resistance ($\Omega/\text{sq}/25 \mu\text{m}$)	Processing	Substrates	Cure
LOCTITE® ECI 7001 E&C	• Printable batteries	• Used for printable batteries applied on flexible substrates • Highly conductive	X		< 10	Screenprint, Rotary screen	Treated and untreated polyester, PEN, paper	10 min. at 120°C
LOCTITE ECI 7004HR E&C	• Force-sensitive modules • Printed resistors and sensing devices	• Force sensitive ink responds to increased force with decreased resistance • Blend with LOCTITE NCI 7002 E&C • Suitable for slow responsive sensitivity profiles	X		5,000 – 500,000	Screenprint	Treated polyester and polyimide	5 to 10 min. at 120°C
LOCTITE ECI 7004LR E&C	• Force-sensitive modules • Printed resistors and sensing devices	• Force sensitive ink responds to increased force with decreased resistance • Blend with LOCTITE NCI 7002 E&C • Suitable for fast responsive sensitivity profiles	X		50 – 5,000	Screenprint	Treated polyester and polyimide	5 to 10 min. at 120°C
LOCTITE ECI 7005	• Flexible circuits • Flexo high speed • Biosensors • RFID • Printed resistors	• Water based • High speed printing	X		< 40	Flexographic, Rotogravure	PET, plastics, paper	2 min. at 120°C
LOCTITE ECI 8000 E&C Series	• Heating elements	• Positive Temperature Coefficient (PTC) printable ink • Self regulating heater	X		1,700	Screenprint	Polyester, PEN, Kapton®	10 min. at 120°C
LOCTITE EDAG 109 E&C	• Flexible circuits • Biosensors • RFID • Heating elements • Flexo high speed	• High speed printing	X		< 30	Flexographic, Rotogravure	Polyester, paper	15 to 30 min. at 70°C to 80°C
LOCTITE EDAG 423SS E&C	• Flexible circuits	• Excellent adhesion • Stable electrical resistance • Excellent environmental stability	X		< 25	Screenprint	Treated and untreated polyester, PEN,	5 min. at 120°C

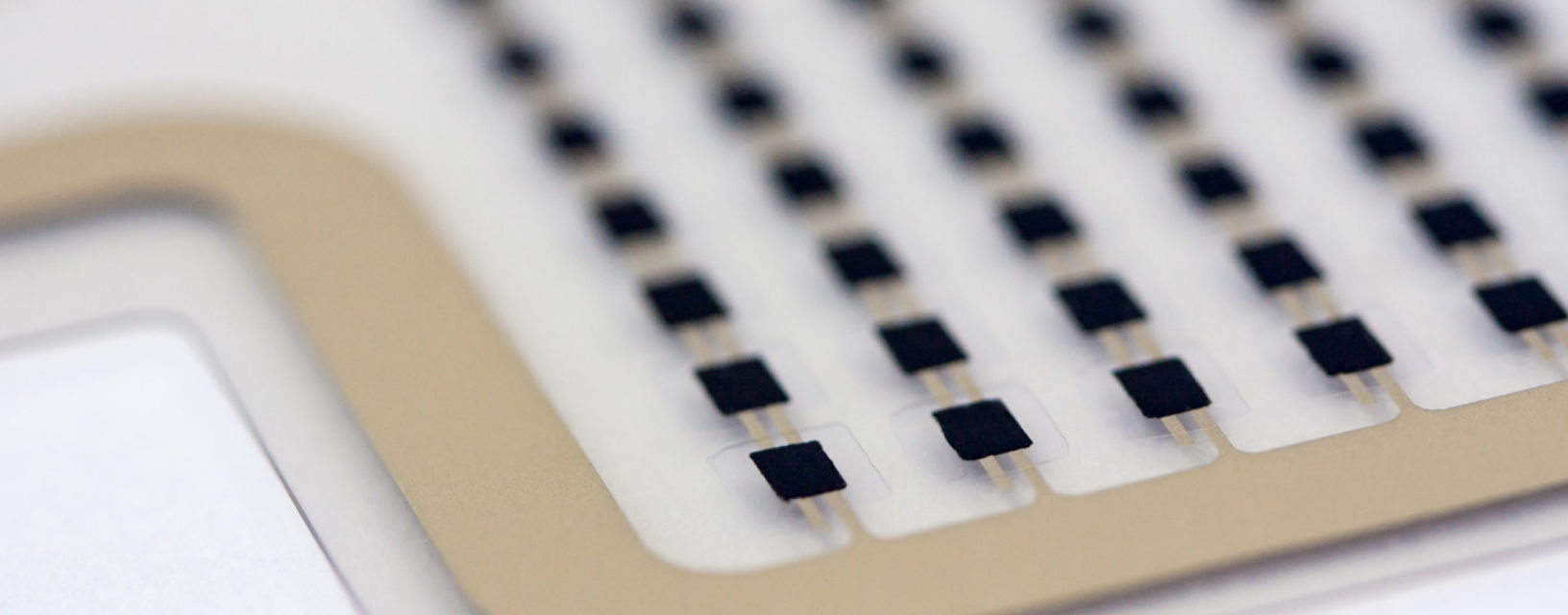

CARBON

Product Name	Application	Key Features	Flex	Rigid	Sheet Resistance ($\Omega/\text{sq}/25 \mu\text{m}$)	Processing	Substrates	Cure
LOCTITE EDAG 6017SS E&C	<ul style="list-style-type: none"> Heating elements Printed resistors 	<ul style="list-style-type: none"> Blend with LOCTITE EDAG PM 404 Good for low voltage circuitry 	X		50 – 3,800	Screenprint	Treated and untreated polyester, Paper	10 min. at 100°C
LOCTITE EDAG 965SS E&C	<ul style="list-style-type: none"> Flexible circuits Touch screens 	<ul style="list-style-type: none"> Good for low voltage circuitry to protect silver pads and tracks from chemical attack and silver migration 	X		< 60	Screenprint	Treated and untreated polyester, ITO film	15 min. at 120°C
LOCTITE EDAG PF 407A E&C	<ul style="list-style-type: none"> Flexible circuits Printed resistors Heating elements 	<ul style="list-style-type: none"> Good screen residence time Flexible low temperature drying cycle Very good adhesion 	X		< 20	Screenprint	Treated and untreated polyester, polycarbonate, paper, cardboard	15 min. at 120°C
LOCTITE EDAG PF 407C E&C	<ul style="list-style-type: none"> Flexible circuit Printed resistors Heating elements Medical biosensors 	<ul style="list-style-type: none"> Highly conductive Good for low voltage circuitry 	X		< 15	Screenprint	Treated and untreated polyester, PEN, paper	5 min. at 120°C
LOCTITE EDAG PR 800 E&C	<ul style="list-style-type: none"> Heating elements Potentiometers Printed resistors Rigid circuits 	<ul style="list-style-type: none"> Resistant to high abrasion Excellent resistance to heat and humidity Organic solvent resistant 		X	< 15	Screenprint	FR-4, FR-3, CEM-1, CEM-3, PEN, ceramic, metals	30 min. at 150°C
LOCTITE M 2000 E&C Series	<ul style="list-style-type: none"> Heating elements Potentiometers Printed resistors Rigid circuits 	<ul style="list-style-type: none"> Eliminates soldering of discrete components Excellent wear resistance Can be trimmed via laser (linearity of 1%) 		X	1 to 75,000	Screenprint	FR-4, FR-3, CEM-1, CEM-3, PEN, ceramic	30 min. at 200°C
LOCTITE M 3000 E&C Series	<ul style="list-style-type: none"> Printed resistors Flexible circuit 	<ul style="list-style-type: none"> Blended for a custom fixed resistor One component for easy processing Excellent screenprint performance 	X		10,000 to 100,000	Screenprint	Polyester, polyimide	30 min. at 120°C
LOCTITE NCI 7002 E&C	<ul style="list-style-type: none"> Force-sensitive modules Printed resistors and sensing devices Heating elements 	<ul style="list-style-type: none"> Non-conductive Blend with LOCTITE ECI 7004HR E&C or LOCTITE ECI 7004LR E&C Good adhesion 	X		> 360,000	Screenprint	Treated polyester and polyimide	5 to 10 min. at 120°C

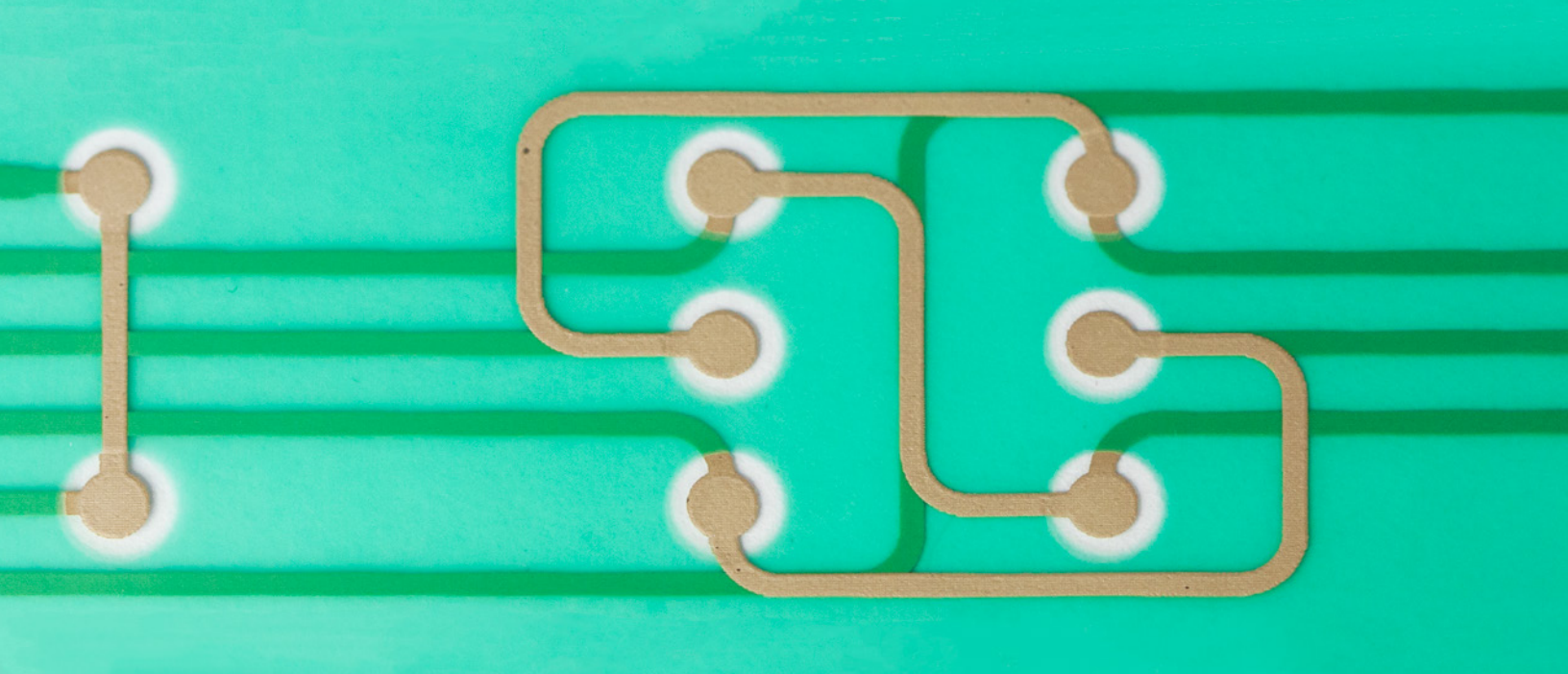

Dielectric – Non-conductive, dielectric inks insulate multilayer circuitry to allow for circuitry crossover and multilayer applications. These materials offer excellent flexibility, humidity resistance and additional protection for improved strength and performance for multiple applications including keyboards, copper-etched circuitry and hybrid circuits.

Product Name	Application	Key Features	Flex	Rigid	Processing	Substrates	Cure
LOCTITE® EDAG 451SS E&C	<ul style="list-style-type: none"> • Flexible circuits • Flexo high speed 	<ul style="list-style-type: none"> • UV cure • Smooth film • Compatible with LOCTITE EDAG silver and carbon inks 	X		Screenprint, Flexographic	Untreated and print receptive polyester and polycarbonate film	0.3 to 0.7 J/cm ²
LOCTITE EDAG 452SS E&C	<ul style="list-style-type: none"> • Flexible circuits • RFID • Medical electrodes • Biosensors 	<ul style="list-style-type: none"> • Excellent printability • Excellent flexibility • Excellent adhesion • UV cure 	X		Screenprint	Untreated polyester and polycarbonate film	0.5 J/cm ²
LOCTITE EDAG ML 25208 E&C	<ul style="list-style-type: none"> • Flexible circuits 	<ul style="list-style-type: none"> • Translucent • Excellent printability • UV cure • Excellent adhesion • Excellent flexibility 	X		Screenprint	Untreated and print receptive polyester and polycarbonate film	0.5 J/cm ²
LOCTITE EDAG ML 25240 E&C	<ul style="list-style-type: none"> • Touch screens • Flexible circuits 	<ul style="list-style-type: none"> • Insulating • UV cure • Excellent adhesion • High peel strength in high temperature and humidity 	X		Screenprint	Flexible copper circuits, ITO sputtered polyester film, metals and glass	0.3 to 0.6 J/cm ²
LOCTITE EDAG ML 25265 E&C	<ul style="list-style-type: none"> • Flexible circuits 	<ul style="list-style-type: none"> • Translucent • Insulating • UV cure • Excellent adhesion • High peel strength in high temperature and humidity 	X		Screenprint	ITO sputtered polyester film, metals and glass	0.3 to 0.6 J/cm ²
LOCTITE EDAG PF 021 E&C	<ul style="list-style-type: none"> • Flexible circuits • Surface mounting 	<ul style="list-style-type: none"> • Translucent • UV cure • Prevents silver migration • LED glob top • Dot dispensable 	X	X	Screenprint, Dispense	Polyester, polycarbonate film and FR-4	0.4 to 1.0 J/cm ²



DIELECTRIC

Product Name	Application	Key Features	Flex	Rigid	Processing	Substrates	Cure
LOCTITE EDAG PF 455B E&C	<ul style="list-style-type: none"> Flexible circuits RFID Medical electrodes Biosensors 	<ul style="list-style-type: none"> Excellent humidity resistance Excellent printability Excellent adhesion Good dielectric strength UV cure 	X		Screenprint	Treated and untreated polyester film	80 W/cm ²
LOCTITE EDAG PF 455BC E&C	<ul style="list-style-type: none"> Flexible circuits RFID Medical electrodes Biosensors 	<ul style="list-style-type: none"> Translucent Excellent humidity resistance Compatible with LOCTITE EDAG conductive inks UV cure 	X		Screenprint	Treated and untreated polyester foil	80 W/cm ²
LOCTITE EDAG PF 465 E&C	<ul style="list-style-type: none"> Flexible circuits 	<ul style="list-style-type: none"> Translucent blue Excellent printability UV cure Excellent flexibility Good dielectric strength Compatible with other LOCTITE EDAG conductive polymer thick film inks 	X		Screenprint	Untreated and print receptive polyester and polycarbonate film	80 W/cm ²
LOCTITE M 7000A E&C	<ul style="list-style-type: none"> Rigid circuits Potentiometer 	<ul style="list-style-type: none"> One component Insulating High resistance to heat and humidity 		X	Screenprint	Printed circuit boards, copper, ceramic	25 min. at 165°C
LOCTITE NCI 9001 E&C	<ul style="list-style-type: none"> Touch screens Flexible circuits 	<ul style="list-style-type: none"> Minimal dielectric strength Excellent flexibility Resistant to abrasion Primer coat for difficult to adhere to substrate 	X		Screenprint, Flexographic	Flexible copper circuits, ITO sputtered polyester film, metals and glass	5 min. at 130°C



EMI SHIELDING COATINGS

Minimizing electromagnetic interference (EMI) is an important design criteria that needs to be addressed during the development of any new electronic device, especially if the device is going to be housed in a plastic enclosure. Conductive coatings have been used successfully as a method of EMI shielding for over 25 years and are common throughout the electronic industry. Henkel offers a wide range of shielding coatings: nickel coatings offer unique performance benefits, while silver plated copper and silver formulations are for applications where the highest levels of shielding are required.

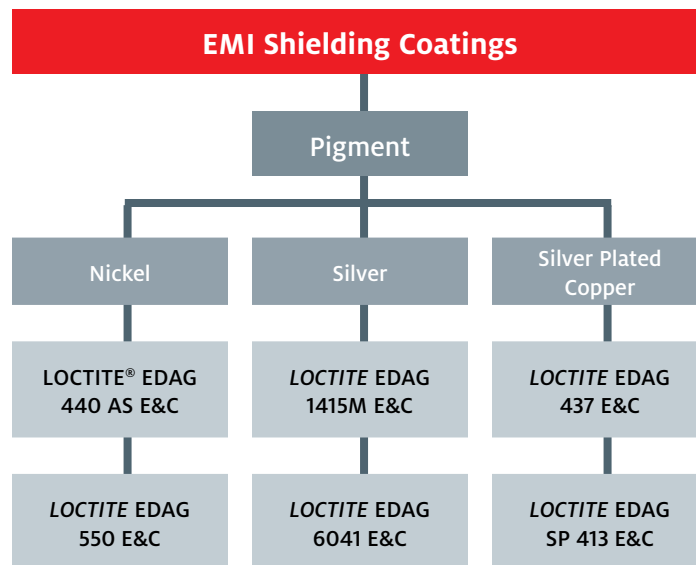



EMI SHIELDING COATINGS

Product Name	Pigment	Key Features	Flex	Rigid	Attenuation	Sheet Resistance ($\Omega/\text{sq}/25 \mu\text{m}$)	Substrates	Cure
LOCTITE EDAG 440 AS E&C	Nickel	<ul style="list-style-type: none"> Excellent shielding against radiated electromagnetic interference (EMI) Protection against electrostatic discharge (ESD) Stable in difficult environmental conditions such as high humidity or heat 		X	50 – 70 dB at 50 μm	< 0.50	Plastic	20 min. at 70°C
LOCTITE EDAG 550 E&C	Nickel	<ul style="list-style-type: none"> Extremely conductive and stable nickel acrylic lacquer coating Provides excellent long-term shielding protection against radiated EMI UL recognized coating Can be overcoated by decorative top coatings with minimum affect on the shielding properties 		X	60 – 65 dB at 50 μm	< 0.9	Plastic	30 min. at 70°C
LOCTITE EDAG 1415M E&C	Silver	<ul style="list-style-type: none"> Excellent shielding against radiated electromagnetic interference (EMI) Maintains low resistance after exposure to heat, cold, humidity and salt spray Air drying system that requires no primer or top coat 		X	60 dB at 25 μm	< 0.015	Plastic	30 min. at 70°C
LOCTITE EDAG 6041 E&C	Silver	<ul style="list-style-type: none"> Cure hot air drying and heat cure Dry rapidly to form a flexible conductive coating 		X	N/A	< 0.1	Plastic, phenolic paper, epoxy paper, glass epoxy	30 min. at 150°C
LOCTITE EDAG 437 E&C	Silver Plated Copper	<ul style="list-style-type: none"> Excellent shielding against radiated electromagnetic interference (EMI) and protection against electrostatic discharge (ESD) 		X	50 – 70 dB at 50 μm	< 0.5	Plastic	30 min. at 25°C
LOCTITE EDAG SP 413 E&C	Silver Plated Copper	<ul style="list-style-type: none"> Excellent shielding against radiated electromagnetic interference (EMI) at low coating thicknesses 		X	70 – 80 dB at 15 μm	< 0.015	Plastic	30 min. at 70°C



AMERICAS

UNITED STATES

Henkel Corporation
14000 Jamboree Road
Irvine, CA 92606
United States
Tel: +1.888.943.6535
Fax: +1.714.368.2265

Henkel Corporation
20021 Susana Road
Rancho Dominguez, CA 90221
United States
Tel: +1.310.764.4600
Fax: +1.310.605.2274

Henkel Corporation
18930 W. 78th Street
Chanhassen, MN 55317
United States
Tel: +1.952.835.2322
Tel: +1.800.347.4572
Fax: +1.952.835.0430

BRAZIL

Henkel Brazil
Av. Prof. Vernon Kriebler, 91
06690-070 Itapevi, Sao Paulo
Brazil
Tel: +55.11.3205.7001
Fax: +55.11.3205.7100

ASIA-PACIFIC

CHINA

Henkel Management Center
Building 7, No. 99 Jiang Wan Cheng Road
Shanghai 200438,
China
Tel: +86.21.2891.8999
Fax: +86.21.2891.8952

ABLESTIK (Shanghai) LIMITED
No. 332 Meigui South Road
WaiGaoQiao Free Trade Zone, Pu Dong
Shanghai 200131,
China
Tel: +86.21.2702.5888
Fax: +86.21.5048.4169

JAPAN

Henkel Japan Ltd.
27-7, Shin Isogo-cho
Isogo-ku Yokohama, 235-0017
Japan
Tel: +81.45.286.0161
Email: jp.ae-csdesk@henkel.com

KOREA

Henkel Korea Co Ltd.
18th Floor of tower B, BYC High City Bldg
Gasam Digital 1-ro, Geumcheon-gu,
Seoul, 08506
South Korea
Tel: +82.2.6150.3000
Fax: +82.2.6947.5203

SINGAPORE

Henkel Singapore Pte Ltd.
401, Commonwealth Drive
#03-01/02 Haw Par Technocentre,
Singapore 149598
Tel: +65.6266.0100
Fax: +65.6472.8738 / +65.6266.1161

TAIWAN

Henkel Taiwan Ltd.
10F, No. 866, Zhongzheng Road,
Zhonghe District, New Taipei City, 23586
Taiwan
Tel: +866.2.2227.1988
Fax: +866.2.2226.8699

EUROPE

BELGIUM

Henkel Belgium N.V.
Nijverheidsstraat 7
B-2260 Westerlo
Belgium
Tel: +32.1457.5611
Fax: +32.1458.5530

UNITED KINGDOM

Henkel Ltd.
Adhesives Limited Technologies House
Wood Lane End
Hemel Hempstead
Hertfordshire HP2 4RQ
United Kingdom
Tel: +44.1442.278000
Fax: +44.1442.278071

Across the Board, 

henkel-adhesives.com/electronics