

MEMORY HiLOGGER 8423

Data Logger

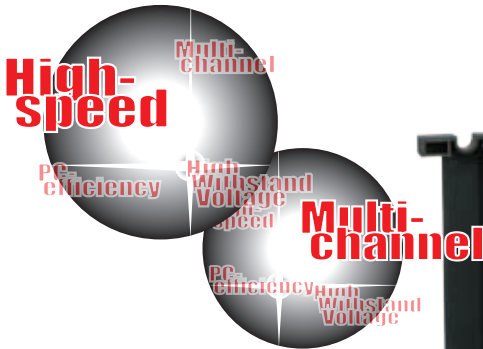

Fast 10-ms Sampling Up to 600 Channels Data Logging

MEMORY HiLOGGER Model 8423 is a data acquisition system capable of measuring and recording multiple channels at high speed. Acquired data can be easily analyzed on a personal computer. This model is ideal for acquiring data for evaluation and testing at development sites. If your evaluation needs require faster data sampling than was available with former HIOKI MEMORY HiLOGGERS, or if you just need more measurement channels, this model has the capabilities you want.



ISO 9001
JMI-0216



ISO14001
JQA-E-90091



www.hioki.com

HIOKI company overview, new products, environmental considerations and other information are available on our website.

Who needs 10 ms high-speed sampling?

High-Speed

Multi-channel

PC efficiency

High Withstand Voltage

- Answer -

To acquire data when converting automobile electronics for electric or hybrid vehicles

- Fastest measurement interval (sampling interval) is 10 ms
- Acquires up to 600 channels of data with 10 ms sampling interval
- Insulation withstand voltage between the measurement channels in each module is 200 V (Model 8948)

In the development of electric and hybrid automobiles, the need to capture sudden swings in various loads requires a measurement instrument with multi-channel high-speed sampling capability. For this purpose, HIOKI has developed a very economical logger that can measure with

10-ms sampling interval on all channels. Also included is a dual-sampling function that can measure at two different sampling rates simultaneously. This new model can follow waveforms that former 100-ms-sampling instruments could not.

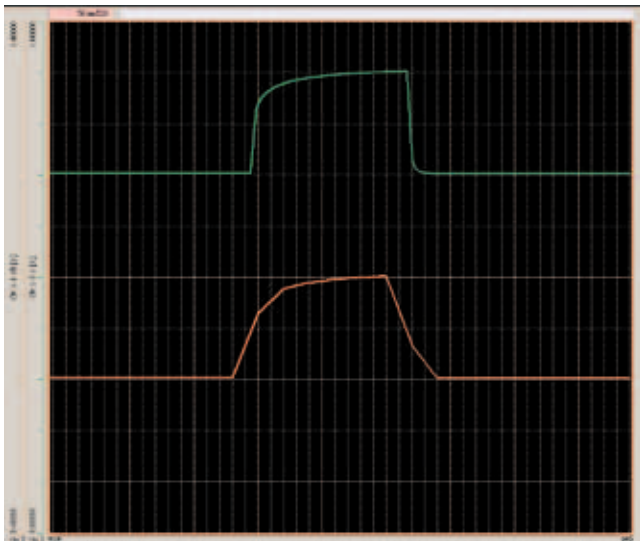

Sudden-load-change testing of a fuel cell employs dual sampling to measure with 10-ms (upper trace) and 100-ms sampling (lower trace). (Timebase: 50 ms/div).

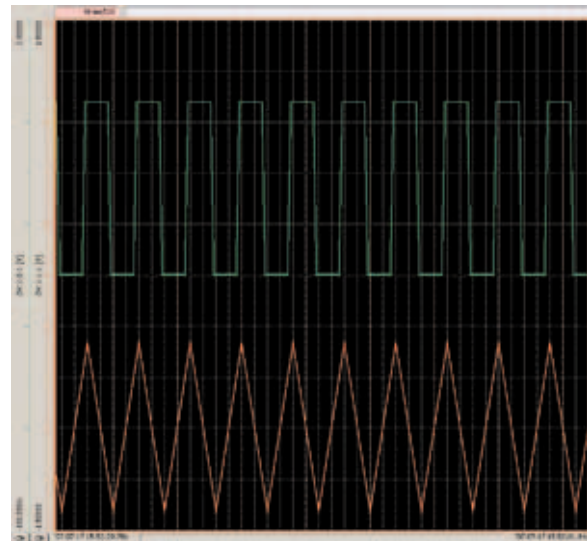

A 5-Hz pulse waveform is measured using dual sampling: 10-ms (upper trace) and 100-ms sampling (lower trace) (Timebase: 50 ms/div).

Who needs 120 or 600 channels?



High-Speed
 Multi-channel
 PC efficiency
 High Withstand Voltage

- Answer -

To acquire multi-point temperature distribution data To measure the voltage of each cell in a stack

- Expandable up to 120 channels with a single instrument
- Up to five instruments can be connected for measuring up to 600 channels
- Isolated to sustain up to 600 V between modules and earth

Temperature distribution is measured to evaluate air conditioning systems during development. A system to acquire data on up to 600 channels can be constructed with merely a LAN or USB connection, providing highly detailed temperature distribution measurements.

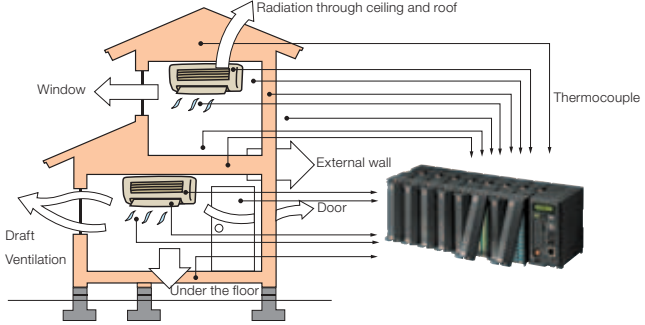

With all channels isolated and a 600V AC/DC maximum rated voltage to earth, even when the common mode voltage increases as is common with layered batteries, the voltage of each individual battery cell can be safely measured.

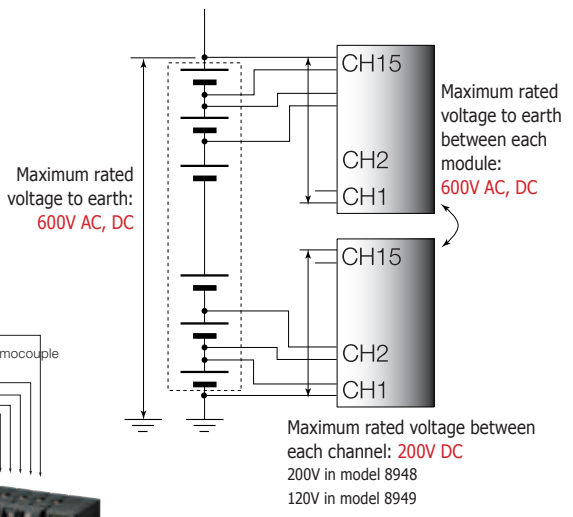

To evaluate heat radiation characteristics and copy machine operation, temperatures at many points inside the chassis and analog voltages from the control board are simultaneously measured.

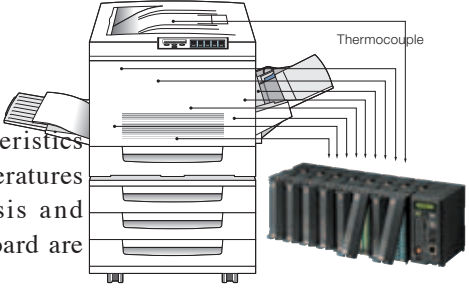

“Simplicity” as a Design Concept



Installation

Because the terminal blocks are designed to be removable, thermocouples can be connected to the terminal block in hand before connecting the block to a HiLOGGER input module, with just one touch.



Easily add input modules: just align and mate the connectors on the left side of the instrument assembly, and turn the metal clasp. For added strength, attach the supplied mounting bracket on the rear, or attach a standard DIN rail to the rear for tray or rack mounting.

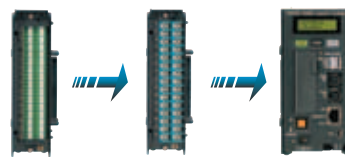

Each measurement module daisy-chains onto the stacking configuration.

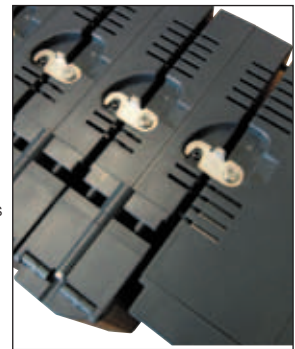

Mounting with a standard DIN rail is supported.



Measurement configuration settings

Logger configuration settings are made from a computer running the supplied application program. Settings can be easily made using familiar PC operations. To keep the process simple, the user is guided sequentially through the setting items.

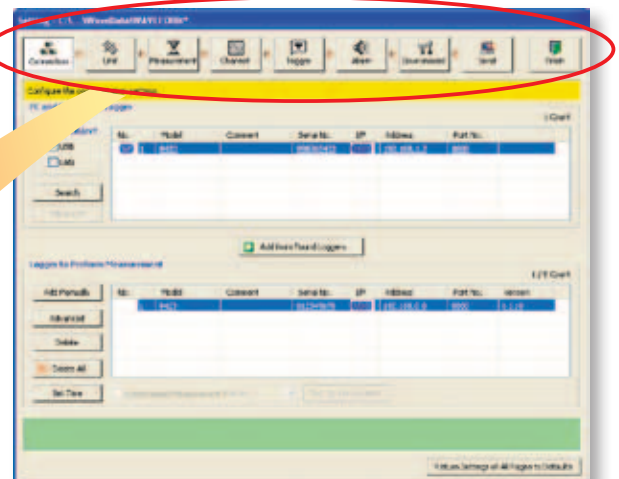



View your data even while measuring!

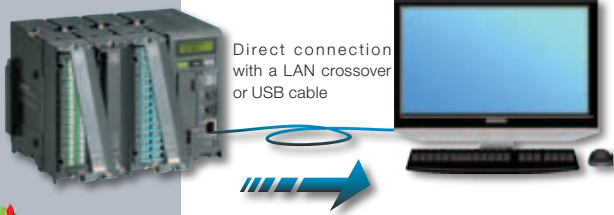
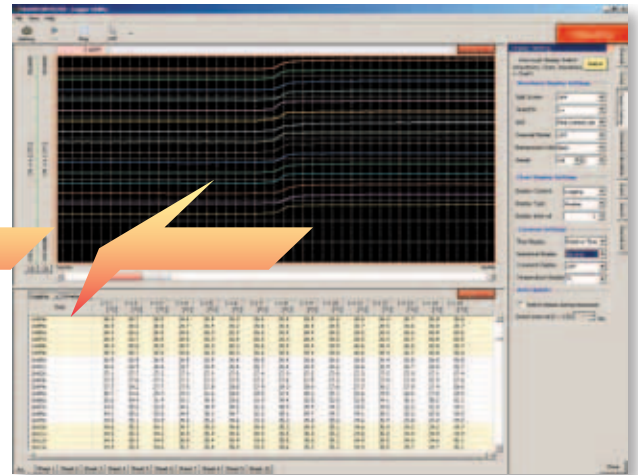
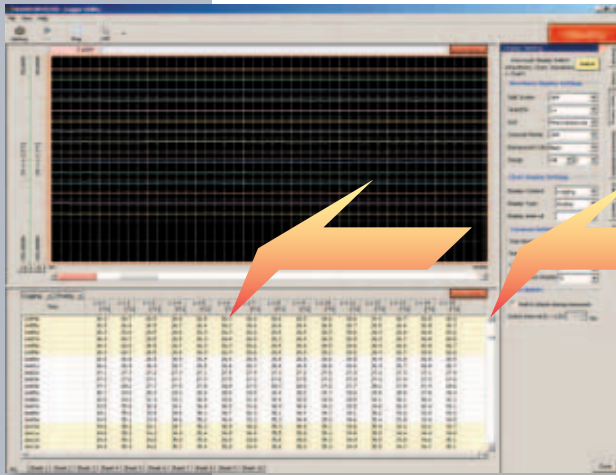

Direct connection with a LAN crossover or USB cable

Data is recorded on the computer in real time using the supplied Logger Utility PC application program. View a trend graph in a window and scroll back to view earlier waveform data, even while recording.



Post-measurement analysis (New Double-Thumb function*)

The newly developed Double-Thumb function simplifies analysis. Two windows are displayed side by side, each with a scroll bar at the bottom containing a thumb (scroll box) that corresponds to the length and position of that window's displayed segment within the overall waveform. The thumbs in the scroll bars of the waveform display windows show you the position of the segments at a glance, greatly simplifying scrolling operations.

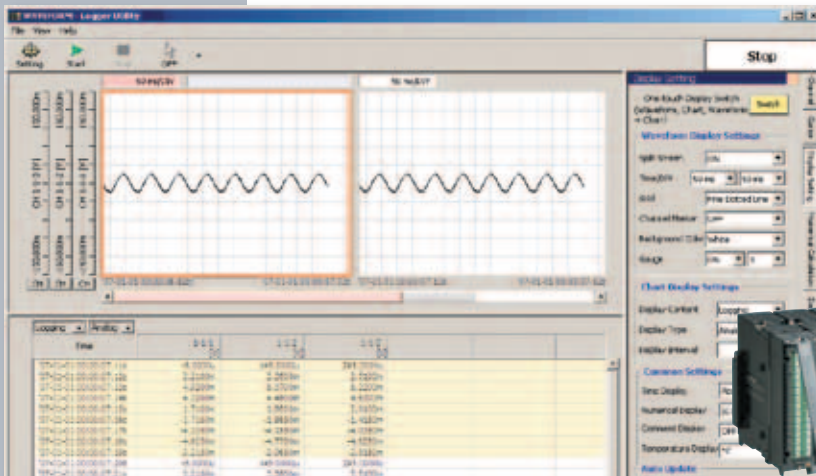
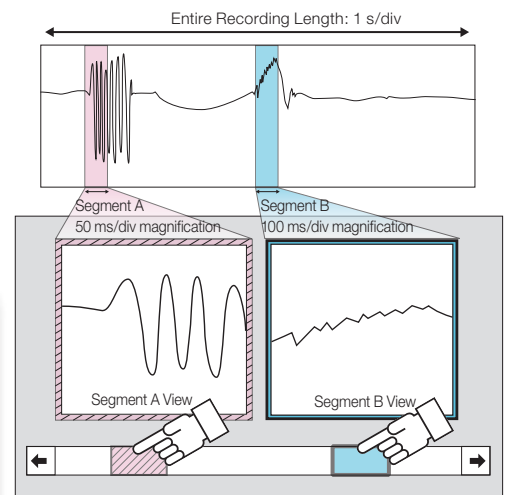

More Functional Details

Universal isolated inputs for temperature, voltage and pulses

*1 Pt (platinum resistance temperature sensor) and humidity measurements require UNIVERSAL UNIT 8949
*2 Requires optional HUMIDITY SENSOR 7901

With the modular input design, you can select the input modules appropriate for your measurement application. Select from voltage and temperature (thermocouple or Pt input*) and humidity.*² Also, Digital Pulse Module 8996 provides 15 input channels for totalization/rotation counts and Hi/Lo logic measurements. In addition to inter-channel input isolation, the PC connection interface is completely isolated from the measurement terminals, minimizing shock hazards and interference even when measuring thermocouple and voltage inputs at the same time.

VOLTAGE/TEMP UNIT 8948

- Voltage: 100 mV f.s., 1 V f.s., 10 V f.s., 20 V f.s., 100 V f.s., 1-5 V f.s.
- Thermocouples: 100 °C f.s., 500 °C f.s., 2000 °C f.s.

UNIVERSAL UNIT 8949

- Voltage: 100 mV f.s., 1 V f.s., 10 V f.s., 20 V f.s., 100 V f.s., 1-5 V f.s.
- Thermocouples: 100 °C f.s., 500 °C f.s., 2000 °C f.s.
- Pt/Pt100: 100 °C f.s., 500 °C f.s., 2000 °C f.s.
- Humidity: 5 to 95% rh

DIGITAL/PULSE UNIT 8996

Note: Isolation between channels is possible through the use of semi-conductor relays. Voltage exceeding the product specifications, such as that originating from lightning surges or other sources, should never be applied between each channel; otherwise the relays will short and the recorder will be damaged.

Real-time saving to CF Card

Each measurement can be saved to a CF Card in real time. Continuous long-term recording can be performed with high capacity CF Cards up to 1 GB. Data can be viewed on a PC using the supplied Logger Utility program.

Enhanced data protection from power failures

This exclusive technology has been developed to preserve data as reliably as possible in the event of a power failure, by incorporating memory card technology with the know-how built into the MEMORY HiLOGGER 8420-50, 8421-50 and 8422-50 series. The 8423 emphasizes the existing HiLOGGER functions and maintains internal supply voltage with a large internal capacitor until all data has been saved to the card, resulting in greater reliability when acquiring large amounts of data.

A CF Card slot is included as a standard feature, supporting HIOKI CF Cards up to 1 GB (operation with non-HIOKI-brand cards is not guaranteed). Using a CF Card, instrument settings can be easily copied from one 8423 to another.

Recording Times with a 512 MB Card (Voltage, Temperature and Humidity Measurements, but no Pulse Channels)

Recording intervals	512MB (using 1 channel)	512MB (using 15 channels)	512MB (using 30 channels)	512MB (using 60 channels)	512MB (using 120 channels)
10ms	31 d 01 h 39 min	2 d 01 h 42 min	1 d 00 h 51 min	12 h 25 min	6 h 12 min
20ms	62 d 03 h 18 min	4 d 03 h 25 min	2 d 01 h 42 min	1 d 00 h 51 min	12 h 25 min
50ms	155 d 08 h 16 min	10 d 08 h 33 min	5 d 04 h 16 min	2 d 14 h 08 min	1 d 07 h 04 min
100ms	310 d 16 h 32 min	20 d 17 h 06 min	10 d 08 h 33 min	5 d 04 h 16 min	2 d 14 h 08 min
200ms	"★"	41 d 10 h 12 min	20 d 17 h 06 min	10 d 08 h 33 min	5 d 04 h 16 min
500ms	"★"	103 d 13 h 30 min	51 d 18 h 45 min	25 d 21 h 22 min	12 d 22 h 41 min
1s	"★"	207 d 03 h 01 min	103 d 13 h 30 min	51 d 18 h 45 min	25 d 21 h 22 min
10s	"★"	"★"	"★"	"★"	258 d 21 h 47 min
1min	"★"	"★"	"★"	"★"	"★"
10min	"★"	"★"	"★"	"★"	"★"
1hour	"★"	"★"	"★"	"★"	"★"

Note: Actual CF data capacity is less than total CF storage capacity, and waveform file headers are not included in these calculated values, so we recommend using 90% of these values for estimation purposes.

Note: "★" Periods longer than 1 year is abbreviated.

Recording Times with a 512 MB Card (Pulse Channels use only)

Recording intervals	512MB (using 1 channel)	512MB (using 15 channels)	512MB (using 30 channels)	512MB (using 60 channels)	512MB (using 120 channels)
10ms	15 d 12 h 49 min	1 d 00 h 51 min	12 h 25 min	6 h 12 min	3 h 06 min
20ms	31 d 01 h 39 min	2 d 01 h 42 min	1 d 00 h 51 min	12 h 25 min	6 h 12 min
50ms	77 d 16 h 08 min	5 d 04 h 16 min	2 d 14 h 08 min	1 d 07 h 04 min	15 h 32 min
100ms	155 d 08 h 16 min	10 d 08 h 33 min	5 d 04 h 16 min	2 d 14 h 08 min	1 d 07 h 04 min
200ms	310 d 16 h 32 min	20 d 17 h 06 min	10 d 08 h 33 min	5 d 04 h 16 min	2 d 14 h 08 min
500ms	"★"	51 d 18 h 45 min	25 d 21 h 22 min	12 d 22 h 41 min	6 d 11 h 20 min
1s	"★"	103 d 13 h 30 min	51 d 18 h 45 min	25 d 21 h 22 min	12 d 22 h 41 min
10s	"★"	"★"	"★"	258 d 21 h 47 min	129 d 10 h 53 min
1min	"★"	"★"	"★"	"★"	"★"
10min	"★"	"★"	"★"	"★"	"★"
1hour	"★"	"★"	"★"	"★"	"★"

Note: Actual CF data capacity is less than total CF storage capacity, and waveform file headers are not included in these calculated values, so we recommend using 90% of these values for estimation purposes.

Note: "★" Periods longer than 1 year is abbreviated.

Trigger function

Focus: All Channels | Trigger Function: ON | Copy | Do

Channel	Condition	Slope	IN/OUT	Level 1	Level 2	1	2	3	4	5	6	7	8	9	10	11	12	13	14	15
1-1-1	Level	↑		0.1[V]																
1-1-2	Window		IN	40.0m[V]	0.1[V]															
	OFF																			
	OFF																			

Level, Window and Logic trigger functions are provided. You can have one criterion start recording and another stop recording.

Dual Sampling

Two different measurement intervals can be specified at the same time (one interval setting per input module). Using dual sampling, the appropriate measurement interval can be set for each type of object to be measured, optimizing use of internal memory and CF Card capacity.

Time	1-1-2 [V]	1-1-3 [V]	1-2-1 [°C]
'07-05-23 14:34:22.2s	0.7370	0.9864	26.10
'07-05-23 14:34:22.3s	0.6488	0.8735	-----
'07-05-23 14:34:22.4s	0.4979	0.6766	-----
'07-05-23 14:34:22.5s	0.2983	0.4132	-----
'07-05-23 14:34:22.6s	0.0698	0.1098	-----
'07-05-23 14:34:22.7s	-0.1642	-0.2024	-----
'07-05-23 14:34:22.8s	-0.3824	-0.4953	-----
'07-05-23 14:34:22.9s	-0.5618	-0.7379	-----
'07-05-23 14:34:23.0s	-0.6848	-0.9065	-----
'07-05-23 14:34:23.1s	-0.7414	-0.9868	-----
'07-05-23 14:34:23.2s	-0.7252	-0.9705	26.07
'07-05-23 14:34:23.3s	0.6360	0.8392	-----

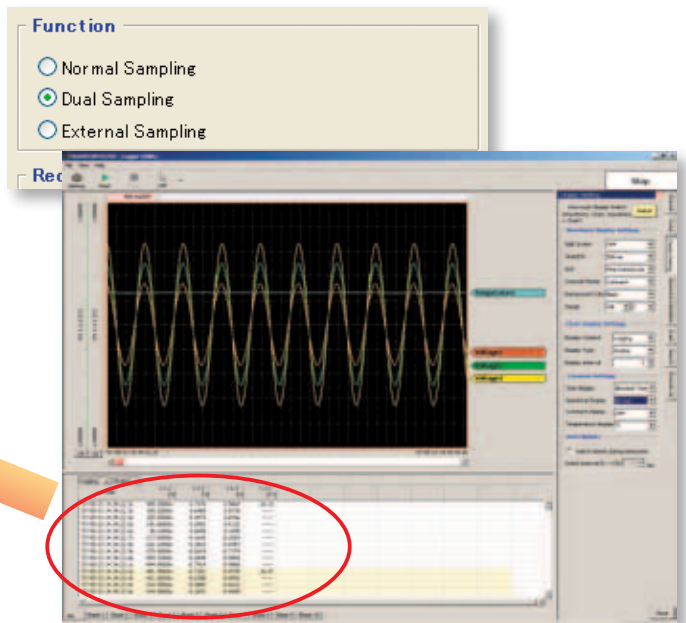

Enhanced PC Interface



USB Port Included

A USB 2.0 (mini-B connector) port is included as standard. The 8423 instrument and a PC can be connected by a USB cable (A to mini-B) for transferring 8423 operating settings and data.



LAN Terminal Included

A 100Base-TX LAN terminal is included as standard. The 8423 instrument and a PC can be connected by a LAN cable for transferring 8423 operating settings and data.

External Control Inputs Included



Input terminals are provided for external triggering, external start and stop and external sampling. External signals can be applied as a trigger source and to start and stop measurements, so data can be acquired by controlled sampling timing.

Note: External triggering and external sampling share a common terminal, so only one of these control input types can be used at a time.

More Functional Details

All-Channel Synchronous Measurement Capability

When measuring up to 120 channels on combined modules, all input channels are sampled synchronously. When multiple **8423s** are connected via LAN or USB for measuring up to 600 channels, the sampling of each instrument in the system can be synchronized using optional Connection Cable Model **9683**. As well as PC-based data collection, measurement start and stop can be controlled by the [START/MARK] and [STOP] keys on a master **8423**.

*Note: Any **8423** may be designated as the master. Only the initial acquisition criteria setting needs to be performed on a PC via USB or LAN.*

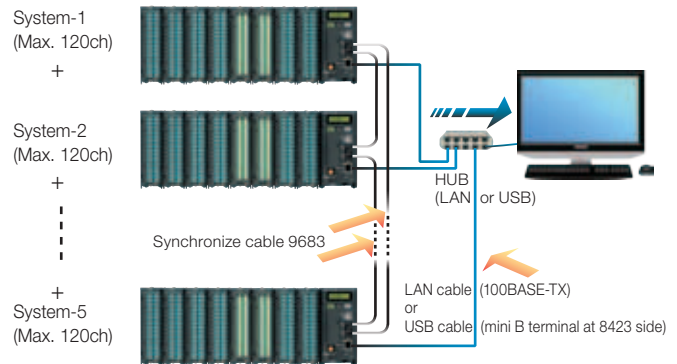

Enhanced Noise Immunity

A delta-sigma type A/D converter has been incorporated in the measurement circuitry. The effects of previously problematic inverter switching noise and 50/60 Hz hum noise have been greatly reduced by the digital filtering function using the oversampling principle inherent in this type of device.

Note: Optimum noise suppression is obtained with recording intervals of two seconds or longer

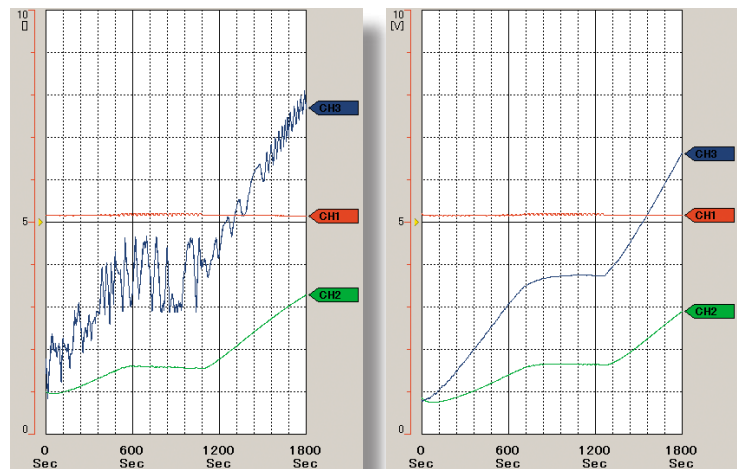

Product Specifications



8423 Hardware Specifications <small>(accuracy is specified @23 ±5°C/73 ±9°F, 30 to 80 % rh, from 30 minutes after power on, accuracy guaranteed for one year, product guaranteed for one year)</small>	
Display	LCD, 16 characters × 2 lines, 5 × 8 dots / characters
Memory capacity	Total 16 M-word (about 16.77 million data points: 32 mega-bytes)
External control connectors	<p>Push-button type terminal block : External trigger/ External sampling input (exclusive OR), External start input, External stop input</p> <p>External sampling : rise-up, or fall-down (selectable)</p> <p>Rise-up : Low (0 to 1.0 V) to High (2.5 to 5.0 V)</p> <p>Fall-down : High (2.5 to 5.0 V) to Low (0 to 1.0 V), or terminal short</p> <p>Input voltage range : -5 to 10 V DC, Filter ON/OFF possible</p> <p>Pulse width response : Over 1 ms at "H", over 2 μs at "L" (at filter OFF), Over 2.5 ms at "H", over 4 ms at "L" (at filter ON)</p> <p>Maximum external sampling period : 10 ms (at digital filter OFF), 20 ms (at digital filter OFF, and synchronous measurement), 5 s (at digital filter ON, and combined with humidity measurement)</p> <p>Synchronous sampling : Five-units maximum for synchronous connection, Function : Connect via the connection cable model 9683 for synchronous sampling</p>
Clock	Auto calendar, leap year auto distinguish, Precision : ±0.2s/ day at power ON, ±3s/ day at power OFF (at 23 °C/ 73°F)
Accuracy of timebase	±0.2s/ day on measurement (at 23 °C/ 73°F)
Recording intervals	10ms, 20ms, 50ms, 100ms, 200ms, 500ms, 1s, 2s, 5s, 10s, 20s, 30s, 1min, 2min, 5min, 10min, 20min, 30min, 1hr (5s to 1hr when combined with humidity measurement)
Recording length	Set to arbitrary length or continuous; Data storage : last 16-mega datas in internal memory (for one channel recording, For n channels, 16 M-datas / n data)
Recording mode	Continue, Repeat, Timer measurement
Number of data	For analog "n" channels, (16-mega datas / n) datas
Durability of battery	Backup battery for clock and setting conditions: battery life of at least 10 years, For measurement data: none (at 23 °C/ 73°F)
No. of connectable units	Maximum 8 units (total 120 channels)
Environmental conditions	Operating temperature and humidity : 0 (32°F) to 40°C (104°F), 30 to 80% rh, Storage temperature and humidity : -10 (14°F) to 50°C (122°F), 80% rh or less, (non-condensating)
Conforming standards	Safety : EN61010, EMC : EN61326, EN61000-3-2, EN61000-3-3
Power supply	(1) Using the AC ADAPTER 9418-15 , 100 to 240 VAC, 50/60 Hz (2) External DC Power: 9.6 V to 15.6 VDC (Please contact HIOKI for connection cord)
Power consumption	Using the AC adapter 9418-15: 55 VA Max. (include AC adapter), 20 VA Max. (main unit only) (when connected with 8 units), External DC Power: 20 VA Max. (when connected with 8 units)
Dimensions & Mass	Approx. 67 mm (2.64 in) W × 133 mm (5.24 in) H × 125 mm (4.92 in) D, 600 g (21.2 oz)
Accessories	Operating Manual ×1, Quick Start Manual ×1, AC ADAPTER 9418-15 ×1, USB cable ×1, Connection Plate ×1, CD-R (data collection software "Logger Utility") ×1, Connector cover ×1, Ferrite clamp ×1
PC Interface	
Data storage media	CF card slot × 1 (Up to 1GB), MS-DOS format, <i>Note: Cannot use with the 9830 (2GB) card</i>
Interface	LAN : supports 100Base-TX, DHCP, DNS USB : Ver 2.0, mini-B receptacle
PC control	Data acquisition and measurement criteria settings are controlled by the PC data acquisition program; data acquired to internal memory and CF Cards is downloaded via FTP server function; simple operations (measurement start/stop and data acquisition to internal memory) are available via HTTP server function
Function Specifications	
Major Functions	Control the input units, or output units, Communication to the PC, Data storage to the CF card
Measurement parameters	Depending on the connected measurement unit: Temperature (thermocouple, Pt), voltage, humidity (used optional sensor), totalized pulses (addition, instantly), rotation count, digital signal
Real time save	Measurement data are saved as binary data to the CF Card in real time, and can be saved to separate files at preset times, selectable as full files or an endless loop with automatic deletion of oldest data.
Dual sampling	Two (high-speed and low-speed) recording intervals can be specified for every input module from the following: 10, 20, 50, 100, 200 and 500 ms; 1, 2, 5, 10, 20 and 30 s; 1, 2, 5, 10, 20 and 30 min; and 1 hr (the low-speed setting divided by the high-speed setting must be an integer less than 1,000)
Marking	Event mark input : Press [Start / Stop] key at measurement
Trigger function	Mode : Single / Repeat, Timing : Start / Stop / Start & Stop, Pre-Trigger : records period before trigger, can be set for real-time saving
Trigger source	<p>Analog input : Maximum 120 channels, depend on number of the input unit.</p> <p>Pulse totalizer inputs : Maximum 120 channels, depend on number of the input unit.</p> <p>Logic inputs : Maximum 120 channels, depend on number of the input unit.</p> <p>External trigger : Rise up or fall down of the external input signal (selectable)</p> <p>Logical AND or OR for each trigger source, Trigger condition settable for each channels</p>
Trigger type	<p>Level: Triggers when rising or falling through preset level</p> <p>Window: Triggers when entering or exiting range defined by preset upper and lower limit values</p> <p>Trigger level resolution : 0.1 % f.s. Logic : 1, 0, × Pattern trigger</p>
External trigger signal	<p>Rise up : Low level (0 to 1.0 V) to High level (2.5 V to 5.0 V)</p> <p>Fall down : High level (2.5 V to 5.0 V) to Low level (0 to 1.0 V), or terminal short</p> <p>Input voltage range : -5 V to 10 V, Filter ON/OFF possible, Pulse width response : more than 1 ms (High period), more than 2 μs (Low period) at filter OFF, more than 2.5 ms (High period), more than 4 ms (Low period) at filter ON</p>
Alarm output	Alarm Module 8997 can be connected along with various measurement modules (although it cannot be connected alone)
Alarm type	<p>Level: Triggers when rising or falling through preset level</p> <p>Window: Triggers when entering or exiting range defined by preset upper and lower limit values</p> <p>Logic pattern : agreement (or disagreement) in the specified pattern</p> <p>Output latch settings : latch / no latch</p>
Start backup	Possible

■ Specification

■ Bundled software specifications

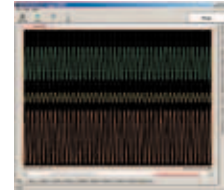

Logger Utility (bundled application software)	
Operating environment	OS: Windows 8 (32/64 bit)/ 7 (32/64 bit)/ Vista/ XP (SP2 or later) (This software is compatible only to the Wireless Logging Station LR8410-20, Memory HiLogger LR8400-20series, LR8431-20, 8423, and 8430-20)
Real-time data acquisition	Measurements on multiple loggers connected by LAN or USB can be controlled to sequentially acquire, display and save waveform data (for recording up to 10 million samples) Number of controllable instruments: up to 5 units (This software is compatible only with the LR8410-20, LR8400-20series, LR8431-20, 8423, and 8430-20) Display: Waveforms (time-axis divided display possible), numerical values (logging), and alarm status can be displayed at the same time Numerical value display: Can be monitored in a separate window Scroll: Waveform scroll while measuring Data saving destination: Real-time data transfer to Excel, or Real-time data acquisition file (LUW format) Event marks: Can be set while measuring
Data acquisition settings	Data acquisition settings for the logger or logging station Saving: The setting for multiple loggers or logging stations can be saved together in one file (LUS format); Instrument configuration settings can be sent and received
Waveform display	Processed data file: Real-time data acquisition file (LUW format), Record to internal memory data (MEM format) Display format: Simultaneously display waveform and numerical value, (time-axis divided display possible) Maximum number of channels: 675 channels (measurement data) + 60 channels (waveform processing data) Others: Display each channel's waveform on 10 sheets, scroll, record event mark, cursor, screen hard copy, numerical value display

Data conversion	Target data: Real-time data acquisition file (LUW format), record to internal memory data (MEM format) Converted sections: All data, designation section Format: CSV format (separate by comma, space, tab), transfer to Excel spreadsheet, arbitrary data thinning
Waveform processing	Processing items: Four arithmetic operations Number of processing channels: 60 channels
Parameter calculations	Target data: Real-time data acquisition file (LUW format), record to internal memory data (MEM format), data acquired in real time, waveform processing data Calculation items: Average, peak, maximum values, time to maximum values, minimum values, time to minimum values, ON time, OFF time, count the number of ON time and OFF time, standard deviation, integration, area values, totalization
Search functions	Target data: Real-time data acquisition file (LUW format), record to internal memory data (MEM format) Search mode: Event mark, time and date, maximum position, minimum position, maximum pole, minimum pole, alarm position, level, window, amount of change
Print functions	Supported printer: Printer compatible with the OS Target data: Real-time data acquisition file (LUW format), record to internal memory data (MEM format) Print format: Waveform image, report format, list print (channel settings, event, cursor value) Print area: The entire area, area between cursors A and B Print preview: Supported



VOLTAGE/TEMP UNIT 8948 (accuracy specified @23 ±5°C/73 ±9°F, 30 to 80% rh., from 30 minutes after power on and after zero point adjustment, accuracy and product guaranteed for one year)																																																																																																																			
Input	Measurement parameters : Voltage, Thermocouples (K, E, J, T, N, W, R, S, B) Terminal : M3 (mm) screw terminals (2 terminals/1ch), terminal block removable, supplied terminal block cover Number of channels : 15 channels isolated from each other and chassis, (voltage or thermocouple selectable for each channels) Input impedance: 1MΩ (850kΩ when open-circuit polling is enabled)																																																																																																																		
Measurement parameters	<table border="1"> <thead> <tr> <th></th> <th>Setting Range</th> <th>Measurement range</th> <th>Resolution</th> <th>Accuracy</th> </tr> </thead> <tbody> <tr> <td rowspan="6">Voltage</td> <td>100mV f.s.</td> <td>-150mV to +150mV</td> <td>5μV</td> <td rowspan="6">±0.1% f.s.</td> </tr> <tr> <td>1V f.s.</td> <td>-1.5V to +1.5V</td> <td>50μV</td> </tr> <tr> <td>10V f.s.</td> <td>-15V to +15V</td> <td>500μV</td> </tr> <tr> <td>20V f.s.</td> <td>-30V to +30V</td> <td>1mV</td> </tr> <tr> <td>100V f.s.</td> <td>-100V to +100V</td> <td>5mV</td> </tr> <tr> <td>1-5V f.s.</td> <td>1V to 5V</td> <td>500μV</td> </tr> <tr> <td rowspan="16">Thermocouples</td> <td>K 100°C f.s.</td> <td>-100°C to 100°C</td> <td>0.01°C</td> <td rowspan="16">±0.05% f.s. ±1°C</td> </tr> <tr> <td>K 500°C f.s.</td> <td>-200°C to 500°C</td> <td>0.05°C</td> </tr> <tr> <td>K 2000°C f.s.</td> <td>-200°C to 1350°C</td> <td>0.1°C</td> </tr> <tr> <td>E 100°C f.s.</td> <td>-100°C to 100°C</td> <td>0.01°C</td> </tr> <tr> <td>E 500°C f.s.</td> <td>-200°C to 500°C</td> <td>0.05°C</td> </tr> <tr> <td>E 2000°C f.s.</td> <td>-200°C to 1000°C</td> <td>0.1°C</td> </tr> <tr> <td>J 100°C f.s.</td> <td>-100°C to 100°C</td> <td>0.01°C</td> </tr> <tr> <td>J 500°C f.s.</td> <td>-200°C to 500°C</td> <td>0.05°C</td> </tr> <tr> <td>J 2000°C f.s.</td> <td>-200°C to 1200°C</td> <td>0.1°C</td> </tr> <tr> <td>T 100°C f.s.</td> <td>-100°C to 100°C</td> <td>0.01°C</td> </tr> <tr> <td>T 500°C f.s.</td> <td>-200°C to 400°C</td> <td>0.05°C</td> </tr> <tr> <td>T 2000°C f.s.</td> <td>-200°C to 400°C</td> <td>0.1°C</td> </tr> <tr> <td>N 100°C f.s.</td> <td>-100°C to 100°C</td> <td>0.01°C</td> </tr> <tr> <td>N 500°C f.s.</td> <td>-200°C to 500°C</td> <td>0.05°C</td> </tr> <tr> <td>N 2000°C f.s.</td> <td>-200°C to 1300°C</td> <td>0.1°C</td> </tr> </tbody> </table> <table border="1"> <thead> <tr> <th></th> <th>Setting Range</th> <th>Measurement range</th> <th>Resolution</th> <th>Accuracy</th> </tr> </thead> <tbody> <tr> <td rowspan="7">Thermocouples</td> <td>R 100°C f.s.</td> <td>0°C to 100°C</td> <td>0.01°C</td> <td rowspan="7">±0.05% f.s. ±3.5°C (0°C to less than 400°C) (Temperatures less than 400°C measured by B thermocouples are not guaranteed for accuracy)</td> </tr> <tr> <td>R 500°C f.s.</td> <td>0°C to 500°C</td> <td>0.05°C</td> </tr> <tr> <td>R 2000°C f.s.</td> <td>0°C to 1700°C</td> <td>0.1°C</td> </tr> <tr> <td>S 100°C f.s.</td> <td>0°C to 100°C</td> <td>0.01°C</td> </tr> <tr> <td>S 500°C f.s.</td> <td>0°C to 500°C</td> <td>0.05°C</td> </tr> <tr> <td>S 2000°C f.s.</td> <td>0°C to 1700°C</td> <td>0.1°C</td> </tr> <tr> <td>B 2000°C f.s.</td> <td>0°C to 1800°C</td> <td>0.1°C</td> </tr> <tr> <td>W : WreS-26</td> <td></td> <td></td> <td></td> <td rowspan="4">±0.05% f.s. ±2°C (400°C and above)</td> </tr> <tr> <td>W 100°C f.s.</td> <td>0°C to 100°C</td> <td>0.01°C</td> </tr> <tr> <td>W 500°C f.s.</td> <td>0°C to 500°C</td> <td>0.05°C</td> </tr> <tr> <td>W 2000°C f.s.</td> <td>0°C to 2000°C</td> <td>0.1°C</td> </tr> </tbody> </table>		Setting Range	Measurement range	Resolution	Accuracy	Voltage	100mV f.s.	-150mV to +150mV	5μV	±0.1% f.s.	1V f.s.	-1.5V to +1.5V	50μV	10V f.s.	-15V to +15V	500μV	20V f.s.	-30V to +30V	1mV	100V f.s.	-100V to +100V	5mV	1-5V f.s.	1V to 5V	500μV	Thermocouples	K 100°C f.s.	-100°C to 100°C	0.01°C	±0.05% f.s. ±1°C	K 500°C f.s.	-200°C to 500°C	0.05°C	K 2000°C f.s.	-200°C to 1350°C	0.1°C	E 100°C f.s.	-100°C to 100°C	0.01°C	E 500°C f.s.	-200°C to 500°C	0.05°C	E 2000°C f.s.	-200°C to 1000°C	0.1°C	J 100°C f.s.	-100°C to 100°C	0.01°C	J 500°C f.s.	-200°C to 500°C	0.05°C	J 2000°C f.s.	-200°C to 1200°C	0.1°C	T 100°C f.s.	-100°C to 100°C	0.01°C	T 500°C f.s.	-200°C to 400°C	0.05°C	T 2000°C f.s.	-200°C to 400°C	0.1°C	N 100°C f.s.	-100°C to 100°C	0.01°C	N 500°C f.s.	-200°C to 500°C	0.05°C	N 2000°C f.s.	-200°C to 1300°C	0.1°C		Setting Range	Measurement range	Resolution	Accuracy	Thermocouples	R 100°C f.s.	0°C to 100°C	0.01°C	±0.05% f.s. ±3.5°C (0°C to less than 400°C) (Temperatures less than 400°C measured by B thermocouples are not guaranteed for accuracy)	R 500°C f.s.	0°C to 500°C	0.05°C	R 2000°C f.s.	0°C to 1700°C	0.1°C	S 100°C f.s.	0°C to 100°C	0.01°C	S 500°C f.s.	0°C to 500°C	0.05°C	S 2000°C f.s.	0°C to 1700°C	0.1°C	B 2000°C f.s.	0°C to 1800°C	0.1°C	W : WreS-26				±0.05% f.s. ±2°C (400°C and above)	W 100°C f.s.	0°C to 100°C	0.01°C	W 500°C f.s.	0°C to 500°C	0.05°C	W 2000°C f.s.	0°C to 2000°C	0.1°C
	Setting Range	Measurement range	Resolution	Accuracy																																																																																																															
Voltage	100mV f.s.	-150mV to +150mV	5μV	±0.1% f.s.																																																																																																															
	1V f.s.	-1.5V to +1.5V	50μV																																																																																																																
	10V f.s.	-15V to +15V	500μV																																																																																																																
	20V f.s.	-30V to +30V	1mV																																																																																																																
	100V f.s.	-100V to +100V	5mV																																																																																																																
	1-5V f.s.	1V to 5V	500μV																																																																																																																
Thermocouples	K 100°C f.s.	-100°C to 100°C	0.01°C	±0.05% f.s. ±1°C																																																																																																															
	K 500°C f.s.	-200°C to 500°C	0.05°C																																																																																																																
	K 2000°C f.s.	-200°C to 1350°C	0.1°C																																																																																																																
	E 100°C f.s.	-100°C to 100°C	0.01°C																																																																																																																
	E 500°C f.s.	-200°C to 500°C	0.05°C																																																																																																																
	E 2000°C f.s.	-200°C to 1000°C	0.1°C																																																																																																																
	J 100°C f.s.	-100°C to 100°C	0.01°C																																																																																																																
	J 500°C f.s.	-200°C to 500°C	0.05°C																																																																																																																
	J 2000°C f.s.	-200°C to 1200°C	0.1°C																																																																																																																
	T 100°C f.s.	-100°C to 100°C	0.01°C																																																																																																																
	T 500°C f.s.	-200°C to 400°C	0.05°C																																																																																																																
	T 2000°C f.s.	-200°C to 400°C	0.1°C																																																																																																																
	N 100°C f.s.	-100°C to 100°C	0.01°C																																																																																																																
	N 500°C f.s.	-200°C to 500°C	0.05°C																																																																																																																
	N 2000°C f.s.	-200°C to 1300°C	0.1°C																																																																																																																
		Setting Range	Measurement range		Resolution	Accuracy																																																																																																													
Thermocouples	R 100°C f.s.	0°C to 100°C	0.01°C	±0.05% f.s. ±3.5°C (0°C to less than 400°C) (Temperatures less than 400°C measured by B thermocouples are not guaranteed for accuracy)																																																																																																															
	R 500°C f.s.	0°C to 500°C	0.05°C																																																																																																																
	R 2000°C f.s.	0°C to 1700°C	0.1°C																																																																																																																
	S 100°C f.s.	0°C to 100°C	0.01°C																																																																																																																
	S 500°C f.s.	0°C to 500°C	0.05°C																																																																																																																
	S 2000°C f.s.	0°C to 1700°C	0.1°C																																																																																																																
	B 2000°C f.s.	0°C to 1800°C	0.1°C																																																																																																																
W : WreS-26				±0.05% f.s. ±2°C (400°C and above)																																																																																																															
W 100°C f.s.	0°C to 100°C	0.01°C																																																																																																																	
W 500°C f.s.	0°C to 500°C	0.05°C																																																																																																																	
W 2000°C f.s.	0°C to 2000°C	0.1°C																																																																																																																	
A/D conversion	Resolution : 16 bit, Maximum sampling speed : 10 ms																																																																																																																		
Filter function	Digital filter : OFF, 50 Hz, 60 Hz (With 50 and 60 Hz settings, the digital filter is automatically set according to recording interval)																																																																																																																		
Max. allowable input	Max. allowable input : 100 V DC (maximum voltage between input terminals that does not cause damage), Max. rated voltage between channels : 200 V DC Max. rated voltage to earth : 600 V DC, AC (Upper limit voltage that does not cause damage when applied between input channel and chassis, and between each input channels)																																																																																																																		
Conforming standards	Safety : EN61010, EMC : EN61326																																																																																																																		
Dimensions & Mass	Approx. 38.5 mm (1.52 in) W × 133 mm (5.24 in) H × 141.2 mm (5.56 in) D mm, 550 g (19.4 oz)																																																																																																																		
Accessories	Connection Plate x1, Operating Manual x1																																																																																																																		

Standard reference contact

Accuracy with internal compensation, add to measurement accuracy ±0.5°C (K, E, J, T)
±1.0°C (N, R, S, B, W)

Switching Switchable between internal and external

■ Specification



UNIVERSAL UNIT 8949		(accuracy specified @ 23 ±5°C/73 ±9°F, 30 to 80% rh., from 30 minutes after power on and after zero point adjustment, accuracy and product guaranteed for one year)																																																																	
Input	Measurement parameters : Voltage, Thermocouples (K, E, J, T, N, W, R, S, B), Resistance temperature sensor (Pt 100, JPt 100), Humidity (only use with the Model 9701 sensor) Terminal : Screw-type terminals (4 terminals/1ch), terminal block removable, supplied terminal block cover Number of channels : 15 channels (input type selectable for each channels), Isolated from each other and chassis (at voltage or thermocouples), Not isolated from each other and common GND (at resistance temperature sensor or humidity) Input impedance: 1MΩ (850kΩ when open-circuit polling is enabled at thermocouples), 2MΩ (when resistance temperature sensor)																																																																		
Measurement parameters	Voltage	<table border="1"> <thead> <tr> <th>Setting Range</th> <th>Measurement range</th> <th>Resolution</th> <th>Accuracy</th> </tr> </thead> <tbody> <tr> <td>100mV f.s.</td> <td>-150mV to +150mV</td> <td>5μV</td> <td rowspan="6">±0.1% f.s. <i>Note: at 1-5 V range, f.s.=10 V</i></td> </tr> <tr> <td>1V f.s.</td> <td>-1.5V to +1.5V</td> <td>50μV</td> </tr> <tr> <td>10V f.s.</td> <td>-15V to +15V</td> <td>500μV</td> </tr> <tr> <td>20V f.s.</td> <td>-30V to +30V</td> <td>1mV</td> </tr> <tr> <td>100V f.s.</td> <td>-60V to +60V</td> <td>5mV</td> </tr> <tr> <td>1-5V f.s.</td> <td>1V to 5V</td> <td>500μV</td> </tr> </tbody> </table>	Setting Range	Measurement range	Resolution	Accuracy	100mV f.s.	-150mV to +150mV	5μV	±0.1% f.s. <i>Note: at 1-5 V range, f.s.=10 V</i>	1V f.s.	-1.5V to +1.5V	50μV	10V f.s.	-15V to +15V	500μV	20V f.s.	-30V to +30V	1mV	100V f.s.	-60V to +60V	5mV	1-5V f.s.	1V to 5V	500μV	<table border="1"> <thead> <tr> <th>Setting Range</th> <th>Measurement range</th> <th>Resolution</th> <th>Accuracy</th> </tr> </thead> <tbody> <tr> <td>R 100°C f.s.</td> <td>0°C to 100°C</td> <td>0.01°C</td> <td rowspan="10">±0.05% f.s. ±3.5°C (0°C to less than 400°C) (Temperatures less than 400°C measured by B thermocouples are not guaranteed for accuracy)</td> </tr> <tr> <td>R 500°C f.s.</td> <td>0°C to 500°C</td> <td>0.05°C</td> </tr> <tr> <td>R 2000°C f.s.</td> <td>0°C to 1700°C</td> <td>0.1°C</td> </tr> <tr> <td>S 100°C f.s.</td> <td>0°C to 100°C</td> <td>0.01°C</td> </tr> <tr> <td>S 500°C f.s.</td> <td>0°C to 500°C</td> <td>0.05°C</td> </tr> <tr> <td>S 2000°C f.s.</td> <td>0°C to 1700°C</td> <td>0.1°C</td> </tr> <tr> <td>B 2000°C f.s.</td> <td>0°C to 1800°C</td> <td>0.1°C</td> </tr> <tr> <td>W : Wres-26</td> <td></td> <td></td> <td rowspan="4">±0.05% f.s. ±2°C (400°C and above)</td> </tr> <tr> <td>W 100°C f.s.</td> <td>0°C to 100°C</td> <td>0.01°C</td> </tr> <tr> <td>W 500°C f.s.</td> <td>0°C to 500°C</td> <td>0.05°C</td> </tr> <tr> <td>W 2000°C f.s.</td> <td>0°C to 2000°C</td> <td>0.1°C</td> </tr> </tbody> </table>			Setting Range	Measurement range	Resolution	Accuracy	R 100°C f.s.	0°C to 100°C	0.01°C	±0.05% f.s. ±3.5°C (0°C to less than 400°C) (Temperatures less than 400°C measured by B thermocouples are not guaranteed for accuracy)	R 500°C f.s.	0°C to 500°C	0.05°C	R 2000°C f.s.	0°C to 1700°C	0.1°C	S 100°C f.s.	0°C to 100°C	0.01°C	S 500°C f.s.	0°C to 500°C	0.05°C	S 2000°C f.s.	0°C to 1700°C	0.1°C	B 2000°C f.s.	0°C to 1800°C	0.1°C	W : Wres-26			±0.05% f.s. ±2°C (400°C and above)	W 100°C f.s.	0°C to 100°C	0.01°C	W 500°C f.s.	0°C to 500°C	0.05°C	W 2000°C f.s.	0°C to 2000°C	0.1°C
	Setting Range	Measurement range	Resolution	Accuracy																																																															
100mV f.s.	-150mV to +150mV	5μV	±0.1% f.s. <i>Note: at 1-5 V range, f.s.=10 V</i>																																																																
1V f.s.	-1.5V to +1.5V	50μV																																																																	
10V f.s.	-15V to +15V	500μV																																																																	
20V f.s.	-30V to +30V	1mV																																																																	
100V f.s.	-60V to +60V	5mV																																																																	
1-5V f.s.	1V to 5V	500μV																																																																	
Setting Range	Measurement range	Resolution	Accuracy																																																																
R 100°C f.s.	0°C to 100°C	0.01°C	±0.05% f.s. ±3.5°C (0°C to less than 400°C) (Temperatures less than 400°C measured by B thermocouples are not guaranteed for accuracy)																																																																
R 500°C f.s.	0°C to 500°C	0.05°C																																																																	
R 2000°C f.s.	0°C to 1700°C	0.1°C																																																																	
S 100°C f.s.	0°C to 100°C	0.01°C																																																																	
S 500°C f.s.	0°C to 500°C	0.05°C																																																																	
S 2000°C f.s.	0°C to 1700°C	0.1°C																																																																	
B 2000°C f.s.	0°C to 1800°C	0.1°C																																																																	
W : Wres-26				±0.05% f.s. ±2°C (400°C and above)																																																															
W 100°C f.s.	0°C to 100°C	0.01°C																																																																	
W 500°C f.s.	0°C to 500°C	0.05°C																																																																	
W 2000°C f.s.	0°C to 2000°C	0.1°C																																																																	
Thermocouples	<table border="1"> <thead> <tr> <th>Setting Range</th> <th>Measurement range</th> <th>Resolution</th> <th>Accuracy</th> </tr> </thead> <tbody> <tr> <td>K 100°C f.s.</td> <td>-100°C to 100°C</td> <td>0.01°C</td> <td rowspan="16">±0.05% f.s. ±1°C</td> </tr> <tr> <td>K 500°C f.s.</td> <td>-200°C to 500°C</td> <td>0.05°C</td> </tr> <tr> <td>K 2000°C f.s.</td> <td>-200°C to 1350°C</td> <td>0.1°C</td> </tr> <tr> <td>E 100°C f.s.</td> <td>-100°C to 100°C</td> <td>0.01°C</td> </tr> <tr> <td>E 500°C f.s.</td> <td>-200°C to 500°C</td> <td>0.05°C</td> </tr> <tr> <td>E 2000°C f.s.</td> <td>-200°C to 1000°C</td> <td>0.1°C</td> </tr> <tr> <td>J 100°C f.s.</td> <td>-100°C to 100°C</td> <td>0.01°C</td> </tr> <tr> <td>J 500°C f.s.</td> <td>-200°C to 500°C</td> <td>0.05°C</td> </tr> <tr> <td>J 2000°C f.s.</td> <td>-200°C to 1200°C</td> <td>0.1°C</td> </tr> <tr> <td>T 100°C f.s.</td> <td>-100°C to 100°C</td> <td>0.01°C</td> </tr> <tr> <td>T 500°C f.s.</td> <td>-200°C to 400°C</td> <td>0.05°C</td> </tr> <tr> <td>T 2000°C f.s.</td> <td>-200°C to 400°C</td> <td>0.1°C</td> </tr> <tr> <td>N 100°C f.s.</td> <td>-100°C to 100°C</td> <td>0.01°C</td> </tr> <tr> <td>N 500°C f.s.</td> <td>-200°C to 500°C</td> <td>0.05°C</td> </tr> <tr> <td>N 2000°C f.s.</td> <td>-200°C to 1300°C</td> <td>0.1°C</td> </tr> </tbody> </table>				Setting Range	Measurement range	Resolution	Accuracy	K 100°C f.s.	-100°C to 100°C	0.01°C	±0.05% f.s. ±1°C	K 500°C f.s.	-200°C to 500°C	0.05°C	K 2000°C f.s.	-200°C to 1350°C	0.1°C	E 100°C f.s.	-100°C to 100°C	0.01°C	E 500°C f.s.	-200°C to 500°C	0.05°C	E 2000°C f.s.	-200°C to 1000°C	0.1°C	J 100°C f.s.	-100°C to 100°C	0.01°C	J 500°C f.s.	-200°C to 500°C	0.05°C	J 2000°C f.s.	-200°C to 1200°C	0.1°C	T 100°C f.s.	-100°C to 100°C	0.01°C	T 500°C f.s.	-200°C to 400°C	0.05°C	T 2000°C f.s.	-200°C to 400°C	0.1°C	N 100°C f.s.	-100°C to 100°C	0.01°C	N 500°C f.s.	-200°C to 500°C	0.05°C	N 2000°C f.s.	-200°C to 1300°C	0.1°C													
Setting Range	Measurement range	Resolution	Accuracy																																																																
K 100°C f.s.	-100°C to 100°C	0.01°C	±0.05% f.s. ±1°C																																																																
K 500°C f.s.	-200°C to 500°C	0.05°C																																																																	
K 2000°C f.s.	-200°C to 1350°C	0.1°C																																																																	
E 100°C f.s.	-100°C to 100°C	0.01°C																																																																	
E 500°C f.s.	-200°C to 500°C	0.05°C																																																																	
E 2000°C f.s.	-200°C to 1000°C	0.1°C																																																																	
J 100°C f.s.	-100°C to 100°C	0.01°C																																																																	
J 500°C f.s.	-200°C to 500°C	0.05°C																																																																	
J 2000°C f.s.	-200°C to 1200°C	0.1°C																																																																	
T 100°C f.s.	-100°C to 100°C	0.01°C																																																																	
T 500°C f.s.	-200°C to 400°C	0.05°C																																																																	
T 2000°C f.s.	-200°C to 400°C	0.1°C																																																																	
N 100°C f.s.	-100°C to 100°C	0.01°C																																																																	
N 500°C f.s.	-200°C to 500°C	0.05°C																																																																	
N 2000°C f.s.	-200°C to 1300°C	0.1°C																																																																	
A/D conversion		Resolution : 16 bit, Maximum sampling speed : 10 ms (5 s when combined with humidity measurement)																																																																	
Filter function		Digital filter : OFF, 50 Hz, 60 Hz (With 50 and 60 Hz settings, the digital filter is automatically set according to recording interval)																																																																	
Max. allowable input		Max. allowable input : 60 V DC (maximum voltage between input terminals that does not cause damage), Max. rated voltage between channels : 120 V DC Max. rated voltage to earth : 600 V DC, AC (Upper limit voltage that does not cause damage when applied between input channel and chassis, and between each input channels)																																																																	
Conforming standards		Safety : EN61010, EMC : EN61326																																																																	
Dimensions & Mass		Approx. 38.5 mm (1.52 in) W × 133 mm (5.24 in) H × 141.2 mm (5.56 in) D mm, 530 g (18.7 oz)																																																																	
Accessories		Flat-blade Screwdriver x1 (for terminal block), Connection Plate x1, Operating Manual x1																																																																	

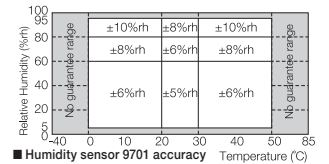

DIGITAL/PULSE UNIT 8996		(product guaranteed for one year)			
Input	Input signal condition : No-voltage 'a' contact (normally open contact), open collector or voltage input, Digital / Pulse input selectable for each channels Measurement parameters : Voltage, Totalized pulses (integrated or instantaneous), Rotation count, ON/OFF digital signal Terminal : M3 (mm) screw terminals (2 terminals/1ch), terminal block removable, supplied terminal block cover Number of channels : 15 channels (digital / pulse selectable for each channels) (common ground for CH-1 to CH-5, common ground for CH-6 to CH-10, common ground for CH-11 to CH-15) Input impedance : 1.1MΩ				
Pulse input	Totalized pulses	Setting Range	Measurement range	Resolution	Pulse input period with filter OFF 200 μs or more (both H and L periods must be at least 100 μs) with filter ON 100 ms or more (both H and L periods must be at least 50 ms)
	Rotation count	1,000M pulse f.s. 5,000/n (r/s) f.s.	0 to 1,000M pulse 0 to 5,000/n (r/s)	1 pulse 1/n (r/s)	
Digital input	Logic detection level	HIGH = at least 1.0 V, LOW = 0 to 0.5 V HIGH = at least 4.0 V, LOW = 0 to 1.5 V			Filter Chatter-prevention filter : can be set ON/OFF for each channels Slope Rising or falling edge can be set for each channel Detection level HIGH = at least 1.0 V, LOW = 0 to 0.5 V HIGH = at least 4.0 V, LOW = 0 to 1.5 V
Max. allowable input		50 V DC (maximum voltage between input terminals that does not cause damage)			
Max. rated voltage to earth		600 V DC, AC (Upper limit voltage that does not cause damage when applied between CH-1 to CH-5 each channel and chassis, CH-6 to CH-10 each channel and chassis, CH-11 to CH-15 each channel and chassis, and between each UNITS)			
Max. rated voltage to each channels		33 V AC rms, 70 V DC (Upper limit voltage that does not cause damage when applied between CH-1 to CH-5 each channel and CH-6 to CH-10 each channel, CH-6 to CH-10 each channel and CH-11 to CH-15 each channel, CH-1 to CH-5 each channel and CH-11 to CH-15 each channel)			
Conforming standards		Safety : EN61010, EMC : EN61326			
Dimensions & Mass		Approx. 38.5 mm (1.52 in) W × 133 mm (5.24 in) H × 141.2 mm (5.56 in) D mm, 500 g (17.6 oz)			
Accessories		Connection Plate x1, Operating Manual x1			

ALARM UNIT 8997		(product guaranteed for one year)			
Output	Output type : open collector (active low) Alarm parameters : Use up to 15 channels in response to analog input, pulse input, rotation count, or ON/OFF digital signal Terminal : M3 (mm) screw terminals (2 terminals/1ch) Number of channels : 15 channels isolated from each other and chassis				
Output sink current	Maximum switching capability : 5 to 60 V DC @10 mA (open collector drive)				
Output refresh	Output latch settings : Latch / No latch at every recording interval				
Max. rated voltage to earth	600 V DC, AC (Upper limit voltage that does not cause damage when applied between each output channel and chassis, and between each units)				
Max. rated voltage to each channels	33 V AC rms, 70 V DC (Upper limit voltage that does not cause damage when applied between each output channels)				
Conforming standards		Safety : EN61010, EMC : EN61326			
Dimensions & Mass		Approx. 38.5 mm (1.52 in) W × 133 mm (5.24 in) H × 141.2 mm (5.56 in) D mm, 500 g (17.6 oz)			
Accessories		Connection Plate x1, Operating Manual x1			



8423 Options in Detail



Note: 8423 cannot operate alone. You must install one or more optional input modules in the unit. Thermocouples are not provided by HIOKI, and must be purchased from a separate vendor.

MEMORY HILOGGER 8423
Maximum number of connectable units: 8

Input options				
	VOLTAGE/TEMP UNIT 8948 15-channels, Voltage, Thermocouple input	UNIVERSAL UNIT 8949 15-channels, Voltage, Thermocouple, Resistance temperature sensor, Humidity measurement	DIGITAL/PULSE UNIT 8996 15-channels, ON/OFF logic signal, Totalized pulses (integrated or instantaneous), Rotation count	ALARM UNIT 8997 15-channels, Open-collector output

Storage media		Supplied with PC Card adapter
	PC CARD 1G 9729 (1 GB capacity)	PC CARD 512M 9728 (512 MB capacity)
	PC Card Precaution Use only PC Cards sold by HIOKI. Compatibility and performance are not guaranteed for PC cards made by other manufacturers. You may be unable to read from or save data to such cards.	

Note: The PC CARD 2G 9830 is not usable with the Model 8423

*9418-15 is supplied as standard

Other options				
	AC ADAPTER 9418-15 100 to 240V AC	LAN CABLE 9642 Straight Ethernet cable, supplied with straight to cross conversion adapter, 5 m (16.41 ft) length	CONNECTION CABLE 9683 For synchronization, cable length 1.5 m (4.92 ft)	HUMIDITY SENSOR 9701 1-channel, for Universal unit 8949

■ Appearance/Dimension Illustration

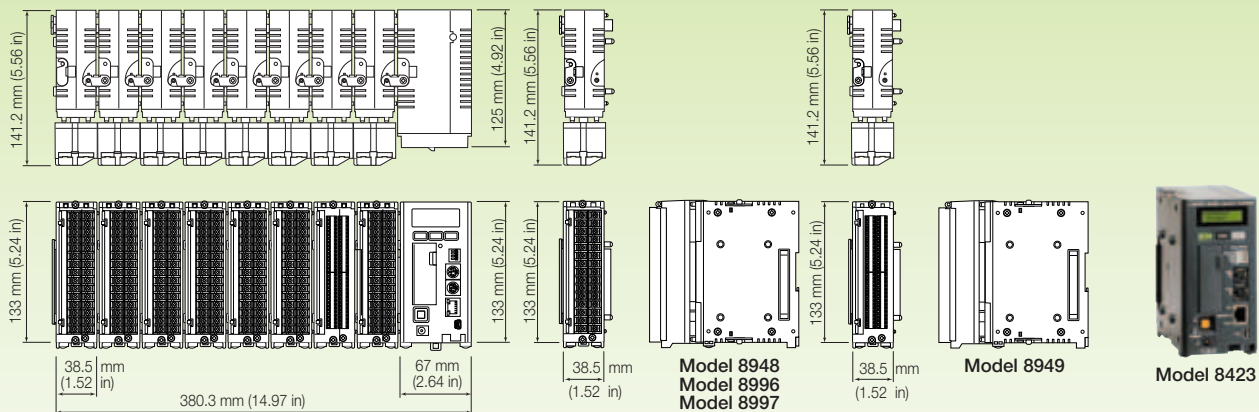

■ Configuration Examples

Input unit x 1 15-channels Isolated	Input unit x 2 30-channels Isolated	Input unit x 4 60-channels Isolated	Input unit x 8 120-channels Isolated	(Input unit x 8) system x 2 240-channels Isolated	(Input unit x 8) system x 4 480-channels Isolated	(Input unit x 8) system x 5 600-channels Isolated
Model 8423 x 1 Model 8948 x 1	Model 8423 x 1 Model 8948 x 2	Model 8423 x 1 Model 8948 x 4	Model 8423 x 1 Model 8948 x 8	Model 8423 x 2 Model 8948 x 16 Synchronization cable 9683 x 2	Model 8423 x 4 Model 8948 x 32 Synchronization cable 9683 x 4	Model 8423 x 5 Model 8948 x 40 Synchronization cable 9683 x 5

Note: Company names and Product names appearing in this catalog are trademarks or registered trademarks of various companies.

HIOKI

HIOKI E. E. CORPORATION

HEADQUARTERS:

81 Koizumi, Ueda, Nagano, 386-1192, Japan
TEL +81-268-28-0562 FAX +81-268-28-0568
http://www.hioki.com / E-mail: os-com@hioki.co.jp

HIOKI USA CORPORATION:

TEL +1-609-409-9109 FAX +1-609-409-9108
http://www.hiokiusa.com / E-mail: hioki@hiokiusa.com

HIOKI (Shanghai) SALES & TRADING CO., LTD.:

TEL +86-21-63910090 FAX +86-21-63910360
http://www.hioki.cn / E-mail: info@hioki.com.cn

HIOKI INDIA PRIVATE LIMITED:

TEL +91-124-6590210 FAX +91-124-6460113
E-mail: hioki@hioki.in

HIOKI SINGAPORE PTE. LTD.:

TEL +65-6634-7677 FAX +65-6634-7477
E-mail: info-sg@hioki.com.sg

HIOKI KOREA CO., LTD.:

TEL +82-42-936-1281 FAX +82-42-936-1284
E-mail: info-kr@hioki.co.jp

DISTRIBUTED BY