

HIOKI

QUICK START MANUAL

3169-20/21

**CLAMP ON POWER
HiTESTER**

HIOKI E. E. CORPORATION

Contents

Introduction	1
Safety Notes	1
1 Parts Names	3
<hr/>	
1.1 Instrument Labels and Functions	4
1.2 Screen Names and Display Elements	8
1.2.1 Screen Configuration	8
1.2.2 Common Display	9
1.2.3 On-Screen Indicators	10
2 Power Measurement	11
<hr/>	
2.1 Outline	11
2.2 Measurement Procedure	13
2.3 Measurement Preparations	14
2.4 Connect to the Line to be Measured	18
2.5 Perform Measurement	26





Introduction



- The 3169-20/21 CLAMP ON POWER HiTESTER is supplied with a instruction manual in addition to this manual. Please be sure to read both manuals.
- This manual is a quick reference source with examples and information regarding the setting-up of and key operation for the 3169-20/21 CLAMP ON POWER HiTESTER for measurement purposes.
- For current input with this device, a clamp-on sensor (optional) is required. For details, refer to the instruction manual for the clamp-on sensor you are using.

Safety Notes

The following symbols in this manual indicate the relative importance of cautions and warnings.

 <u>DANGER</u>	Indicates that incorrect operation presents an extreme hazard that could result in serious injury or death to the user.
 <u>WARNING</u>	Indicates that incorrect operation presents a significant hazard that could result in serious injury or death to the user.
 <u>CAUTION</u>	Indicates that incorrect operation presents a possibility of injury to the user or damage to the product.
<u>NOTE</u>	Advisory items related to performance or correct operation of the product.

Other Symbols

	Indicates the prohibited action.
	Indicates the reference.
	Indicates quick references for operation and remedies for troubleshooting.
*	Indicates terminology explained at the bottom of the page.



Parts Names

1

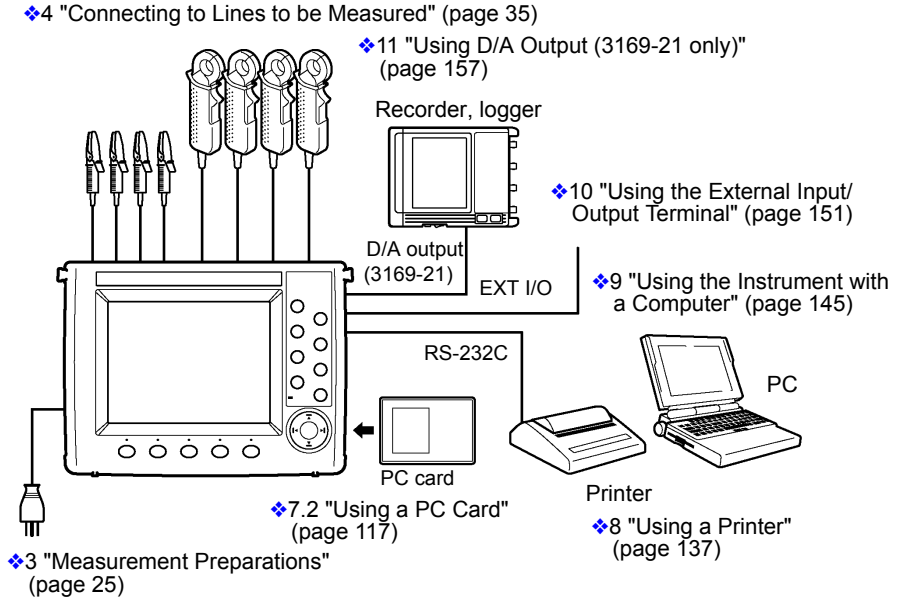

*: The RS-232C is connected to a printer or PC.

NOTE

The reference pages referred to above are those in the instruction manual.

1.1 Instrument Labels and Functions

Front Panel

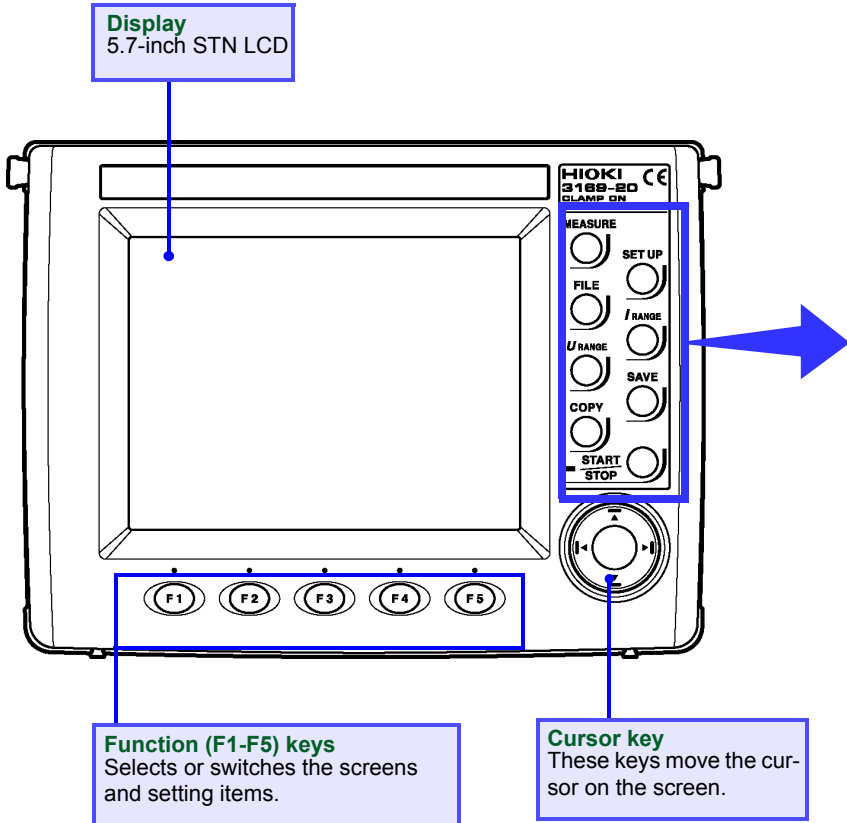

Front Panel Enhanced View

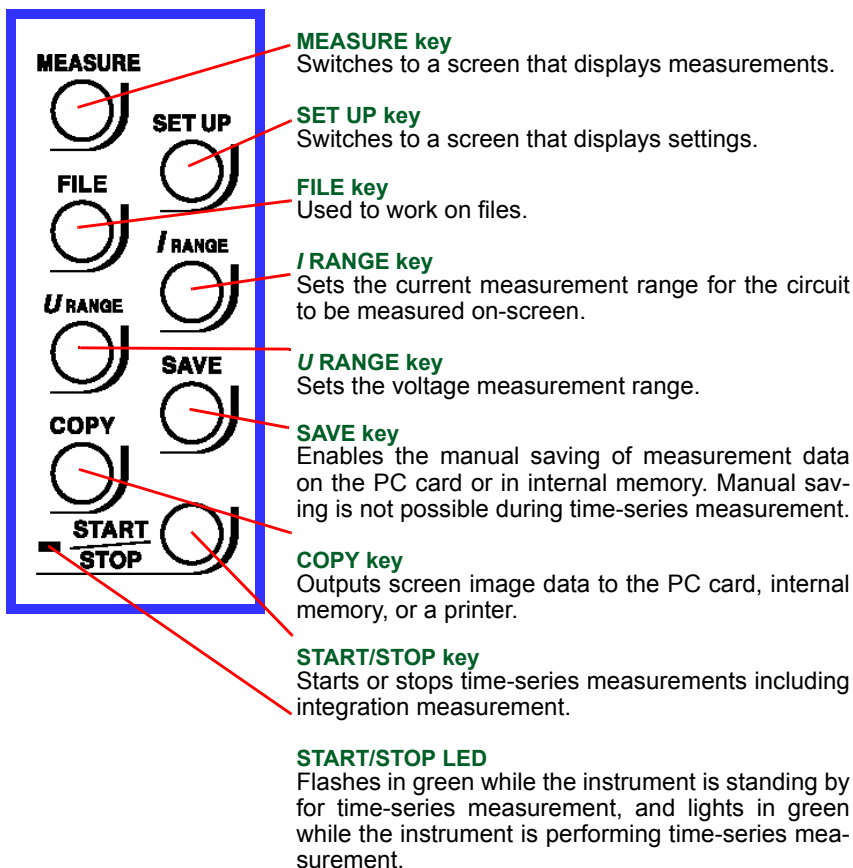

1.1 Instrument Labels and Functions

Top Panel

Voltage Input terminals

Connect the supplied 9438-03 VOLTAGE CORD.

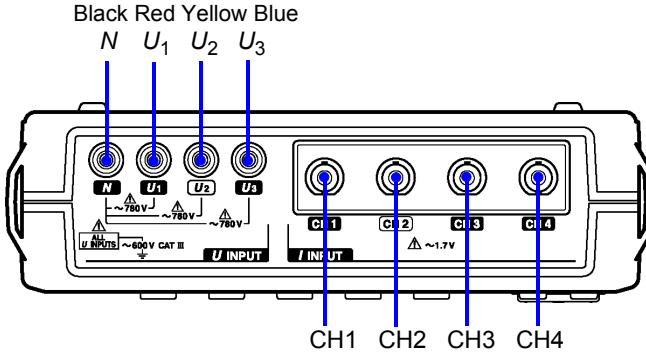
**Current Input terminals**

Connect an optional clamp-on sensor.

Left Panel

Contrast Control Knob (CONTRAST)

Adjusts the contrast of the screen.

KEY LOCK switch

Sliding this switch in the direction of the arrow disables all key operation except the POWER switch.

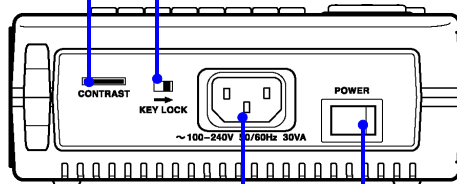
**AC Power Inlet**

Connects the power cord.
The supply voltage ranges from 100 V to 240 V.

POWER switch

Turns the instrument on and off.
○ : Power OFF
| : Power ON

Right Panel

PC Card slot

A PC Card can be inserted here.

RS-232C Interface connector

Connects to a PC or printer using an RS-232C cable.

D/A Output Terminal (D/A OUT)

Installed in the 3169-21 only. Connects the supplied 9441 connection cable. Used for analog output.

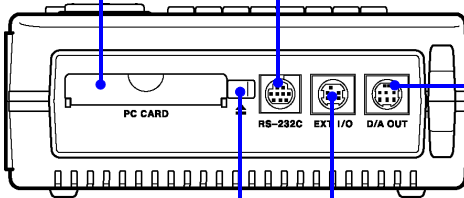

Eject button

Press this button to eject a PC Card from the slot.

External Input/Output Terminal (EXT I/O)

Connects the optional 9440 connection cable. Used to start and stop time-series measurement, and control data storage on the PC card.

Rear Panel

Number plate

Contains manufacturer's ID numbers. Please do not remove, as this information is required for product management.

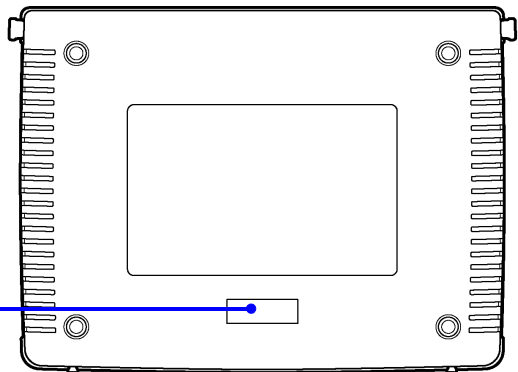

1.2 Screen Names and Display Elements

1.2.1 Screen Configuration

The screens are divided into three basic types: measurement screens, setting screens, and file screens. Each screen is selected using three panel keys: **MEASURE**, **SET UP**, and **FILE**.

Measurement screen

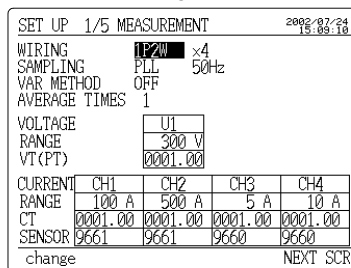
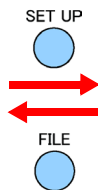
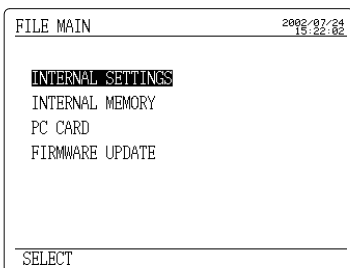
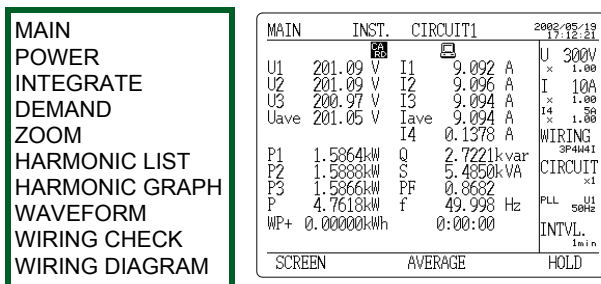

INTERNAL SETTINGS
 INTERNAL MEMORY
 PC CARD
 FIRMWARE UPDATE

MEASUREMENT
 DATA OUTPUT
 SAVE, PRINT ITEMS
 SYSTEM
 D/A OUTPUT (3169-21 only)

1.2.2 Common Display

This section of the screen shows information common to all measurement screens (except the zoom screen and the wiring diagram screen).

Common Display

MAIN	INST.	CIRCUIT1		2002/05/19 17:12:21
U1	201.09 V	I1	9.092 A	U 300V × 1.00
U2	201.09 V	I2	9.096 A	I 10A × 1.00
U3	200.97 V	I3	9.094 A	I4 50 × 1.00
Uave	201.05 V	Iave	9.094 A	WIRING 3P4W4I
		I4	0.1378 A	CIRCUIT x1
P1	1.5864kW	Q	2.7221kvar	PLL U1 50Hz
P2	1.5888kW	S	5.4850kVA	INTVL. 1min
P3	1.5866kW	PF	0.8682	
P	4.7618kW	f	49.998 Hz	
WP+	0.00000kWh		0:00:00	
SCREEN			AVERAGE	HOLD











Annotations in the image point to the following elements in the right-hand column of the table:

- Time: 2002/05/19 17:12:21
- Range: U 300V, I 10A, I4 50
- Wiring: WIRING 3P4W4I
- No. of circuits: CIRCUIT x1
- Synchronization method: PLL U1 50Hz
- Interval: INTVL. 1min

Time	Displays the current time.
Range	Displays the voltage range and current range of the on-screen circuit. The VT(PT) ratio and CT ratio are shown under these ranges. The current range and CT ratio of I4 are shown only when 3P4W4I is set as the wiring method.
Wiring	Displays the wiring method set on the setting screen.
No. of circuits	Displays the number of circuits to be measured as set on the setting screen.
Synchronization method	Displays the synchronization method and frequency of the line to be measured as set on the setting screen.
Interval	Displays the interval set on the setting screen.

1.2.3 On-Screen Indicators

MAIN	INST.	CIRCUIT1	VAR	2002/05/25 14:05:53
U1	over V	I1	over A	U 150V x 1.00
U2	over V	I2	over A	I 5A x 1.00
U3*	over V	I3*	over A	
Uave	over V	Iave	over A	
P	over kW	Q	over kvar	WIRING 3P3W2M
		S	over kVA	CIRCUIT x2
		PF	over	PLL U1 50Hz
		f	50.000 Hz	INTVL. 1min
WP+	0.000 Wh		0:00:00	
SCREEN CIRCUIT AVERAGE				HOLD

	Goes on when the reactive-power-meter method is ON.
	Goes on when the displayed measurement is held.
	Goes on when the medium for saving data is set to PC card. Flashes when the PC card is accessed.
	Goes on when the medium for saving data is set to internal memory. Flashes when the internal memory is accessed.
	Goes on when the PC card or internal memory is full.
	Goes on when the device to be connected to the RS-232C is set to PC.
	Goes on when the device to be connected to the RS-232C is set to printer.
	Goes on when the PLL is unlocked; the synchronization method is automatically switched over to the fixed clock.
	Goes on when the keys are locked.
	Goes on when the voltage or current dynamic range is exceeded.
over	Displayed when the range is exceeded.

NOTE

U3* and I3* indicate that the data is obtained by calculating the 2-voltage, 2-current measurement results when 3P3W2M (three-phase, 3-wire, 2-power-meter method) is selected.

❖ Instruction manual "Appendix" (page 195)

Power Measurement

2

2.1 Outline

This chapter explains setting and measurement procedures using the following conditions.

Measure the power of a Three-phase 3-wire line for 7 days.

Measurement location:

A Three-phase 3-wire 200 V line of a switchboard (50 Hz, 50 A load)

Setting:

Time-series measurement start time: 2002/06/20 08:00

Time-series measurement stop time: 2002/06/27 08:00

Data is automatically output to the PC card at 5-minute intervals.

Average value (voltage, current, and power) and integrated power are stored on the PC card. The reactive power-meter method is not used.

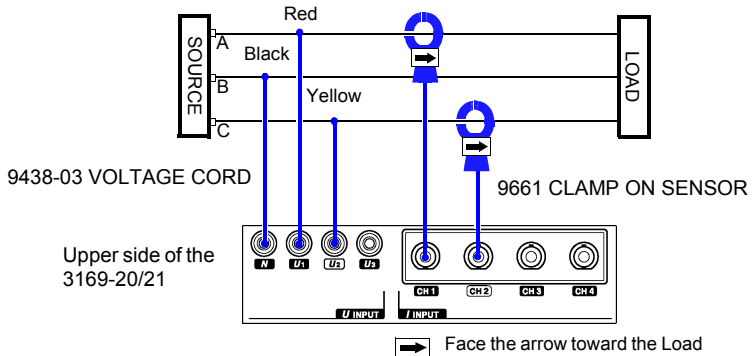

◆ Instrument and Accessories Required for Measurement

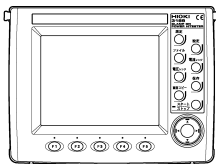

3169-20/21

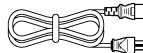

Power cord



PC card

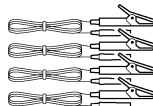

9438-03 VOLTAGE CORD
1 set (4 cords)(One each red, yellow,
blue, and black cords.)

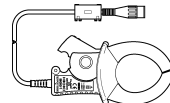

9661 CLAMP ON SENSOR
x 2

2.1 Outline

◆ Setting Screens under the Example Conditions

SET UP 1/5 MEASUREMENT		2002/06/19 15:37:32
WIRING	3P3W2M x1	
SAMPLING	PLL 50Hz	
VAR METHOD	OFF	
AVERAGE TIMES	1	
VOLTAGE	U12	
RANGE	300 V	
VT(PT)	0001.00	
CURRENT	CH12	
RANGE	50 A	
CT	0001.00	
SENSOR	9661	
change		NEXT SCR

<MEASUREMENT>

WIRING : 3P3W2M
 (Three-phase 3-wire,
 2-power-meter method)
Number of circuits : X 1 (1 circuit)
SAMPLING : PLL
Measured frequency : 50 Hz
VAR METHOD : OFF
AVERAGE TIMES : 1
VOLTAGE RANGE : 300 V
VT (PT) : 0001.00
CURRENT RANGE : 50 A
CT : 0001.00
SENSOR : 9661

SET UP 2/5 DATA OUTPUT		2002/06/19 15:45:00
MEAS. START	TIME	
	2002/06/20 08:00	
MEAS. STOP	TIME	
	2002/06/27 08:00	
INTERVAL TIME	5 min	
SAVE IN...	PC CARD	
DATA FILE NAME	INTEG	
RS CONNECTION	PC	
DISPLAY COPY	PC CARD	
MANUAL TIME	JUST	NEXT SCR

<DATA OUTPUT>

MEAS. START : TIME
 (2002/06/20 08:00)
MEAS. STOP : TIME
 (2002/06/27 08:00)
INTERVAL TIME : 5 min
SAVE IN... : PC CARD
DATA FILE NAME : INTEG

SET UP 3/5 SAVE, PRINT ITEMS		2002/06/19 15:46:06
		NO. OF ITEMS 39
NORM. MEAS.	ON	INST. OFF
		AVE. ON
HARMONIC	OFF	MAX. OFF
		MIN. OFF
INTEG. & DEM.	ON	
SAVE TIME AVAIL.	73d 18h 40m 0s	
OFF	ON	NEXT SCR

<SAVE, PRINT ITEMS>

NORM. MEAS.: ON **INST.:** OFF
HARMONIC : OFF **AVE.:** ON
MAX.: OFF
MIN.: OFF

INTEG. & DEM.: ON

2.2 Measurement Procedure

Measurement Preparations (page 14)

1. Connecting the Power Cord
2. Connecting the Voltage Cords
3. Connecting the Clamp-On Sensor
4. Inserting a PC Card
5. Turning the Power On



Connect to the Line to be Measured (page 18)

1. Setting the wiring details
2. Displaying the Wiring Diagram
3. Connecting the voltage cords and clamp-on sensor to the line to be measured
4. Checking the Wiring



Perform Measurement (page 26)

1. Setting the measurement conditions
2. Confirm range
3. Start measurement
4. Stop measurement

Shutdown Procedure

1. Disconnect the voltage cords and clamp-on sensor from the measured line.
2. Turn off the power to the 3169-20/21.
3. Disconnect the power cord from the AC outlet.
4. Remove the PC card from the 3169-20/21 and analyze the saved data on PC.

2.3 Measurement Preparations

1. Connecting the Power Cord

! WARNING

- Before turning the product on, make sure the source voltage matches that indicated on the product's power connector. Connection to an improper supply voltage may damage the product and present an electrical hazard.
- To avoid electric shock and ensure safe operation, connect the power cable to a grounded (3-contact) outlet.

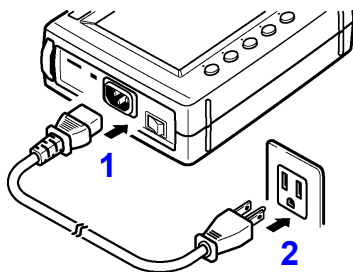

1. Connect the power cord to the AC power inlet.
2. Plug the power cord into the AC mains outlet.

2. Connecting the Voltage Cords



Connect the voltage cords to the product first, and then to the active lines to be measured. Observe the following to avoid electric shock and short circuits.

- Voltage cord should only be connected to the secondary side of a breaker, so the breaker can prevent an accident if a short circuit occurs. Connections should never be made to the primary side of a breaker, because unrestricted current flow could cause a serious accident if a short circuit occurs.
- Do not allow Do not allow the voltage cable clips to touch two wires at the same time. Never touch the edge of the metal clips. Never touch the edge of the metal clips.
- Voltage input terminals U_1 , U_2 , and U_3 are common to the N terminal and are not insulated. To avoid the risk of electric shock, do not touch the terminals.



- For safety reasons, when taking measurements, only use the 9438-03 VOLTAGE CORD provided with the product.
- The supplied voltage cords consist of one each red, yellow, blue and black cords. Connect only the cords actually needed for measurement. Cords not being used for measurement should be disconnected.

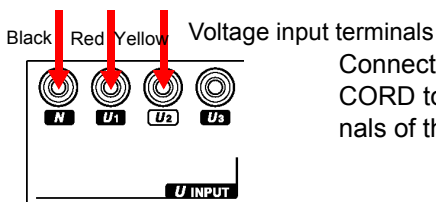

Connect the 9438-03 VOLTAGE CORD to the voltage input terminals of the 3169-20/21.

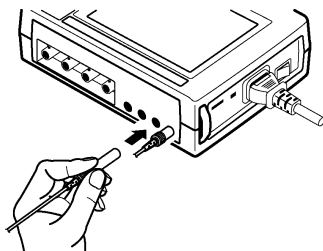

Insert plugs all the way in.

3. Connecting the Clamp-On Sensor



Connect the clamp-on sensors to the product first, and then to the active lines to be measured. Observe the following to avoid electric shock and short circuits.

- Clamp sensor should only be connected to the secondary side of a breaker, so the breaker can prevent an accident if a short circuit occurs. Connections should never be made to the primary side of a breaker, because unrestricted current flow could cause a serious accident if a short circuit occurs.
- When the clamp sensor is opened, do not allow the metal part of the clamp to touch any exposed metal, or to short between two lines, and do not use over bare conductors.
- To prevent damage to the product and sensor, never connect or disconnect a sensor while the power is on.
- The current input terminals of the 3169-20/21 are not insulated. To avoid the risk of electric shock, only use the specified optional clamp-on sensor.

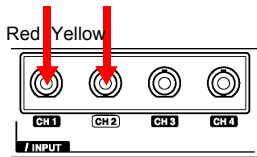

Current input terminas

Connect the 9661 CLAMP ON SENSOR to the current input terminals of the 3169-20/21.

3169-20/21 Current input terminal connector guide pins

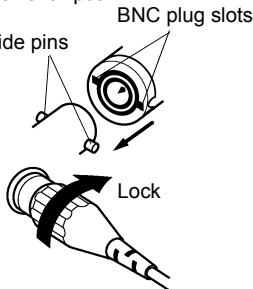

Align the slots in the BNC plug with the guide pins on the connector at the instrument side, then push and turn the plug clockwise. (to unplug the connector, push the plug and turn it counterclockwise before pulling it apart.)

NOTE

When disconnecting the BNC connector, be sure to release the lock before pulling the connectors apart. Forcibly pulling the connector without releasing the lock, or pulling on the cable, can damage the connector.

4. Inserting a PC Card



WARNING

Use only PC Cards sold by HIOKI. Compatibility and performance are not guaranteed for PC cards made by other manufacturers. You may be unable to read from or save data to such cards.



CAUTION

- The PC card or the instrument can be damaged if the card is inserted forcefully in the wrong direction.
- Never eject a PC card while it is being accessed by the instrument. Data on the PC card may be lost.

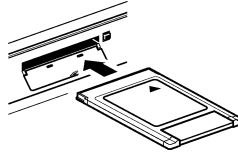

Open the cover and insert the PC card with the arrow facing up and in the direction of the PC card slot, as far as it will go.

❖ Instruction manual 7.2 "Using a PC Card" (page 117)

5. Turning the Power On



WARNING

Before turning the product on, make sure the source voltage matches that indicated on the product's power connector. Connection to an improper supply voltage may damage the product and present an electrical hazard.

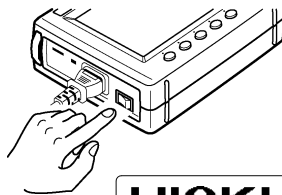

Turn the POWER switch ON (|).

As soon as the power is turned on, the self-test screen appears. Upon completion of the self test, display switches to the measurement screen.

Screen after the power is turned on (Self-test screen)

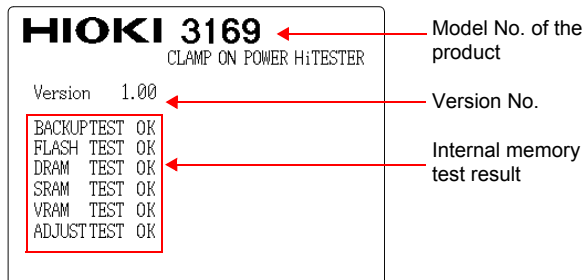

2.4 Connect to the Line to be Measured

1. Setting the wiring details

Set the 3169-20/21 to measure a three-phase 3-wire 200 V line (50 Hz, 50 A load) using the 9661 CLAMP ON SENSOR (500 A rated).

(1) Set the wiring to "3P3W2M."

SET UP



F5

NEXT
SCR

Press the **SET UP** key to display the setting screen.

Press the **F5** (NEXT SCR) key to display the measurement setting screen.

SET UP	1/5 MEASUREMENT	2002/06/19 15:34:41
WIRING	1P2W	×1
SAMPLING	PLL	50Hz
VAR METHOD	OFF	
AVERAGE TIMES	1	
VOLTAGE	U1	
RANGE	300 V	
VT(PT)	0001.00	
CURRENT	CH1	
RANGE	100 A	
CT	0001.00	
SENSOR	9661	
change		NEXT SCR

Move the cursor to "**WIRING.**"



F1

change

Press the **F1** (change) key to display the selection window.

SET UP	1/5 MEASUREMENT	2002/06/19 15:34:48
WIRING	1P2W	×1
SAMPLING	PLL	50Hz
VAR METHOD	OFF	
AVERAGE TIMES	1	
VOI1P2W	U1	
RA1P2W	300 V	
VT1P2W	0001.00	
CUR3P3W3M	CH1	
RA13P4W	00 A	
CT3P4W4I	.00	
SENSOR	9661	
select		cancel

Select "**3P3W2M**" (Three-phase 3-wire, 2-power-meter method) by using the cursor key.



F1

select

Press the **F1** (select) key.

(2) Make sure the number of circuits to be measured is set to "X1 (1 circuit)."

SET UP 1/5 MEASUREMENT		2002/05/19 15:35:11
WIRING	3P3W2M	X1
SAMPLING	PLL	50Hz
VAR METHOD	OFF	
AVERAGE TIMES	1	

When multiple circuits of the same voltage system (the same transformer) are to be measured, use a preset between X2 (2 circuits) and X4 (4 circuits).

1P2W	X1 (1 circuit), X2 (2 circuits), X3 (3 circuits), X4 (4 circuits)
1P3W	X1 (1 circuit), X2 (2 circuits)
3P3W2M	X1 (1 circuit), X2 (2 circuits)
3P3W3M,3P4W, 3P4W4I	X1 (1 circuit) only

(3) Make sure the synchronization method (sampling) is set to "PLL."

SET UP 1/5 MEASUREMENT		2002/05/19 15:35:13
WIRING	3P3W2M	x1
SAMPLING	PLL	50Hz
VAR METHOD	OFF	
AVERAGE TIMES	1	

(4) Make sure the frequency of the line to be measured is set to "50 Hz."

SET UP 1/5 MEASUREMENT		2002/05/19 15:35:24
WIRING	3P3W2M	x1
SAMPLING	PLL	50Hz
VAR METHOD	OFF	
AVERAGE TIMES	1	

(5) Make sure the reactive power-meter method is "OFF."

SET UP 1/5 MEASUREMENT		2002/05/19 15:35:28
WIRING	3P3W2M	x1
SAMPLING	PLL	50Hz
VAR METHOD	OFF	
AVERAGE TIMES	1	

2.4 Connect to the Line to be Measured

(5) Make sure the displayed data averaging times is set to "1."

SET UP	1/5 MEASUREMENT	2002/06/19 15:35:35
WIRING	3P3W2M x1	
SAMPLING	PLL 50Hz	
VAR METHOD	OFF	
AVERAGE TIMES	1	

(6) Set the voltage range to "300 V."

SET UP	1/5 MEASUREMENT	2002/06/19 15:38:04
WIRING	3P3W2M x1	
SAMPLING	PLL 50Hz	
VAR METHOD	OFF	
AVERAGE TIMES	1	
VOLTAGE	U12	
RANGE	300 V	
VT (PT)	0001.00	



Move the cursor to "**VOLTAGE RANGE.**"

Select "**300 V**" using the function keys.

(7) Make sure the VT (PT) ratio is set to "1."

SET UP	1/5 MEASUREMENT	2002/06/19 15:38:12
WIRING	3P3W2M x1	
SAMPLING	PLL 50Hz	
VAR METHOD	OFF	
AVERAGE TIMES	1	
VOLTAGE	U12	
RANGE	300 V	
VT (PT)	0001.00	

Set the VT (PT) ratio, if necessary.
(Example)

When the primary voltage is 6.6 kV and the secondary voltage is 110 V, the VT ratio is 60 (6600 V/110 V). In this case, as the rated measurement voltage is 110 V, set the voltage range to 150 V.

(8) Make sure "9661" is selected as the clamp-on sensor to be used.

RANGE	100 A
CT	0001.00
SENSOR	9661
change	
NEXT SCR	

(9) Set the current range to "50 A."

CURRENT	CH12
RANGE	50 A
CT	0001.00
SENSOR	9661
- +	
NEXT SCR	



Move the cursor to "CURRENT RANGE."

Select "50A" using the function keys.

NOTE

Selectable current ranges vary according to the clamp-on sensor used.

Clamp-On Sensor and Current Range:

9660, 9695-03	5 A, 10 A, 50 A, 100 A
9661	5 A, 10 A, 50 A, 100 A, 500 A
9667-5 kA (5000 A range)	5 kA
9667-500 A (500 A range)	500 A
9669	100 A, 200 A, 1 kA
9694	0.5 A, 1 A, 5 A
9695-02	0.5 A, 1 A, 5 A, 10 A, 50 A

(10) Make sure the CT ratio is set to "1."

CURRENT	CH12
RANGE	50 A
CT	0001.00
SENSOR	9661
- +	
NEXT SCR	

Set the CT ratio, if necessary.

(Example)

When the primary current is 100 A and the secondary current is 5 A, the CT ratio is 20 (100 A/5 A). In this case, as the rated measurement current is 5 A, set the current range to 5 A.

2. Displaying the Wiring Diagram

MEASURE



Press the **MEASURE** key to display the measurement screen.

F1

SCREEN



Press the **F1** (SCREEN) key to display the selection window.

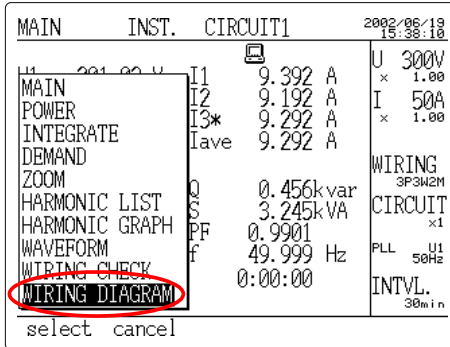

Move the cursor to "**WIRING DIAGRAM.**"

F1

select



Press the **F1** (select) key; the wiring diagram will appear.

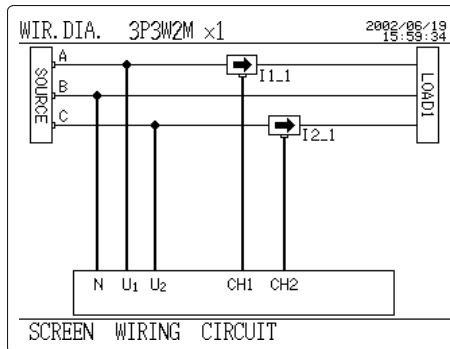

3. Connecting the voltage cords and clamp-on sensor to the line to be measured

Connect the 9438-03 voltage cords and the 9661 clamp-on sensor to the line to be measured, while referring to the wiring diagram. We recommend that the color of a voltage cord be matched to that of the attached input-cord label used for the same channel.

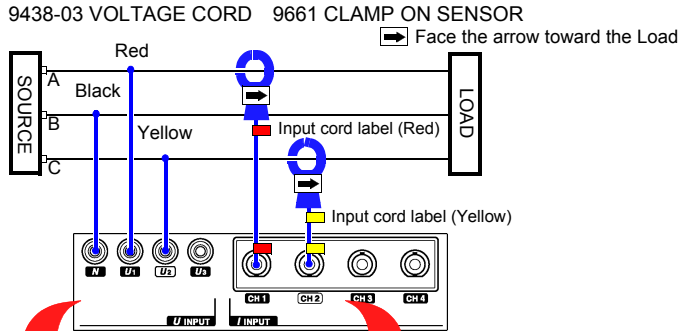

(Example)

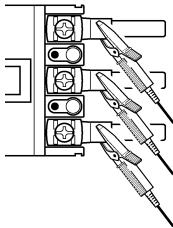

Clip securely to metal parts such as connection screws or bus bars at the power side.

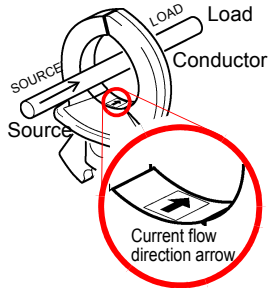

The arrows on the clamp indicating the direction of current flow should point toward the load side.

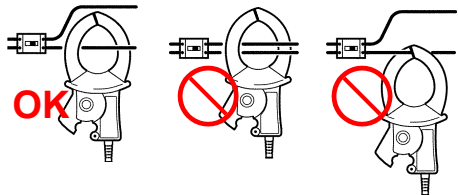

Clamp around only one conductor. Measurement is not possible if the clamp is placed around two lines in a single-phase circuit, or three lines in a three-phase circuit.

4. Checking the Wiring

MEASURE



Press the **MEASURE** key to display the measurement screen.

F1

SCREEN

Press the **F1** (SCREEN) key to display the selection window.

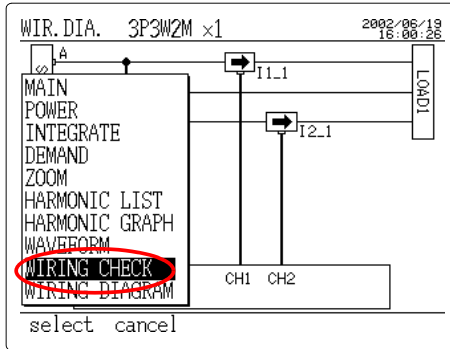

Move the cursor to "**WIRING CHECK.**"



F1

select

Press the **F1** (select) key.

The connection status is shown by the voltage, current vectors, and the connection check result.

If the wiring check result is not "**OK**," check the wiring.

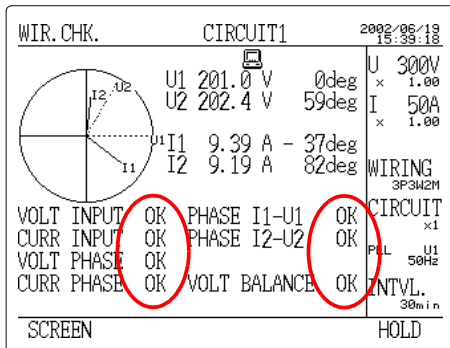

NOTE

The wiring check function may indicate improper connection ("NG") even when the actual wiring is correct, or vice versa. Check the vectors and measurement data as well.



The wiring check result is NG.

The voltage input is NG.	<ul style="list-style-type: none"> • Do the voltage clips grip the wires properly? • Is the voltage cord properly inserted into the voltage input terminal of the 3169-20/21?
The current input is NG.	<ul style="list-style-type: none"> • Is the clamp-on sensor securely inserted into the current input terminals? • Is the set current range too large for the input level?
The voltage phase is NG.	<ul style="list-style-type: none"> • Are the voltage cords connected to the correct terminals?
The current phase is NG.	<ul style="list-style-type: none"> • Does the arrow of the clamp-on sensor point to the load side? • Is the clamp-on sensor connected to the correct terminals?
The phase difference (I-U) is NG.	<ul style="list-style-type: none"> • Are the voltage cords and clamp-on sensor properly connected? • Does the arrow of the clamp-on sensor point to the load side? • Is the power factor of the line to be measured too low, such as 0.5 or less?
The voltage balance is NG.	<ul style="list-style-type: none"> • Does the connection method of the line to be measured differ from that set? • Do the voltage clips grip the wires properly? • Is the voltage cord properly inserted into the voltage input terminal?

2.5 Perform Measurement

1. Setting the measurement conditions

SET UP 2/5 DATA OUTPUT		2002/06/13 15:45:00
MEAS. START	TIME	2002/06/20 08:00
MEAS. STOP	TIME	2002/06/27 08:00
INTERVAL TIME	5 min	
SAVE IN...	PC CARD	
DATA FILE NAME	INTEG	
RS CONNECTION	PC	
DISPLAY COPY	PC CARD	
MANUAL TIME	JUST	NEXT SCR

DATA OUTPUT

- Measurement start: 2002/06/20 08:00
- Measurement stop: 2002/06/27 08:00
- Data is automatically output to the PC card at 5-minute intervals.
- Data file name: INTEG

SET UP 3/5 SAVE, PRINT ITEMS		2002/06/13 15:46:00
		NO. OF ITEMS 39
NORM. MEAS.	<input checked="" type="checkbox"/>	INST. OFF
		AVE. ON
HARMONIC	<input type="checkbox"/>	MAX. OFF
		MIN. OFF
INTEG. & DEM.		<input checked="" type="checkbox"/>
SAVE TIME AVAIL.	73d 18h 40m 0s	
OFF	ON	NEXT SCR

SAVE, PRINT ITEMS

Saves the average value (voltage, Current, and Power) and integrated power on a PC card

(1) Set the measurement start time to "2002/06/20 08:00."

Before setting the measurement start time, make sure the current date and time displayed on the screen are correct.

- ❖ Instruction manual 5.5.7 "Setting the Clock" (page 92)

SET UP



NEXT
SCR

Press the **SET UP** key to display the setting screen.

Press the **F5** (NEXT SCR) key to display the data-output setting screen.

SET UP 2/5 DATA OUTPUT		2002/06/13 15:46:00
MEAS. START	MANUAL	



Move the cursor to **"MEAS. START."**

SET UP 2/5 DATA OUTPUT	2002/06/19 15:48:33
MEAS. START	TIME 2002/06/20 08:00

F2 TIME

Press the **F2** (TIME) key.

MANUAL	Measurement starts when the START/STOP key is pressed (default setting).
TIME	Measurement starts at the time set by users.
JUST	Measurement will begin as soon as the internal clock reaches a time that is evenly divisible by the set interval.

❖ Instruction manual 5.3.1 "Setting the Time-Series Measurement Start Method" (page 69)



Move the cursor to the measurement start time.

Set the measurement start time to **"2002/06/20 08:00"** using the function keys. (Cursor **◀**: Moves left to next digit; Cursor **▶**: Moves right to next digit)

F1 -
F2 +

-	Decrements the number.
+	Increments the number.

NOTE

If **F3** (AUTO) key is pressed when the cursor is at the measurement start time, the start time will be set to a date and time close to the current time.

(2) Set the measurement stop time to "2002/06/27 08:00."

SET UP 2/5 DATA OUTPUT	2002/06/19 15:48:48
MEAS. START	TIME 2002/06/20 08:00
MEAS. STOP	MANUAL

Move the cursor to **"MEAS. STOP."**



F2 TIME

Press the **F2** (TIME) key.

MANUAL	Measurement stops when the START/STOP key is pressed (default setting).
TIME	Measurement stops at the time set by users.
TIMER	Measurement stops when the duration set by the users has elapsed. 1 second to 8784 hours



F1 -
F2 +

Move the cursor to the measurement stop time and set it to **"2002/06/27 08:00."**

2.5 Perform Measurement

(3) Set the interval time to "5 minutes."



Move the cursor to "INTERVAL TIME."

change Press the **F1** (change) key to display the selection window.

```

SET UP 2/5 DATA OUTPUT          2002/06/19
                                15:41:34
MEAS. START      TIME
                2002/06/20 08:00
MEAS. STOP       TIME
                2002/06/27 08:00
INT 1 min
   2 min
   5 min
   10 min
   15 min
   30 min
SAVE IN...       PC CARD
DATA FILE NAME
RS CONNECTION    PC
DISPLAY COPY     PC CARD
select cancel
  
```



select Press the **F1** (select) key.

Select "5 min" using the cursor key.

Storable Data According to Interval Setting

Interval setting	Normal measurement data	integrated power/demand measurement data	Harmonic measurement data
1/2/5/10/15/30/60 minutes	Yes	Yes	Yes
1/2/5/10/15/30 seconds	Yes	Yes	No
All wave/100/200/500 ms	Yes (Instantaneous values only) Binary data	No	No

(4) Make sure the medium for saving data to is set to "PC card."

```

INTERVAL TIME      5 min
SAVE IN...         PC CARD
DATA FILE NAME
RS CONNECTION      PC
DISPLAY COPY       PC CARD
CARD MEMORY
NEXT SCR
  
```

(5) Set the data output file name to "INTEG."

Move the cursor to **"DATA FILE NAME."**



change Press the **F1** (change) key to display the selection window.

SET UP	2/5 DATA OUTPUT	2002/06/19 15:43:57
MEAS. START	TIME	2002/06/20 08:00
MEAS. STOP	FILE NAME	[INTEG]
INTERVAL TIME	01234 56789	01/27 08:00
SAVE IN...	ABCDEFGHIJ	
DATA FILE NAME	KLMNO PQRST	
RS CONNECTION	UVWXY Z!#\$%	
DISPLAY COPY	&*()~@_-()	
	PC CARD	
input	BS	enter cancel



Enter **"INTEG"** using the cursor and **F1** (input) key. To make a correction, press the **F2** (BS) key. Pressing the **F2** key once will delete one letter.



input



BS



enter Press the **F3** (enter) key.

NOTE

- The file is saved as "INTEG.csv" on the PC card.
- If a filename is not specified or a file with the same name exists on the PC card, the file will automatically be named "69MEASXX" (XX: 00 to 99).

(6) Set the data output items

F5

**NEXT
SCR**

Press the **F5** (NEXT SCR) key to display the save/print items setting screen.

SET UP 3/5 SAVE, PRINT ITEMS		2002/06/19
NO. OF ITEMS		39
NORM. MEAS.	ON	FNST. OFF
		AVE. ON
HARMONIC	OFF	MAX. OFF
		MIN. OFF
INTEG. & DEM.	ON	
SAVE TIME AVAIL.	73d	18h 40m 0s
OFF ON		NEXT SCR

Annotations: Red boxes highlight '39' and '73d'. Red arrows point to '39' with text '256 or less' and to '73d' with text '7 days or more'.



F1

ON

Move the cursor to "**NORM. MEAS.**".

Press the **F1** (ON) key.

Turn ON "**AVE.**" and "**INTEG. & DEM.**" in a similar way. All other items shall be turned OFF.

NOTE

- Check the storable time. This indicates the length of time for which the currently installed PC card stores data. If the storable time is shorter than the measurement time (7 days), delete unnecessary files from the PC card or replace it with a larger-capacity PC card.
- If the number of output is greater or equal to 256, all of the data may not be read into common spreadsheet software.
- For details on settings for harmonics measurement-data output, see 5.4.4 "Setting Harmonic Measurement-data Output Items" (page 82) of the instruction manual.

2. Confirm range

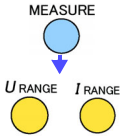

Press the **MEASURE** key to display the measurement screen.

Press the **U RANGE** key or **I RANGE** key to select an appropriate range.

NOTE

If you press the **I RANGE** Key, it selects a current range with a sufficient margin, in consideration of fluctuations in the load current of the line to be measured.

3. Start measurement

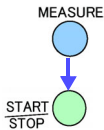

Press the **MEASURE** key to display the measurement screen.

Press the **START/STOP** key to place the 3169-20/21 in standby mode (LED blinking).

MAIN	INST.	CIRCUIT1	2002/06/20 07:55:43
WAITING			
U1	201.04 V	I1 9.392 A	U 300V x 1.00

The 3169-20/21 will automatically start measurement (LED remaining ON) at the measurement start time.

MAIN	INST.	CIRCUIT1	2002/06/20 08:00:06
RUNNING			
U1	201.03 V	T1 9.393 A	U 300V x 1.00

Switch Over to Another Screen.

F1 SCREEN

Press the **F1 (SCREEN)** key to display the selection window.

MAIN	INST.	CIRCUIT1	2002/06/20 08:00:22
RUNNING			
U1	201.00 V	I1 9.392 A	U 300V x 1.00
MAIN	I2 9.192 A	I 50A	
POWER	I3* 9.292 A	x 1.00	
INTEGRATE	Iave 9.292 A		
DEMAND			
ZOOM	Q 0.456kvar	WIRING	
HARMONIC LIST	S 3.245kVA	3P3W2M	
HARMONIC GRAPH	PF 0.9901	CIRCUIT	x1
WAVEFORM	f 50.002 Hz	PLL U1	50Hz
WIRING CHECK	0:00:22	INTVL.	Swi n
WIRING DIAGRAM			
select cancel			

Select a screen to be viewed using the cursor key.



F1 select

Press the **F1 (select)** key.

4. Stop measurement

The 3169-20/21 will automatically stop measurement at the stop time. The measurement data "INTEG.csv" has been saved on the PC card.

Interrupt Measurement.

START
STOP

Press the **START/STOP** key. The message "Do you want to stop the time-series measurement?" is displayed for you to confirm.

MAIN	INST.	CIRCUIT1	2002/06/20 08:00:34
RUNNING			
U1			U 300V x 1.00
U2			50A x 1.00
U3*			
Uave	201.66 V	Iave	9.292 A
P	3.213kW	Q	0.457kvar
		S	3.246kVA
		PF	0.9901
		f	49.998 Hz
WP+	0.0306kWh		0:00:34
			INTVL. 5min
yes		no	

F1 yes

Press the **F1** (yes) key.

NOTE

All measurement data before the interruption is saved on the PC card if the measurement is interrupted.

Shutdown Procedure

1. Disconnect the voltage cords and clamp-on sensor from the measured line.
2. Turn off the power to the 3169-20/21.
3. Disconnect the power cord from the AC outlet.
4. Remove the PC card from the 3169-20/21 and analyze the saved data on PC.

HIOKI 3169-20/21 CLAMP ON POWER HiTESTER
Quick Start Manual

Publication date: October 2003 Revised edition 2

Edited and published by HIOKI E.E. CORPORATION
Technical Support Section

All inquiries to International Sales and Marketing Department
81 Koizumi, Ueda, Nagano, 386-1192, Japan

TEL: +81-268-28-0562 / FAX: +81-268-28-0568

E-mail: os-com@hioki.co.jp

URL <http://www.hioki.co.jp/>

Printed in Japan 3169A983-02

-
-
- All reasonable care has been taken in the production of this manual, but if you find any points which are unclear or in error, please contact your supplier or the International Sales and Marketing Department at HIOKI headquarters.
 - In the interests of product development, the contents of this manual are subject to revision without prior notice.
 - Unauthorized reproduction or copying of this manual is prohibited.
-
-

HIOKI

HIOKI E. E. CORPORATION

HEAD OFFICE

81 Koizumi, Ueda, Nagano 386-1192, Japan

TEL +81-268-28-0562 / FAX +81-268-28-0568

E-mail: os-com@hioki.co.jp / URL <http://www.hioki.co.jp/>

HIOKI USA CORPORATION

6 Corporate Drive, Cranbury, NJ 08512, USA

TEL +1-609-409-9109 / FAX +1-609-409-9108

3169A983-02 03-10H



Printed on recycled paper