

# **HIOKI**

---

---

INSTRUCTION MANUAL

## **3273-50**

# **CLAMP ON PROBE**

HIOKI E. E. CORPORATION

---

---



# Contents

Introduction .....	i
Inspection .....	i
Notes on Safety .....	i
Precautions .....	v
Chapter 1 Overview .....	1
1.1 Product Overview .....	1
1.2 Features .....	1
1.3 Names of Parts .....	2
1.4 Parts of the Sensor .....	2
Chapter 2 Specifications .....	5
2.1 Product Specifications .....	5
2.2 Standards Applying .....	7
Chapter 3 Measurement Procedure .....	9
3.1 Notes on Use .....	9
3.2 Preparations for Measurement .....	13
3.3 Demagnetizing and Zero Adjustment .....	14
3.4 Measurement Procedure .....	17



---

## Introduction

Thank you for purchasing the HIOKI 3273-50 CLAMP ON PROBE. To obtain maximum performance from the device, please read this manual first, and keep it handy for future reference.

---

## Inspection

When you receive the device, inspect it carefully to ensure that no damage occurred during shipping. If damage is evident, or if it fails to operate according to the specifications, contact your dealer or Hioki representative.

### Supplied accessories

Instruction manual	1
Soft case	1

---





## Notes on Safety







**This device is designed to comply with IEC 61010 Safety Standards, and has been thoroughly tested for safety prior to shipment. However, mishandling during use could result in injury or death, as well as damage to the device. Be certain that you understand the instructions and precautions in the manual before use. We disclaim any responsibility for accidents or injuries not resulting directly from device defects.**

## Safety Symbols

This manual contains information and warnings essential for safe operation of the device and for maintaining it in safe operating condition. Before using the device, be sure to carefully read the following safety notes.

	<p>The  symbol printed on the device indicates that the user should refer to a corresponding topic in the manual (marked with the  symbol) before using the relevant function.</p> <p>In the manual, the  symbol indicates particularly important information that the user should read before using the device.</p>
	<p>Indicates that application around or removal from live lines is only permitted on condition that the lines are insulated.</p>

The following symbols in this manual indicate the relative importance of cautions and warnings.

	Indicates that incorrect operation presents an extreme hazard that could result in serious injury or death to the user.
	Indicates that incorrect operation presents a significant hazard that could result in serious injury or death to the user.
	Indicates that incorrect operation presents a possibility of injury to the user or damage to the device.
	Indicates advisory items related to performance or correct operation of the device.

## **Measurement categories (Overvoltage categories)**

This device conforms to the safety requirements for CAT I measurement instruments.

To ensure safe operation of measurement instruments, IEC 61010 establishes safety standards for various electrical environments, categorized as CAT I to CAT IV, and called measurement categories. These are defined as follows.

**CAT I** :Secondary electrical circuits connected to an AC electrical outlet through a transformer or similar device.

**CAT II** :Primary electrical circuits in equipment connected to an AC electrical outlet by a power cord (portable tools, household appliances, etc.)

**CAT III**:Primary electrical circuits of heavy equipment (fixed installations) connected directly to the distribution panel, and feeders from the distribution panel to outlets.

**CAT IV**:The circuit from the service drop to the service entrance, and to the power meter and primary overcurrent protection device (distribution panel).

Higher-numbered categories correspond to electrical environments with greater momentary energy, so a measurement instrument designed for CAT III environments can endure greater momentary energy than one designed for CAT II. Using a measurement instrument in an environment designated with a higher-numbered category than that for which the instrument is rated could result in a severe accident, and must be carefully avoided.

Never use a CAT I measuring instrument in CAT II, III, or IV environments.



The measurement categories comply with the Overvoltage Categories of the IEC60664 Standards.

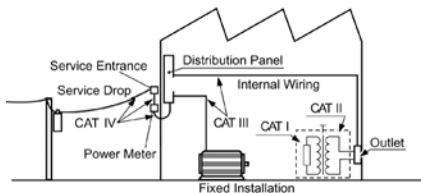

---

## Precautions

Follow these precautions to ensure safe operation and to obtain the full benefits of the various functions.

### **Preliminary Check**

Before using the device the first time, verify that it operates normally to ensure that no damage occurred during storage or shipping. If you find any damage, contact your dealer or Hioki representative.

**⚠ DANGER**

- To avoid short circuits and potentially life-threatening hazards, never attach the 3273-50 to a circuit that operates at more than 300V, or over bare conductors.
- When conductors being measured carry in excess of the safe voltage level (SELV-E) and not more than 300 V, to prevent short circuits and electric shock while the core section is open, make sure that conductors to be measured are insulated with material conforming to (1) Measurement Category, (2) Basic Insulation Requirements for Working Voltages of 300 V, and (3) Pollution Degree 2. For safeties sake, never use this sensor on bare conductors. The core and shield case are not insulated.

Un-insulated  
(core and  
shield case)

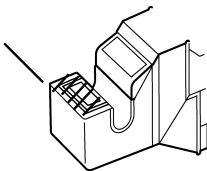

**⚠ DANGER**

- Be careful to avoid damaging the insulation surface while taking measurements.
- This instrument is made for use with the 3269 or 3272 POWER SUPPLY. It is possible to use a power supply other than the 3269 or 3272, provided that the connector and pin assignments match, and that voltage and other electrical specifications are satisfied. In the interest of safety, make sure that the power supply has a protective earthing with double-insulation construction.
- Make sure that the waveform measuring equipment connected to this device's output terminal (BNC) is equipped with a protective earthing with double-insulation construction.
- If the waveform measuring instrument being connected to the output terminal (BNC) on this device is equipped with any other measurement terminals, take the following precautions to ensure that the other instrument does not form a bridge between the probe and any hazardous live of a part.
  1. Isolate the terminal to which the probe is connected from other terminals on the measuring instrument using basic insulation conforming to the measurement category, working voltage, and pollution degree requirements of the circuit being tested.



2. If basic insulation requirements cannot be met between the terminal to which this device is connected and other terminals of the measuring instrument, make sure that the voltage input to the measurement terminal does not exceed the safe voltage level (SELV-E).
3. Read and observe all warnings and precautions relating to electrical safety for the measuring instrument being connected to the probe.

Refer to the following standards regarding the meanings of underlined terms.

IEC61010-1

IEC61010-031

IEC61010-2-032

**⚠ DANGER**

- Be sure to observe all operating precautions for the waveform monitoring instrument (oscilloscope or recorder) and other measurement instruments to which this device is connected.
- When using a measurement instrument that does not provide isolation between its input terminals and chassis or other input terminals, please pay attention to the following points. If a signal is applied to an input terminal other than that to which this device is connected, do not connect the ground-side terminal to any non-ground potential. Otherwise, short-circuit current will flow through the 3269 or 3272 or this device from the ground terminal, which could cause an electrical accident or damage.

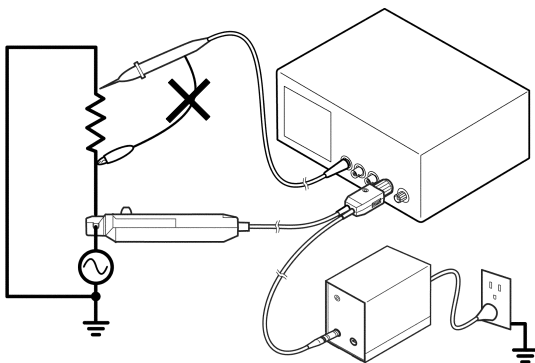

 **WARNING**

- **Do not allow the device to get wet, and do not take measurements with wet hands. This may cause an electric shock.**
- **To avoid electric shock when measuring live lines, wear appropriate protective gear, such as insulated rubber gloves, boots and a safety helmet.**

 **CAUTION**

- To avoid damage to the device, protect it from physical shock when transporting and handling. Be especially careful to avoid physical shock from dropping.
- This device should be installed and operated indoors only, between 0 and 40°C (32 to 104°F) and 80% RH or less.
- Do not store or use the device where it could be exposed to direct sunlight, high temperature or humidity, or condensation. Under such conditions, the device may be damaged and insulation may deteriorate so that it no longer meets specifications.
- This device is not designed to be entirely water- or dust-proof. To avoid damage, do not use it in a wet or dusty environment.

**Precautions**

 **CAUTION**

- The sensor head is a precision assembly including a molded component, a ferrite core, and a Hall effect element. It may be damaged if subjected to sudden changes in ambient temperature, or mechanical strain or shock, and therefore great care should be exercised in handling it.
- The matching surfaces of the sensor head are precisely ground, and should be treated with care. If these surfaces are scratched, performance may be impaired.
- Measurements are degraded by dirt on the mating surfaces of the sensor head, so keep the surfaces clean by gently wiping with a soft cloth.
- To avoid damaging the sensor cables, do not bend or pull the sensor cable and power supply cable.
- To clean the device, wipe it gently with a soft cloth moistened with water or mild detergent. Never use solvents such as benzene, alcohol, acetone, ether, ketones, thinners or gasoline, as they can deform and discolor the case.
- When the power is on, keep the core section of the sensor closed, except when clamping them onto the conductor to be measured. The facing surface of the core section can be scratched while it is open.
- Keep the clamp jaws and core slits free from foreign objects, which could interfere with clamping action.

**⚠ CAUTION**

- Keep the sensor head closed when not in use, to avoid accumulating dust or dirt on the mating core surfaces, which could interfere with clamp performance.
- Avoid stepping on or pinching the cable, which could damage the cable insulation.
- Keep the cables well away from heat sources, as bare conductors could be exposed if the insulation melts.
- The maximum continuous measured current should be limited to 15 A when using the Hioki Model 8940 F/V Unit with the Memory HiCorder. Because the 8940 F/V Unit is not designed for measuring higher current, measurements may be incorrect or the 8940 F/V Unit may be damaged.

**NOTE**

Correct measurement may be impossible in the presence of strong magnetic fields, such as near transformers and high-current conductors, or in the presence of strong electromagnetic fields such as near radio transmitters.

**Service**

When sending the device for repair, carefully to prevent damage in transit. Include cushioning material so the instrument cannot move within the package. Be sure to include details of the problem. Hioki cannot be responsible for damage that occurs during shipment.



---

# Chapter 1

## Overview

---

---

### 1.1 Product Overview

This device can be directly connected to a BNC input connector of a waveform measuring instrument such as an oscilloscope or recorder, and by clamping on a conductor to be measured, allows the current waveform to be easily captured.

---

### 1.2 Features

- Highly accurate current detection
- Easy current measurement
- Broadband frequency characteristics DC to 50 MHz
- Compact and permits measurement of low current levels
- Easy protect function at excessive input
- Unique HIOKI development of thin film Hall effect element

## 1.3 Names of Parts

### External view

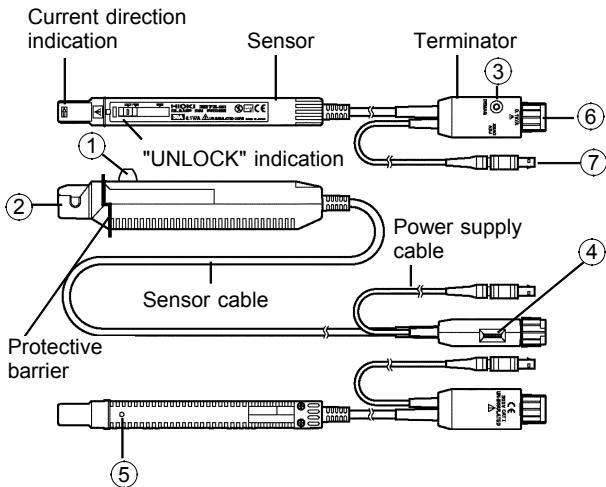

## 1.4 Parts of the Sensor

### ① Opening lever

Operating lever for opening the sensor head. Always use this lever to open the sensor head.

### ② Sensor head

This clamps the conductor being measured, and carries out the actual current measurement. It is a precision assembly including a molded component, a ferrite core, and a Hall effect element. It may be damaged if subjected to sudden changes in ambient temperature, or mechanical strain or shock, and therefore great care should be exercised in handling it.

③ Demagnetizing switch (DEMAG)

This demagnetizes the core if it has been magnetized by switching the power on and off, or by an excessive input. Always carry out demagnetizing before measurement.

The demagnetizing process takes about one second. During demagnetizing, a demagnetizing waveform is output.

④ Zero adjustment dial (ZERO ADJ)

Use the zero adjustment dial to correct for the effect of a voltage offset or temperature drift on the device. When beginning measurement, after demagnetizing always carry out zero adjustment.

⑤ Coarse adjustment trimmer

Use this only when adjustment is not possible within the range of the zero adjustment dial. Use a nonconductive screwdriver (e.g. ceramic driver) for adjustment.

⑥ Output connector

The current waveform of the measured conductor is output at a constant rate (0.1 V/A).

Connect to the BNC input connector of the waveform measuring instrument.

**NOTE**

- The output of this device is terminated internally. Use a high-impedance input to the measuring instrument. With an input impedance of 50  $\Omega$ , accurate measurement is not possible.
- If using BNC-banana plug adapters or similar to connect to input terminals other than BNC connectors, make sure the polarity is correct.
- Turn the collar until it clicks, and check that it is locked securely.

**⑦ Power plug**

Connect this to the 3269 or 3272 POWER SUPPLY receptacle to supply power to the sensor terminator.



**DANGER**

**To avoid electric shock, do not touch the portion beyond the protective barrier during use.**

# Chapter 2

## Specifications

### 2.1 Product Specifications

Accuracy is guaranteed at  $23^{\circ}\text{C} \pm 5^{\circ}\text{C}$  ( $73^{\circ}\text{F} \pm 9^{\circ}\text{F}$ ) after the power has been on for 30 minutes.

Frequency range	DC to 50 MHz (-3 dB) (Characteristics shown in Fig. 1)
Rise time	7 ns or less
Maximum continuous input range	30 Arms (Derating according to frequency shown in Fig. 2)
Maximum peak current value	Non-continuous 50 Apeak
Output voltage rate	0.1 V/A
Amplitude accuracy	$\pm 1.0\%$ rdg. $\pm 1$ mV ; up to 30 Arms $\pm 2.0\%$ rdg. ; over 30 Arms to 50 Apeak (DC, and 45 to 66 Hz, input within continuous maximum input range)
Noise	Equivalent to 2.5 mArms or less (for 20 MHz band measuring instrument)
Input impedance	(Characteristics shown in Fig.3)
Temperature coefficient for sensitivity	$\pm 2\%$ or less (During input of 50 Hz 30 Arms within range of $0$ to $40^{\circ}\text{C}$ ( $32$ to $104^{\circ}\text{F}$ ))

Maximum rated power	5.6 VA
Rated supply voltage	$\pm 12 \text{ V} \pm 0.5 \text{ V}$
Operating temperature and humidity range	0 to 40°C (32 to 104°F), 80 % RH or less (no condensation)
Storage temperature and humidity range	-10 to 50 °C (14 to 122°F), 80 % RH or less (no condensation)
Location for use	Indoor, altitude up to 2000 m (6562 feet)
Effect of external magnetic fields	Equivalent to a maximum of 20 mA (DC and 60 Hz, Magnetic field of 400 A/m)
Maximum rated voltage	300 V, CAT (insulated conductor)
Diameter of measurable conductors	5 mm dia. 0.2" dia.
Guaranteed accuracy period	1 year (Opening/closing up to 10,000 times)
Cable lengths	Sensor cable Approx. 1.5 m (59.0") Power supply cable Approx. 1 m (39.4")
External dimensions	Sensor Approx. 175W × 18H × 40Dmm Approx. 6.89"W × 0.71"H × 1.58"D (excluding protrusions) Terminator Approx. 27H × 55W × 18D mm Approx. 1.06"W × 2.17"H × 0.71"D

Mass	Approx. 230 g Approx. 8.1 oz.
Accessories	Instruction manual, Soft case

## 2.2 Standards Applying

Safety	EN61010-2-032:2002 Measurement category (anticipated transient overvoltage 1500 V), Pollution Degree 2
EMC	EN61326:1997+A1:1998+A2:2001+A3:2003

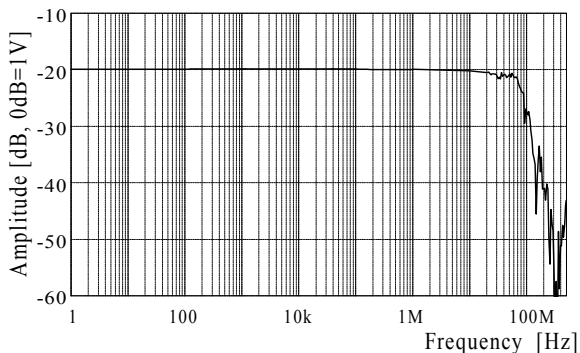

Fig.1 Frequency characteristics(Typical characteristics)

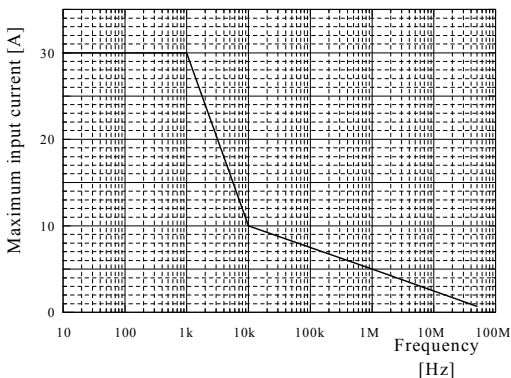

Fig.2 Derating according to frequency

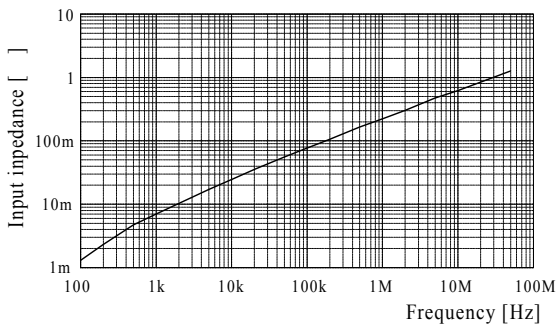

Fig.3 Input impedance (Typical characteristics)





---

## Chapter 3

# Measurement Procedure

---

---

### 3.1 Notes on Use

**⚠ DANGER**

- To avoid short circuits and potentially life-threatening hazards, never attach the 3273-50 to a circuit that operates at more than 300V, or over bare conductors.
- When conductors being measured carry in excess of the safe voltage level (SELV-E) and not more than 300 V, to prevent short circuits and electric shock while the core section is open, make sure that conductors to be measured are insulated with material conforming to (1) Measurement Category , (2) Basic Insulation Requirements for Working Voltages of 300 V, and (3) Pollution Degree 2. For safeties sake, never use this sensor on bare conductors. The core and shield case are not insulated.
- Be careful to avoid damaging the insulation surface while taking measurements.

**⚠ DANGER**

- This instrument is made for use with the 3269 or 3272 POWER SUPPLY. It is possible to use a power supply other than the 3269 or 3272, provided that the connector and pin assignments match, and that voltage and other electrical specifications are satisfied. In the interest of safety, make sure that the power supply has a protective earthing with double-insulation construction.
- Make sure that the waveform measuring equipment connected to this device's output terminal (BNC) is equipped with a protective earthing with double-insulation construction.
- If the waveform measuring instrument being connected to the output terminal (BNC) on this device is equipped with any other measurement terminals, take the following precautions to ensure that the other instrument does not form a bridge between the probe and any hazardous live of a part.
  1. Isolate the terminal to which the probe is connected from other terminals on the measuring instrument using basic insulation conforming to the measurement category, working voltage, and pollution degree requirements of the circuit being tested.



2. If basic insulation requirements cannot be met between the terminal to which this device is connected and other terminals of the measuring instrument, make sure that the voltage input to the measurement terminal does not exceed the safe voltage level (SELV-E).
3. Read and observe all warnings and precautions relating to electrical safety for the measuring instrument being connected to the probe.

Refer to the following standards regarding the meanings of underlined terms.

IEC61010-1

IEC61010-031

IEC61010-2-032

**⚠ DANGER**

- Be sure to observe all operating precautions for the waveform monitoring instrument (oscilloscope or recorder) and other measurement instruments to which this device is connected
- When using a measurement instrument that does not provide isolation between its input terminals and chassis or other input terminals, please pay attention to the following points. If a signal is applied to an input terminal other than that to which this device is connected, do not connect the ground-side terminal to any non-ground potential. Otherwise, short-circuit current will flow through the 3269 or 3272 or this device from the ground terminal, which could cause an electrical accident or damage.

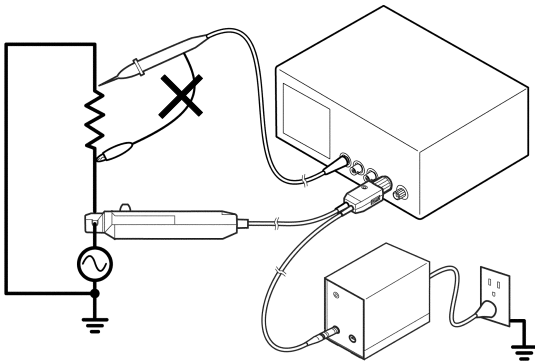

---

## 3.2 Preparations for Measurement

- (1) Have the 3269 or 3272 POWER SUPPLY, and oscilloscope or recorder for waveform measurement ready.

 CAUTION

- Before turning on the power, make sure that the voltage of the power supply being used matches the supply voltage indicated on the rear panel of the 3269 or 3272.
- The maximum continuous measured current should be limited to 15 A when using the Hioki Model 8940 F/V Unit with the Memory HiCorder. Because the 8940 F/V Unit is not designed for measuring higher current, measurements may be incorrect or the 8940 F/V Unit may be damaged.

**NOTE**

The output of this device is terminated internally. Use a high-impedance input to the measuring instrument. With an input impedance of 50  $\Omega$ , accurate measurement is not possible.

- (2) Turn the power switch off and connect the power cord.

- (3) Connect the power plug of the 3273-50 to the power receptacle of the 3269 or 3272.

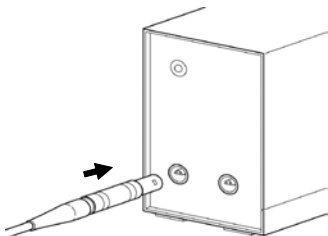

- (4) Turn the 3269 or 3272 power switch on, and check that the front panel power indicator lights.

---

### 3.3 Demagnetizing and Zero Adjustment

- (1) With the waveform measurement instrument input at ground, adjust the trace to the zero position.
- (2) Set the input coupling of the waveform measurement instrument to DC.

- (3) Connect the output connector of the 3273-50 to the input connector of the waveform measurement instrument. Turn the collar until it clicks, and check that it is locked securely.

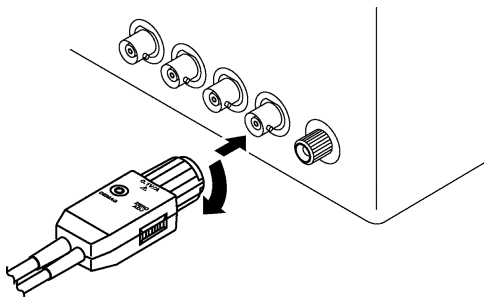

**CAUTION**

- When disconnecting the output connector, be sure to release the lock before pulling off the connector. Forcibly pulling the connector without releasing the lock, or pulling on the cable, can damage the terminator.
- If using BNC-banana plug adapters or similar to connect to input terminals other than BNC connectors, make sure the polarity is correct.

**⚠ CAUTION**

- Do not demagnetize while the 3273-50 is clamping a conductor to be measured. Demagnetizing causes current to flow into the conductor, which may damage parts in the circuit to be measured.

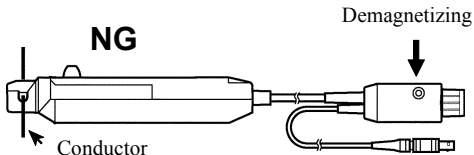

- Check that the conductor being measured is not clamped when supplying power to the 3273-50 for the same reason. Demagnetized waveforms are generated when supplying electric power.

- (4) Without clamping the conductor to be measured, press the opening lever until the "UNLOCK" indication disappears, and check that the sensor head is properly closed.
- (5) Press the demagnetizing switch (DEMAG) on the terminator.
- (6) Turn the zero adjustment dial on the terminator, to adjust the trace to the zero position.
- (7) If zero adjustment is not possible in step 6, turn the coarse adjustment trimmer to bring the trace within the range of adjustment by the zero adjustment dial.



## 3.4 Measurement Procedure

- (1) Check that the system is safe, and that the preparations described in the preceding section have been carried out.
- (2) Pull the sensor opening lever, so that the sensor head opens.

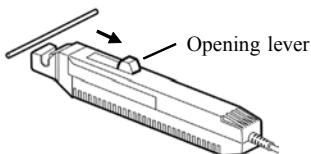

- (3) Align the sensor so that the current direction indication corresponds to the direction of current flow through the conductor to be measured, and clamp so that the conductor is in the center of the sensor aperture.
- (4) Press the opening lever on the sensor head until the "UNLOCK" indication disappears, and check that the opening lever is firmly locked and the sensor head securely closed.

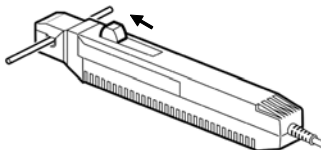

- (5) It is now possible to monitor the current waveform. The output rate of the 3273-50 is 0.1 V/A. The current sensitivity can be derived from the voltage sensitivity of the waveform measurement instrument. For example, if the voltage sensitivity is 10 mV/division, the current sensitivity is 100 mA/division.

**NOTE**

- When using the 3273-50, note that two clamp-on probes may not be used simultaneously with the 3272 POWER SUPPLY, depending on the current to be measured.
- The current consumption of clamp-on probes depends on the current to be measured. Confirm that the total current consumption of the clamp-on probes does not exceed the rated output current of the 3272. See Fig. 1.

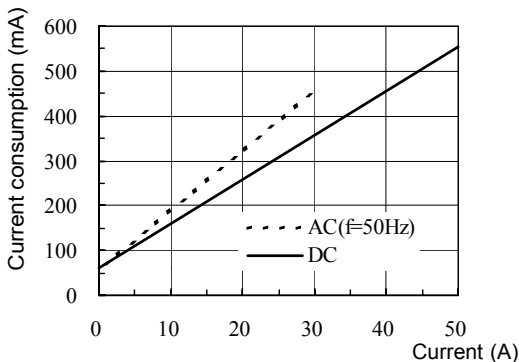

Fig.1

Current consumption\* vs. current to be measured(typical)

\*The sum total of a positive and negative current consumption

**⚠ CAUTION**

- The maximum continuous input range is based on heat that is internally generated during measurement. Never input current in excess of this level. Exceeding the rated level may result in damage to the probe.
- The maximum continuous input range varies according to the frequency of the current being measured. See the figures in 2.1, "Product Specifications"
- If excess current is input, generated heat activates a built-in safety function that blocks normal output. If this happens, remove the input immediately (remove the sensor from the conductor being measured, or reduce the input current to zero). Wait until the sensor has had sufficient time to cool before resuming operation.
- Even if the input current does not exceed the rated continuous maximum, continuous input for an extended period of time may result in activation of the safety circuit to prevent damage resulting from heating of the sensor.
- The maximum continuous measured current should be limited to 15 A when using the Hioki Model 8940 F/V Unit with the Memory HiCorder. Because the 8940 F/V Unit is not designed for measuring higher current, measurements may be incorrect or the 8940 F/V Unit may be damaged.

**CAUTION**

- At high ambient temperatures, the built-in safety circuit may activate at current input levels below the rated continuous maximum.
- Continuous input of current exceeding the rated maximum or repeated safety circuit activation will degrade performance of the safety circuit, possibly resulting in damage to the device.
- The maximum input range is indicated by the continuous maximum input range. It is also indicated by another product specification  
Maximum peak current: Noncontinuous 50 A peak. This means that the upper limit of the waveform response is 50 A peak. Make sure that the input does not exceed the continuous maximum input range in rms.
- When opening the sensor head of the probe, be sure to operate with the opening lever. If an upper core is forced to open, when the sensor head is locked, the open-close mechanism can be damaged.

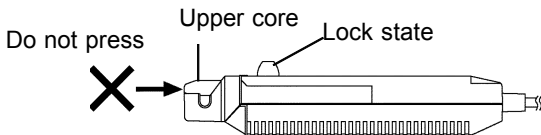

**NOTE**

- The output of this device is terminated internally. Use a waveform measurement instrument with an input impedance of at least 1 M $\Omega$ .

**NOTE**

- Immediately after powering on, this device may be subject to an appreciable offset drift due to the effect of self-heating. To counteract this, allow the device to warm up for about 30 minutes before carrying out measurement.
- When performing continuous measurements, it is necessary to be aware that the offset voltage drifts, depending on factors such as the ambient temperature.
- Under certain circumstances, oscillation may occur if the probe is connected to the 3269 or 3272 POWER SUPPLY while the power supply is on. This does not indicate a malfunction. Oscillation can be stopped and operation restored to normal by opening and closing the sensor head.
- Depending on the measured current frequency, however some sound may be produced by resonance, it has no effect on measurements.
- The measurement may be affected by the position within the clamp aperture of the conductor being measured. The conductor should be in the center of the clamp aperture
- When carrying out measurement, press the opening lever until the "UNLOCK" indication disappears, and check that the sensor head is properly closed. If the sensor head is not properly closed, accurate measurement will not be possible.

**NOTE**

- At high frequencies, common mode noise may affect measurements taken on the high voltage side of circuits. If this occurs, reduce the frequency range of the waveform measuring instrument, or clamp onto the low-voltage side of the circuit, as appropriate.

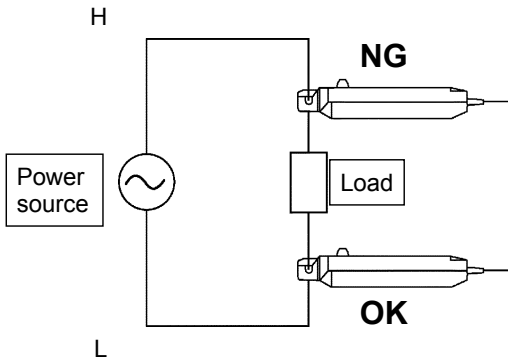

- Accurate measurement may be impossible in locations subject to strong external magnetic fields, such as transformers and high-current conductors, or in locations subject to strong external electric fields, such as radio transmission equipment.

**HIOKI**

**DECLARATION OF CONFORMITY**

Manufacturer's Name: HIOKI E.E. CORPORATION  
Manufacturer's Address: 81 Koizumi, Ueda, Nagano 386-1192, Japan  
Product Name: CLAMP ON PROBE  
Model Number: 3273-50

The above mentioned product conforms to the following product specifications:

Safety: EN61010-2-032:2002  
EMC: EN61326:1997+A1:1998+A2:2001+A3:2003  
Class B equipment  
Minimum immunity test requirement

Supplementary Information:

The product herewith complies with the requirements of the Low Voltage Directive 73/23/EEC and the EMC Directive 89/336/EEC.

HIOKI E.E. CORPORATION

15 September 2006

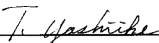
  
\_\_\_\_\_  
Tatsuyoshi Yoshiike  
President

3273B999-01





HIOKI 3273-50 CLAMP ON PROBE  
Instruction Manual

Publication date: September 2006 Revised edition 1  
Edited and published by HIOKI E.E. CORPORATION  
Technical Support Section

All inquiries to International Sales and Marketing Department

81 Koizumi, Ueda, Nagano, 386-1192, Japan

TEL: +81-268-28-0562 / FAX: +81-268-28-0568

E-mail: [os-com@hioki.co.jp](mailto:os-com@hioki.co.jp)

URL <http://www.hioki.co.jp/>

Printed in Japan 3273B981-01

- 
- 
- All reasonable care has been taken in the production of this manual, but if you find any points which are unclear or in error, please contact your supplier or the International Sales and Marketing Department at HIOKI headquarters.
  - In the interests of product development, the contents of this manual are subject to revision without prior notice.
  - Unauthorized reproduction or copying of this manual is prohibited.
- 
-

# HIOKI

---

HIOKI E. E. CORPORATION

## HEAD OFFICE

81 Koizumi, Ueda, Nagano 386-1192, Japan  
TEL +81-268-28-0562 / FAX +81-268-28-0568  
E-mail: [os-com@hioki.co.jp](mailto:os-com@hioki.co.jp)  
URL <http://www.hioki.co.jp/>

## HIOKI USA CORPORATION

6 Corporate Drive, Cranbury, NJ 08512, USA  
TEL +1-609-409-9109 / FAX +1-609-409-9108

---

3273B981-01 06-09H



Printed on recycled paper

---