

HIOKI

INSTRUCTION MANUAL

3275

CLAMP ON PROBE

HIOKI E. E. CORPORATION

Contents

Introduction	1
Inspection	1
Notes on Safety	1
Notes on Use	4
Chapter 1 Overview	9
1.1 Product Overview	9
1.2 Features	9
1.3 Names of Parts	10
1.4 Parts of the Sensor	11
Chapter 2 Specifications	13
2.1 Product Specifications	13
2.2 Standards Applying	14
Chapter 3 Measurement Procedure	17
3.1 Notes on Use	17
3.2 Preparations for Measurement	20
3.3 Demagnetizing and Zero Adjustment	21
3.4 Measurement Procedure	22

Introduction

Thank you for purchasing this HIOKI 3275 CLAMP ON PROBE. To obtain maximum performance from the device, please read this manual first, and keep it handy for future reference.

Inspection

When you receive the device, inspect it carefully to ensure that no damage occurred during shipping. If damage is evident, or if it fails to operate according to the specifications, contact your dealer or Hioki representative.

Supplied accessories

Instruction manual	1
Carrying case	1





Notes on Safety

**WARNING**





This device is designed to comply with IEC 61010 Safety Standards, and has been thoroughly tested for safety prior to shipment. However, mishandling during use could result in injury or death, as well as damage to the device. Be certain that you understand the instructions and precautions in the manual before use. We disclaim any responsibility for accidents or injuries not resulting directly from device defects.

Safety Symbols

This manual contains information and warnings essential for safe operation of the device and for maintaining it in safe operating condition. Before using the device, be sure to carefully read the following safety notes.

	<ul style="list-style-type: none"> • The  symbol printed on the device indicates that the user should refer to a corresponding topic in the manual (marked with the  symbol) before using the relevant function. • In the manual, the  symbol indicates particularly important information that the user should read before using the device.
	<ul style="list-style-type: none"> • Wear appropriate protective insulation (insulating rubber gloves and boots, helmet and etc.) when connecting and disconnecting from live electric circuits.

The following symbols in this manual indicate the relative importance of cautions and warnings.

	<p>Indicates that incorrect operation presents an extreme hazard that could result in serious injury or death to the user.</p>
	<p>Indicates that incorrect operation presents a significant hazard that could result in serious injury or death to the user.</p>
	<p>Indicates that incorrect operation presents a possibility of injury to the user or damage to the device.</p>
	<p>Indicates advisory items related to performance or correct operation of the device.</p>

Measurement categories (Overvoltage categories)

This device conforms to the safety requirements for CAT II (600V), CAT III (300V) measurement instruments.

To ensure safe operation of measurement devices, IEC 61010 establishes safety standards for various electrical environments, categorized as CAT I to CAT IV, and called measurement categories. These are defined as follows.

CAT I: Secondary electrical circuits that are connected to a wall outlet through a transformer or similar instrument.

CAT II: Primary electrical circuits in equipment connected to a wall outlet via a power cord (portable tools, household appliances, etc.)

CAT III: Primary electrical circuits of heavy equipment (fixed installations) connected directly to the distribution panel, and feeders between the distribution panel and outlets.

CAT IV: The circuit from the service drop to the service entrance, then to the power meter and to the primary overcurrent protection instrument.

Higher-numbered categories correspond to electrical environments with greater momentary energy. So a measurement device designed for CAT III environments can endure greater momentary energy than a device designed for CAT II.

Using a measurement device in an environment designated with a higher-numbered category than that for which the device is rated could result in a severe accident, and must be carefully avoided.

Never use a CAT I measuring device in CAT II, III, or IV environments.

The measurement categories comply with the Overvoltage Categories of the IEC60664 Standards.

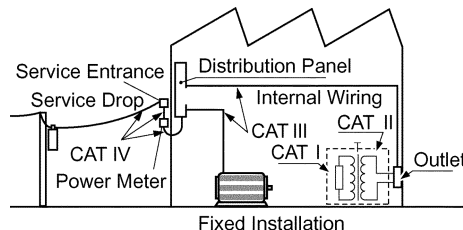



Notes on Use

Follow these precautions to ensure safe operation and to obtain the full benefits of the various functions.



To avoid short circuits and potentially life-threatening hazards, follow these precautions.

- **Never attach the clamp to a circuit that operates at more than the maximum rated voltage to earth.**
 - **For safety's sake, avoid clamping around bare conductors, while clamping or measuring.**
 - **While clamping and measuring, do not touch the clamp in front of the barrier or the conductor being measured.**
 - **Be careful to avoid damaging the insulation surface while taking measurements.**
 - **This device is made for use with the 3269 or 3272 POWER SUPPLY. It is possible to use a power supply other than the 3269 or 3272, provided that the connector and pin assignments match, and that voltage and other electrical specifications are satisfied. In the interest of safety, make sure that the power supply has a protective earthing with double-insulation construction.**
 - **Make sure that the waveform measuring equipment connected to this device's output terminal (BNC) is equipped with a protective earthing with double-insulation construction.**
-



- If the waveform measuring instrument being connected to the output terminal (BNC) on this device is equipped with any other measurement terminals, take the following precautions to ensure that the other instrument does not form a bridge between the probe and any hazardous live of a part.

1. Isolate the terminal to which the probe is connected from other terminals on the measuring instrument using basic insulation conforming to the measurement category, working voltage, and pollution degree requirements of the circuit being tested.
2. If basic insulation requirements cannot be met between the terminal to which this device is connected and other terminals of the measuring instrument, make sure that the voltage input to the measurement terminal does not exceed the Separated Extra-Low Voltage Earthed (SELV-E).
3. Read and observe all warnings and precautions relating to electrical safety for the measuring instrument being connected to the probe.

Refer to the following standards regarding the meanings of underlined terms.

IEC 61010-1

IEC 61010-031

IEC 61010-2-032

DANGER

- Be sure to observe all operating precautions for the waveform monitoring instrument (oscilloscope or recorder) and other measurement instruments to which this device is connected
- When using a measurement instrument that does not provide isolation between its input terminals and chassis or other input terminals, please pay attention to the following points.

If a signal is applied to an input terminal other than that to which this device is connected, do not connect the ground-side terminal to any non-ground potential. Otherwise, short-circuit current will flow through the 3269 or 3272, or this device from the ground terminal, which could cause an electrical accident or damage.

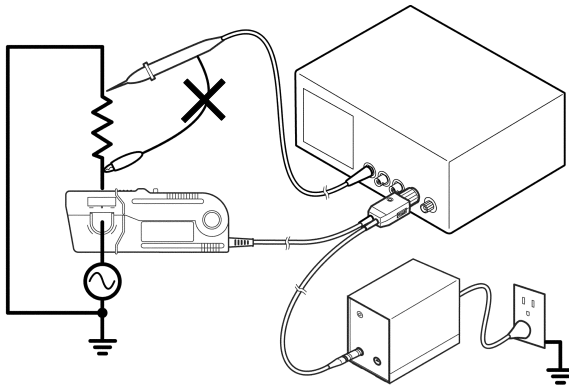
**WARNING**

- Do not allow the device to get wet, and do not take measurements with wet hands. This may cause an electric shock.

 **CAUTION**

- To avoid damage to the device, protect it from vibration or shock during transport and handling, and be especially careful to avoid dropping.
- Do not store or use the device where it could be exposed to direct sunlight, high temperature, humidity, or condensation. Under such conditions, the device may be damaged and insulation may deteriorate so that it no longer meets specifications.
- Before using the device the first time, verify that it operates normally to ensure that no damage occurred during storage or shipping. If you find any damage, contact your dealer or Hioki representative.
- This device is not designed to be entirely water- or dust- proof. To avoid damage, do not use it in a wet or dusty environment.
- The sensor head is a precision assembly including a molded component, a ferrite core, and a Hall effect element. It may be damaged if subjected to sudden changes in ambient temperature, or mechanical strain or shock, and therefore great care should be exercised in handling it.
- The matching surfaces of the sensor head are precision ground, and should be treated with care. If these surfaces are scratched, performance may be impaired.
- Foreign substances such as dust on the contact surfaces of the sensor head can cause acoustic resonance and degrade measurement, so it should be cleaned by gently wiping with a soft cloth.
- To avoid damaging the sensor cable and power supply cable, do not bend or pull the cables.

CAUTION

- When the power is on, keep closed, except when clamping them onto the conductor to be measured. The facing surface of the core section can be scratched while it is open.

NOTE

- Correct measurement may be impossible in the presence of strong magnetic fields, such as near transformers and high-current conductors, or in the presence of strong electromagnetic fields such as near radio transmitters.

Service / Maintenance

- To clean the device, wipe it gently with a soft cloth moistened with water or mild detergent. Never use solvents such as benzene, alcohol, acetone, ether, ketones, thinners or gasoline, as they can deform and discolor the case.
 - If the device seems to be malfunctioning, contact your dealer or Hioki representative.
 - When sending the device for repair, pack carefully to prevent damage in transit. Include cushioning material so the device cannot move within the package. Be sure to include details of the problem.
 - Hioki cannot be responsible for damage that occurs during shipment.
-

Chapter 1

Overview

1.1 Product Overview

This device can be directly connected to a BNC input connector of a waveform measuring instrument such as an oscilloscope or recorder, and by clamping on a conductor to be measured, allows the current waveform to be easily captured.

1.2 Features

- Highly accurate current detection.
- Easy current measurement.
- Broadband frequency characteristics DC to 2 MHz.
- Large diameter allows high-current measurements.
- Easy protection function to avoid self-heating during excessive input.
- Unique HIOKI development of thin film Hall effect element

1.3 Names of Parts

External view

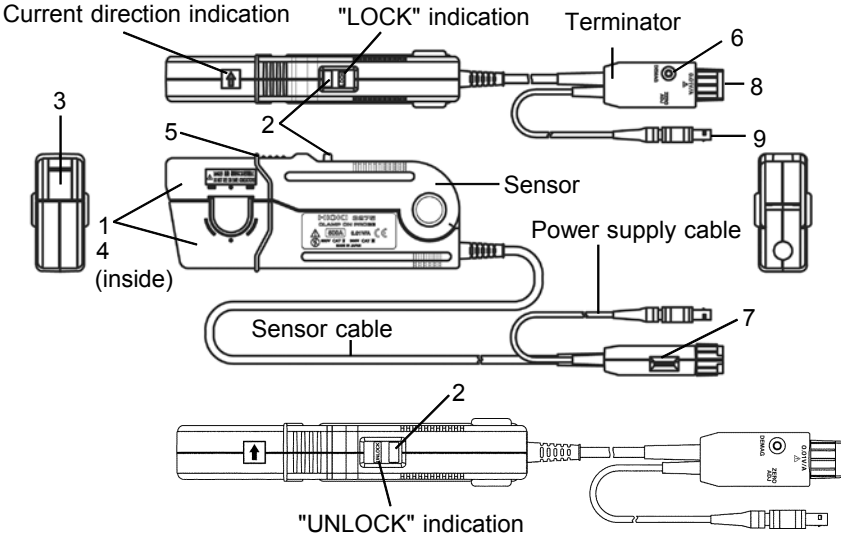

1.4 Parts of the Sensor

1. Clamp

This clamps around the conductor to be measured.

2. Slider

This slider opens the clamp. Always use it to open and close the clamp.

3. Lever

This lock mechanism keeps the clamp closed.

4. Sensor head

This clamps the conductor being measured, and carries out the actual current measurement. It is a precision assembly including a molded component, a ferrite core, and a Hall effect element. It may be damaged if subjected to sudden changes in ambient temperature, or mechanical strain or shock, and therefore great care should be exercised in handling it.

5. Barrier

This structure reduces the likelihood of touching the conductor while testing, and indicates the limit of safe physical contact.

Avoid touching the clamp in front of the barrier when clamping or measuring.

6. Demagnetizing switch (DEMAG)

This demagnetizes the core if it has been magnetized by switching the power on and off, or by an excessive input. Always carry out demagnetizing before measurement.

The demagnetizing process takes about 3 second. During demagnetizing, a demagnetizing waveform is output.

7. Zero adjustment dial (ZERO ADJ)

Use the zero adjustment dial to correct for the effect of a voltage offset or temperature drift on the device.

When beginning measurement, after demagnetizing always carry out zero adjustment.

8. Output connector

The current waveform of the measured conductor is output at a constant rate (0.01 V/A).

Connect to the BNC input connector of the waveform measuring instrument.

NOTE

- The output of this device is terminated internally. Use a high-impedance input to the measuring instrument. With an input impedance of 50 Ω , accurate measurement is not possible.
- If using BNC-banana plug adapters or similar to connect to input terminals other than BNC connectors, make sure the polarity is correct.
- Turn the collar until it clicks, and check that it is locked securely.

9. Power plug

Connect this to the 3269 or 3272 POWER SUPPLY receptacle to supply power to the sensor terminator.

Chapter 2

Specifications

2.1 Product Specifications

Guaranteed at $23^{\circ}\text{C} \pm 5^{\circ}\text{C}$ ($73^{\circ}\text{F} \pm 9^{\circ}\text{F}$) after the power has been on for 30 minutes.

Bandwidth	DC to 2 MHz (-3 dB) (Typical characteristics shown in Fig.1)
Rise time	175 ns or less
Maximum continuous input range	500 A Derating according to frequency shown in Fig.2
Maximum peak current value	Non-continuous 700 A peak;
Output voltage rate	0.01 V/A
Amplitude accuracy	To 500 A: $\pm 1.0\%$ rdg. ± 5 mV To 700 A peak: $\pm 2.0\%$ rdg. (DC, and 45 to 66 Hz)
Noise	Equivalent to 25 mA rms or less (for 20 MHz band measuring instrument)
Input impedance	(Typical characteristics shown in Fig.3)
Temperature coefficient for sensitivity	$\pm 2\%$ or less (Input: 50 Hz 500 A, within a range of 0 to 40°C , within a range of 32 to 104°F)
Maximum rated power	7.2 VA (within maximum continuous input range)
Rated supply voltage	± 12 V ± 0.5 V

Operating temperature and humidity range	0 to 40°C (32 to 104°F), 80 % RH or less (no condensation)
Storage temperature and humidity range	-10 to 50 °C (14 to 122°F), 80 % RH or less (no condensation)
Location for use	Indoor, altitude up to 2000 m (6562 feet)
Period of guaranteed accuracy	1 year (Opening/Closing up to 10,000 times)
Effect of external magnetic fields	Equivalent to a maximum of 800 mA (in a DC or 60 Hz, 400 A/m magnetic field)
Maximum rated voltage to earth	600 V CAT II, 300 V CAT III (insulated conductor)
Diameter of measurable conductors	20 mm dia. 0.79" dia.
Cable lengths	Sensor cable Approx. 2 m (78.7") Power supply cable Approx. 1 m (39.4")
External dimensions	Sensor Approx. 176W X 69H X 27D mm Approx. 6.93"W X 2.72"H X 1.06"D Terminator Approx. 27H X 55W X 18D mm Approx. 1.06"W X 2.17"H X 0.71"D
Mass	Approx. 520 g Approx. 18.3 oz.
Accessories	Instruction manual, Carrying case

2.2 Standards Applying

Safety	EN61010-2-032:2002 Measurement category II, III (anticipated transient overvoltage 4000 V), Pollution Degree 2
EMC	EN61326:1997+A1:1998+A2:2001+A3:2003

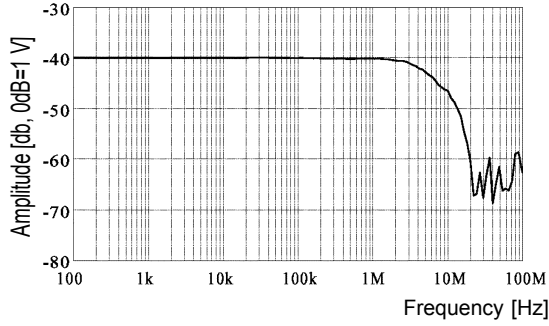

Fig.1 Frequency characteristics (Typical characteristics)

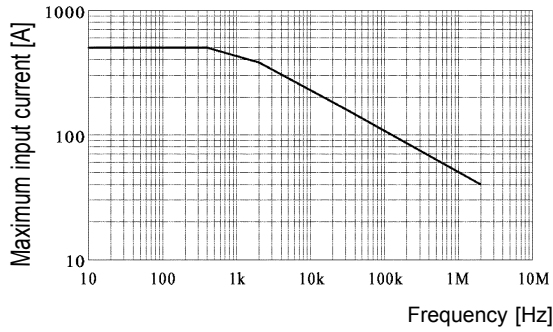

Fig.2 Derating according to frequency

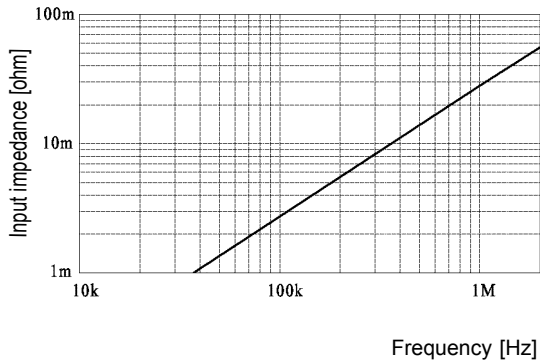

Fig.3 Input impedance (Typical characteristics)



Chapter 3

Measurement Procedure

3.1 Notes on Use



To avoid short circuits and potentially life-threatening hazards, follow these precautions.

- Never attach the clamp to a circuit that operates at more than the maximum rated voltage to earth.
- For safety's sake, avoid clamping around bare conductors, while clamping or measuring.
- While clamping and measuring, do not touch the clamp in front of the barrier or the conductor being measured.
- Be careful to avoid damaging the insulation surface while taking measurements.
- This device is made for use with the 3269 or 3272 POWER SUPPLY. It is possible to use a power supply other than the 3269 or 3272, provided that the connector and pin assignments match, and that voltage and other electrical specifications are satisfied. In the interest of safety, make sure that the power supply has a protective earthing with double-insulation construction.
- Make sure that the waveform measuring equipment connected to this device's output terminal (BNC) is equipped with a protective earthing with double-insulation construction.



- **Make sure that the waveform measuring equipment connected to this device's output terminal (BNC) is equipped with a protective earthing with double-insulation construction.**
- **If the waveform measuring instrument being connected to the output terminal (BNC) on this device is equipped with any other measurement terminals, take the following precautions to ensure that the other instrument does not form a bridge between the probe and any hazardous live of a part.**
 1. **Isolate the terminal to which the probe is connected from other terminals on the measuring instrument using basic insulation conforming to the measurement category, working voltage, and pollution degree requirements of the circuit being tested.**
 2. **If basic insulation requirements cannot be met between the terminal to which this device is connected and other terminals of the measuring instrument, make sure that the voltage input to the measurement terminal does not exceed the Separated Extra-Low Voltage Earthed (SELV-E).**
 3. **Read and observe all warnings and precautions relating to electrical safety for the measuring instrument being connected to the probe.**

Refer to the following standards regarding the meanings of underlined terms.

 - IEC 61010-1**
 - IEC 61010-031**
 - IEC 61010-2-032**

⚠ DANGER

- Be sure to observe all operating precautions for the waveform monitoring instrument (oscilloscope or recorder) and other measurement instruments to which this device is connected
- When using a measurement instrument that does not provide isolation between its input terminals and chassis or other input terminals, please pay attention to the following points.

If a signal is applied to an input terminal other than that to which this device is connected, do not connect the ground-side terminal to any non-ground potential. Otherwise, short-circuit current will flow through the 3269 or 3272, or this device from the ground terminal, which could cause an electrical accident or damage.

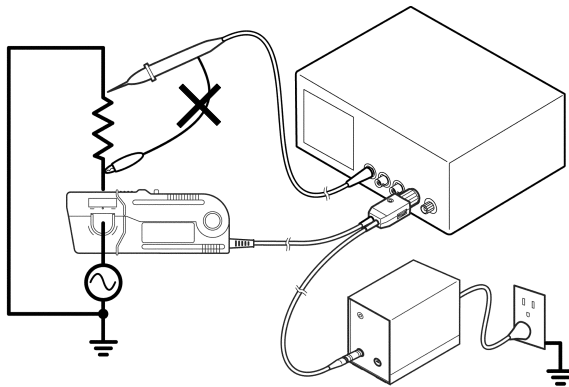

3.2 Preparations for Measurement

- (1) Have the 3269 or 3272 POWER SUPPLY, and oscilloscope or recorder for waveform measurement ready.

CAUTION

Before turning the device on, make sure the source voltage matches that indicated on the rear panel of the 3269 or 3272. Connection to an improper supply voltage may damage the 3269 or 3272 and present an electrical hazard.

NOTE

- The output of this device is terminated internally. Use a high-impedance input to the measuring instrument. With an input impedance of $50\ \Omega$, accurate measurement is not possible.
- Depending on the current value being measured, there are cases in which two CLAMP ON PROBES cannot be used simultaneously on the 3272. Power consumption on the CLAMP ON PROBE depends on the current value being measured.

- (2) Turn the power switch off and connect the power cord.
- (3) Connect the power plug of the 3275 to the power receptacle of the 3269 or 3272.

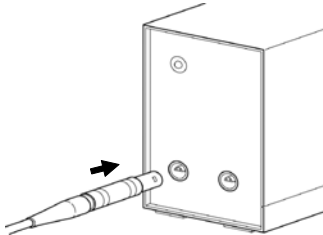

- (4) Turn the 3269 or 3272 power switch on, and check that the front panel power indicator lights.

3.3 Demagnetizing and Zero Adjustment

- (1) With the waveform measurement instrument input at ground, adjust the trace to the zero position.
- (2) Set the input coupling of the waveform measurement instrument to DC.
- (3) Connect the output connector of the 3275 to the input connector of the waveform measurement instrument. Turn the collar until it clicks, and check that it is locked securely.

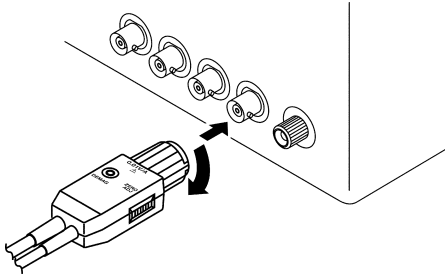

CAUTION

- When disconnecting the output connector, be sure to release the lock before pulling off the connector. Forcibly pulling the connector without releasing the lock, or pulling on the cable, can damage the terminator.
- If using BNC-banana plug adapters or similar to connect to input terminals other than BNC connectors, make sure the polarity is correct.
- Do not demagnetize while the 3275 is clamping a conductor to be measured. Demagnetizing causes current to flow into the conductor, which may damage parts in the circuit to be measured.

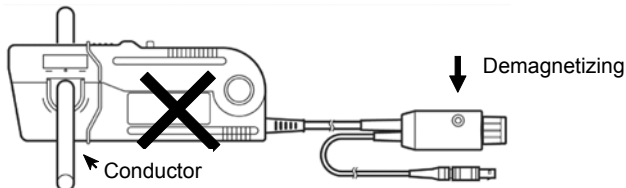

- Check that the conductor being measured is not clamped when supplying power to the 3275 for the same reason. Demagnetized waveforms are generated when supplying electric power.

- (4) Before clamping a conductor, confirm that the clamp can be securely closed: press the slider until UNLOCK is no longer displayed, and hold it until LOCK appears.
- (5) Press the demagnetizing switch (DEMAG) on the terminator.
- (6) Turn the zero adjustment dial on the terminator, to adjust the trace to the zero position.

3.4 Measurement Procedure

- (1) Check that the system is safe, and that the preparations described in the preceding section have been carried out.
- (2) Pull the sensor slider, so that the clamp opens.
- (3) Align the sensor so that the current direction indication corresponds to the direction of current flow through the conductor to be measured, and clamp so that the conductor is in the center of the sensor aperture.

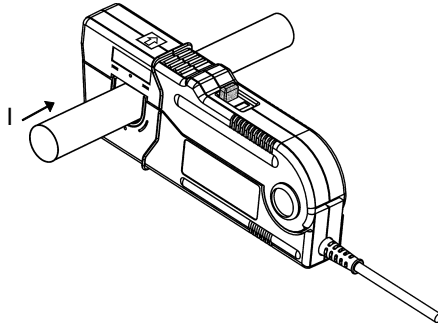

- (4) Press the slider on the sensor head until the "UNLOCK" indication disappears, and hold it until LOCK appears, and check that the opening lever is firmly locked and the clamp securely closed.
- (5) It is now possible to monitor the current waveform. The output rate of the 3275 is 0.01 V/A. The current sensitivity can be derived from the voltage sensitivity of the waveform measurement instrument. For example, if the voltage sensitivity is 10 mV/division, the current sensitivity is 1 A/division.

NOTE

- When using the 3275, note that two clamp-on probes may not be used simultaneously with the 3272 POWER SUPPLY, depending on the current to be measured.
- The current consumption of clamp-on probes depends on the current to be measured. Confirm that the total current consumption of the clamp-on probes does not exceed the rated output current of the 3272. See Figure 1.

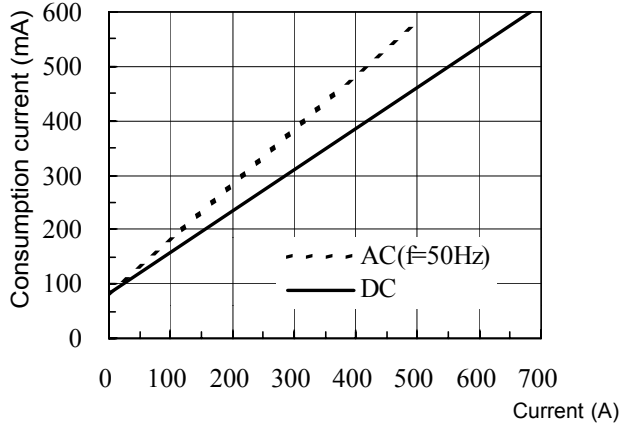

Fig.1

Current consumption* vs. current to be measured (typical)

*The sum total of a positive and negative current consumption

CAUTION

- The maximum continuous input range is based on heat that is internally generated during measurement. Never input current in excess of this level. Exceeding the rated level may result in damage to the probe.
- The maximum continuous input range varies according to the frequency of the current being measured. See the figures in Chapter 2, "Specifications"
- If excess current is input, generated heat activates a built-in safety function that blocks normal output. If this happens, remove the input immediately (remove the sensor from the conductor being measured, or reduce the input current to zero). Wait until the sensor has had sufficient time to cool before resuming operation.

⚠ CAUTION

- Even if the input current does not exceed the rated continuous maximum, continuous input for an extended period of time may result in activation of the safety circuit to prevent damage resulting from heating of the sensor.
- At high ambient temperatures, the built-in safety circuit may activate at current input levels below the rated continuous maximum.
- Continuous input of current exceeding the rated maximum or repeated activation of the safety function may result in damage to the device.
- The probe is rated for maximum input under condition in addition to the input maximums shown in the Product Specifications. It is 700 Apeak, for non-continuous input. This indicates an upper waveform response limit of 700 Apeak. Use the sensor at RMS current input levels that are within the rated continuous maximums.
- When opening the clamp, be sure to operate with the slider.

NOTE

- The output of this device is terminated internally. Use a waveform measurement instrument with an input impedance of at least 1 M Ω .
- Immediately after powering on, this device may be subject to an appreciable offset drift due to the effect of self-heating. To counteract this, allow the device to warm up for about 30 minutes before carrying out measurement.
- When performing continuous measurements, it is necessary to be aware that the offset voltage drifts, depending on factors such as the ambient temperature.
- Under certain circumstances, oscillation may occur if the probe is connected to the 3269 or 3272 POWER SUPPLY while the power supply is on. This does not indicate a malfunction. Oscillation can be stopped and operation restored to normal by opening and closing the clamp.
- Acoustic resonance may occur depending on the level and frequency of the measured current. This does not normally affect measurements unless a foreign substance such as dust is present on the contact surfaces of the sensor head.
- The reading may be affected by the position within the clamp aperture of the conductor being measured. The conductor should be in the center of the clamp aperture.
- When carrying out measurement, press the slider on the sensor head until the "UNLOCK" indication disappears, and hold it until LOCK appears, and check that the opening lever is firmly locked and the clamp securely closed. Correct measurements cannot be performed unless the clamp is securely closed and the slider is pressed until LOCK is displayed.

- At high frequencies, common mode noise may affect measurements taken on the high voltage side of circuits. If this occurs, reduce the frequency range of the waveform measuring instrument, or clamp onto the low-voltage side of the circuit, as appropriate.

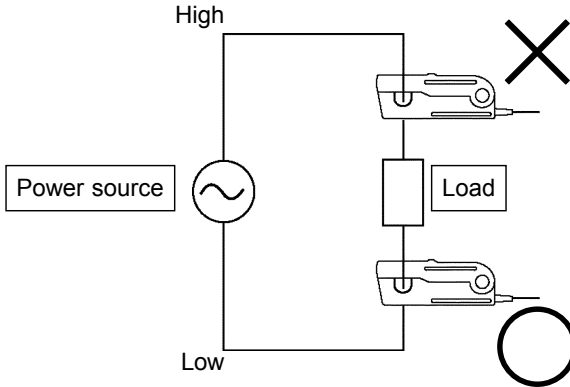

- When power is turned on, a demagnetizing waveform is initially applied to the output: this is intentional in the design, and not a fault.
- Accurate measurement may be impossible in locations subject to strong external magnetic fields, such as transformers and high-current conductors, or in locations subject to strong external electric fields, such as radio transmission equipment.

HIOKI

DECLARATION OF CONFORMITY

Manufacturer's Name: HIOKI E.E. CORPORATION
Manufacturer's Address: 81 Koizumi, Ueda, Nagano 386-1192, Japan
Product Name: CLAMP ON PROBE
Model Number: 3275

The above mentioned product conforms to the following product specifications:

Safety: EN61010-2-032:2002
EMC: EN61326:1997+A1:1998+A2:2001+A3:2003
Class B equipment
Minimum immunity test requirement

Supplementary Information:

The product herewith complies with the requirements of the Low Voltage Directive 73/23/EEC and the EMC Directive 89/336/EEC.

HIOKI E.E. CORPORATION

15 September 2006



Tatsuyoshi Yoshiike
President

3275A999-03

HIOKI 3275 CLAMP ON PROBE

Instruction Manual

Publication date: September 2006 Revised edition 3

Edited and published by HIOKI E.E. CORPORATION

Technical Support Section

All inquiries to International Sales and Marketing Department

81 Koizumi, Ueda, Nagano, 386-1192, Japan

TEL: +81-268-28-0562 / FAX: +81-268-28-0568

E-mail: os-com@hioki.co.jp

URL <http://www.hioki.co.jp/>

Printed in Japan 3275A981-03

-
-
- All reasonable care has been taken in the production of this manual, but if you find any points which are unclear or in error, please contact your supplier or the International Sales and Marketing Department at HIOKI headquarters.
 - In the interests of product development, the contents of this manual are subject to revision without prior notice.
 - Unauthorized reproduction or copying of this manual is prohibited.
-
-

HIOKI

HIOKI E. E. CORPORATION

HEAD OFFICE

81 Koizumi, Ueda, Nagano 386-1192, Japan
TEL +81-268-28-0562 / FAX +81-268-28-0568
E-mail: os-com@hioki.co.jp / URL <http://www.hioki.co.jp/>

HIOKI USA CORPORATION

6 Corporate Drive, Cranbury, NJ 08512, USA
TEL +1-609-409-9109 / FAX +1-609-409-9108

3275A981-03 06-09H



Printed on recycled paper
