

Electrical Measurements of Lithium-Ion Batteries
Fundamentals and Applications



Contents

Introduction	3
1. Overview of the lithium-ion battery manufacturing process	4
2. Electrode materials and electrode manufacturing process.....	5
-1. Importance of quality testing for electrode materials and electrodes	5
-2. Quality testing of the dispersion of materials in electrode slurry	6
-3. Quality testing of electrode sheets during their fabrication process	7
-4. Testing of electrode sheets for metal contaminants	9
3. Cell assembly	11
-1. Weld resistance testing of terminal (tab-lead)	11
-2. Testing of the insulation resistance before electrolyte filling	14
-3. Measuring enclosure potential (laminated lithium-ion batteries)	19
4. Finished cells (cell performance testing).....	24
-1. Pre-charging and charge/discharge characteristics testing.....	24
-2. Measurement of open-circuit voltage (OCV) during the aging process	26
-3. Battery impedance measurement.....	28
5. Battery modules and battery packs (performance evaluation at the finished-product level)	37
-1. Total resistance testing of battery modules and battery packs	37
-2. Testing of BMS boards	41
-3. Actual-load testing of batteries in EVs	46
Conclusion	49
References	50

Introduction

Lithium-ion batteries (LIBs) offer particularly high performance among rechargeable batteries and are used in a variety of industrial domains. They were primarily used as a power supply for portable devices in the past. In recent years their applications have expanded to encompass stationary energy storage systems and electric vehicles (EVs), driving demand for lower-cost LIBs with even higher performance.

Demand for LIBs for use in electric vehicles, including EVs and xEVs (HEVs and PHEVs), is growing particularly rapidly as governments around the world fast-track measures to promote automobile electrification.

Batteries used in EVs must deliver an extremely high level of performance. Examples of automobile characteristics and the corresponding requirements placed on batteries include:

- Long-distance driving: High energy density (high capacity in a compact, lightweight footprint)
- Fast charging: The ability to charge using large currents (exceptional high-current characteristics)
- Extended use: Long battery service life (improved performance in the face of repeated charge/discharge cycles)
- Improved safety: Resistance to combustion (protective functionality provided by prevention of internal battery short-circuits, BMS ICs, etc.)
- Lower vehicle costs: Limitations on material prices and high productivity (development of inexpensive materials and improvements to yields)

For the realization of the battery characteristics shown above, many kinds of measurements and tests are necessary at each state of the battery manufacturing process to assure the quality of each process. In addition, measurements and testing are essential in a variety of settings, during not only manufacturing, but also R&D and finished-product inspections.

Typical measurement and test instrument includes charge/discharge systems, impedance meters, insulation testers, and high-precision voltmeters. HIOKI offers a variety of products in the electrical measurement domain that are well suited to the measurement and testing of batteries.

This guide introduces key considerations in the selection of measurement and testing equipment that is essential in evaluating the performance of materials, manufacturing processes, and finished products, mainly with a focus on our solutions.

1. Overview of the lithium-ion battery manufacturing process

First, Figure 1 offers a survey of lithium-ion battery production processes and the types of testing used in each. Broadly speaking, the process by which lithium-ion batteries are manufactured can be broken down into the following stages:

- Manufacture of materials and electrodes
- Assembly of battery cells
- Performance testing of finished battery cells
- Assembly of modules and packs (assembled batteries)
- Performance testing of modules and packs (assembled batteries)

The section starting on the next page describes the parameters that need to be evaluated in each process and the measuring equipment used to obtain them.

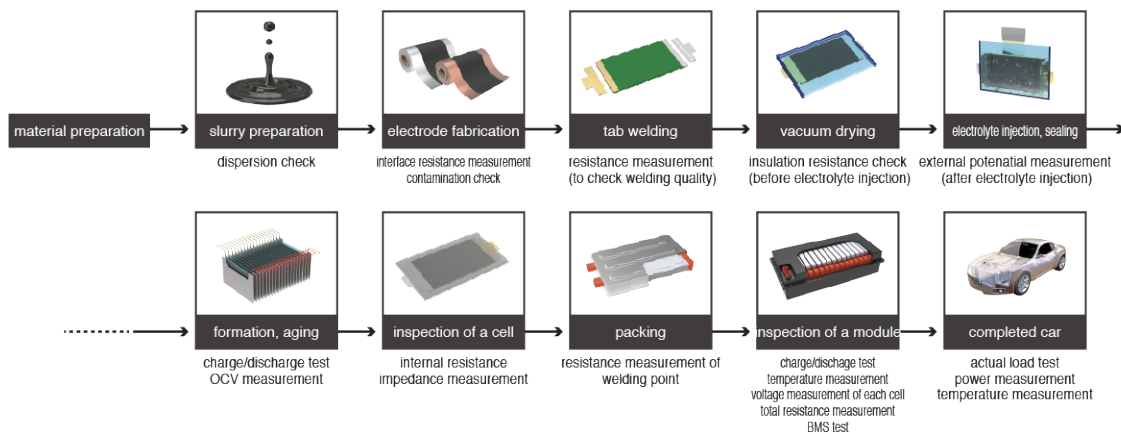

Figure 1. Some of the test parameters by each process

2. Electrode materials and electrode manufacturing process

-1. Importance of quality testing for electrode materials and electrodes

Battery cell manufacturing process can be broadly divided into material manufacture, slurry production, electrode fabrication, and battery assembly.

In order to produce batteries that satisfy the desired specifications in a stable manner, it is extremely important to ensure quality in each stage of the manufacturing process. The more defects can be eliminated in upstream processes, the more production efficiency can be increased. Although there are numerous quality indicators that should be managed, this section will address the following:

- Slurry production: Material ratio and degree of mixing
- Electrode fabrication: Drying conditions and electrode density
- Assembly process: Extent of contamination with impurities

Strict management of each process lays the foundation for process changes and improvements during the R&D stage and for high-quality, high-yield, stable production during the manufacturing stage.

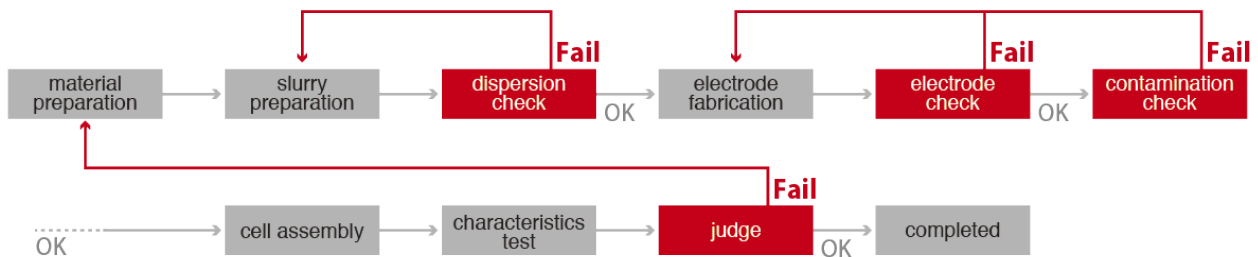

Figure 2. Testing during the battery assembly process

-2. Quality testing of the dispersion of materials in electrode slurry

Lithium-ion battery electrode sheets are fabricated from an electrode slurry that consists of active material, conductive additives, a polymer binder, and an organic solvent.

To boost battery capacity, it is straightforward strategy to reduce the proportion of conductive additives and to increase the proportion of active material. On the other hand, it is important to have enough electron conductivity in order to lower the battery's internal resistance, necessitating an appropriate quantity of conductive additives. It is important to optimize the ratio of active material to conductive additives based on this trade-off.

Additionally, several researches in recent years suggest that a uniform dispersion of these materials in the electrode slurry is extremely important in obtaining favorable battery characteristics¹⁻³. Ensuring surface contact between active material particles and electrolyte increases the reaction area, resulting in more favorable battery characteristics. In addition, an appropriate dispersion of conductive additives, which provides the electron conduction path, is necessary. If the shearing force applied to mix the slurry is too little, the conductive auxiliary material will not loosen sufficiently. On the other hand, good electron conduction cannot be obtained if the shearing force is too strong that a particle of conductive additives is broken apart into fine particles. Additionally, if the conductive additives forms clumps, charges will concentrate there during the charge/discharge after the battery has been assembled. They are undesirable since the goal is to facilitate uniform battery reactions across the entire electrode surface. It can be concluded here it is important to manage the particle size distribution and dispersibility of active material and the conductive additives in the electrode slurry.

HIOKI is proposing a new method analyzing electrode slurry using impedance measurement. This method makes it possible to analyze capacitance components that depend on the electron conductivity of conductive additives, the particle size and dispersion of active material. It has been difficult to accomplish this with the conventional DC method or optical testing.

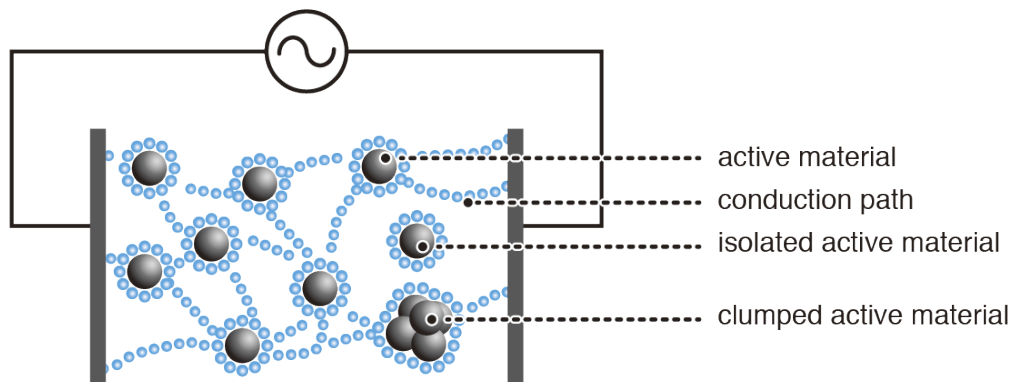

Figure 3. Measuring the impedance of an electrode slurry

-3. Quality testing of electrode sheets during their fabrication process

The first step in the electrode sheet fabrication process is to apply a thin coat of slurry to metal foil (so-called the current collector). Next, the solvent of the slurry is evaporated by warm air in a drying step. The layer fabricated is called the composite layer. Then the sheet is pressed with a metal roller to increase the strength of the composite layer and improve electrical conductivity (“calendaring”). A number of key points must be considered with regard to battery performance during electrode fabrication.

The first consideration is uniformity of thickness when applying the slurry. If the thickness is not uniform, there will be deviations in battery reactions. Additionally, if there are air bubbles in the slurry, they could burst and cause the slurry around them to thin. It is necessary to measure variations in the thickness of the coating in both the widthwise and lengthwise directions in order to control quality and detect anomalies. Optical micrometers are used to measure slurry thickness.

The second consideration is whether the particles in the slurry have been dispersed in a sufficiently fine-grained manner. If they are not thoroughly dispersed, the particles will not be able to perform their function fully, resulting in the deterioration of the battery’s performance. Particles sometimes form clumps in the slurry due to poor dispersion. If a slurry with clumps is applied, the coating can wear away and appear stringy. One technique involves image testing with a camera to detect this stringy appearance and use it as an indicator for evaluating slurry characteristics.

In addition, it is necessary to increase the mechanical strength of the dried electrode composite layer, which is brittle, by pressing it with a metal roller. This process also has the effect of embedding the active material in the collector to improve electrical conductivity. Increasing the press force lowers the contact resistance (interface resistance) between the composite layer and the current collector. However, excessively high press force impedes impregnation of the electrolyte and increases the battery’s resistance, worsening the battery’s input/output performance. By contrast, excessively low press force fails to endow the composite layer with sufficient mechanical strength, posing the risk that it will collapse in the face of repeated charge/discharge. This will lead to reduced battery service life. Consequently, it is necessary to set and maintain the appropriate press force.

HIOKI offers the RM2610 Electrode Resistance Measurement System as a means of managing electrode sheets based on an evaluation of their resistance (Figure 4). The RM2610 determines the volume resistivity of the composite layer and the contact resistance (interface resistance) between the current collector and the composite layer separately, by applying a current from the composite layer surface and then measuring and calculating the surface potential distribution created by that current.

The RM2610 makes it possible to evaluate electrodes prior to the assembly of battery cells by using the composite layer volume resistivity and contact resistance as indicators. Assuring quality during the electrode sheet fabrication process promises to speed the development work that drives lithium-ion battery evolution and to improve the production yield rate.

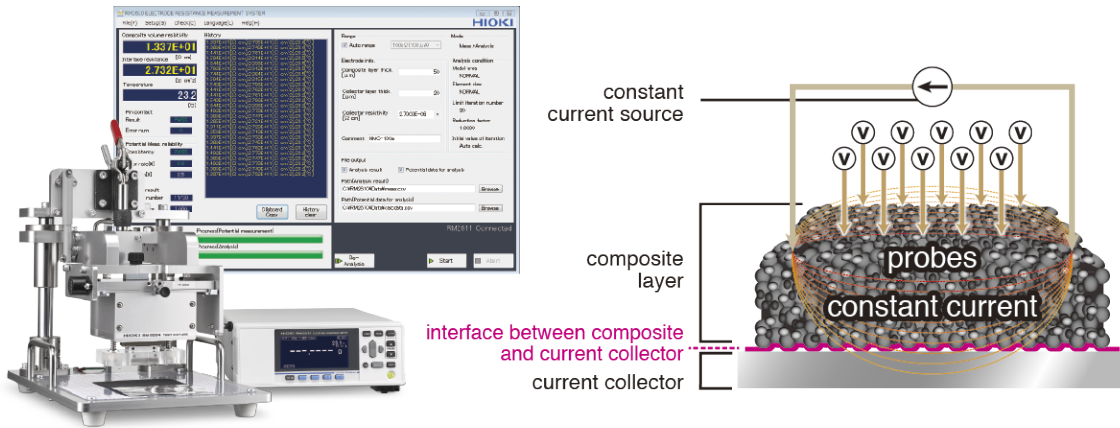

Figure 4. RM2610 Electrode Resistance Measurement System

Let's take a look two conventional techniques: 4-probe measurement (Figure 5) and pass-through resistance measurement (Figure 6). In the 4-probe measurement method, four probes are placed in contact with one side of the electrode, and 4-terminal resistance measurement is performed. In pass-through resistance measurement, the electrode is sandwiched in between plate electrodes, and its electrical resistance is measured using 2-terminal resistance measurement.

These measurement methods can not measure the contact resistance (interface resistance) or the composite layer resistance separately. Even so, they do yield resistance values that reflect the electrode's characteristics, and they are widely used as qualitative quality indicators in electrode fabrication processes. However, the generally low reproducibility of measurement makes it essential to carefully manage measurement conditions.

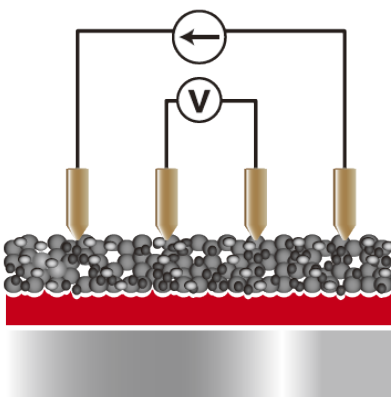

Figure 5. Measurement using the 4-probe method

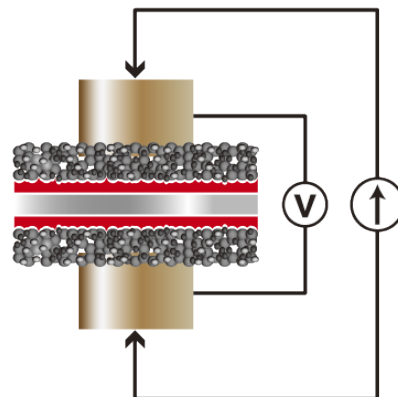

Figure 6. Pass-through resistance measurement

-4. Testing of electrode sheets for metal contaminants

The electrode sheet manufacturing process must be painstakingly managed to ensure that materials are not contaminated with metal powder. Potential sources of metal powder include:

- Metal shavings in the manufacturing area, for example from manufacturing equipment enclosures
- Burrs from the process in which electrodes are cut to the desired size
- Metal powder that has adhered to workers' uniforms

Contamination of materials with metal powder can cause internal short-circuits during battery operation. For example, metal contaminants such as iron, copper, and nickel can dissolve in electrolyte during charging and cause highly branched or dendritic deposits on the negative electrode¹. In addition to a reduction in capacity caused by a series of reactions, contamination in the worst case can cause a large-scale short between the positive and negative electrodes, resulting in an explosion or other accident (Figure 7).

Let's take a look at several techniques to detect foreign material directly which have been commercialized. There are several types of contaminant detection systems:

- Camera-based image testing systems: These systems can perform large-scale contaminant testing relatively inexpensively. Although it is difficult to detect metals alone², some systems offer that capability. This method has the disadvantage of not being able to detect foreign materials that are embedded inside electrodes.
- Detection of metal contaminants using X-rays: This approach can detect resins and other contaminants in addition to metals. This approach is more expensive than other testing systems in terms of both initial costs and maintenance costs.
- Detection of metal contaminants using a magnetic sensor: In order to detect minuscule metal fragments, the sensor must be positioned extremely close to the DUT. This approach can only detect magnetic metal contaminants.

Since each of the techniques described above has its own strengths and weaknesses, manufacturers must either choose the system that best suits their objective or utilize multiple techniques.

Contamination of battery cells with metallic material can be reliably prevented by testing electrode sheets immediately prior to winding. Alternatively, testing can be performed in multiple processes, making it possible to trace specific contaminants to specific processes.

¹ It is often called simply "dendrite".

² Rejecting cells that contain foreign materials that do not affect battery performance as defective is known as overkill. This practice can worsen the production yield rate.

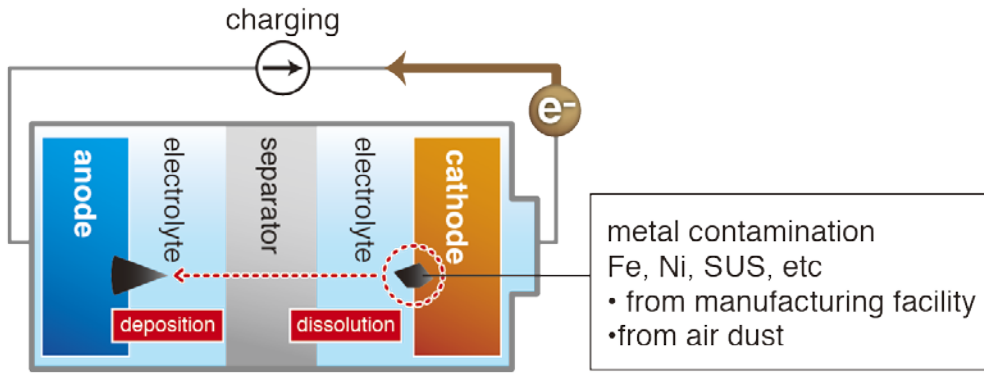

Figure 7. Short-circuit in a battery caused by contamination with foreign material

3. Cell assembly

-1. Weld resistance testing of terminal (tab-lead)

The quality of terminal (tab-lead) welds plays an important role in allowing battery cells to deliver their full performance (Figure 8). In EV applications, it is particularly important to minimize output loss and heat generation. To that end, it is ideal for welds to have super-low resistance that approaches 0Ω .

In general, defective and non-defective products are classified based on weld resistance on the order of $0.1 \text{ m}\Omega$ or less. Engineers must choose a resistance meter that is ideal for low-resistance measurement with a resolution of $1 \mu\Omega$ or less.

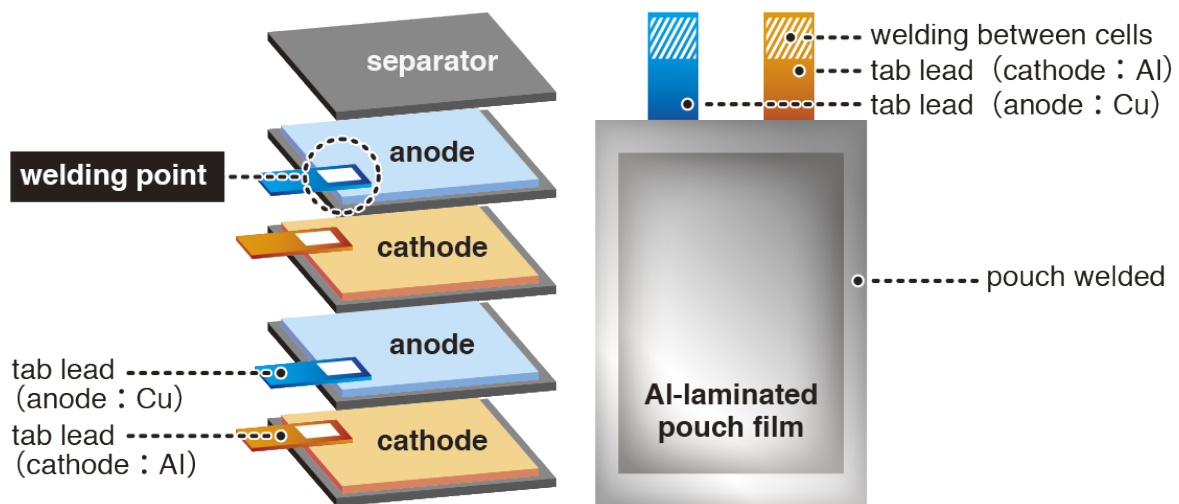

Figure 8. Tab-leads in a laminated lithium-ion battery

The following precautions should be taken with regard to low-resistance measurement:

(1) Measurement current

First the constant current is applied to the DUT (device under test³), and then the voltage across the DUT is measured. The resistance value is calculated using Ohm's law. Instruments known as resistance meters are specifically designed to use this resistance measurement method. Generally speaking, low-resistance measurement requires a large measurement current in order to facilitate accurate measurement. If the DUT has a resistance value of $1 \text{ m}\Omega$ or less, it is recommended to use a resistance meter that generates a current of at least 100 mA , and if possible, of 1 A .

(2) Resistance measurement using the 4-terminal method

In low-resistance measurement, the measurement probes' wiring resistance and the contact resistance of the probe tips exert a significant influence on measurement and therefore cannot be ignored. In particular, the contact resistance at the point of measurement probe contact can reach several ohms or even dozens of ohms depending on environmental

³ The object under measurement is generally called "the device under test" or simply "the DUT".

conditions.

With 2-terminal measurement, the measurement current I flows through not only the resistance R_0 of the DUT, but also the wiring resistance and contact resistance (r_1 and r_2), with the result that the observed voltage E is given by the following equation: $E = I (R_0 + r_1 + r_2)$. The resistance value calculated using Ohm's law from this equation is $R_0 + r_1 + r_2$ (Figure 9).

The 4-terminal method is used to resolve this problem. With 4-terminal method, separate pairs of current-applying and voltage-measuring electrodes are used. The measurement current I flows through the resistance R_0 but not through the voltage measurement terminal's r_3 or r_4 . Consequently no voltage occurs across the r_3 and r_4 portion of the circuit. As a result, the voltage E measured is exactly equal to the voltage E_0 of the DUT, allowing the resistance to be accurately measured without being affected by r_1 , r_2 , r_3 , or r_4 (Figure 10).

Based on the above, it is necessary to choose a resistance meter of the 4-terminal method when measuring low resistance values on the order of milliohms.

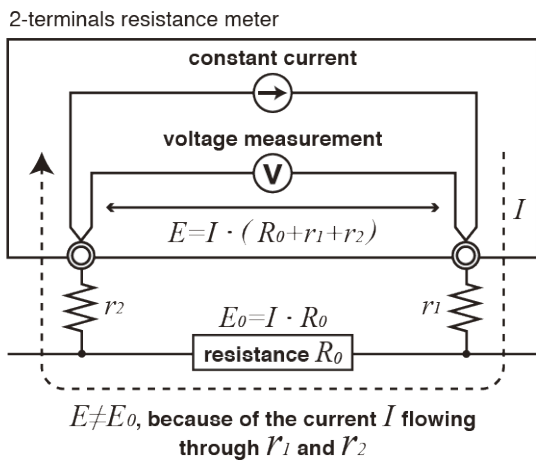

Figure 9. Resistance measurement with the 2-terminal method

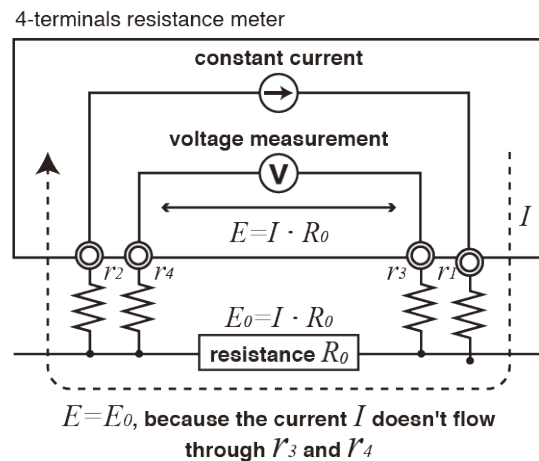

Figure 10. Resistance measurement with the 4-terminal method

(3) Influence of thermal electromotive force

Thermal electromotive force is a potential difference that occurs across the junction of different metals. When measuring the resistance, thermal electromotive force occurs at the junction of the measuring probe and the DUT, which becomes a source of error. The influence of the thermal electromotive force V_{EMF} is particularly large if the resistance value R_X of the DUT is small, because the voltage $R_X I_M$ to be measured is small in such cases. One technique to eliminate the influence of thermal electromotive force is to conduct the measurement twice, one the measuring current in the positive direction and one in the negative direction. The influence of thermal electromotive force can be removed by means of a calculation.

By subtracting the voltage measured with the current in the negative direction from the voltage measured with the current in the positive direction, it is possible to obtain a resistance value that is immune to the influence of thermal electromotive force (Figure 12, Equation [1]). The Resistance Meter RM3545 provides an offset voltage compensation (OVC) function for canceling the influence of thermal electromotive force.

$$\frac{(R_X I_M + V_{EMF}) - (-R_X I_M + V_{EMF})}{2I_M} = R_X \quad (1)$$

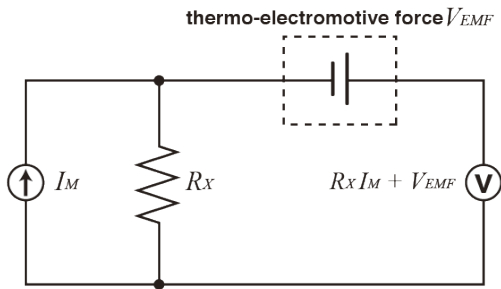

Figure 11. Error caused by thermal electromotive force

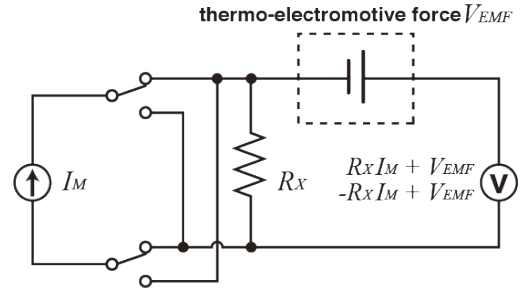

Figure 12. Cancellation of thermal electromotive force using the OVC function

-2. Testing of the insulation resistance before electrolyte filling

When the insulation of the components, between which must be insulated, is insufficient, the deficiency may cause a lowering in the battery's service life or an accident involving fire. The primary causes of the deficiency of the insulation resistance are contamination with metallic material and separator tears.

Principal parts of the battery that must be insulated include the electrodes and the electrodes and enclosure⁴.



Figure 13. Insulation Tester ST5520 to measure the insulation resistance of battery cells

In order to ensure sufficient insulation resistance, it is essential to perform insulation resistance testing of battery cells before the electrolyte filling. Insulation resistance meters are used to perform insulation resistance testing. Insulation resistance meters are one type of resistance meter that has been specifically designed to measure high resistance values⁴.

Insulation resistance meters apply a high voltage to an insulator, measure the flowing current, and calculate the corresponding resistance value. These instruments equip highly sensitive ammeters that can accurately detect minuscule picoampere (pA) and femtoampere (fA) currents.

Because the measurement signals in insulation resistance measurement are minuscule, measured values are highly susceptible to external noise or leakage currents. It is essential to prepare a suitable measurement environment. The stability of measured values is also important.

Conventionally, the term “insulation resistance meter” refers to an instrument that is capable of measuring resistance values up to around 10 GΩ. Insulation resistance meters that can measure even higher resistance values (typically values on the order of $T\Omega = 10^{12} \Omega$ or higher) are known as super megohmmeters to distinguish them⁵. This guide differentiates broadly between the two types of instruments in its explanations by using the terms “insulation resistance meter” and “super megohmmeter.” Since the two types of instrument differ significantly not only in terms of the

⁴ It is particularly important to identify batteries with insulation defects between the negative electrode and the enclosure as defective. A more detailed explanation is provided in the chapter “Measuring the enclosure potential”.

⁵ Super megohmmeters are sometimes known as super-meggers or picoammeters.

performance but also cost, it is advisable to choose the best instrument based on the pass/fail judgment criteria of the process.

HIOKI's insulation resistance meters include the Insulation Tester ST5520, and its super megohmmeters include the Super Megohmmeter SM7110 series. The following points should be taken into consideration in order to choose the best instrument for a given set of requirements.

(1) Insulation resistance value measurement range

It is necessary to choose an instrument that is capable of measuring insulation resistance values that are greater than the insulation pass/fail judgment threshold. It is particularly important to check the measurement range when the judgment thresholds are high, on the order of several gigaohms or greater.

- If you require accuracy on the order of several percent with judgment thresholds from several megaohms to several gigaohms: ST5520
- If you require higher accuracy with judgment thresholds from several kiloohms to several hundred teraohms: SM7110, SM7120

(2) Voltage output performance

Choose a model that offers optimal voltage levels that are applied during insulation resistance measurement.

- 1000 V or less: ST5520, SM7110
- 2000 V or less: SM7120

In addition, exercise care with regard to the capacitance of battery cells. Some battery cells have large capacitance values, several hundred picofarads or several microfarads, or even greater. When measuring such cells, the applied voltage may exhibit overshoot. When overshoot occurs, it will take time for the set test voltage to be output in a stable manner. This phenomenon may influence cycle time, as described below. In addition, a voltage exceeding the set voltage is applied during the overshooting, raising the risk that the DUT could be damaged.

HIOKI's insulation resistance meters and super megohmmeters are designed to limit overshoot even when measuring the DUT of large capacitance. They are well suited to use in the insulation resistance testing of batteries.

(3) Cycle time

In order to efficiently test large amount of battery cells, it is important to minimize cycle time. The following insulation resistance meter specifications help determine cycle time:

a. Current capacity (current limitations)

To measure the insulation resistance of the capacitive DUT like battery cells, the DUT must be charged previous to the measurement. Current capacity refers to the limit of current that can be applied to the DUT. Product specifications for instruments use terms such as charging current, current limitation, current limiter,

measurement current, or rated current to express this quantity. A low current capacity means that more time will be required to charge the DUT before the measurement. It is therefore important to use an instrument that offers a sufficiently large current capacity relative to the required cycle time.

In insulation resistance measurement, a constant voltage is applied to the DUT. When this voltage is applied, charges accumulate between the electrodes, and between the electrode and the enclosure's insulation layer⁶. The time t [s] needed to charge the DUT can be calculated from the capacitance C [F] of the DUT, the current I [A] flowing to the circuit, and the applied voltage V [V] as follows:

$$t = \frac{CV}{I} \quad (2)$$

t : charge time, C : capacitance of the DUT, V : test voltage, I : charge current

The capacitance C of the DUT and the test voltage V are determined by the process in question. Consequently, the time needed before the measurement is inversely proportional to the current that can be applied to the DUT, or a current capacity. In other words, in order to shorten the cycle time, it is necessary to use an insulation resistance meter with a high current capacity.

The current capacities of HIOKI insulation resistance meters are as follows:

ST5520: Max. 1.8 mA

SM7110, SM7120: Max. 50 mA (the maximum value is settable as "current limit")

b. Discharge function (charge absorption function)

The discharge function serves to discharge the accumulated charge in the insulation layer of the DUT after the measurement. Inadequate discharge could lead to electric shock or cause damage to the DUT due to residual charge. Consequently, after the completion of testing it is necessary to absorb the charge with a discharge function. Most insulation resistance meters provide a discharge function, of which there are two variants: resistance discharge method and constant-current discharge method. When testing a capacitive DUT such as a battery cell, the constant-current method can complete discharging significantly faster.

[Time required for resistance discharge method]

$$t = CR \ln \left(\frac{V_0}{V_1} \right) \quad (3)$$

⁶ The phenomenon in which the insulator is charged is known as dielectric absorption.

[Time required for constant-current discharge method]

$$t = \frac{C(V_0 - V_1)}{I} \quad (4)$$

t : discharge time, C : capacitance of the DUT, R : discharge resistance,
 V_0 : voltage when charged, V_1 : voltage after discharge, I : discharge current

The HIOKI Insulation Tester ST5520 and the Super Megohmmeter SM7110/SM7120 provide constant-current discharge functionality.

ST5520: 10 mA constant-current discharge

SM7110, SM7120: Constant-current discharge at the current value specified by the current limiter settings (max. 50 mA)

(4) Contact check function

In the absence of electrical contact between the measurement probes and the DUT, it is impossible to measure the insulation resistance. However, the insulation resistance meter's display value will be extremely large in such a state, making it impossible to distinguish a non-defective product simply by looking at the display value (Figure 14). In this situation, there is a risk that a battery with defective insulation could be incorrectly determined to be non-defective. Consequently, it is requisite to verify that the probes have made proper contact prior to the measurement. Functionality for checking whether the probes are in contact with the DUT is known as contact check functionality. In order to reliably prevent defective products from being shipped to the market, it is desirable to choose a resistance insulation meter with this functionality.

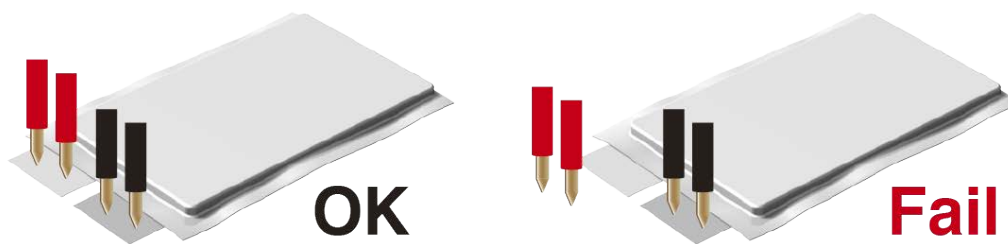

Figure 14. Proper contact (left) and improper contact (right)

(5) Micro-short check function

A micro-short is a short-circuit in which metallic foreign material, burr, or other substance has introduced a minuscule conductive pathway⁷. Applying a high voltage⁸ to the battery with such a micro-short could cause an electric

⁷ In the lithium-ion battery industry, the term “micro-short” usually refers to a phenomenon in which dendrite growth causes conductivity between the positive and negative electrodes. The term has a somewhat more general meaning in the context of

field to concentrate in the area of the micro-short, causing it to burn away. In such cases, measurement will eliminate the micro-short and result in a “pass” judgment (Figure 15). However, in fact batteries with micro-shorts must be judged defective due to the risk of a large-scale short developing with repeated charge/discharge.

Functionality for applying a low voltage (on the order of several volts) such that micro-shorts are not eliminated and detecting them before insulation resistance measurement offers an effective way to avoid the issue. It is desirable to choose an insulation resistance meter that offers such functionality.

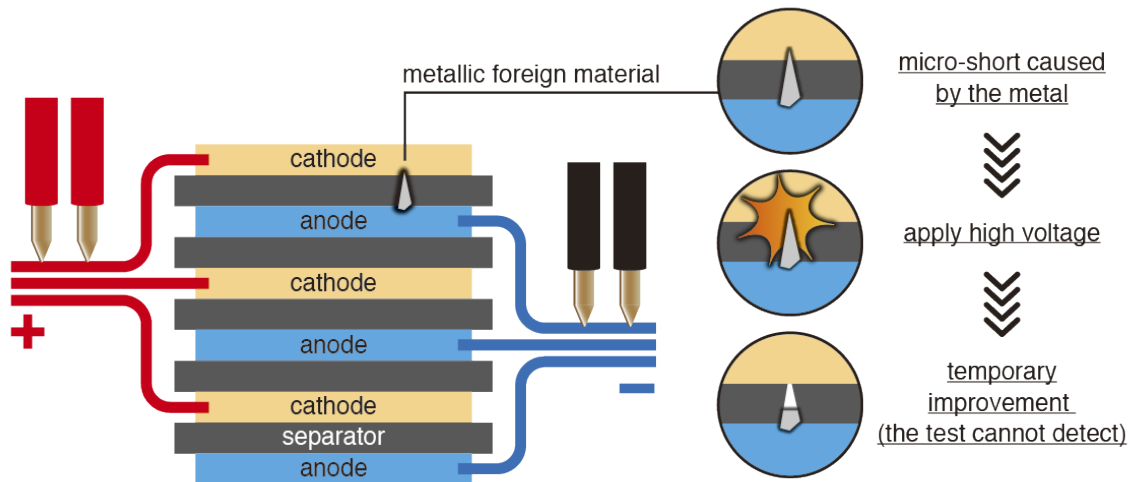

Figure 15. Temporary elimination of a micro-short by application of a high voltage

insulation performance testing, where it refers to a condition in which areas that should be isolated are in fact conductive, but due to the minuscule size of the conductive region, the high voltage applied during insulation performance testing causes the region to burn away, with the result that the insulation defect goes undetected. Please note that this guide uses the term in its more general meaning.
⁸ In insulation resistance measurement performed before electrolyte filling, it is typical to apply a voltage ranging from around 100 V to around 200 V.

-3. Measuring enclosure potential (laminated lithium-ion batteries)

This section describes enclosure potential measurement as a method for insulation testing of laminated lithium-ion batteries, as shown in Figure 16.

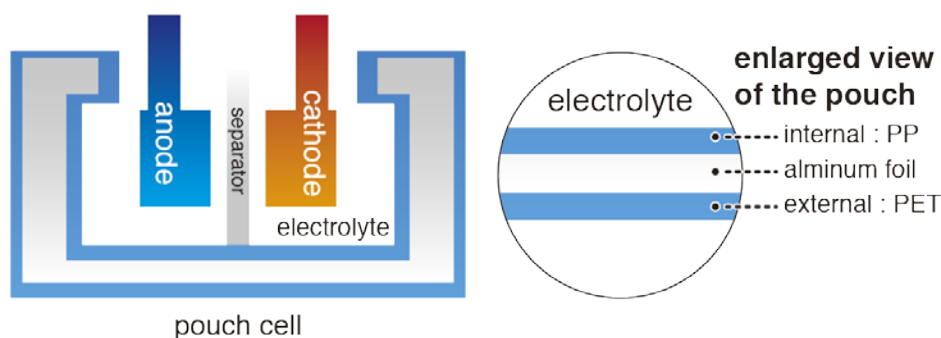

Figure 16. Example diagram of the structure of a laminated lithium-ion battery

Even if proper isolation is verified before the electrolyte filling, insulation defects can occur if new electrical pathways form after electrolyte filling. Consequently, it is extremely important to verify the state of insulation after electrolyte filling. However, if insulation resistance measurement is carried out at a high voltage here as it was before electrolyte filling, a high voltage may cause the decomposition of the electrolyte and influence the performance of the battery.

For example, consider an insulation defect between the negative electrode and the enclosure aluminum, as illustrated on the left side of Figure 17. In addition to that, suppose that a crack occurs in the enclosure aluminum's resin film as shown on the right side of Figure 17, introducing a conductive pathway between the electrolyte and the enclosure aluminum. The result is a current pathway such as that indicated by the arrow on the right side of Figure 17. Because the aluminum has the higher potential than the negative electrode, a reduction reaction will occur at the interface, leading to the formation of a Li-Al alloy. Due to the extremely brittle nature of this Li-Al alloy, this phenomenon may cause pinholes to form in the enclosure aluminum. If moisture enters the battery through these pinholes, the service life of the lithium-ion battery will decline significantly (Figure 18). In short, it is essential to detect insulation defects between the negative electrode and the enclosure aluminum in order to manufacture high-quality batteries.

Other potential issues include insulation defects between the positive electrode and the enclosure as well as shorts between the electrolyte and the enclosure. These issues result in an oxidation reaction since the aluminum has the lower potential, so no Li-Al alloy forms (Figure 19). Since there is no impact on the service life of the lithium-ion battery, these issues can be judged as non-defective (Table 1.[3]).

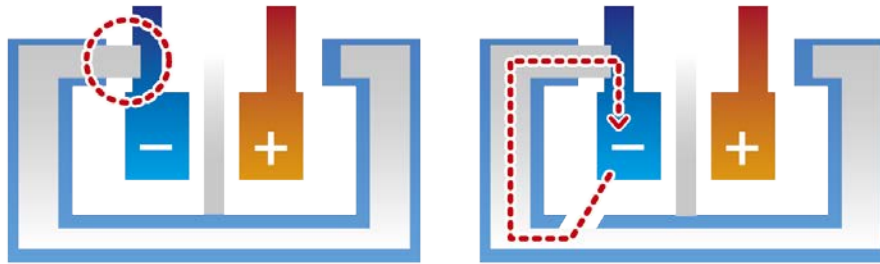
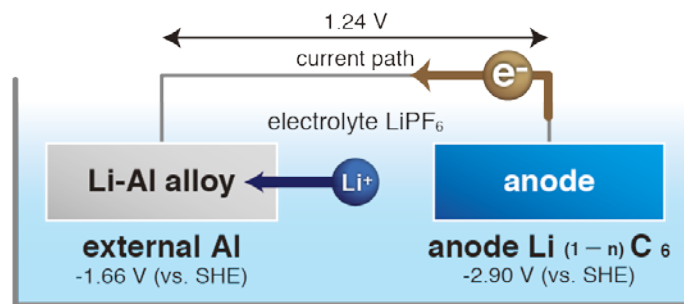
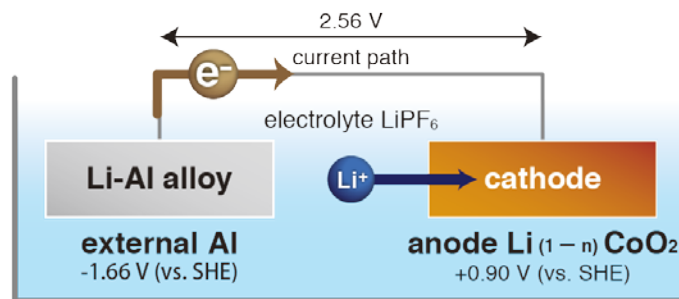

Figure 17. A negative electrode insulation defect and the resulting current pathway formed by cracking inside the pouch



[insulation defect between the negative electrode and the enclosure aluminum]
aluminum reduced and Li-Al alloy generated

Figure 18. A reaction caused by an insulation defect between the negative electrode and the enclosure aluminum



[insulation defect between the positive electrode and the enclosure aluminum]
aluminum oxidized

Figure 19. A reaction caused by an insulation defect between the positive electrode and the enclosure aluminum

With laminated lithium-ion batteries, measuring the potential difference between the positive electrode and enclosure aluminum is an effective way to detect insulation defects between the negative electrode and the enclosure aluminum. This potential difference is subsequently referred to as the “enclosure potential”. The enclosure potential’s voltage value varies with the nature of the insulation defect. Table 1 summarizes the relationship between internal insulation defect patterns and enclosure potential.

As described so far, it is essential to reliably detect insulation defects between the negative electrode and the enclosure aluminum such as those described in Table 1(5). When such a defect has occurred, the enclosure aluminum

potential will be the same as that of the negative electrode, with the result that the enclosure potential will be equal to the result of subtracting the negative electrode potential from the positive electrode potential. In short, an enclosure potential that is close to the battery's voltage suggests an insulation defect between the negative electrode and enclosure aluminum.

In a healthy battery, there is no enclosure potential and the displayed value will be unsettled, as indicated in Table 1(1). But it is practically useful if the measuring instrument displays a settled value, specifically a value of 0 V. In order to achieve this, it is effective to connect a resistance of about 10 M Ω to 10 G Ω (R_{IN}) between the voltmeter's high and low terminals. Ordinarily, the voltmeter's input resistance ranges from 10 M Ω to 10 G Ω , and this input resistance is written as R_{IN} (Figure 20).

On the other hand, even if the positive and negative electrodes are shorted (Table 1(2)), there should be no enclosure potential, as in a healthy battery, and the potential would be unsettled. In short, shorts between the positive and negative electrodes cannot be detected in enclosure potential measurement. However, such shorts are an insulation defect that can cause serious accidents. It is necessary to ensure they are reliably detected by performing insulation resistance testing between the positive and negative electrodes before electrolyte filling.

Another potential issue is cracking in the insulating coating, as described in Table 1(4). The enclosure potential indicates the figure calculated by subtracting the enclosure aluminum potential from the positive electrode potential. The enclosure aluminum potential is about -1.7 V (vs. SHE⁹). The positive electrode potential varies with the battery voltage and electrode active material. For example, in the case of LiCoO₂ with comparatively high state of charge, it is about +0.9 V (vs. SHE). Consequently the measured enclosure potential would be about 2.6V. Since cracking at the insulating coating does not itself affect battery performance, batteries exhibiting this issue can be judged as non-defective.

Since shorts between the positive electrode and enclosure aluminum (Table 1(3)) do not affect battery characteristics, batteries with this issue can also be judged non-defective. Under such conditions, naturally, the enclosure voltage is 0 V, which is the same value as that of a healthy battery.

In this way, it is possible to reliably detect insulation defects between the negative electrode and the enclosure aluminum by treating batteries whose enclosure potential is close to the battery voltage as defective.

The following three points demand caution when measuring enclosure potential:

(1) Input resistance of the instrument used to measure the potential





If the instrument has a low input resistance, the voltage being observed will be divided, making it difficult to distinguish between defective and non-defective batteries. It is desirable that the voltmeter have a high input resistance in order to facilitate better testing.

For example, if the insulation resistance is 10 M Ω and R_{IN} is 10 M Ω , the enclosure potential would be divided in half. It is necessary to use a voltmeter with a higher input resistance. It is recommended to use an instrument with an input

⁹ Indicates the potential relative to a standard hydrogen electrode (SHE). The potential relative to SHE is known as the standard electrode potential.

resistance of at least 10 G Ω . However, few instruments have such high input resistance. Caution is necessary when choosing an instrument since many standard voltmeters and digital multimeters have an input resistance of 10 M Ω .

Table 1. Internal insulation defect patterns exhibited by lithium-ion batteries and corresponding pass/fail judgments

	Defect location	Cause	Phenomenon	Pass/ Fail	Enclosure potential	Test method
(1)	non-defective 	-	-	Pass	unsettled (0V)	-
(2)	between positive and negative electrode 	Puncture of separator by dendrite Contamination with metallic particles Winding defect	Increase in self- discharge Abnormal heating	Fail	unsettled (0V)	Insulation resistance
(3)	Between positive electrode and enclosure aluminum 	Contamination with metallic particles Enclosure seal defect	No impact on battery characteristics	Pass	0V	Enclosure potential
(4)	Between electrolyte and enclosure aluminum 	Cracks in insulating coating	No impact on battery characteristics	Pass	~2.6V (= +0.9 - (-1.7))	Enclosure potential
(5)	Between negative electrode and enclosure aluminum 	Contamination with metallic particles Enclosure seal defect	Degradation progresses (if cracks develop in the enclosure aluminum's insulation coating)	Fail	~3.8V (= +0.9 - (-2.9))	Enclosure potential

(2) Probing reliability

In enclosure potential measurement, a battery with a reading close to 0 V is judged to be healthy. Similarly, if the probes fail to make contact with the DUT, the resistance meter will indicate 0 V due to the input resistance R_{IN} . As a result, a contact error could lead to a defective battery being recognized incorrectly as healthy and shipped to the market. Caution is particularly necessary on the enclosure aluminum side since the insulation film coating makes it more likely for contact defects to occur.

Since HIOKI's DM7275/DM7276 voltmeter provides contact check functionality, the instrument can perform measurements after verifying proper contact. It is important to use an instrument with contact check functionality so that contact can be verified prior to measurement.

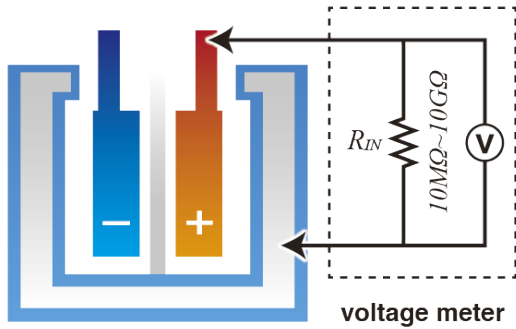

Figure 20. With the voltmeter's input resistance (R_{IN}) connected

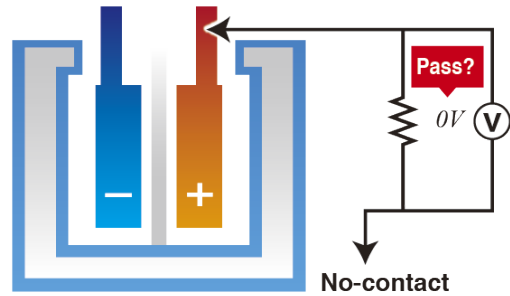

Figure 21. Example of an incorrect judgment caused by a contact error

(3) Noise suppression

Enclosure potential measurement involves measurement of a pathway with high output resistance. In noisy environments, large dispersion in measured values can result in erroneous judgments. It is necessary to use shielded measurement cables so that the circuit is less susceptible to such noise. Additionally, it is important to synchronize the voltmeter's integration time and the power supply frequency in order to reduce the influence of commercial power supply hum noise.



Figure 22. Shielded cable

4. Finished cells (cell performance testing)

-1. Pre-charging and charge/discharge characteristics testing

It is necessary to pre-charge the cell immediately after electrolyte filling in order to prevent elution of the negative electrode's collector. The charge/discharge system used to pre-charge the cell must have a sufficient output voltage and current capacity for pre-charging. Since the battery voltage may be negative after electrolyte filling, it is desirable to use a charge/discharge system that provides functionality for charging at a negative voltage.

Pre-charging is performed at a low current value in order to facilitate the formation of a uniform solid electrolyte interphase (SEI) film on the surface of the negative electrode. The thickness of the SEI can be gradually increased through repeated pre-charging. The state of the formed film can be determined based on changes in AC impedance.

The charge/discharge system will need to provide a variety of charge and discharge modes for evaluating the battery's various characteristics. The most basic capacity measurement is made by charging in constant-current/constant-voltage (CC-CV) mode and discharging in constant-current (CC) mode. Pulse charge/discharge mode is often used when testing capacity during actual use with discharge patterns that simulate actual loads for devices that require a large amount of current in a short period of time. There are also charge/discharge systems that can simulate actual loads in a finer-grained manner, for example to simulate high-frequency ripple in a motor's inverter current. Other modes, for example constant-resistance discharge mode and constant-power mode, are used to perform tests simulating actual use depending on the application in which the battery will be used.

A battery's internal resistance is an important indicator for understanding the battery's state. There are two types of internal resistance measurement: the AC method and the DC method. In the AC method, the impedance is calculated from the current and voltage change when an AC signal is applied to the battery. By contrast, in the DC method, the resistance value is calculated based on the voltage change and current either immediately after the start of the test or after discharge stops. Consequently, a charge/discharge system that can start and stop current application abruptly and acquire voltage changes quickly is required in order to measure internal resistance using the DC method.

Since battery characteristics vary with temperature, it is important to manage the battery's temperature during charge/discharge characteristics testing. A temperature test chamber is essential in order to investigate battery performances in an accurate manner. It is typical to insert a pause after the temperature test chamber reaches the set temperature in order to allow the inside of the battery to reach a uniform temperature. It is necessary to determine the duration of the pause based on the battery's volume (heat capacity).

Some charge/discharge systems provide power regeneration functionality so that the discharge power can be captured by the tester's circuitry and used as the charge current. Since charge/discharge systems use a significant amount of power, this feature helps save energy and limit heat dissipation.

The maximum power that the charge/discharge system must provide varies greatly depending on whether it will be used with cells or with modules and battery packs. The instrument should be chosen based on the output voltage and charge/discharge current needed for the application.

-2. Measurement of open-circuit voltage (OCV) during the aging process

When batteries are left untouched, gradual growth of dendrite will lead to micro-shorts between the positive and negative electrodes. Since such batteries are at risk of future large-scale shorts, it is necessary to reliably eliminate them during the manufacturing process. Since micro-shorts between the positive and negative electrodes lower the OCV, Testing of the voltage values is an effective method to detect defective batteries. Ordinarily, such testing is carried out by measuring the variation in the OCV during the aging process. Conductive material adhering to the surface of the electrodes is also the potential source of micro-shorts and it cannot be discovered by insulation testing during the previous process completely. Testing using OCV measurement during the aging process is necessary.

The amount of variation in the OCV is extremely small, making necessary an extended aging process. It is typical to measure the OCV before and after aging, which lasts at least from 100 to 200 hours, and sometimes for several weeks, in order to make pass/fail judgments. It is necessary to use a voltmeter that offers excellent accuracy and precision on the order of μV so that minuscule variations in voltage can be detected.

As more time passes, the difference in the OCV of defective and non-defective cells increases, making detection easier. However, excessively long aging can undermine productivity (Figure 24). If the voltmeter being used provides sufficient precision and accuracy, it will be possible to distinguish between defective and non-defective cells following a short aging process. It is particularly important to choose a digital multimeter or voltmeter that can make accurate measurements of the cell voltage (around 4 V). Since instruments offer different ranges and other characteristics, it is necessary to exercise care so as to not make performance comparisons based simply on resolution and the number of display digits. Instead, calculate the accuracy for the cell voltage you wish to measure (around 4 V) and then calculate the measurement error. Then choose the instrument that offers the highest measurement accuracy.

Thanks to exceptional voltage basic measurement accuracy of 9 ppm and a one-year accuracy guarantee made possible by a fully automatic calibration system, HIOKI's Precision DC Voltmeter DM7276 (Figure 25) can detect defective cells during the aging process in an efficient and economic manner.

Table 2. Types of conductive material that adhere to the surface of electrodes

-1	Metallic contamination (cause of dendrite)
-2	Collector cuttings from electrodes cutting
-3	Active layer powder from cutting
-4	Burrs on the sides of the collector

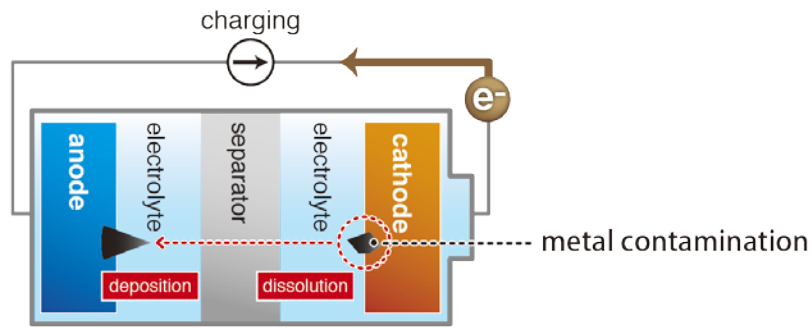

Figure 23. Puncture in separator caused by dendrite growth

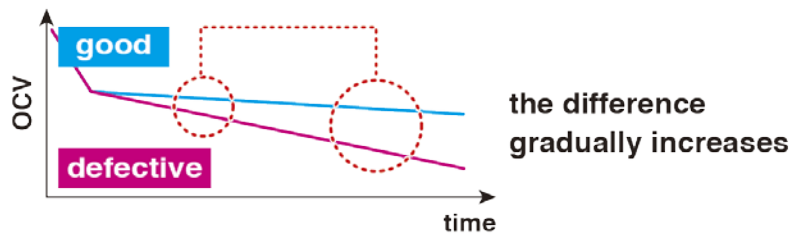

Figure 24. Change in battery voltage during aging



Precision DC Voltmeter
DM7276

Figure 25. DC Voltmeter DM7276

-3. Battery impedance measurement

The characteristics of a battery vary greatly with its internal resistance value. High internal resistance causes increased energy loss, resulting in degraded battery performance. In addition, heat generation in the battery during use accelerates the degradation process. Generally speaking, batteries with low internal resistance exhibit favorable characteristics. Internal resistance values are widely used as an indicator of battery characteristics.

There are two methods for measuring a battery’s internal resistance: the AC method and the DC method.

In the DC method, the battery is discharged at a constant current, and the internal resistance is calculated from the discharge current value and the voltage drop as measured at specific times. The method is primarily used in testing large-current characteristics in a manner that envisions actual use.

By contrast, the AC method for measuring internal resistance involves applying a minuscule AC signal to the battery and detecting the resistive component and the reactive component of the voltage. The AC method is widely used in internal resistance measurement in order to evaluate the performance and quality of batteries because highly reproducible measurements can be made easily with a small instrument, and because measurements can be made quickly. Additionally, because the battery is discharged in the DC method, the measurement process causes the battery’s state of charge to change. The AC method should be chosen for applications in which such issues would be problematic.

Ordinarily, resistance values measured using the DC method are known as DC-IR, while resistance values measured using the AC method are known as AC-IR¹⁰. Internal resistance measurement using the AC method is often called simply “impedance measurement,” and this guide will follow the same convention.

Note that ordinary resistance meters and ordinary impedance meters (LCR meters) cannot measure batteries (Figure 26). Impedance meters capable to measure batteries are known as “battery testers” in order to distinguish them from ordinary impedance meters. Typically, battery testers can measure batteries’ voltage as well as their impedance.

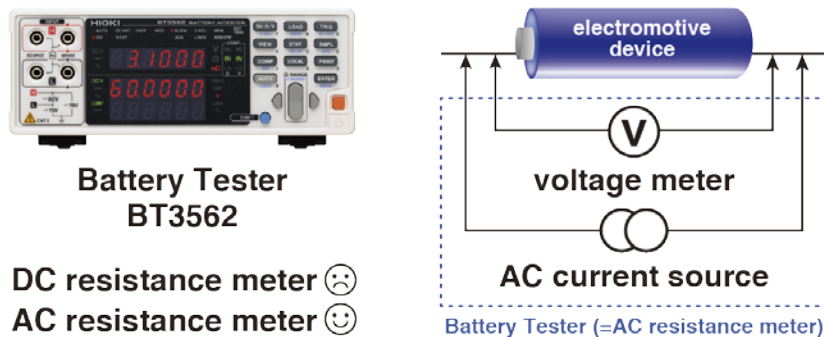

Figure 26. Measurement of a battery’s internal resistance using a battery tester (AC resistance meter)

¹⁰ IR: Internal resistance

On shipping and acceptance inspection lines, it is typical to measure impedance at a specific frequency (generally 1 kHz). The resistive and reactive components are calculated, and the resistive component alone is displayed as the effective resistance value. This approach is particularly well suited to mass-production testing and acceptance inspections for its quickness.

JIS C 8711:2013, a standard concerning lithium-ion batteries for portable devices, specifies a method for measuring the AC internal resistance of assembled batteries using 1 kHz impedance measurement. IEC 61960-3:2017 offers a similar definition by following the JIS method⁵⁾. The standard is excerpted below.

The alternating RMS voltage, U_a , shall be measured while applying an alternating RMS current, I_a , at the frequency of $1,0 \text{ kHz} \pm 0,1 \text{ kHz}$, to the battery, for a period of 1 s to 5 s.

All voltage measurements shall be made at the terminals of the battery independently of the contacts used to carry current.

The internal AC resistance, R_{ac} , is given by:

$$R_{ac} = \frac{U_a}{I_a}$$

where

U_a is the alternating RMS voltage;

I_a is the alternating RMS current.

NOTE 1 The alternating current is selected so that the peak voltage stays below 20 mV.

NOTE 2 This method will in fact measure the impedance, which at the frequency specified, is approximately equal to the resistance.

On the other hand, techniques to measure the impedance with multiple frequencies, instead of a single frequency, are also well known¹¹. Measurement results are graphed on what is known as a Cole-Cole plot or a Nyquist plot (Figure 27).

With each frequency band, the different physics dominates the impedance of the lithium ion batteries. For example, Li-ion migration in electrolyte mainly contributes to the impedance at high frequencies of (about 1 kHz), Li-ion diffusion within the electrode at low frequencies (less than Hz), and Li-ion transfer reactions at intermediate frequencies (1 Hz to several hundred hertz). Consequently, it is possible to evaluate various phenomena in different parts of the battery by conducting a detailed analysis of the battery's impedance. Equivalent circuit analysis using an equivalent circuit model such as that illustrated in Figure 28 is a typical analytical technique⁶. In the circuit model, individual phenomena inside the battery are modeled with equivalent circuit elements. The element values calculated by the analysis can be considered to indicate the characteristics of the physical phenomena represented by the elements.

¹¹ This technique is well known as Electrochemical Impedance Spectroscopy, or EIS.

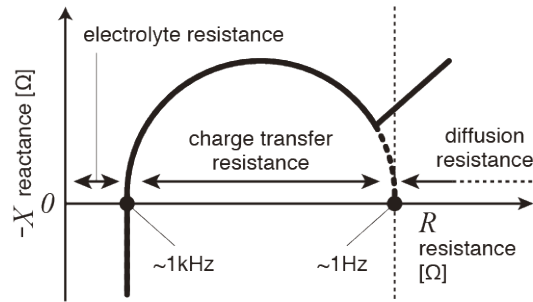

Figure 27. Example Cole-Cole plot for a lithium-ion battery

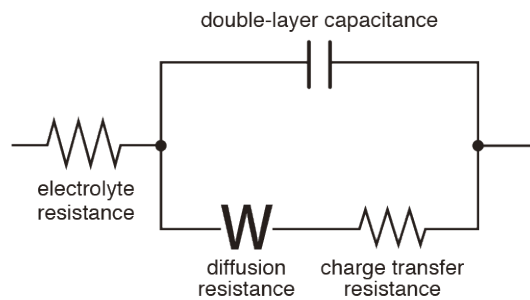

Figure 28. Example equivalent circuit for a battery

HIOKI provides a variety of battery impedance measuring instruments that can accommodate various battery voltage and measurement frequency ranges. This section introduces some key considerations when choosing an instrument and measurement method. Because large-capacity lithium-ion batteries in particular have a minuscule internal impedance of 1 m Ω or less, accurate measurement is not a simple process. Caution is necessary when choosing the instrument and measurement method.

(1) Measurement method

Low-impedance measurement generally uses the 4-terminal method instead of the 2-terminal method. This approach allows accurate, stable measurement that eliminates the influence of the measurement probes' wiring resistance and contact resistance¹².

(2) Influence of induction fields

The applied current causes an eddy current to flow in surrounding metal, creating an induction field. Caution is necessary since this induction field will become a source of measurement error if it enters the loop created by the voltage measurement line (Figure 29). This phenomenon is unique to AC measurement and does not occur with DC.

For example, when measuring large batteries such as those used in EVs, the electrodes are necessarily further apart due to the size of the battery. Consequently, the loop created by the voltage measurement line has a larger area. When measuring a battery such as this, an induction field from the battery's metal components is caused by the measurement

¹² See also section 3.-1 for more information about the 4-terminal method.

current. The field becomes a source of measurement error.

The following measures may be taken to reduce the influence of induction fields.

a. Twisted cable

It is effective to twist current cables together and voltage cables together over as much of their overall length as possible. Twisting current cables together cancels the magnetic field produced by the current and decreases the magnetic field that leaks externally. Twisting voltage cables is effective because it can decrease the area of the loop that magnetic fields enter. Furthermore, this approach can reduce the influence of eddy currents and other external magnetic fields.

b. Keeping cables and batteries away from metallic objects

The further current and metallic objects are kept apart, the better the influence of induction fields can be reduced. Exercise caution with regard to metallic components in measurement equipment and in working bench, and try to keep as much distance as possible.

c. 4-terminal-pair method

It is also effective to choose a measurement system that uses the 4-terminal-pair method instead of the 4-terminal method (Figure 30). When using the 4-terminal-pair method, a current with the same magnitude flows in the reverse direction to the measurement current shielding. Consequently, the magnetic field caused by the current for the most part does not leak externally, allowing its influence to be reduced in the extreme.

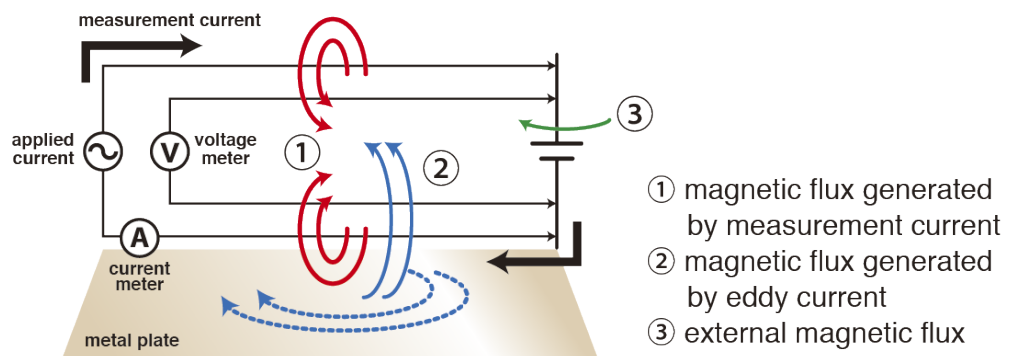

Figure 29. Four-terminal method

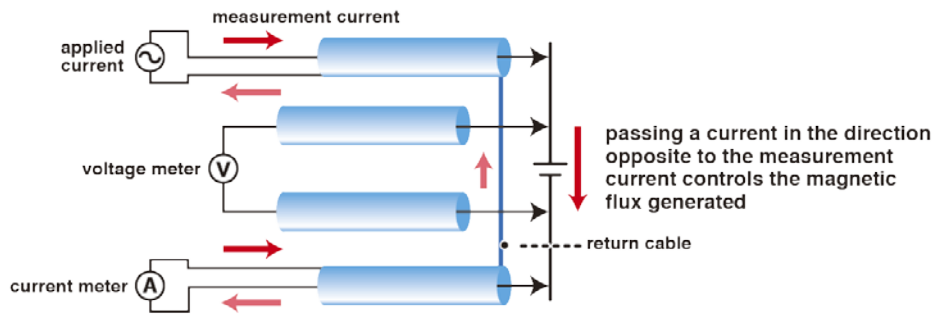

Figure 30. Four-terminal-pair method

d. Changing the measurement frequency

Lowering the measurement frequency is also effective. As described above, it is standard practice to use a frequency of 1 kHz in impedance measurement. The influence of eddy currents increase with frequency, and the influence on measured values at 1 kHz are not insignificant. For example, the influence of eddy currents can be reduced significantly by using a frequency of 100 Hz, which is one-tenth of 1 kHz. Since lower frequencies mean increased cycle time, it is a good idea to choose a frequency that balances both considerations.

(3) Applied current values

It is necessary to determine the applied current value based on the battery's impedance value. The lower the battery's impedance, the larger the current that must be applied in order to ensure stable measurement. However, batteries' I-V characteristics are fundamentally non-linear (Figure 31), and applying too large a current will cause that nonlinearity to manifest itself in an undesirable manner. The amplitude of the AC voltage generated at the batteries' terminals should be limited to a level at which linearity is maintained (Figure 32).

In general, the applied AC voltage should be limited so that it is less than $20 \text{ mV}_{\text{p-p}}$ when performing AC impedance measurement of an electrochemical system. For example, the applied current should not exceed about 7 A_{rms} if the battery's impedance is $1 \text{ m}\Omega$ (Equation [5]). A good approach to follow when considering the current value to apply is to assume that a current value that results in a battery voltage fluctuation of about 5 to $10 \text{ mV}_{\text{p-p}}$ is appropriate, and increase the current value if measured values exhibit poor S/N characteristics. If an adequate S/N ratio can be maintained, the current value can be reduced without issue.

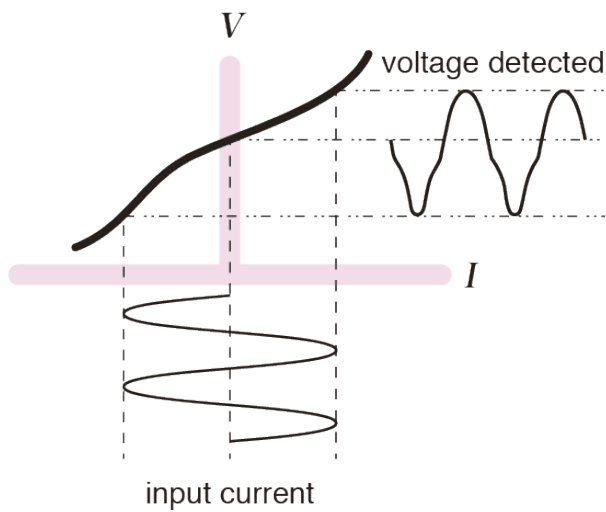

Figure 31. Distortion in the detected voltage when the measurement current is too large

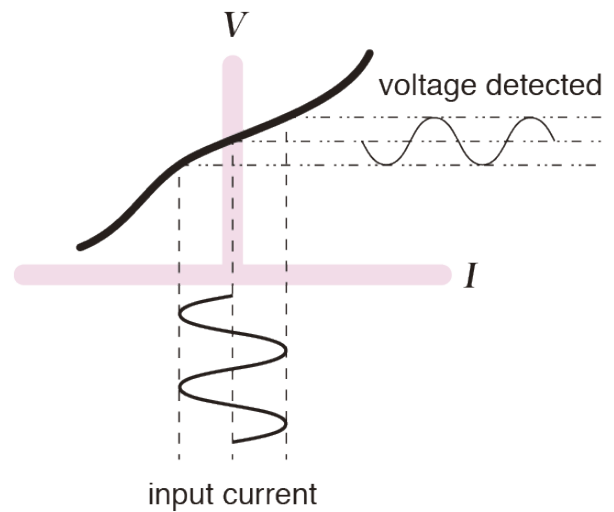

Figure 32. Detected voltage when the measurement current is appropriate

$$\frac{20.0 \text{ [mV]}}{2\sqrt{2}} \div 1.0 \text{ [m}\Omega] \doteq 7.0 \text{ [A}_{\text{rms}}] \quad (5)$$

(4) Measurement frequency and maximum input voltage

There are two types of impedance measurement systems: one type that uses a single frequency of 1 kHz as described in IEC 61960-3, and another that provides frequency sweep functionality. The latter is used in detailed analysis of battery characteristics, for example with Cole-Cole plot and equivalent circuit analysis. To perform frequency sweep measurement, it is needed to choose a measurement system that provides the necessary measurement frequency band since frequency characteristics vary depending on the type of battery. Note that the battery may be charged or discharged by the measurement current, specifically during low-frequency impedance measurement. As a result, the battery's state of charge may change before and after measurement if measurement is not started and stopped at appropriate times. Functionality for stopping measurement at measurement signal zero-cross events provides an effective means of preventing this issue (Figure 33).

In addition, it is necessary to choose a measurement system that meets the battery's voltage. The measurement system's maximum input voltage should be about 5 V for cell testing and about 1000 V at the maximum for testing of EV battery packs. Caution is necessary concerning the input voltage rating.

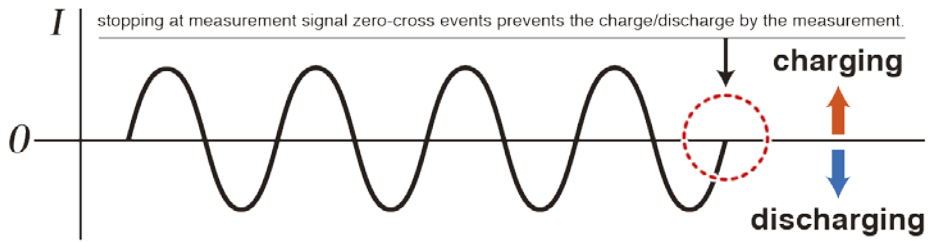

Figure 33. Measurement signal zero-cross stop function

(5) Contact with battery terminals

When specifically measuring low impedance, it is also necessary to exercise caution with regard to the contact of the probes with the DUT.

In the 4-terminal method and the 4-terminal-pair method, separate terminals are used to apply the measurement current and to measure the voltage. Due to a steep potential gradient near the current terminals, the fluctuation in measured values caused by misalignment of the voltage terminals will increase. The following practices are important in order to measure low resistance with good reproducibility(Figures 34, 35, and 36):

- Maintain a certain minimum distance between voltage and current terminals.
- Keep that distance constant during measurement.
- Make contact between the DUT and each probe at a single point.
- Make contact at the same locations each time.

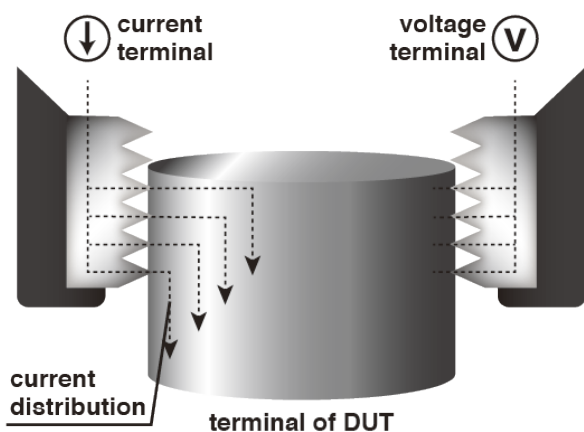

- ☹️ probing points too close
- ☹️ multiple point contact

Figure 34. Influence of multi-point contact

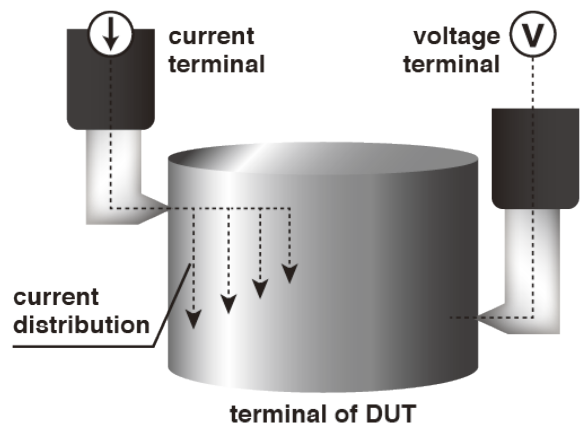

- ☺️ probing point not too close
- ☺️ constant distance between probes
- ☺️ one-point contact

Figure 35. Reproducible contact method

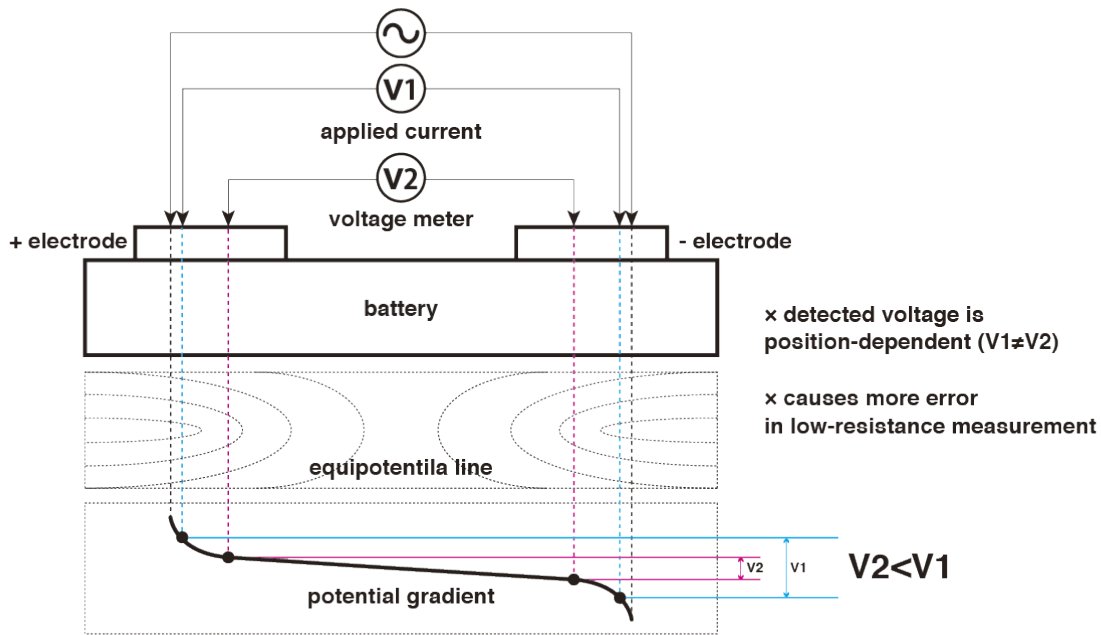

Figure 36. Effects of current terminal and voltage terminal contact position

(6) Key considerations when choosing a battery tester

The following summarizes key considerations when choosing a HIOKI battery tester based on the above:

• Measurement frequency

single frequency of 1 kHz: 3561, BT3562, BT3563, BT3564, BT3554

capable of frequency sweep operation: BT4560 (0.1 Hz to 1050 Hz*), IM3590 (0.001 Hz to 200 kHz)

*Band can be expanded to 0.01 Hz to 1050 Hz on a special-order basis.

In shipping and acceptance inspection line use, instruments that use a single frequency of 1 kHz are generally used. In such applications, instruments can be chosen on the basis of input voltage and impedance range.

To conduct a more detailed evaluation of batteries' internal characteristics, it is desirable to use an instrument that is capable of frequency sweep operation. Good choices include the IM3590 to measure across a broad frequency range and the BT4560 to measure low impedance accurately while sweeping through multiple frequencies (Figure 37).

• Impedance range

0.1 $\mu\Omega$ to 100 m Ω : BT4560*

0.1 $\mu\Omega$ to 3000 Ω : BT3562, BT3563, BT3564

1 $\mu\Omega$ to 3 Ω : BT3554

10 $\mu\Omega$ to 3 Ω : 3561

10 m Ω to 10 Ω : IM3590

*Range can be increased to 3 Ω on a special-order basis.

In general, internal resistance decreases as batteries increase in size. Large batteries such as those used in EVs can have the impedance value of less than 1 mΩ. The BT4560 or BT3562 would be good choices to measure them.

- Other

If you need an instrument that you can carry around with you, the BT3554, a portable design, is an excellent choice (Figure 38).

With the exception of the BT3554, all battery testers can perform multichannel measurement using the SW100x series of scanners. This solution is effective when you wish to measure the internal resistance of multiple batteries.



Figure 37. Battery Impedance Meter BT4560 and Chemical Impedance Analyzer IM3590



Figure 38. Battery Tester BT3554

5. Battery modules and battery packs (performance evaluation at the finished-product level)

-1. Total resistance testing of battery modules and battery packs

Although finished cell batteries are sometimes embedded in equipment as individual cells, most are assembled into modules or packs consisting of anywhere from two to dozens of cells (Figure 39). Total voltages of battery packs designed for use in compact devices range from several volts to dozens of volts. Recent years have seen increasing commercialization of high-voltage packs with voltages ranging from dozens to hundreds of volts as a result of the increase in electrically powered vehicles such as xEVs and electric carts. Typical total voltages of battery packs include 24 V, 48 V, 72 V, and 300 V.

As of 2020, the most popular commercially available EV in Japan is equipped with 192 laminated cells, 2 in parallel and 96 in series (for some models 3 in parallel and 96 in series, 288 cells in total). The total voltage of the battery pack is about 350 V.

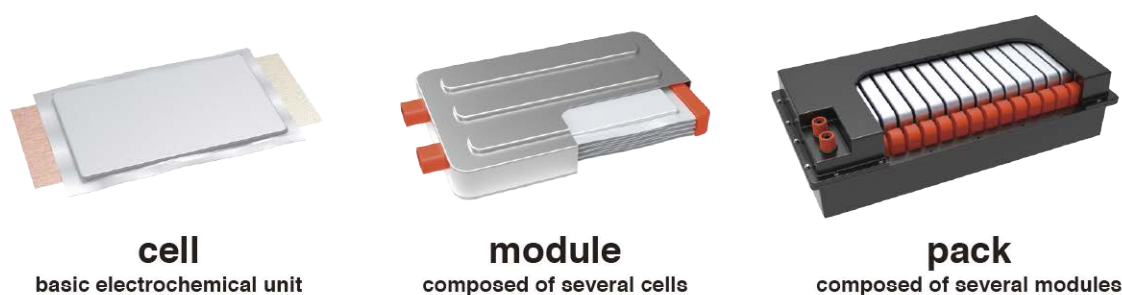

Figure 39. Examples of laminated lithium-ion battery configurations

When multiple single-cell batteries are connected, the following types of electrical testing are required:

- (1) Quality control for the weld/connections between the terminals (tabs) of cell batteries during the modularization process (resistance measurement)
 - a. To make accurate measurements of low-voltage modules (DC Resistance Meter RM3545)

During the modularization process, the terminals (tabs) of multiple cell batteries are connected together, for example by fastening or by welding them to a metal busbar. Since even minuscule resistance values lead to high energy loss when large currents flow to batteries, it is extremely important to ensure the quality of connections between terminals in order to take maximum advantage of battery performance. It is desirable that welds have extremely low resistance. The internal resistance of a cell battery is about 20 m Ω for a standard 21700 type cylindrical lithium-ion battery and less than 1 m Ω for a large laminated pouch-type lithium-ion battery. Consequently, quality control of weld resistance demands super-low resistance values of 0.1 m Ω or less. It is necessary to choose a resistance meter with a resolution of 1 $\mu\Omega$ or less that is well suited to low-resistance

measurement¹³.

Since both terminals at the weld share the same potential, no voltage will occur between the measurement terminals if measurement is performed properly. It is best to use a DC resistance meter to measure weld resistance at high precision under such conditions. In particular, HIOKI's DC Resistance Meter RM3545 excels at accurately measuring 0 Ω without zero adjustment, making it ideal for use in high-precision quality control of weld resistance¹⁴.

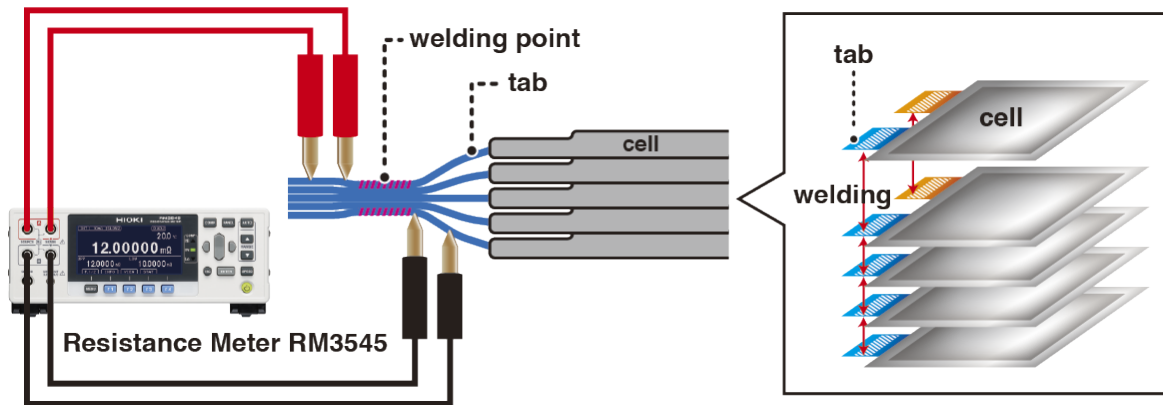

Figure 40. Tab weld resistance measurement in multiple cells

- b. To safely measure high-voltage modules (Battery Tester BT3562/BT3563/BT3564)

Caution is necessary with regard to the DUT's voltage when measuring the weld resistance of battery modules. For example, a module in which 20 cells are connected in series would have a maximum voltage of about 74 V across its terminals. The module voltage could be inputted to the instrument if busbar connections are incorrect or if a measurement probe is inadvertently placed in contact with a terminal. Ordinarily, DC resistance meters are not designed to handle this type of voltage input, so excessively large voltage input can damage the instrument.

To emphasize safety and prevent such accidents caused by excessive input, it is recommended to use a battery tester (AC resistance meter) that combines high voltage resistance with high-precision resistance measurement capability, for example the BT3562 (60 V), BT3563 (300 V), or BT3564 (1000 V), instead of a DC resistance meter. Since such use involves measuring extremely low resistance values, it is advisable to perform zero adjustment accurately when using a battery tester.

¹³ See also "4.1 Weld resistance testing of terminal/tab-lead"

¹⁴ For more information about techniques for accurately measuring low resistance, see reference ⁸⁾.

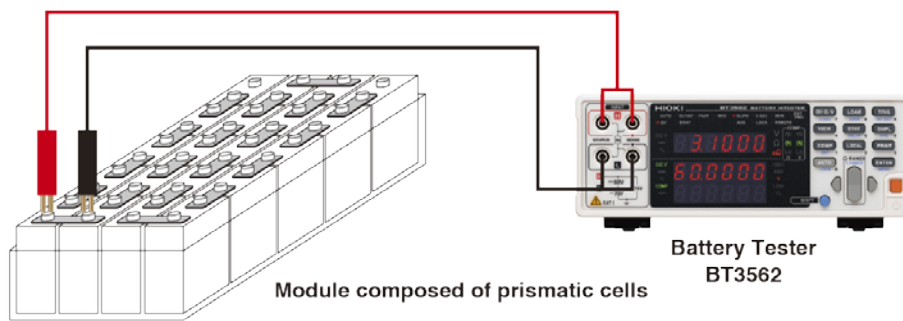

Figure 41. The Battery Tester BT3562 series is capable of safe resistance measurement.

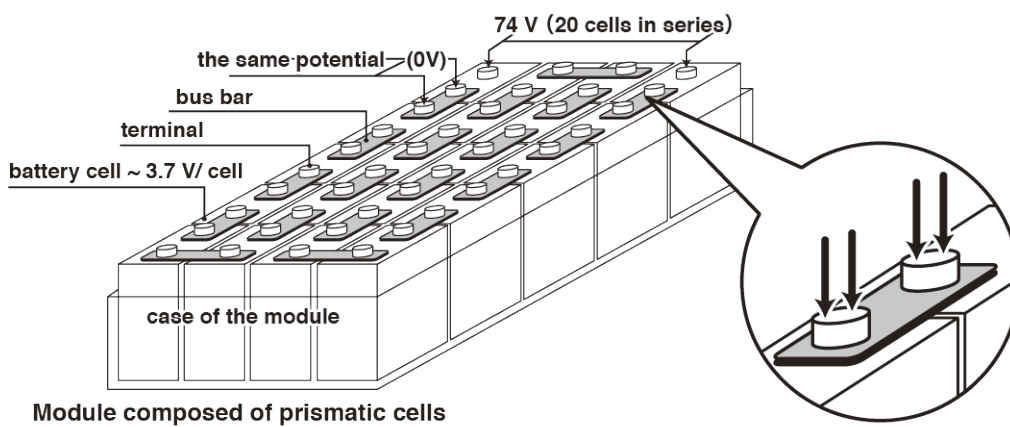

Figure 42. Measuring the resistance of busbar connections in a square LIB module

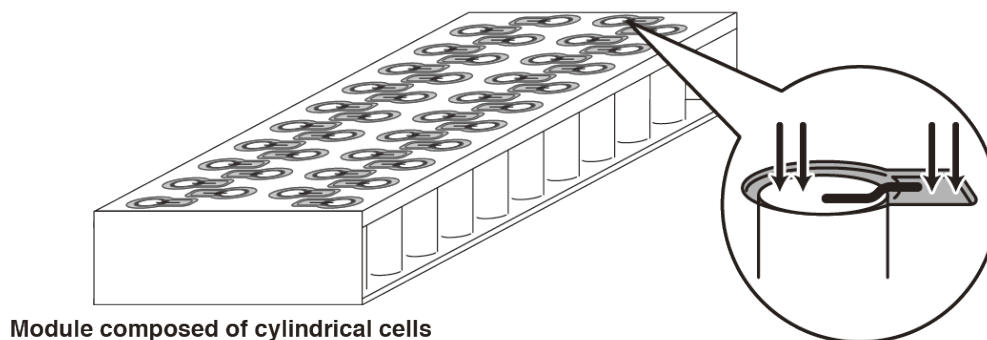

Figure 43. Measuring the resistance of busbar welds in a cylindrical LIB module

(2) Total resistance testing of modules and packs

As a final evaluation, assembled batteries are subjected to total resistance measurement and OCV measurement. These tests are primarily carried out during shipping and acceptance inspections. Since total resistance includes the battery's internal resistance, it must be carried out using the AC method. Although the cell battery voltage is about 4 V,

module and unit battery voltage values include 48 V, 350 V, and 1000 V. It is necessary to choose a measuring instrument with a rated input voltage that exceeds the DUT's total voltage and terminal-to-ground voltage.

- 3561: 20 V max.
- BT3562 60 V max.
- BT3563 300 V max.
- BT3564 1000 V max.

-2. Testing of BMS boards

Battery packs incorporate BMS boards¹⁵ that monitor and control individual cells. In order to maximize the battery's performance, it is essential to ensure that the BMS carries out battery control in an optimal manner.

BMS boards play the following roles:

- Measuring cell voltage

The BMS measures cell voltages in order to detect overvoltage and low-voltage conditions in cells (in other words, in order to detect excessive charging and discharging of the battery). This function makes it possible to use the battery pack within a safe voltage range.

- Cell balancing

Characteristics always vary from cell to cell. Even if the variation of the characteristics is fairly small, leaving for a long time or repeated charge/discharge during use can lead to significant differences in cell's remaining capacity. Functionality for regulating battery packs and modules under these conditions so that individual cells have the same remaining capacity is known as cell balancing. Balancing prevents abnormal cell states such as excessive charge/discharge of the battery.

Two techniques are used to accomplish cell balancing: active cell balancing and passive cell balancing.

Active cell balancing is a technique for balancing cells by using a transformer to move energy from cells with high remaining capacity to cells with low remaining capacity or to the master charge circuit (thereby recovering energy). By contrast, passive cell balancing is a technique for using resistors to discharge cells with high remaining capacity and align their capacity with cells with low remaining capacity. Active cell balancing is superior from an energy efficiency standpoint. However, the large number of components needed to perform active cell balancing makes it no match for passive cell balancing from the standpoint of cost and failure rate (reliability). Currently, passive cell balancing is the more common of the two techniques.

- Measuring battery temperature

BMS boards measure the surface temperature of the battery in order to detect abnormal heating. In addition, this information is necessary in order to estimate the battery's remaining capacity since battery characteristics are temperature-dependent.

- Estimating the battery's state of charge (SOC) and state of health (SOH)

Some BMS boards provide functionality for estimating the battery's remaining capacity and health in order to facilitate safer use. There are a wide range of estimation techniques, and a variety of R&D is ongoing.

¹⁵ BMS: Battery management system. It is also called a battery management unit (BMU).

In addition, some BMS boards also detect anomalies by measuring the charge current or the battery pack's total voltage.

In this way, BMS boards provide an extensive range of complex and important functionality, and it is extremely important to test that functionality. Manufacturers carry out such testing during BMS development and, for important functions, during BMS manufacture.

In order to test BMS operation, it is necessary to connect a battery or an equivalent device to the BMS. Naturally, an actual battery may be used to perform such tests (Figure 44). However, testing cannot be conducted under the same conditions because battery characteristics vary greatly with the condition of the battery (state of charge, temperature, health, etc.). For this reason, actual batteries are not well suited to use in quantitative testing. Additionally, although it is necessary to check operation of BMS functions under a large number of conditions, it is not possible to create batteries with the desired characteristics. Even if testing only involved varying the battery's voltage, this process would take time due to the need to actually charge and discharge the battery, making it inefficient. Use of actual batteries should be avoided if you wish to carry out quantitative and reproducible testing .

Testing can be carried out without using an actual battery. Your first thought might be to connect a power supply to the BMS. You could input a voltage simulating the behavior of a battery from the power supply to the BMS and test whether the BMS accurately assesses the battery's behavior. However, you would have to connect one power supply for each of the battery's cells in order to check the BMS board's battery voltage monitor functionality. In order to simulate current and temperature measured values, you would need even more power supplies. Complex control would be required for all of these power supplies to simulate the battery's behavior, and implementing that control would likely impose significant costs in terms of time and money.

Additionally, although high voltage output precision would be required in order to test BMS ICs, which have been becoming increasingly precise in recent years, there are not many commercially available power supplies that deliver that level of precision. It would not be impossible to address the voltage precision issue if high-precision voltmeters and multimeters were connected in parallel with the power supplies. However, the control logic would become more complex as the number of devices being used increased even further as a result. With increasing costs posing another problem, it would not be realistic to use this approach to carry out large-scale testing.

Fortunately, multichannel, high-precision voltage generators that are capable of resolving problems such as the above are commercially available. Some of those devices are specialized for BMS testing, and they offer numerous channels per unit along with simplified control (Figure 45).

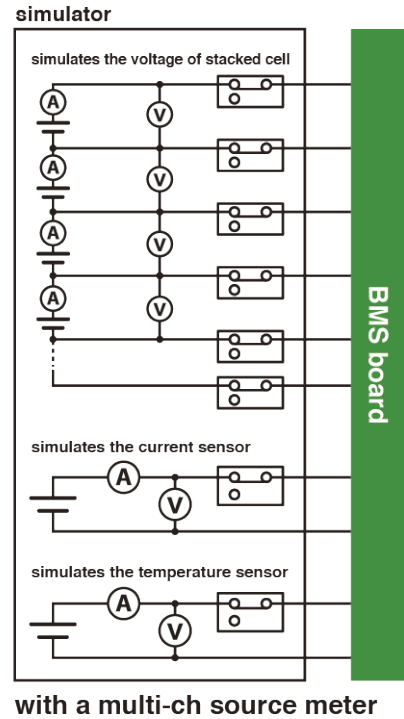
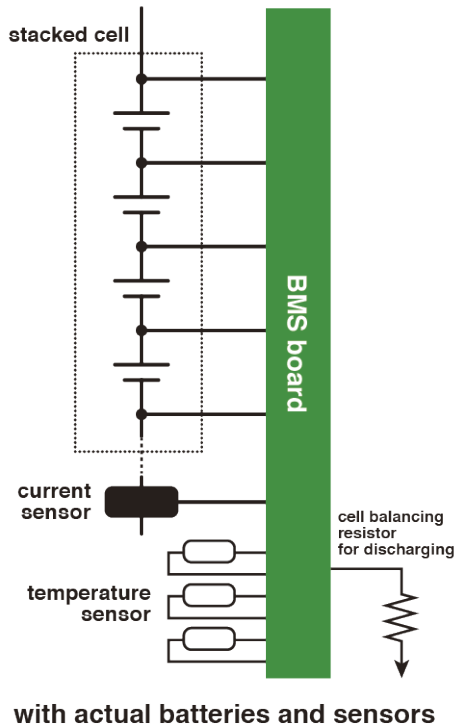

Figure 44. An evaluation device using an actual battery and sensors

Figure 45. Example architecture of a simulation system

The following precautions should be taken with regard to a BMS testing system:

- Accuracy specifications

As noted above, BMS ICs have become more precise in recent years. Consequently, it is desirable that BMS testing systems be capable of high-precision voltage generation and measurement. At a minimum, such systems must have higher precision than the IC's voltage measurement precision.

- Maximum output current

BMS testing systems must have enough performance to output at least the current that flows to the BMS during cell balancing.

Since active cell balancing involves comparatively large currents (on the order of several amps), it is desirable that BMS testing systems be capable of outputting large currents. In addition, since current must be provided to cells with low remaining capacity from cells with high remaining capacity, BMS testing systems must provide a bidirectional power supply (with sink functionality).

By contrast, since passive cell balancing uses lower currents compared to active cell balancing (on the order of several hundred milliamperes), BMS testing systems used with that approach need not be capable of outputting currents as large as for active cell balancing. Since passive cell balancing relies on discharge via resistance, source functionality alone is sufficient.

- Maximum rated terminal-to-ground voltage (maximum connectable voltage)

BMS boards use two types of architecture: one in which one BMS board is connected to the entire battery pack, and another in which a BMS board is connected to each module. With regard to the former in particular, there is increasing need for testing systems that can simulate battery packs during testing. Since large-scale battery packs have large numbers of cells connected in series, they must be tested by connecting multiple BMS testing systems in series. Note that it is not possible to connect just any number of BMS testing systems in series. The maximum voltage that can be simulated is constrained by either the maximum connectable voltage or the ground-to-terminal voltage as defined in the product specifications, and that voltage must be lower than the pack's overall voltage.

- Measurement of minuscule currents

In order to facilitate more efficient use of batteries, BMS boards rely on innovations to decrease leakage current from switches in cell balancing circuits, standby current (current consumed when the system is powered on but not operating), and dark current (current consumed when the system is not powered on). In some cases, it is necessary to test whether the BMS is behaving according to its design with regard to not only current consumption during operation, but also these minuscule currents. However, since standby current and dark current are extremely small compared to the currents that flow during cell balancing, they cannot be precisely measured using the current range utilized to measure cell balancing currents. The minuscule current would be nearly indistinguishable at the maximum resolution of such ranges, making them mostly unmeasurable. Testing systems that provide a range for measuring minuscule currents, in addition to ranges for measuring operating currents, are well suited to use in this application.

- Wire break simulation

In the event that electrical contact between the battery and the BMS IC is interrupted, for example due to a wire break in a cable connecting the battery to the BMS or due to a component defect on the BMS board, the BMS IC will lose its ability to measure cell voltages and perform cell balancing. In such cases, the battery could enter a dangerous state due to factors such as excessive charging and excessive discharge. Consequently, most BMS boards provide functionality for detecting such wire break states as quickly as possible. Wire break detection testing is a simple proposition if you use a testing system that provides functionality for simulating wire break states.

- Resistance generation

In most cases, thermistors are used by BMS boards to measure battery temperature. In such implementations, temperature measurement is accomplished by measuring the thermistor's electrical resistance value and then converting that value to a temperature. Consequently, it is convenient to use a testing system that provides resistance generation functionality when testing temperature measurement circuits.



Figure 46. HIOKI's BMS testing system

-3. Actual-load testing of batteries in EVs

When a battery will be used under high-speed, high-current loads, for example in an EV, it is important to measure the characteristics of the battery pack while it is embedded in the host device. Testing that relies on impedance measurement and charge/discharge capacity measurement is not capable of accurately assessing battery characteristics in the event of high-speed, high-current use. Carrying out tests while the battery is under actual load offers an effective alternative.

It is effective to use a power analyzer (power measurement instrument) in such tests. For example, it is typical to measure current and voltage at the downstream inverter and motor as well as at the battery pack, as illustrated in Figure 47. In this type of setup, not only the battery's actual-load characteristics, but also the energy consumed by downstream components such as the inverter and motor and energy conversion efficiency are measured.

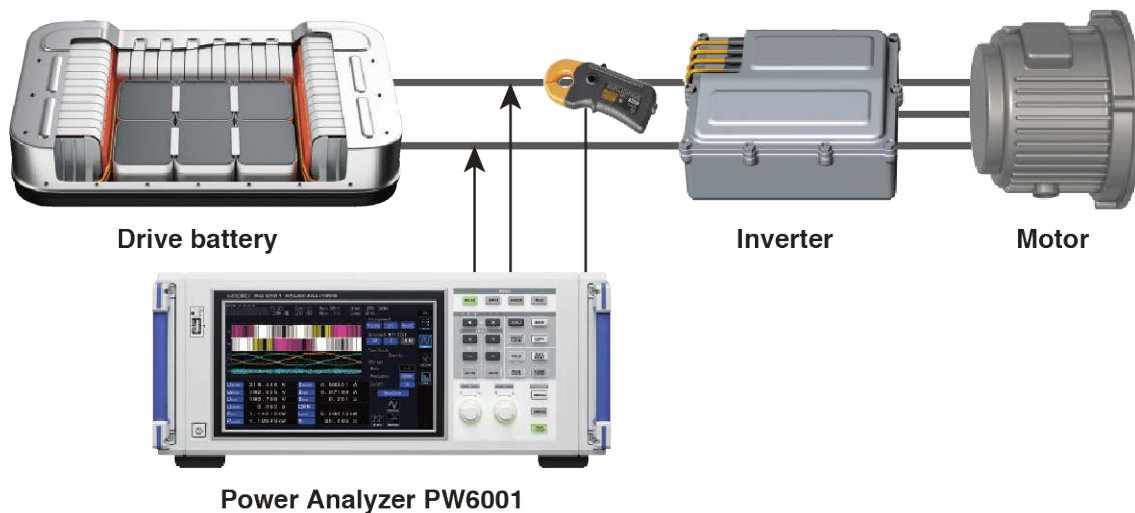

Figure 47. Measuring the power of an EV inverter motor

Let's examine the capabilities that a power analyzer used to measure the actual-load characteristics of a battery must provide.

(1) Current measurement method

Current can be measured in two ways: one using a shunt resistor (the direct-input method) and the other using a current sensor (the sensor method). Generally speaking, the direct-connection method is suited to measurement of small currents, while the sensor method is suited to measurement of high-frequency and large currents. Because large currents flow to motor inverter inputs, and because such currents carry superposed high-frequency ripple, it is effective to use current sensors.

Current sensors can be broadly classified as either pass-through or clamp-on designs (Figure 48). Pass-through sensors offer excellent frequency band, measurement precision, and stability. However, the need for the cable to pass through the sensor makes preparation more labor-intensive. In addition, it is extremely difficult to install current sensors

in finished vehicles, making it unrealistic to use pass-through current sensors in finished vehicle testing. Pass-through current sensors are well suited to applications that are characterized by a high degree of freedom in terms of wire routing and a need to measure power with a high degree of precision, for example test bench measurement.

By contrast, clamp-on designs are distinguished by the ease with which they can be affixed, although they cannot deliver the same frequency band and measurement precision as their pass-through counterparts. When performing testing in finished vehicles, it is advisable to choose a clamp-on design. In testing where the high precision of a pass-through sensor is not required, the convenience of clamp-on designs is likely to make a significant contribution to increased test efficiency.



Figure 48. Example of a pass-through current sensor (left) and clamp-on current sensor (right)

(2) Measurement band and accuracy

Large currents flow to motor inverter inputs, and such currents carry superposed high-frequency ripple. In order to measure power accurately, it is important that the power analyzer and current sensor offer suitable rated current, rated voltage, and measurement frequency bands. Current sensors' current ratings are defined in terms of either the peak current value or the RMS value. Caution is warranted when choosing a sensor model. If the sensor is selected without the notice above, its rating might be insufficient for the application at hand.

In inverter input power analysis applications, it is especially necessary to exercise caution with regard to the measurement frequency band. Inverters generate high-frequency ripple currents. Because such ripple currents cause heating of battery packs and can degrade their performance, evaluation is necessary. Since the ripple currents' frequency band includes harmonics of the inverter's switching frequency, it is desirable to use a current sensor whose band is at least 5 times the inverter switching frequency to facilitate accurate evaluation.

The magnitude of the ripple current is evaluated using the current ripple rate I_{rf} , as expressed in Equation [6]. Current ripple rate is an important indicator of inverter performance.

$$I_{rf} = \frac{I_{pk+} - I_{pk-}}{2 \times |I_{dc}|} \times 100 \quad [\%] \quad (6)$$

I_{pk+} : current waveform peak (+), I_{pk-} : current waveform peak (-), I_{dc} : current simple average

(3) Functionality required by the WLTP, a new fuel efficiency standard

Test cycles and methods related to automotive fuel efficiency long varied by country and region, necessitating a

regime of fuel efficiency tests that complied with each set of regulations in powertrain development. Recently, the Worldwide harmonized Light vehicles Test Procedure (WLTP) has been established as a unified worldwide standard as part of an effort to standardize test methods. Individual countries are free to determine for themselves when to bring the WLTP into force. Countries are currently considering adopting WLTP as a standard testing method in order to promote exports. It is already being widely utilized by companies as a standard testing method.

In WLTP-compliant testing, it is necessary to measure energy consumption [Wh] when EVs, xEVs (HEVs, PHEVs) and FCVs are driven in predefined patterns. These measurements are made using finished vehicles. Testing includes all type of batteries; lead-acid batteries, fuel cell batteries, Li-ion batteries, and nickel-metal hydride batteries. The method was developed against the backdrop of strong social pressure to reduce the environmental impacts of automobiles, and its measurements are designed to calculate CO₂ emissions.

When carrying out WLTP-compliant testing, it is necessary to exercise caution with regard to the need to choose a current sensor and watt-hour meter that fulfill WLTP requirements. Table 3 summarizes the capabilities that the WLTP requires of power analyzers and current sensors used in power measurement. The ability to measure load currents that fluctuate dynamically from large currents to minuscule currents with a high degree of accuracy is essential. Power measurement systems that consist of high-accuracy clamp-on current sensors and high-accuracy power meters from HIOKI offer features such as those listed below, indicating that they are well suited to WLTP-compliant power measurement:

- High-accuracy clamp-on current sensors: Clamp-on current sensors are ideal since they can be used to measure currents in finished vehicles. High-accuracy clamp-on current sensors from HIOKI satisfy the WLTP's measurement accuracy requirements.
- Power meters with exceptional measurement accuracy: In order to accurately calculate current and voltage integrated values, it is important that power meters be able to measure DC currents with a high degree of accuracy and that they can refresh data at high speeds. HIOKI's high-accuracy power meters are designed to maximize DC measurement accuracy, and they offer exceptional DC characteristics. In addition, they boast data refresh rates of up to 10 ms, and they can maintain their highest accuracy under those operating conditions.
- Phase correction functionality: HIOKI's power meters can correct current sensors' high-frequency phase characteristics mathematically. This function is uniquely possible because HIOKI develops both current sensors and power meters by themselves, and it dramatically improves power measurement performance at high frequencies, including in the ripple current frequency band.

Table 3. WLTP requirements⁷⁾

Parameter	Measurement accuracy	Measurement resolution
Energy [Wh]	±1 %	0.001 kWh
Current [A]	±0.3 % of full scale or ±1 % of reading	0.1 A
Voltage [V]	±0.3 % of full scale or ±1 % of reading	0.1 V

Conclusion

This guide has introduced considerations that should be taken into account concerning measurement systems needed to evaluate the performance in lithium-ion battery production processes. Large lithium-ion batteries have been commercialized, and the scope of the applications in which they are being used is increasing with each passing year. There will be high demand for batteries with even higher performance in the future, including in terms of high safety, high output, and long service life. Quality control in production processes plays a key role in ensuring a stable supply of high-performance batteries.

References

- 1) E. Ligneel, B. Lestriez, O. Richard, D. Guyomard, J. Phys. Chem. Solids, 67, 1275 (2006)
- 2) T. J. Patey, A. Hintennach, F. La Mantia, P. Novák, J. Power Sources, 189, 590 (2009)
- 3) C.-C. Li, Y.-S. Lin, J. Power Sources, 220, 413 (2012)
- 4) HIOKI E.E. CORPORATION, *Insulation Resistance Measurement Handbook* (2020)
<https://www.hioki.com/file/cmw/hdCatalog/4942/pdf/?action=browser&log=1&lang=en>
- 5) IEC 61960-3:2017 Secondary cells and batteries containing alkaline or other non-acid electrolytes - Secondary lithium cells and batteries for portable applications - Part 3:
Prismatic and cylindrical lithium secondary cells and batteries made from them
- 6) N. Oyama (ed.), *Evaluating the Performance of lithium-ion Batteries*, Nikkan Kogyo Shimbun (2019), in Japanese
- 7) ECE/TRANS/WP.29/GRPE/2016/3, Proposal for amendments to global technical regulation No. 15 on Worldwide harmonized Light vehicles Test Procedure (WLTP)
- 8) HIOKI E.E. CORPORATION, *Resistance Measurement Handbook* (2020)
<https://www.hioki.com/file/cmw/hdCatalog/4884/pdf/?action=browser&log=1&lang=en>

(MEMO)

HIOKI Profile

About HIOKI

HIOKI E.E. CORPORATION is a manufacturer of electrical measuring instruments that was founded in 1935. Products in four categories--data recording equipment, electronic measuring instruments, field measuring instruments, and automatic test equipment--feature proprietary technologies. Our Head Office in Ueda, Nagano Prefecture, brings together R&D, manufacturing, maintenance, and service departments, allowing us to offer high-quality instruments and fine-grained service.

Product calibration and repair

If you encounter an issue or malfunction with a HIOKI product, please submit a repair request through your distributor. Even when products are discontinued, we continue to offer repair service for a minimum of five years from the date of discontinuation. If a malfunction for which HIOKI is responsible occurs while the product is covered by its warranty, which begins on the date of purchase, we will repair or replace it free of charge.

Calibration and adjustment service

We recommend that instruments be calibrated regularly, about once a year, to ensure that customers can use them with peace of mind. When you have us calibrate your instrument (through our general calibration service), our experts will perform the calibration in accordance with ISO 9001 and issue you a report of results. If there is an error between the reference standard's ideal value and the value indicated by your instrument, we can also adjust the instrument to correct that divergence. HIOKI recommends that calibration and adjustment be performed together.

JCSS calibration (ISO/IEC 17025 certified calibration)

In addition to general calibration, we offer JCSS calibration service in accordance with ISO/IEC 17025 for some instruments. Calibration certificates issued at the time of JCSS calibration are international MRA-compliant, so they are valid outside Japan, too.

List of sales offices

Branch offices in Japan

Tohoku Sales Branch, Nagano Sales Branch, Kanazawa Office, Greater Tokyo Sales Branch, Yokohama Sales Branch, Atsugi Office, Shizuoka Sales Branch, Nagoya Sales Branch, Osaka Sales Branch, Hiroshima Office, Fukuoka Sales Branch

Overseas sales subsidiaries

U.S., China, Singapore, South Korea, India, Germany, Taiwan

Publication of this document

HIOKI E.E. CORPORATION <https://www.hioki.com/en/>

Initial edition published February 26, 2020