

HIOKI

Instruction Manual

BT4560

BATTERY IMPEDANCE METER

HIOKI E. E. CORPORATION

November 2014 Edition 1 BT4560A981-00 14-11H



600441620

Contents

Introduction.....	1
■ Registered trademark	1
Verifying Package Contents	1
Safety Information	3
Operating Precautions	6

1 Overview 11

1.1 Product Overview and Features	11
1.2 Names and Functions of Parts	12
1.3 Screen Configuration and Operation	15
■ Measurement screen	15
■ Settings screen	15
1.4 Measurement Flow	16

2 Preparation 17

2.1 Connecting the Power Cord.....	17
2.2 Connecting the Measurement Probe and Temperature Sensor (Optional)	18
■ Connect the four-terminal cable to the instrument	18
■ Connect the temperature sensor to the instrument	18
2.3 Turning the Power ON or OFF.....	19
2.4 Inspection Before Use	19

3 Basic Measurement 21

3.1 Selecting the Measurement Functions	21
3.2 Selecting the Measurement Range	22
3.3 Setting the Measurement Speed...	23
3.4 Setting the Measurement Frequency	24
■ When the measurement time is long (Display of the Progress Bar).....	25
3.5 Performing the Zero Adjustment ..	26
■ Performing the zero adjustment.....	26
■ Connection when performing the zero adjustment	29
3.6 Checking the Measurement Results	30
■ Detecting the measurement abnormality	30
■ Temperature measurement indication	32
■ Overrange indication.....	32
3.7 Basic Measurement Examples.....	33

4 Customization of Measurement Conditions 37

4.1 Setting the Measurement Starting Conditions (Trigger Functions).....	37
■ Setting the trigger	37
■ Inputting the external trigger	38
4.2 Starting the Measurement After the Response of the Measuring Object is Stable (Sample Delay Function).....	38
4.3 Maintaining Voltage Measurement Accuracy (Self- Calibration Function)	41
4.4 Stabilizing the Measurement Values (Average Function)	42
4.5 Compensating the Potential Slope Due to Electric Discharge (Slope Correction Function).....	43
4.6 Preventing the Overcharge due to Measurement Signal (Voltage Limit Function)	45
4.7 Prevents Charging and Discharging due to the Measurement Signal (Measurement Signal Zero Cross Stop Function).....	47

5 Judging Measurement Results (Comparator Function) 49

5.1 Turning the Comparator Function ON and OFF	50
5.2 Setting the Upper and Lower Limit Value	51
5.3 Voltage is Judged with the Absolute Value	54
5.4 Checking the Judgment with Sound	55
5.5 Checking the Judgment Result	56

1

2

3

4

5

6	Saving and Reading Measurement Conditions	57			
6.1	Saving the Setting Conditions (Panel Saving Function)	58			
6.2	Reading the Setting Conditions (Panel Loading Function)	60			
6.3	Deleting the Contents of the Panel	61			
7	System Setting	63			
7.1	Making the Key Operation Effective or Ineffective	63			
7.2	Setting the Sound of the Key Operation Effective or Ineffective	65			
7.3	Adjusting the Contrast of the Screen	66			
7.4	Adjusting the Backlight	67			
7.5	System Testing	68			
7.6	Confirm Instrument Information	73			
7.7	Initializing (Reset)	74			
	■ Initial setting table	76			
8	External control (EXT.I/O)	79			
8.1	External Input/output Terminals and Signals	80			
	■ Switching the current sink (NPN) /the current source (PNP)	80			
	■ Arranging the usage connector and the signals	80			
	■ Functions of each signal	82			
8.2	Timing Chart	84			
	■ Acquiring the judgment results after starting measurement	84			
	■ Timing of the zero adjustment	87			
	■ Timing of the self-calibration	87			
	■ Timing of the panel loading	89			
	■ Output signal status when turning ON the power supply	89			
	■ Taking-in flow with the external trigger	90			
8.3	Internal Circuitry	91			
	■ Electrical Specifications	92			
	■ Examples of connection	93			
8.4	Checking the External Control	94			
	■ Testing the inputs/outputs (EXT.I/O testing functions)	94			
9	Communication (RS-232C, USB)	95			
9.1	Features of Interface	95			
	■ Specifications	95			
9.2	Connecting and Setting Method	96			
	■ Using the USB interface	96			
	■ Using the RS-232C cable	98			
	■ Setting the transmission speed (Common for USB, RS-232C)	99			
9.3	Controlling the Communication and Acquiring the Data	100			
	■ Remote state/Local state	100			
10	Specifications	101			
10.1	Specifications of Measurement Functions	101			
10.2	Additional Function	104			
10.3	User Interface	110			
10.4	External Interface	110			
10.5	Accuracy	112			
10.6	General Specifications	115			
	■ Standards	116			
	■ Accessories	116			
	■ Options	116			
11	Maintenance and Service	117			
11.1	Troubleshooting	117			
	■ Q&A (Frequent inquiries)	117			
	■ Error display and remedy	121			
11.2	Inspection, Repair and Cleaning	123			
11.3	Discarding the Instrument	124			
	■ Lithium battery removal	124			

Appendix **A1**

Appx. 1 Measurement Parameters and Calculation FormulaA1

Appx. 2 Four-terminal Pair MethodA2

Appx. 3 Cautions When Making Your Own Measurement Probe.....A4

Appx. 4 Measurement Probe Structure and ExtensionA6

Appx. 5 Measurement Value in the Four-terminal Measurement (Difference in Measurement Value Due to the Measurement Probe)A7

Appx. 6 Influence of the Eddy Current A8

Appx. 7 Zero AdjustmentA8

Appx. 8 Measurement Probe (Option)A12

Appx. 9 Precautions When Making the Switching UnitA13

Appx. 10 Precautions When Measuring the BatteryA15

Appx. 11 Calibrating the InstrumentA18

Appx. 12 Rack MountingA20

Appx. 13 Dimensional DiagramA22

Index **Index1**

6

7

8

9

10

Appx.

Index

Introduction

Thank you for purchasing the HIOKI BT4560 Battery Impedance Meter. To obtain maximum performance from the instrument, please read this manual first, and keep it handy for future reference.

Registered trademark

Microsoft and Windows are either registered trademarks or trademarks of Microsoft Corporation in the United States and other countries.

Verifying Package Contents

When you receive the instrument, inspect it carefully to ensure that no damage occurred during shipping.

In particular, check the accessories, panel switches, and connectors. If damage is evident, or if it fails to operate according to the specifications, contact your authorized Hioki distributor or reseller.

Confirm that these contents are provided.

- BT4560 Battery Impedance Meter

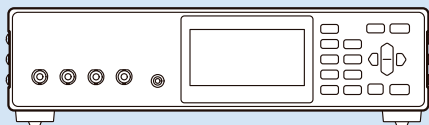

- Instruction Manual



- Power Cord

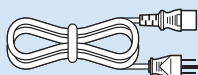

- CD (Communications Command Instruction Manual, Application Software*, USB Driver)



*The latest version can be downloaded from our website.

- USB Cable (A-B type)

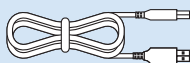

- Zero Adjustment Board



Options (p. A12)

The following options are available for the instrument. Contact your authorized Hioki distributor or reseller when ordering.

L2002 Clip Type Probe

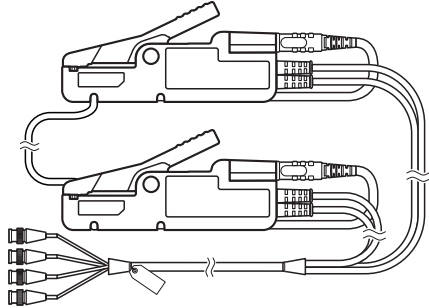

L2003 Pin Type Probe

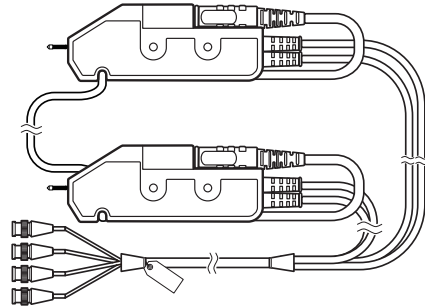

Z2005 Temperature Sensor



9637 RS-232C Cable (9pin-9pin/1.8 m)

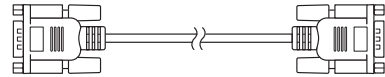

Safety Information

This instrument is designed to conform to IEC 61010 Safety Standards, and has been thoroughly tested for safety prior to shipment. However, using the instrument in a way not described in this manual may negate the provided safety features.

Before using the instrument, be certain to carefully read the following safety notes.

DANGER



Mishandling during use could result in injury or death, as well as damage to the instrument. Be certain that you understand the instructions and precautions in the manual before use.







WARNING









With regard to the electricity supply, there are risks of electric shock, heat generation, fire, and arc discharge due to short circuits. If persons unfamiliar with electricity measuring instrument are to use the instrument, another person familiar with such instruments must supervise operations.

Notation



In this manual, the risk seriousness and the hazard levels are classified as follows.

 DANGER	Indicates an imminently hazardous situation that will result in death or serious injury to the operator.
 WARNING	Indicates a potentially hazardous situation that may result in death or serious injury to the operator.
 CAUTION	Indicates a potentially hazardous situation that may result in minor or moderate injury to the operator or damage to the instrument or malfunction.
IMPORTANT	Indicates information related to the operation of the instrument or maintenance tasks with which the operators must be fully familiar.
	Indicates a high voltage hazard. If a particular safety check is not performed or the instrument is mishandled, this may give rise to a hazardous situation; the operator may receive an electric shock, may get burnt or may even be fatally injured.
	Indicates prohibited actions.
	Indicates the action which must be performed.
*	Additional information is presented below.
[]	Setting items and names on the screen are indicated in brackets [].
SET (Bold character)	Bold characters within the text indicate operating key labels.

Symbols on the instrument

	Indicates cautions and hazards. When the symbol is printed on the instrument, refer to a corresponding topic in the Instruction Manual.
	Indicates the ON side of the power switch.
	Indicates the OFF side of the power switch.
	Indicates a grounding terminal.
	Indicates DC (Direct Current).
	Indicates AC (Alternating Current).

Symbols for various standards

	Indicates the Waste Electrical and Electronic Equipment Directive (WEEE Directive) in EU member states.
	This symbol indicates that the product conforms to regulations set out by the EC Directive.

Accuracy

We define measurement tolerances in terms of rdg. (reading) and dgt. (digit) values, with the following meanings:

rdg.	(Reading or displayed value) The value currently being measured and indicated on the measuring instrument.
dgt.	(Resolution) The smallest displayable unit on a digital measuring instrument, i.e., the input value that causes the digital display to show a "1" as the least-significant digit.

Measurement categories

To ensure safe operation of measurement instruments, IEC 61010 establishes safety standards for various electrical environments, categorized as CAT II to CAT IV, and called measurement categories.

DANGER



- Using a measuring instrument in an environment designated with a higher-numbered category than that for which the instrument is rated could result in a severe accident, and must be carefully avoided.
- Using a measuring instrument without categories in an environment designated with the CAT II to CAT IV category could result in a severe accident, and must be carefully avoided.

CAT II: When directly measuring the electrical outlet receptacles of the primary electrical circuits in equipment connected to an AC electrical outlet by a power cord (portable tools, household appliances, etc.).

CAT III: When measuring the primary electrical circuits of heavy equipment (fixed installations) connected directly to the distribution panel, and feeders from the distribution panel to outlets.

CAT IV: When measuring the circuit from the service drop to the service entrance, and to the power meter and primary overcurrent protection device (distribution panel).

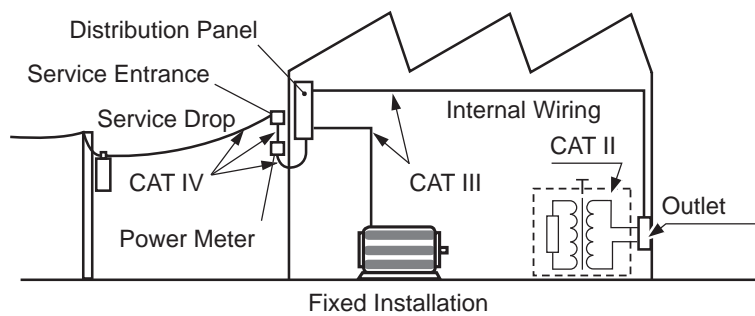

Operating Precautions

Follow these precautions to ensure safe operation and to obtain the full benefits of the various functions.

DANGER



This instrument carries a maximum electric current up to 1.5 A to the measuring object. Do not measure the primary battery. Doing so may cause damage to the measuring object.



Battery may cause ignition and damage due to overcharge/over discharge. Be certain in managing battery voltage when measuring.

WARNING



If the measurement probe or the instrument is damaged, there is a risk of electric shock. Before using the instrument, perform the following inspection.

- Before using the instrument, check that the coating of the measurement probes are neither ripped nor torn and that no metal parts of connection cord are exposed. Using the instrument under such conditions could result in electrocution. Replace the measurement probes with those specified by our company.
- Before using the instrument for the first time, verify that it operates normally to ensure that no damage occurred during storage or shipping. If you find any damage, contact your authorized Hioki distributor or reseller.

Instrument installation

Installing the instrument in inappropriate locations may cause a malfunction of instrument or may give rise to an accident. Avoid the following locations.

For details on the operating temperature and humidity, see the specifications p. 115.

WARNING



- Exposed to direct sunlight or high temperature
- Exposed to corrosive or combustible gases
- Exposed to water, oil, chemicals, or solvents
- Exposed to high humidity or condensation
- Exposed to a strong electromagnetic field or electrostatic charge
- Exposed to high quantities of dust particles
- Near induction heating systems (such as high-frequency induction heating systems and IH cooking equipment)
- Susceptible to vibration

Installation

To prevent overheating, be sure to leave the specified clearances around the instrument.

⚠ CAUTION



- Do not install the instrument with any side except the bottom facing down.
- Ventilation holes for heat radiation are provided on the side, bottom and rear panels of the instrument. Leave sufficient space around the ventilation holes and install the instrument with the holes unobstructed. Installation of the instrument with the ventilation holes obstructed may cause a malfunction or fire.

Unplugging the power cord kills power to the instrument. Be sure to provide enough unobstructed space to unplug the power cord immediately in an emergency.

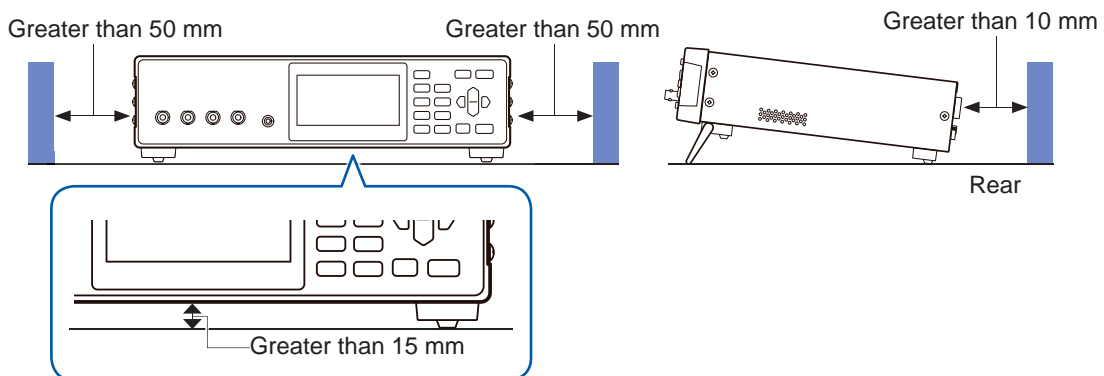

“Raising/closing the stand” (p. 13)

Handling the instrument

⚠ DANGER



To avoid electric shock, do not remove the instrument's case. The internal components of the instrument carry high voltages and may become very hot during operation.

⚠ CAUTION



- Do not place the instrument on an unstable table or an inclined place. Dropping or knocking down the instrument can cause injury or damage to the instrument.
- To avoid damage to the instrument, protect it from physical shock when transporting and handling. Be especially careful to avoid physical shock from dropping.

This instrument may cause interference if used in residential areas. Such use must be avoided unless the user takes special measures to reduce electromagnetic emissions to prevent interference to the reception of radio and television broadcasts.

Before connecting the power cord

WARNING



- Before turning the instrument on, make sure the supply voltage matches that indicated on its power connector. Connection to an improper supply voltage may damage the instrument and present an electrical hazard.
- To avoid electrical accidents and to maintain the safety specifications of this instrument, connect the power cord provided only to a 3-contact (two-conductor + ground) outlet.

CAUTION



- To avoid damaging the power cord, grasp the plug, not the cord, when unplugging it from the power outlet.
- Avoid using an uninterruptible power supply (UPS) or DC/AC inverter with rectangular wave or pseudo-sine-wave output to power the instrument. Doing so may damage the instrument.

IMPORTANT

- Turn off the power before disconnecting the power cord.
- Use only the specified power cord. Using a non-specified cord may result in incorrect measurements due to poor connection or other reasons.

Before connecting measurement probe/temperature sensor

DANGER



- To avoid electrical hazards and damage to the instrument, do not apply voltage exceeding the rated maximum to the input terminals.
- The maximum rated voltage to earth of the SOURCE-H terminal and the SENSE-H terminal is ± 5 V DC. The maximum rated voltage to earth of the SOURCE-L terminal and the SENSE-L terminal is 0 V DC. Attempting to measure voltages exceeding this level with respect to ground could damage the instrument and result in personal injury. (Do not apply voltage to earth since the SOURCE-L terminal and SENSE-L terminal where pseudo earthing is provided in the internal circuit.)
- To avoid electrical shock, be careful to avoid shorting live lines with the measurement probe.

WARNING



- To avoid injury or damage to the instrument, do not attempt to measure AC voltage, or DC voltage exceeding 5 V DC.

⚠ CAUTION

- To avoid damage to the instrument, do not apply voltage or current to temperature sensor terminal.
 - To prevent cable damage, do not step on cables or pinch them between other objects. Do not bend or pull on cables at their base.
 - The sensor used in the temperature sensor is a thin, precision platinum film. Be aware that excessive voltage pulses or static discharges can destroy the film.
 - Avoid subjecting the temperature sensor tip to physical shock, and avoid sharp bends in the sensor. These may damage the probe or break a wire.
 - When measuring high temperatures, do not let the temperature sensor exceed the specified temperature range.
-
- When disconnecting the BNC connector, be sure to release the lock before pulling off the connector. Forcibly pulling the connector without releasing the lock, or pulling on the cable, can damage the connector.

Releasing the lock

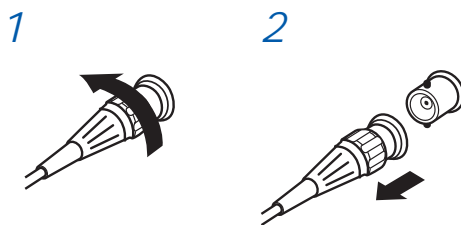

Use only the specified measurement probe and the temperature sensor. Using a non-specified one when measuring may result in incorrect measurements due to poor connection or other reasons.

Before connecting the communication cable

⚠ WARNING

- **Always turn both devices OFF when connecting and disconnecting an interface connector. Otherwise, an electric shock accident may occur.**
- **After connecting, be sure to tighten the screws. When the mounting screws are not firmly tightened, the input module may not perform to specifications, or may even fail.**
- **To avoid electric shock or damage to the equipment, always observe the following precautions when connecting to connectors.**
- **Be careful to avoid exceeding the ratings of connectors .**
- **During operation, a wire becoming dislocated and contacting another conductive object can be serious hazard. Use screws to secure RS-232C.**

⚠ CAUTION

- The USB and RS-232C are not insulated to the ground (earth). Grounding (earthing) for the instrument and the controller must be wired as the common earth. Different earthing may cause a voltage potential difference between the GNDs of the instrument and the controller. Connecting the communication cable under condition that there is a voltage potential difference may cause a malfunction and/or a failure. When different earthing is required, connecting instruments and devices must be isolated.

Before switching the current sink (NPN) and the current source (PNP)

CAUTION



You must not operate the EXT.I/O MODE changing over switch (NPN/PNP) during Power-ON status of the instrument.



Set the NPN/PNP based on devices that are externally connected.

Before connecting the EXT.I/O terminals

WARNING



- The EXT.I/O of the instrument cannot be applied to from an external power. Do not apply external power to the instrument. (The ISO_5V terminal of the EXT I/O connector is a 5 V (NPN)/-5 V (PNP) power output.)

To avoid electric shock or damage to the instrument, always observe the following precautions when connecting to the connector.



- Always turn off the main power switch to the instrument and to any device to be connected before making connections.

- Be careful to avoid exceeding the ratings of the signal of the EXT.I/O terminals. (p. 111)

During operation, a wire becoming dislocated and contacting another conductive object can be serious hazard. Use screws to secure the external connectors.

Precautions during shipment

When shipping the instrument, observe the following.

Hioki cannot be responsible for damage that occurs during shipment.

CAUTION



During shipment of the instrument, handle it carefully so that it is not damaged due to a vibration or shock.

CD disc precautions

IMPORTANT

- Exercise care to keep the recorded side of discs free of dirt and scratches. When writing text on a disc's label, use a pen or marker with a soft tip.
- Keep discs inside a protective case and do not expose to direct sunlight, high temperature, or high humidity.
- Hioki is not liable for any issues your computer system experiences in the course of using this disc.

1.1 Product Overview and Features

The BT4560 is a variable-frequency impedance meter.

This instrument is equipped with a highly accurate voltmeter and a temperature measurement function, and optimal for quality control of batteries.

This instrument has the circuit configuration with high noise immunity, and thus, can provide stable measurement even at production sites.

What can the instrument BT4560 measure?

- The instrument can measure the internal impedance of a battery using the AC four-terminal method.
(Frequency: 0.1 Hz to 1050 Hz, Minimum resolution: 0.1 $\mu\Omega$)
- This instrument can also measure the DC voltage (the electromotive force of the battery) simultaneously.
(Resolution: 10 μV , Measurement accuracy: $\pm 0.0035\%$ rdg. ± 5 dgt.)
- In addition, temperature measurement, which is important for battery control, can be performed. (Temperature measurement accuracy: $\pm 0.5^\circ\text{C}$)

What is the difference between the instrument BT4560 and the existing battery impedance instruments?

- The instrument has a simple structure, which does not need a loading device. It is not necessary to configure a system.
- This is a compact instrument and measurement can be performed without other instruments or devices.

Can the instrument BT4560 be used at production lines or sites?

- Optional measurement probes can be extended up to a maximum of 4 m, corresponding to an operating environment.
- This can provide highly accurate measurement with a measurement configuration that resists the influences of external noise and contact resistance.
- The built-in comparator function can perform quality judgment of batteries.
- PLC control using the EXT. I/O is possible.

Can the instrument BT4560 analyze the internal resistance of batteries?

- A personal computer with application software connected to the instrument can continuously measure any frequency in the range of 0.01 Hz to 1050 Hz and necessary points.
- This instrument is able to draw Cole-Cole plots*.

* The Cole-Cole plot is a plot of the frequency characteristics of battery impedance in which the horizontal axis represents the real part of impedance and the vertical axis represents the imaginary part of impedance. This plot is used to evaluate the internal resistance of the battery.

1.2 Names and Functions of Parts

Front

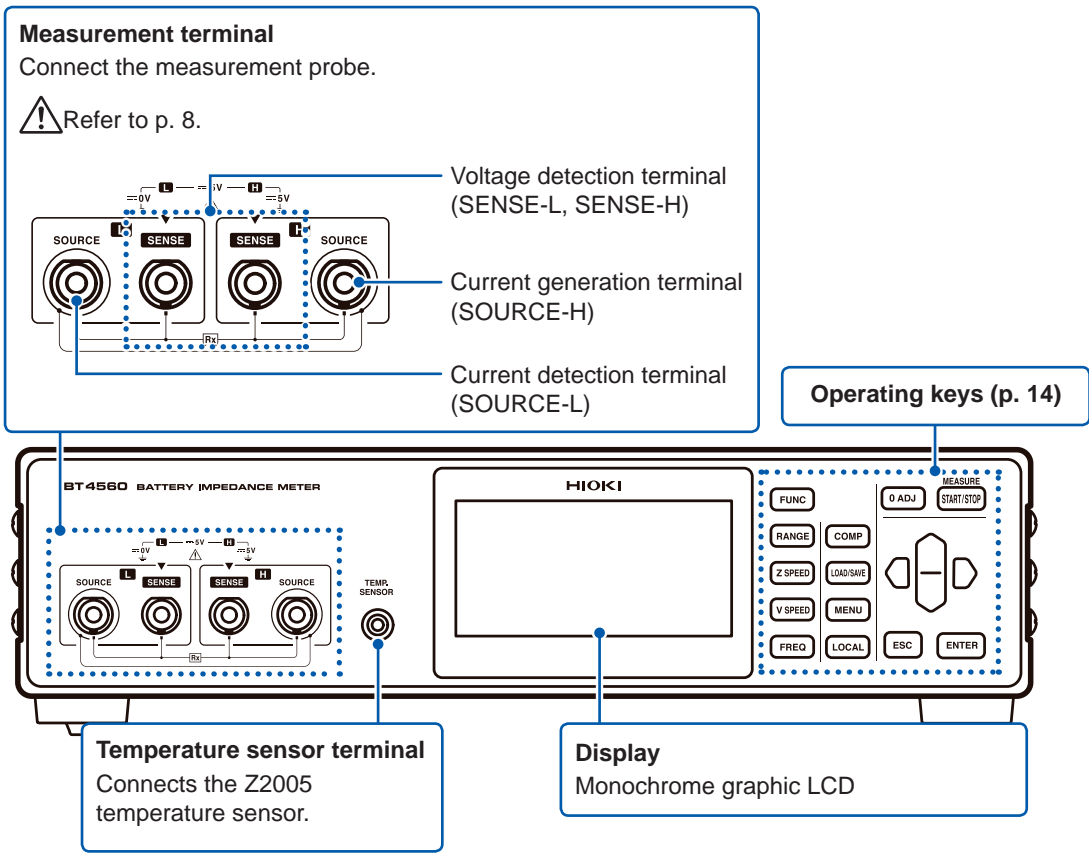

Rear

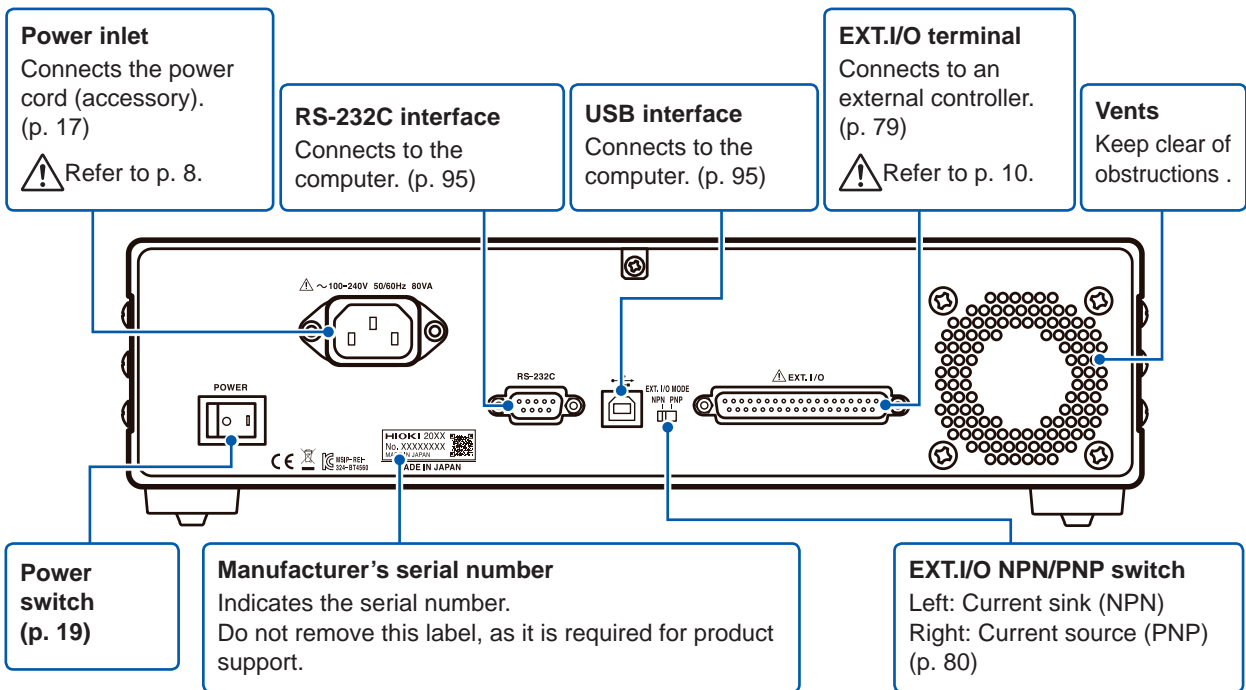

Bottom panel

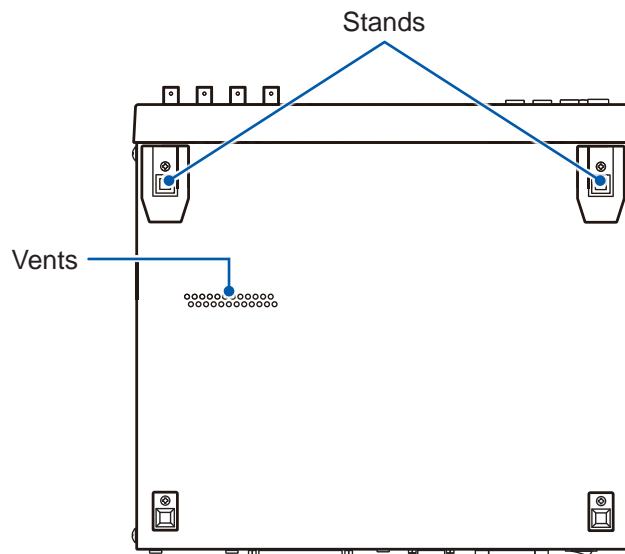

Side

Raising/closing the stand

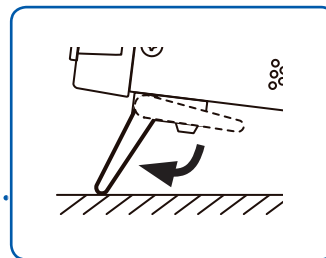
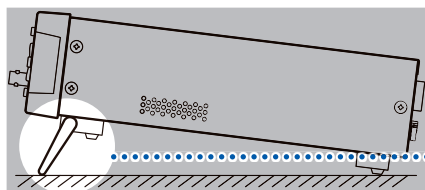

⚠ CAUTION



Do not apply heavy downward pressure with the stand extended. The stand could be damaged.

Operating keys

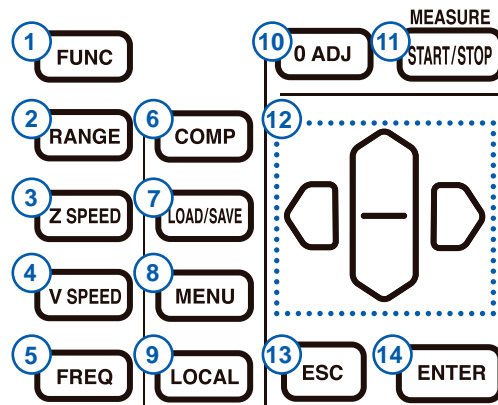

	Key	Description
①	FUNC	Selects the measurement function (combination of the voltage measurement and the impedance measurement).
②	RANGE	Sets the measurement range.
③	Z SPEED	Sets the measurement speed of impedance.
④	V SPEED	Sets the measurement speed of voltage.
⑤	FREQ	Sets the measurement frequency of impedance.
⑥	COMP	Sets the power switch of ON-OFF and the upper and lower limit values ,etc. of the comparator.
⑦	LOAD/SAVE	Saves and reads the measurement conditions.
⑧	MENU	Sets each of the functions (Trigger, Sample delay, Self-calibration, etc.).
⑨	LOCAL	Releases the remote state and enables key operation.
⑩	0 ADJ	Performs the zero adjustment.
⑪	MEASURE START/STOP	Starts and stops the measurement.
⑫		<ul style="list-style-type: none"> • Moves setting items and digits. • Changes numerical values.
⑬	ESC	<ul style="list-style-type: none"> • Cancels the settings being set. • Erases a display message.
⑭	ENTER	Confirms the setting.

1.3 Screen Configuration and Operation

The instrument is configured with the measurement screen and each setting screen.

Measurement screen

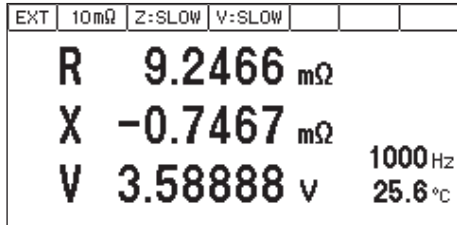

Settings screen

FREQ Measurement frequency setting screen

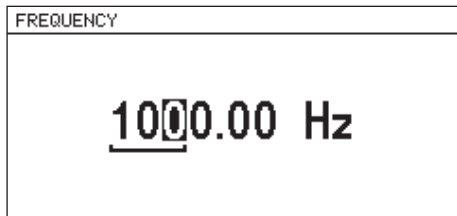

COMP Comparator setting screen

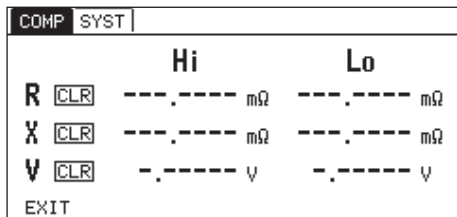

LOAD/SAVE Panel load/panel save screen

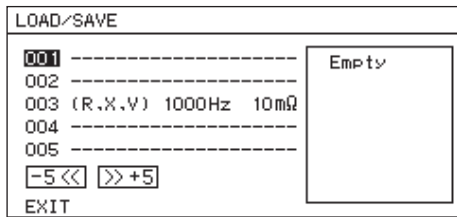

MENU Menu settings screen

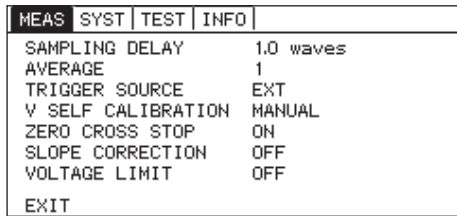

0 ADJ Zero adjustment setting screen



When [EXIT] is selected, display returns to the measurement screen.

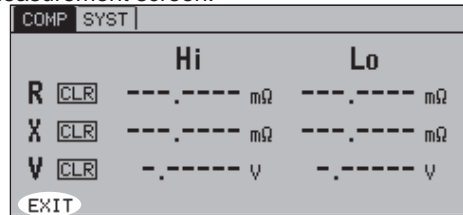

When [EXIT] is selected, display returns to the measurement screen.

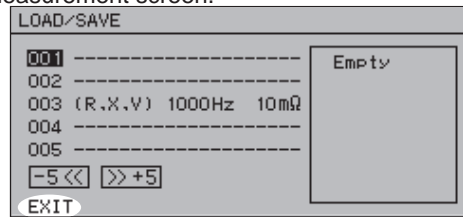

When [EXIT] is selected, display returns to the measurement screen.

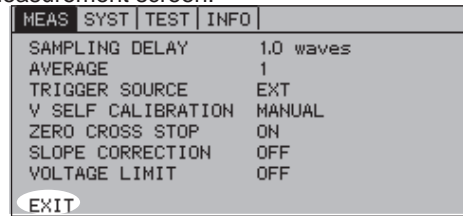

1.4 Measurement Flow

Be sure to refer to “Operating Precautions” (p. 6) before using the instrument.

Installing, connecting, and turning power on

Install (p. 7).

Connect the power cord (p. 17).

Connect the measurement probe and the temperature sensor (p. 18).

Connect the external interface (as needed).

- Use the EXT. I/O (p. 80).
- Communicate computer with USB or RS-232C (p. 95).

Turn Power On (p. 19).

Connect the measurement probe and the temperature sensor (p. 18).

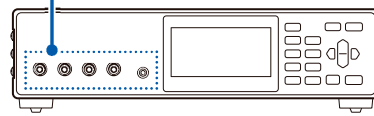

Connect the power cord (p. 17).

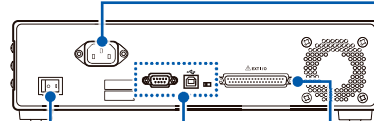

Turn Power On (p. 19).

Use the EXT. I/O (p. 79).

Communicate computer with USB or RS-232C (p. 95).

Setting the instrument (p. 21)

Set the measurement conditions (as needed).

- Basic setting (p. 21)
- Setting basic conditions for customization (p. 37)
- Setting system related items (p. 63)
- Initial setting table (p. 76)

Performing the zero adjustment

Make the measurement probes short-circuit with the zero adjustment board (p. 26).

Perform zero adjustment (p. 26).

Starting the measurement

Connect the measurement probe to the object being measured.

(For EXT trigger, start the measurement by pressing the **START/STOP** key.)

Check the measurement values.

Ending

Turn Power Off (p. 19).

2 Preparation

2.1 Connecting the Power Cord

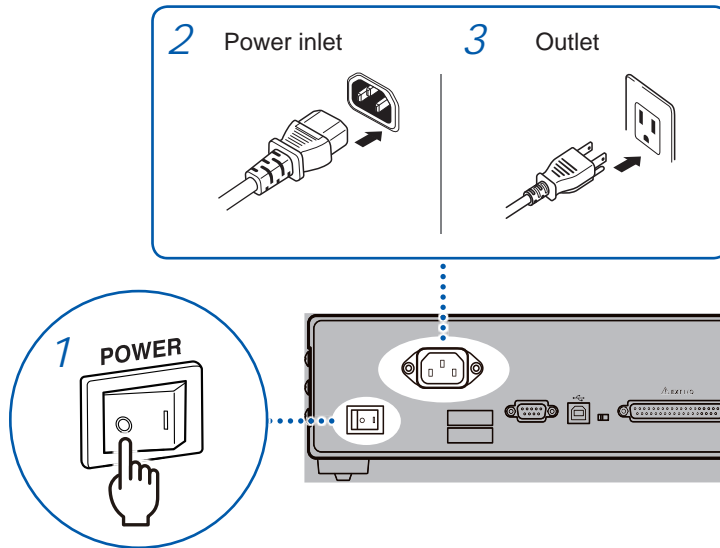

- 1 Check that the power switch (rear) of the instrument is OFF (O).
- 2 Check that the power voltage is in the range indicated on the rear, and then connect the power cord to the power inlet.
- 3 Connect the plug of the power cord into an outlet.

2.2 Connecting the Measurement Probe and Temperature Sensor (Optional)

The measurement probe and the temperature sensor are optional. (p. A12)

Connect the four-terminal cable to the instrument

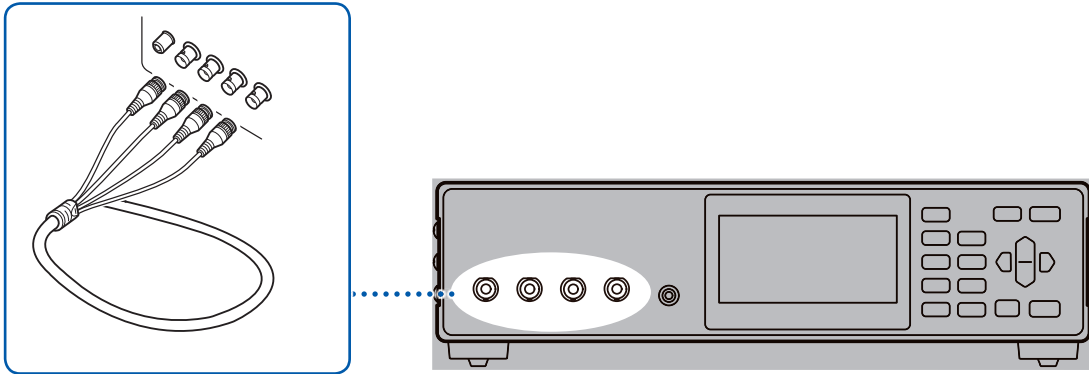

Connection method

- 1 Check the orientation of the groove in the BNC connector and ensure that it fits into the connector guide of the instrument side.
- 2 Align the groove in the BNC connector along the connector guide of the instrument, and insert the BNC connector into the instrument connector.
- 3 Turn the BNC connector to the right and lock it.

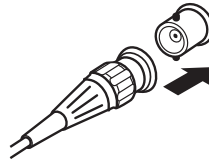
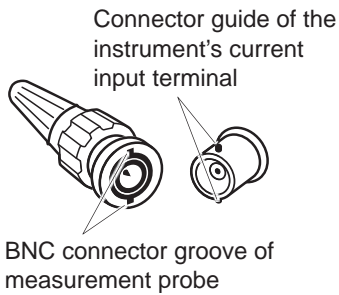

Connect the temperature sensor to the instrument

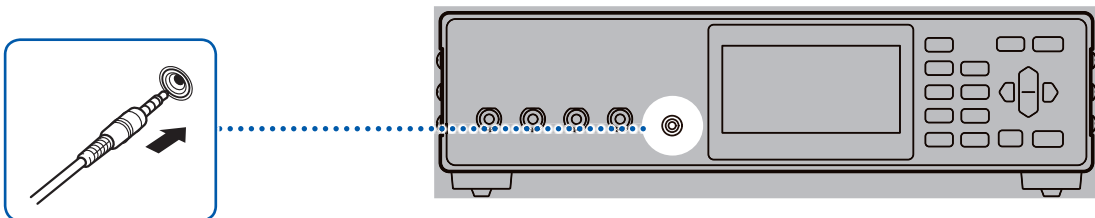

2.3 Turning the Power ON or OFF

Turn the power on or off using the power switch on the rear.

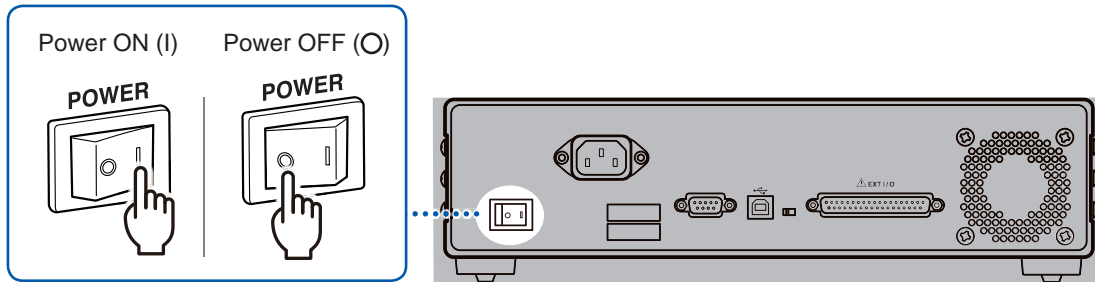

2

Preparation

2.4 Inspection Before Use

Before using the instrument, verify that it operates normally to ensure that no damage occurred during storage or shipping. If you find any damage, contact your authorized Hioki distributor or reseller.

Verifying the instrument and the peripheral devices

Inspection items	Countermeasures
Is the power cord insulation torn, or is any metal exposed?	Do not use the instrument if damage is found, as electric shock or short-circuit accidents could result. Contact your authorized Hioki distributor or reseller.
Is the insulation of the measurement probe or the connection cords torn, or is any metal exposed?	When any damage is found, it may cause electrical shock. If this happens, replace the measurement probe or connection cords with ones specified by Hioki.
Is the instrument damaged?	When any damage is found, it may cause electrical shock. Do not use the instrument, and then request repair.

Verifying when turning the power on

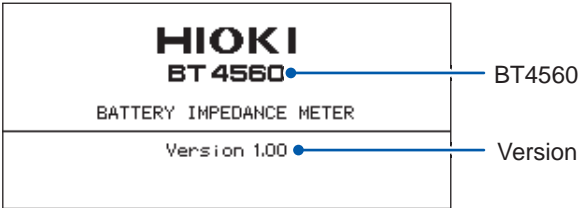
Inspection items	Countermeasures
Does the fan rotate when the power is turned on? Are there the indications of "BT4560" and "Version number" on the display?	<p>If the fan does not rotate, or if "BT4560" and "Version number" are not displayed, the instrument may be malfunctioning. Request repairs.</p> 
After the self-test, is the measurement screen displayed?	If the screen does not display, the instrument may have be malfunctioning internally. Request repairs.

3 Basic Measurement

3.1 Selecting the Measurement Functions

Set the measurement functions.

Parameters	Measurement items	Parameters	Measurement items
Z	Impedance	X	Reactance
θ	Phase angle	V	Voltage
R	Resistance	T	Temperature

By pressing **FUNC** (**FUNC**) the measurement functions are switched.
For the selectable functions, refer to Table below.

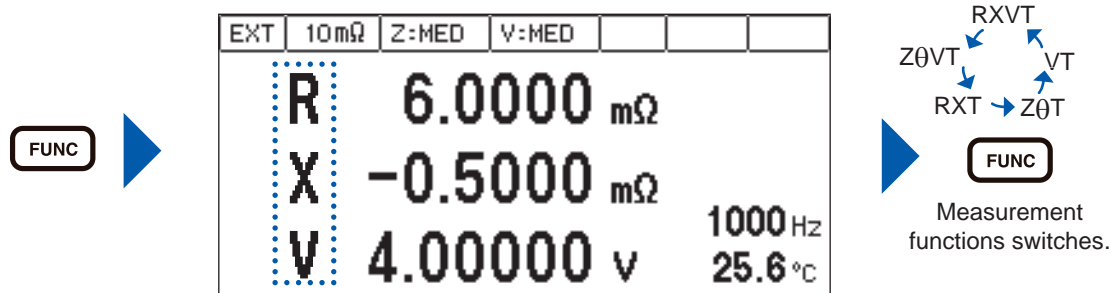

Measurement functions	Screen																												
R, X, V, T	<table border="1"> <thead> <tr> <th>EXT</th> <th>10 mΩ</th> <th>Z: MED</th> <th>V: MED</th> <th></th> <th></th> <th></th> </tr> </thead> <tbody> <tr> <td>R</td> <td>6.0000</td> <td>mΩ</td> <td></td> <td></td> <td></td> <td></td> </tr> <tr> <td>X</td> <td>-0.5000</td> <td>mΩ</td> <td></td> <td></td> <td></td> <td></td> </tr> <tr> <td>V</td> <td>4.00000</td> <td>v</td> <td></td> <td>1000 Hz</td> <td></td> <td>25.6 °C</td> </tr> </tbody> </table>	EXT	10 mΩ	Z: MED	V: MED				R	6.0000	mΩ					X	-0.5000	mΩ					V	4.00000	v		1000 Hz		25.6 °C
EXT	10 mΩ	Z: MED	V: MED																										
R	6.0000	mΩ																											
X	-0.5000	mΩ																											
V	4.00000	v		1000 Hz		25.6 °C																							
Z, θ , V, T	<table border="1"> <thead> <tr> <th>EXT</th> <th>10 mΩ</th> <th>Z: MED</th> <th>V: MED</th> <th></th> <th></th> <th></th> </tr> </thead> <tbody> <tr> <td>Z</td> <td>6.0207</td> <td>mΩ</td> <td></td> <td></td> <td></td> <td></td> </tr> <tr> <td>θ</td> <td>-0.083</td> <td>°</td> <td></td> <td></td> <td></td> <td></td> </tr> <tr> <td>V</td> <td>4.00000</td> <td>v</td> <td></td> <td>1000 Hz</td> <td></td> <td>25.6 °C</td> </tr> </tbody> </table>	EXT	10 mΩ	Z: MED	V: MED				Z	6.0207	mΩ					θ	-0.083	°					V	4.00000	v		1000 Hz		25.6 °C
EXT	10 mΩ	Z: MED	V: MED																										
Z	6.0207	mΩ																											
θ	-0.083	°																											
V	4.00000	v		1000 Hz		25.6 °C																							
R, X, T	<table border="1"> <thead> <tr> <th>EXT</th> <th>10 mΩ</th> <th>Z: MED</th> <th>V: MED</th> <th></th> <th></th> <th></th> </tr> </thead> <tbody> <tr> <td>R</td> <td>6.0000</td> <td>mΩ</td> <td></td> <td></td> <td></td> <td></td> </tr> <tr> <td>X</td> <td>-0.5000</td> <td>mΩ</td> <td></td> <td></td> <td></td> <td></td> </tr> <tr> <td></td> <td></td> <td></td> <td></td> <td>1000 Hz</td> <td></td> <td>25.6 °C</td> </tr> </tbody> </table>	EXT	10 mΩ	Z: MED	V: MED				R	6.0000	mΩ					X	-0.5000	mΩ									1000 Hz		25.6 °C
EXT	10 mΩ	Z: MED	V: MED																										
R	6.0000	mΩ																											
X	-0.5000	mΩ																											
				1000 Hz		25.6 °C																							
Z, θ , T	<table border="1"> <thead> <tr> <th>EXT</th> <th>10 mΩ</th> <th>Z: MED</th> <th>V: MED</th> <th></th> <th></th> <th></th> </tr> </thead> <tbody> <tr> <td>Z</td> <td>6.0207</td> <td>mΩ</td> <td></td> <td></td> <td></td> <td></td> </tr> <tr> <td>θ</td> <td>-0.083</td> <td>°</td> <td></td> <td></td> <td></td> <td></td> </tr> <tr> <td></td> <td></td> <td></td> <td></td> <td>1000 Hz</td> <td></td> <td>25.6 °C</td> </tr> </tbody> </table>	EXT	10 mΩ	Z: MED	V: MED				Z	6.0207	mΩ					θ	-0.083	°									1000 Hz		25.6 °C
EXT	10 mΩ	Z: MED	V: MED																										
Z	6.0207	mΩ																											
θ	-0.083	°																											
				1000 Hz		25.6 °C																							
V, T	<table border="1"> <thead> <tr> <th>EXT</th> <th></th> <th></th> <th>V: MED</th> <th></th> <th></th> <th></th> </tr> </thead> <tbody> <tr> <td>V</td> <td>4.00000</td> <td>v</td> <td></td> <td></td> <td></td> <td>25.6 °C</td> </tr> </tbody> </table>	EXT			V: MED				V	4.00000	v				25.6 °C														
EXT			V: MED																										
V	4.00000	v				25.6 °C																							

3.2 Selecting the Measurement Range

Set the measurement range of impedance (3 mΩ, 10 mΩ, 100 mΩ).

The voltage and the temperature have a single range respectively. Thus, setting is not necessary. Use the measurement range of impedance when the impedance measurement value exceeds the present range or when changing the measurement accuracy.

When the functions (V, T) are selected, setting cannot be performed.

By pressing **RANGE** (**RANGE**) the measurement ranges are switched.

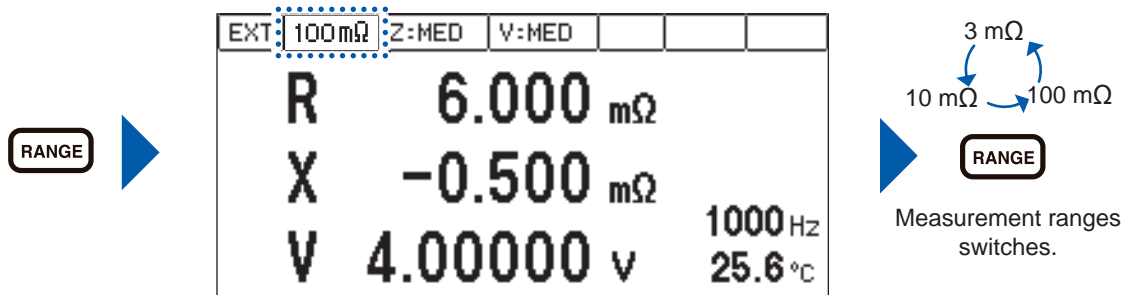

3.3 Setting the Measurement Speed

Set the measurement speed (FAST, MED, SLOW) in the impedance measurement and the voltage measurement.

The slower the measurement speed is, the more accurate are the results.

Set the measurement speed of impedance measurement (Z)

By pressing **Z SPEED** (**Z SPEED**) the measurement speed in the impedance measurement is switched.

The diagram illustrates the process of switching the impedance measurement speed. On the left, a button labeled 'Z SPEED' is shown with a blue arrow pointing to the right. In the center is a digital display showing measurement results: 'R 6.0000 mΩ', 'X -0.5000 mΩ', and 'V 4.00000 v'. The top status bar shows 'EXT 10 mΩ', 'Z:SLOW', and 'V:MED'. A dashed blue box highlights the 'Z:SLOW' setting. To the right, a circular diagram shows three speed settings: 'Z:FAST' at the top, 'Z:MED' on the left, and 'Z:SLOW' on the right, connected by curved arrows in a clockwise cycle. Below this diagram is another 'Z SPEED' button with a blue arrow pointing to the right, and the text 'Measurement speed switches.'

Setting Items	Contents
Z:FAST	When the high speed measurement is performed, set this item.
Z:MED	When the normal speed measurement is performed, set this item.
Z:SLOW	When the high accurate measurement is performed, set this item.

Set the measurement speed in the voltage measurement (V)

By pressing **V SPEED** (**V SPEED**) the measurement speed in the voltage measurement is switched.

The diagram illustrates the process of switching the voltage measurement speed. On the left, a button labeled 'V SPEED' is shown with a blue arrow pointing to the right. In the center is a digital display showing measurement results: 'R 6.0000 mΩ', 'X -0.5000 mΩ', and 'V 4.00000 v'. The top status bar shows 'EXT 10 mΩ', 'Z:MED', and 'V:SLOW'. A dashed blue box highlights the 'V:SLOW' setting. To the right, a circular diagram shows three speed settings: 'V:FAST' at the top, 'V:MED' on the left, and 'V:SLOW' on the right, connected by curved arrows in a clockwise cycle. Below this diagram is another 'V SPEED' button with a blue arrow pointing to the right, and the text 'Measurement speed switches.'

Setting Items	Contents
V:FAST	When the high speed measurement is performed, set this item.
V:MED	When the normal speed measurement is performed, set this item.
V:SLOW	When the high accurate measurement is performed, set this item.

3.4 Setting the Measurement Frequency

Setting the measurement frequency. (0.1 Hz to 1050 Hz)

- 1 Press **FREQ** (**FREQ**). (Measurement frequency setting screen appears.)
The selected digit is displayed in reverse black and white, with a bar under the digit enabled to be set.

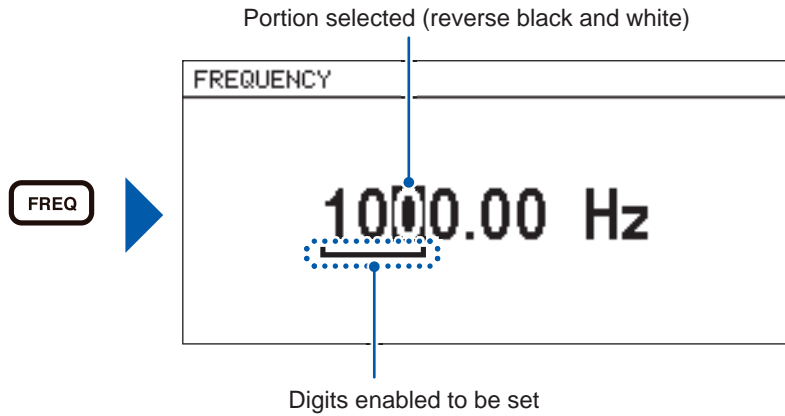

- 2 Set the measurement frequency.

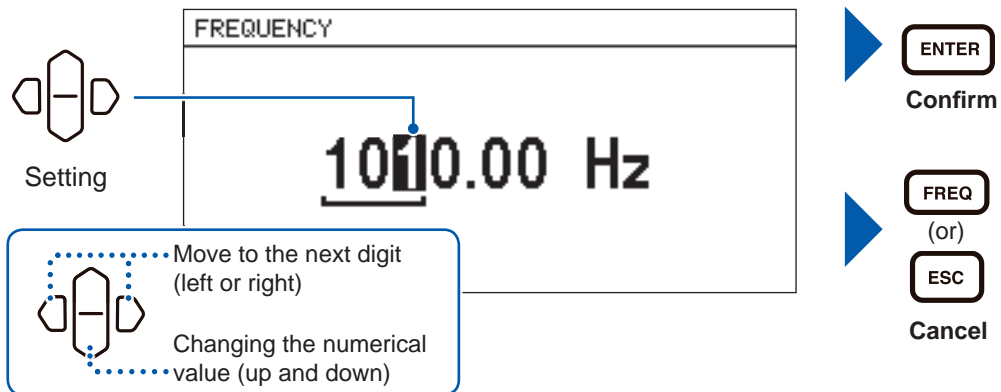

Disabled digits will be set to zero automatically.

The display will automatically change to zero as setting the digits is disabled.



When the measurement time is long (Display of the Progress Bar)

When the impedance measurement time is long (more than approx. 1 second), the progress bar is displayed on the right side of the measuring screen which is in operation.

During sample delay (p. 38)

[D] is displayed at the center of the progress bar.

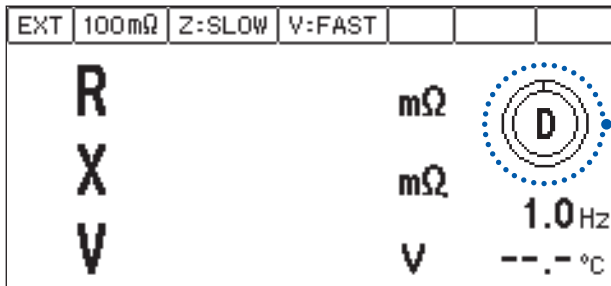

Progress bar
([D] is displayed at the center.)

During impedance measurement

Percentage of measurement progress is displayed at the center of the progress bar.

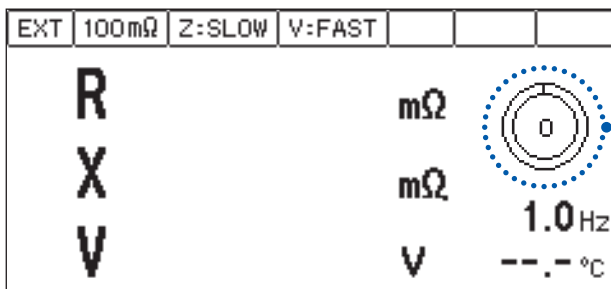

Progress bar
(Progress percentage is displayed at the center.)

Transition of the progress percentage

Progress percentage
0%

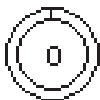

Progress percentage
20%



Progress percentage
80%



Measurement complete (The progress percentage is 100%.)
The measurement is finished and the measurement value is displayed.

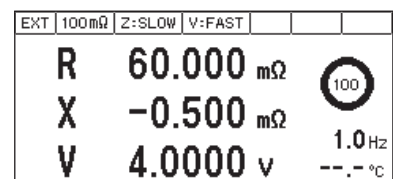

During the detection of zero cross stop (When zero cross stop is ON) (p. 47)

[Z] is displayed at the center of the progress bar.

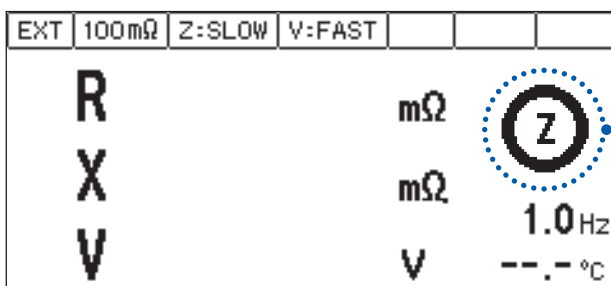

Progress bar
([Z] is displayed at the center.)

3.5 Performing the Zero Adjustment

Remove the residual components due to offset and the measurement environment.
 Be sure to perform the zero adjustment before the impedance measurement and the voltage measurement.

Performing the zero adjustment

Placing the measurement probe (Example: L2002)

- 1 **Place the measurement probe in the same condition as the measurement is performed.**
 The zero residual volume differs due to the condition of the measurement probe (length, shape, and location). Thus, place the measurement probe in the same condition as the actual measurement is performed, before performing the zero adjustment.
- 2 **Prepare the zero adjustment board (accessory).**
- 3 **Place the probes with a space the same length as the width of the actual measuring object.**
 Clip a pattern on the zero adjustment board, with the same number of divisions for both HIGH and LOW.

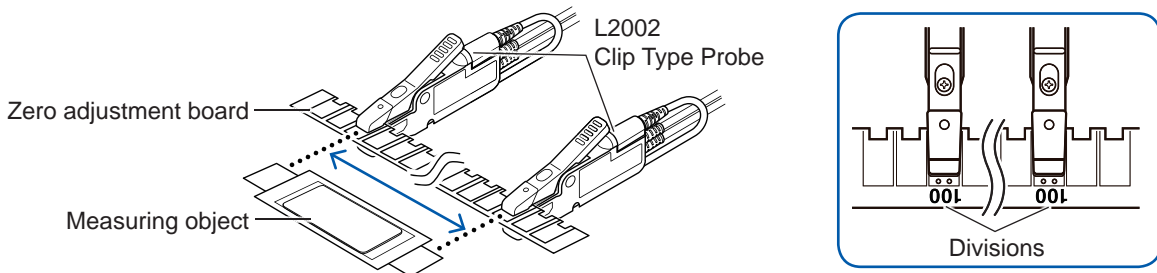

Setting the zero adjustment

There are two methods of the zero adjustment, the spot zero adjustment (SPOT) and the all zero adjustment (ALL).

Spot zero adjustment (SPOT)	The zero adjustments for the range and the frequency that are presently set, and the voltage measurement are performed. The time required differs according to the frequency. The lower the frequency, the longer it takes to set (Reference: approx. 350 s for 0.1 Hz, approx. 45 s for 1 Hz). When setting at a different range and/or frequency, zero adjustment will be invalid.
All zero adjustment (ALL)	The zero adjustments for the range that is presently set, and the full range of the frequency, and the voltage measurement are performed. Even if the measurement frequency is changed, the zero adjustment is effective. However, when the range is changed, the zero adjustment is not effective.

- When the zero adjustment is effective, the indicator of 0 ADJ appears on the measurement screen.
- After performing the zero adjustment, even if the zero adjustment becomes ineffective, the zero adjustment will become effective when returning to the conditions that the zero adjustment was performed.
- With the 0ADJ_SPOT of the EXT.I/O and 0ADJ_ALL terminals, performing can be done.

- 1 Press **0 ADJ** (**0 ADJ**). (The zero adjustment screen appears.)

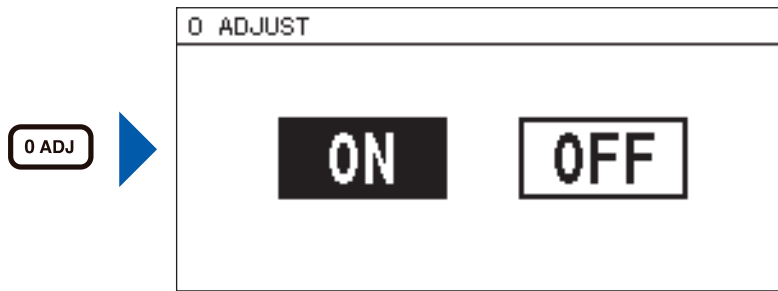

- 2 Select **[ON]**.

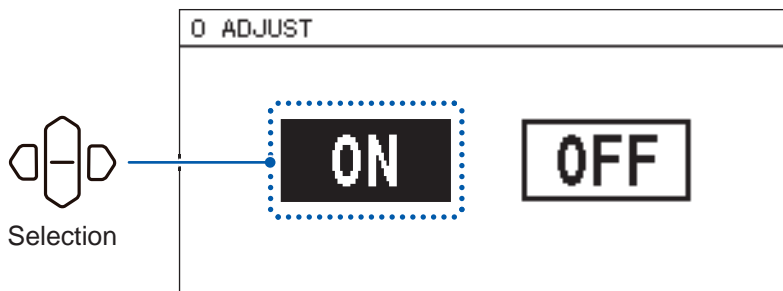

ENTER
To the SPOT and ALL selection screen

0 ADJ
(or)
ESC
Cancel

- 3 Select **[SPOT]** or **[ALL]**.

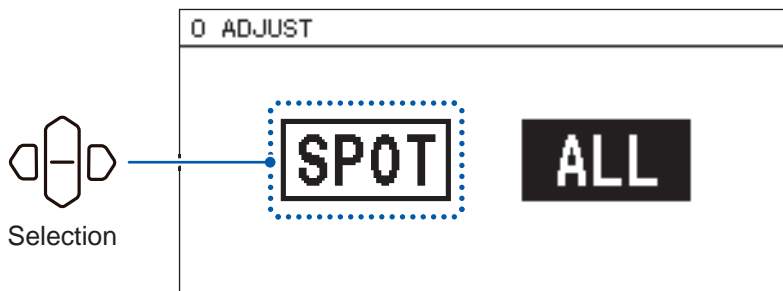

ENTER
Performing zero adjustment

0 ADJ
(or)
ESC
Cancel

When selecting **[ALL]**, the confirmation window opens.

- OK: Performing all zero adjustment
- CANCEL: Returns to the measurement screen without execution.

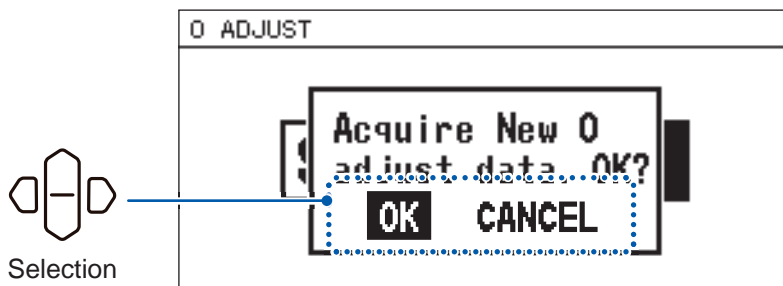

ENTER
Confirm

- 4 After the zero adjustment is normally performed, the screen will go back to the measurement screen. (When the zero adjustment is effective, 0 ADJ appears at the upper right on the measurement screen.)

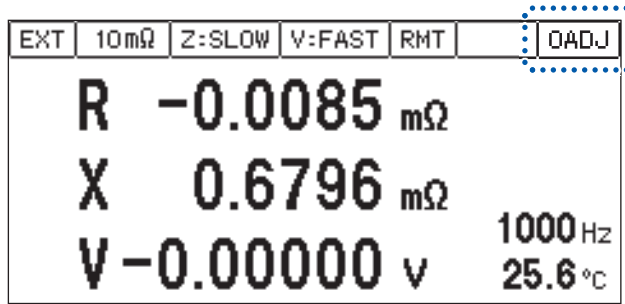

When the zero adjustment is not normally performed

When [0 ADJUST ERROR] appears, the proper adjustment is not performed. Check the short-circuit method of the measurement probe and perform the zero adjustment with a proper method so that the zero adjustment data values come within the range given in the table below.

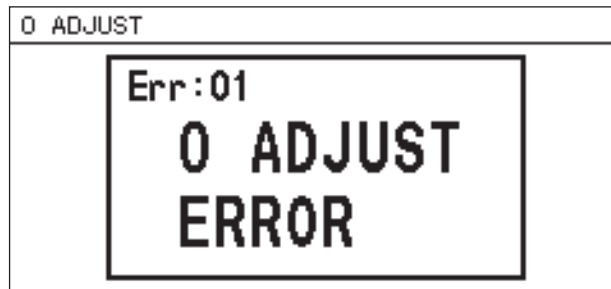

Impedance measurement	R	X
3 mΩ range	-0.1000 mΩ to 0.1000 mΩ	-1.5000 mΩ to 1.5000 mΩ
10 mΩ range	-0.3000 mΩ to 0.3000 mΩ	-1.5000 mΩ to 1.5000 mΩ
100 mΩ range	-3.000 mΩ to 3.000 mΩ	-1.500 mΩ to 1.500 mΩ

Voltage measurement
-0.10000 V to 0.10000 V

Disabling zero adjustment

Select [OFF] on the zero adjustment screen. (When [OFF] is selected, zero adjustment will be disabled. To enable, perform zero adjustment again.)

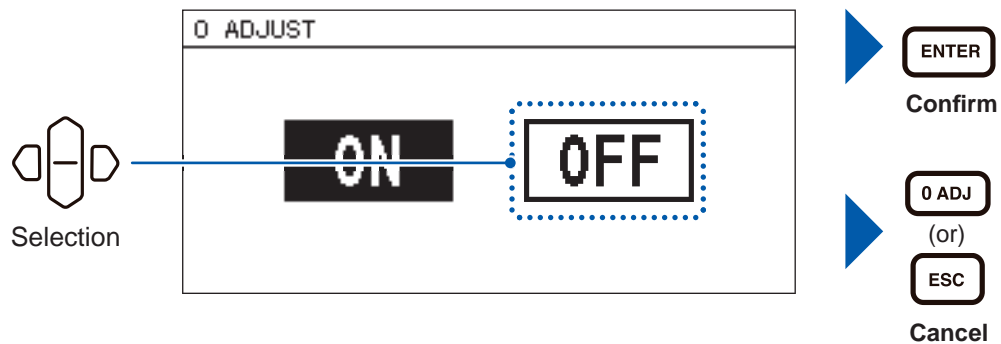

When measuring while changing the measurement range

If measured as below, zero adjustment will not be necessary every time the range is changed.

1. Perform zero adjustment at 3 m Ω range.
2. Save the current condition by panel saving function (p. 58).
(Zero adjustment data of the current range will be saved.)
3. Change the range to 10 m Ω and perform zero adjustment.
4. Save the current condition by panel saving function (p. 58).
5. Change the range to 100 m Ω and perform zero adjustment.
6. Save the current condition by panel saving function (p. 58).
7. Read the condition of the range used by panel saving function (p. 58), and then measure.

Connection when performing the zero adjustment

If the zero adjustment board is used, the connection will be as below.

Perform zero adjustment with the same connection when making your own measurement probe (refer to "Appx. 3 Cautions When Making Your Own Measurement Probe" (p. A4)).

- 1 **Connect the shields of SOURCE-H and SOURCE-L.**
(Connected by the return cable)
- 2 **Connect SENSE-H and SENSE-L.**
- 3 **Connect SOURCE-H and SOURCE-L.**
- 4 **Connect the above 2 and 3 lines at one point.**

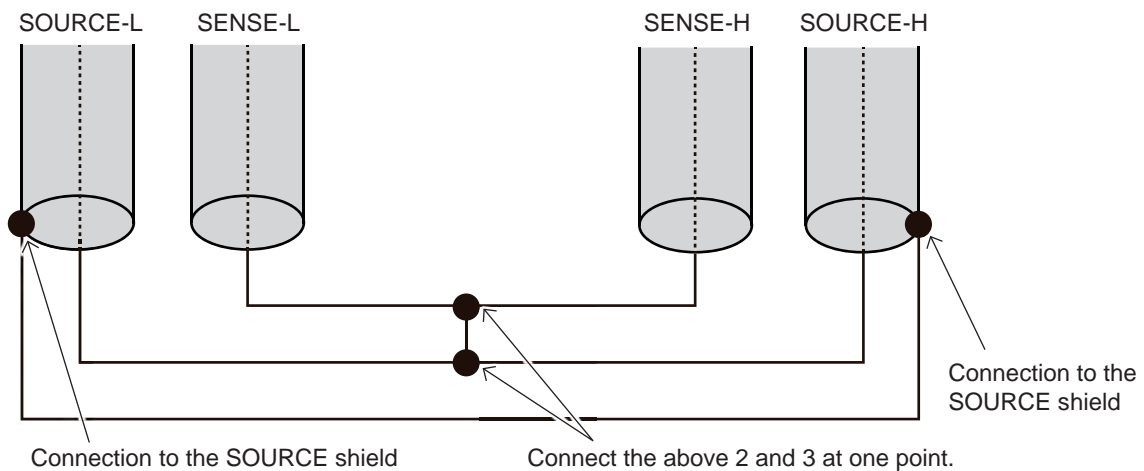

3.6 Checking the Measurement Results

Detecting the measurement abnormality

When the measurement is not normally performed, the indication expressing the measurement abnormality appears on the screen, and the ERR signal from the EXT.I/O is output.

Contact error

When the resistance value is greater between SOURCE-H and SENSE-H, or between SENSE-L and SOURCE-L, the contact error appears. The possible causes are listed below.

- The measurement probe is not connected to the measuring object.
- The probe is broken.
- The contact resistance or the wiring resistance are large due to frictional wear and dirt of the probe.
- The circuit protection fuse is broken.

The guideline in the contact error detection

Place for abnormality detection	Target resistance value for abnormality detection			Measurement abnormality type	Error indication
	3 mΩ range	10 mΩ range	100 mΩ range		
SOURCE-H and SENSE-H	10 Ω	15 Ω	50 Ω	H Contact error	CONTACT ERROR H
SOURCE-H and SOURCE-L	10 Ω	15 Ω	50 Ω	L Contact error	CONTACT ERROR L

- The resistance values indicate the guideline, which are not strictly defined.
- The capacitance of the measurement probe is greater than 20 nF, the measurement abnormality may not be detected.
- For functions V and T, target resistance value for abnormality detection will be the same resistance value as 100 mΩ range.

Over-voltage input error (indication: OVER VOLTAGE)

When the voltage of the measuring object exceeds the measurable range, OVER VOLTAGE appears.

The measurable voltage range is -5.10000 V to 5.10000 V.

It may be displayed SENSE-H and SOURCE-H short-circuit, and SENSE-L and SOURCE-L short-circuit state.

Voltage limit error (Indication: OVER V LIMIT)

When the voltage of the measuring object exceeds the voltage limit setting range, LIMIT VOLTAGE appears.

For the setting method of the voltage limit, refer to “4.6 Preventing the Overcharge due to Measurement Signal (Voltage Limit Function)” (p. 45).

It may be displayed SENSE-H and SOURCE-H short-circuit, and SENSE-L and SOURCE-L short-circuit state.

Measurement current abnormality (Indication: -----)

This indication appears when the measurement current does not flow normally. The possible causes are listed below.

- The contact resistance or the wiring resistance are large due to frictional wear and dirt of the probe.
- The resistance of the measuring object is remarkably large to the range (Example: when 1 kΩ is selected).
- When wiring is wrongly connected to a battery.
- When wiring is connected to a battery that is grounded.

The guide line in the abnormality detection of the measurement current

Place for abnormality detection	Target resistance value for abnormality detection			Measurement abnormality type	Indication
	3 mΩ range	10 mΩ range	100 mΩ range		
SOURCE-H	1.5 Ω to 4.0 Ω	5 Ω to 12 Ω	50 Ω to 55 Ω	Measurement current abnormality	-----
SOURCE-L	1.5 Ω	4 Ω	45 Ω	Measurement current abnormality	-----

The resistance values indicate the guideline, which are not strictly defined. The detected value of SOURCE-H changes based on the voltage of the measuring object.

Impedance measurement error due to voltage drift (Indication: VOLTAGE DRIFT)

The voltage of the measuring object considerably fluctuates during the measurement. When the difference between voltage values at the start and at the end of measurement is 10 mV or more, the difference is detected as an error.

Return cable unconnected error (Indication: RETURN CABLE ERROR)

The probe's return cable is not properly connected. It may be disconnected or the wire connection may be wrong.

To reduce noise due to the electromagnetic induction, it needs the return cable where the current flows opposed to the measurement current. The return cable has a structure that short-circuits between the shield wire of the SOURCE-H and the shield wire of the SOURCE-L. (In the optional probe, the return cable short-circuits between the shield wire of the SOURCE-H and the shield wire of the SOURCE-L.)

Detection sequence of measurement abnormality

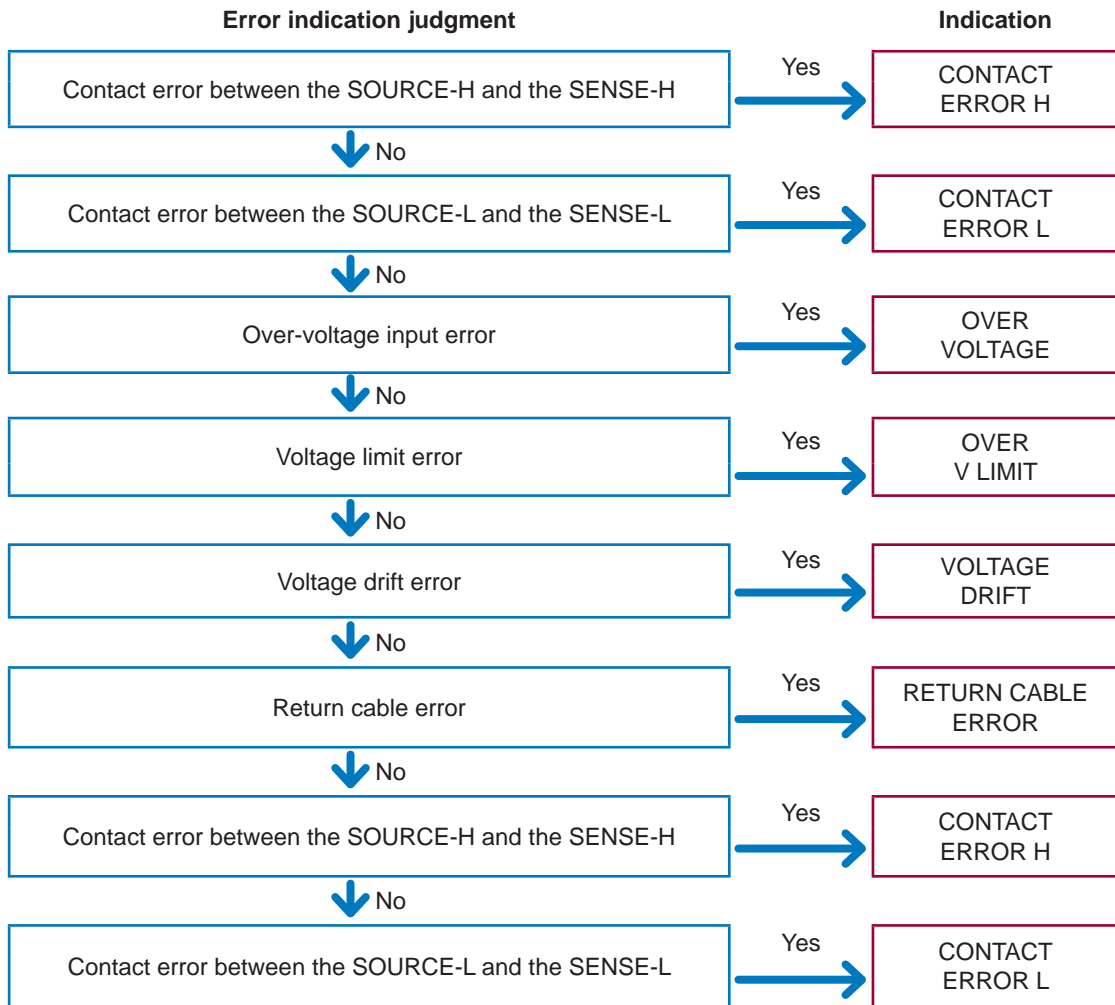

Measurement errors are judged in the order of the above figure and the error detected initially is displayed.

Abnormal measurement current is monitored during the following:

- When trigger has been accepted until voltage measurement is executed
- During impedance measurement

Temperature measurement indication

Temperature sensor unconnected (Indication: --.-°C)

The temperature sensor is not connected. Thus, the temperature measurement cannot be performed. When the temperature measurement is not necessary, there is no need for connection.

Overrange indication

Each parameter over-indicates due to causes listed below.

Parameters	Over indication	Cause
R	OverRange	The measurement value of Z exceeds the indication range of the present range.
X		
Z		
θ		
T	+Over°C	The measurement value is greater than 60.0°C.
	-Under°C	The measurement value is smaller than -10.0°C.

3.7 Basic Measurement Examples

In this section, setting the battery cell is explained as an example.

Examples of setting contents

Measurement functions		R, X, V, T
Measurement Range		100 mΩ
Measurement speed	Impedance measurement	FAST
	Voltage measurement	SLOW
Impedance measurement frequency		1 Hz
Zero adjustment		ALL

- 1 Set the measurement functions (R, X, V, T). (p. 21)

EXT	10mΩ	Z:MED	V:MED			
	R			mΩ		
	X			mΩ		
	V			V	1000 Hz	25.6 °C

- 2 Set the measurement range at 100 mΩ. (p. 22)

EXT	100mΩ	Z:MED	V:MED			
	R			mΩ		
	X			mΩ		
	V			V	1000 Hz	25.6 °C

- 3 Set the measurement speed of impedance measurement (Z) at **[FAST]**. (p. 23)

EXT	100mΩ	Z:FAST	V:MED			
	R			mΩ		
	X			mΩ		
	V			V	1000 Hz	25.6 °C

4 Set the speed of the voltage measurement (V) at [SLOW]. (p. 23)

EXT	100mΩ	Z:FAST	V:SLOW			
R			mΩ			
X			mΩ			
V			V	1000 Hz		
				25.6 °C		

5 Set the measurement frequency of impedance at 1 Hz. (p. 24)

EXT	100mΩ	Z:FAST	V:SLOW			
R			mΩ			
X			mΩ			
V			V	1.0 Hz		
				25.6 °C		

6 Connect the zero adjustment connection and then perform the all zero adjustment. (p. 26)

EXT	100mΩ	Z:FAST	V:SLOW			0ADJ
R			mΩ			
X			mΩ			
V			V	1.0 Hz		
				25.6 °C		

7 Connect the battery cell.

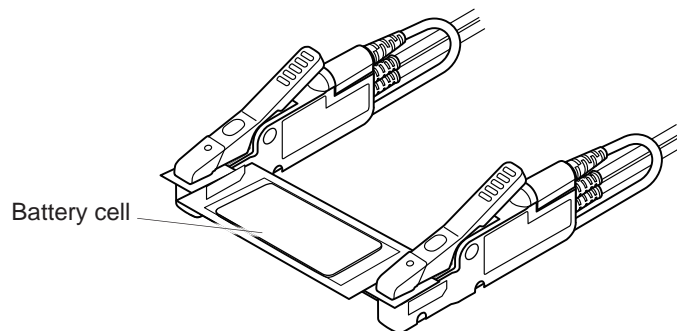

8 Press **START/STOP** to measure.

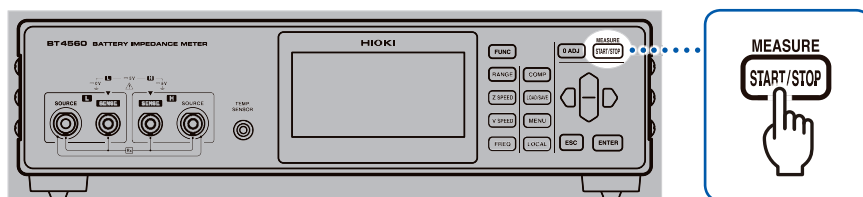

9 Check the measurement results.

EXT	100mΩ	Z:FAST	V:SLOW		OADJ
R	6.000	mΩ			
X	-0.500	mΩ			
V	4.00000	v		1.0 Hz	25.6 °C

4

Customization of Measurement Conditions

4.1 Setting the Measurement Starting Conditions (Trigger Functions)

There are two methods to set the measurement starting conditions, which are described below.

External trigger	When START/STOP (START/STOP) is pressed or the external trigger signal is input, the measurement starts.
Internal trigger	Trigger signals are automatically generated internally to perform the automatic-measurement.

Setting the trigger

- 1 Press **MENU** (**MENU**). (The setting screen appears.)

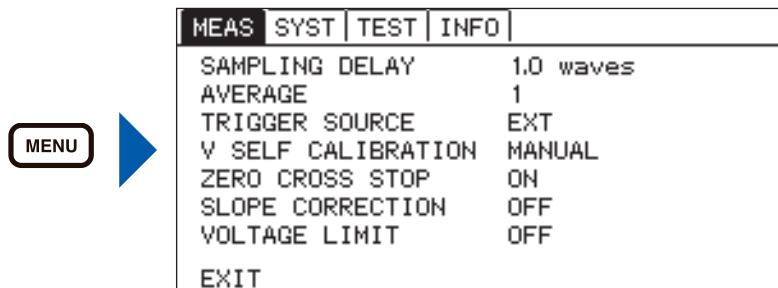

- 2 Select **[MEAS]** tab.

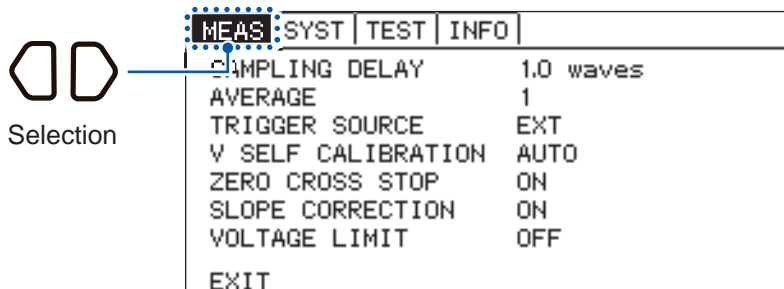

- 3 Select **[EXT]** (external trigger) or **[INT]** (internal trigger).

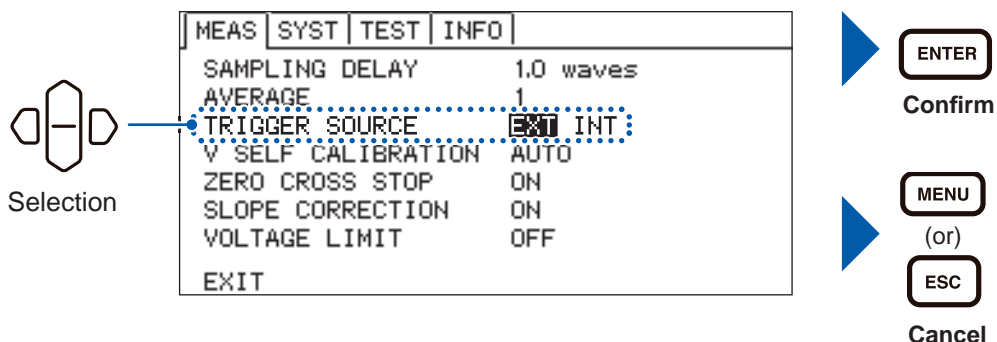

4

Inputting the external trigger

- When inputting from the key
On the measurement screen, press **START/STOP** (**START/STOP**) to perform measurement once.
- When inputting from the EXT.I/O
If the TRIG terminal of the EXT.I/O terminal is short-circuited to ISO_COM, the measurement is performed once. (p. 80)
- When inputting from the communication interface
When the ***TRIG** command is received, measurement is performed once.

IMPORTANT

- When the function is set in the internal trigger, the input from the EXT.I/O and ***TRG** command are ignored, and the voltage limit function is enabled. If the measuring object continues to be connected with an internal trigger set, may cause continuous charging or discharging. Therefore, remove the measuring object from the instrument after measurement.
- Measurement will stop if **START/STOP** (**START/STOP**) is pressed during measurement.

4.2 Starting the Measurement After the Response of the Measuring Object is Stable (Sample Delay Function)

When measuring impedance, set the delay (delayed time) from applying AC to the start of the sampling. There are two methods to set the delay, one is to use the frequency of the Alternating Current signal for setting and the other is to use the deviation of the offset voltage fluctuation for setting.

Settings based on waveform (WAVE)

Alternating Current response of the battery

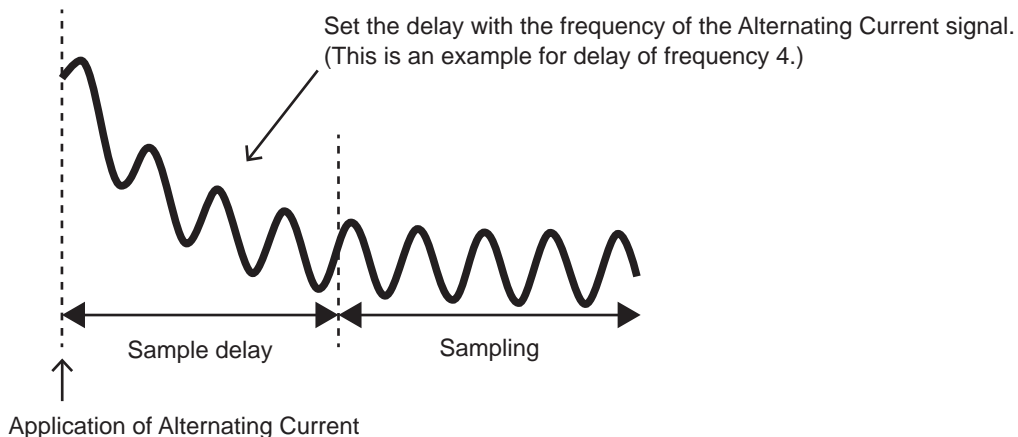

Setting with the deviation of voltage fluctuation (Δ VOLT)

Alternating Current response of the battery

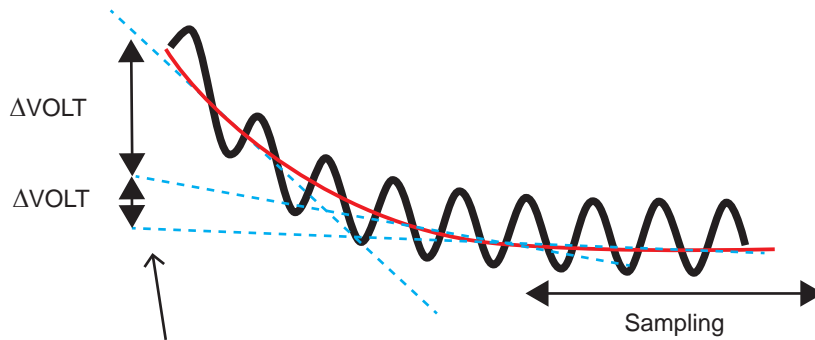

The slope of Alternating Current response is monitored and sampling is started when the slope of deviation (Δ VOLT) drops below the set value.

1 Press **MENU** (**MENU**). (The setting screen appears.)

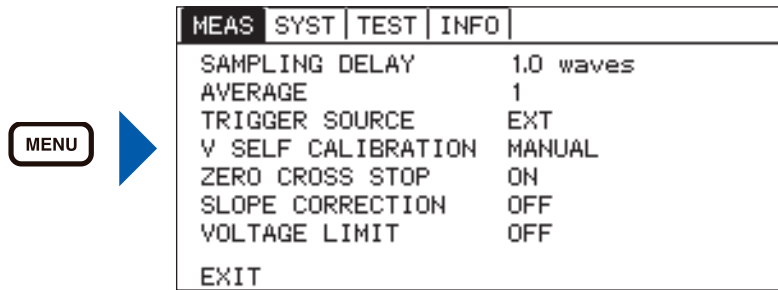

2 Select **[MEAS]** tab.

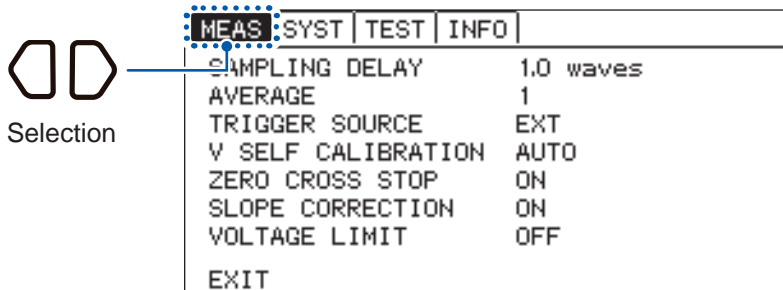

3 Select **[WAVE]** or **[ΔVOLT]**.

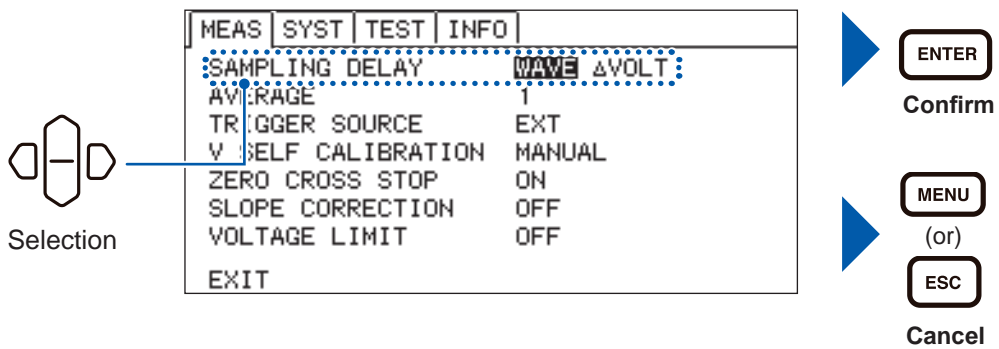

When selecting **[WAVE]**, set the wavenumber of delay. (0.0 waves to 9.0 waves)

Setting

MEAS	SYST	TEST	INFO
SAMPLING DELAY		1.0	waves
AVERAGE		1	
TRIGGER SOURCE		EXT	
V SELF CALIBRATION		MANUAL	
ZERO CROSS STOP		ON	
SLOPE CORRECTION		OFF	

Move to the next digit (left or right)
 Changing the numerical value (up and down)

ENTER
 Confirm
 MENU
 (or)
 ESC
 Cancel

When selecting **[VOLT]**, set the voltage. (00.001 mV to 10.000 mV)

Setting

MEAS	SYST	TEST	INFO
SAMPLING DELAY		00.010	mV
AVERAGE		1	
TRIGGER SOURCE		EXT	
V SELF CALIBRATION		MANUAL	
ZERO CROSS STOP		ON	
SLOPE CORRECTION		OFF	

Move to the next digit (left or right)
 Changing the numerical value (up and down)

ENTER
 Confirm
 MENU
 (or)
 ESC
 Cancel

4.3 Maintaining Voltage Measurement Accuracy (Self-Calibration Function)

This function compensates the offset voltage and the gain drift in the internal part of the circuit, to improve the voltage measurement accuracy.

To satisfy the instrument's measurement accuracy, the self-calibration is required. Be sure to perform it. Be sure to perform the self-calibration especially after warming-up or when the ambient temperature has changed more than 2°C.

The methods for configuring self-calibration to run are as follows:

AUTO	Self calibration of 0.2 s is automatically executed before measuring the voltage. In the functions (R, X, T) and (Z, θ , T) where the voltage measurement is not performed, the self-calibration is not performed.
MANUAL	The self-calibration is performed from the input signal CAL of the EXT.I/O, or from the command. (Perform it under the TRIG waiting condition. When the signal is input, perform it after the measurement.)

- 1 Press **MENU** (**MENU**). (The setting screen appears.)

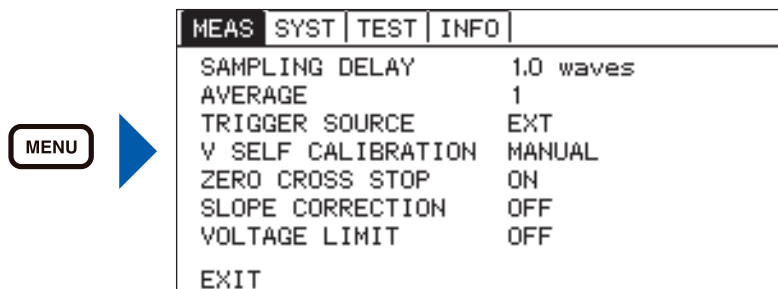

- 2 Select **[MEAS]** tab.

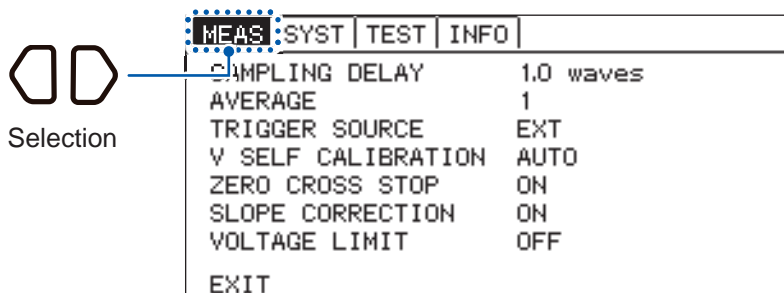

- 3 Select **[AUTO]** or **[MANUAL]**.

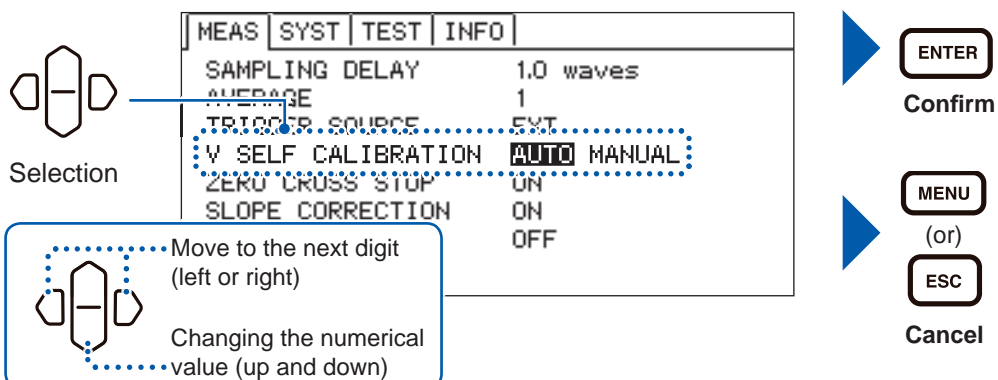

4.4 Stabilizing the Measurement Values (Average Function)

The arithmetic mean for the set number of measurement values will be displayed as the result. This function can reduce the fluctuation of the measurement values. This function can apply only to the impedance measurement.

- 1 Press **MENU** (**MENU**). (The setting screen appears.)

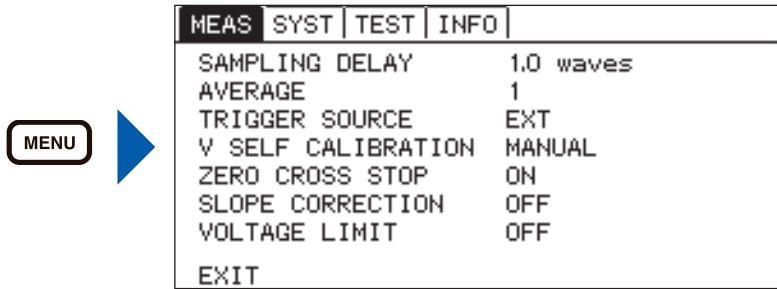

- 2 Select **[MEAS]** tab.

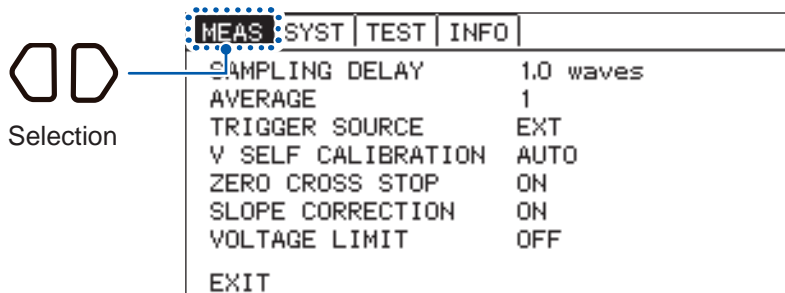

- 3 Sets the number of measured values to be used for averaging. (1 to 99)

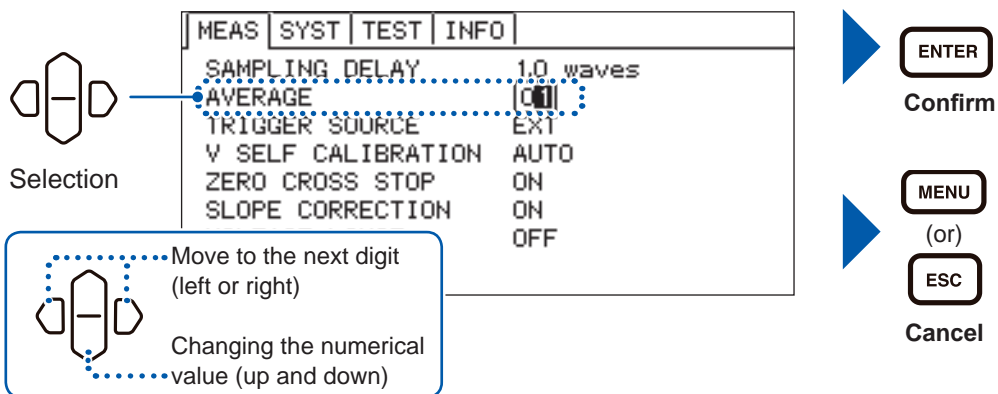

4.5 Compensating the Potential Slope Due to Electric Discharge (Slope Correction Function)

During impedance measurement, the measurement signal may drift due to characteristics of the battery and input impedance of the measuring instrument. This function performs compensation for linear drift.

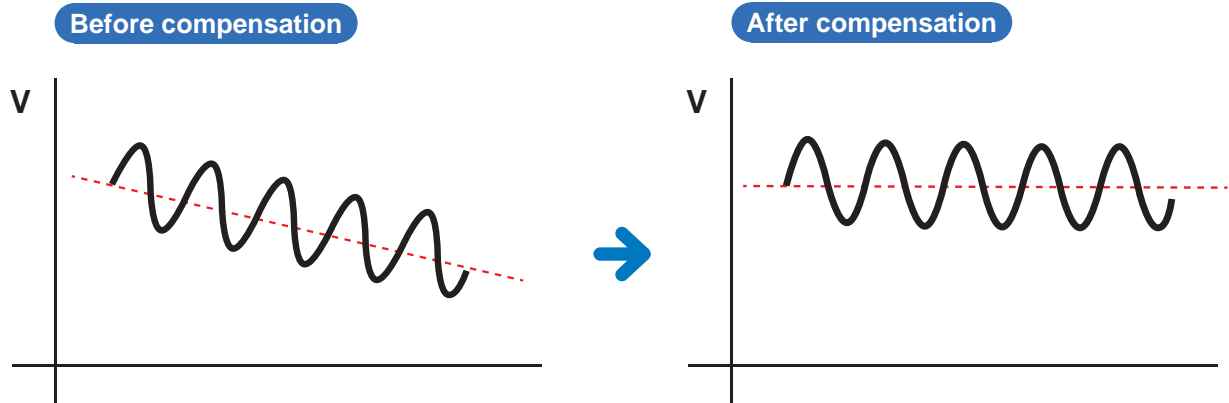

IMPORTANT

Compensation will be performed for linear drift.

Proper compensation cannot be performed for fluctuations that are not linear as shown below.

“Starting the Measurement After the Response of the Measuring Object is Stable (Sample Delay Function)” (p. 38) is used, and wait to measure until the measuring object’s response time becomes stable.

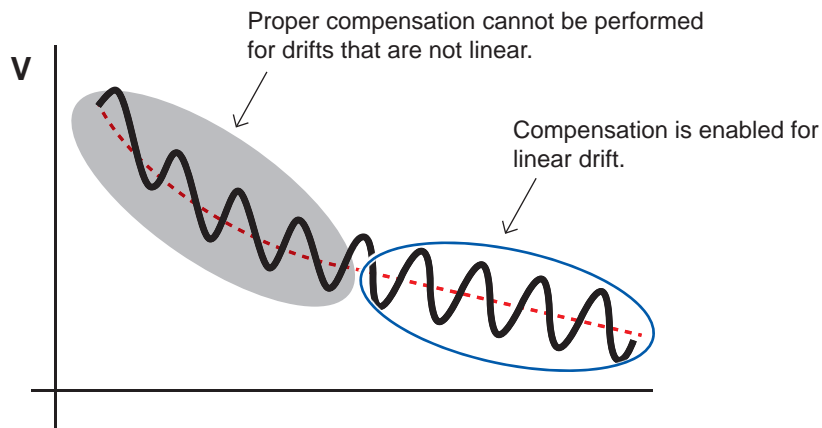

1 Press **MENU** (**MENU**). (Settings screen is displayed.)

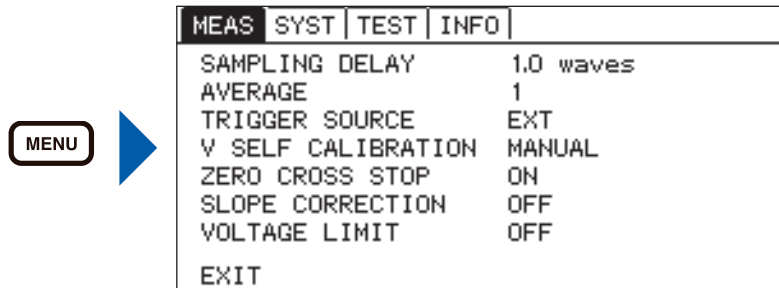

2 Select **MEAS** tab.

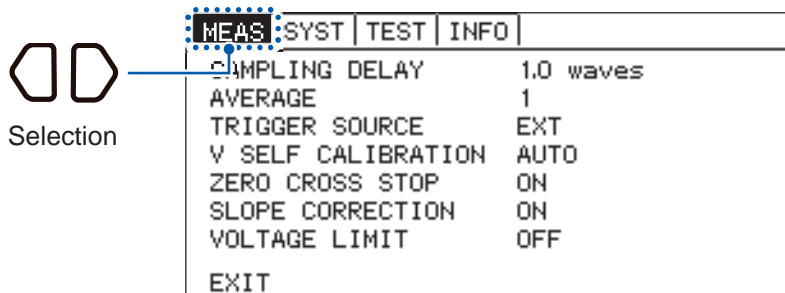

3 Select **ON** or **OFF**.

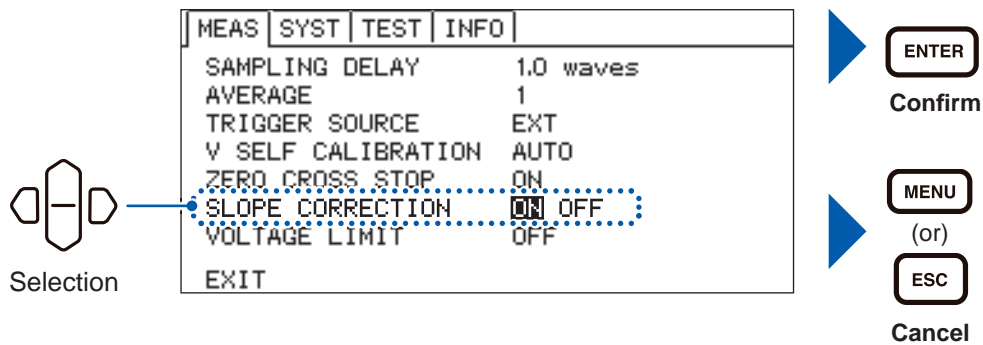

4.6 Preventing the Overcharge due to Measurement Signal (Voltage Limit Function)

This function prevents the battery from getting overcharged due to the applied signal when measuring impedance. If the voltage of the object to be measured is higher compared to the set voltage, impedance will not be measured and the message **[OVER V LIMIT]** will be displayed.

⚠ CAUTION



Set the voltage limit value lower than the voltage value of the measuring object's battery which will become overcharged. The battery may be overcharged, if the measurement is repeated at a high voltage value setting.

- 1 Press **[MENU]** (**MEAS**). (Settings screen is displayed.)

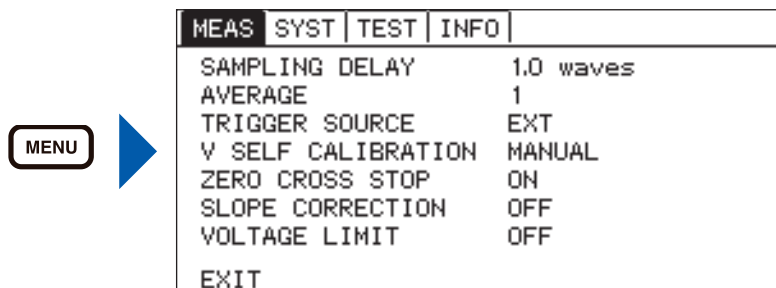

- 2 Select **[MEAS]** tab.

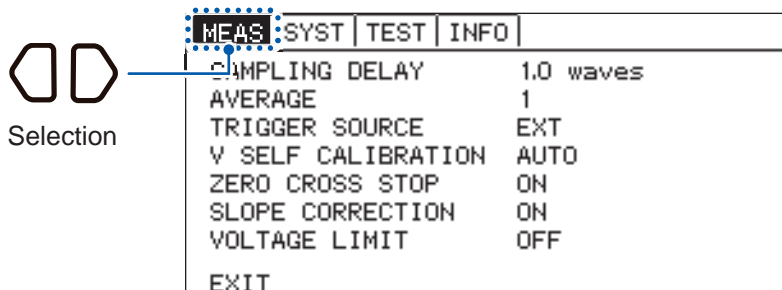

- 3 Select **[ON]** or **[OFF]**.

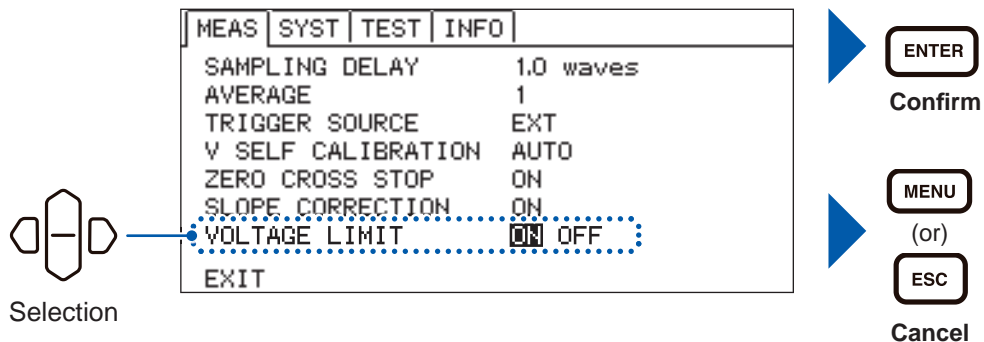

When selecting **[ON]**, set the voltage. (0.01 V to 5.00 V)

The screenshot shows a menu with the following items:

MEAS	SYST	TEST	INFO
SAMPLING DELAY		1.0 waves	
AVERAGE		1	
TRIGGER SOURCE		EXT	
V SELF CALIBRATION		AUTO	
ZERO CROSS STOP		ON	
SLOPE CORRECTION		ON	

The '4.20 V' value is highlighted with a dashed box. A callout box explains navigation: 'Move to the next digit (left or right)' and 'Changing the numerical value (up and down)'. To the right, a legend shows: ENTER Confirm, MENU (or) ESC Cancel.

4.7 Prevents Charging and Discharging due to the Measurement Signal (Measurement Signal Zero Cross Stop Function)

This function performs the process of stopping the applied measurement signal at zero cross during impedance measurement to prevent charging and discharging of the object to be measured. When the measurement signal zero cross stop function is enabled, the measurement time increases by approximately one cycle of measurement frequency.

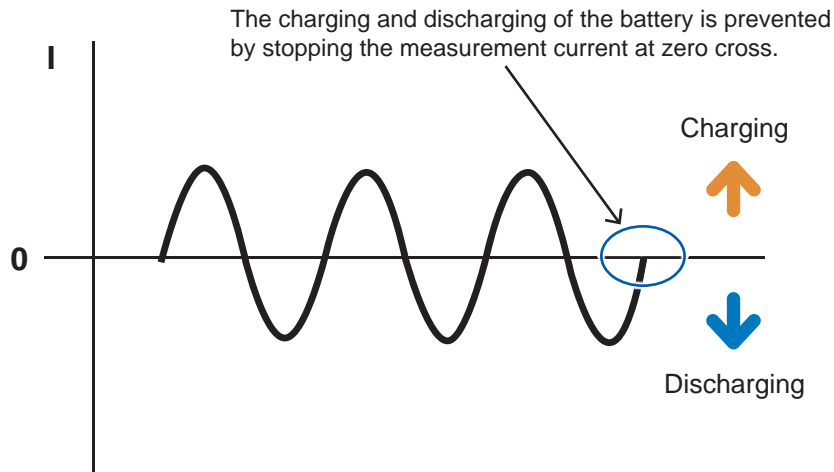

1 Press **MENU** (**MENU**). (Settings screen is displayed.)

MENU →

MEAS	SYST	TEST	INFO
SAMPLING DELAY		1.0 waves	
AVERAGE		1	
TRIGGER SOURCE		EXT	
V SELF CALIBRATION		MANUAL	
ZERO CROSS STOP		ON	
SLOPE CORRECTION		OFF	
VOLTAGE LIMIT		OFF	
EXIT			

2 Select **[MEAS]** tab.

Selection →

MEAS	SYST	TEST	INFO
SAMPLING DELAY		1.0 waves	
AVERAGE		1	
TRIGGER SOURCE		EXT	
V SELF CALIBRATION		AUTO	
ZERO CROSS STOP		ON	
SLOPE CORRECTION		ON	
VOLTAGE LIMIT		OFF	
EXIT			

3 Select [ON] or [OFF].

Selection

MEAS	SYST	TEST	INFO
SAMPLING DELAY			1.0 waves
AVERAGE			1
TRIGGER SOURCE			EXT
V SELF CALIBRATION			AUTO
ZERO CROSS STOP			[ON] OFF
SLOPE CORRECTION			ON
VOLTAGE LIMIT			OFF
EXIT			

ENTER
Confirm

MENU
(or)
ESC
Cancel

5

Judging Measurement Results (Comparator Function)

The function judges that the measured value is in the range of Hi (upper limit value < measured value), or IN (lower limit value ≤ measured value ≤ upper limit value), or Lo (measured value < lower limit value) compared to the preset upper and lower limit value.

Upper and lower limit values and absolute values (absolute values setting is for voltages [V] only)

Upper and lower limit values

The function judges whether the measurement value is in the Hi, IN, or Lo range for the upper and lower limit values set previously.

(Example: If the upper limit is 3 V, Lower limit is 2 V, and the measurement value is 1.5 V)

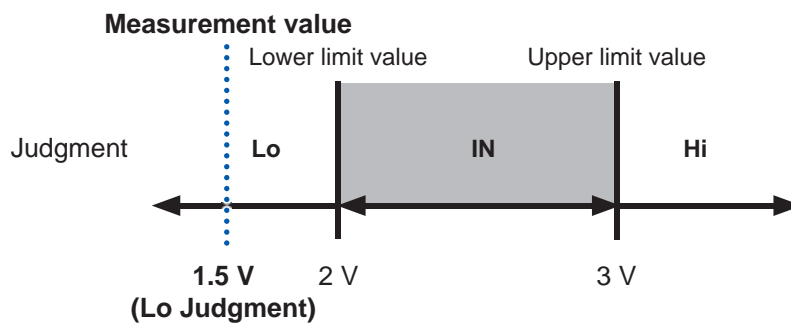

Absolute value

The function judges whether the absolute value of the measurement value is in the Hi, IN, or Lo range for the upper and lower limit values set previously.

Even if wiring is connected in reversed polarity, judgment can be performed correctly.

(Example: If the upper limit 3 V, Lower limit is -1 V, and the measurement value is -2 V)

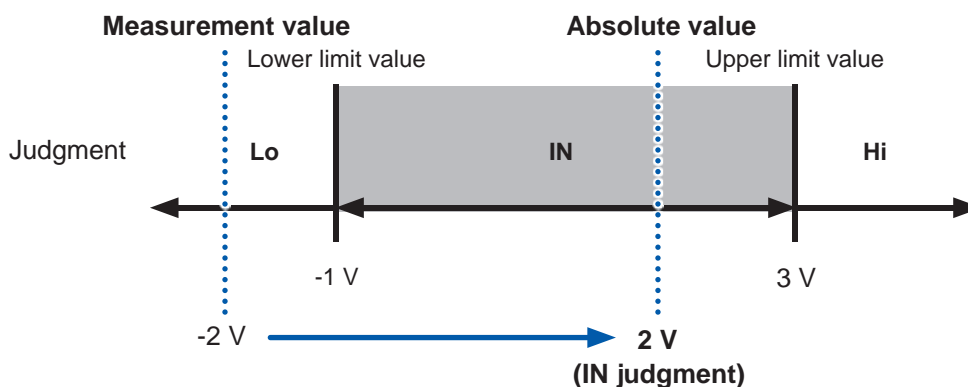

5.1 Turning the Comparator Function ON and OFF

1 Press **COMP** (**COMP**). (The setting screen appears.)

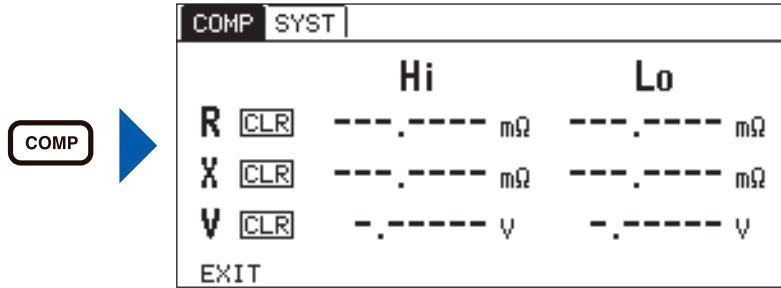

2 Select **[SYST]** tab.

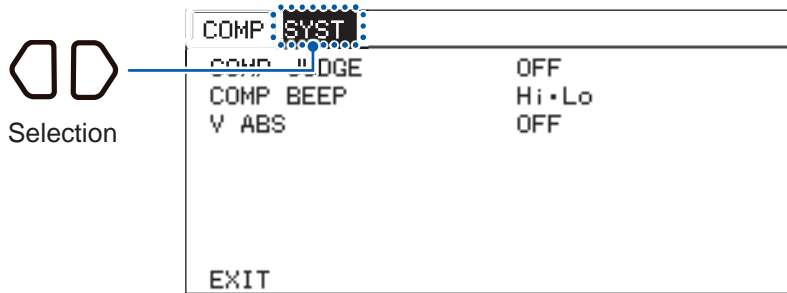

3 Select **[ON]** or **[OFF]**.

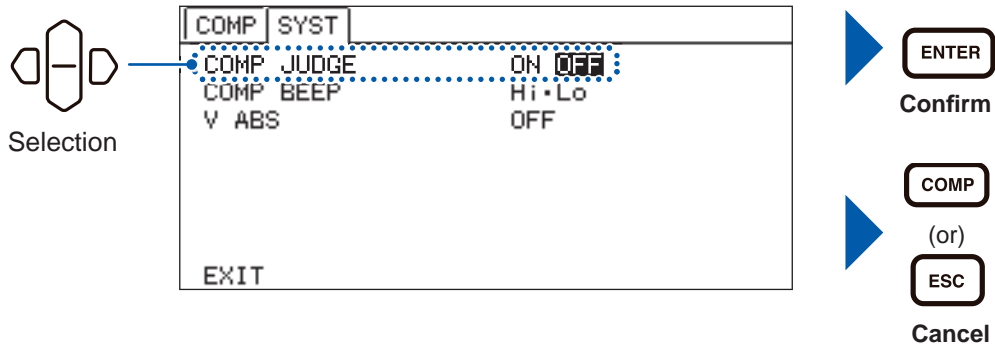

5.2 Setting the Upper and Lower Limit Value

When making the comparator function effective, set the upper and lower limit value, which are used for the judgment. The following describes the setting method, taking R, X, V as the examples.

Setting examples

R	Upper limit value:	7.5 mΩ	Lower limit value:	7 mΩ
X	No judgment			
V	Upper limit value:	5 V	Lower limit value:	4 V

1 Press **COMP** (**COMP**). (The setting screen appears.)

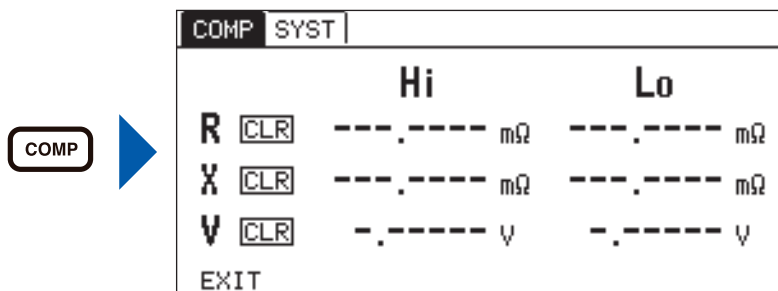

2 Select **[COMP]** tab.

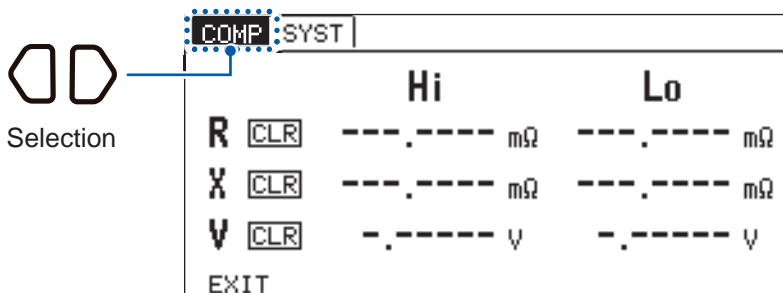

3 Select parameter **[R]**.

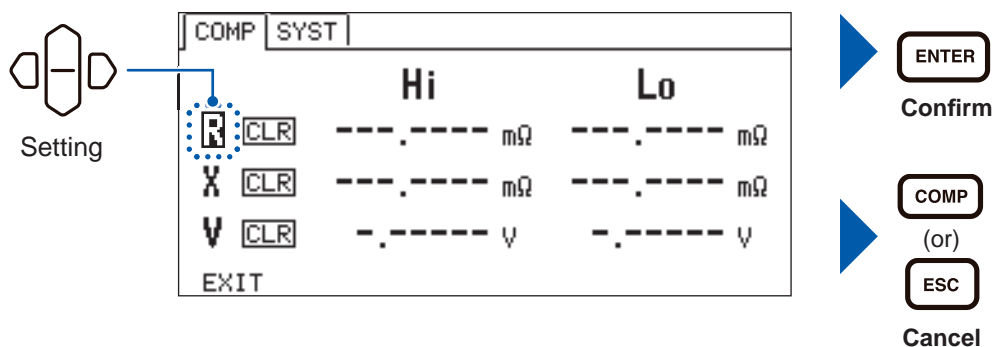

4 Set the upper limit value of [R] at 7.5000 mΩ, and the lower limit value at 7.0000 mΩ.

Upper limit value Lower limit value

	Hi	Lo
R [CLR]	+007.5000 mΩ	+007.0000 mΩ
	----- mΩ	----- mΩ
	∇	∇

COMP SYST

ENTER
Confirm

COMP
(or)
ESC
Cancel

Move to the next digit (left or right)
Changing the numerical value (up and down)

5 Since the parameter [X] is not used, the value is not set. ([---.---]) display indicates disabled.)

	Hi	Lo
R [CLR]	+007.5000 mΩ	+007.0000 mΩ
X [CLR]	---.--- mΩ	---.--- mΩ
V [CLR]	---.--- V	---.--- V

COMP SYST

EXIT

6 Select parameter [V].

Selection

	Hi	Lo
R [CLR]	+007.5000 mΩ	+007.0000 mΩ
X [CLR]	---.--- mΩ	---.--- mΩ
V [CLR]	---.--- V	---.--- V

COMP SYST

EXIT

ENTER
Confirm

COMP
(or)
ESC
Cancel

7 Set the upper limit value of [V] at 5.00000 V, and the lower limit value at 4.00000 V.

Upper limit value Lower limit value

	Hi	Lo
V [CLR]	+5.00000 V	+4.00000 V
	----- V	----- V

COMP SYST

EXIT

ENTER
Confirm

COMP
(or)
ESC
Cancel

Move to the next digit (left or right)
Changing the numerical value (up and down)

When [CLR] is selected and confirmed, the set value is displayed as [-.----] and is disabled. Disabled parameters are not judged.

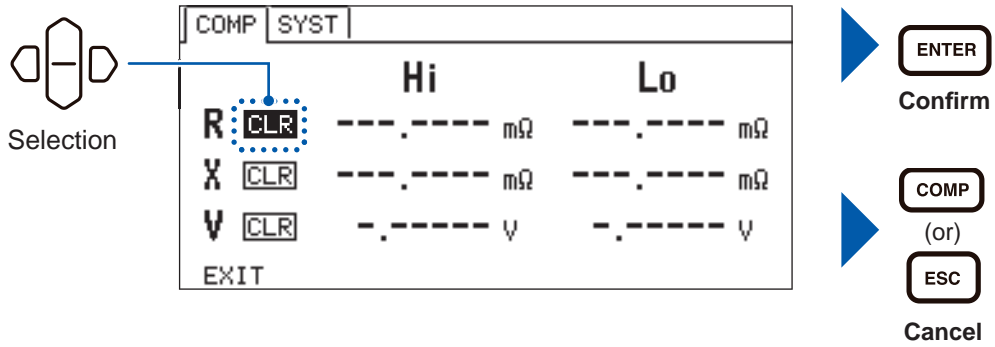

When set to 100 mΩ range (Minimum resolution 0.001 mΩ)

Rounded off to the minimum digits set.

After rounding, the upper limit will be 7.500 mΩ, and the lower limit will be 7.001 mΩ.

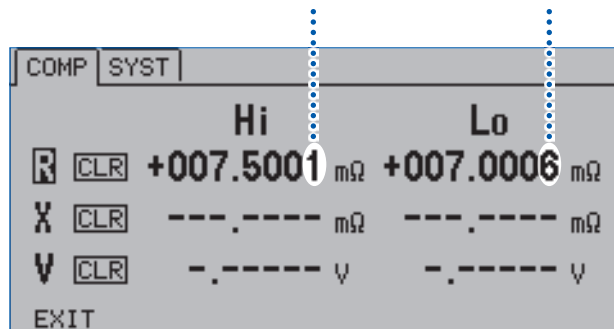

Settable range

R	-003.0000 mΩ to +120.0000 mΩ
X	-120.0000 mΩ to +120.0000 mΩ
Z	+000.0000 mΩ to +120.0000 mΩ
θ	-180.000° to +180.000°
V	-5.10000 V to +5.10000 V
Common in all ranges	

IMPORTANT

When the value of Hi is set smaller than the value of Lo, the value of Hi set is corrected to the value of Lo.

5.3 Voltage is Judged with the Absolute Value

The upper and lower limit of voltage is judged with the absolute values.
(R, X, Z and θ cannot be set to be judged with absolute values.)

- 1 Press **COMP** (**COMP**). (Settings screen is displayed.)

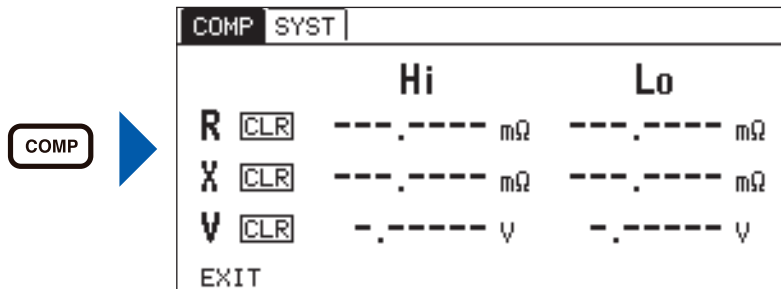

- 2 Sets the upper and lower limit values for **V**. (p. 51)

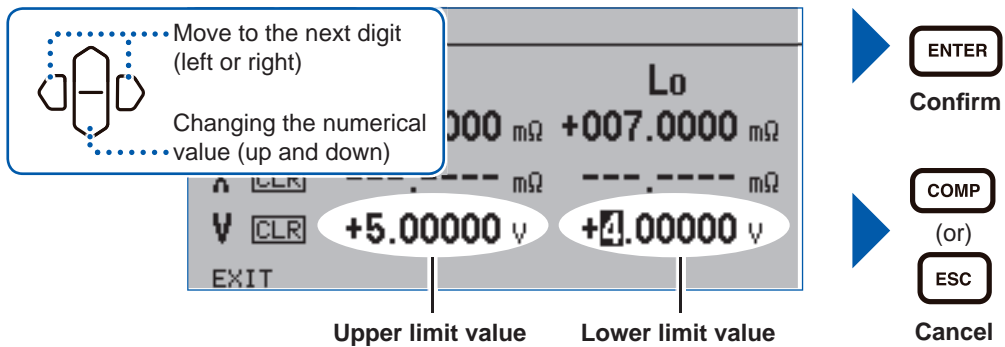

- 3 Select **[SYST]** tab.

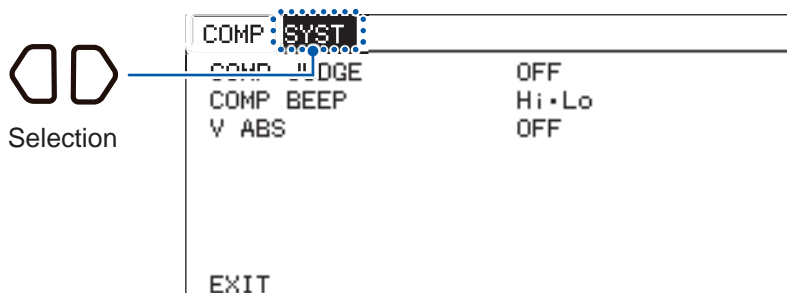

- 4 Select **[ON]** or **[OFF]**.

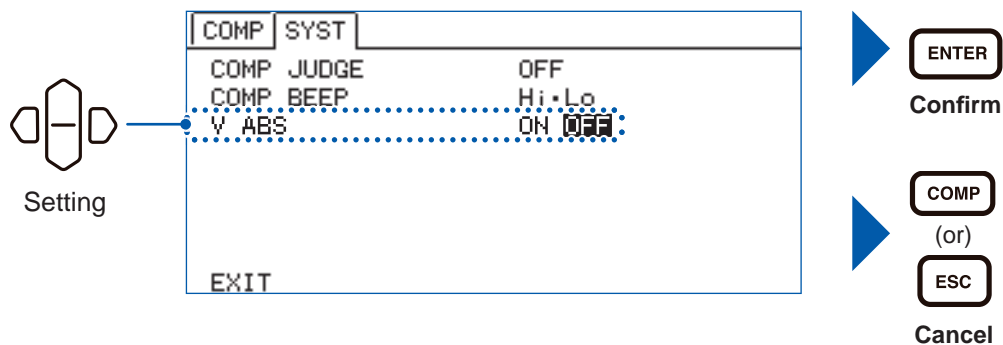

5.4 Checking the Judgment with Sound

Select whether to use a judgment sound of the measurement results.

- OFF** : The buzzer does not sound.
- Hi • Lo** : When the judgment result is Hi • Lo, the buzzer sounds (three short sounds).
- IN** : When the judgment result is IN, the buzzer sounds (long sound).
- ALL** : When the judgment result is Hi • Lo, the buzzer sounds (three short sounds).
When the judgment result is IN, the buzzer sounds (long sound).

Setting the sound				
Judgment result in measurement	OFF	Hi • Lo	IN	ALL
HI	—	✓ (three short sounds)	—	✓ (three short sounds)
IN	—	—	✓ (long sound)	✓ (long sound)
Lo	—	✓ (three short sounds)	—	✓ (three short sounds)

—: No buzzer sound, ✓(long sound): Long buzzer sound, ✓(three short sounds): Three short buzzer sounds.

1 Press **COMP** (**COMP**). (The setting screen appears.)

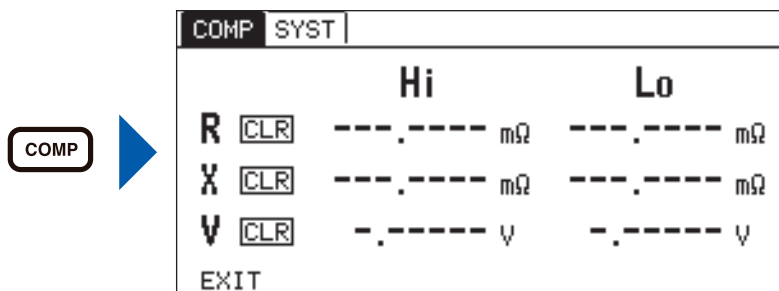

2 Select **[SYST]** tab.

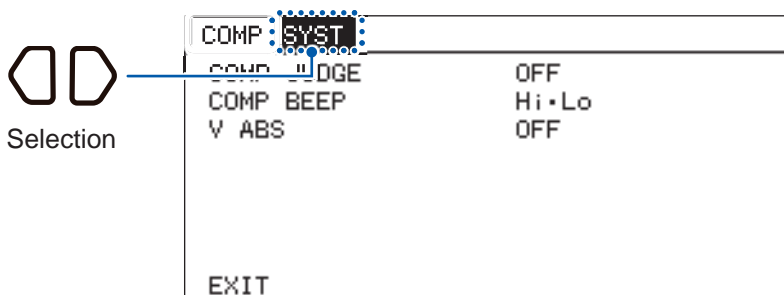

3 Select the buzzer sound from among **[OFF]**, **[IN]**, **[Hi • Lo]**, **[ALL]**.

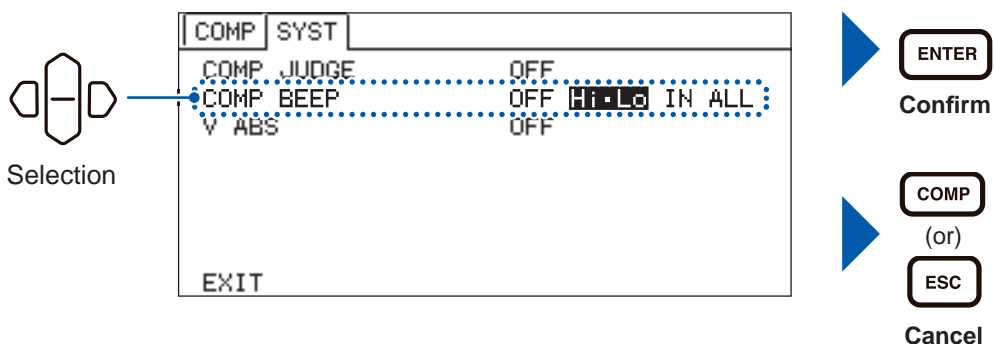

5.5 Checking the Judgment Result

The indicator appears at the left of the parameters on the measurement screen depending on the judgment result.

Each judgment result, and the comprehensive judgment result of all the parameters are output to the EXT.I/O.

PASS of the comprehensive judgment result is ON (FAIL is OFF) only when all the enabled parameters judged by the comparator are IN.

IN	When the measured value is smaller than the upper limit value and greater than the lower limit value.
Hi	When the measured value is greater than the upper limit value that is set.
Lo	When the measured value is smaller than the lower limit value that is set.

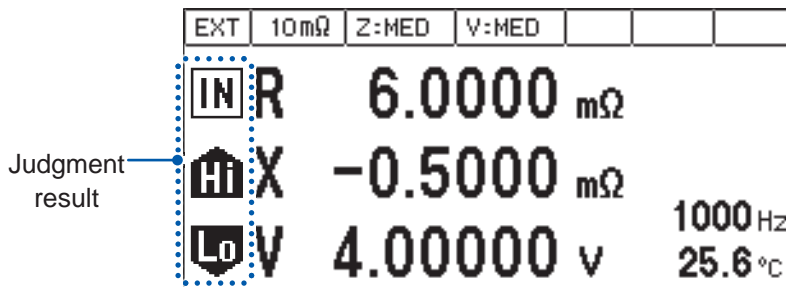

Measurement result	Judgment result	Output of EXT. I/O					
		Hi	IN	Lo	ERR	PASS	FAIL
Hi Set value < Measured value	Hi	ON	OFF	OFF	OFF	OFF	ON
Lo Set value ≤ Measured value ≤ Hi Set value	IN	OFF	ON	OFF	OFF	ON	OFF
Measured value < Lo Set value	Lo	OFF	OFF	ON	OFF	OFF	ON
OverRange	Hi	ON	OFF	OFF	OFF	OFF	ON
Measurement Error	No judgment	OFF	OFF	OFF	ON	OFF	OFF
During interruption of measurement	No judgment	OFF	OFF	OFF	OFF	OFF	OFF

6

Saving and Reading Measurement Conditions (Panel Saving and Loading)

The present measurement conditions are saved to the memory of the instrument (panel saving function), and the measurement conditions are read from the memory by the key operation, communication command transmission, and external control. (Panel loading function)

The instrument can save 126 panels of measurement conditions at a maximum. The measurement conditions that are saved are retained even if the power is turned off, which can be read by the panel loading function.

Items that can be saved by the panel saving

Saving contents	• Measurement functions	• Measurement range	• Measurement frequency
	• Measurement speed of impedance	• Measurement speed of voltage	• Zero adjustment setting
Numbers of panel	• Zero adjustment data	• Sample delay setting	• Comparator setting
	• Average	• Slope correction setting	• Voltage limit
	• Self-Calibration settings	• Measurement signal zero cross stop function	• Trigger source
	126		

6.1 Saving the Setting Conditions (Panel Saving Function)

Saves the measurement conditions that are currently set.

- 1 Press **LOAD/SAVE** (**LOAD/SAVE**). (The panel screen appears.)

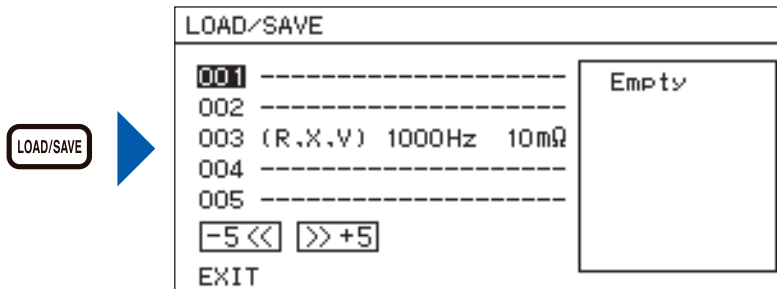

- 2 Select the number of the panel that will be saved.

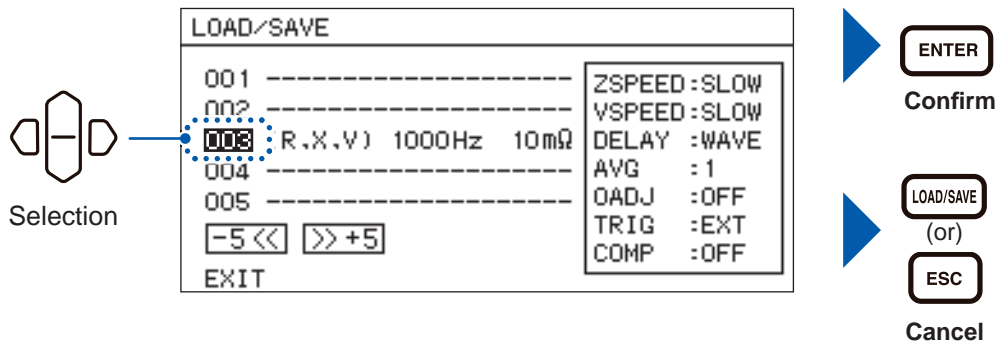

- 3 Select **SAVE**.

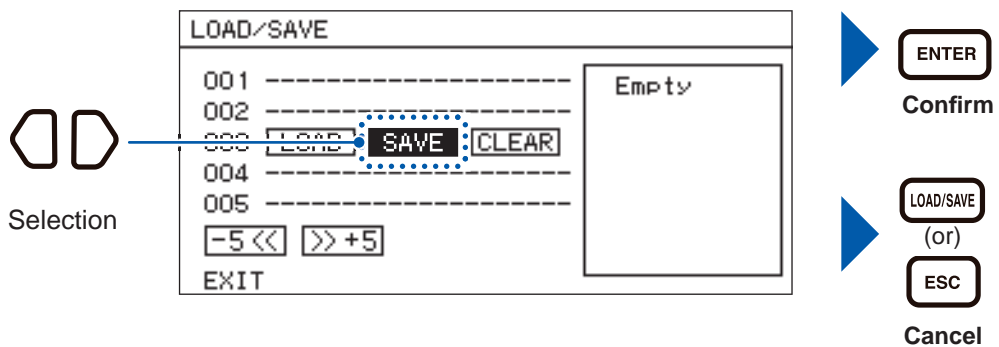

(When selecting the number of the panel that has been saved, the confirmation window will appear.)

OK: Overwriting
CANCEL: Cancel

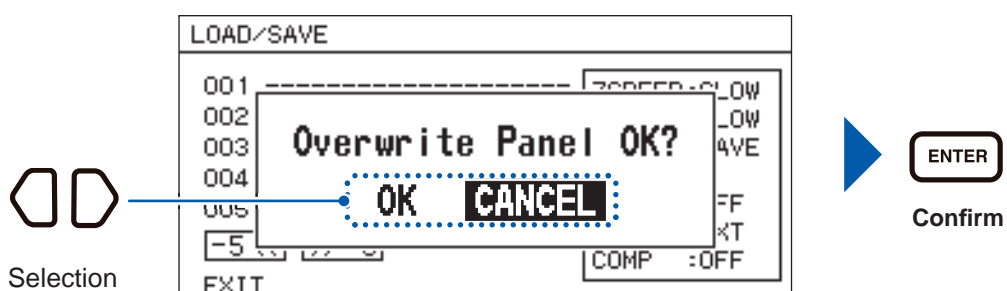

When **[+5]** is selected, the next 5 panel numbers are displayed. When **[-5]** is selected, the previous 5 panel numbers are displayed.

LOAD/SAVE	
006 -----	Next 5
007 -----	
008 -----	
009 -----	
010 -----	
[-5<< >>+5	
EXIT	

6.2 Reading the Setting Conditions (Panel Loading Function)

Reads the measurement conditions that are saved.

- 1 Press **LOAD/SAVE** (**LOAD/SAVE**). (The panel screen appears.)

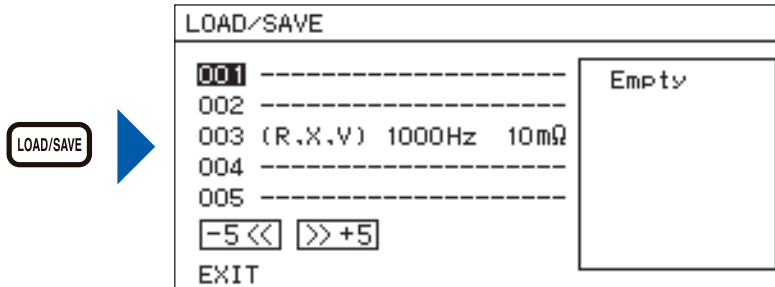

- 2 Select the number of the panel that will be read.

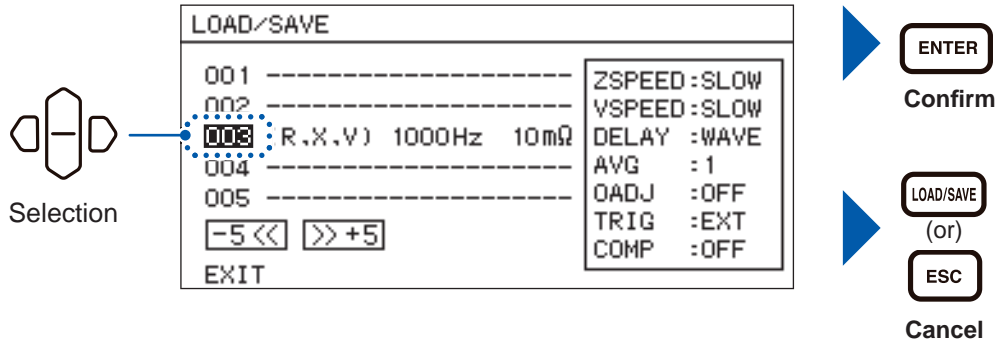

- 3 Select **[LOAD]**.

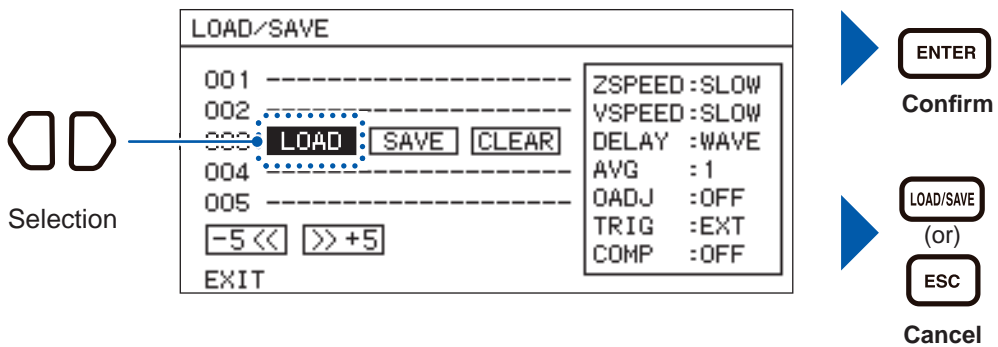

When **[+5]** is selected, the next 5 panel numbers are displayed. When **[-5]** is selected, the previous 5 panel numbers are displayed.

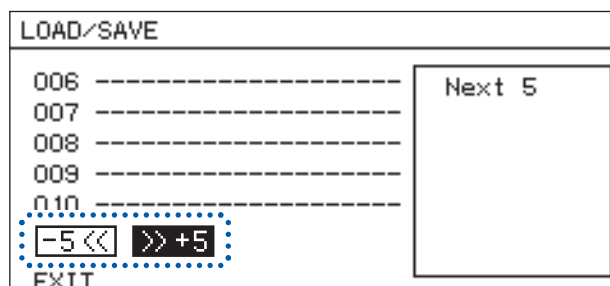

6.3 Deleting the Contents of the Panel

Deletes saved measurement conditions.

- 1 Press **LOAD/SAVE** (**LOAD/SAVE**). (Panel screen is displayed.)

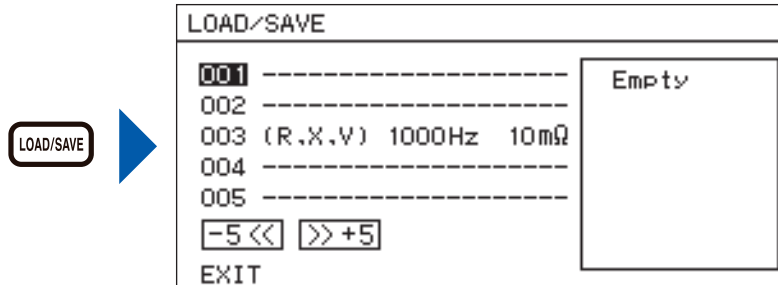

- 2 Select a panel number to be deleted.

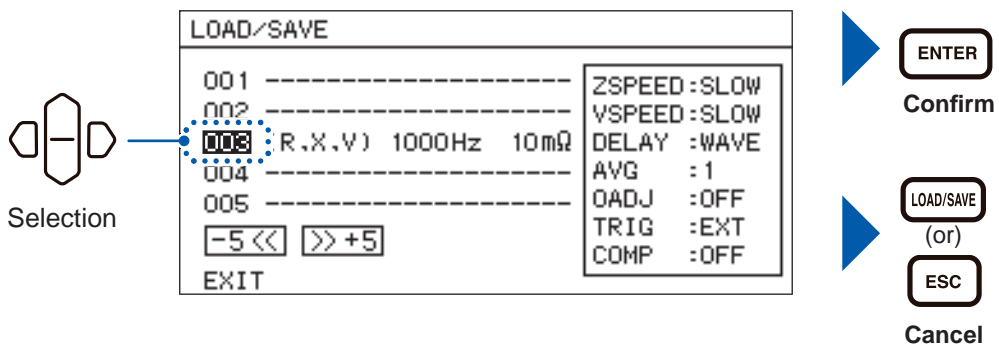

- 3 Select **[CLEAR]**.

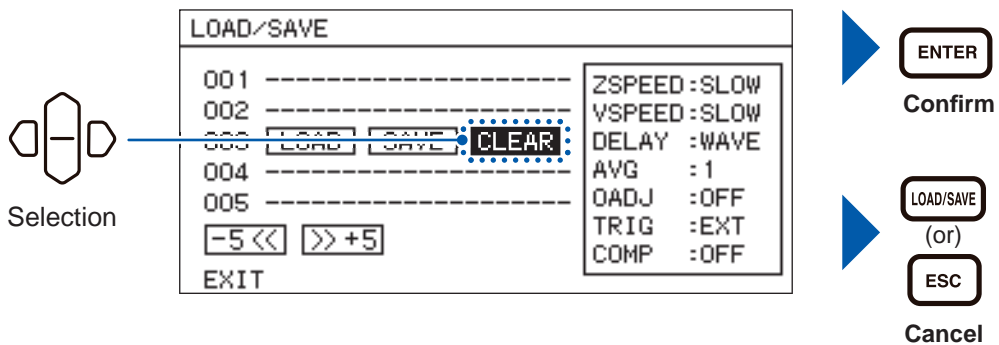

- 4 Opens confirmation window.
OK: Clear
CANCEL: Cancel

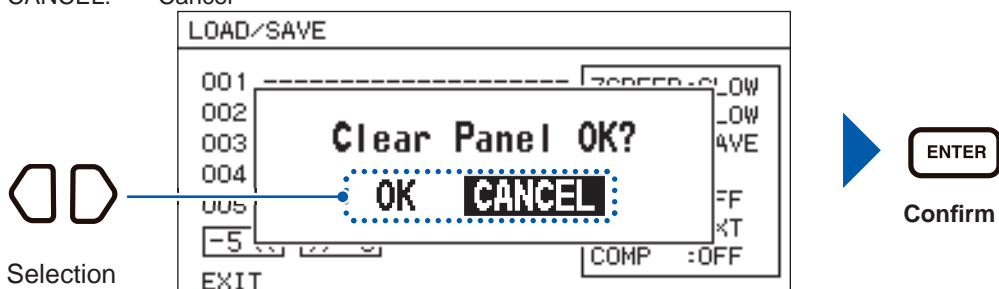

7 System Setting

7.1 Making the Key Operation Effective or Ineffective

Makes the key operation except for **START/STOP** (**START/STOP**) ineffective.

Ineffective

- 1 Press **MENU** (**MENU**). (The setting screen appears.)

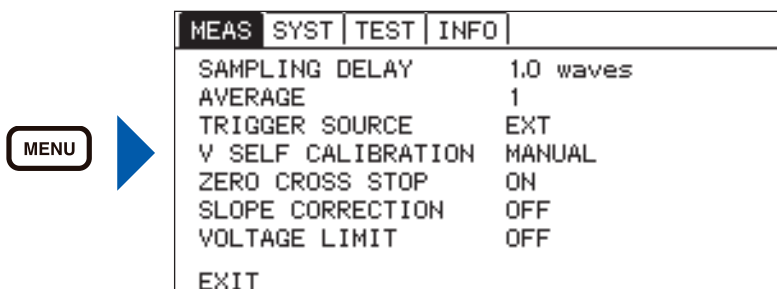

- 2 Select **[SYST]** tab.

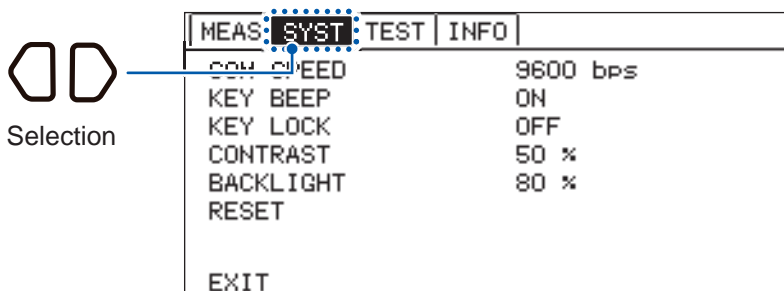

- 3 Select **[ON]**.

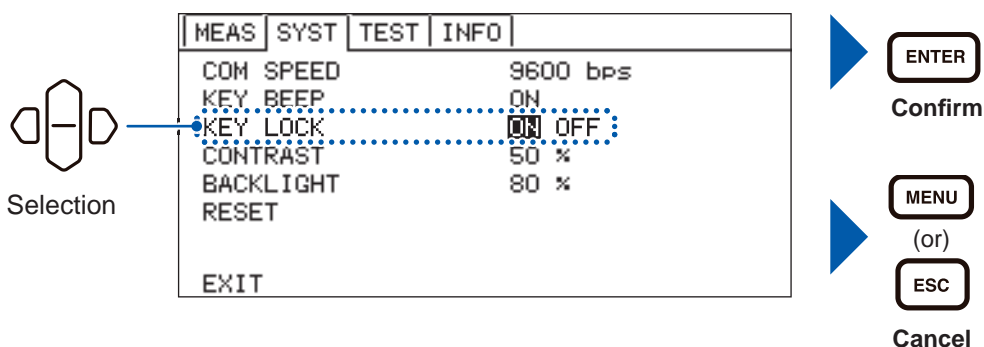

- 4 **[LOCK]** appears on the measurement screen, and the key operation becomes ineffective.

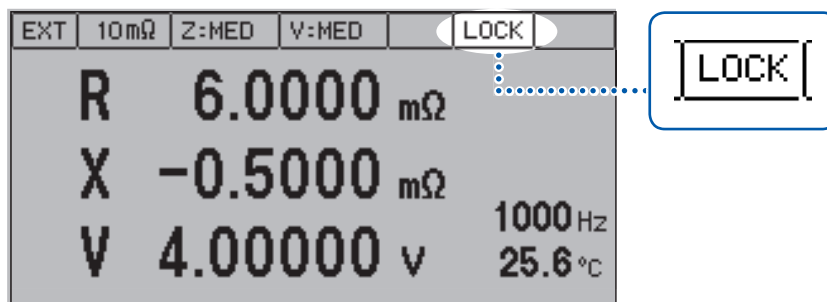

Effective

- 1 Press **LOCAL** (**LOCAL**) and hold for at least 5 seconds.
- 2 **[LOCK]** disappears on the measurement screen, and the key operation becomes effective.

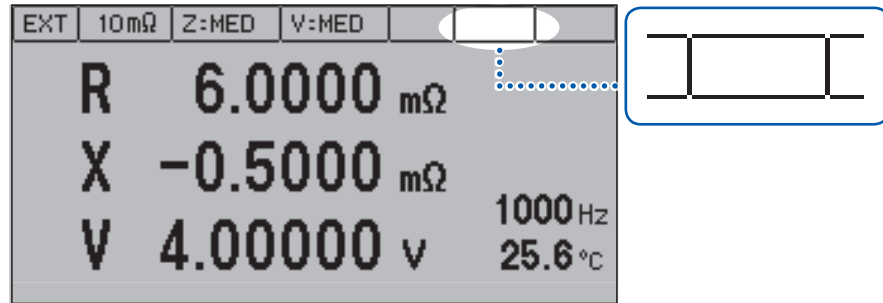

7.2 Setting the Sound of the Key Operation Effective or Ineffective

Make the sound of the key operation effective or ineffective.

- 1 Press **MENU** (**MENU**). (The setting screen appears.)

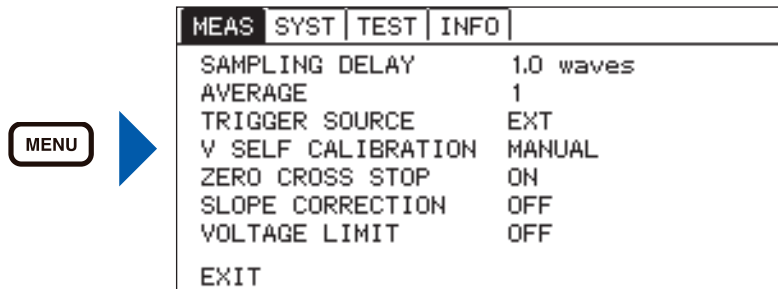

- 2 Select **[SYST]** tab.

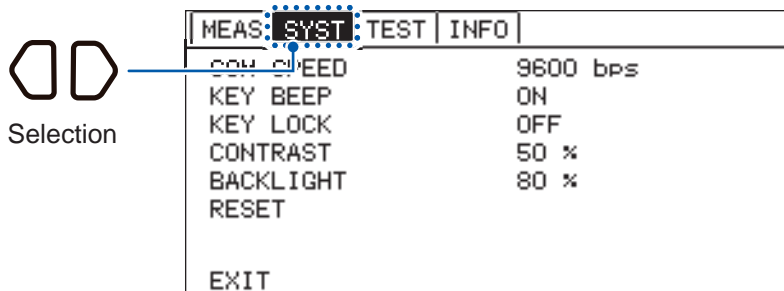

- 3 Select **[ON]** or **[OFF]**.

ON : The operation sound is beeped.
 OFF : The operation sound is not beeped.

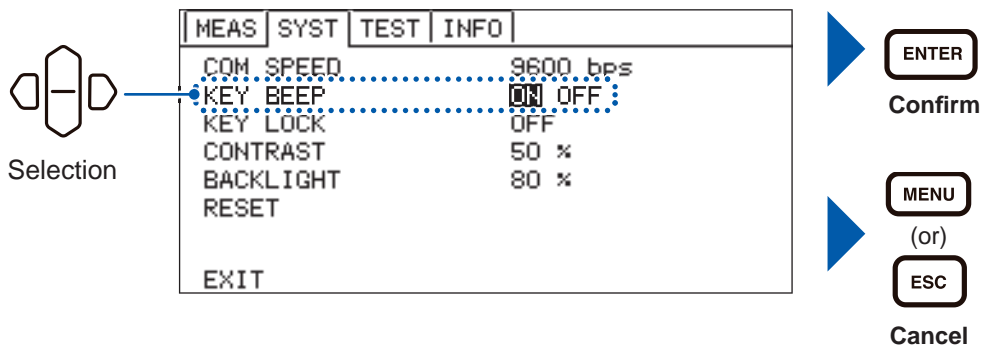

7.3 Adjusting the Contrast of the Screen

The visibility of the screen may not be clear at some ambient temperatures. The visibility of the screen can be adjusted by adjusting the screen contrast.

- 1 Press **MENU** (**MENU**). (The setting screen appears.)

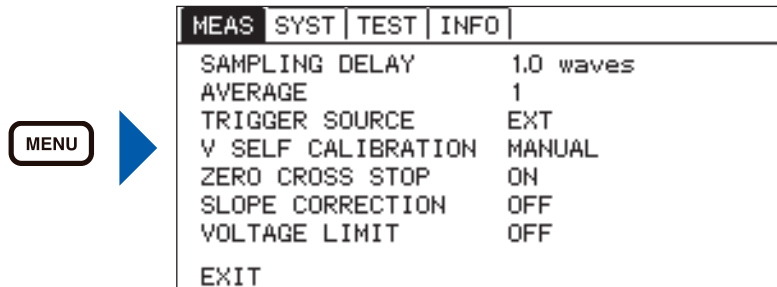

- 2 Select **[SYST]** tab.

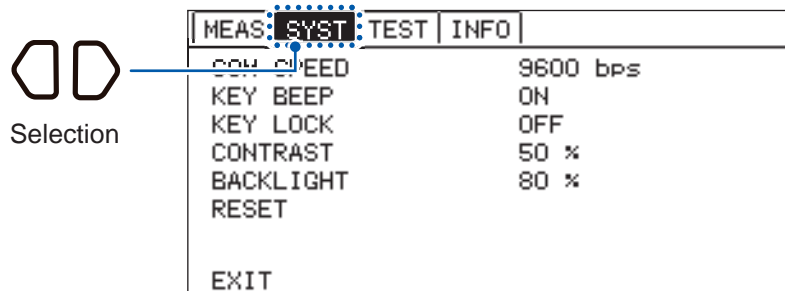

- 3 Adjust the contrast of the screen.



: Increases the contrast.



: Decreases the contrast.

Setting range : 0% to 100%, steps of 5% (default setting: 50%)

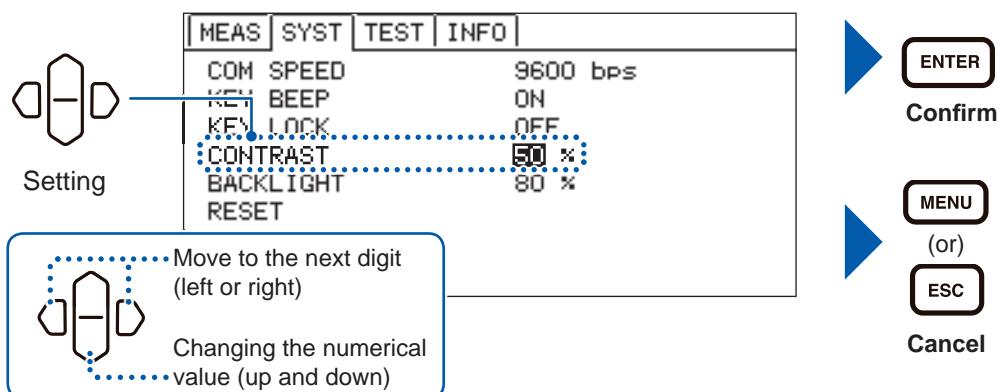

7.4 Adjusting the Backlight

The brightness of the backlight can be adjusted for the illumination of the installation location.

When the trigger source is set from the external trigger, if the status with no operation continues for 1 minute, the brightness of the backlight will become dim automatically.

- 1 Press **MENU** (**MENU**). (The setting screen appears.)

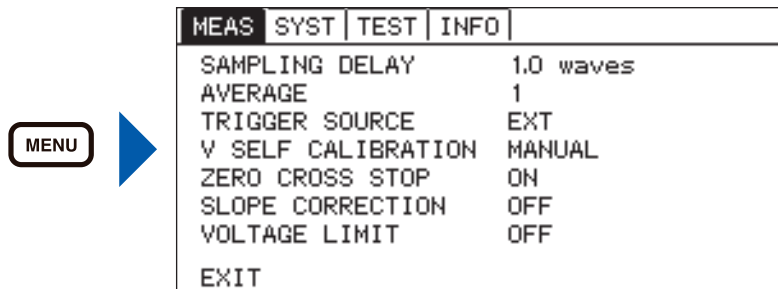

- 2 Select **[SYST]** tab.

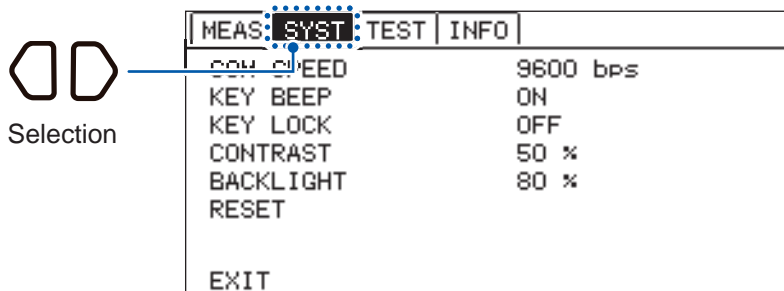

- 3 Adjust the backlight.



: Raise the backlight brightness.



: Drop the backlight brightness.

Setting range : 10% to 100%, steps of 5% (default setting: 80%)

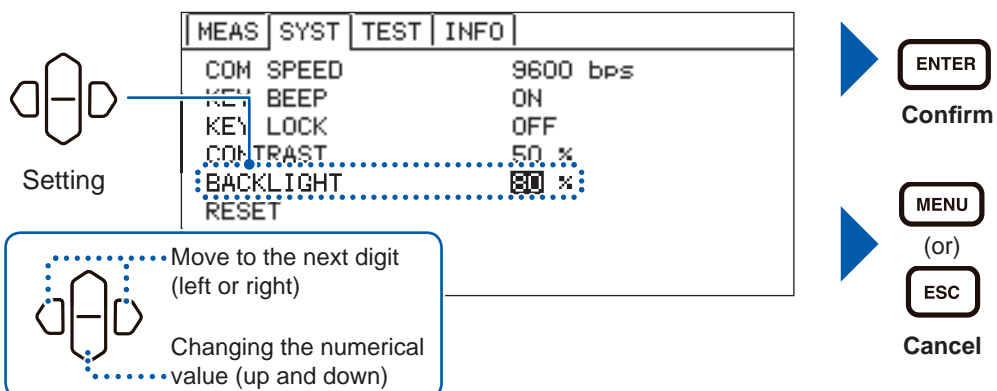

7.5 System Testing

I/O TEST

The input and output test of the EXT. I/O can be performed. The ON and OFF of the output signal can be switched manually. In addition, the status of the input signal can be monitored on the screen.

- 1 Press **MENU** (**MENU**). (The setting screen appears.)

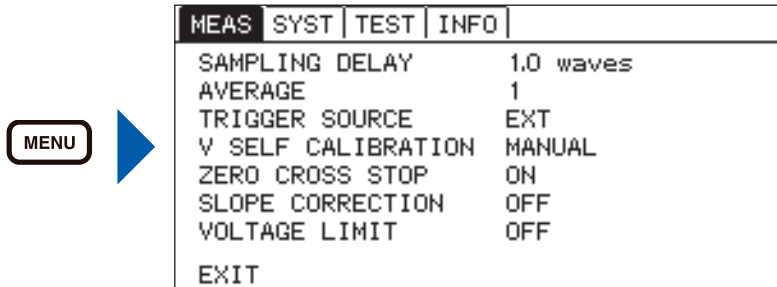

- 2 Select **TEST** tab.

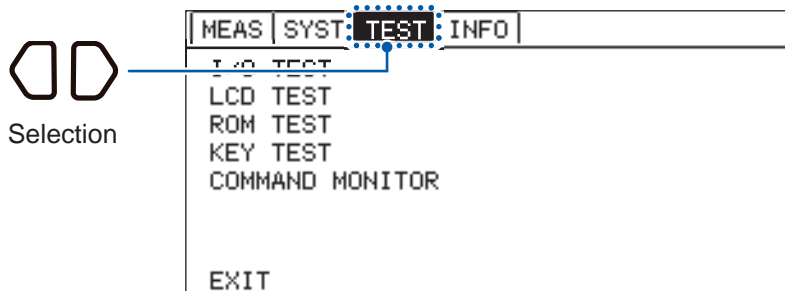

- 3 Select **I/O TEST**.

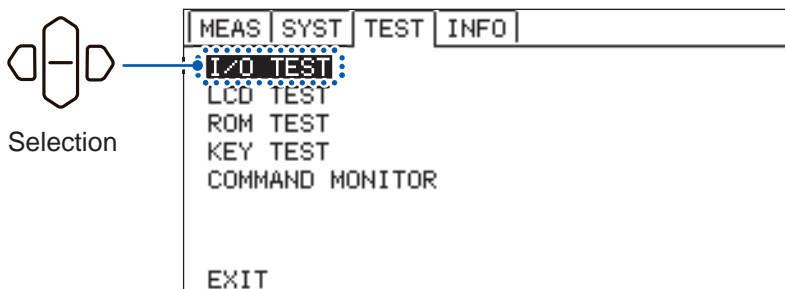

- 4 Test I/O devices.
(Commands and queries due to communication could not be performed during I/O testing.)

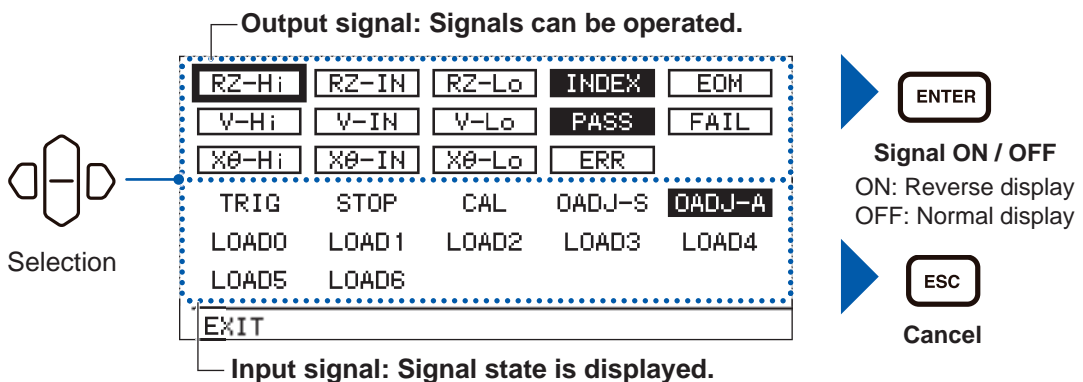

KEY TEST

This test can check that the key is not defective.

- 1 Press **MENU** (**MENU**). (The setting screen appears.)

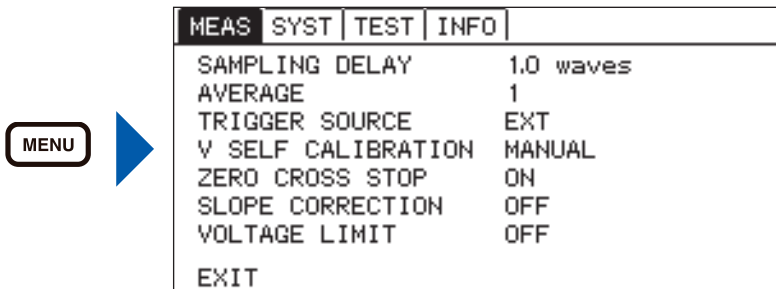

- 2 Select **TEST** tab.

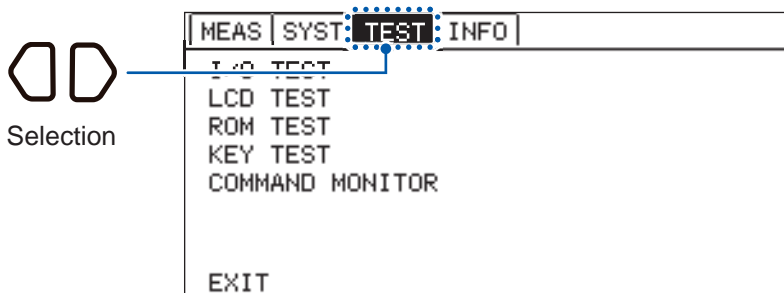

- 3 Select **KEY TEST**.

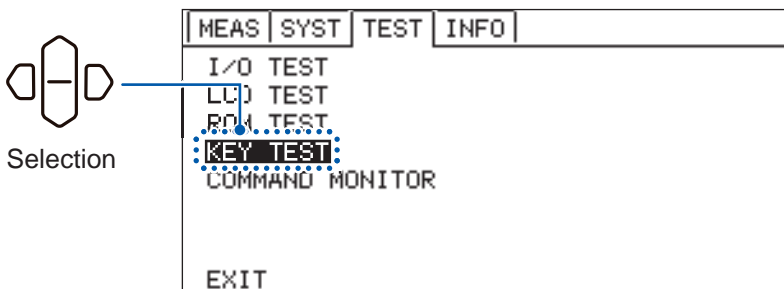

- 4 Press the keys of the instrument to test the keys. (Check that all the key names on the screen are reversed.)

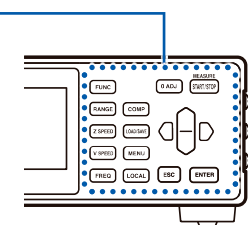
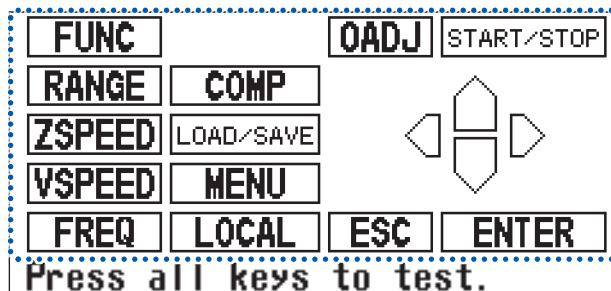

- 5 The screen returns to the key test screen.

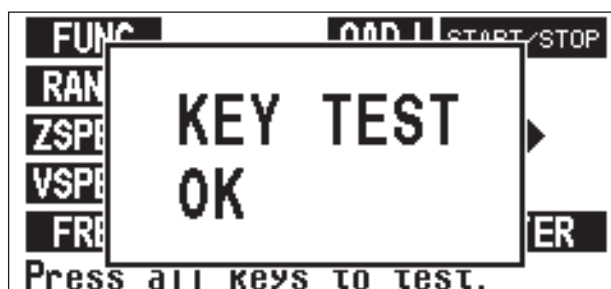

LCD TEST

This test can check that there is no dead pixel on the display screen.

- 1 Press **MENU** (**MENU**). (The setting screen appears.)

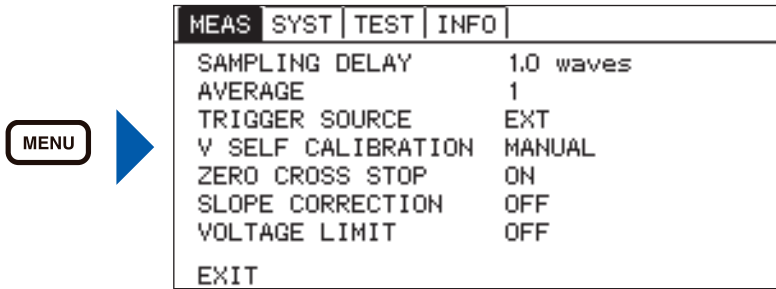

- 2 Select **[TEST]** tab.

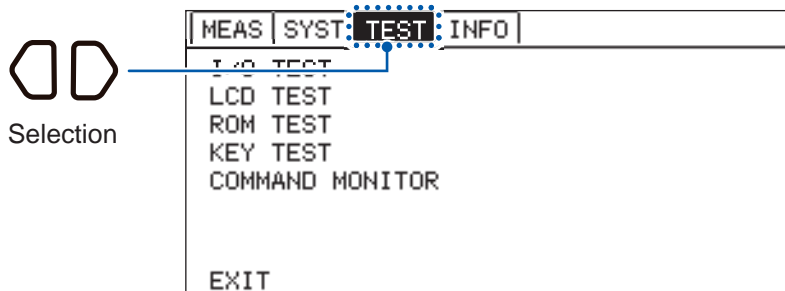

- 3 Select **[LCD TEST]**.

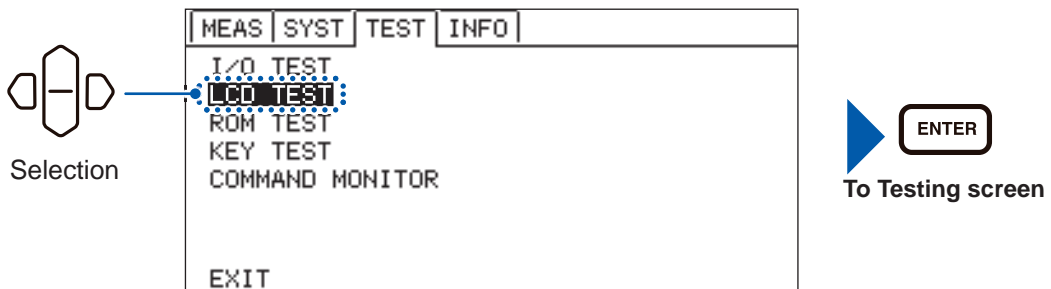

- 4 The explanation screen for test is displayed.

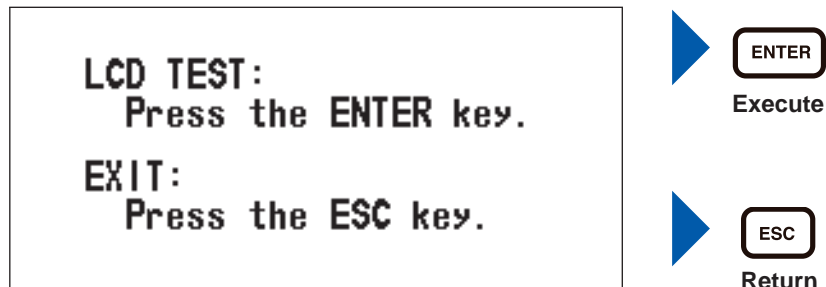

- 5 Press **ENTER**, and confirm that all screen indicators lights up and off repeatedly. (The display below shows that all screen indicators are lit up.)



ROM TEST

This test can check that the program data of the instrument is normal.

1 Press **MENU** (**MENU**). (The setting screen appears.)

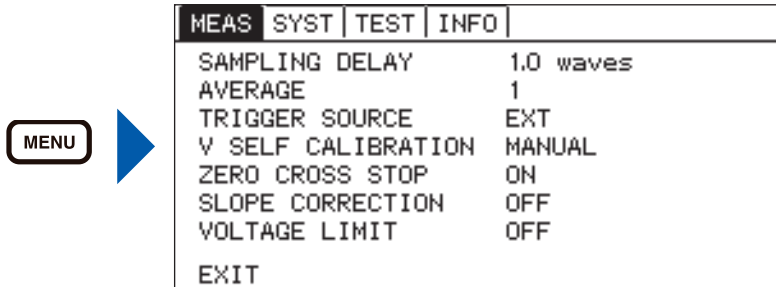

2 Select **[TEST]** tab.

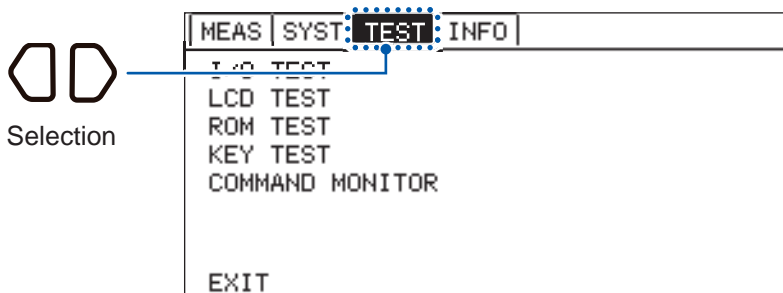

3 Select **[ROM TEST]**.

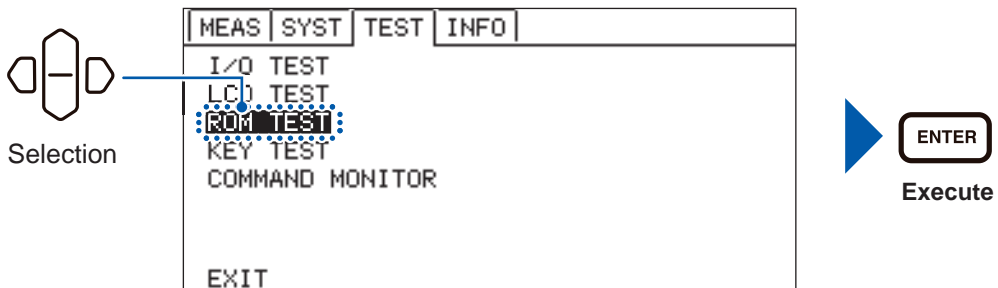

4 Test the ROM.

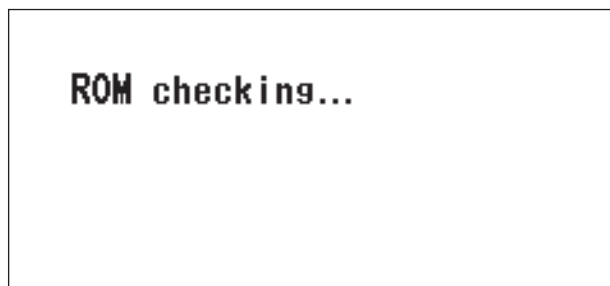

5 The screen returns to the ROM testing screen.



COMMAND MONITOR

Response of communications command and queries can be displayed on the screen.

1 Press **MENU** (**MENU**). (Settings screen is displayed.)

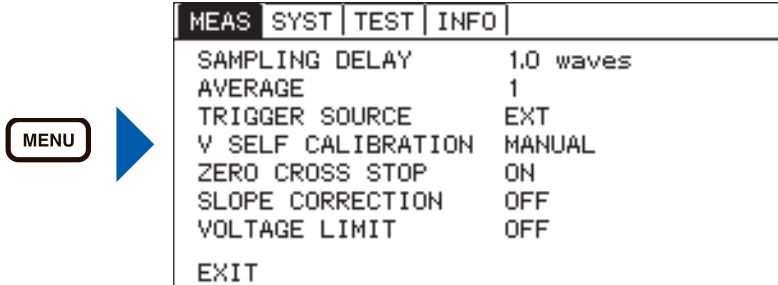

2 Select **TEST** tab.

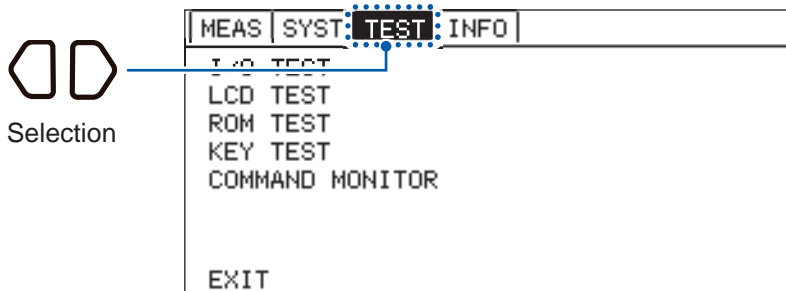

3 Select **COMMAND MONITOR**.

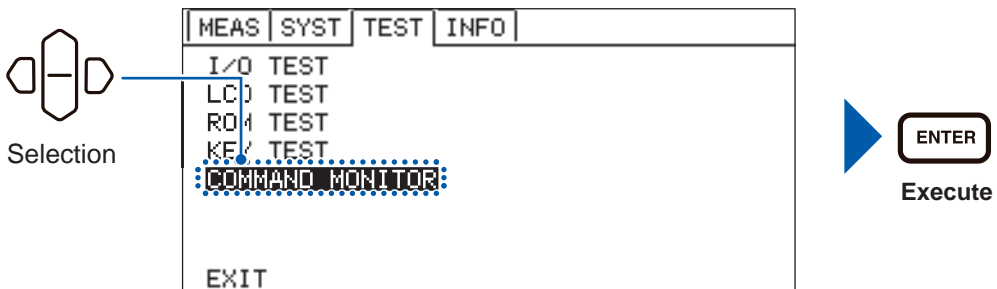

4 Confirm the contents of the communication commands.

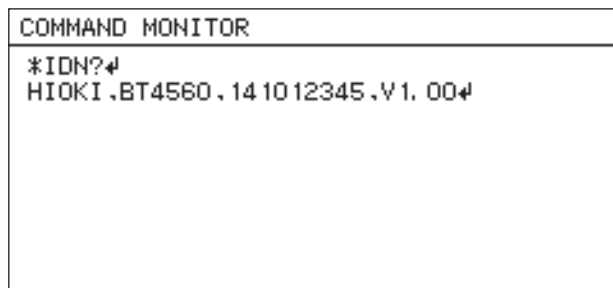

5 Press **LOCAL** (**LOCAL**). (Key operation is enabled.)

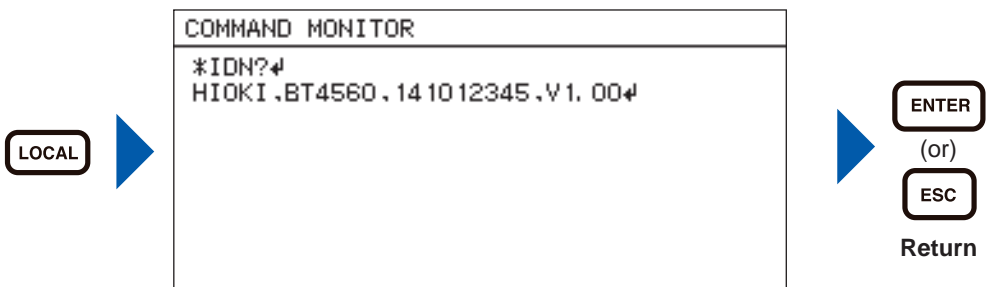

Scroll the screen if the confirmation screen becomes full.

- 1 Press **LOCAL** (**LOCAL**). (Key operation is enabled.)

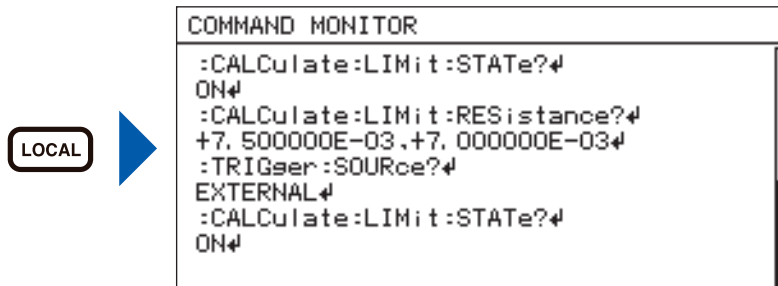

- 2 Scroll the screen.

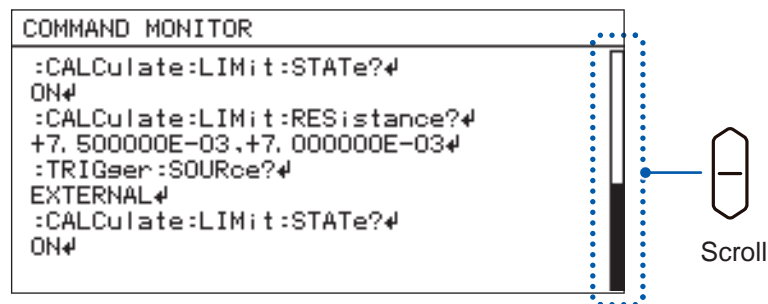

7.6 Confirm Instrument Information

The software version and serial number are displayed.

- 1 Press **MENU** (**MENU**). (Settings screen is displayed.)

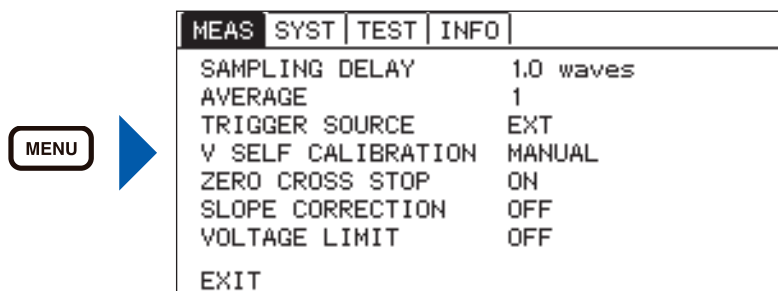

- 2 Select **INFO** tab. (The software version and serial number will be displayed.)

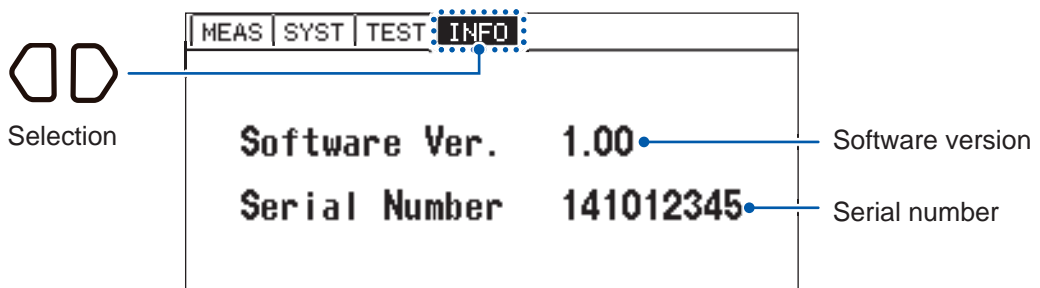

7.7 Initializing (Reset)

The reset function has two kinds of methods.

NORMAL	Initializing the settings to the factory default excluding the interface setting, zero adjustment values, and panel saving data.
SYSTEM	Initializing the settings to the factory default excluding the interface setting.

For details of resetting items, refer to “Initial setting table” (p. 76).

- 1 Press  (**MENU**). (The setting screen appears.)

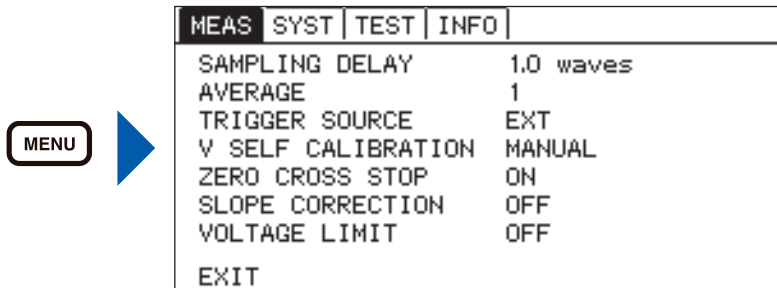

- 2 Select **[SYST]** tab.

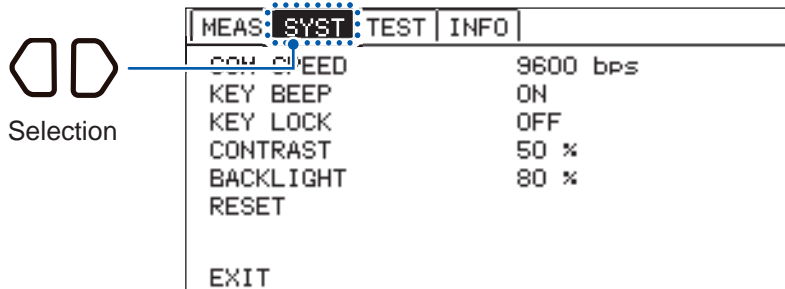

- 3 Select **[NORMAL]** or **[SYSTEM]**.

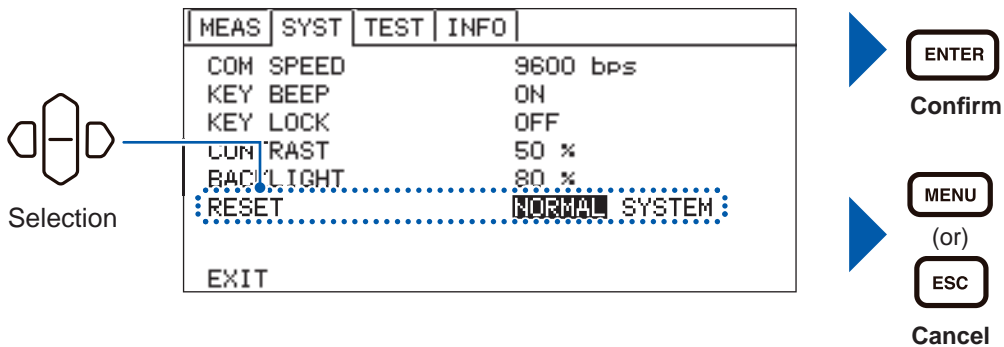

4 The confirmation window appears.

OK : Executes reset.

CANCEL : Returns to the measurement screen without execution.

When NORMAL is selected

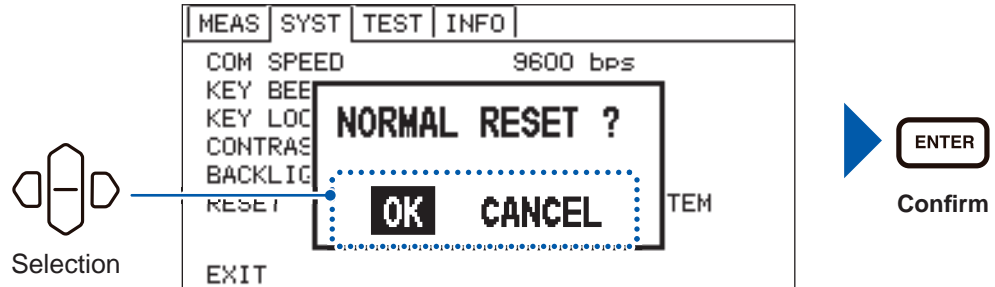

When SYSTEM is selected

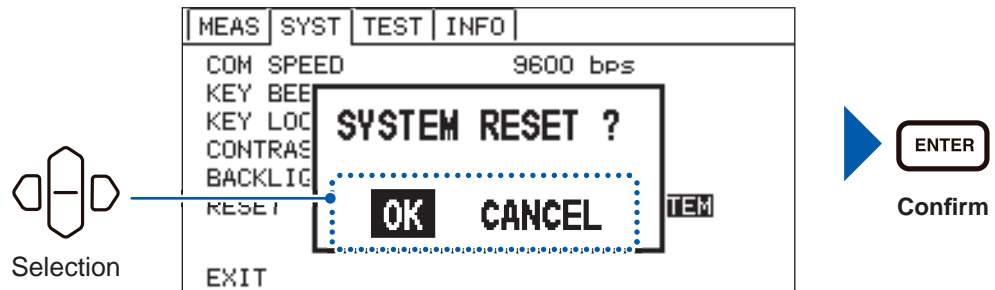

5 The display returns to the measurement screen after the reset process is completed.

Initial setting table

Item		Default setting	Initialization by normal reset (Communication: *RST)	Initialization by system reset (Communication: SYSTem:RESet)	Returns to default when the power supply is turned ON	Panel Save/Load
Range		10 mΩ				
Measurement frequency		1000 Hz				
Measurement speed	Voltage measurement	MED				
	Impedance measurement	MED				
Function		(R,X,V,T)				
Trigger source		EXT				
Comparator	ON/OFF	OFF	✓			
	Judgment buzzer beep	OFF				
	Voltage absolute value judgment	OFF				
	Upper limit value of R	OFF				
	Lower limit value of R	OFF				
	Upper limit value of X	OFF				
	Lower limit value of X	OFF				
	Upper limit value of Z	OFF				
	Lower limit value of Z	OFF				
	Upper limit value of θ	OFF			✓	-
	Lower limit value of θ	OFF				
	Upper limit value of V	OFF				
	Lower limit value of V	OFF				
Zero Adjustment	Correction mode	OFF	-			
	R Corrected value	0.0 mΩ				
	X Corrected value	0.0 mΩ				
	V Corrected value	0.0V				
Self-Calibration		AUTO				
Sample delay	Delay mode	WAVE	✓			
	Delay time	1.0 wave				
	Acceptable range of deviation	10 μV				
Average		1				
Measurement signal zero cross stop		ON				
Slope Correction		ON				
Voltage limit	ON/OFF	OFF				
	Acceptable range	4.2 V				

Item		Default setting	Initialization by normal reset (Communication: *RST)	Initialization by system reset (Communication: SYSTem:RESet)	Returns to default when the power supply is turned ON	Panel Save/Load
Screen contrast		50%	✓	✓	-	-
Screen brightness		80%			-	
Key-lock		OFF			✓	
Key operation buzzer		ON			-	
Panel save		Not registered	-		-	✓
Interface	Continuous measurement (:INITiate:CONTInuous)	ON	✓	✓	✓	-
	Response format for measurement value (:MEASure:VALid)	1 (Response for measurement value only)			-	
	Communication speed	9,600 bps	-	-	✓	
	Header	OFF				
	Status byte register	0				
	Event register	0				
	Enable register	0				

✓: Applicable, -: Not applicable

Initializing (Reset)

8

External Control (EXT.I/O)

Using the EXT.I/O terminals on the rear of the instrument, the instrument can be controlled by external devices such as PLC.

The instrument can also be controlled by outputting the measurement ending signal and the judgment result signal, and by inputting the measurement starting signal by using the EXT.I/O connector on the rear. All of the signals are isolated from the measurement circuit and the ground. (The common terminals for input and output are shared.) The input circuit can be switched so as to correspond to the current sink output (NPN) or the current source output (PNP).

To use the instrument properly, confirm input/output ratings and the internal circuit configuration, and understand the safety precautions before connecting to a control system.

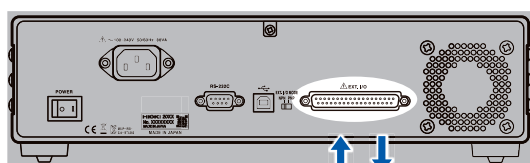

Signal input/output

Check the specifications of the controller's input/output.



Set the NPN/PNP switches of the instrument (p. 80).



Connect between the EXT.I/O connector of the instrument and the controller (p. 80).



Configure the instrument settings.

8.1 External Input/output Terminals and Signals

Switching the current sink (NPN) /the current source (PNP)

Before switching, be sure to read “Before switching the current sink (NPN) and the current source (PNP)” (p. 10).

The type of the PLC (programmable controller) that can be supported is changed by the NPN/PNP switch. The factory default is set to the NPN.

	NPN/PNP switch setting	
	NPN	PNP
BT4560 input circuit	Corresponding to sink output	Corresponding to source output
BT4560 output circuit	non-polarity	non-polarity
ISO_5V output	+5 V output	-5 V output

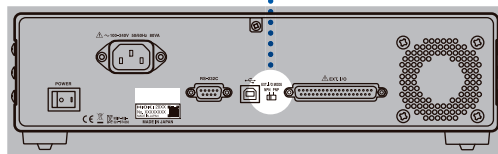
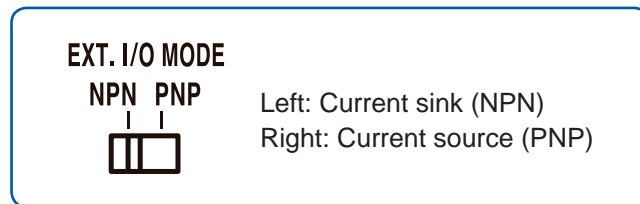

Arranging the usage connector and the signals

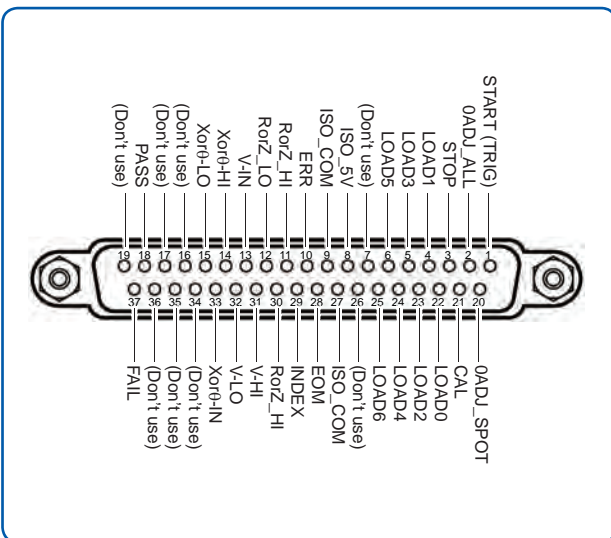

Usage connector

- 37-pin D-sub socket contact with #4-40 inch screws

Mating Connectors

- DC-37P-U/LR (solder type)
 - DCSP-JB37PR (compression contact type)
- Manufactured by Japan Aviation Electronics Industry, Ltd.
 Other comparable products

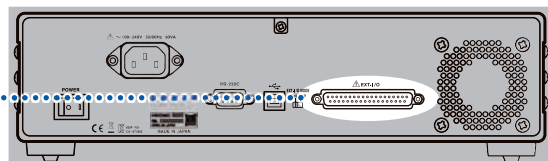

Pin	Signal name	I/O	Function	Logic
1	START (TRIG)	IN	Starting the measurement (external trigger)	Edge
2	0ADJ_ALL	IN	All zero adjustment	Edge
3	STOP	IN	Stopping the measurement	Edge
4	LOAD1	IN	Loading number Bit 1	Level
5	LOAD3	IN	Loading number Bit 3	Level
6	LOAD5	IN	Loading number Bit 5	Level
7	(Don't use)	-	-	-
8	ISO_5V	-	Isolated power supply +5 V (-5 V) output	-
9	ISO_COM	-	Isolated power supply common	-
10	ERR	OUT	Measurement Error	Level
11	RorZ_HI	OUT	Resistance judgment result Hi, Impedance judgment result Hi	Level
12	RorZ_LO	OUT	Resistance judgment result Lo, Impedance judgment result Lo	Level
13	V_IN	OUT	Judgment result IN	Level
14	Xor θ _HI	OUT	Reactance judgment result Hi, Phase angle judgment result Hi	Level
15	Xor θ _LO	OUT	Reactance judgment result Lo, Phase angle judgment result Lo	Level
16	(Don't use)	-	-	-
17	(Don't use)	-	-	-
18	PASS	OUT	Judgment result PASS	Level
19	(Don't use)	-	-	-
20	0ADJ_SPOT	IN	Spot zero adjustment (SPOT)	Edge
21	CAL	IN	Performing Self-Calibration	Edge
22	LOAD0	IN	Loading number Bit 0	Level
23	LOAD2	IN	Loading number Bit 2	Level
24	LOAD4	IN	Loading number Bit 4	Level
25	LOAD6	IN	Loading number Bit 6	Level
26	(Don't use)	-	-	-
27	ISO_COM	-	Isolated power supply common	-
28	EOM	OUT	End of measurement	Edge
29	INDEX	OUT	Measurement reference number	Level
30	RorZ_HI	OUT	Resistance judgment result IN, Impedance judgment result IN	Level
31	V_HI	OUT	Voltage judgment result Hi	Level
32	V_LO	OUT	Voltage judgment result Lo	Level
33	Xor θ _IN	OUT	Reactance judgment result IN, Phase angle judgment result IN	Level
34	(Don't use)	-	-	-
35	(Don't use)	-	-	-
36	(Don't use)	-	-	-
37	FAIL	OUT	Judgment result FAIL	Level

IMPORTANT

The connector shell is conductively connected to the metal instrument chassis and the protective earth pin of the power inlet. Be aware that it is not isolated from ground.

Functions of each signal

Input signal

START (TRIG)	When START (TRIG) signal is switched from OFF to ON, measurement is performed once on the edge. This is only effective when TRIGGER SOURCE is set to the external [EXT] side.
0ADJ_ALL	When the 0ADJ_ALL signal is switched from OFF to ON, all zero adjustment (p. 26) is performed once on the edge.
STOP	When the STOP signal is switched from OFF to ON, the measurement is interrupted on the edge.
0ADJ_SPOT	When the 0ADJ_ALL signal is switched from OFF to ON, spot zero adjustment (p. 26) is performed on the edge.
CAL	When the CAL signal is switched from OFF to ON in the self-calibration manual setting, the self-calibration is started on the edge. When self-calibration is set to auto, the above is ineffective. Self-calibration takes approximately 210 ms. When a switch is input during measurement, self-calibration is performed after the measurement.
LOAD0 to LOAD6	When the number of the panel to load is selected and the TRIG signal is input, the selected panel number is read and measured. LOAD0 is LSB and LOAD6 is MSB. When the TRIG signal is input, if LOAD0 to LOAD6 are the same as the previous ones, the panel load is not performed. In the above case, when the external trigger is used, the measurement is performed once as a normal TRIG signal. When the internal trigger is used, the input of LOAD0 to LOAD6 is ineffective.

Panel No.	LOAD6	LOAD5	LOAD4	LOAD3	LOAD2	LOAD1	LOAD0
*	OFF	OFF	OFF	OFF	OFF	OFF	OFF
1	OFF	OFF	OFF	OFF	OFF	OFF	ON
2	OFF	OFF	OFF	OFF	OFF	ON	OFF
3	OFF	OFF	OFF	OFF	OFF	ON	ON
4	OFF	OFF	OFF	OFF	ON	OFF	OFF
5	OFF	OFF	OFF	OFF	ON	OFF	ON
6	OFF	OFF	OFF	OFF	ON	ON	OFF
7	OFF	OFF	OFF	OFF	ON	ON	ON
8	OFF	OFF	OFF	ON	OFF	OFF	OFF
.....							
122	ON	ON	ON	ON	OFF	ON	OFF
123	ON	ON	ON	ON	OFF	ON	ON
124	ON	ON	ON	ON	ON	OFF	OFF
125	ON	ON	ON	ON	ON	OFF	ON
126	ON	ON	ON	ON	ON	ON	OFF
*	ON	ON	ON	ON	ON	ON	ON

* When turning all of the LOAD0 to LOAD6 to ON or OFF and then the START (TRIG) signal to ON, the panel loading is not performed.

- In the case of setting to the external trigger, the measurement is performed once after the completion of the loading.
- In the case of setting to the internal trigger, panel loading will not be performed.

Output signal

ERR	When a measurement error (p. 30) occurs, the output changes to ON. (In the case of the overrange, the output is OFF.) ERR is updated just before the EOM signal. When ERR is ON, all of the comparator judgment outputs become OFF. In the case of a measurement error: ERR output changes to ON In the case of a normal measurement: ERR output changes to OFF
PASS	When the results of the measurement parameters being judged are all IN, the PASS is ON. Example 1: When the functions (R, X, V, T) are set, if all of the measurement results of R, X, V are IN, the PASS is ON. Example 2: When the functions (V, T) are set, if the measurement result of V is IN, the PASS is ON.
EOM	EOM is end of measurement. When EOM changes to ON, the judgment result of the comparator and the ERR output have been determined.
INDEX	INDEX indicates that the A/D conversion has ended in the measurement circuit. When the signal changes from OFF to ON, the object being measured can be removed from the probe.
FAIL	It will be ON when the judgment results of comparator are Hi or Lo.
RorZ_HI	The RorZ_HI is the judgment result of the comparator for resistance or impedance.
RorZ_IN, RorZ_LO	The RorZ_IN and RorZ_LO are the judgment results of the comparator for resistance or impedance.
V_HI, V_IN, V_LO	They are the judgment results of the comparator for voltage.
Xor θ _HI, Xor θ _IN, Xor θ _LO	They are the judgment results of the comparator for reactant or a phase angle.

IMPORTANT

- The I/O signals cannot be used during changing the measurement conditions in the instrument.
- When the power supply is turned on, the EOM signal and the INDEX signal are initialized to ON.
- When it is not necessary to switch the measurement conditions, fix all of LOAD0 to LOAD6 at ON or OFF.
- To avoid misjudgment, check with both the PASS and FAIL signals for the judgment to the comparator.

8.2 Timing Chart

The levels of each signal indicate the ON/OFF status of the contacts. In the case of the current source (PNP) setting, the signal levels are the same as the voltage level of the EXT.I/O terminals. In the case of the current sink (NPN) setting, the High and Low voltage levels are reversed.

Acquiring the judgment results after starting measurement

(1) When the external trigger [EXT] is set

In the case of measurement functions (R, X, V, T), (Z, θ , V, T)

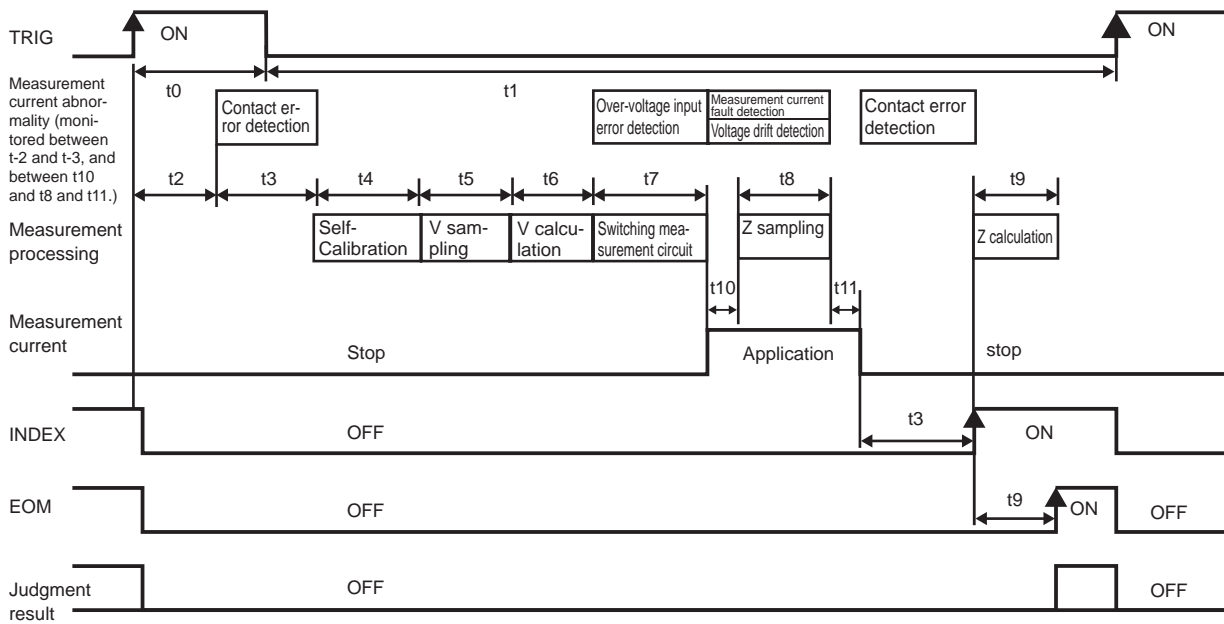

Judgment results: HI, IN, LO, PASS, FAIL, ERR

In the case of measurement functions (R, X, T), (Z, θ , T)

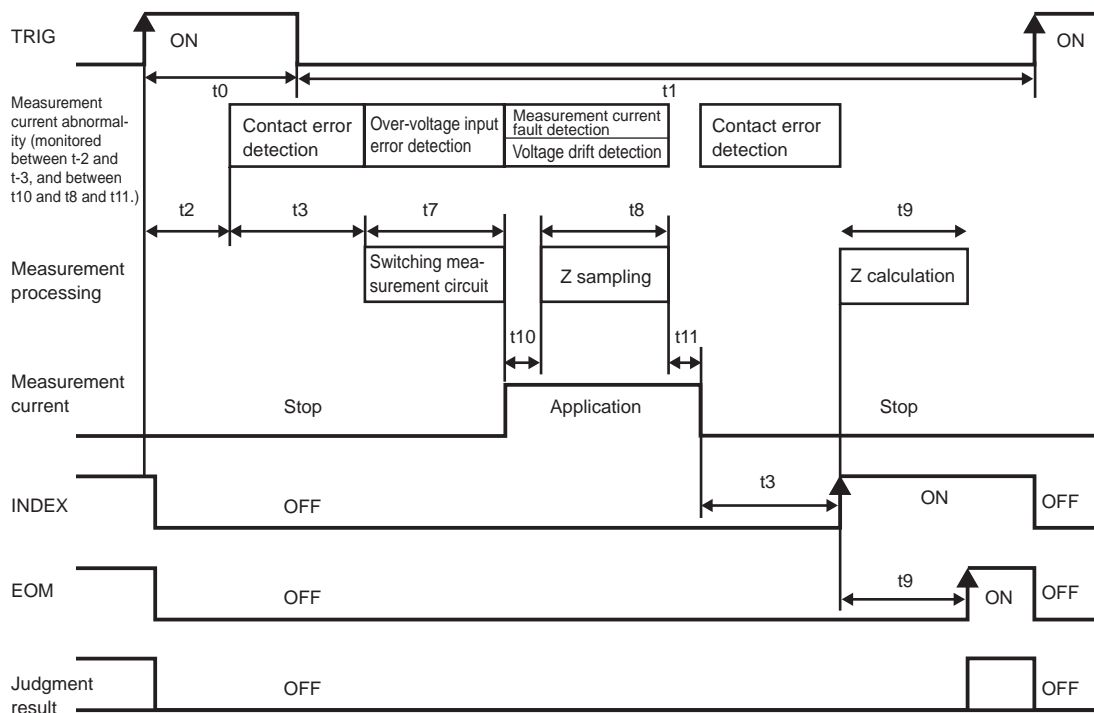

In the case of measurement functions (V, T)

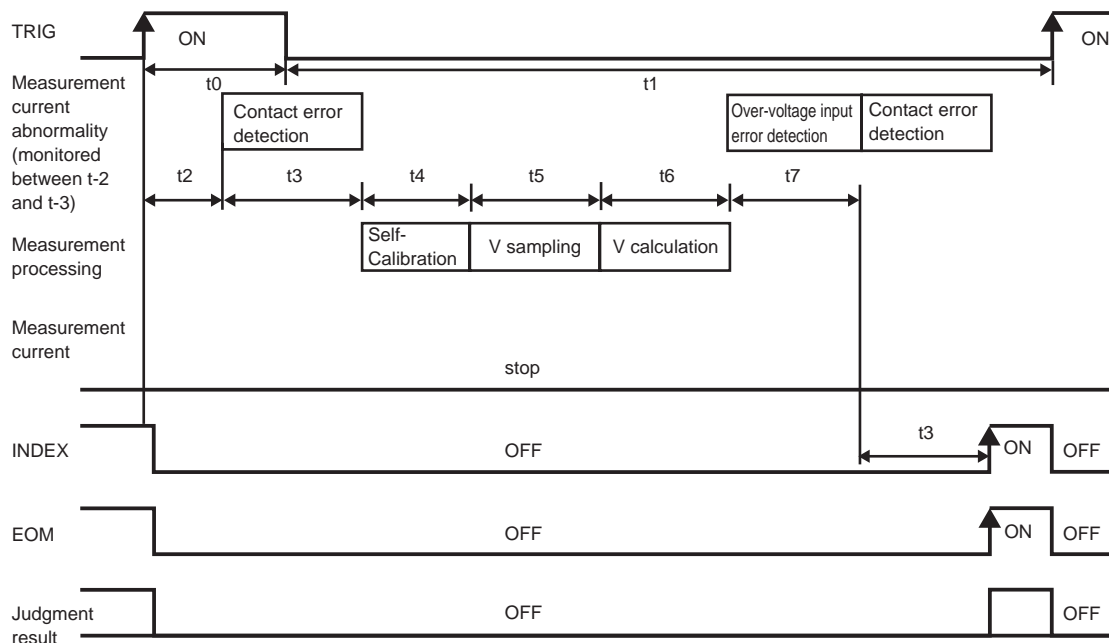

- Do not input TRIG signal when measurement (INDEX signal is OFF) is in progress.
- When settings such as measurement frequency are changed, input the TRIG signal after the processing time (approx. 15 ms).
- The input signal is disabled when the measurement screen is not open, or when an error message is displayed.
- The output of the judgment result is determined before the EOM signal becomes ON. When the response of the controller input circuit is slow, a wait is required from when the EOM signal ON is detected until the judgment results are read.

(2) When the internal trigger [INT] is set

In the case of measurement functions (R, X, V, T), (Z, θ , V, T), (R, X, T), (Z, θ , T)

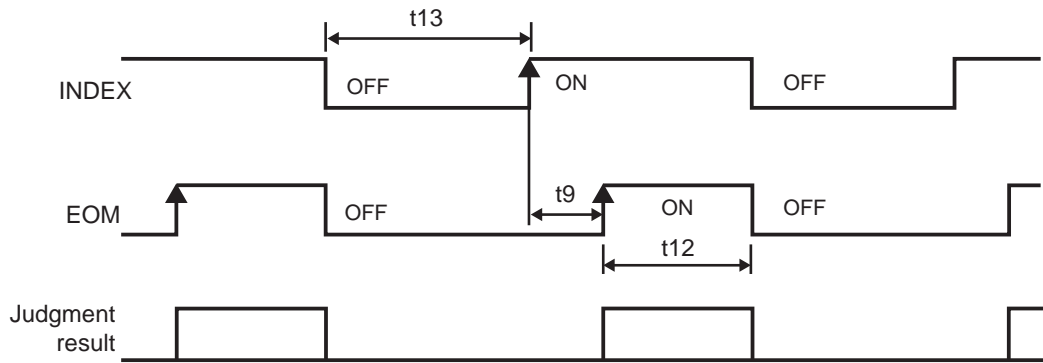

Judgment results: HI, IN, LO, PASS, FAIL, ERR

In the case of measurement functions (V, T)

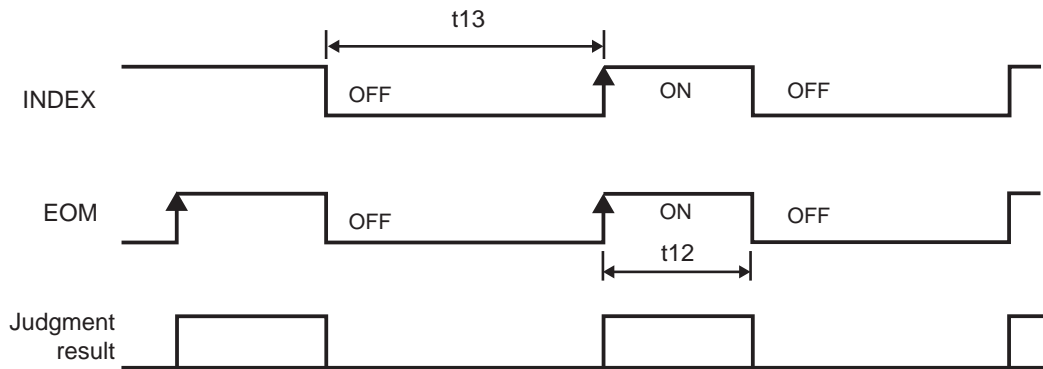

Timing chart interval descriptions

Item	Contents	Time (approximately)	Remarks
t0	Trigger pulse ON-time	0.1 ms or more	
t1	Trigger pulse OFF-time	1 ms or more	
t2	Response time	0.1 ms	
t3	Contact check time	10 ms	
t4	Self-Calibration time	210 ms	When self-calibration is set to AUTO, self-calibration is performed. In the case of the MANUAL setting, if the CAL signal is input, self-calibration is performed. For details, refer to p. 41.
t5	Voltage measurement sampling time	100 ms/400 ms/ 1 s	Measurement speed: FAST/MED/SLOW
t6	Voltage measurement calculation time	0.1 ms	
t7	Switching time of measurement circuit	58 ms	
t8	Impedance measurement sampling time	$(1 \div f) \times N + T + 0.016^*$	f: Measurement frequency, N: measurement wave number, T: Control time for sampling. The measurement wave number is determined by the measurement speed and the average number. For details, refer to p. 24, p. 42, and p. 102. Sampling control time differs due to the frequency. T=0.088 ÷ f (f: 0.1 Hz to 66 Hz) T=0.36 ÷ f (f: 67 Hz to 250 Hz) T=1.5 ÷ f (f: 260 Hz to 1050 Hz)

Item	Contents	Time (approximately)	Remarks
t9	Calculation time in impedance measurement	70 ms	Measurement frequency: 1 kHz, Z measurement speed: SLOW, Slope correction: representative value of ON
t10	Sample delay	$(1 \div f) \times M^* + 0.005$ s	f: Measurement frequency, M: Sample delay setting wave number For the setting wave number, refer to (p. 38).
t11	Measurement signal zero-cross detection	$(1 \div f)$ or less*	f: Measurement frequency To prevent charging and discharging the measuring object, the applied AC signal is processed to end at zero cross. It will be applied if the measurement signal zero cross stop function is ON. (p. 47)
t12	EOM pulse width in the internal trigger	100 ms	
t13	Total measurement time	$t2+t3 \times 2+t4+t5+t6+t7+t8+t9+t10+t11$	In the case of the functions (Z,θ,V,T) or (R,X,V,T)
		$t2+t3 \times 2+t7+t8+t9+t10+t11$	In the case of functions (Z,θ,T) or (R,X,T)
		$t2+t3 \times 2+t4+t5+t6+t7$	In the case of the functions (V,T)

* Unit is "s".

Timing of the zero adjustment

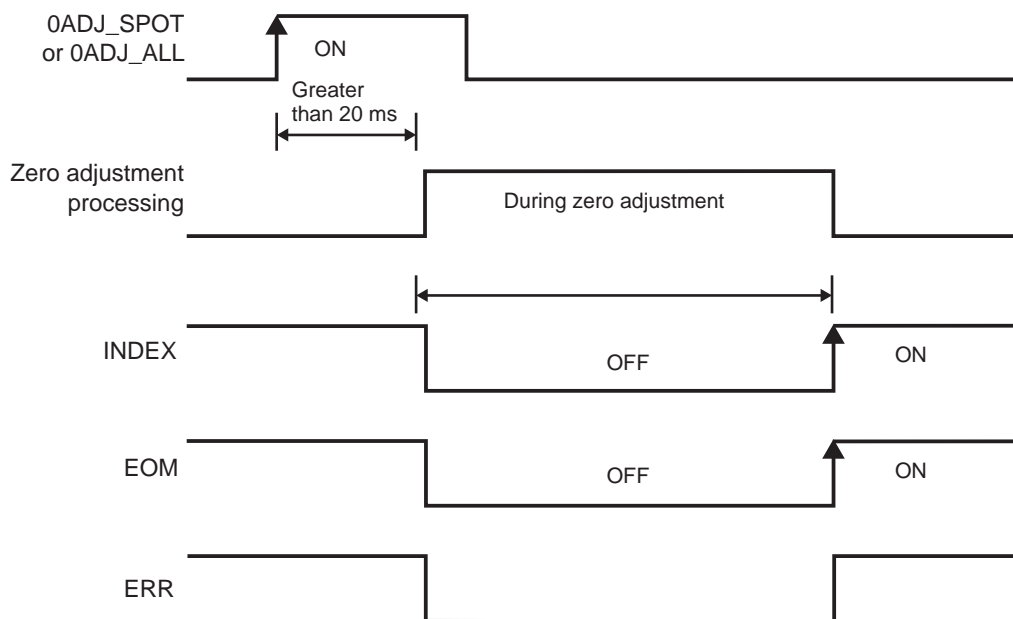

The ERR signal becomes ON or OFF dependent on the result of the zero adjustment. When the zero adjustment is performed normally, the ERR is OFF. When it is not performed normally, the ERR is ON synchronously with the EOM.

IMPORTANT

For signals 0ADJ_SPOT and 0ADJ_ALL, input when it is not in measurement state.

Timing of the self-calibration

When the self-calibration setting is **[AUTO]**, the self-calibration always is performed before the voltage measurement. The self-calibration is performed to maintain the accuracy of the voltage calibration. In the case of the measurement functions (R, X, T) and (Z, θ, T) where the voltage measurement is not performed, the self-calibration is not performed. (Even if the CAL signal is input, the self-calibration is not performed.)

Operation when the self-calibration setting is [MANUAL]

The CAL signal is input, and the self-calibration is started immediately. Even if the TRIG signal is input during the self-calibration, the self-calibration is continued. In this case, the trigger signal is held and then the measurement is started after the completion of the self-calibration. When the CAL signal is input during the measurement, the CAL signal is held and then the self-calibration is started after the completion of the measurement.

Normal usage

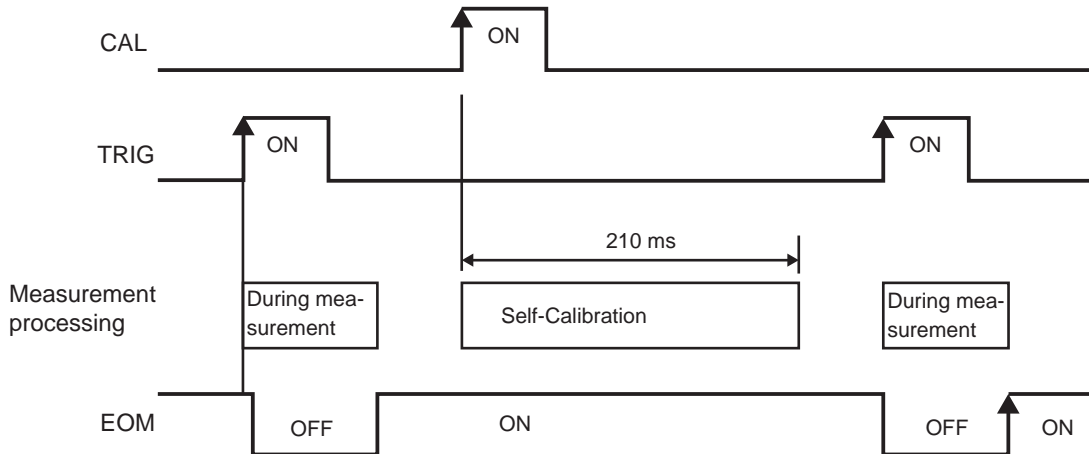

When the TRIG signal is input during the self-calibration

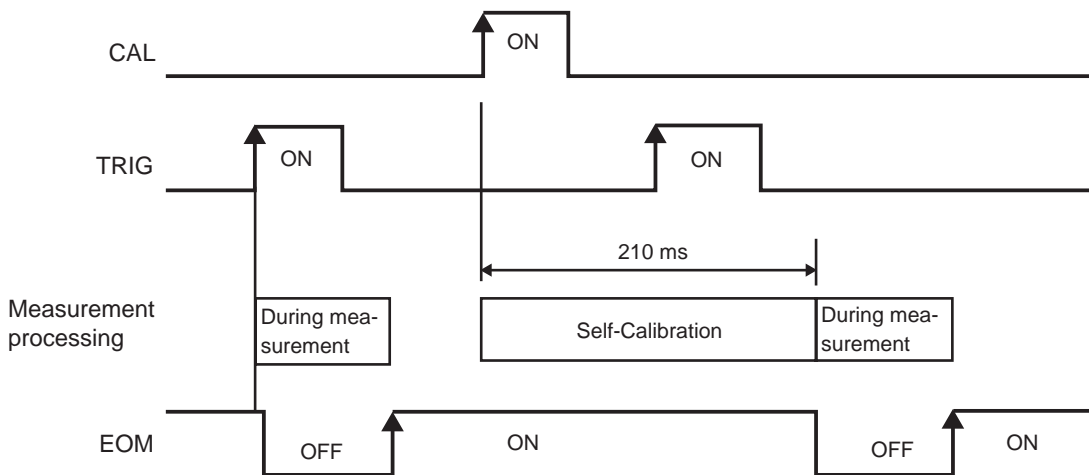

When the CAL signal is input during the measurement

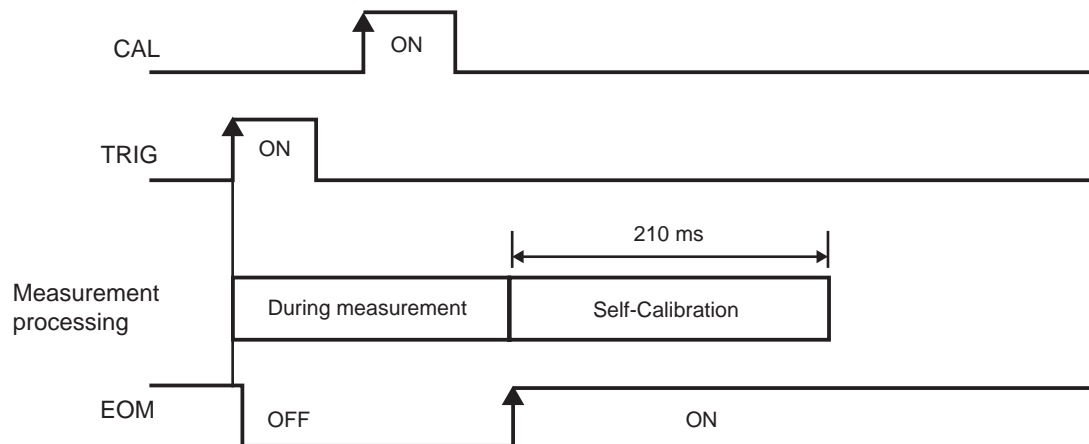

Timing of the panel loading

When the TRIG signal is used

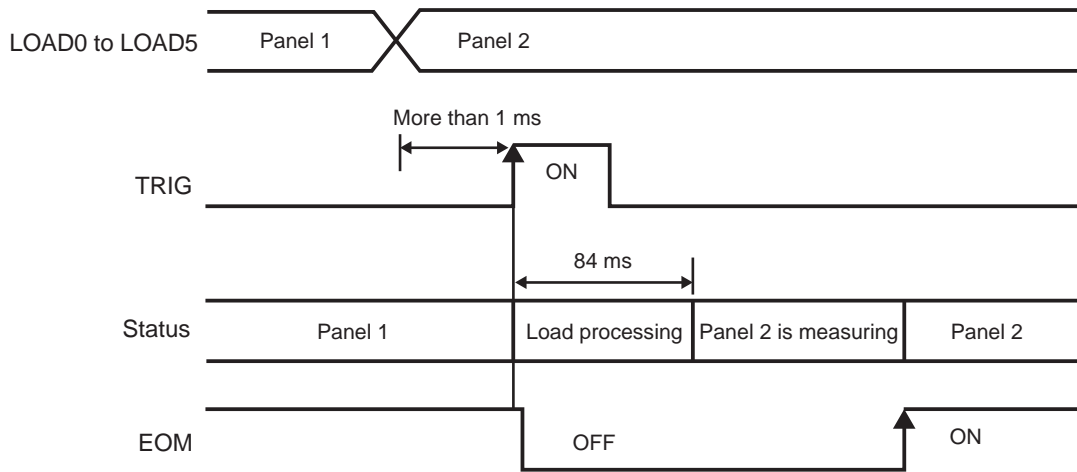

IMPORTANT

The timing to identify the panel number is not when trigger is input (TRIG:ON), but when it reads the LOAD signal right before the measurement starts. Fix the LOAD signal before the measurement (INDEX:OFF, EOM:OFF) starts.

Output signal status when turning ON the power supply

After turning on the power supply, when the screen changes from the start-up screen to the measurement screen, the EOM signal and the INDEX signal changes to ON.

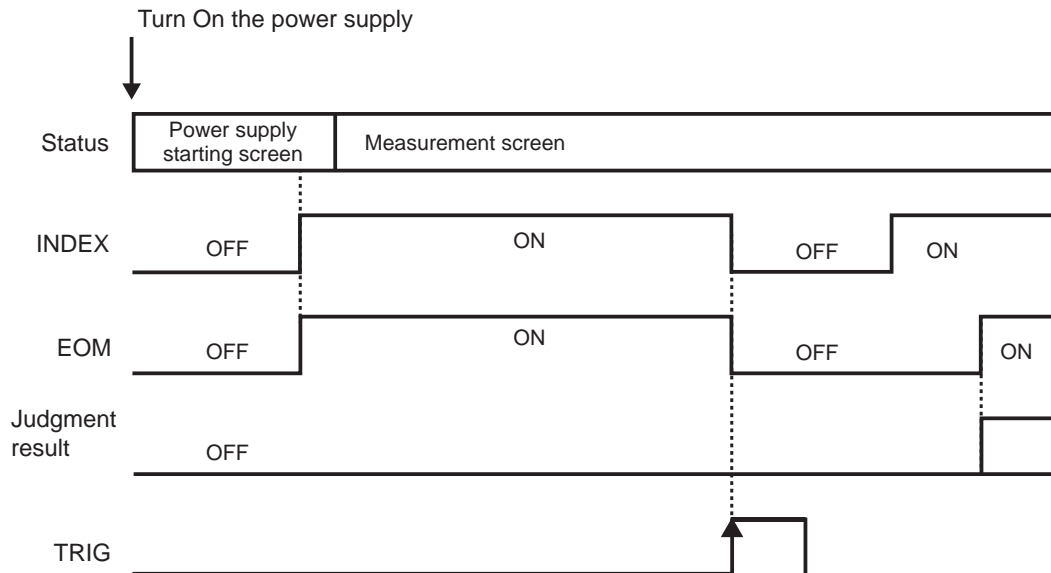

Judgment results: HI, IN, LO, PASS, FAIL, ERR

The above chart indicates the operation when the trigger source is set to the EXT.

Taking-in flow with the external trigger

With the external trigger, the diagram indicates the flow from the starting of the measurement to the taking-in of the judgment result or the measured values. The instrument outputs the EOM signal immediately after the judgment results (HI, IN, LO, PASS, FAIL, ERR) have been determined. When the response of the controller's input circuit is delayed, it takes a waiting time from the detection of the EOM signal's ON status to the taking-in of the judgment results.

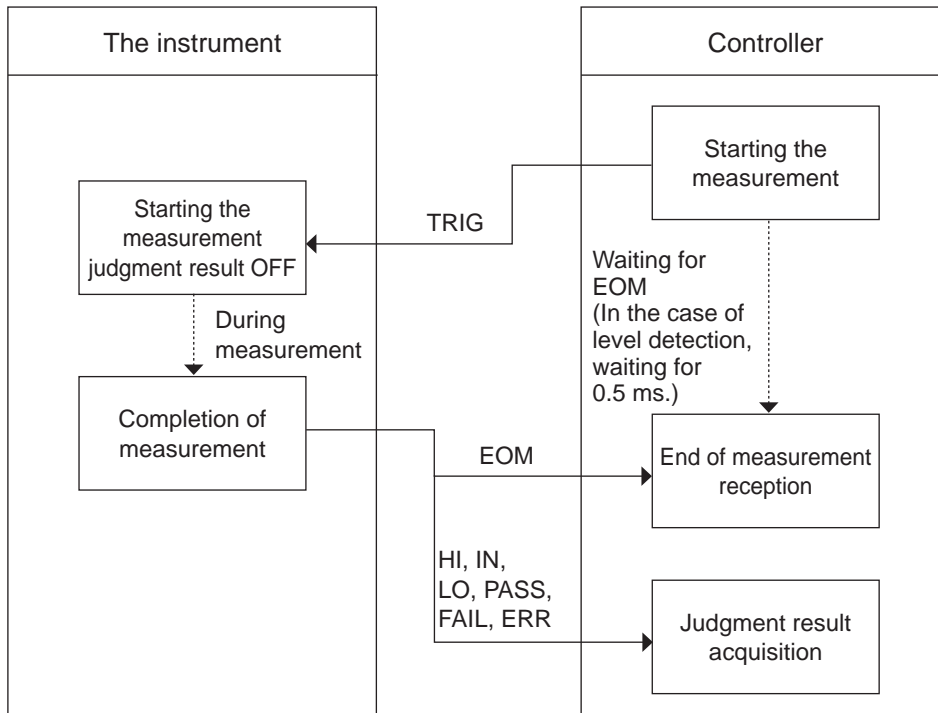

8.3 Internal Circuitry

NPN setting

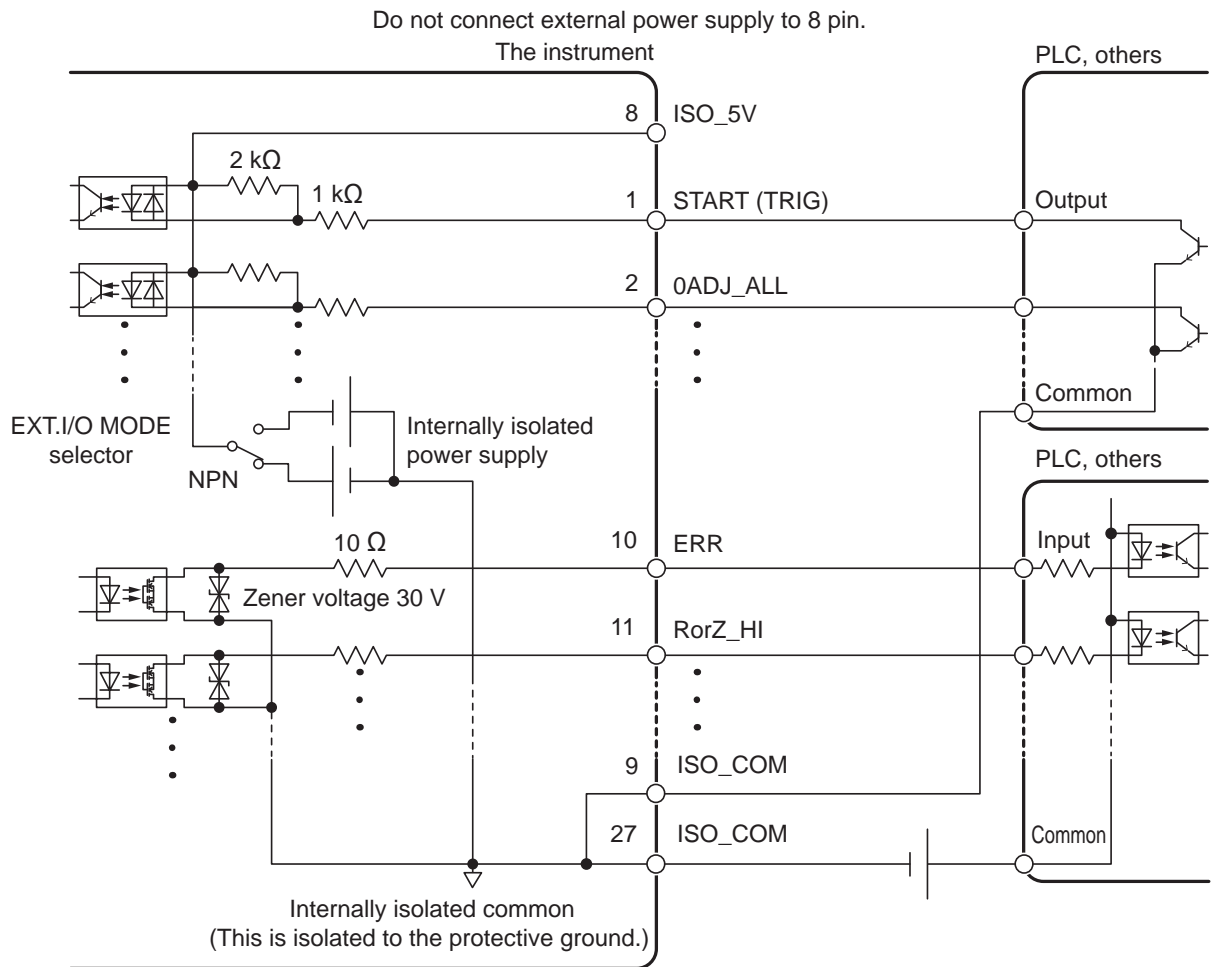

PNP setting

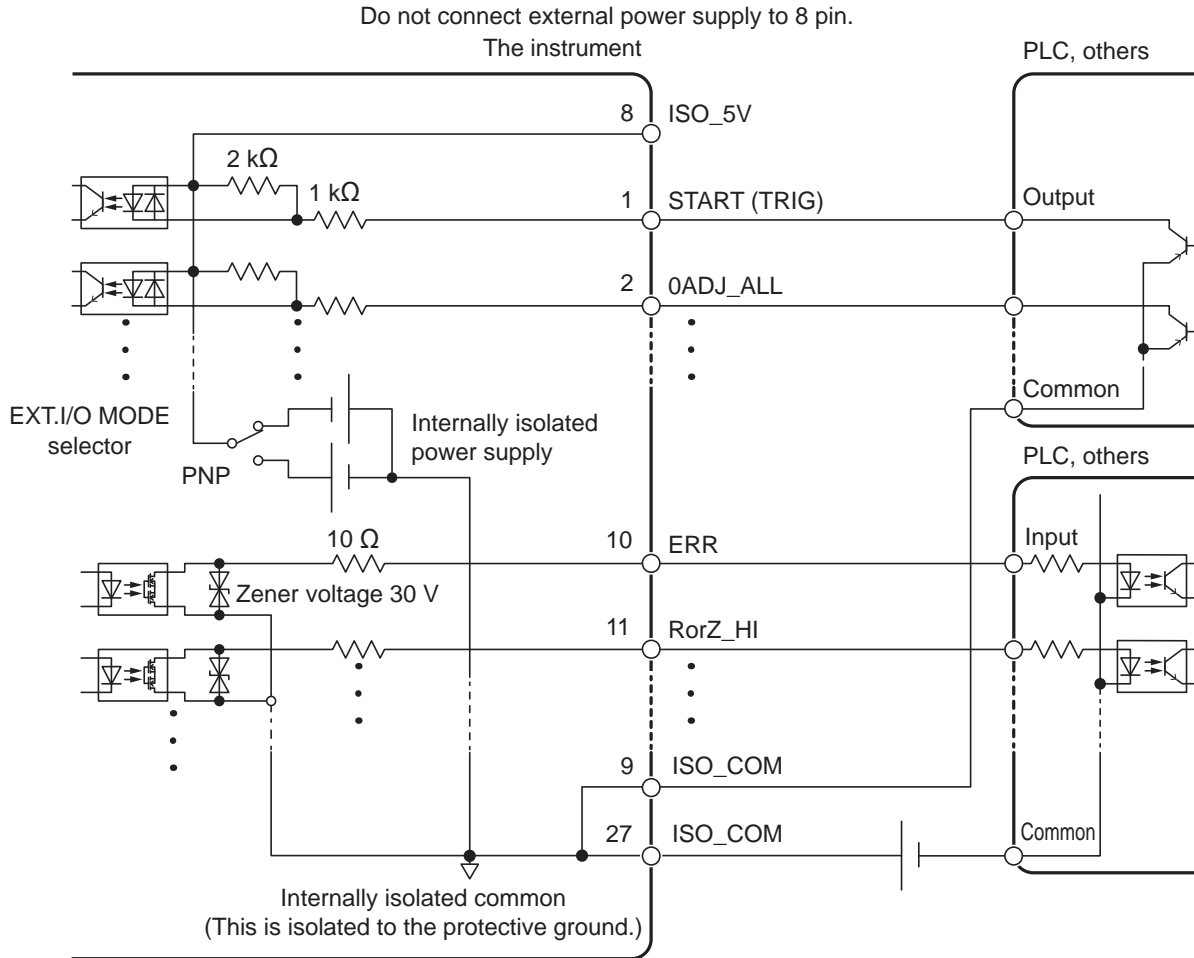

Share the ISO_COM for the common terminals of the input and the output signal.

Electrical Specifications

Input signal	Input type	Photo-coupler-isolated, non-voltage contact inputs (corresponding to current sink/source output)
	Input ON	Residual voltage 1 V (Input ON Current 4 mA (reference value))
	Input OFF	OPEN (Breaking current less than 100 μ A)
Output signal	Output type	Photo-coupler-isolated open drain output (non-polarity)
	Maximum load voltage	30 V max DC
	Maximum output current	50 mA/ch
	Residual voltage	Less than 1 V (Load current 50 mA)/less than 0.5 V (Load current 10 mA)
Internally isolated power supply	Output voltage	Corresponding to sink output: +5.0 V \pm 10%, Corresponding to source output: -5.0 V \pm 10%
	Maximum output current	100 mA
	External power input	None
	Insulation	Floating from the protective grounding potential and the measurement circuit
	Insulation rating	Voltage to ground 50 V DC, 33 V AC rms, less than 46.7 Vpeak AC

Examples of connection

Examples of input circuit connection

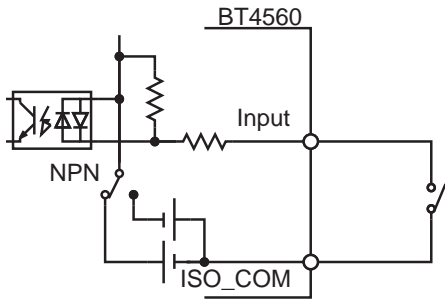

Connection to switch

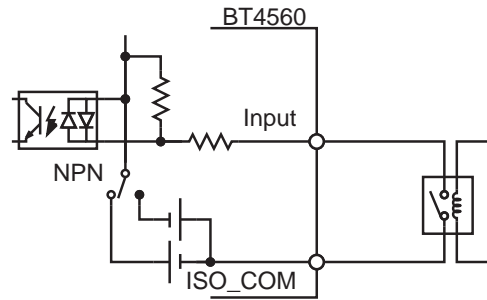

Connection to relay

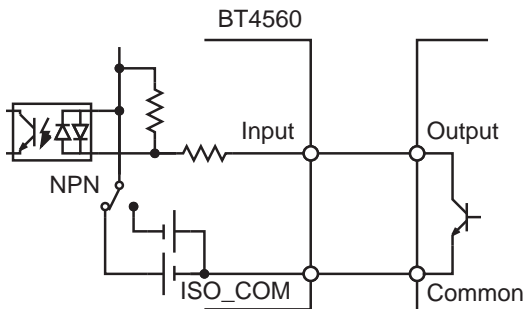

Connection to PLC output (NPN output)

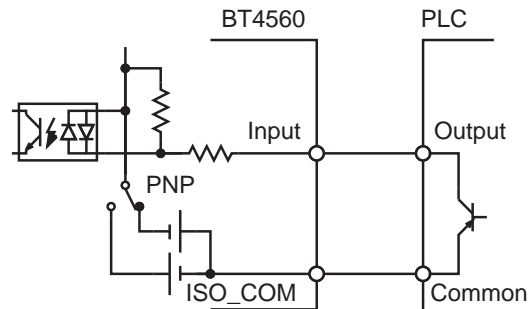

Connection to PLC output (PNP output)

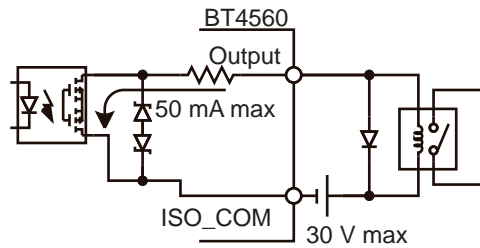

Connection to relay

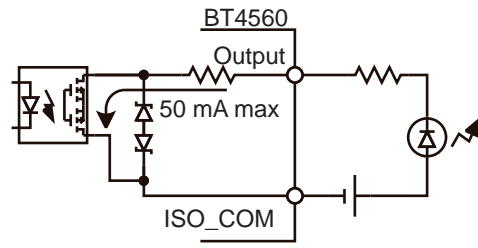

Connection to LED

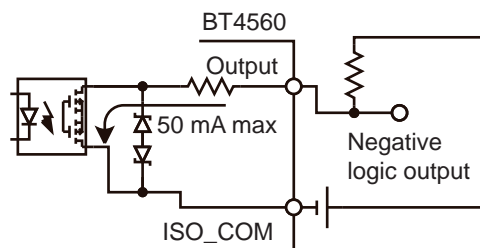

Negative logic output

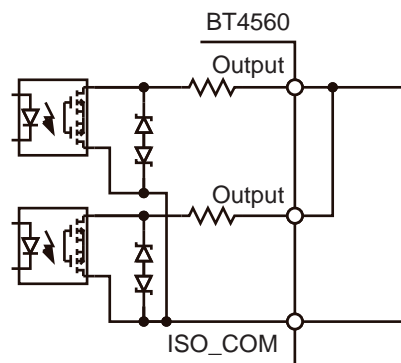

wired-OR

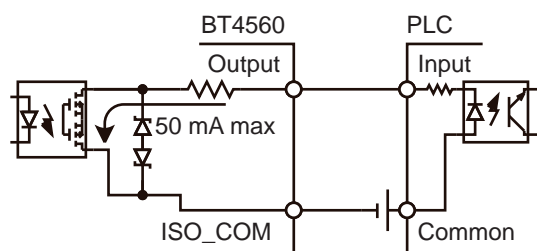

Connection to PLC input (plus common input)

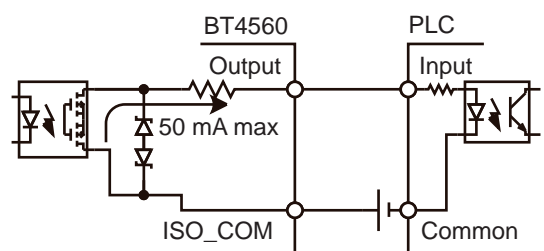

Connection to PLC input (minus common input)

8.4 Checking the External Control

Testing the inputs/outputs (EXT.I/O testing functions)

The output signal can be switched ON and OFF manually. In addition, the condition of the input signal can be monitored on the screen.

For details, refer to "I/O TEST" (p. 68).

9.1 Features of Interface

The communication interface can be used for the following.

- Controlling the instrument using commands and acquiring data.
- Using application software.

The command table and the application software can be downloaded from the attached CD or our website (<http://www.hioki.com/>).

Specifications

USB

Connector	Series B receptacle
Electrical Specifications	USB2.0 (pseudo COM port)
Class	CDC class (COM mode)
Transmission speed	9,600 bps, 19,200 bps, 38,400 bps
Data length	8 bit
Parity bit	None
Stop bit	1 bit
Message terminator (Delimiter)	When received: CR+LF, CR When transmitting: CR+LF

RS-232C

Transmission method	Communication method: Full duplex, Synchronous system: Asynchronous communication method
Transmission speed	9,600 bps, 19,200 bps, 38,400 bps
Data length	8 bit
Parity bit	None
Stop bit	1 bit
Message terminator (Delimiter)	When receiving: CR+LF, CR When transmitting: CR+LF
Flow control	None
Electrical Specifications	Input voltage levels: 5 V to 15 V: ON, -15 V to -5 V: OFF
	Output voltage levels: 5 V to 9 V: ON, -9 V to -5 V: OFF
Connector	Layout of interface connector (D-sub9 pin, pin contact, mating fixed base screw #4-40)
	The input/output connectors follow terminal (DTE) specifications.
	Recommended cable: 9637 RS-232C cable (for computer)

Code in use: ASCII code

9.2 Connecting and Setting Method

The instrument cannot control both the USB and the RS-232C communication simultaneously. When both USB and RS-232C communication are connected, the USB connection is effective.

Using the USB interface

When the instrument is first connected to a computer, it is necessary to prepare the dedicated USB driver. If the driver has already been installed, for example, due to using products from other manufacturers, the following procedure is not necessary. The USB driver can be downloaded from the attached CD or our website (<http://www.hioki.com/>).

Installation procedure

Perform the installation before connecting between the instrument and the computer with the USB cable. If they are already connected, unplug the USB cable.

- 1 Log into the computer with administrative privileges such as “administrator”.
- 2 Before installation, exit all applications that are running on the computer.
- 3 Run the driver installation program of the CD [X:\USB Driver] provided. (X: is CD-ROM Drive)
It may take some time until the dialog box appears, depending on the system environment.
Wait for the dialog box.
- 4 After installation, when the instrument is connected to the computer via USB, the instrument is automatically recognized.
 - When the Hardware Wizard screen for new hardware appears, select “No, not this time” when “Windows Update” prompts to connect, and then select “Install the software automatically”.
 - If an instrument with a different serial no. is connected, you may be notified that a new device has been detected. If this happens, install the device driver by following the instructions on the screen.

Uninstallation procedure (Uninstall the driver if you no longer need it.)

Using [Control Panel] - [Add or Remove Programs], delete PL-2303 USB-to-Serial.

Connect the USB cable

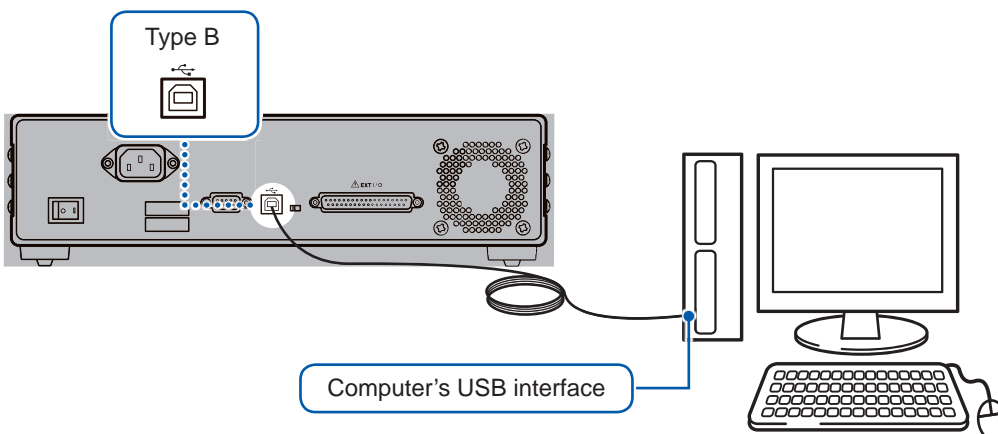

IMPORTANT

The instrument's USB port is a pseudo COM port. In the case of the communication, it is necessary to set the speed as well as the RS-232C. In the COM port setting, the COM port number that is allocated to the USB port varies with the computer in use.

Check the COM port number that is allocated by the following method.

1. Open the device manager.
 - In the case of Windows Vista
[Start] - [Control Panel] - [Hardware and Sound] - [Device Manager]
 - In the case of Windows 7
[Start] - [Control Panel] - [System and Security] - [Device Manager]
 - In the case of Windows 8
[Desktop] - [Right Click on Start] - [Device Manager]
2. The "X" of Prolific USB-to-Serial Comm Port (COMX) under "Port (COM and LPL)" is the COM port number.

Using the RS-232C cable

Connect the RS-232C cable to the RS-232C Connector. When connecting the cable, be sure to fasten the screws.

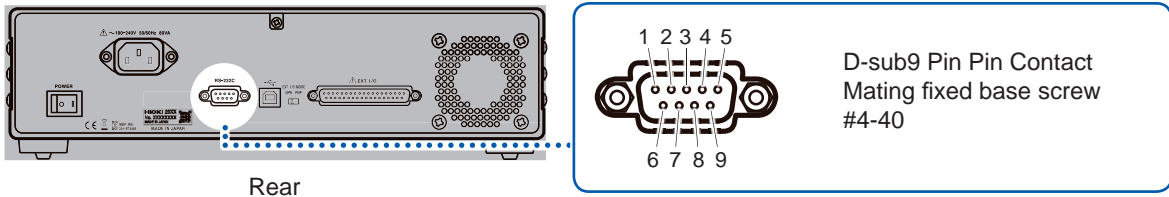

Rear

When connecting to the controller (DTE), prepare the crossing cable that is suited to both specifications of this instrument side and the controller side. Input/output cables are applied to Terminal (DTE) specifications. The instrument uses the pin numbers of 2, 3, and 5. The other pins are not used.

PIN No.	Signal name			Signal	Remarks
	Common use	EIA	JIS		
1	DCD	CF	CD	Career detection	Unconnected
2	RxD	BB	RD	Receive data	
3	TxD	BA	SD	Transmit Data	
4	DTR	CD	ER	Data Terminal Ready	ON level (+5 V to +9 V) fixed
5	GND	AB	SG	Ground for signal	
6	DSR	CC	DR	Data Set Ready	Unconnected
7	RTS	CA	RS	Request to Send	ON level (+5 V to +9 V) fixed
8	CTS	CB	CS	Clear to Send	Unconnected
9	RI	CE	CI	Calling Indicator	Unconnected

When connecting Instrument to computer

Use crossing cable of D-sub9 Pin Female - D-sub9 Pin Female.

Cross connection

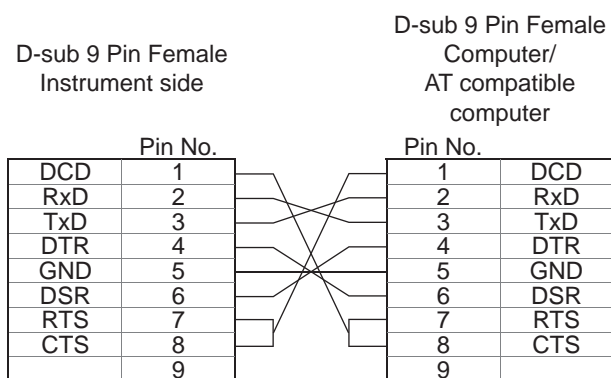

Recommended cable: Model 9637 RS-232C Cable (1.8 m) manufactured by HIOKI

Setting the transmission speed (Common for USB, RS-232C)

The instrument sets the transmission speed (baud rate) of the interface. It is necessary to set the transmission speed when either the USB communication or the RS-232C communication is used.

- 1 Press **MENU** (**MENU**). (The setting screen appears.)

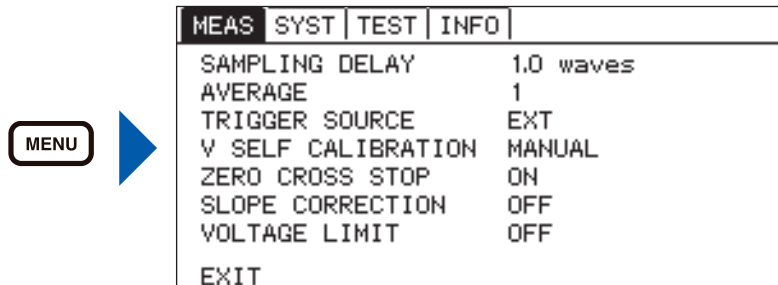

- 2 Select **[SYST]** tab.

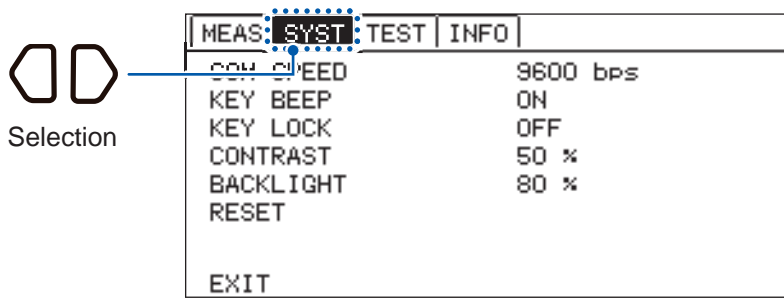

- 3 Select **[COM SPEED]** and set SPEED.

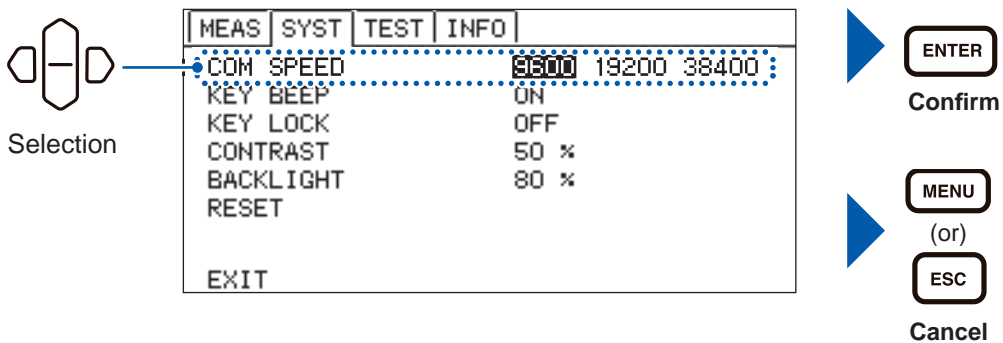

Setting the controller (Computer or PLC)

Be sure to set to the following.

- Start-stop synchronization
- Transmission speed: 9,600 bps, 19,200 bps, 38,400 bps (Adjust to the instrument's setting.)
- Stop bit: 1
- Data length: 8
- Parity check: Not provided
- Flow control: Not provided

IMPORTANT

The fast transmission speed (baud rate) may not be used due to a large error caused by some computers. In that case, use with lower transmission speed.

9.3 Controlling the Communication and Acquiring the Data

For the description (communication message reference) of the communication commands and queries, refer to the Communication Command Instruction Manual for the Application Software, which is attached.

Remote state/Local state

During the communication, the instrument becomes the remote status, and **[RMT]** appears on the measurement screen. Then, the operation keys except for **LOCAL** key are ineffective.

Press **LOCAL** (**LOCAL**). Then, the remote status is released and the key operation is possible.

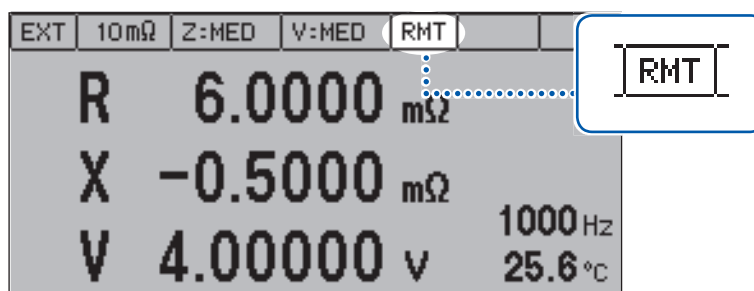

When the instrument indicates the setting screen, if it becomes the remote status, the screen automatically moves to the measurement screen.

10 Specifications

10.1 Specifications of Measurement Functions

Impedance measurement

Measurement signal	Constant current AC signal	
Measurement method	Four-terminal pair method	
Measurement terminal structure	BNC	
Measurement terminal function	SOURCE-H terminal	Current generation terminal
	SOURCE-L terminal	Current detection terminal
	SENSE-H terminal	Voltage detection terminal
	SENSE-L terminal	Voltage detection terminal
Measurement items	Resistance	(Parameter indication: R)
	Reactance	(Parameter indication: X)
	Impedance	(Parameter indication: Z)
	Phase angle	(Parameter indication: θ)
Range structure	3 m Ω /10 m Ω /100 m Ω	
Measurement speed setting	FAST/MED/SLOW	

Display range/Resolution

		3 m Ω range	10 m Ω range	100 m Ω range
Z	Display range	0.0000 m Ω to 3.6000 m Ω	0.0000 m Ω to 12.0000 m Ω	0.000 m Ω to 120.000 m Ω
	Resolution	0.1 $\mu\Omega$	0.1 $\mu\Omega$	1 $\mu\Omega$
θ	Display range	-180.000° to 180.000°	-180.000° to 180.000°	-180.000° to 180.000°
	Resolution	0.001°	0.001°	0.001°
R	Display range	-0.1000 m Ω to 3.6000 m Ω	-0.3000 m Ω to 12.0000 m Ω	-3.000 m Ω to 120.000 m Ω
	Resolution	0.1 $\mu\Omega$	0.1 $\mu\Omega$	1 $\mu\Omega$
X	Display range	-3.6000 m Ω to 3.6000 m Ω	-12.0000 m Ω to 12.0000 m Ω	-120.000 m Ω to 120.000 m Ω
	Resolution	0.1 $\mu\Omega$	0.1 $\mu\Omega$	1 $\mu\Omega$

Frequency range	0.10 Hz to 1050 Hz	
Frequency setting resolution	0.10 Hz to 0.99 Hz	0.01 Hz step
	1.0 Hz to 9.9 Hz	0.1 Hz step
	10 Hz to 99 Hz	1 Hz step
	100 Hz to 1050 Hz	10 Hz step
Frequency accuracy	$\pm 0.01\%$ of setting or less	

Measuring current/DC load (DC load is the offset current that is applied to the measuring object when measuring the impedance.)

	3 mΩ range	10 mΩ range	100 mΩ range
Measurement current	1.5 A rms ±10%	500 mA rms ±10%	50 mA rms ±10%
DC load current	1 mA or less	0.35 mA or less	0.035 mA or less

Measurement wave number		FAST	MED	SLOW
	0.10 Hz to 66 Hz	1 wave	2 waves	8 waves
	67 Hz to 250 Hz	2 waves	8 waves	32 waves
	260 Hz to 1050 Hz	8 waves	32 waves	128 waves

Overrange indication OverRange

Voltage measurement

Measurement terminal structure	BNC		
Measurement terminal function	SENSE-H terminal	Voltage detection terminal	
	SENSE-L terminal	Voltage detection terminal	
Measurement items	Voltage (Parameter indication: V)		
Range structure	5 V (single range)		
Display range	-5.10000 V to 5.10000 V		
Resolution	10 μV		
Measurement speed setting	FAST/MED/SLOW		
Measurement time	FAST	0.1 s	
	MED	0.4 s	
	SLOW	1.0 s	
	(When self calibration is AUTO, 210 ms is added to the measurement time.)		
Sampling period	6 kHz		
Overrange display	OVER VOLTAGE		

Temperature measurement

Measurement terminal structure	Four-terminal earphone jack φ3.5 mm		
Measurement items	Temperature (Parameter indication: T)		
Display range	-10.0°C to 60.0°C		
Resolution	0.1°C		
Sampling time	2.3 s		
Overrange indication	+Over°C, -Under°C		
Indication when unconnected	--.°C		

Function

Function structure (R, X, V, T)/(Z, θ , V, T)/(R, X, T)/(Z, θ , T)/(V, T)

Measurement sequence

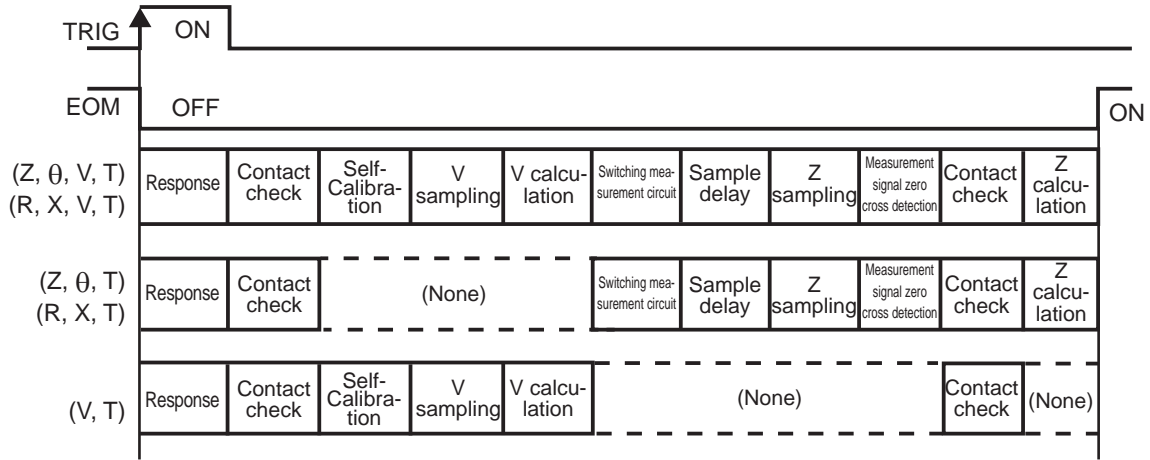

The self-calibration is performed when the self-calibration setting is **[AUTO]**.

Measurement signal zero cross detection is performed when the measurement signal zero cross stop function is **[ON]**.

Measurement time

Response time	0.1 ms
Contact check time	10 ms
Self-Calibration time	210 ms
V Sampling time	0.1 s/0.4 s/1.0 s (FAST/MED/SLOW)
V calculation time	0.1 ms
Switching time of measurement circuit	58 ms
Sample delay time	$(1 \div f) \times M + 5$ ms (f: Measurement frequency, M: Set wave number)
Z sampling time	$(1 \div f) \times N + T + 0.016$ (f: Measurement frequency, N: Measurement wave number, T: Sampling control time) (Unit is "s") $T = 0.088 \div f$ (f: 0.1 Hz to 66 Hz) $T = 0.36 \div f$ (f: 67 Hz to 250 Hz) $T = 1.5 \div f$ (f: 260 Hz to 1050 Hz)
Measurement signal zero cross detection	$(1 \div f)$ or less (f: Measurement frequency) (Unit is "s")
Z calculation time	70 ms

Total measurement time	Function (R, X, V, T)/(Z, θ , V, T) Response time + Contact checking time \times 2 + (Self calibration time) + V sampling time + V calculation time + Measurement circuit switching time+ Sample delay time + Z sampling time + (Measurement signal zero cross detection time) + Z calculation time
	Function (R, X, T)/(Z, θ , T) Response time + Contact checking time \times 2 + Measurement circuit switching time + Sample delay time + Z sampling time + (Measurement signal zero cross detection time) + Z calculation time
	Function (V, T) Response time + Contact checking time \times 2 + (Self calibration time) + V sampling time + V calculation time
	(Self calibration time is added when the self calibration is set to [AUTO] .) (Measurement signal zero cross detection time is added when the measurement signal zero cross stop function is [ON] .)

10.2 Additional Function

Measurement

Range setting

Function overview	Setting measurement range of impedance. (Voltage and temperature have no setting due to the single range.)
Function setting	3 m Ω /10 m Ω /100 m Ω (AUTO setting is not provided.)
Setting backup	Yes

Frequency setting

Function overview	Setting the measurement frequency of impedance measurement.
Function setting	0.10 Hz to 1050 Hz
Setting backup	Yes

Measurement speed setting

Function overview	Setting impedance measurement, Setting measurement speed of voltage measurement.	
Function setting	Impedance measurement	FAST/MED/SLOW
	Voltage measurement	FAST/MED/SLOW
Setting backup	Yes	

Function setting

Function overview	Setting measurement functions.
Function setting	(R, X, V, T)/(Z, θ , V, T)/(R, X, T)/(Z, θ , T)/(V, T)
Setting backup	Yes

Setting trigger source

Function overview	Trigger for measurement start.
Function setting	EXT/INT EXT: External trigger INT: Internal trigger (The voltage limit is turned ON when the internal trigger is set.)

Setting backup	Yes
----------------	-----

Stopping the measurement

Function overview	Stopping the measurement.
Function setting	By pressing START/STOP key during measurement, measurement stops.

Indicating measurement status

Function overview	Indicating measurement in operation on the screen.
Function operation	Indicating measurement in operation on the LCD screen when the measurement time is long (about 1 s or more).

Panel saving and loading

Function overview	Saves and reads measurement conditions.	
Adaptive conditions	Measurement function, Measurement range, Impedance measurement speed, Voltage measurement speed, Measurement frequency, Comparator setting, Zero adjustment setting, Zero adjustment data, Sample delay setting, Average, Trigger source setting, Self calibration setting, Measurement signal zero cross stop setting, Slope correction setting, Voltage limit	
Numbers of panel	126	
Function setting	Save	Saving current measurement conditions
	Load	Reading saved measurement conditions
	Clear	Erases saved measurement conditions
	Detailed display	Displays saved measurement conditions (displays adaptive conditions)
Setting backup	Yes (Backs up panel data)	

Detecting the measurement error

Function overview	Indicating measurement error, and performs error indication and error output. Stopping measurement immediately after detection.	
-------------------	---	--

Malfunction detection contents	Detected contents	Detection timing	Indication
	Measurement current error	<ul style="list-style-type: none"> Between trigger acceptance and voltage measurement Between sampling delay and measurement signal zero cross stop 	----
	Contact error between SOURCE-H and SENSE-H	Before and after measurement	CONTACT ERR H
	Contact error between SOURCE-L and SENSE-L	Before and after measurement	CONTACT ERR L
	Voltage drift of the measuring object	During impedance measurement	VOLTAGE DRIFT
	Over-voltage input error	When voltage is measured	OVER VOLTAGE
	Voltage limit error	When voltage is measured	OVER V LIMIT
	Return cable unconnected error	After impedance measurement	RETURN CABLE ERROR

Detection timing	Refer to "8.2 Timing Chart" (p. 84)
Measurement error display	Refer to "Error display and remedy" (p. 121)

Comparator

Function overview	Comparison functions of measurement and reference values		
Function setting	ON/OFF (Setting each measurement parameter)		
Adaptive measurement	Impedance measurement, voltage measurement		
Setting the range for upper and lower limit values	Z: 0.0000 mΩ θ: -180.000° R: -3.0000 mΩ X: -120.0000 mΩ V: -5.10000 V	to	120.0000 mΩ 180.000° 120.0000 mΩ 120.0000 mΩ 5.10000 V
Buzzer mode	OFF/Hi • Lo/IN/ALL		
Buzzer operation	OFF	No buzzer sound	
	Hi • Lo	Short buzzer sound (three times)	
	IN	Long buzzer sound	
	ALL	In the case of Hi • Lo:	Short buzzer sound (three times)
		In the case of IN	Long buzzer sound
V absolute value judgment	ON/OFF		
Judgment result	Hi/IN/Lo (impedance and voltage are independently judged)		
PASS/FAIL judgment	AND-operates the results of impedance judgment and voltage judgment, and then outputs PASS/FAIL (EXT.I/O output)		

Judgment operation

Measurement Result	Judgment result	Output of EXT. I/O					
		Hi	IN	Lo	ERR	PASS	FAIL
Hi Set value < Measured value	Hi	ON	OFF	OFF	OFF	OFF	ON
Lo Set value ≤ Measured value ≤ Hi Set value	IN	OFF	ON	OFF	OFF	ON	OFF
Measured value < Lo Set value	Lo	OFF	OFF	ON	OFF	OFF	ON
OverRange	Hi	ON	OFF	OFF	OFF	OFF	ON
Measurement Error	Will not judge	OFF	OFF	OFF	ON	OFF	OFF
During interruption of measurement	Will not judge	OFF	OFF	OFF	OFF	OFF	OFF

Setting backup	Yes
----------------	-----

Zero adjustment

Function overview	Removing the residual components caused from offset and the measurement environment.
Adaptive measurement	Impedance measurement, voltage measurement
Function setting	ON/OFF
Adjustment mode	SPOT/ALL
	SPOT: Zero adjustments are performed for the frequency and voltage measurements within the range that is currently set.
	ALL: Zero adjustment is performed for all the frequencies and voltage measurements within the range that is currently set.

Zero adjustment range	R	-0.1000 mΩ to 0.1000 mΩ (3 mΩ range) -0.3000 mΩ to 0.3000 mΩ (10 mΩ range) -3.000 mΩ to 3.000 mΩ (100 mΩ range)
	X	-1.5000 mΩ to 1.5000 mΩ (Common for all ranges)
	V	-0.10000 V to 0.10000 V
Setting backup	Yes	

Self-Calibration

Function overview	Calibration of internal circuit to maintain accuracy of voltage measurement.	
Function setting	AUTO/MANUAL	
Execution timing	AUTO	Always performed every voltage measurements.
	MANUAL	Executed with EXT.I/O or command. (Executed in the TRIG waiting state. The EXT. I/O or command will be executed after the completion of measurement if a signal is received when the measurement is in progress.)
Self-Calibration time	210 ms	
Setting backup	Yes	

Sample delay

Function overview	When the impedance measurement is performed, sets the number of waves to wait from applying AC to sampling start. (p. 38)	
Function setting	WAVE/ΔVOLT	
	WAVE:	Sampling is performed only for the set wavenumbers after the application of measurement signal. Set with 0 wave to 9 wave (Resolution 0.1 wave, default value: 1 wave)
	ΔVOLT:	Sampling is performed after the deviation of the measurement signal slope drops below the set voltage. Setting with 0.001 mV to 10.000 mV
Setting backup	Yes	

Average (Only for impedance measurement)

Function overview	Averaging specified times of impedance measurement values and then output.	
Function setting	1 to 99 times	
Averaging method	Simple average	
	$R_{\text{avg}(n)} = \frac{1}{A} \sum_{k=(n-1)A+1}^{nA} R_k$	
Setting backup	Yes	

Slope correction of impedance measurements

Function overview	Compensating the slope of AC signal when the impedance measurement is performed. (p. 43)	
Function setting	ON/OFF	
Setting backup	Yes	

Voltage limit

Function overview	Setting the upper limit value of the battery voltage that the impedance measurement is performed. When the battery voltage is higher than the set voltage, impedance measurement will not be performed. (p. 45)
Function setting	ON/OFF
Setting range	0.01 V to 5.00 V (Default setting: 4.20 setting based on absolute value)
Setting backup	Yes

Preventing charge and/or discharge when AC is applied

Function overview	Prevents charging to and/or discharging from the battery by terminating the measurement AC signal at zero cross.
Function settings	ON/OFF
Accuracy	±80 μs
Setting backup	Yes

System**Interface setting**

Function overview	Setting the communication interface.
Function setting	RS-232C/USB (automatic recognition that USB is taken priority. Both cannot be use simultaneously.)
Transmission speed setting	9,600 bps/19,200 bps/38,400 bps (Transmission delimiter is fixed with CR+LF.)
Setting backup	Yes

Display setting

Function overview	Adjusting the contrast of display and the backlight.
Auto-off	The brightness is reduced to 10% if a non-operational state continues for one minute in the case of an external trigger. The brightness can be returned to the previous status by the key operation on the front panel.
Contrast	0% to 100% (by 5%, initial value: 50%)
Brightness adjustment	10% to 100% (by 5%, initial value: 80%)
Setting backup	Yes

EXT.I/O setting

Function overview	Setting the output of EXTI/O in the sink or the source.
EXT.I/O setting	PNP/NPN
Setting method	Switching with the rear switch

Key-lock

Function overview	Disabling the key operations excluding trigger.
Function setting	ON/OFF (When ON is set, disables the key operations excluding trigger.)
Release method	Press and hold the LOCAL key for five seconds or more

Key operation buzzer

Function overview	When the key is operated, the buzzer is beeped.
Function setting	ON/OFF (When ON is set, the buzzer is beeped.)
Setting backup	Yes

Reset

Function overview	Cancels the settings	
Function operation	System reset	Initializing the settings to the factory default excluding communication setting.
	Normally reset	Initializing the settings to the factory default excluding the communication setting, zero adjustment values, and panel saving data.

Information

Function overview	Indicating the system information.
Indicating information	Serial number, software version

System test

Function overview	Checking each operations.	
Testing item	Key test, LCD test, ROM test, EXT.I/O test	
Function operation	Key test	Checks if the keys are operating correctly.
	LCD test	Checking the ON/OFF operation of LCD.
	ROM test	Checking that the contents of ROM are normal.
	EXT.I/O test	Check that the output signal is output normally from the EXT I/O, and the input signal is read normally.
	Communication monitor	The command and the response for the query is displayed on the screen.

Error display

“Error display and remedy” (p. 121)

10.3 User Interface

Display

Monochrome graphic	LCD 240 × 110
Screen size	94 W × 55 H mm (View area)
Backlight	White LED
	Brightness adjustment range: 10% to 100% (in 5% steps)
Contrast	Adjustment range: 0% to 100% (in 5% steps)

10.4 External Interface

Communication Interface

Interface types	RS-232C/USB (Both RS-232C and USB cannot be controlled simultaneously. When both the USB and the RS-232C communication are connected, the USB connection is effective.)
-----------------	--

RS-232C

Communication contents	Remote control, measured value output
Transmission method	Start-stop synchronization system, full duplex
Transmission speed	9,600 bps/19,200 bps/38,400 bps
Data bit length	8 bit
Stop bit	1
Parity bit	None
Terminator	Sending: CR+LF Receiving: CR, CR+LF
Delimiter	Sending: CR+LF Receiving: CR, CR+LF
Handshake	X flow: Not provided, Hardware flow: Not provided
Protocol	Non-procedure system
Connector	D-sub9 pin, male, mating fixed base screw #4-40

USB

Communication contents	Remote control, measured value output
Electrical specifications	USB2.0 (pseudo COM port)
Class	CDC class
Connector	Series B receptacle

EXT.I/O**Input signal**

Input signal	• START (TRIG)	• STOP	• 0ADJ_SPOT
	• 0ADJ_ALL	• LOAD0 to LOAD6	• CAL
Photo-coupler insulation	Non-voltage contact inputs (corresponding to current sink/source output)		
Input ON	Residual voltage 1 V (Input ON Current 4 mA (reference value))		
Input OFF	OPEN (Breaking current less than 100 μ A)		

Output signal

Output signal	• INDEX	• EOM	• ERR	• PASS	• FAIL
	• RorZ_HI	• RorZ_IN	• RorZ_LO	• Xor θ _HI	• Xor θ _IN
	• Xor θ _LO	• V_HI	• V_IN	• V_LO	
Photo-coupler insulation	Open drain output (non-polarity)				
Maximum load voltage	30 V max DC Residual voltage less than 1 V (Load current 50 mA)/less than 0.5 V (Load current 10 mA)				
Maximum output current	50 mA max /ch				

Service power supply output

Output voltage	Corresponding to sink output	+5.0 V \pm 10%, 100 mA max
	Corresponding to source output	-5.0 V \pm 10%, 100 mA max
Insulation	Floating from the protective grounding potential and the measurement circuit.	
Insulation rating	Voltage to ground 50 V DC, 33 V AC rms, less than 46.7 V _{peak} AC	

Structure

Connector	D-sub37Pin, Female, mating fixed base screw #4-40 Screw
Pin layout	"8.1 External Input/output Terminals and Signals" (p. 80)

10.5 Accuracy

Guaranteed accuracy conditions

Temperature and humidity range	23°C±5°C (73°F±9°F), less than 80% RH (no condensation)
Zero adjustment	After performing the zero adjustment
Measurement status	Measuring under the same conditions (probe shape, layout, measurement environment) as the zero adjustment. Unchanging of the probe's shape during the measurement.
Warm-up time	At least 60 minutes
Self-Calibration	Performing the self-calibration after warm-up. Maintaining the fluctuation of environment temperature after the self-calibration within ±2°C.

Impedance measurement accuracy

- 3 mΩ range (0.1 Hz to 100 Hz), 10 mΩ range, and 100 mΩ range

$$R \text{ accuracy} = \pm (0.004|R| + 0.0017|X|) [\text{m}\Omega] \pm \alpha$$

$$X \text{ accuracy} = \pm (0.004|X| + 0.0017|R|) [\text{m}\Omega] \pm \alpha$$

(The units of R and X are [mΩ], α is as shown in the table below.)

$$Z \text{ accuracy} = \pm 0.4\% \text{ rdg.} \pm \alpha (|\sin \theta| + |\cos \theta|)$$

$$\theta \text{ accuracy} = \pm 0.1^\circ \pm 57.3\alpha / Z (|\sin \theta| + |\cos \theta|)$$

(α is as shown in the table below.)

- 3 mΩ range (110 Hz to 1050 Hz)

$$R \text{ accuracy} = \pm (0.004|R| + 0.0052|X|) [\text{m}\Omega] \pm \alpha$$

$$X \text{ accuracy} = \pm (0.004|X| + 0.0052|R|) [\text{m}\Omega] \pm \alpha$$

(The units of R and X are [mΩ], α is as shown in the table below.)

$$Z \text{ accuracy} = \pm 0.4\% \text{ rdg.} \pm \alpha (|\sin \theta| + |\cos \theta|)$$

$$\theta \text{ accuracy} = \pm 0.3^\circ \pm 57.3\alpha / Z (|\sin \theta| + |\cos \theta|)$$

(α is as shown in the table below.)

		3 mΩ range	10 mΩ range	100 mΩ range
α	FAST	25 dgt.	60 dgt.	60 dgt.
	MED	15 dgt.	30 dgt.	30 dgt.
	SLOW	8 dgt.	15 dgt.	15 dgt.
Temperature coefficient	R: ±R Accuracy × 0.1/°C X: ±X Accuracy × 0.1/°C Z: ±Z Accuracy × 0.1/°C θ: ±θ Accuracy × 0.1/°C Applied in the range (0°C to 18°C, 28°C to 40°C)			

Accuracy graph

- 3 mΩ range (0.1 Hz to 100 Hz), 10 mΩ range, and 100 mΩ range

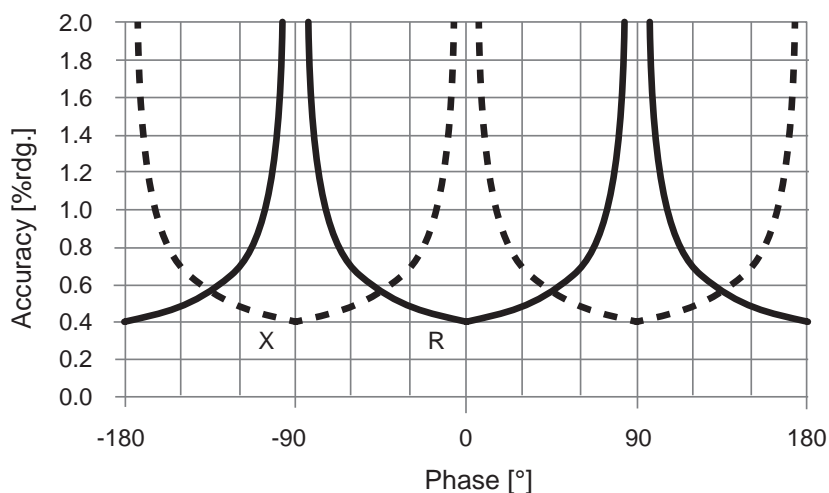

Impedance accuracy excluding α ($0.004|R| + 0.0017|X|$, $0.004|X| + 0.0017|R|$)

- 3 mΩ range (110 Hz to 1050 Hz)

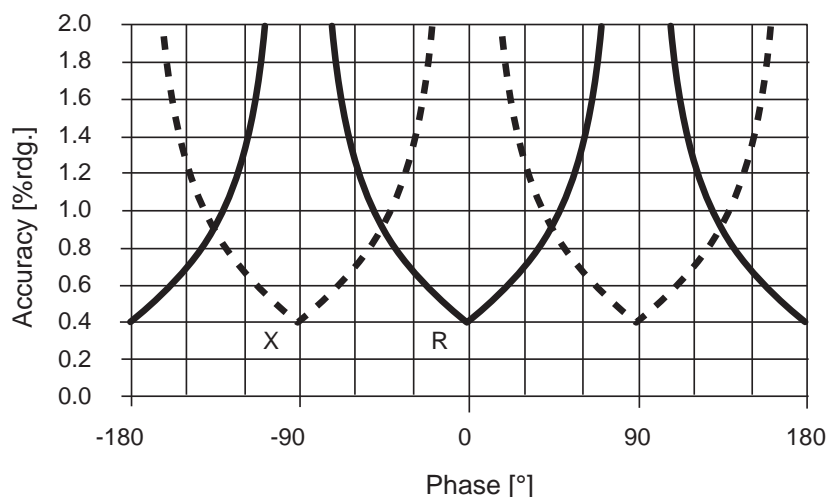

Impedance accuracy excluding α ($0.004|R| + 0.0052|X|$, $0.004|X| + 0.0052|R|$)

Voltage measurement accuracy

Voltage measurement

V	Display range	-5.10000 V to 5.10000 V
	Resolution	10 μ V
Voltage accuracy	FAST	$\pm 0.0035\%$ rdg. ± 5 dgt.
	MED	$\pm 0.0035\%$ rdg. ± 5 dgt.
	SLOW	$\pm 0.0035\%$ rdg. ± 5 dgt.
Temperature coefficient	$\pm 0.0005\%$ rdg. ± 1 dgt./ $^{\circ}$ C (Applied in the ranges of 0° C to 18° C, and 28° C to 40° C)	

Temperature measurement accuracy

Temperature measurement (BT4560 only)	±0.1°C Temperature coefficient: ±0.01°C/°C (applied to the range of 0°C to 18°C, 28°C to 40°C)
Temperature measurement (BT4560+Z2005)	±0.5°C (Measured temperature: 10.0°C to 40.0°C) ±1.0°C (Measured temperature: -10.0°C to 9.9°C, 40.1°C to 60.0°C)

Example of accuracy calculation

(Rounded down to the displayed digit)

1 Impedance measurement accuracy

<Measurement condition 1>

Measurement range: 3 mΩ range, Measurement speed: SLOW, Frequency: 0.1 to 100 Hz, Measuring object: R=1 mΩ, X=-0.5 mΩ

R accuracy

$$\begin{aligned} & \pm (0.004 \times |1 \text{ m}\Omega| + 0.0017 \times |-0.5 \text{ m}\Omega|) \pm 8 \text{ dgt.} \\ = & \pm (0.004 \times |1 \text{ m}\Omega| + 0.0017 \times |-0.5 \text{ m}\Omega|) \pm 0.0008 \text{ m}\Omega \\ = & \pm 0.00565 \text{ m}\Omega \text{ (Rounded down to the displayed digit } \pm 0.0056 \text{ m}\Omega) \end{aligned}$$

X accuracy

$$\begin{aligned} & \pm (0.004 \times |-0.5 \text{ m}\Omega| + 0.0017 \times |1 \text{ m}\Omega|) \pm 8 \text{ dgt.} \\ = & \pm (0.004 \times |-0.5 \text{ m}\Omega| + 0.0017 \times |1 \text{ m}\Omega|) \pm 0.0008 \text{ m}\Omega \\ = & \pm 0.00450 \text{ m}\Omega \text{ (Rounded down to the displayed digit } \pm 0.0045 \text{ m}\Omega) \end{aligned}$$

<Measurement condition 2>

Measurement range: 100 mΩ range, Measurement speed: FAST, Frequency: 0.1 to 1050 Hz, Measuring object: Z=60 mΩ, θ=-20°

Z accuracy

$$\begin{aligned} & \pm 0.4\% \text{ rdg.} \times 60 \text{ m}\Omega \pm 60 \text{ dgt.} \times \{|\cos(-20^\circ)| + |\sin(-20^\circ)|\} \\ = & \pm 0.240 \text{ m}\Omega \pm 0.060 \text{ m}\Omega \times (|0.940| + |-0.342|) \\ = & \pm 0.3169 \text{ m}\Omega \text{ (Rounded down to the displayed digit } \pm 0.316 \text{ m}\Omega) \end{aligned}$$

θ accuracy

$$\begin{aligned} & \pm 0.1^\circ \pm 57.3^\circ \times 60 \text{ dgt.} \div 60 \text{ m}\Omega \times \{|\cos(-20^\circ)| + |\sin(-20^\circ)|\} \\ = & \pm 0.1^\circ \pm 57.3^\circ \times 0.060 \text{ m}\Omega \div 60 \text{ m}\Omega \times (|0.940| + |-0.342|) \\ = & \pm 0.1734^\circ \text{ (Rounded down to the displayed digit } \pm 0.173^\circ) \end{aligned}$$

<Measurement condition 3>

Measurement range: 3 mΩ range, Measurement speed: SLOW, Frequency: 0.1 to 100 Hz, Measuring object: R=1 mΩ, X=-0.5 mΩ, Instrument's ambient temperature: 15°C

R accuracy

$$\begin{aligned} & \pm (0.004 \times |1 \text{ m}\Omega| + 0.0017 \times |-0.5 \text{ m}\Omega|) \pm 8 \text{ dgt.} \\ & + \{\pm (0.004 \times |1 \text{ m}\Omega| + 0.0017 \times |-0.5 \text{ m}\Omega|) \pm 8 \text{ dgt.}\} \times 0.1^\circ\text{C} \times (|18^\circ - 15^\circ\text{C}|) \\ = & \pm 0.00565 \text{ m}\Omega + (\pm 0.00565 \text{ m}\Omega) \times 0.1^\circ\text{C} \times 3^\circ\text{C} \\ = & \pm 0.00735 \text{ m}\Omega \text{ (Rounded down to the displayed digit } \pm 0.0073 \text{ m}\Omega) \end{aligned}$$

X accuracy

$$\begin{aligned} & \pm (0.004 \times |-0.5 \text{ m}\Omega| + 0.0017 \times |1 \text{ m}\Omega|) \text{ m}\Omega \pm 8 \text{ dgt.} \\ & + \{\pm (0.004 \times |-0.5 \text{ m}\Omega| + 0.0017 \times |1 \text{ m}\Omega|) \text{ m}\Omega \pm 8 \text{ dgt.}\} \times 0.1^\circ\text{C} \times (|18^\circ - 15^\circ\text{C}|) \\ = & \pm 0.0045 \text{ m}\Omega + (\pm 0.0045 \text{ m}\Omega) \times 0.1^\circ\text{C} \times 3^\circ\text{C} \\ = & \pm 0.00585 \text{ m}\Omega \text{ (Rounded down to the displayed digit } \pm 0.0058 \text{ m}\Omega) \end{aligned}$$

2 Voltage measurement accuracy

<Measurement condition 1>

Measurement range: arbitrary, Measurement speed: arbitrary, Frequency: arbitrary, Measuring object: R=arbitrary, X=arbitrary, V=3.6 V

V accuracy

$$\begin{aligned} & \pm 0.0035\% \text{ rdg.} \times 3.6 \text{ V} \pm 5 \text{ dgt.} \\ = & \pm 0.000126 \text{ V} \pm 0.00005 \text{ V} \\ = & \pm 0.000176 \text{ V (Rounded down to the displayed digit } \pm 0.00017 \text{ V)} \end{aligned}$$

<Measurement condition 2>

Measurement range: arbitrary, Measurement speed: arbitrary, Frequency: arbitrary, Measuring object: R=arbitrary, X=arbitrary, V=3.6 V, Instrument's ambient temperature: 15°C

V accuracy

$$\begin{aligned} & \pm 0.0035\% \text{ rdg.} \times 3.6 \text{ V} \pm 5 \text{ dgt.} + (\pm 0.0005\% \text{ rdg./}^\circ\text{C} \times 3.6 \text{ V} \pm 1 \text{ dgt./}^\circ\text{C}) \times (|18^\circ\text{C} - 15^\circ\text{C}|) \\ = & \pm 0.000176 \text{ V} + (\pm 0.000018 \text{ V/}^\circ\text{C} \pm 0.00001 \text{ V/}^\circ\text{C}) \times 3^\circ\text{C} \\ = & \pm 0.000260 \text{ V (Rounded down to the displayed digit } \pm 0.00026 \text{ V)} \end{aligned}$$

3 Temperature measurement accuracy

<Measurement condition 1>

Combination of this instrument and Z2005, Measured temperature: T=35°C, Instrument's ambient temperature: 0°C

T accuracy

$$\begin{aligned} & \pm 0.5^\circ\text{C} \pm 0.01^\circ\text{C/}^\circ\text{C} \times (|18^\circ\text{C} - 0^\circ\text{C}|) \\ = & \pm 0.68^\circ\text{C (Rounded down to the displayed digit } \pm 0.6^\circ\text{C)} \end{aligned}$$

10.6 General Specifications

Operating temperature and humidity	0°C to 40°C (32°F to 104°F), 80% RH or less (no condensation)	
Storage temperature and humidity	-10°C to 50°C (14°F to 122°F), 80% RH or less (no condensation)	
Accuracy guarantee for temperature and humidity range	23°C±5°C (73.4°F±9°F), 80% RH or less (no condensation)	
Guaranteed accuracy period	One year	
Product warranty period	One year	
Operating environment	Indoors, Pollution degree 2, altitude up to 2000 m (6562 ft.)	
Rated supply voltage	100 V AC to 240 V AC (Considers ±10% voltage fluctuation against rated supply voltage) Anticipated transient overvoltage 2500 V	
Rated supply frequency	50 Hz/60 Hz	
Maximum rated power	80 VA	
Maximum input voltage	±5 V (Between H terminal and L terminal)	
Maximum voltage to ground	0 V DC (Between H terminal and chassis) (The L terminal is virtually grounded in the internal circuit. Thus, the voltage to ground must not be input.)	
Open-circuit terminal voltage	50 mV or less (When not measured) 15 V or less (When measured)	
Dielectric strength	Between power supply terminal lump and protective ground	1.62 kV AC, Cut-off current 10 mA for 1 minute
Dimensions	Approx. 330 W × 80 H × 293 D mm (12.99"W × 3.15"H × 11.54"D) (excluding projections)	
Mass	Approx. 3.7 kg (130.5 oz.)	

Standards

Safety	EN61010	
EMC	EN61326 Class A EN61000-3-2 EN61000-3-3	
	Effect of radiated radio-frequency electromagnetic field	At 10 V/m, Impedance measurement $\pm 5\%$ f.s. At 10 V/m, Voltage measurement $\pm 2\%$
	Effect of conducted radio-frequency electromagnetic field	At 3 V, Impedance measurement $\pm 2\%$ f.s.
	Effect of external magnetic field	In a magnetic field of 400 A/m, 50/60 Hz Impedance measurement $\pm 6\%$ f.s.

Accessories

Refer to p. 1.

Options

Refer to p. 2.

11.1 Troubleshooting

- If damage is suspected, check the “Troubleshooting” section before contacting your authorized Hioki distributor or reseller.
- When sending the instrument for repair, pack carefully to prevent damage in transit. Include cushioning material so the instrument cannot move within the package. Be sure to include details of the problem. Hioki cannot be responsible for damage that occurs during shipment.
- The fuse is housed in the power unit of the instrument. If the power does not turn on, the fuse may be blown. If this occurs, a replacement or repair cannot be performed by customers. Please contact your authorized Hioki distributor or reseller.

Q&A (Frequent inquiries)

General items

No.	Trouble	Confirm	Possible causes → Solution	Ref.	
1-1	Power is still OFF (nothing is displayed).	Main power switch (rear)	OFF	Power is not supplied. → Turn ON the main power switch (rear).	p. 19
			ON	Power is not supplied. → Check the conduction of power cables. → Check if the breaker for the equipment is turned ON.	p. 19
				Power voltage and/or frequency are different. → Check the power rating. (100 V to 240 V, 50/60 Hz)	–
				The screen is dark. → Adjust the backlight brightness and contrast. → External trigger setting automatically reduces the backlight brightness if a non-operation state continues for 1 minute.	p. 66
1-2	Keys cannot be operated.	Display	[LOCK] is displayed.	The key is locked. → Release the keylock.	p. 63
			[RMT] is displayed.	The instrument is in remote state. → Release the remote state.	p. 100
1-3	Judgment results are not displayed.	Measurement values	are displayed.	Comparator function is OFF. → Turn the function ON.	p. 50
			are not displayed. (Non-values are displayed)	When measurement values are not displayed, judgment is not done and the indicator is not displayed.	–
1-4	Buzzer cannot be heard.	Key operation tone is set to	OFF	Key operation tone is set to OFF. → Turn the function ON.	p. 65
		Judgment tone is set to	OFF	Judgment tone is set to OFF. → Turn the function ON.	p. 55

No.	Trouble	Confirm	Possible causes → Solution	Ref.
1-5	Adjusting buzzer volume	The buzzer volume cannot be adjusted for this instrument.		-

Concerning measurement items

No.	Trouble	Confirm	Possible causes → Solution	Ref.
2-1	The measurement values have deviated from the expected values.	Zero adjustment	ON Zero adjustment is not correct. → Adjust zero adjustment again by setting the wiring shape of the probe to a shape closer to the actual measuring state.	p. 26
			OFF The impact of the wiring shape has not been removed. → Adjust zero adjustment again by setting the wiring shape of the probe to a shape closer to the actual measuring state.	p. 26
2-2	Measurement values are not stable.	The shape of the measurement probe	Varies for each measuring object. The impact of the wiring shape has not been removed. → Adjust zero adjustment again by setting the wiring shape of the probe to a shape closer to the actual measuring state.	p. 26
			The loop of SENSE-H and L is large. Electromagnetic field affects the measurement values. → Decrease the loop area formed by SENSE-H and SENSE-L wiring.	p. A4
		The measurement probe is	self fabricated. Measurement value changes depending on the measurement position. → Measure after correctly adjusting the probing positions. → Separate the probing positions of SENSE and SOURCE as far as possible. → Use a probe with a point contact (Crown type will result in multi-point contact, which is poor in repeatability.)	p. A4
			provided probe Measurement value changes depending on the measurement position. → Measure after correctly adjusting the probing positions.	-
		Measuring object	Temperature is not stable. Characteristics have changed depending on the temperature. → Measure after the temperature change becomes small.	-
			Heat capacity is small. The measuring current is causing the measuring object to heat up. → Reduce the range of the measurement current.	-
			Discharge capacity is small. Discharge is caused by DC load current. → Reduce the range of the measurement current.	-
		Temperature sensor	is not inserted all the way in. Temperature sensor is not correctly connected. → Insert the temperature sensor all the way in.	-

No.	Trouble	Confirm	Possible causes → Solution	Ref.
2-3	Zero adjustment is not possible.	Measurement values before zero adjustment is not within the acceptable range.	The impact of the wiring shape is too large. → Reduce the loop area formed by the return cable and the measuring object. → Reduce the loop area formed by SENSE-H and SENSE-L.	-
		Measurement error is displayed.	There is a problem with the wiring. → Adjust again with the correct wiring. When the resistance value is high due to self fabricated cables, zero adjustment cannot be performed. Reduce the wiring resistance in such cases.	p. 30

Concerning EXT.I/O items

No.	Trouble	Confirm	Possible causes → Solution	Ref.
3-1	The instrument does not operate at all.	IN and OUT displayed in the EXT.I/O test of the instrument does not match with the controller.	Wiring etc. is incorrect. → Check EXT.I/O again. • Loose connection between connectors • Is the pin number correct? • Wiring of ISO_COM terminals • NPN/PNP settings • Contact (or Open collector) control (Not voltage control) • Power supply to the controller (Power supply to the instrument is not required.)	p. 80
3-2	TRIG is not applied.	Trigger source is internal trigger (INT).	TRIG signal cannot apply a trigger with internal trigger setting. → Set an external trigger.	p. 37
		ON time of TRIG is less than 0.1 ms.	ON time of TRIG is short. → Ensure that ON time is 0.1 ms or more.	-
		ON time of TRIG is less than 1 ms.	OFF time of TRIG is short. → Ensure that OFF time is 1 ms or more.	-
3-3	Does not LOAD.	Panel has not been saved in the loaded panel number.	Panel that is not saved cannot be loaded. → Change the LOAD signal, or save the panel again so it matches the LOAD signal.	p. 82
3-4	EOM is not output.	Measurement values are not updated.	Confirm Q&A in 3-2.	-
		EOM signal logic	The EOM signal will be ON once the measurement is completed.	p. 83
3-5	HI, IN, and LO signals are not output.	Judgment results are not displayed on the instrument screen.	Confirm Q&A in 1-3.	p. 117

Concerning communication items

The operation can be checked smoothly by using the communication monitor (p. 72).

No.	Trouble	Confirm	Possible causes → Solution	Ref.
4-1	There is no response at all.	Display	[RMT] is not displayed. Connection cannot be established. → Check the connector insertions. → Check that the settings of the interfaces are correct. → Do not insert a USB cable when RS-232C is used. → When using the USB, install drivers on control instruments. → Use the cross cable when RS-232C is used. → Check the COM port number of the control instrument. → Match the communication speeds of the instrument and the control instrument.	p. 95
			[RMT] is displayed. Commands are not accepted. → Check the delimiter of the software.	p. 95
4-2	Result becomes an error.	Display	results in a command error. Commands do not match. → Check the spelling of the commands (space is x20H.) → Do not add “?” to commands with no query. → Match the communication speeds of the instrument and the control instrument.	-
			Input buffer (256 bytes) overflow. → Ensure waiting until the received character string is processed. Example: Insert a dummy query for sending several lines of commands such as *OPC? Sending → “1” reception.	-
			results in an execution error. Not in the state in which execution is possible, though the command character string is correct Example: Spelling mistake in data part :SAMP:RATE SLOW2 → Check each command specification.	-
			Input buffer (256 bytes) overflow. → Ensure waiting until the received character string is processed. Example: Insert a dummy query for sending several lines of commands such as *OPC? Sending → “1” reception.	-
4-3	An answer to the query is not returned.	On the communication monitor	response present. The program is not correct. → The instrument is returning the query. Check the receiving part of the program.	-

Error display and remedy

When an error is displayed on the LCD screen, repair is necessary. Please contact your authorized Hioki distributor or reseller.

Display	Error No.	Cause	Countermeasures
OverRange	None	The measurement value exceeds the impedance measurement range.	Set the correct range.
+Over°C	None	The measurement value exceeds the temperature measurement range. The measurement voltage range is -10.0°C to 60.0°C.	The measured temperature is too high and cannot be measured by this instrument.
-Under°C	None	The measurement value lowers the temperature measurement range. The measurement voltage range is -10.0°C to 60.0°C.	The measured temperature is too low and cannot be measured by this instrument.
--.°C	None	The temperature sensor is not connected.	Connect the temperature sensor to the instrument.
----	None	The measurement current cannot be applied.	<ul style="list-style-type: none"> • Check that the probe is in secure contact with the object being measured. • Check that the cable is not disconnected and/or the probe is not worn. • The measurement range may not be suitable. Select a larger measurement range. • When the measurement probe is self-made, some of the wiring resistance may be too high. Make the wire diameter larger and wire length shorter to reduce the wiring resistance. • Check that the measuring object is ungrounded.
RETURN CABLE ERROR	None	The return cable is not connected.	<ul style="list-style-type: none"> • Connect the return cable. (The return cable connects the shields of SOURCE-H and SOURCE-L.) • Check that the wire connection of the probe is correct. • If the error does not go off even if the return cable is connected, the instrument may be malfunction. Request repairs.
CONTACT ERROR H	None	It is not properly connected between SOURCE-H and SENSE-H.	<ul style="list-style-type: none"> • Check that the probe is in secure contact with the object being measured. • Check that the cable is not disconnected and/or the probe is not worn.
CONTACT ERROR L	None	It is not properly connected between SOURCE-H and SENSE-H.	<ul style="list-style-type: none"> • Check that the probe is in secure contact with the object being measured. • Check that the cable is not disconnected and/or the probe is not worn.

Display	Error No.	Cause	Countermeasures
OVER VOLTAGE	None	The voltage of the measuring object exceeds the measurable range. The measurable voltage range is -5.10000 V to 5.10000 V.	The voltage of the measuring object is too high and cannot be measured by this instrument.
OVER V LIMIT	None	The voltage of the measuring object exceeds the voltage limit. It may be overcharged by applying the AC voltage. Lower the battery voltage to measure it. (For the setting method of the voltage limit, refer to p. 45).	Discharge the battery to a safety voltage, and then measure it.
DRIFT VOLTAGE	None	The voltage of the measuring object considerably fluctuates during the measurement.	The instrument cannot measure it.
0ADJUST ERROR	ERR:01	The proper zero adjustment is not performed.	Perform the zero adjustment with a proper method so that the zero adjustment data becomes within the full scale of the range. (p. 26)
COMMAND ERROR	ERR:30	The command is not correct.	Check that the command is correct. (Refer to the attached CD).
EXECUTION ERROR	ERR:31	The parameter part of the command is not correct.	Check that the parameters are proper. (Refer to the attached CD).
OVERHEAT ERROR	ERR:60	The internal temperature of the instrument increases.	<ul style="list-style-type: none"> • Check that the power switch of the instrument is turned off. • Ensure that there is no clogging in the vent holes.
SUM ERROR	ERR:90	The internal data is corrupt.	The device fails. Request repairs.
CALIB ERROR	ERR:91	The adjustment data is corrupt.	The device fails. Request repairs.
ROM ERROR	ERR:92	The ROM data is corrupt.	The device fails. Request repairs.
A/D ERROR	ERR:93	The A/D converter cannot communicate.	The device fails. Request repairs.
VREF ERROR	ERR:94	The voltage calibration cannot be performed.	The device fails. Request repairs.
FAN STOP ERROR	ERR:95	The fan does not rotate.	The device fails. Request repairs.
OVER CURRENT ERROR	ERR:96	The internal circuit is broken.	The device fails. Request repairs.
VREF B ERROR	ERR:97	The built in battery of the instrument has to be replaced.	Please contact your authorized Hioki distributor or reseller.

11.2 Inspection, Repair and Cleaning

WARNING



Touching any of the high-voltage points inside the instrument is very dangerous. Customers are not allowed to modify, disassemble, or repair the instrument. Doing so may cause fire, electric shock, or injury.

Calibrations

IMPORTANT

Periodic calibration is necessary in order to ensure that the instrument provides correct measurement results of the specified accuracy.

The calibration frequency varies depending on the status of the instrument or installation environment. We recommend that the calibration frequency is determined in accordance with the status of the instrument or installation environment and that you request that calibration be performed periodically.

Replaceable parts and operating lifetimes

The characteristics of some of the parts used in the product may deteriorate with extended use. To ensure the product can be used over the long term, it is recommended to replace these parts on a periodic basis. When replacing parts, please contact your authorized Hioki distributor or reseller. The service life of parts varies with the operating environment and frequency of use. Parts are not guaranteed to operate throughout the recommended replacement cycle.

Part name	Recommended replacement cycle	Remarks/conditions
Electrolytic capacitors	Approx. 3 years	The circuit board on which the corresponding part is mounted will be replaced.
LCD backlight (Brightness half life)	Approx. 6 years	When the backlight is used for 365 days with using 24 hours/day,
Fan motor	Approx. 7 years	When the backlight is used for 365 days with using 24 hours/day,
Lithium battery	Approx. 10 years	

Precautions during transportation of the instrument

Pack the instrument so that it will not sustain damage during shipping, and include a description of existing damage. We do not take any responsibility for damage incurred during shipping.

Cleaning

- To clean the instrument, wipe it gently with a soft cloth moistened with water or mild detergent.
- Wipe the LCD gently with a soft, dry cloth.
- Clean the vents periodically to avoid blockage.
If vents become clogged, the instruments internal cooling is impeded, and damage may result.

IMPORTANT

Never use solvents such as benzene, alcohol, acetone, ether, ketones, thinners or gasoline, as they can deform and discolor the case.

11.3 Discarding the Instrument

The instrument uses the CR2032 Coin-shaped lithium battery.
Handle and dispose of the instrument in accordance with local regulations.

Lithium battery removal

WARNING



To avoid electric shock, turn off the power switch and disconnect the power cord and measurement cables before removing the lithium battery.

Required tools

- One Philips screwdriver (No.1)
- A pair of tweezers (to remove the lithium battery)

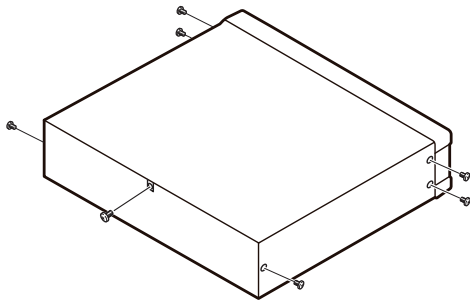

(Overhead view)

1 Verify that the power is off, and remove the connection cables and power cord.

2 Remove the six screws from the sides and one screw from the rear.

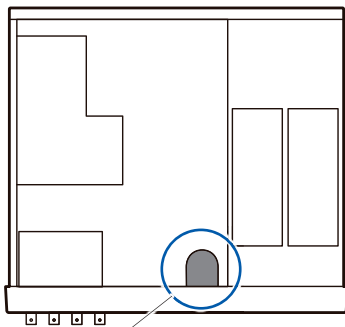

3 Remove the cover.

4 Insert the tweezers between the battery and battery holder as shown in the diagram and lift up the battery.

Lithium battery

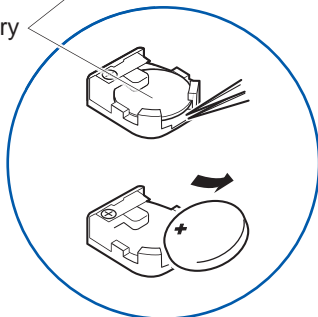

IMPORTANT
Take care not to short the + and -. Doing so may cause sparks.

CALIFORNIA, USA ONLY
This product contains a CR Coin Lithium Battery which contains Perchlorate Material - special handling may apply. See www.dtsc.ca.gov/hazardouswaste/perchlorate

Appendix

Appx. 1 Measurement Parameters and Calculation Formula

In general, the impedance Z is used to evaluate the characteristics of, for example, circuit components.

This instrument measures the voltage vectors of the object being measured against measurement current vectors, and then determines the impedance Z and the phase difference θ from these values. From the values of the impedance Z and the phase difference θ , the values of the resistance and the reactance can be calculated using the following formula. These values are illustrated on the complex plane are illustrated in the diagram below.

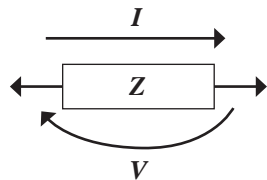

$$Z = R + jX$$

$$\theta = \tan^{-1} \frac{X}{R}$$

$$|Z| = \sqrt{R^2 + X^2}$$

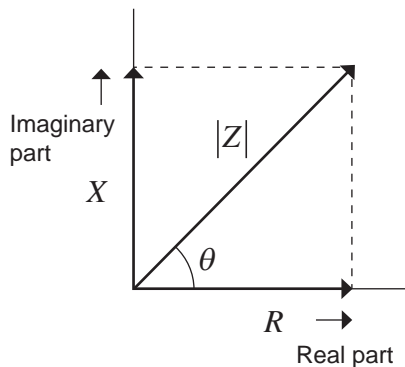

Z : Impedance (Ω)

θ : Phase angle (deg)

R : Resistance (Ω)

X : Reactance (Ω)

$|Z|$: Absolute value of impedance (Ω)

Appx. 2 Four-terminal Pair Method

This instrument uses the four-terminal pair method as the measurement method. In addition to the characteristics of the AC four-terminal method, which is unaffected by the contact resistance, this is a more accurate method that is unaffected by the magnetic field caused by the measuring current.

The principles of the AC four-terminal method and the four-terminal pair method are described below.

AC four-terminal method

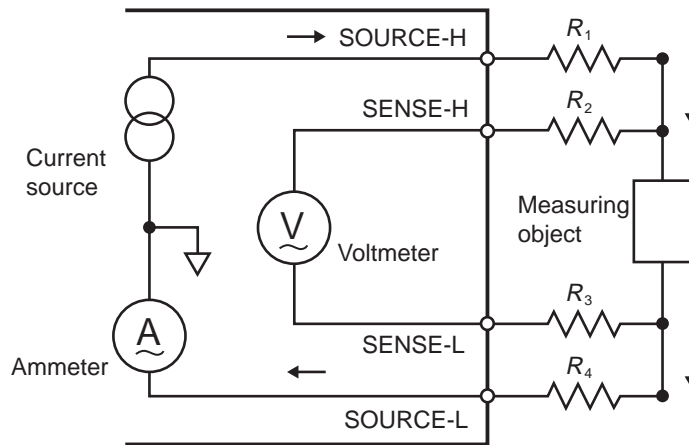

R_1 to R_4 : Resistances of measurement probes and contact resistances of contact portions

This method is unaffected by the wiring resistance of the measurement probes and the contact resistance between the measurement probe and the object being measured, and is suitable for low resistance measurement. This method uses the measuring current between the SOURCE terminals to measure the voltage of the object being measured at the SENSE terminals.

The current flowing through the voltmeter can be ignored because of the voltmeter's high impedance. The voltage actually generated in the object being measured can thus be measured because the voltage drops due to the resistance of the wiring and the resistance of contact can be ignored even if there is wiring resistance or contact resistance in the portions corresponding to R_2 and R_3 .

Four-terminal pair method

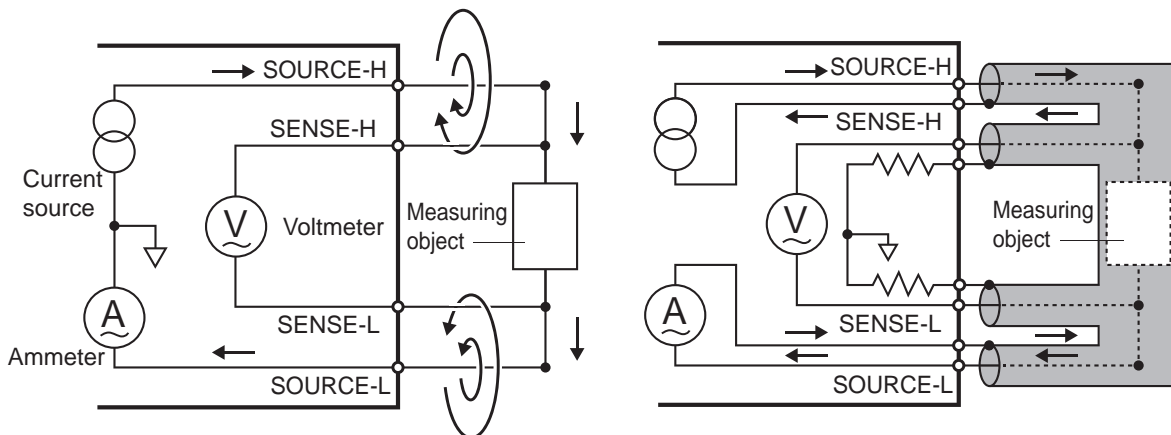

The AC four-terminal method is suitable for a low resistance measurement because it is affected by the resistance of the wiring and the contact resistance. The magnetic field of the measuring current produces an induced electromotive force that affects the SENSE terminals.

In the four-terminal pair method, the current flows backward (current returns) with the same magnitude as the measuring current in the shields of the SOURCE cables, and then cancels the magnetic field of the measuring current. This method suppresses the induced electromotive force induced at the SENSE terminals, and detects the voltage actually generated in the object being measured.

Four-terminal pair method when using the optional probe

When the optional probe L2002 or L2003 of the instrument is used, the four-terminal pair method is structured as described below.

It is necessary that the measuring current and the return current flow in close proximity to each other. This structure enables the return cables to be easily brought close to the object being measured. It is important that the shape of the return cable, which affects the magnetic field, is not changed.

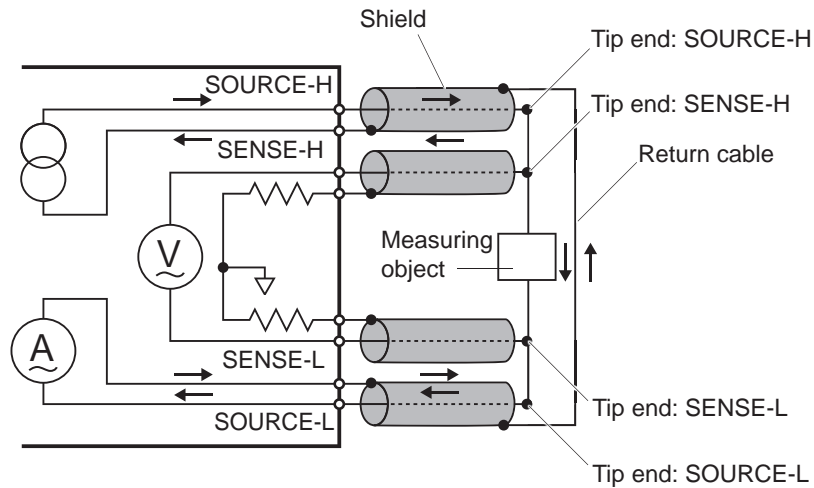

Appx. 3 Cautions When Making Your Own Measurement Probe

Observe the following precautions when making your own measurement probe.

- You must connect the shields of the SOURCE-H and the SOURCE-L. If the shields are not connected, the impedance cannot be measured.
- When the probe is connected to the object being measured, place the SOURCE-H and the SOURCE-L at the outer side and the SENSE-H and the SENSE-L at the inner side in relation to the object being measured. If you do not connect the probes in this fashion, the correct measurement values may not be obtained.
- A coaxial cable is recommended when self fabricating the measurement probe.

<Recommended coaxial cable specifications>

- Conductor resistance: 150 mΩ/m or less
- Capacitance: 150 pF/m or less
(Example: RG58A/U, etc.)

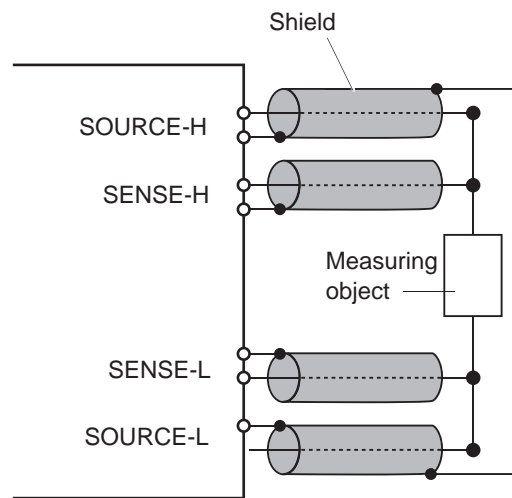

- If you connect the cables together so as to measure the object being measured using the two-terminal connection, you will not be able to obtain the correct measurement values.

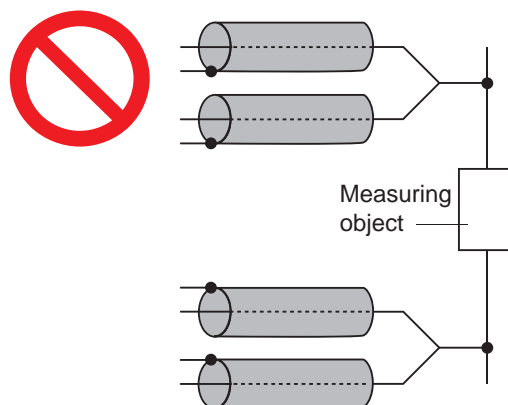

- You must not place the measurement probes near a metal body. In particular, move any portion other than the four-terminal pair structure away from metal bodies. An eddy current produced in a metal body may cause a large error in the measurement value. For details, refer to "Influence of the Eddy Current" (p. A8).

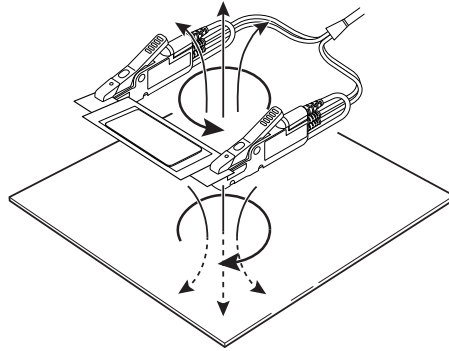

- For the shape and position of the measurement probe, give attention to the points in the Figure shown below. Eddy currents from adjacent metal bodies or exogenous inductive noise may cause errors and variations in the measurement value and worsen the repetitive accuracy. (The following measures can be used to reduce these effects.)

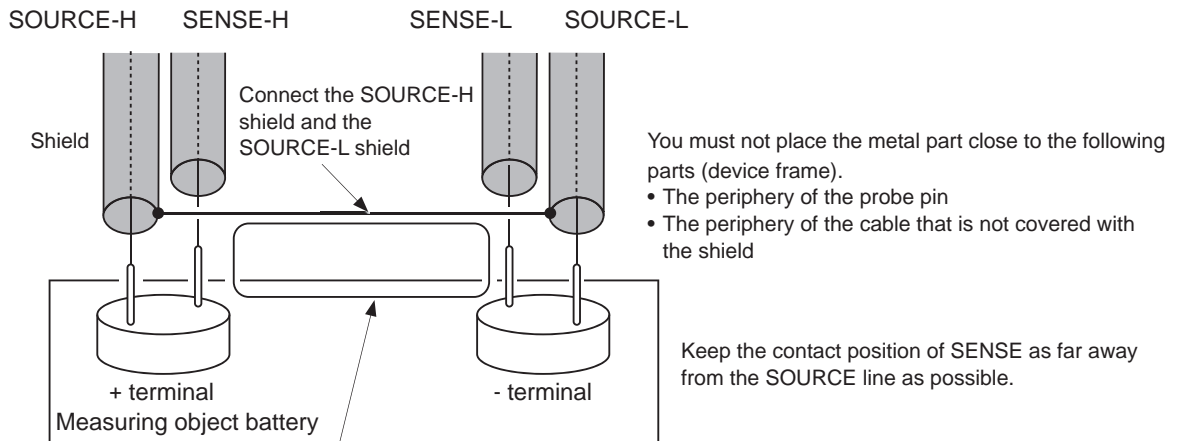

- Make the loop area between the SOURCE shield and the measurement battery as small as possible.
- Set the loop shape and the wiring position (a distance to the metal part of the surrounding inspection device) in the normal condition.
- The wiring cable should be of minimum length. (less than 4 m) A longer wiring cable is easily affected by exogenous inductive noise. The return wiring resistance and the contact resistance must be less than the allowable values respectively.
- Perform zero adjustment before measurement. Perform zero adjustment using the zero adjustment board that corresponds to the terminal spacing.
- You must not use a metal plate (short bar) as the zero adjustment jig. If a metal plate is used, the correct zero adjustment cannot be performed and then a large error will occur in the measurement. For details, refer to “Zero Adjustment” (p. A8).

Set the following to the same conditions as those when measuring.

- Loop area
- Loop shape
- Probe spacing
- Wiring position (distance to the surrounding metal part of a device)

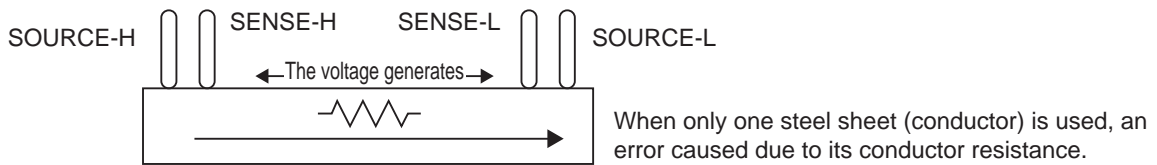
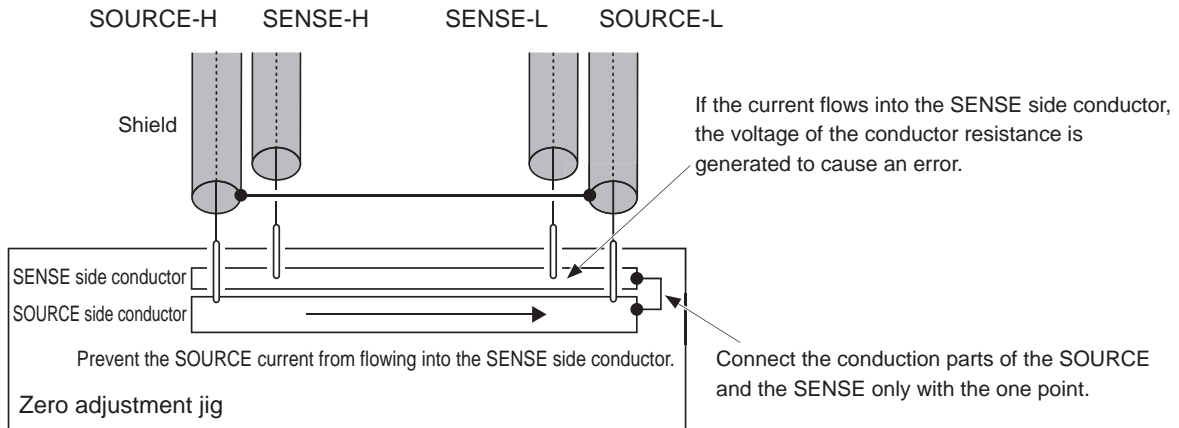

IMPORTANT

- When making the measurement probe by yourself, you must be careful to not cause the short circuit of any signal wire and the short circuit between the core wire and the shield wire.
- To prevent a short circuit, connect the probe terminal to the instrument and then connect the battery.

Appx. 4 Measurement Probe Structure and Extension

We can fill requests for probe extensions as a special order. Contact the distributor (store) from which you purchased the instrument or your nearest Hioki sales office.

Observe the following precautions when extending the measurement probes by yourself.

- Use a thicker lead wire and a minimum length that you can prepare and implement as the extension.
- Extend the measurement probe with the four-terminal pair structure that is unchanged. In the case of the two-terminal structure, the measurement value may be affected by the resistance of wiring and the contact, and the inductive voltage. In the case of the four-terminal structure, the measurement value may be affected by the inductive voltage.
- In parts other than the four-terminal pair structure, use an extension of as small a length as possible.
- Prepare shapes that are as similar as possible during the zero adjustment and the measurement.
- When extended, the measurement probe will have a greater voltage drop in the lead wire. The resistance of the lead wire, including the resistance of the contact, must be kept within the allowable value.
- Keep the measurement probe away from metal parts. When the measurement probe is placed close to a metal body, the measurement may not be correctly done due to the influence of eddy currents.
- After extending the measurement probe, check the operation and the following:
 1. By measuring the zero adjustment board, zero-point accuracy appears.
 2. By measuring the master work (non-defective sample product) and comparing with the management value, the measurement is done properly.

Reduction method of inductive voltage

This instrument is subject to the influence of the inductive voltage because of the measurement of a micro resistance using AC. This inductive voltage means the voltage that is generated by the magnetic induction of the measurement current flowing in the lead wire which may affect the signal system of the measurement. The inductive voltage has a phase difference of 90° from the AC current (reference signal), which can be removed in the synchronous detection circuit theoretically. However, when the inductive voltage is excessive, the signal is distorted, so that the inductive voltage cannot be removed in the synchronous detection circuit. To reduce the inductive voltage, it is important that the measurement probe is as short as possible. It is very effective to shorten the part where the four-terminal pair is not structured.

Appx. 5 Measurement Value in the Four-terminal Measurement (Difference in Measurement Value Due to the Measurement Probe)

For some measuring objects, different measurement values may be obtained depending on the measurement probes used.

These differences between the measurement values are caused by the shapes of the tip and the dimensions of the four-terminal probes used. Accordingly, each of the different measurement values is correct when the corresponding probe is used.

You must use the same measurement probe when comparing the measurement values.

Explanation

The differences between the measurement values depend on the differences between the distances (dimensions) of the pins to which the current is applied, and between the pins that voltage is detected of the measurement probes.

The difference between the measurement values increases as the resistance of the battery terminals increases in comparison to the battery internal resistance.

The figure below shows, as an example, the difference between the detection voltages that are caused by the differences in the space of the probe pins when a large capacity battery was measured.

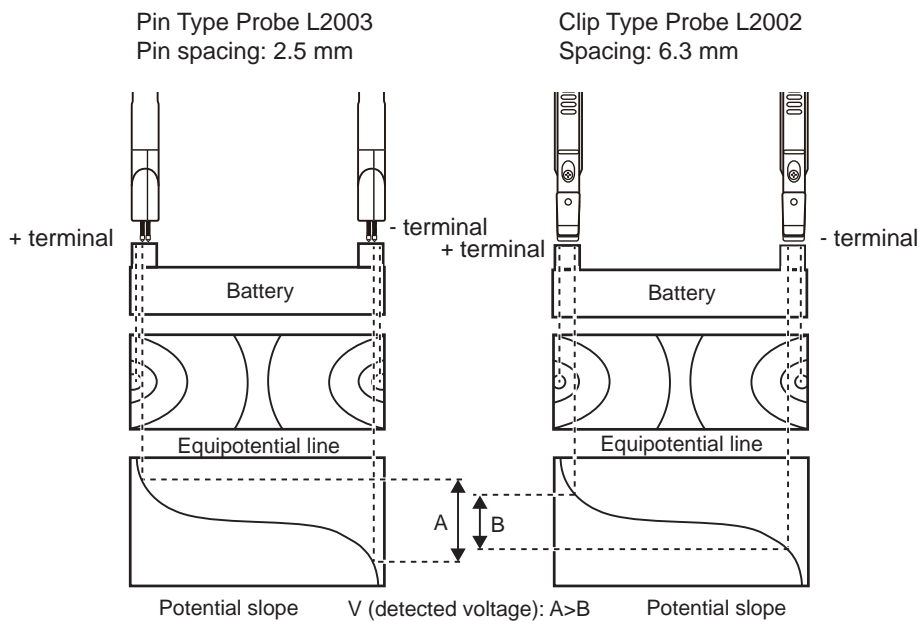

Appx. 6 Influence of the Eddy Current

Measurement close to the metal body causes an eddy current to flow due to the dynamic magnetic field that is generated by the measurement current of the instrument.

This eddy current generates an inductive voltage with a phase opposite to the measurement current in the measurement probe. The inductive voltage generated cannot be removed even in the synchronous detection circuit. Therefore, it may cause a measurement error.

Thus, the measurement instrument using the AC signals needs to take into account the influence of the eddy current.

To suppress the influence of the eddy current, you must not bring the measurement probe without a four-terminal pair structure close to a metal body.

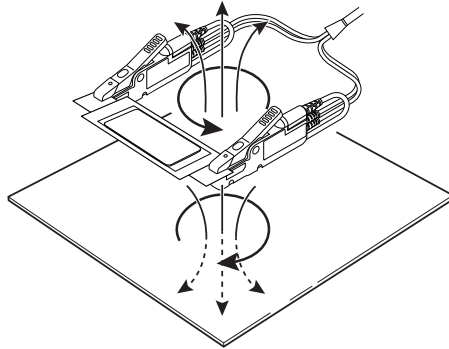

Appx. 7 Zero Adjustment

Zero adjustment is a function that compensates for the value remaining when a resistance 0Ω is measured and then adjusts the zero-point. Thus, zero adjustment must be carried out under conditions where a resistance of 0Ω is connected. However, it is very difficult and impractical to connect a sample that has a zero resistance value.

Accordingly, zero adjustment is actually carried out to adjust the zero-point by creating conditions where a pseudo resistance of 0Ω is connected.

To create the conditions where a pseudo resistance of 0Ω is connected:

When the ideal resistance of 0Ω is connected, from the relational expression of Ohm's law $E=I \times R$, the voltage between SENSE-H and SENSE-L becomes 0 V . That is, if the voltage between the SENSE-H and the SENSE-L is made to be 0 V , the same conditions as when a resistance of 0Ω is connected can be created.

When performing zero adjustment with this instrument:

This instrument monitors the condition of the spaces of the four measurement terminals by the measurement fault detection function. Accordingly, zero adjustment needs to be properly connected to each space of the terminals. (Figure. Conditions Where a Pseudo Resistance of 0Ω is Connected)

First, create a short-circuit between SENSE-H and SENSE-L to cause the voltage between SENSE-H and SENSE-L to be 0 V . If the wiring resistance of the cable being used $R_{\text{SEH}}+R_{\text{SEL}}$ is less than several Ω , the resistance of the wiring can be ignored. The explanation is as follows. The SENSE terminals are the voltage measurement terminals, and thus the current I_0 is ignored. In the relational expression, $E=I_0 \times (R_{\text{SEH}}+R_{\text{SEL}})$, $I_0 \approx 0$. When the resistance of wiring $R_{\text{SEH}}+R_{\text{SEL}}$ is several Ω , the voltage between SENSE-H and SENSE-L becomes almost zero.

Next, connect the spacing between SOURCE-H and SOURCE-L.

This prevents an error display when the measurement current cannot be flown. The wiring resistance of the cable used $R_{\text{SOH}}+R_{\text{SOL}}$ must be less than the resistance value with which the measurement current can flow. In addition, when monitoring the connection condition between SENSE and SOURCE, the spaces between SENSE and SOURCE must be connected. If the wiring resistance of the cable used R_{short} is approximately several Ω , the cable is acceptable.

The above wiring makes the measurement current I that flows out from SOURCE-H flow into SOURCE-L, and thus prevents the measurement current that flows out from SOURCE-H from flowing into the wiring of SENSE-H and SENSE-L. Consequently, the voltage between SENSE-H and SENSE-L can be maintained accurately at 0 V and zero adjustment can be performed.

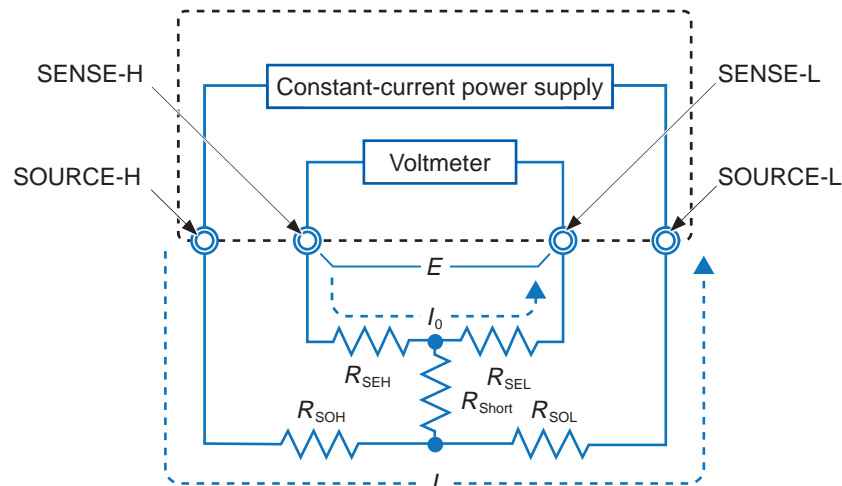

$$\begin{aligned}
 E &= (I_0 \times R_{SEL}) + (I_0 \times R_{SEH}) \\
 &= (0 \times R_{SEL}) + (0 \times R_{SEH}) \\
 &= 0 \text{ [V]}
 \end{aligned}$$

Figure. Conditions where a pseudo 0 Ω is connected

To properly carry out the zero adjustment:

“Table. Connection Method” illustrates the correct connection method and the incorrect connection method. The resistances in the figure show the wiring resistances, and these are ignored if they are less than several Ω respectively.

As shown in (a), when connecting respectively SENSE-H and SENSE-L, and SOURCE-H and SOURCE-L, and then connecting the SENSE and the SOURCE with one path, there is no voltage potential difference produced between SENSE-H and SENSE-L, and thus, a voltage of 0 V is applied. This connection method performs the correct zero adjustment.

However, as illustrated (b), when connecting respectively SENSE-H and SOURCE-H, and SENSE-L and SOURCE-L, and then connecting the Hi-side and the Lo-side with one path, there is a voltage potential difference of $I \times R_{Short}$ between SENSE-H and SENSE-L. Thus, the connection method does not create conditions where a pseudo resistance of 0 Ω is connected, and thus, does not perform the correct zero adjustment.

Table. Connection method

	(a) Connecting the spaces between SENSE and SOURCE with one point respectively	(b) Connecting the spaces between the Hi-side and the Lo-side respectively.
Resistance between SENSE-H and SENSE-L	$R_{SEH} + R_{SEL}$	$R_{SEH} + R_{Short} + R_{SEL}$
Path where the measurement current I flows	$R_{SOH} \rightarrow R_{SOL}$	$R_{SOH} \rightarrow R_{Short} \rightarrow R_{SOL}$
Voltage produced between SENSE-H and SENSE-L	0	$I \times R_{Short}$
As the connection method when performing the zero adjustment	Correct	Incorrect

When performing zero adjustment using the zero adjustment board of an accessory:

When performing zero adjustment, you must not use a metal plate in substitution for the attached zero adjustment board. The zero adjustment board is structured to connect between the SENSE terminals and the SOURCE terminals with one point. When performing zero adjustment of the optional L2002 Clip Type Probe and the L2003 Pin Type Probe, the zero adjustment board is used.

The equivalent circuits when connecting to the zero adjustment board and to a metal plate are shown in Table. Connection method when performing zero adjustment. When connecting using the zero adjustment board, the connection is the same as shown in the Connection Method table (a). Thus, the voltage between SENSE-H and SENSE-L becomes 0 V. However, when connected using metal, the connection is the same as shown in the Connection Method table (b). The voltage between SENSE-H and SENSE-L is thus not 0 V.

	(a)	(b)
Connection method	<p>L2002</p> <p>Zero adjustment board</p> <p>L2003</p> <p>Zero adjustment board</p>	<p>L2002</p> <p>Metallic plate</p> <p>L2003</p> <p>Metallic plate</p>
Equivalent circuit		
Detailed equivalent circuit		
As the connection method when performing the zero adjustment	Correct	Incorrect

Appx. 8 Measurement Probe (Option)

L2002 Clip Type Probe

Total length: Approx. 1500 mm

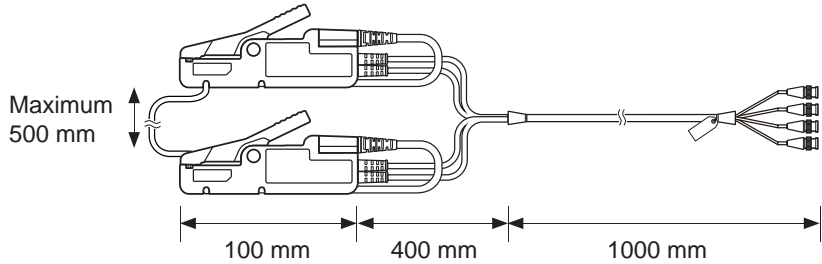

1. Arrange the probes so that the distance between the SENSE of the probes is the same as the actual object to be measured with the SENSE of the probes (both red and black) facing inwards.
2. Adjust the position of the probes such that the return cable between the probes does not sag, and fix by pushing the return cable into the grooves of the probes.

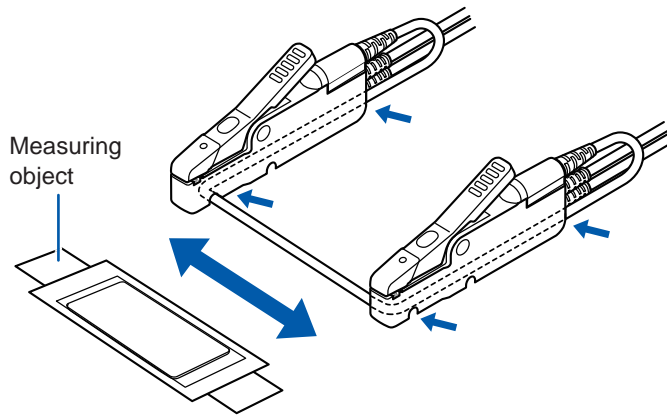

L2003 Pin Type Probe

Total length: Approx. 1490 mm

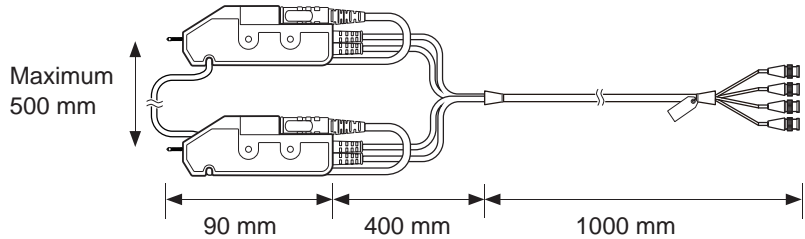

1. Arrange the probes so that the distance between the pin tips of the probe is the same as that between the terminals of the actual measuring object, with the SENSE sides of the probes (both red and black) facing inwards.
2. Adjust the position of the probes such that the return cable between the probes does not sag, and fix by pushing the return cable into the grooves of the probes.

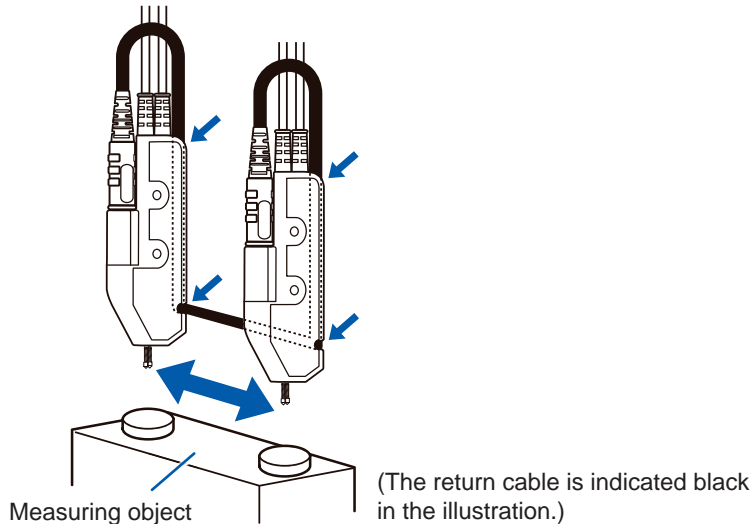

Appx. 9 Precautions When Making the Switching Unit

When placing the switching unit between the instrument and the measuring object, you must make the switching unit with the four-terminal pair connection. Here, when making the switching unit, precautions including performing the four-terminal pair connection are described.

This instrument has the measurement terminals with the four-terminal pair connection structure. (Figure. Four-Terminal Pair Connection Structure) This four-terminal pair connection structure prevents the magnetic field created by the measurement current from generating and suppresses an inductive electromotive force to the voltage measurement terminals. The inductive electromotive force becomes noise to the measurement voltage, which must be suppressed as much as possible. The inductive electromagnetic force also must be suppressed in the switching unit.

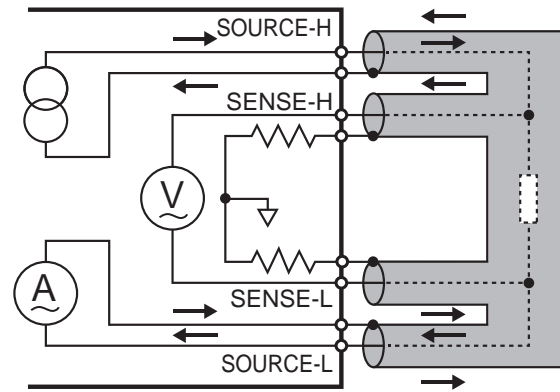

Figure. Four-terminal pair connection structure

Observe the following methods to suppress the inductive electromotive force.

- The loop area formed by the flow-out wire (core wire) and the flow-in wire (shield wire) of the SOURCE-H terminal must be as small as possible.
- The loop area formed by the flow-in wire (core wire) and the flow-out wire (shield wire) of the SOURCE-L terminal must be as small as possible.
- The loop area made by the detection wire (core wire) of the SENSE-H terminal and the detection wire (core wire) of the SENSE-L terminal must be as small as possible.
- The loop formed by the SOURCE wires and the loop formed by the SENSE wires must be kept away from each other.
- The loop formed by the SOURCE wires and the loop formed by the SENSE wires must not be face each other.

The relays that are used in the switching unit must observe the following.

- For the relays, 2a or 2c contact type must be used, and the area of each loop must be as small as possible.
- The relays with the rated current that exceeds the measurement current of this instrument (the maximum current is 2.12 A at the measurement current 1.5 Arms) must be used to change over the SOURCE terminals.
- For changing over the SENSE terminals, the latching relays must be used to suppress the effect of the inductive electromagnetic force.
- Furthermore, for changing over the SENSE terminals, the relays with the Au clad cross-bar twin contact type or AgPd contact type must be used to ensure the reliability of the relay contacts.

Integrating the above points, the Pattern layout examples (in the case of the single-sided board) of the switching unit figure is shown. When designing the patterns with two or more layers, the loop can be minimized by layering a pair of patterns over it. (Figure. Pattern Layout Examples of the Switching Unit (in the case of the substrate with the two or more layers))

When wiring with electrical wires, the loop can be reduced by twisting a pair of electrical wires. (Figure. The Wiring Examples of the Switching Unit (when connecting using electrical wires))

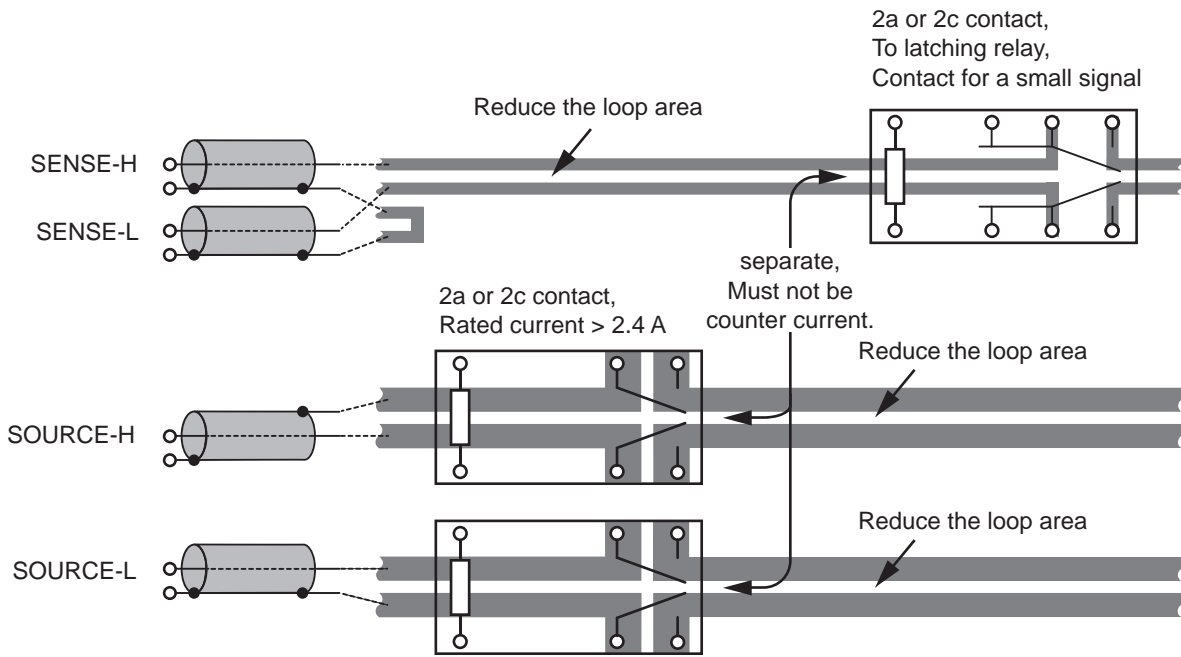

Figure. The pattern layout examples of switching unit (in the single sided board)

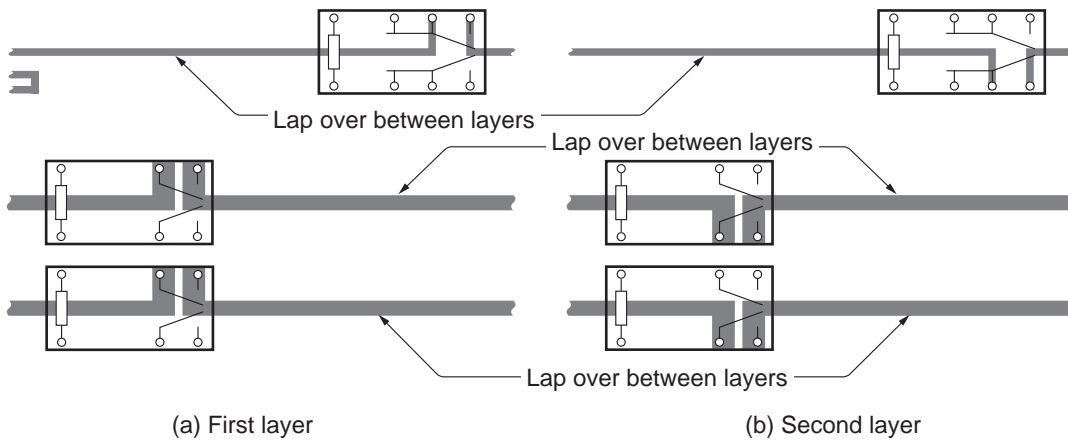

Figure. Pattern layout examples (in the case of the substrate with two or more layers)

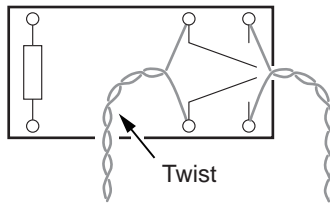
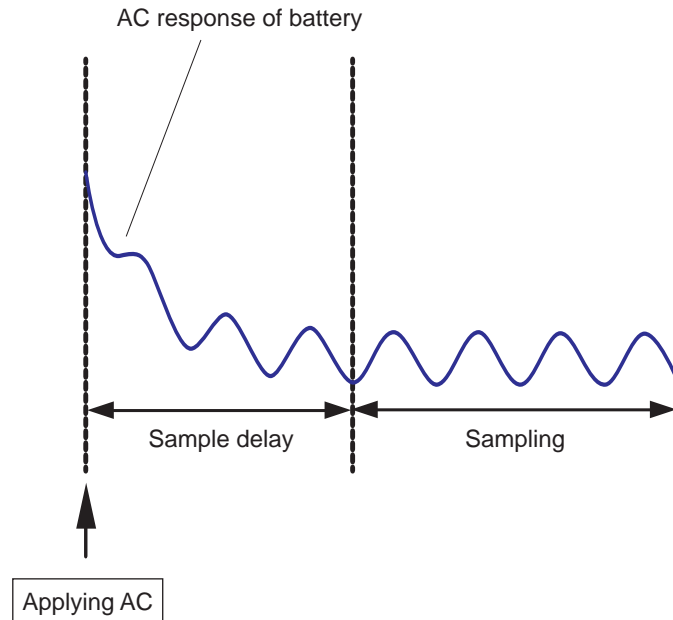

Figure. Wiring example of the switching unit (in the case of wiring the electrical wires)

Appx. 10 Precautions When Measuring the Battery

The stability of AC response

When measuring the impedance, the response may not stabilize immediately after AC is applied. The sampling using the sample delay function after the AC response is stabilized enables one to measure the impedance accurately.



Adjusting SOC (State Of Charge)

The impedance of the battery may vary depending on its SOC. The impedance has a remarkable tendency to vary when the measurement is performed at low frequency. Thus, the SOC must be adjusted. Generally, the proper SOC is within 30% to 80%.

Caution on connections

This L terminal of the instrument is controlled to keep its potential at the ground potential. (Imaginary grounding)

If applying an input to the L terminal which provides the L terminal has a potential to the ground, the circuit may be broken. Do not connect equipment other than the instrument during measurement. There is a risk of circuit damage due to improper grounding of equipment. Refer to the following figure.

Cases that cannot be measured

If the voltage exceeds 5 V

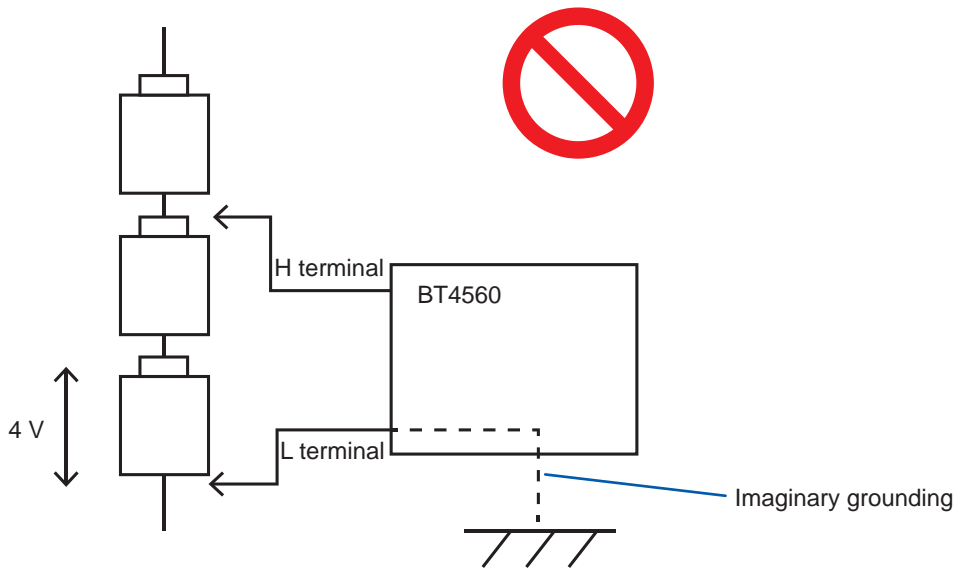

In case of measuring the cell that has been grounded

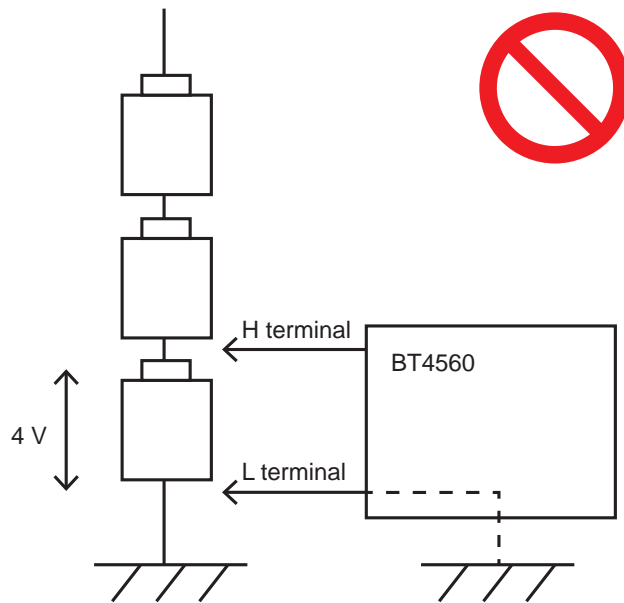

In case of connecting devices other than this instrument

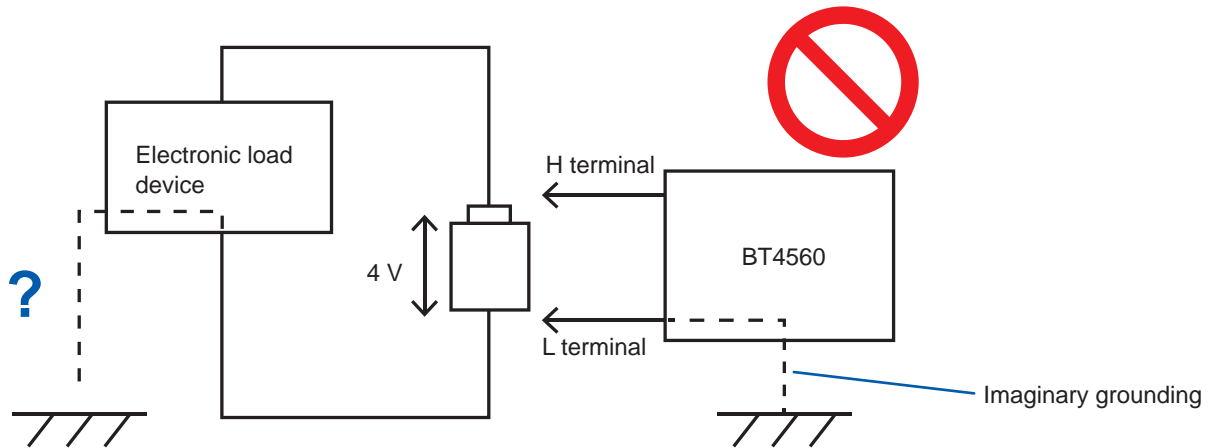

When instruments to be grounded are internally grounded or when capacitance between groundings is large.

Cases that can be measured

If battery modules have not been connected

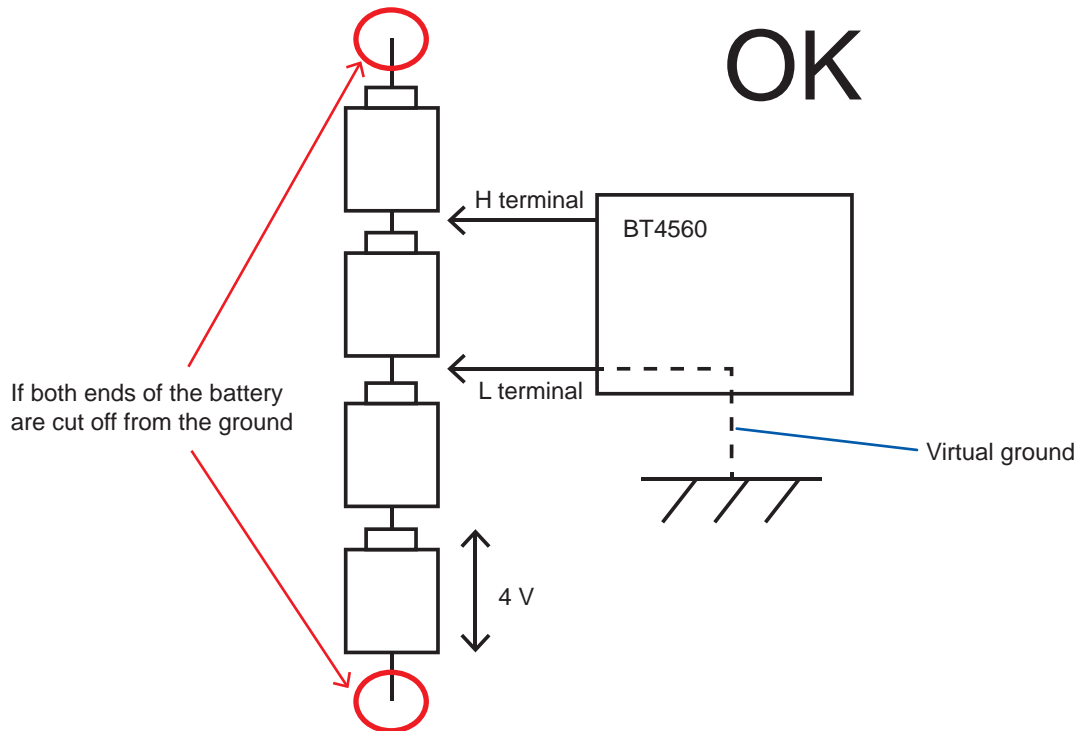

Appx. 11 Calibrating the Instrument

For the calibration environment, refer to the accuracy guarantee conditions (p. 112).

Calibrating impedance measurement

- Use a standard resistor with non-aged degradation and good temperature characteristics.
- Use a resistor that enables one to configure the four-terminal pair structure, to not be subject to the effect of the lead wires of the resistor.
- For connection between this instrument and the standard resistor, refer to the figure shown below.

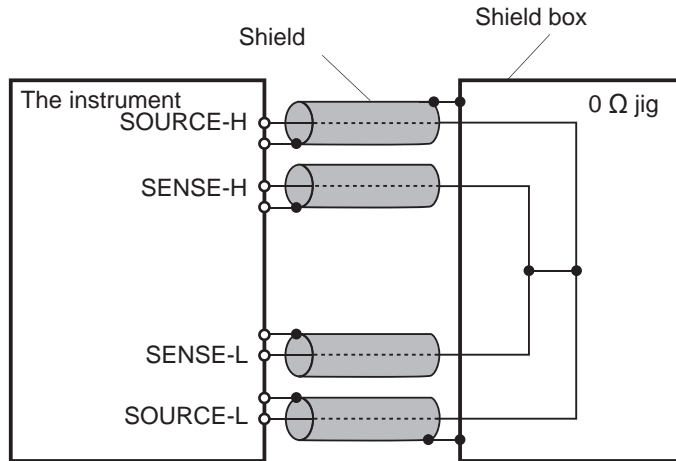

Figure. Calibrating 0 Ω

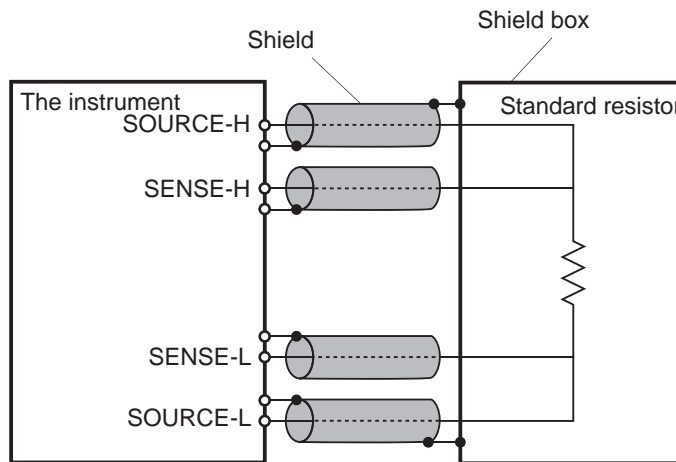

Figure. Connecting to the standard resistor

Contact your authorized Hioki distributor or reseller for standard resistor to be used for impedance calibration.

Calibrating voltage measurement

- Use a generator that can output 7 V DC.
- For the connection between this instrument and the generator, refer to Figure illustrated below.
- You must not input the AC current of this instrument to the generator. This may cause a malfunction of the generator.
- Use the generator with a low output impedance.
- Some of generators may not operate normally.

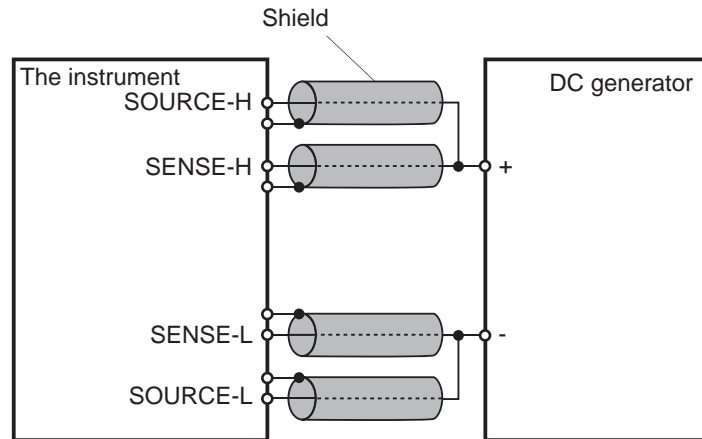

Figure. Connection to the generator

Calibrating temperature measurement

- Calibrate the standard resistor with Pt100 IEC Class A or equivalent.
- For the connection between this instrument and the generator, refer to Figure illustrated below.
- You must use the wiring resistance of both ways less than 10 Ω .
- Use the connection terminals of $\phi 3.5$ four-terminal structure (For the four-pole signal cable, refer to Figure illustrated below.)

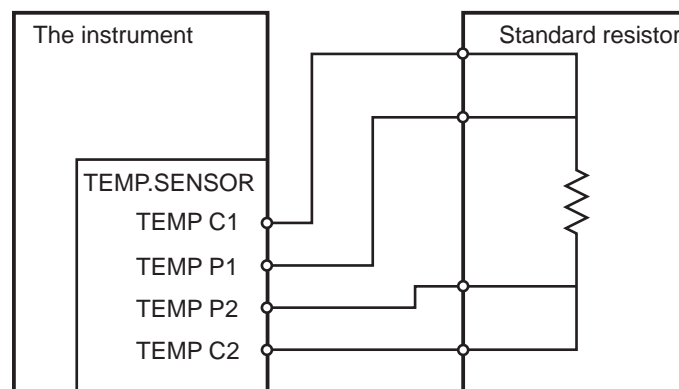

Figure. Connecting to the standard resistor

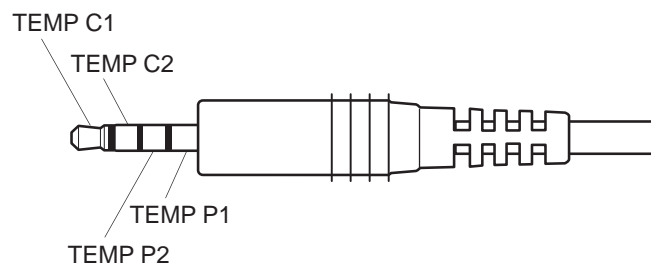

Figure. Connection terminal's structure

Appx. 12 Rack Mounting

By removing the screws on the sides, this instrument can be installed in a rack mounting plate.

⚠ WARNING



Use the screws that are mounted during shipment to avoid instrument damage and electric shock accidents. (Standard: M3 × 6 mm, sides: M4 × 6 mm, when installing rack mounting bracket: M4 × 10 mm)
If screws are lost or damaged, contact your authorized Hioki distributor or reseller.

Rack Mounting Plate (EIA)

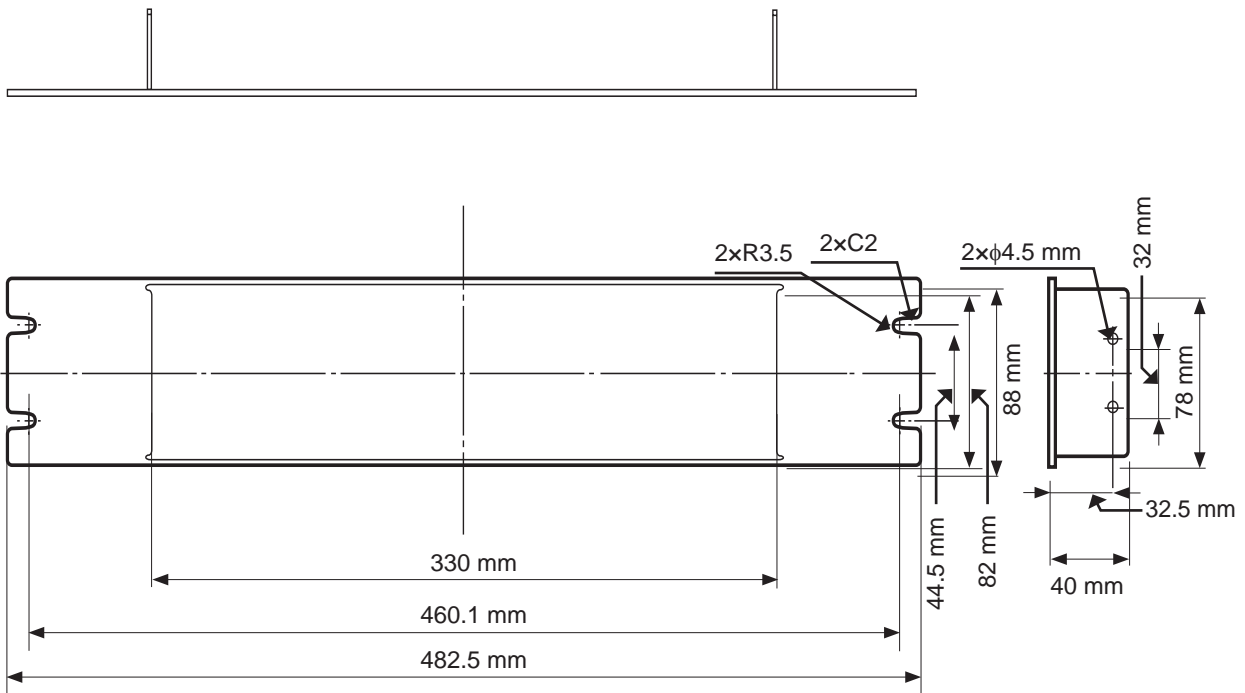

Rack Mounting Plate (JIS)

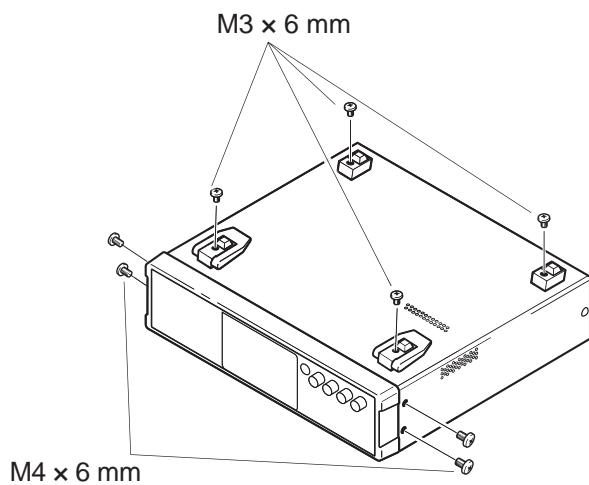
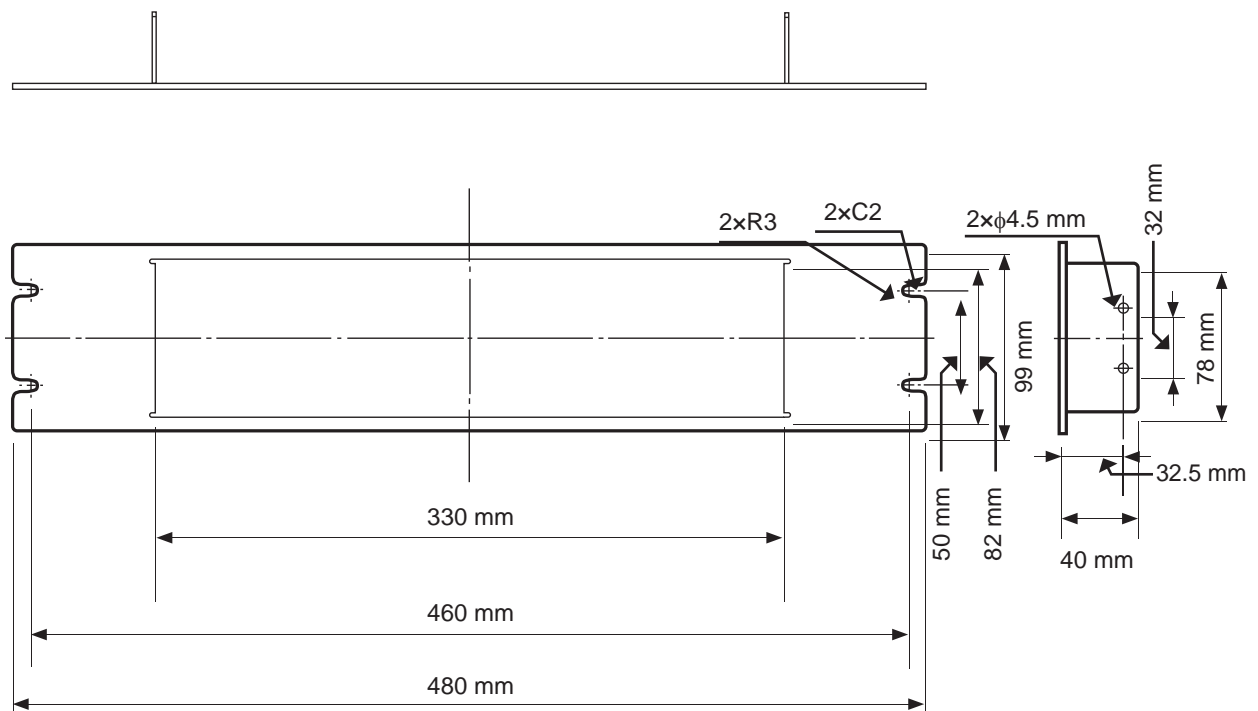

1 Remove the feed from the bottom of the instrument, and the screws from the sides (four near the front).

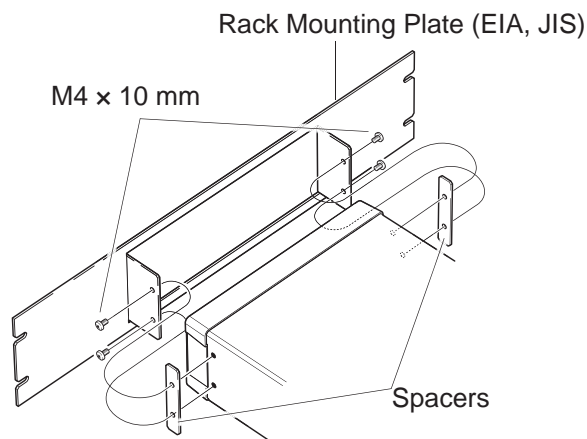

2 Installing the spacers on both sides of the instrument, affix the Rack Mounting Plate with the M4 x 10 screws.

- When installing into the rack, reinforce the installation with a commercially available support stand.
- Ensure that the vents on the sides, rear, and bottom are not blocked.

Appx. 13 Dimensional Diagram

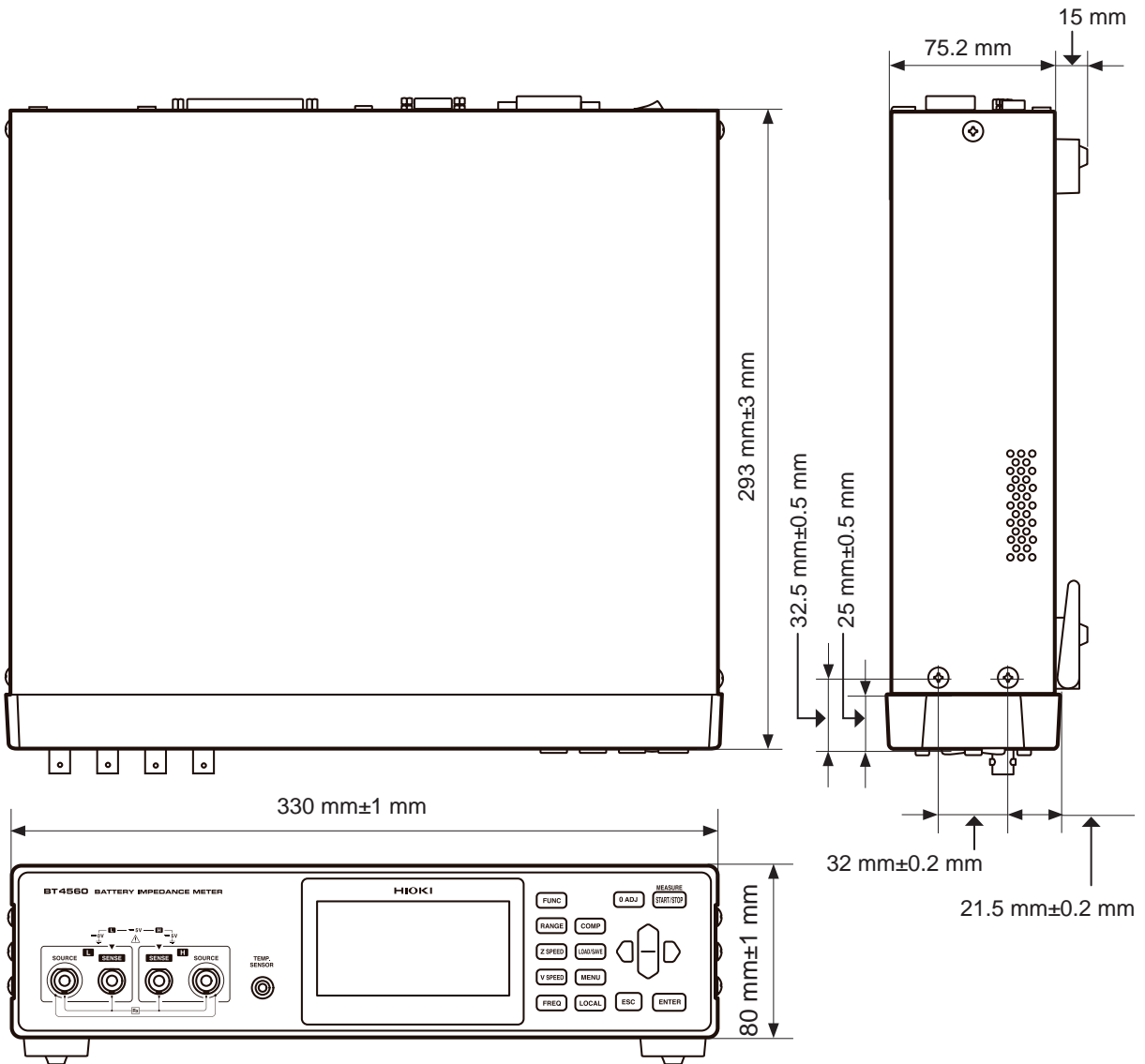

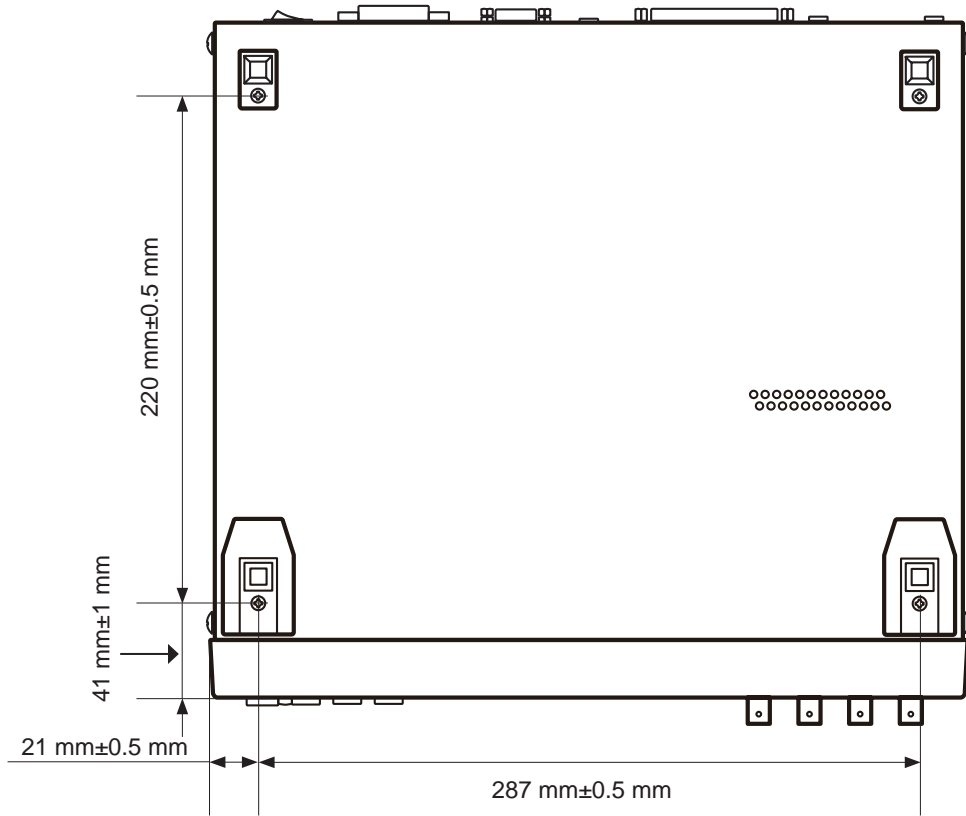

Index

A

Absolute value	49, 54
Accessory/Accessories.....	116
Accuracy.....	112
Average function.....	42

B

Backlight.....	67
Battery measurement	
Precaution point	A15
BT4560	1

C

Calibration	A18
Cleaning	123
Command.....	95, 100
Comparator function	
OFF.....	50
ON.....	50
Confirming the sound.....	55
Upper and lower limit value.....	51
Judgment result.....	56
Connect	
Four-terminal cable	18
Temperature sensor	18
Power cord.....	17
Connection	
Performing.....	26
Failure	26
Setting.....	28
Measurement abnormality detection.....	26
Contact error.....	30
Measurement current abnormality	30
Measurement frequency	30
Current sink (NPN).....	80
Current source (PNP).....	80

D

Dimensional Diagram	A22
Discarding.....	124
Display.....	12

E

Eddy current	A8
Error display and Remedy.....	121
EXT I/O NPN/PNP switch.....	12
EXT I/O terminal.....	12
EXT.I/O test functions.....	94

F

Four-terminal pair method	A2
---------------------------------	----

I

Impedance measurement (Z)	23
Voltage measurement (V)	23
Measurement functions.....	23
Initializing	
NORMAL.....	74
SYSTEM	74
Initial testing table.....	76
Input signal	82, 83
Installation	7
Internal circuitry	91
Connection examples.....	93
Electrical specifications.....	92

J

Judgment result.....	56
----------------------	----

K

Key operating sound	
OFF	65
ON.....	65
Key operation	
Ineffective.....	63
Effective	63

L

Lithium Battery.....	124
----------------------	-----

M

Manufacturer's serial number	12
Measurement example.....	21
Measurement probe	A12
Extension	A6
Self-make.....	A4
Measurement range	33
Measurement screen.....	15
Measurement Signal Zero Cross Stop Function.....	47
Measurement speed.....	24
Measurement terminal.....	12

O

Operating keys	12, 14
Operational expression.....	A1
Option	2, 116
Output signal	83
Overrange indication	32

P

Panel loading function	60
Panel saving function	58
Power cord	17
Power inlet.....	12
Power supply	
Turn on.....	19
Turn off.....	19
Power switch	12
Pre-operation inspection.....	19
Progress bar	25

Q

Q&A.....	117
----------	-----

R

Rack mounting.....	A20
replacement pars.....	123
Reset	74
RS-232C Interface.....	12
Specifications.....	95
Use.....	98

S

Sample delay function	38
Screen configuration.....	15
Screen contrast	66
Self-calibration function	41
Setting	
Measurement speed	23
Zero adjustment	22
Setting conditions	
Deleting.....	61
Saving	58
Reading out.....	60
Setting screen.....	15
Slope Correction Function.....	43
Specifications	101
Stand.....	13
Switching unit	A13
System test.....	68
I/O TEST	68
KEY TEST.....	69
LCD TEST.....	70
ROM TEST.....	71

T

Temperature sensor terminal.....	12
Test lead	22
Timing chart.....	84
Trigger function.....	37
Input external trigger	37
Setting.....	37

U

USB Interface	12
Specifications.....	95
Use.....	96

V

Vent	12
Voltage limit function.....	45

Z

Zero adjustment.....	A8
----------------------	----

Warranty Certificate

Model	Serial No.	Warranty period One (1) year from date of purchase (___ / ___)
-------	------------	---

This product passed a rigorous inspection process at Hioki before being shipped.

In the unlikely event that you experience an issue during use, please contact the distributor from which you purchased the product, which will be repaired free of charge subject to the provisions of this Warranty Certificate. This warranty is valid for a period of one (1) year from the date of purchase. If the date of purchase is unknown, the warranty is considered valid for a period of one (1) year from the product's date of manufacture. Please present this Warranty Certificate when contacting the distributor.

Accuracy is guaranteed for the duration of the separately indicated guaranteed accuracy period.

1. Malfunctions occurring during the warranty period under conditions of normal use in conformity with the Instruction Manual, product labeling (including stamped markings), and other precautionary information will be repaired free of charge, up to the original purchase price. Hioki reserves the right to decline to offer repair, calibration, and other services for reasons that include, but are not limited to, passage of time since the product's manufacture, discontinuation of production of parts, or unforeseen circumstances.
2. Malfunctions that are determined by Hioki to have occurred under one or more of the following conditions are considered to be outside the scope of warranty coverage, even if the event in question occurs during the warranty period:
 - a. Damage to objects under measurement or other secondary or tertiary damage caused by use of the product or its measurement results
 - b. Malfunctions caused by improper handling or use of the product in a manner that does not conform with the provisions of the Instruction Manual
 - c. Malfunctions or damage caused by repair, adjustment, or modification of the product by a company, organization, or individual not approved by Hioki
 - d. Consumption of product parts, including as described in the Instruction Manual
 - e. Malfunctions or damage caused by transport, dropping, or other handling of the product after purchase
 - f. Changes in the product's appearance (scratches on its enclosure, etc.)
 - g. Malfunctions or damage caused by fire, wind or flood damage, earthquakes, lightning, power supply anomalies (including voltage, frequency, etc.), war or civil disturbances, radioactive contamination, or other acts of God
 - h. Damage caused by connecting the product to a network
 - i. Failure to present this Warranty Certificate
 - j. Failure to notify Hioki in advance if used in special embedded applications (space equipment, aviation equipment, nuclear power equipment, life-critical medical equipment or vehicle control equipment, etc.)
 - k. Other malfunctions for which Hioki is not deemed to be responsible

***Requests**

- Hioki is not able to reissue this Warranty Certificate, so please store it carefully.
- Please fill in the model, serial number, and date of purchase on this form.

13-09

<p>HIOKI E.E. CORPORATION 81 Koizumi, Ueda, Nagano 386-1192, Japan TEL: +81-268-28-0555 FAX: +81-268-28-0559</p>	
--	--

- Please visit our website at <http://www.hioki.com> for the following:
 - Regional contact information
 - The latest revisions of instruction manuals and manuals in other languages.
 - Declarations of Conformity for instruments that comply with CE mark requirements.
- All reasonable care has been taken in the production of this manual, but if you find any points which are unclear or in error, please contact your supplier or the International Sales and Marketing Department at Hioki headquarters.
- In the interests of product development, the contents of this manual are subject to revision without prior notice.
- The content of this manual is protected by copyright.
No reproduction, duplication or modification of the content is permitted without the authorization of Hioki E.E. Corporation.

HIOKI

HIOKI E. E. CORPORATION

Headquarters

81 Koizumi, Ueda, Nagano 386-1192, Japan
TEL +81-268-28-0562 FAX +81-268-28-0568
E-mail: os-com@hioki.co.jp
(International Sales and Marketing Department)

<http://www.hioki.com/>

HIOKI USA CORPORATION

E-mail: hioki@hiokiusa.com <http://www.hiokiusa.com>

HIOKI (Shanghai) Sales & Trading Co., Ltd.

E-mail: info@hioki.com.cn <http://www.hioki.cn>

HIOKI INDIA PRIVATE LIMITED

E-mail: hioki@hioki.in <http://www.hioki.in>

HIOKI SINGAPORE PTE. LTD.

E-mail: info@hioki.com.sg

1407