

# HIOKI

CURRENT SENSOR Series  
CURRENT PROBE Series

NEW



## Application-optimized Current Sensors and Current Probes



## Application-optimized current sensors and current probes

Hioki offers lineup of current sensors and current probes to accommodate current measurement requirements in a variety of applications, from development and evaluation in advanced fields to quality control of commercial power supplies.



### Evaluating power conversion efficiency in EVs

Evaluate vehicles' overall power conversion efficiency in order to develop automobiles that run further with less energy.

**CT6904A, CT687x series + PW8001**



### Evaluating the fuel (energy) efficiency of finished vehicles

Measure fuel efficiency based on the international standard (WLTP) in order to evaluate the fuel efficiency of finished vehicles.

**CT684x-05 series + PW3390**

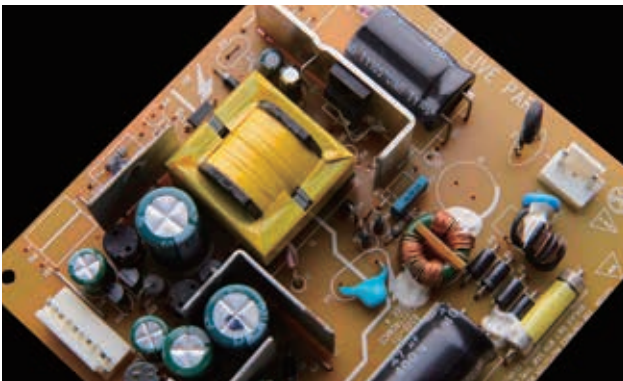

### Evaluating power devices in power supply circuits

Observe the inputs and outputs of the current waveform in order to evaluate whether power devices are providing the required level of performance.

**CT67xx series, 327x series + MR6000**



### Evaluating systems used to control accessory components in automobiles

Observe current waveforms of various magnitudes that fluctuate depending on the state of the device in question, including dark current, inrush current, and drive current, in order to evaluate accessory control.

**CT67xx series, 327x series + MR6000**



### Maintaining power quality

Continuously monitor power quality and analyze the causes of power supply issues in order to maintain stable power quality.

**CT7xxx series, CT9667-0x series + PQ3198, PQ3100**



### Assessing the power consumption of equipment and systems

Assess the power consumption of devices and systems in order to pursue energy-saving activities and achieve the goals of the UN's Sustainable Development Goals (SDGs).

**CT7xxx series, CT9667-0x series + PW3365**

## Applications by operating current and operating frequency

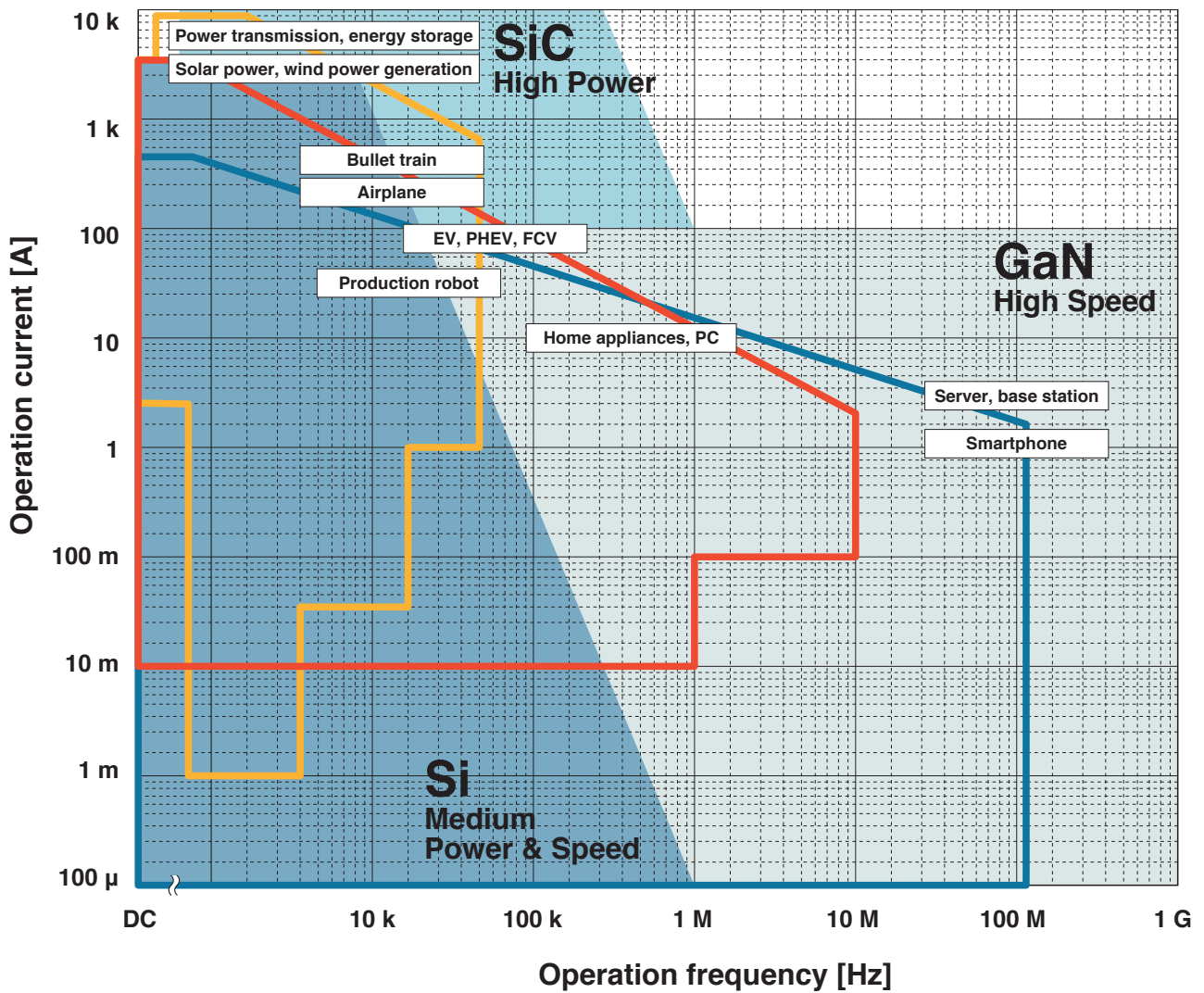

|                            |  |                                   |  |
|----------------------------|--|-----------------------------------|--|
| High-accuracy measurement  |  | pass-through types                | - EV inverter systems R&D<br>- Assessment of reactor and transformer losses  |
|                            |  | clamp types                       | - WLTP-compliant fuel economy (electricity cost) performance testing   |
| Waveform observation       |  | High-sensitivity observation      | - Evaluation of automotive accessory control<br>- Evaluation of power components in power supply circuits  |
|                            |  | Observation of minuscule currents | - Evaluation of automotive accessory control<br>- Development and evaluation of power-saving devices such as wearables                           |
|                            |  | Observation of large currents     | - Fluctuations in fluctuation of load currents of large industrial equipment<br>- Measurement of inrush currents flowing when starting an engine |
| Grid power quality control |  | Measurement of load currents      | - Assessment of power consumption<br>- Periodic inspection of power supply equipment and monitoring of power quality                             |
|                            |  | Measurement of large currents     |  |
|                            |  | Measurement of leakage currents   | - Detection of intermittent electrical leaks<br>- Search for the locations of electrical leaks   |

# Current Sensors Current Probes Lineup

Hioki's first current sensor was a magnetic current sensor developed in-house in 1971. We've pursued sensing technologies over the past 50 years, providing a variety of current sensors for the full range of measurement applications.

## High-accuracy measurement

These models, rated for 20 A to 2000 A, measure currents in a frequency band from DC to 10 MHz with a high degree of accuracy. They're used in applications that require high measurement accuracy, for example evaluation of inverter equipment and evaluation of loss in reactors and transformers.

## Pass-through types

Pass-through sensors deliver the ultimate level of accuracy and stability. With a broadband measurement at up to 10 MHz and measurement of large currents of up to 2000 A, they're used in state-of-the-art research and development.

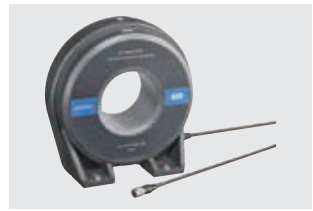

### EV inverter system R&D

Evaluation of reactor and transformer losses

## Clamp types

Clamp-type sensors are quick and easy to connect, and used for testing finished products, an application where it is difficult to cut wires. Capable of functioning at temperatures from  $-40^{\circ}\text{C}$  to  $85^{\circ}\text{C}$ , they're used in high-temperature environments such as engine compartments.



### WLTP-compliant fuel economy

(electricity cost) performance testing

## Direct-wired types

Directly wired current sensors deliver world-class accuracy and frequency band characteristics (50 A model) by Hioki's proprietary DCCT (Direct Connection Current Transducer) method



Evaluation of reactor and transformer losses

Evaluation of inverters in energy-saving household appliances

## Waveform observation

These models, rated from 0.5 A to 500 A, measure current waveforms in a frequency band of DC to 120 MHz. They're used to analyze fluctuations during operation of various types of equipment operation, including standby current, inrush current, load current, and control current.

## Grid power quality control

These models are engineered primarily to measure current at commercial frequencies (50/60 Hz). They're used in applications such as power quality checks and power consumption assessments. We offer models with specifications suitable for a range of measurement locations, from leakage currents to large currents.

## High-sensitivity observation

These models can measure current waveforms that range in magnitude from minuscule to large. With the high-sensitivity ranges and an output rate of 10 V/A, minuscule currents that fluctuate at high speeds can be clearly observed.

## Measurement of load current

These sensors are primarily designed to measure commercial power supplies. They're used to monitor and analyze power quality and to measure power consumption.



**Evaluation of automotive accessory control**

**Evaluation of power devices in power supply circuits**

**Assessment of power consumption**

**Periodic inspection of power supply equipment and monitoring of power quality**

## Observation of minuscule currents

These models can measure minuscule current waveforms, including control currents flowing in control circuits and fluctuations in the current consumption of compact electronic devices that operate at small currents.

## Measurement of large currents

These sensors can measure large currents of up to 6000 A. Their slim, flexible form make them easy to insert into narrow gaps and between wires.

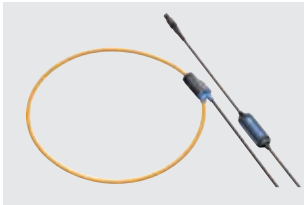

**Evaluation of automotive accessory control**

**Development and evaluation of power-saving devices such as wearables**

**Assessment of power consumption**

**Periodic inspection of power supply equipment and monitoring of power quality**

## Observation of large currents

These models can measure large current waveforms, including fluctuations in load current from the operation of industrial equipment and inrush currents when power supplies are activated.

## Measurement of leakage currents

These sensors are used to measure minuscule currents such as leakage currents.



**Fluctuations of load currents of large industrial equipment**













**Measurement of inrush currents flowing at engine start**

**Detection of intermittent electrical leaks**

**Search for the locations of electrical leaks**

**High-accuracy measurement** Output terminals: ME15W

**Pass-through types**

|                  |  |   |  |  |
|------------------|--|---|--|--|
| 50 A             | <br>φ24 mm (0.94 in.)   | <br>φ24 mm (0.94 in.) <b>NEW</b> |  |  |
|                  | 50 A<br>DC to 1 MHz<br>CT6862-05   | 50 A<br>DC to 10 MHz<br>CT6872, CT6872-01   |  |  |
| 200 A            | <br>φ24 mm (0.94 in.)   | <br>φ24 mm (0.94 in.) <b>NEW</b> |  |  |
|                  | 200 A<br>DC to 500 kHz<br>CT6863-05  | 200 A<br>DC to 10 MHz<br>CT6873, CT6873-01  |  |  |
| 500 A            | <br>φ36 mm (1.42 in.)   | <br>φ36 mm (1.42 in.)            | <br>φ32 mm (1.26 in.)   | <br>φ32 mm (1.26 in.) |
|                  | 500 A<br>DC to 2 MHz<br>CT6875A  | 500 A<br>DC to 1.5 MHz<br>CT6875A-1   | 500 A<br>DC to 4 MHz<br>CT6904A  | 500 A<br>DC to 2 MHz<br>CT6904A-1  |
|                  | 800 A  | <br>φ32 mm (1.26 in.)          | <br>φ32 mm (1.26 in.) |  |
|                  |  | 800 A<br>DC to 4 MHz<br>CT6904A-2   | 800 A<br>DC to 2 MHz<br>CT6904A-3  |  |
| 1000 A<br>2000 A | <br>φ36 mm (1.42 in.) | <br>φ36 mm (1.42 in.)          | <br>φ80 mm (3.15 in.) |  |
|                  | 1000 A<br>DC to 1.5 MHz<br>CT6876A   | 1000 A<br>DC to 1.2 MHz<br>CT6876A-1  | 2000 A<br>DC to 1 MHz<br>CT6877A, CT6877A-1  |  |

**Clamp types**

|                                     |  |  |  |
|-------------------------------------|--|--|--|
| 20 A<br>200 A                       | <br>φ20 mm (0.79 in.) | <br>φ20 mm (0.79 in.) | <br>φ46 mm (1.81 in.) |
|                                     | 20 A<br>DC to 1 MHz<br>CT6841-05   | 200 A<br>DC to 500 kHz<br>CT6843-05  | 20 A/200 A<br>1 Hz to 100 kHz<br>9272-05   |
|                                     | 500 A<br>1000 A  | <br>φ20 mm (0.79 in.) | <br>φ50 mm (1.97 in.) |
| 500 A<br>DC to 200 kHz<br>CT6844-05 |  | 500 A<br>DC to 100 kHz<br>CT6845-05  | 1000 A<br>DC to 20 kHz<br>CT6846-05  |

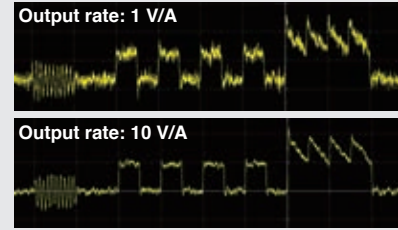

**Waveform observation** Output terminals: BNC

Minuscule current waveforms can be observed more clearly by generating output at 10 V/A





| Model            | Measurement range | Output rate |
|------------------|-------------------|-------------|
| CT6710<br>CT6711 | 0.5 A             | 10 V/A      |
|                  | 5 A               | 1 V/A       |
|                  | 30 A              | 0.1 V/A     |
| CT6700<br>CT6701 | 5 A               | 1 V/A       |
| 3273-50<br>3276  | 30 A              | 0.1 V/A     |
| 3274             | 150 A             | 0.01 V/A    |
| 3275             | 500 A             | 0.01 V/A    |



**High-sensitivity observation**

|                      |  |  |
|----------------------|--|--|
| 0.5 A<br>5 A<br>30 A | <br>φ5 mm (0.20 in.) | <br>φ5 mm (0.20 in.) |
|                      | 0.5 A, 5 A, 30 A<br>DC to 50 MHz<br>CT6710   | 0.5 A, 5 A, 30 A<br>DC to 120 MHz<br>CT6711  |

**Observation of minuscule currents**









|     |   |   |
|-----|---|---|
| 5 A | <br>φ5 mm (0.20 in.) | <br>φ5 mm (0.20 in.) |
|     | 5 A<br>DC to 50 MHz<br>CT6700   | 5 A<br>DC to 120 MHz<br>CT6701  |

**Observation of large currents**



|                               |   |  |
|-------------------------------|---|--|
| 30 A                          | <br>φ5 mm (0.20 in.) | <br>φ5 mm (0.20 in.)  |
|                               | 30 A<br>DC to 50 MHz<br>3273-50   | 30 A<br>DC to 100 MHz<br>3276  |
|                               | 150 A<br>500 A  | <br>φ20 mm (0.79 in.) |
| 150 A<br>DC to 10 MHz<br>3274 |   | 500 A<br>DC to 2 MHz<br>3275   |

**Grid power quality control** Output terminals: **PL14**

**Measurement of load current**

|               |  |   |   |
|---------------|--|---|---|
| 60 A<br>100 A | <br>ϕ15 mm (0.59 in.)<br><b>60 A</b><br>40 Hz to 20 kHz<br>CT7126 | <br>ϕ15 mm (0.59 in.)<br><b>100 A</b><br>40 Hz to 20 kHz<br>CT7131 |   |
|               |  |   |   |
| 100 A         | <br>ϕ33 mm (1.30 in.)<br><b>100 A</b><br>DC to 5 kHz<br>CT7731    | <br>ϕ33 mm (1.30 in.)<br><b>100 A</b><br>DC to 10 kHz<br>CT7631    |   |
|               |  |   |   |
| 600 A         | <br>ϕ33 mm (1.30 in.)<br><b>600 A</b><br>DC to 5 kHz<br>CT7736    | <br>ϕ33 mm (1.30 in.)<br><b>600 A</b><br>DC to 10 kHz<br>CT7636    | <br>ϕ46 mm (1.81 in.)<br><b>600 A</b><br>40 Hz to 20 kHz<br>CT7136 |
|               |  |   |   |
|               |  |   |   |
| 2000 A        | <br>ϕ55 mm (2.17 in.)<br><b>2000 A</b><br>DC to 5 kHz<br>CT7742 | <br>ϕ55 mm (2.17 in.)<br><b>2000 A</b><br>DC to 10 kHz<br>CT7642 |   |
|               |  |   |   |

**Measurement of large currents**









|        |   |   |   |
|--------|---|---|---|
| 6000 A | <br>ϕ100 mm (3.94 in.)<br><b>6000 A</b><br>10 Hz to 50 kHz<br>CT7044 | <br>ϕ180 mm (7.09 in.)<br><b>6000 A</b><br>10 Hz to 50 kHz<br>CT7045 | <br>ϕ254 mm (10.0 in.)<br><b>6000 A</b><br>10 Hz to 50 kHz<br>CT7046 |
|        |   |   |   |

**Measurement of leakage current**

|     |  |
|-----|--|
| 6 A | <br>ϕ40 mm (1.57 in.)<br><b>6 A</b><br>40 Hz to 5 kHz<br>CT7116 |
|     |  |

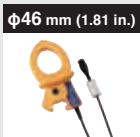

**Grid power quality control** Output terminals: **BNC\*1**

**Measurement of load current**



|             |   |   |  |
|-------------|---|---|--|
| 5 A<br>50 A | <br>ϕ15 mm (0.59 in.)<br><b>5 A</b><br>40 Hz to 5 kHz<br>9694                   | <br>ϕ15 mm (0.59 in.)<br><b>50 A</b><br>40 Hz to 5 kHz<br>9695-02*1          |  |
|             |   |   |  |
| 100 A       | <br>ϕ15 mm (0.59 in.)<br><b>100 A</b><br>40 Hz to 5 kHz<br>9660                 | <br>ϕ15 mm (0.59 in.)<br><b>100 A</b><br>40 Hz to 5 kHz<br>9695-03*1         |  |
|             |   |   |  |
| 500 A       | <br>ϕ46 mm (1.81 in.)<br><b>10 A to 500 A*2</b><br>40 Hz to 1 kHz<br>9010-50    | <br>ϕ46 mm (1.81 in.)<br><b>10 A to 500 A*2</b><br>40 Hz to 3 kHz<br>9018-50 | <br>ϕ46 mm (1.81 in.)<br><b>500 A</b><br>40 Hz to 5 kHz<br>9661 |
|             |   |   |  |
|             |   |   |  |
| 1000 A      | <br>ϕ46 mm (1.81 in.)<br><b>20 A to 1000 A*3</b><br>40 Hz to 1 kHz<br>9132-50 | <br>ϕ55 mm (2.17 in.)<br><b>1000 A</b><br>40 Hz to 5 kHz<br>9669           |  |
|             |   |   |  |

\*1: The 9695-02 and 9695-03 use an M3 terminal block for their output terminals. Optional Connection Cable 9219 is required.  
\*2: Range-switched (10, 20, 50, 100, 200, 500 A AC)  
\*3: Range-switched (20, 50, 100, 200, 500, 1000 A AC)

**Measurement of large currents**

|                 |  |   |   |
|-----------------|--|---|---|
| 500 A<br>5000 A | <br>ϕ100 mm (3.94 in.)<br><b>500 A, 5000 A</b><br>10 Hz to 20 kHz<br>CT9667-01 | <br>ϕ180 mm (7.09 in.)<br><b>500 A, 5000 A</b><br>10 Hz to 20 kHz<br>CT9667-02 | <br>ϕ254 mm (10.0 in.)<br><b>500 A, 5000 A</b><br>10 Hz to 20 kHz<br>CT9667-03 |
|                 |  |   |   |

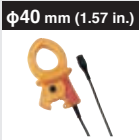















**Measurement of leakage current**

|      |   |   |
|------|---|---|
| 10 A | <br>ϕ40 mm (1.57 in.)<br><b>10 A</b><br>40 Hz to 5 kHz<br>9657-10 | <br>ϕ30 mm (1.18 in.)<br><b>10 A</b><br>40 Hz to 5 kHz<br>9675 |
|      |   |   |







## High-accuracy measurement

Output terminals: ME15W



## Pass-through types

| Model     | Appearance  | Rated primary current | Maximum peak current | Withstand voltage*2 | Output voltage | Frequency range | Linearity error | Offset error | Amplitude errors  |
|-----------|---|-----------------------|----------------------|---------------------|----------------|-----------------|-----------------|--------------|---|
| CT6862-05 |    | 50 Arms               | ±141 A peak          | 7.4 kV AC           | 40 mV/A        | DC to 1 MHz     | -               | -            | -   |
| CT6872    |    | 50 Arms               | ±200 A peak          | 7.4 kV AC           | 40 mV/A        | DC to 10 MHz    | ±2 ppm          | ±5 ppm       | DC: 7 ppm<br>10 Hz to 100 Hz: 0.005%<br>100 Hz to 1 kHz: 0.01%<br>1 kHz to 50 kHz: 0.1%<br>50 kHz to 100 kHz: 0.3%<br>100 kHz to 300 kHz: 1%<br>300 kHz to 1 MHz: 3%          |
| CT6872-01 |    | 50 Arms               | ±200 A peak          | 7.4 kV AC           | 40 mV/A        | DC to 10 MHz    | ±2 ppm          | ±5 ppm       | -   |
| CT6863-05 |    | 200 Arms              | ±565 A peak          | 7.4 kV AC           | 10 mV/A        | DC to 500 kHz   | -               | -            | -   |
| CT6873    |    | 200 Arms              | ±350 A peak*1        | 7.4 kV AC           | 10 mV/A        | DC to 10 MHz    | ±2 ppm          | ±5 ppm       | DC: ±7 ppm<br>10 Hz to 500 Hz: ±0.005%<br>500 Hz to 3 kHz: ±0.01%<br>3 kHz to 30 kHz: ±0.1%<br>30 kHz to 100 kHz: ±0.4%<br>100 kHz to 400 kHz: ±1%<br>400 kHz to 1 MHz: ±3%   |
| CT6873-01 |    | 200 Arms              | ±350 A peak*1        | 7.4 kV AC           | 10 mV/A        | DC to 10 MHz    | ±2 ppm          | ±5 ppm       | -   |
| CT6875A   |    | 500 Arms              | ±1500 A peak*1       | 7.4 kV AC           | 4 mV/A         | DC to 2 MHz     | ±5 ppm          | ±5 ppm       | DC: ±10 ppm<br>10 Hz to 100 Hz: ±0.005%<br>100 Hz to 1 kHz: ±0.02%<br>1 kHz to 20 kHz: ±0.08%<br>20 kHz to 100 kHz: ±0.5%<br>100 kHz to 300 kHz: ±1%<br>300 kHz to 1 MHz: ±5% |
| CT6875A-1 |    | 500 Arms              | ±1500 A peak*1       | 7.4 kV AC           | 4 mV/A         | DC to 1.5 MHz   | ±5 ppm          | ±5 ppm       | -   |
| CT6904A   |   | 500 Arms              | ±1000 A peak*1       | 7.4 kV AC           | 4 mV/A         | DC to 4 MHz     | ±5 ppm          | ±10 ppm      | -   |
| CT6904A-1 |  | 500 Arms              | ±1000 A peak*1       | 7.4 kV AC           | 4 mV/A         | DC to 2 MHz     | ±5 ppm          | ±10 ppm      | -   |
| CT6904A-2 |  | 800 Arms              | ±1200 A peak*1       | 7.4 kV AC           | 2 mV/A         | DC to 4 MHz     | ±12.5 ppm       | ±10 ppm      | -   |
| CT6904A-3 |  | 800 Arms              | ±1200 A peak*1       | 7.4 kV AC           | 2 mV/A         | DC to 2 MHz     | ±12.5 ppm       | ±10 ppm      | -   |
| CT6876A   |  | 1000 Arms             | ±1800 A peak*1       | 7.4 kV AC           | 2 mV/A         | DC to 1.5 MHz   | ±5 ppm          | ±5 ppm       | DC: ±10 ppm<br>10 Hz to 100 Hz: ±0.005%<br>100 Hz to 1 kHz: ±0.03%<br>1 kHz to 10 kHz: ±0.2%<br>10 kHz to 100 kHz: ±1%<br>100 kHz to 300 kHz: ±3%<br>300 kHz to 1 MHz: ±15%   |
| CT6876A-1 |  | 1000 Arms             | ±1800 A peak*1       | 7.4 kV AC           | 2 mV/A         | DC to 1.2 MHz   | ±5 ppm          | ±5 ppm       | -   |
| CT6877A   |  | 2000 Arms             | ±3200 A peak*1       | 7.4 kV AC           | 1 mV/A         | DC to 1 MHz     | ±10 ppm         | ±5 ppm       | DC: ±15 ppm<br>10 Hz to 100 Hz: ±0.01%<br>100 Hz to 1 kHz: ±0.04%<br>1 kHz to 10 kHz: ±0.25%<br>10 kHz to 100 kHz: ±1%<br>100 kHz to 300 kHz: ±2%<br>300 kHz to 700 kHz: ±10% |
| CT6877A-1 |  | 2000 Arms             | ±3200 A peak*1       | 7.4 kV AC           | 1 mV/A         | DC to 1 MHz     | ±10 ppm         | ±5 ppm       | -   |

## Clamp types

|           |   |                   |                         |            |                   |                 |   |   |   |
|-----------|---|-------------------|-------------------------|------------|-------------------|-----------------|---|---|---|
| 9272-05   |  | 20 Arms, 200 Arms | ±71 A peak, ±430 A peak | 5.4 kV AC  | 100 mV/A, 10 mV/A | 1 Hz to 100 kHz | - | - | - |
| CT6841-05 |  | 20 Arms           | ±60 A peak*1            | 4.26 kV AC | 100 mV/A          | DC to 1 MHz     | - | - | - |
| CT6843-05 |  | 200 Arms          | ±600 A peak*1           | 4.26 kV AC | 10 mV/A           | DC to 500 kHz   | - | - | - |
| CT6844-05 |  | 500 Arms          | ±800 A peak*1           | 4.26 kV AC | 4 mV/A            | DC to 200 kHz   | - | - | - |
| CT6845-05 |  | 500 Arms          | ±1500 A peak*1          | 4.26 kV AC | 4 mV/A            | DC to 100 kHz   | - | - | - |
| CT6846-05 |  | 1000 Arms         | ±1900 A peak*1          | 4.26 kV AC | 2 mV/A            | DC to 20 kHz    | - | - | - |

## Direct-wired types

|           |   |         |               |           |         |               |   |   |   |
|-----------|---|---------|---------------|-----------|---------|---------------|---|---|---|
| PW9100A-3 |  | 50 Arms | ±200 A peak*1 | 5.4 kV AC | 40 mV/A | DC to 3.5 MHz | - | - | - |
| PW9100A-4 |  | 50 Arms | ±200 A peak*1 | 5.4 kV AC | 40 mV/A | DC to 3.5 MHz | - | - | - |

\*1: Within 20 ms \*2: Sensed current of 1 mA, 50/60 Hz, 1 min











| High-accuracy measurement |                              |                              |                                  |                   |                                   |                     | Output terminals: ME15W         |                                |                              |
|---------------------------|------------------------------|------------------------------|----------------------------------|-------------------|-----------------------------------|---------------------|---------------------------------|--------------------------------|------------------------------|
| pass-through types        |                              |                              |                                  |                   |                                   |                     |                                 |                                |                              |
| Model                     | Amplitude accuracy           |                              | Phase Shift Values               | Delay times       | Diameter of measurable conductors | Cable length        | Operating temperature           | Maximum rated voltage to earth | Automatic phase correction*3 |
|                           | DC                           | 50/60 Hz                     |                                  |                   |                                   |                     |                                 |                                |                              |
| CT6862-05                 | ±0.05% rdg.<br>±0.01% f.s.   | ±0.05% rdg.<br>±0.01% f.s.   | 300 kHz,<br>-10.96°              | 101 ns            | φ24 mm<br>(0.94 in.)              | 3 m<br>(9.84 ft.)   | -30°C to 85°C<br>-22°F to 185°F | 1000 V<br>CAT III              | -                            |
| CT6872                    | ±0.03% rdg.<br>±0.002 % f.s. | ±0.03% rdg.<br>±0.007% f.s.  | 100 kHz,<br>-1.28°               | 46 ns             | φ24 mm<br>(0.94 in.)              | 3 m<br>(9.84 ft.)   | -40°C to 85°C<br>-40°F to 185°F | 1000 V<br>CAT III              | Yes                          |
| CT6872-01                 | ±0.03% rdg.<br>±0.002% f.s.  | ±0.03% rdg.<br>±0.007% f.s.  | 100 kHz,<br>-2.63°               | 82 ns             | φ24 mm<br>(0.94 in.)              | 10 m<br>(32.81 ft.) | -40°C to 85°C<br>-40°F to 185°F | 1000 V<br>CAT III              | Yes                          |
| CT6863-05                 | ±0.05% rdg.<br>±0.01% f.s.   | ±0.05% rdg.<br>±0.01% f.s.   | 100 kHz,<br>-4.60°               | 128 ns            | φ24 mm<br>(0.94 in.)              | 3 m<br>(9.84 ft.)   | -30°C to 85°C<br>-22°F to 185°F | 1000 V<br>CAT III              | -                            |
| CT6873                    | ±0.03% rdg.<br>±0.002% f.s.  | ±0.03% rdg.<br>±0.007% f.s.  | 100 kHz,<br>-0.75°               | 36 ns             | φ24 mm<br>(0.94 in.)              | 3 m<br>(9.84 ft.)   | -40°C to 85°C<br>-40°F to 185°F | 1000 V<br>CAT III              | Yes                          |
| CT6873-01                 | ±0.03% rdg.<br>±0.002% f.s.  | ±0.03% rdg.<br>±0.007% f.s.  | 100 kHz,<br>-2.10°               | 69 ns             | φ24 mm<br>(0.94 in.)              | 10 m<br>(32.81 ft.) | -40°C to 85°C<br>-40°F to 185°F | 1000 V<br>CAT III              | Yes                          |
| CT6875A                   | 0.04% rdg.<br>±0.008% f.s.   | 0.04% rdg.<br>±0.008% f.s.   | 200 kHz,<br>-10.45°              | 145 ns            | φ36 mm<br>(1.42 in.)              | 3 m<br>(9.84 ft.)   | -40°C to 85°C<br>-40°F to 185°F | 1000 V<br>CAT III              | Yes                          |
| CT6875A-1                 | 0.04% rdg.<br>±0.008% f.s.   | 0.04% rdg.<br>±0.008% f.s.   | 200 kHz,<br>12.87°               | 179 ns            | φ36 mm<br>(1.42 in.)              | 10 m<br>(32.81 ft.) | -40°C to 85°C<br>-40°F to 185°F | 1000 V<br>CAT III              | Yes                          |
| CT6904A                   | ±0.025% rdg.<br>±0.007% f.s. | ±0.02% rdg.<br>±0.007% f.s.  | 300 kHz,<br>-9.82°               | 91 ns             | φ32 mm<br>(1.26 in.)              | 3 m<br>(9.84 ft.)   | -10°C to 50°C<br>14°F to 122°F  | 1000 V<br>CAT III              | Yes                          |
| CT6904A-1                 | ±0.025% rdg.<br>±0.007% f.s. | ±0.02% rdg.<br>±0.007% f.s.  | 300 kHz,<br>-9.82°               | 91 ns             | φ32 mm<br>(1.26 in.)              | 10 m<br>(32.81 ft.) | -10°C to 50°C<br>14°F to 122°F  | 1000 V<br>CAT III              | Yes                          |
| CT6904A-2                 | ±0.030% rdg.<br>±0.009% f.s. | ±0.025% rdg.<br>±0.009% f.s. | 300 kHz,<br>-9.82°               | 91 ns             | φ32 mm<br>(1.26 in.)              | 3 m<br>(9.84 ft.)   | -10°C to 50°C<br>14°F to 122°F  | 1000 V<br>CAT III              | Yes                          |
| CT6904A-3                 | ±0.030% rdg.<br>±0.009% f.s. | ±0.025% rdg.<br>±0.009% f.s. | 300 kHz,<br>-9.82°               | 91 ns             | φ32 mm<br>(1.26 in.)              | 10 m<br>(32.81 ft.) | -10°C to 50°C<br>14°F to 122°F  | 1000 V<br>CAT III              | Yes                          |
| CT6876A                   | 0.04% rdg.<br>±0.008% f.s.   | 0.04% rdg.<br>±0.008% f.s.   | 200 kHz,<br>-12.96°              | 180 ns            | φ36 mm<br>(1.42 in.)              | 3 m<br>(9.84 ft.)   | -40°C to 85°C<br>-40°F to 185°F | 1000 V<br>CAT III              | Yes                          |
| CT6876A-1                 | 0.04% rdg.<br>±0.008% f.s.   | 0.04% rdg.<br>±0.008% f.s.   | 200 kHz,<br>-14.34°              | 199 ns            | φ36 mm<br>(1.42 in.)              | 10 m<br>(32.81 ft.) | -40°C to 85°C<br>-40°F to 185°F | 1000 V<br>CAT III              | Yes                          |
| CT6877A                   | 0.04% rdg.<br>±0.008% f.s.   | 0.04% rdg.<br>±0.008% f.s.   | 100 kHz,<br>-2.63°               | 73 ns             | φ80 mm<br>(3.15 in.)              | 3 m<br>(9.84 ft.)   | -40°C to 85°C<br>-40°F to 185°F | 1000 V<br>CAT III              | Yes                          |
| CT6877A-1                 | 0.04% rdg.<br>±0.008% f.s.   | 0.04% rdg.<br>±0.008% f.s.   | 100 kHz<br>-3.34°                | 93 ns             | φ80 mm<br>(3.15 in.)              | 10 m<br>(32.81 ft.) | -40°C to 85°C<br>-40°F to 185°F | 1000 V<br>CAT III              | Yes                          |
| clamp types               |                              |                              |                                  |                   |                                   |                     |                                 |                                |                              |
| 9272-05                   | -                            | ±0.3% rdg.<br>±0.01% f.s.    | 50 kHz, -3.34°<br>50 kHz, -4.18° | 186 ns,<br>232 ns | φ46 mm<br>(1.81 in.)              | 3 m<br>(9.84 ft.)   | 0°C to 50°C<br>32°F to 122°F    | 600 V<br>CAT III               | -                            |
| CT6841-05                 | ±0.3% rdg.<br>±0.05% f.s.    | ±0.3% rdg.<br>±0.01% f.s.    | 100 kHz,<br>-1.82°               | 51 ns             | φ20 mm<br>(0.79 in.)              | 3 m<br>(9.84 ft.)   | -40°C to 85°C<br>-40°F to 185°F | -                              | -                            |
| CT6843-05                 | ±0.3% rdg.<br>±0.02% f.s.    | ±0.3% rdg.<br>±0.01% f.s.    | 100 kHz,<br>-1.68°               | 47 ns             | φ20 mm<br>(0.79 in.)              | 3 m<br>(9.84 ft.)   | -40°C to 85°C<br>-40°F to 185°F | -                              | -                            |
| CT6844-05                 | ±0.3% rdg.<br>±0.02% f.s.    | ±0.3% rdg.<br>±0.01% f.s.    | 50 kHz,<br>-1.29°                | 72 ns             | φ20 mm<br>(0.79 in.)              | 3 m<br>(9.84 ft.)   | -40°C to 85°C<br>-40°F to 185°F | -                              | -                            |
| CT6845-05                 | ±0.3% rdg.<br>±0.02% f.s.    | ±0.3% rdg.<br>±0.01% f.s.    | 20 kHz,<br>-0.62°                | 86 ns             | φ50 mm<br>(1.97 in.)              | 3 m<br>(9.84 ft.)   | -40°C to 85°C<br>-40°F to 185°F | -                              | -                            |
| CT6846-05                 | ±0.3% rdg.<br>±0.02% f.s.    | ±0.3% rdg.<br>±0.01% f.s.    | 20 kHz,<br>-1.89°                | 263 ns            | φ50 mm<br>(1.97 in.)              | 3 m<br>(9.84 ft.)   | -40°C to 85°C<br>-40°F to 185°F | -                              | -                            |
| direct-wired types        |                              |                              |                                  |                   |                                   |                     |                                 |                                |                              |
| PW9100A-3                 | ±0.02% rdg.<br>±0.007% f.s.  | ±0.02% rdg.<br>±0.005% f.s.  | 300 kHz,<br>-2.80°               | 26 ns             | M6 screw<br>terminals             | 3 ch                | 0°C to 40°C<br>32°F to 104°F    | 1000 V CAT II<br>600 V CAT III | Yes                          |
| PW9100A-4                 | ±0.02% rdg.<br>±0.007% f.s.  | ±0.02% rdg.<br>±0.005% f.s.  | 300 kHz,<br>-2.80°               | 26 ns             | M6 screw<br>terminals             | 4 ch                | 0°C to 40°C<br>32°F to 104°F    | 1000 V CAT II<br>600 V CAT III | Yes                          |

\*3: When using PW8001

## Waveform observation









Output terminals: BNC





| Model  | Appearance  | Rated current:<br>output rate                         | Frequency<br>range | Rise time<br>(10% to 90%) | Delay<br>time | Amplitude<br>accuracy | Diameter of<br>measurable<br>conductors | Cable<br>length*1                  | Operating<br>temperature     |
|--|---|---|--------------------|---------------------------|---------------|-----------------------|---|------------------------------------|------------------------------|
| <b>High-sensitivity observation of currents ranging in magnitude from minuscule to large</b> |   |   |                    |                           |               |                       |   |                                    |                              |
| CT6710   |    | 0.5 Arms: 10 V/A<br>5 Arms: 1 V/A<br>30 Arms: 0.1 V/A | DC to 50 MHz       | 7.0 ns or less            | 12 ns*2       | ±3.0% rdg.<br>±1 mV   | φ5 mm<br>(0.20 in.)                     | 1.5 m, 1 m<br>(4.92 ft., 3.28 ft.) | 0°C to 40°C<br>32°F to 104°F |
| CT6711   |    | 0.5 Arms: 10 V/A<br>5 Arms: 1 V/A<br>30 Arms: 0.1 V/A | DC to 120 MHz      | 2.9 ns or less            | 12 ns*2       | ±3.0% rdg.<br>±1 mV   | φ5 mm<br>(0.20 in.)                     | 1.5 m, 1 m<br>(4.92 ft., 3.28 ft.) | 0°C to 40°C<br>32°F to 104°F |
| <b>Observation of minuscule currents</b>   |   |   |                    |                           |               |                       |   |                                    |                              |
| CT6700   |    | 5 Arms: 1 V/A   | DC to 50 MHz       | 7.0 ns or less            | 13 ns         | ±3.0% rdg.<br>±1 mV   | φ5 mm<br>(0.20 in.)                     | 1.5 m, 1 m<br>(4.92 ft., 3.28 ft.) | 0°C to 40°C<br>32°F to 104°F |
| CT6701   |    | 5 Arms: 1 V/A   | DC to 120 MHz      | 2.9 ns or less            | 12 ns         | ±3.0% rdg.<br>±1 mV   | φ5 mm<br>(0.20 in.)                     | 1.5 m, 1 m<br>(4.92 ft., 3.28 ft.) | 0°C to 40°C<br>32°F to 104°F |
| <b>Observation of large currents</b>   |   |   |                    |                           |               |                       |   |                                    |                              |
| 3273-50  |    | 30 Arms: 0.1 V/A                                      | DC to 50 MHz       | 7.0 ns or less            | 16 ns         | ±1.0% rdg.<br>±1 mV   | φ5 mm<br>(0.20 in.)                     | 1.5 m, 1 m<br>(4.92 ft., 3.28 ft.) | 0°C to 40°C<br>32°F to 104°F |
| 3276   |   | 30 Arms: 0.1 V/A                                      | DC to 100 MHz      | 3.5 ns or less            | 14 ns         | ±1.0% rdg.<br>±1 mV   | φ5 mm<br>(0.20 in.)                     | 1.5 m, 1 m<br>(4.92 ft., 3.28 ft.) | 0°C to 40°C<br>32°F to 104°F |
| 3274   |  | 150 Arms: 0.01 V/A                                    | DC to 10 MHz       | 35 ns or less             | 40 ns         | ±1.0% rdg.<br>±1 mV   | φ20 mm<br>(0.79 in.)                    | 2.0 m, 1 m<br>(6.56 ft., 3.28 ft.) | 0°C to 40°C<br>32°F to 104°F |
| 3275   |  | 500 Arms: 0.01 V/A                                    | DC to 2 MHz        | 175 ns or less            | 66 ns         | ±1.0% rdg.<br>±5 mV   | φ20 mm<br>(0.79 in.)                    | 2.0 m, 1 m<br>(6.56 ft., 3.28 ft.) | 0°C to 40°C<br>32°F to 104°F |

\*1: Sensor cable: cable between relay box and sensor for models with relay boxes (i.e. CT6710, CT6711), power supply cable for other models \*2: When using 0.5 A range: 13 ns















## Grid power quality control

Output terminals: PL14

| Model                              | Appearance  | Rated current | Frequency<br>range | Amplitude<br>accuracy     | Diameter of<br>measurable<br>conductors | Cable length        | Operating<br>temperature        | CAT                            |
|------------------------------------|---|---------------|--------------------|---------------------------|---|---------------------|---------------------------------|--------------------------------|
| <b>Measurement of load current</b> |   |               |                    |                           |   |                     |                                 |                                |
| CT7126                             |  | 60 A AC       | 40 Hz to 20 kHz    | ±0.3% rdg.<br>±0.01% f.s. | φ15 mm<br>(0.59 in.)                    | 2.5 m<br>(8.20 ft.) | -10°C to 50°C<br>14°F to 122°F  | 300 V CAT III                  |
| CT7131                             |  | 100 A AC      | 40 Hz to 20 kHz    | ±0.3% rdg.<br>±0.02% f.s. | φ15 mm<br>(0.59 in.)                    | 2.5 m<br>(8.20 ft.) | -10°C to 50°C<br>14°F to 122°F  | 300 V CAT III                  |
| CT7731                             |  | 100 A AC/DC   | DC to 5 kHz        | ±1.0% rdg.<br>±0.5% f.s.  | φ33 mm<br>(1.30 in.)                    | 2.5 m<br>(8.20 ft.) | -25°C to 65°C<br>-13°F to 149°F | 600 V CAT IV                   |
| CT7631                             |  | 100 A AC/DC   | DC to 10 kHz       | ±1.0% rdg.<br>±0.5% f.s.  | φ33 mm<br>(1.30 in.)                    | 2.5 m<br>(8.20 ft.) | -25°C to 65°C<br>-13°F to 149°F | 600 V CAT IV                   |
| CT7736                             |  | 600 A AC/DC   | DC to 5 kHz        | ±2.0% rdg.<br>±0.5% f.s.  | φ33 mm<br>(1.30 in.)                    | 2.5 m<br>(8.20 ft.) | -25°C to 65°C<br>-13°F to 149°F | 600 V CAT IV                   |
| CT7636                             |  | 600 A AC/DC   | DC to 10 kHz       | ±2.0% rdg.<br>±0.5% f.s.  | φ33 mm<br>(1.30 in.)                    | 2.5 m<br>(8.20 ft.) | -25°C to 65°C<br>-13°F to 149°F | 600 V CAT IV<br>1000 V CAT III |
| CT7136                             |  | 600 A AC      | 40 Hz to 20 kHz    | ±0.3% rdg.<br>±0.01% f.s. | φ46 mm<br>(1.81 in.)                    | 2.5 m<br>(8.20 ft.) | -10°C to 50°C<br>14°F to 122°F  | 600 V CAT IV<br>1000 V CAT III |
| CT7742                             |  | 2000 A AC/DC  | DC to 5 kHz        | ±1.5% rdg.<br>±0.5% f.s.  | φ55 mm<br>(2.17 in.)                    | 2.5 m<br>(8.20 ft.) | -25°C to 65°C<br>-13°F to 149°F | 600 V CAT IV<br>1000 V CAT III |
| CT7642                             |  | 2000 A AC/DC  | DC to 10 kHz       | ±1.5% rdg.<br>±0.5% f.s.  | φ55 mm<br>(2.17 in.)                    | 2.5 m<br>(8.20 ft.) | -25°C to 65°C<br>-13°F to 149°F | 600 V CAT IV<br>1000 V CAT III |

| Model                                 | Appearance  | Rated current | Frequency range | Amplitude accuracy        | Diameter of measurable conductors | Cable length                          | Operating temperature           | CAT                            |
|---------------------------------------|---|---------------|-----------------|---------------------------|-----------------------------------|---------------------------------------|---------------------------------|--------------------------------|
| <b>Measurement of large currents</b>  |   |               |                 |                           |                                   |                                       |                                 |                                |
| CT7044                                |  | 6000 A AC     | 10 Hz to 50 kHz | ±1.5% rdg.<br>±0.25% f.s. | φ100 mm<br>(3.94 in.)             | 2.3 m, 0.2 m*<br>(7.55 ft., 0.66 ft.) | -25°C to 65°C<br>-13°F to 149°F | 600 V CAT IV<br>1000 V CAT III |
| CT7045                                |  | 6000 A AC     | 10 Hz to 50 kHz | ±1.5% rdg.<br>±0.25% f.s. | φ180 mm<br>(7.09 in.)             | 2.3 m, 0.2 m*<br>(7.55 ft., 0.66 ft.) | -25°C to 65°C<br>-13°F to 149°F | 600 V CAT IV<br>1000 V CAT III |
| CT7046                                |  | 6000 A AC     | 10 Hz to 50 kHz | ±1.5% rdg.<br>±0.25% f.s. | φ254 mm<br>(10.00 in.)            | 2.3 m, 0.2 m*<br>(7.55 ft., 0.66 ft.) | -25°C to 65°C<br>-13°F to 149°F | 600 V CAT IV<br>1000 V CAT III |
| <b>Measurement of leakage current</b> |   |               |                 |                           |                                   |                                       |                                 |                                |
| CT7116                                |  | 6 A AC        | 40 Hz to 5 kHz  | ±1.0% rdg.<br>±0.05% f.s. | φ40 mm<br>(1.57 in.)              | 2.5 m<br>(8.20 ft.)                   | -25°C to 65°C<br>-13°F to 149°F | -                              |

\*Sensor cable: between flexible loop and circuit box for flexible sensors (e.g. CT7044), output cable for CT7116

| Grid power quality control            |   |                   |                 |                            |                                   |                                    |                                 | Output terminals: BNC          |
|---------------------------------------|---|-------------------|-----------------|----------------------------|-----------------------------------|------------------------------------|---------------------------------|--------------------------------|
| Model                                 | Appearance  | Rated current     | Frequency range | Amplitude accuracy         | Diameter of measurable conductors | Cable length                       | Operating temperature           | CAT                            |
| <b>Measurement of load current</b>    |   |                   |                 |                            |                                   |                                    |                                 |                                |
| 9694                                  |   | 5 A AC            | 40 Hz to 5 kHz  | ±0.3% rdg.<br>±0.02% f.s.  | φ15 mm<br>(0.59 in.)              | 3 m<br>(9.84 ft.)                  | 0°C to 50°C<br>32°F to 122°F    | 300 V CAT III                  |
| 9695-02*1                             |  | 50 A AC           | 40 Hz to 5 kHz  | ±0.3% rdg.<br>±0.02% f.s.  | φ15 mm<br>(0.59 in.)              | -                                  | 0°C to 50°C<br>32°F to 122°F    | 300 V CAT III                  |
| 9660                                  |  | 100 A AC          | 40 Hz to 5 kHz  | ±0.3% rdg.<br>±0.02% f.s.  | φ15 mm<br>(0.59 in.)              | 3 m<br>(9.84 ft.)                  | 0°C to 50°C<br>32°F to 122°F    | 300 V CAT III                  |
| 9695-03*1                             |  | 100 A AC          | 40 Hz to 5 kHz  | ±0.3% rdg.<br>±0.02% f.s.  | φ15 mm<br>(0.59 in.)              | -                                  | 0°C to 50°C<br>32°F to 122°F    | 300 V CAT III                  |
| 9010-50                               |  | 10 A to 500 A AC  | 40 Hz to 1 kHz  | ±2% rdg.<br>±1% f.s.       | φ46 mm<br>(1.81 in.)              | 3 m<br>(9.84 ft.)                  | 0°C to 50°C<br>32°F to 122°F    | 600 V CAT III                  |
| 9018-50                               |  | 10 A to 500 A AC  | 40 Hz to 3 kHz  | ±1.5% rdg.<br>±0.1% f.s.   | φ46 mm<br>(1.81 in.)              | 3 m<br>(9.84 ft.)                  | 0°C to 50°C<br>32°F to 122°F    | 600 V CAT III                  |
| 9132-50                               |  | 20 A to 1000 A AC | 40 Hz to 1 kHz  | ±3% rdg.<br>±0.2% f.s.     | φ55 mm<br>(2.17 in.)              | 3 m<br>(9.84 ft.)                  | -10°C to 50°C<br>14°F to 122°F  | 600 V CAT III                  |
| 9661                                  |  | 500 A AC          | 40 Hz to 5 kHz  | ±0.3% rdg.<br>±0.01% f.s.  | φ46 mm<br>(1.81 in.)              | 3 m<br>(9.84 ft.)                  | 0°C to 50°C<br>32°F to 122°F    | 600 V CAT III                  |
| 9669                                  |  | 1000 A AC         | 40 Hz to 5 kHz  | ±1.0% rdg.<br>±0.01% f.s.  | φ55 mm<br>(2.17 in.)              | 3 m<br>(9.84 ft.)                  | 0°C to 50°C<br>32°F to 122°F    | 600 V CAT III                  |
| <b>Measurement of large currents</b>  |   |                   |                 |                            |                                   |                                    |                                 |                                |
| CT9667-01                             |  | 500 A, 5000 A AC  | 10 Hz to 20 kHz | ±2% rdg.<br>±0.3% f.s.     | φ100 mm<br>(3.94 in.)             | 2 m, 1 m*2<br>(6.56 ft., 3.28 ft.) | -25°C to 65°C<br>-13°F to 149°F | 600 V CAT IV<br>1000 V CAT III |
| CT9667-02                             |  | 500 A, 5000 A AC  | 10 Hz to 20 kHz | ±2% rdg.<br>±0.3% f.s.     | φ180 mm<br>(7.09 in.)             | 2 m, 1 m*2<br>(6.56 ft., 3.28 ft.) | -25°C to 65°C<br>-13°F to 149°F | 600 V CAT IV<br>1000 V CAT III |
| CT9667-03                             |  | 500 A, 5000 A AC  | 10 Hz to 20 kHz | ±2% rdg.<br>±0.3% f.s.     | φ254 mm<br>(10.00 in.)            | 2 m, 1 m*2<br>(6.56 ft., 3.28 ft.) | -10°C to 50°C<br>14°F to 122°F  | 600 V CAT IV<br>1000 V CAT III |
| <b>Measurement of leakage current</b> |   |                   |                 |                            |                                   |                                    |                                 |                                |
| 9657-10                               |  | 10 A AC           | 40 Hz to 5 kHz  | ±1.0% rdg.<br>±0.05% f.s.  | φ40 mm<br>(1.57 in.)              | 3 m<br>(9.84 ft.)                  | 0°C to 50°C<br>32°F to 122°F    | -                              |
| 9675                                  |  | 10 A AC           | 40 Hz to 5 kHz  | ±1.0% rdg.<br>±0.005% f.s. | φ30 mm<br>(1.18 in.)              | 3 m<br>(9.84 ft.)                  | 0°C to 50°C<br>32°F to 122°F    | -                              |

\*1: The 9695-02 and 9695-03 use an M3 terminal block for their output terminals. The extra purchase of the connection cable 9219 is required.

\*2: Sensor cable: between flexible loop and circuit box for flexible sensors (e.g. CT9667-01), output cable for others.

# High-accuracy measurement

| ME15W     |  | Directly wired | External power supply + connection cord  |       |        | Conversion cable  |
|-----------|--|----------------|--|-------|--------|---|
| CT6862-05 |  |                |  |       |        |   |
| CT6872    |  |                | <b>CT9555, CT9556</b><br>Connects one sensor<br><b>CT9557*</b><br>Connects four sensors.                   |       |        | <b>CT9901</b><br>Converts ME15W terminal to PL23 terminal |
| CT6872-01 |  |                | <b>L9217</b> Isolated BNC<br><b>9165</b> metallic BNC<br>Connects CT9555, CT9556 or CT6557 and instrument. |       |        |   |
| CT6863-05 |  |                |  |       |        |   |
| CT6873    |  |                |  |       |        |   |
| CT6873-01 |  |                |  |       |        |   |
| CT6875A   |  | ME15W          | BNC  | BNC   | BNC    | PL23  |
| CT6875A-1 |  |                |  |       |        |   |
| CT6904A   |  | PW8001         | PW3335-03  | U8975 | MR8870 | The 9318 comes with the 8971                              |
| CT6904A-1 |  | ME15W          | BNC  | BNC   | BNC    |   |
| CT6904A-2 |  |                |  |       |        |   |
| CT6904A-3 |  | PW6001         | PW3335-04  | U8976 | MR8880 |   |
| CT6876A   |  | ME15W          | BNC  | BNC   | BNC    |   |
| CT6876A-1 |  |                |  |       |        |   |
| CT6877A   |  | PW3390         | PW3336   | U8978 |        |   |
| CT6877A-1 |  | ME15W          | BNC  | BNC   |        |   |
| 9272-05   |  |                |  |       |        |   |
| CT6841-05 |  | U8977          | PW3337   | 8966  |        |   |
| CT6843-05 |  |                |  | BNC   |        |   |
| CT6844-05 |  |                |  |       |        |   |
| CT6845-05 |  |                |  | 8968  |        |   |
| CT6846-05 |  |                |  | BNC   |        |   |
| PW9100A-3 |  |                |  |       |        |   |
| PW9100A-4 |  |                |  | 8972  |        |   |

**CT9902 (ME15W-ME15W)**

The CT9902 can be used to extend a current sensor's cable by 5 m. Up two of these cables can be used for a maximum extension of 10 m.

\*When using the CT9902, an addition must be made to accuracy. For details, see the sensor's user manual.

\*The CT9557 can output four channels of input as an added waveform.

CT9557 Front

Sensor input

Rear

1 2 3

|          |                               |   |
|----------|-------------------------------|---|
| <b>1</b> | Total RMS output (BNC)        | CONNECTION CABLE<br><b>L9217, 9165</b><br>BNC-BNC |
| <b>2</b> | Total waveform output (BNC)   | CONNECTION CABLE<br><b>L9217, 9165</b><br>BNC-BNC |
| <b>3</b> | Total waveform output (ME15W) | CONNECTION CABLE<br><b>CT9904</b><br>ME15W-ME15W  |

We accept special orders for extending sensor cables. For inquiries, please contact Hioki for more information.

# Waveform observation

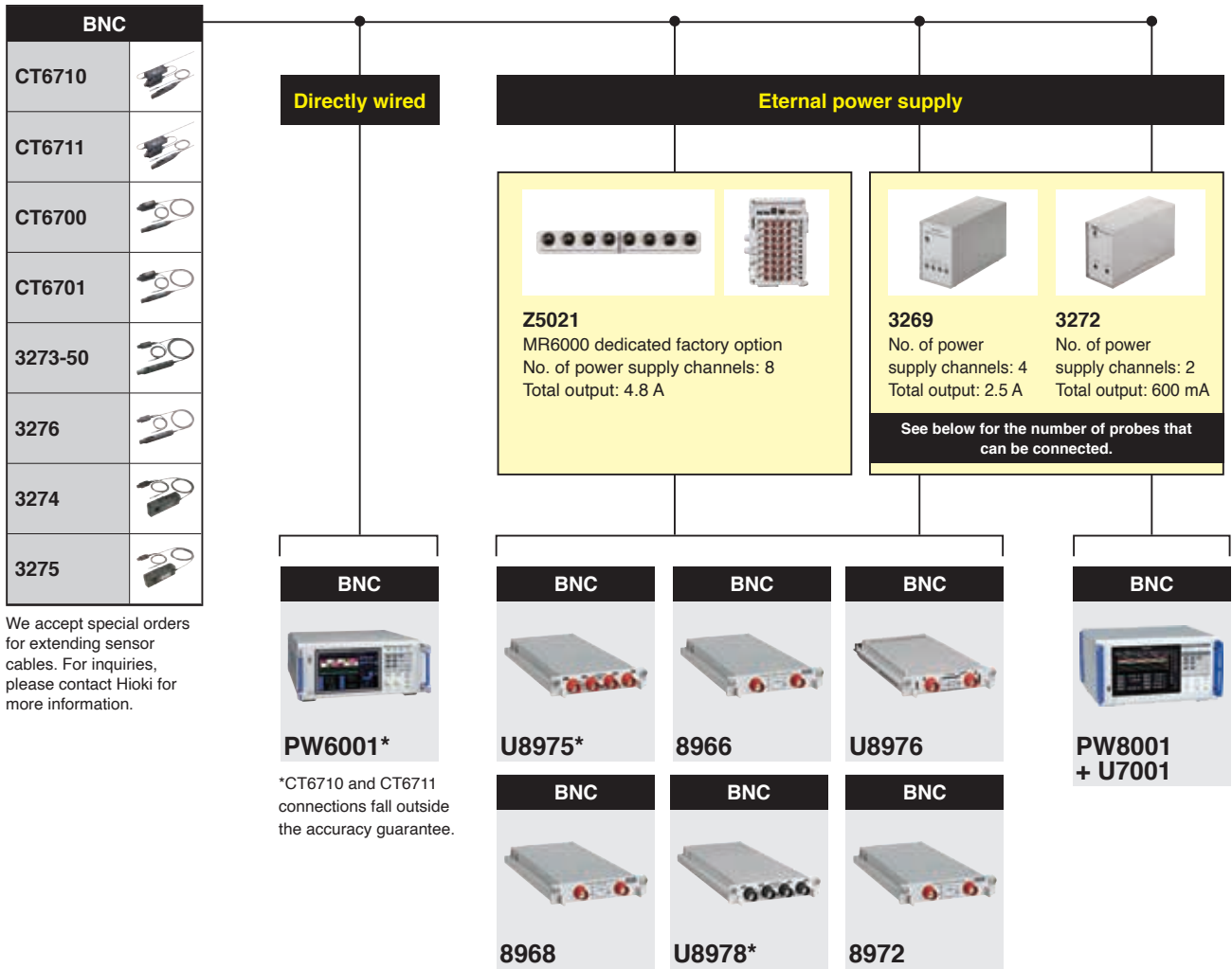

We accept special orders for extending sensor cables. For inquiries, please contact Hioki for more information.

\*CT6710 and CT6711 connections fall outside the accuracy guarantee.

\*Special-order cables are required when using three or more probes simultaneously. Please contact Hioki for details.

The following products can be used with the U8975, U8976, U8978, 8966, 8968, and 8972

|  |       |   |  |       |   |  |       |   |
|--|-------|---|--|-------|---|--|-------|---|
|  | U8975 | ✓ |  | U8975 | ✓ |  | U8975 | - |
|  | U8976 | ✓ |  | U8976 | - |  | U8976 | - |
|  | U8977 | ✓ |  | U8977 | ✓ |  | U8977 | - |
|  | U8978 | ✓ |  | U8978 | ✓ |  | U8978 | - |
|  | 8966  | ✓ |  | 8966  | ✓ |  | 8966  | ✓ |
|  | 8968  | ✓ |  | 8968  | ✓ |  | 8968  | ✓ |
|  | 8971  | ✓ |  | 8971  | ✓ |  | 8971  | ✓ |
|  | 8972  | ✓ |  | 8972  | ✓ |  | 8972  | ✓ |
|  | U8975 | ✓ |  | U8975 | - |  | U8975 | - |
|  | U8976 | - |  | U8976 | - |  | U8976 | - |
|  | U8977 | ✓ |  | U8977 | - |  | U8977 | - |
|  | U8978 | ✓ |  | U8978 | - |  | U8978 | - |
|  | 8966  | ✓ |  | 8966  | ✓ |  | 8966  | ✓ |
|  | 8968  | ✓ |  | 8968  | ✓ |  | 8968  | ✓ |
|  | 8971  | ✓ |  | 8971  | ✓ |  | 8971  | - |
|  | 8972  | ✓ |  | 8972  | ✓ |  | 8972  | ✓ |

## Current consumption per probe and number of probes per power supply

Current consumption varies by probe. The following table indicates how many probes can be utilized when using one type of probe per power supply.

| Sensor  | Consumption current* | Z5021 | 3269 | 3272 |
|---------|----------------------|-------|------|------|
| CT6710  | approx. 650 mA       | 4     | 2    | -    |
| CT6711  | approx. 650 mA       | 4     | 2    | -    |
| CT6700  | approx. 250 mA       | 8     | 4    | 2    |
| CT6701  | approx. 250 mA       | 8     | 4    | 2    |
| 3273-50 | approx. 450 mA       | 8     | 4    | 1    |
| 3274    | approx. 450 mA       | 8     | 4    | 1    |
| 3275    | approx. 600 mA       | 8     | 4    | 1    |
| 3276    | approx. 450 mA       | 8     | 4    | 1    |

\*When measuring the rated current.

# Grid power quality control (PL14)

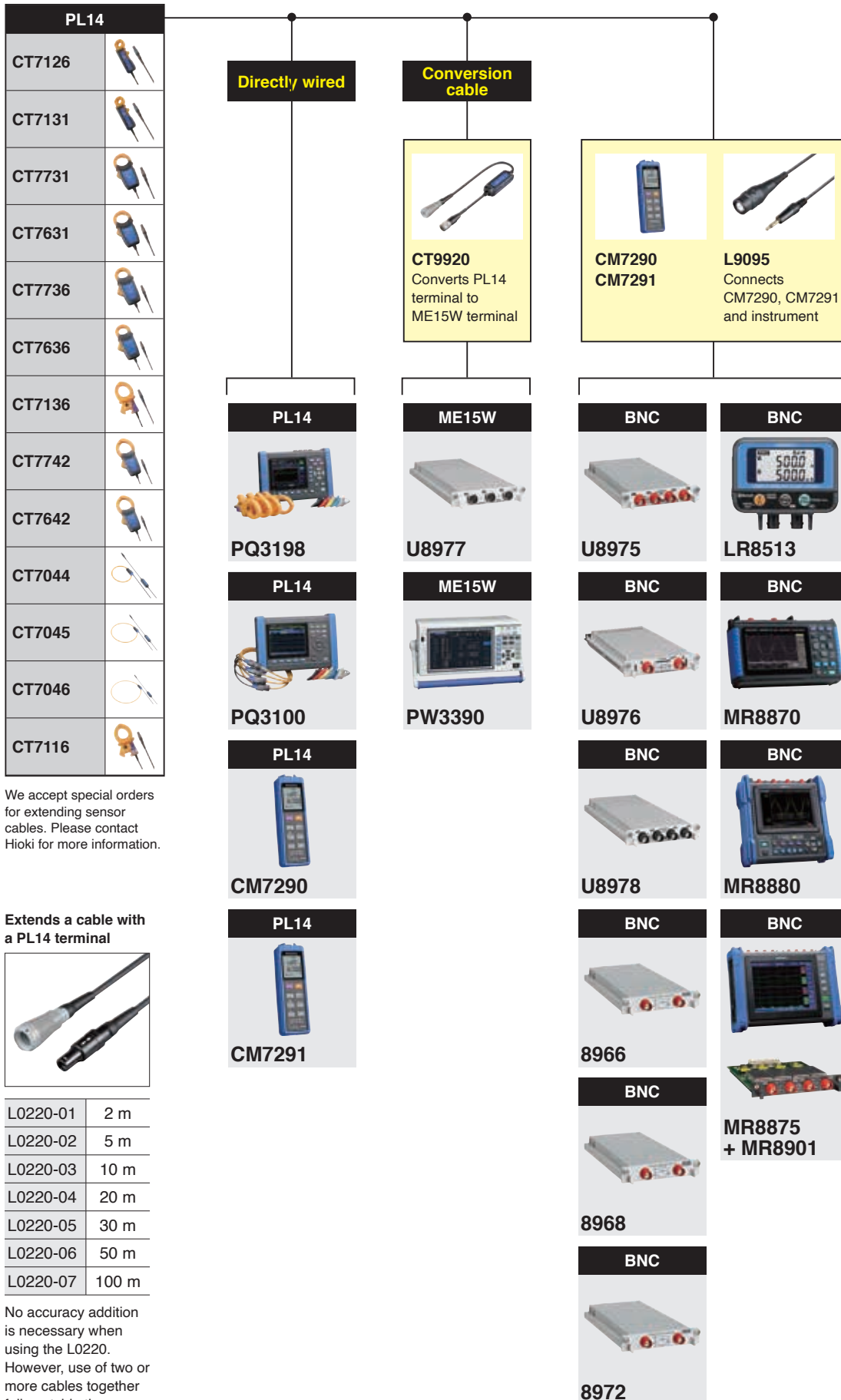

**Directly wired**

**Conversion cable**

**CT9920**  
Converts PL14 terminal to ME15W terminal

**CM7290**  
**CM7291**

**L9095**  
Connects CM7290, CM7291 and instrument

**PL14**

**PQ3198**

**ME15W**

**U8977**

**BNC**

**U8975**

**BNC**

**LR8513**

**PL14**

**PQ3100**

**ME15W**

**PW3390**

**BNC**

**U8976**

**BNC**

**MR8870**

**PL14**

**CM7290**

**BNC**

**U8978**

**BNC**

**MR8880**

**PL14**

**CM7291**

**BNC**

**8966**

**BNC**

**MR8875 + MR8901**

**BNC**

**8968**

**BNC**

**8972**

# Grid power quality control (BNC)

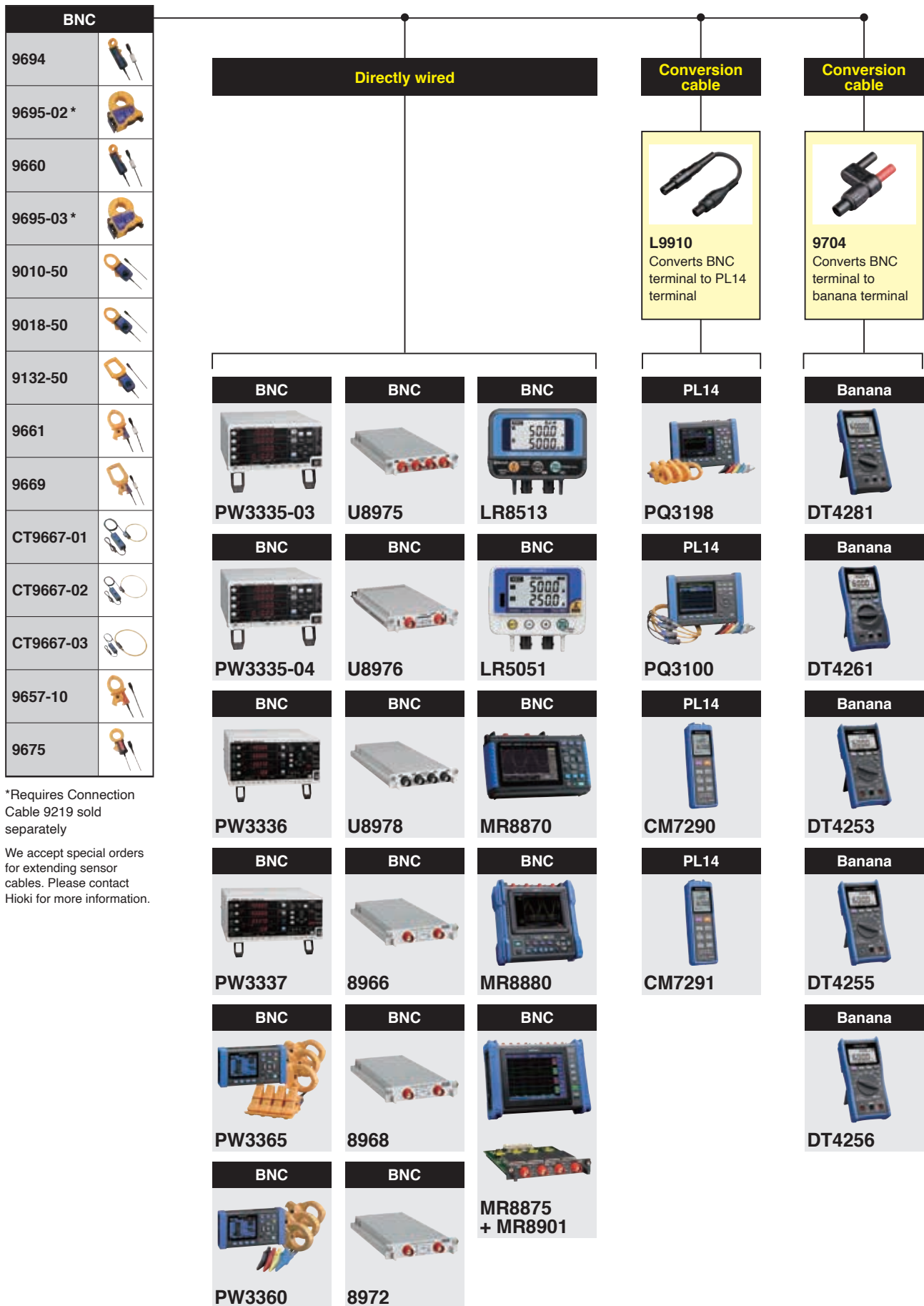

\*Requires Connection Cable 9219 sold separately

We accept special orders for extending sensor cables. Please contact Hioki for more information.

# Accurately evaluating power conversion efficiency

Improving power conversion efficiency is a key part of the effort to facilitate the effective use of energy. Devices that operate at high frequencies are increasingly being used to improve efficiency, and evaluation processes undertaken during the development of such devices requires accurate measurement of power at the low frequencies used by in previous devices as well as at high frequencies. Additionally, sensors that can resist noise are necessary since noise becomes stronger as the frequency increases. Hioki offers current sensors that can measure power accurately while providing robust noise resistance over a broad band of frequencies.

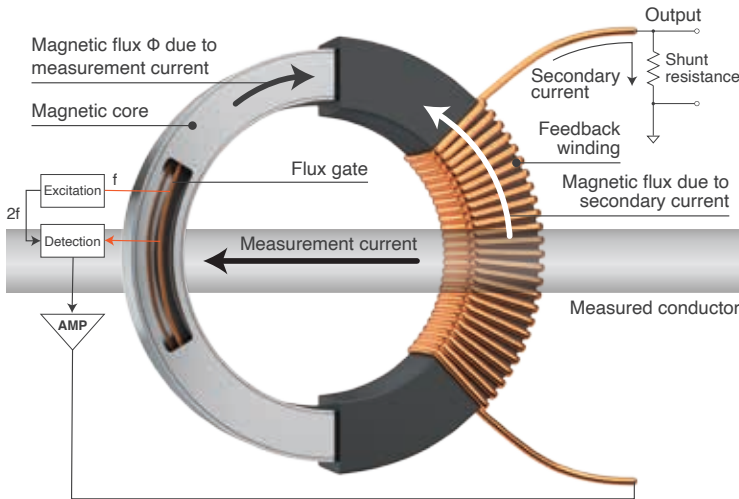

High-frequency currents are detected by a winding (CT), while DC to low-frequency currents are detected by a flux gate.

## Zero-flux method: achieving stable, wideband measurement from DC to high frequencies

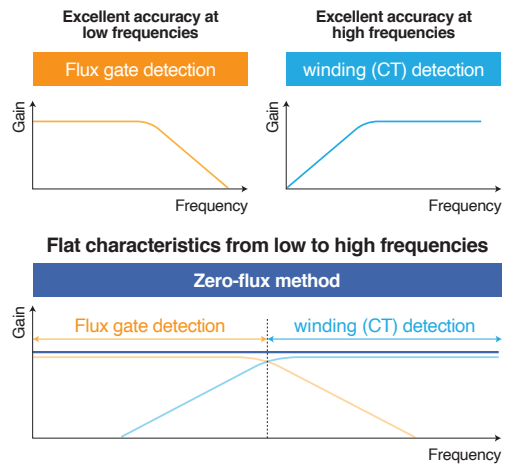

### Zero-flux method (flux gate) current sensors



CT6841-05, CT6843-05, CT6845-05, CT6846-05, CT6844-05

CT6862-05, CT6863-05, CT6872, CT6873

CT6875A, CT6876A

CT6877A

CT6904A

### Application

## Evaluating the power conversion efficiency of an inverter

When evaluating the power conversion efficiency of an inverter, the inverter's input and output power are measured and its efficiency is checked. PWM (pulse width modulated) inverter output, which has been widely used in recently years, contains a modulated wave (fundamental wave) and a switching frequency along with their respective harmonic components. Since switching frequencies tend to be high, the process requires wide frequency band current sensors.

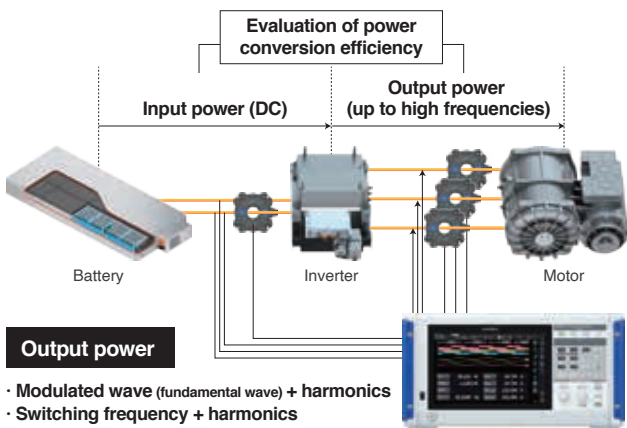

- Modulated wave (fundamental wave) + harmonics
- Switching frequency + harmonics

### Inverter output: principal active power components

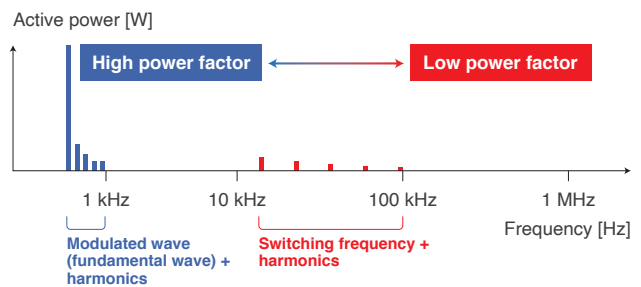

Since the power factor decreases with harmonics, current sensors' phase measurement accuracy becomes key (see right).



### Phase measurement accuracy and correction: accurately measuring power at low power factors

For typical current sensors, phase measurement accuracy is not defined. However, phase measurement precision is important in applications where power must be measured with a high degree of accuracy. Power can be measured more accurately by selecting a current sensor for which phase measurement accuracy is defined in the measurement band.

At low power factors, phase error has a significant effect on power error.

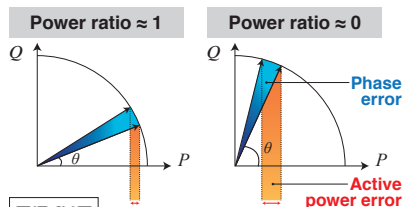

Access the QR Code to view the technical documentation on phase correction.

**PW8001: Automatic Phase Correction function**  
Automatic acquisition of phase correction values

Power supplied from instrument

|  |               |
|--|---------------|
| Information stored in the current sensors' internal memory |               |
| Phase shift  | Rated current |
| Sensor model   | Serial number |

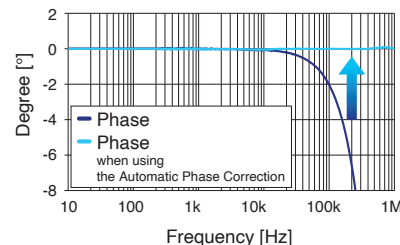

Example of the Automatic Phase Correction for the CT6904A AC/DC current sensor

The power factor decreases in the high-frequency range of the switching frequencies and other frequency components. At low power factors, phase error has a significant effect on power measured values.

For typical sensors, phase error increases with frequency. Since Hioki has developed both current sensors and the measuring instruments, current sensors' phase characteristics can be corrected by the instruments, allowing accurate power values to be calculated.

### Common-mode voltage rejection ratio: measuring current values accurately in noisy environments

In high-frequency measurement, sensors' resistance to noise is critical. A sensor's ability to remove noise is expressed by its common-mode rejection ratio (CMRR). Sensors with a high CMRR reject more noise and therefore can make more accurate measurements.

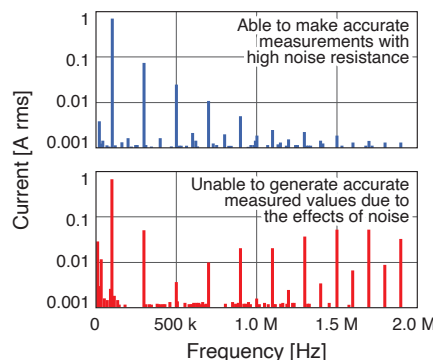
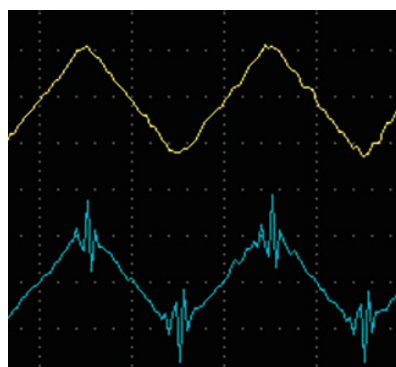
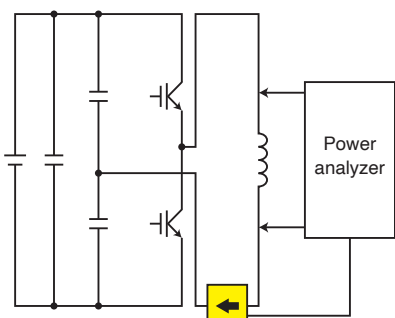

For reactors, higher frequencies mean lower current values. The image to the right shows a waveform obtained by measuring reactor current at high frequency along with variations in current values that accompany variations in the frequency.

Top: CT6904A CMRR 120 dB or greater (100 Hz); bottom: sensor with a low CMRR

### Effects of conductor position: stable, highly reproducible sensing

In general, speaking, the effects of conductor position increase with frequency. Since the position of the conductor inside the clamp core affects the measurement accuracy, resulting the reproducibility of measurement reduces. Sensors are designed the effects of conductor position, highly reproducible measurements are possible since conductor position does not affect measured values.

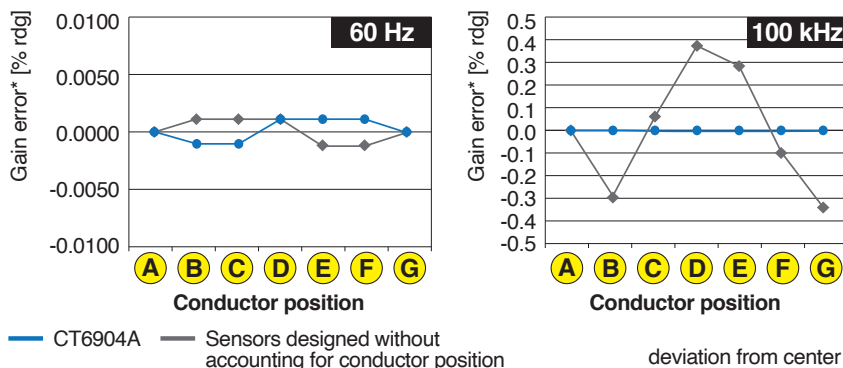

When using a sensor designed with the effects of conductor position, measured values are not affected when the conductor's position changes.

## Clearly observing current waveforms

The magnitude of the currents that flow in power-saving devices during operation and control currents that flow in automotive accessory components have reduced to 1 mA or less. At the same time, reliance on high-speed switching operation for device control is resulting in increased noise. Wideband current probes that are highly resistant to noise are essential in order to clearly observe low-current waveforms without losing them in noise. Hioki offers current probes that enable clear waveform observation while providing robust noise resistance over a broad band of frequencies.

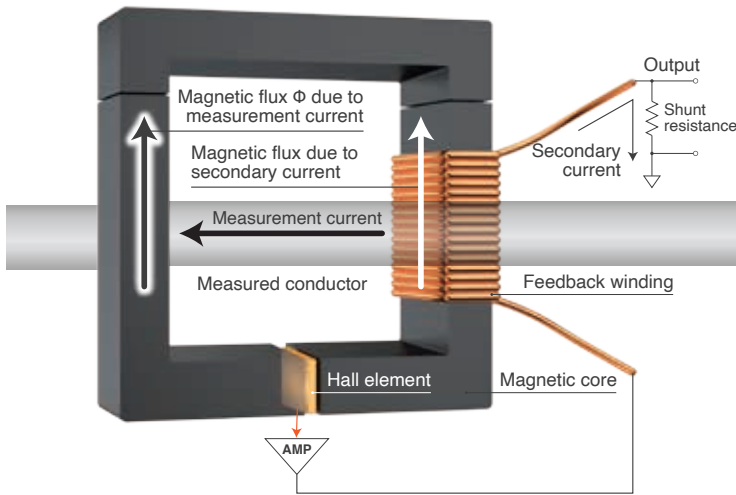

High-frequency currents are detected by the winding (CT), while DC to low-frequency currents are detected by the Hall element.

### Zero-flux method: realizing stable, wideband measurement from DC to high frequencies

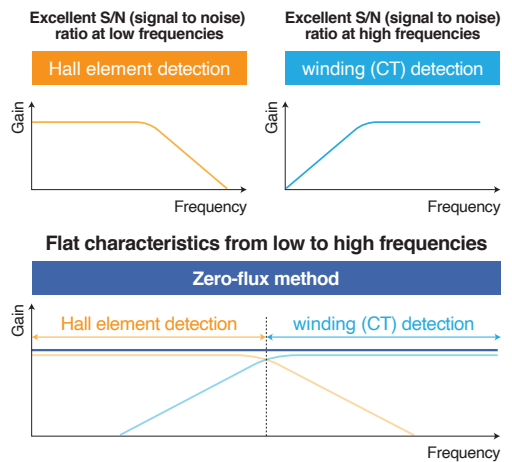

### Zero-flux method (hall element) current probes



CT6710, CT6711

CT6700, CT6701

3273-50, 3276

3274, 3275

### Application

## Evaluating the response performance of switching devices

Switching devices control equipment by turning the power on and off. The response performance of switching devices is evaluated by observing fluctuations of current and voltage when the device cycles the power on and off. Capturing current fluctuations caused by high-speed switching operation requires current probes with a broad frequency band. Additionally, noise resistance is important since switching operation generates noise.

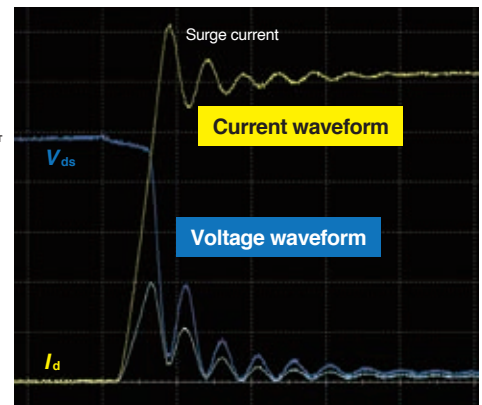
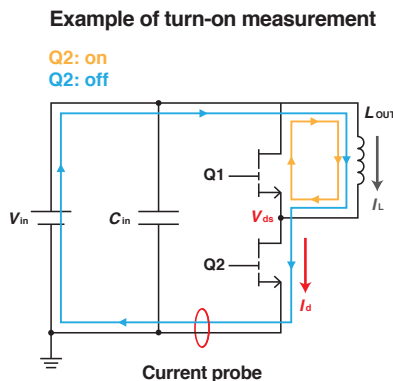
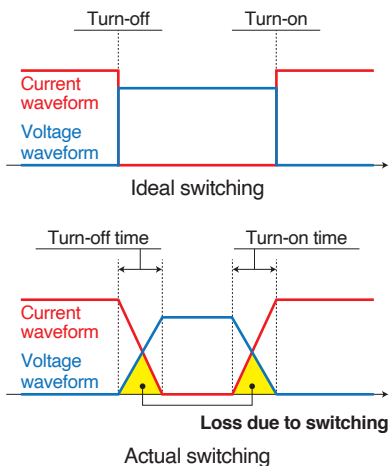

### Observing waveforms from minuscule currents to large currents: evaluating the control design of ECUs and accessory components

The control systems used in ECUs and accessory components carry currents of a variety of magnitudes according to the vehicle's operation, from control currents to inrush currents. Using a current probe that can switch current ranges makes it possible to observe current waveforms associated with an array of operating conditions with a single probe.

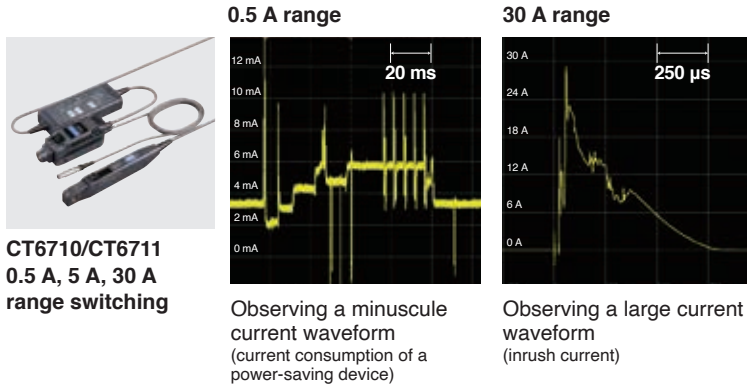

**CT6710/CT6711**  
0.5 A, 5 A, 30 A range switching

Observing a minuscule current waveform (current consumption of a power-saving device)

Observing a large current waveform (inrush current)

| Model   | Freq. band    | measurement range | output rate |
|---------|---------------|-------------------|-------------|
| CT6710  | DC to 50 MHz  | 0.5 A             | 10 V/A      |
|         |               | 5 A               | 1 V/A       |
|         |               | 30 A              | 0.1 V/A     |
| CT6711  | DC to 120 MHz | 0.5 A             | 10 V/A      |
|         |               | 5 A               | 1 V/A       |
|         |               | 30 A              | 0.1 V/A     |
| CT6700  | DC to 50 MHz  | 5 A               | 1 V/A       |
| CT6701  | DC to 120 MHz | 5 A               | 1 V/A       |
| 3273-50 | DC to 50 MHz  | 30 A              | 0.1 V/A     |
| 3276    | DC to 100 MHz | 30 A              | 0.1 V/A     |
| 3274    | DC to 10 MHz  | 150 A             | 0.01 V/A    |
| 3275    | DC to 2 MHz   | 500 A             | 0.01 V/A    |

Observing currents of a variety of magnitudes, from minuscule currents to large currents, with a single probe

### Clearly observing minuscule currents: operating currents of power-saving devices and control currents flowing to accessory components

The magnitude of the currents that flow during operation of power-saving devices like wearables and control currents that flow in automotive accessory components tend to decrease in to 1 mA or less. Using a current probe with a high output rate make you possible for clearly observing minuscule current waveforms.

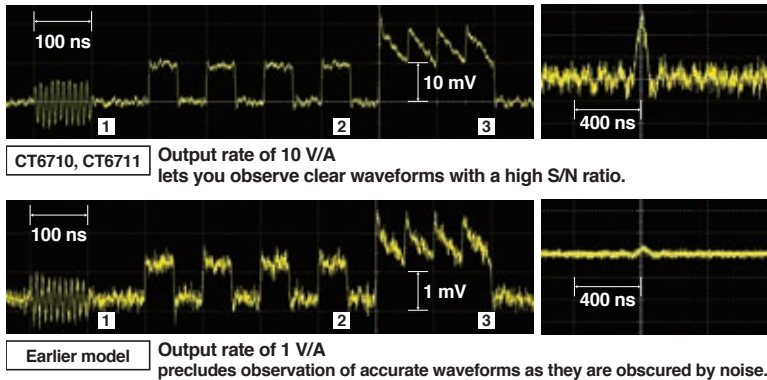

Noise resistance design: key to increasing output rate



Hioki uses a proprietary thin-film Hall element to reduce the amount of noise generated inside the probe. Electromagnetic shielding in the sensor improves resistance to environmental noise.

- 1 Sine wave:  $f = 100 \text{ MHz}$ , 1 mA peak-peak
- 2 Square wave:  $f = 10 \text{ MHz}$ , 1 mA peak-peak
- 3 Sawtooth wave:  $f = 20 \text{ MHz}$ , 1 mA peak-peak (offset +1 mA)

### Observing waveforms across a broad band of frequencies: capturing waveforms and pulse waveforms that fluctuate at high speeds

Currents from switching operation of devices such as SiC and GaN inverters and currents that flow momentarily when a power supply is activated fluctuate at high speeds. Using a current probe with a wide frequency band allows you observe current waveforms that fluctuate at high speed. Additionally, such devices allow you observe current waveforms such as pulse waveforms that contain a variety of frequency components.

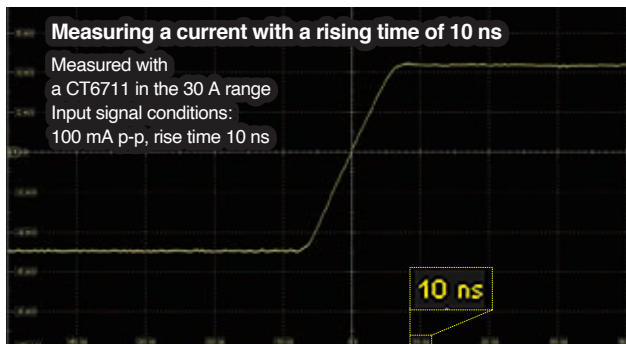

Current probes with a wide frequency band can capture high-speed current fluctuations with a rising time of 10 ns.

Failure to capture accurate waveforms due to insufficient frequency band  
Example of measuring a pulse with a cyclic frequency of 1 MHz using different frequency bands

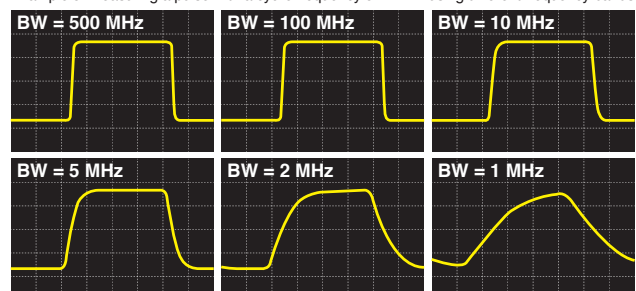

Current probes with a wide frequency band can accurately capture pulse waveforms.

## CT6862-05



Product warranty period: 3 years  
Guaranteed accuracy period: 1 year

|  |                              |
|--|------------------------------|
| <b>Rated current</b>                     | 50 A AC/DC                   |
| <b>Frequency band</b>                    | DC to 1 MHz (-3 dB)          |
| <b>Diameter of measurable conductors</b> | Max. $\phi$ 24 mm (0.94 in.) |

### Accuracy

| Frequency                  | Amplitude<br>$\pm$ (% of reading + % of full scale) | Phase  |
|----------------------------|---|--|
| DC                         | $\pm 0.05\% \pm 0.01\%$                             | -  |
| DC < f $\leq$ 16 Hz        | $\pm 0.10\% \pm 0.02\%$                             | $\pm 0.3^\circ$                              |
| 16 Hz < f $\leq$ 400 Hz    | $\pm 0.05\% \pm 0.01\%$                             | $\pm 0.2^\circ$                              |
| 400 Hz < f $\leq$ 1 kHz    | $\pm 0.2\% \pm 0.02\%$                              | $\pm 0.5^\circ$                              |
| 1 kHz < f $\leq$ 5 kHz     | $\pm 0.7\% \pm 0.02\%$                              | $\pm 1.0^\circ$                              |
| 5 kHz < f $\leq$ 10 kHz    | $\pm 1\% \pm 0.02\%$                                | $\pm 1.0^\circ$                              |
| 10 kHz < f $\leq$ 50 kHz   | $\pm 1\% \pm 0.02\%$                                | $\pm (0.5 + 0.1 \times f \text{ kHz})^\circ$ |
| 50 kHz < f $\leq$ 100 kHz  | $\pm 2\% \pm 0.05\%$                                | $\pm (0.5 + 0.1 \times f \text{ kHz})^\circ$ |
| 100 kHz < f $\leq$ 300 kHz | $\pm 5\% \pm 0.05\%$                                | $\pm (0.5 + 0.1 \times f \text{ kHz})^\circ$ |
| 300 kHz < f $\leq$ 700 kHz | $\pm 10\% \pm 0.05\%$                               | -  |
| 700 kHz < f < 1 MHz        | $\pm 30\% \pm 0.05\%$                               | -  |

The values above are when the input is a sine wave, the conductor is in the center of the sensor opening, and the measurement instrument's input resistance is 1 M $\Omega$  or higher.  
Amplitude accuracy: defined at the rated value or less, or within the derating curve; DC < f < 5 Hz is the typical value by design.  
Phase accuracy: defined at the rated value or less, or within the derating curve; DC < f < 10 Hz is the typical value by design.

|   |  |
|---|--|
| <b>Temperature and humidity range for guaranteed accuracy</b> | 0°C to 40°C (32°F to 104°F), 80% RH or less  |
| <b>Effect of temperature</b>                                  | In ranges from -30°C to 0°C (-22°F to 32°F) and 40°C to 85°C (104°F to 185°F)<br>Amplitude sensitivity: $\pm 0.005\%$ rdg./°C or less<br>Offset voltage: $\pm 0.005\%$ f.s./°C or less |
| <b>Effect of common mode voltage</b>                          | 0.05% f.s. or less (1000 Vrms, DC to 100 Hz)   |

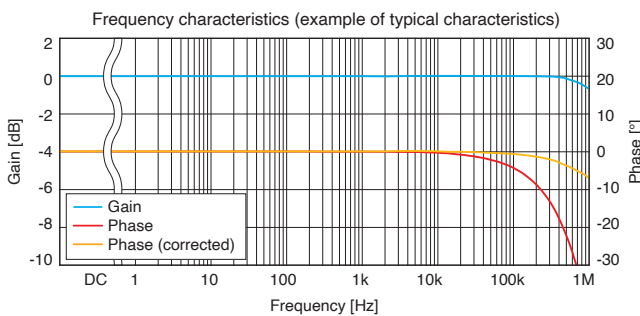
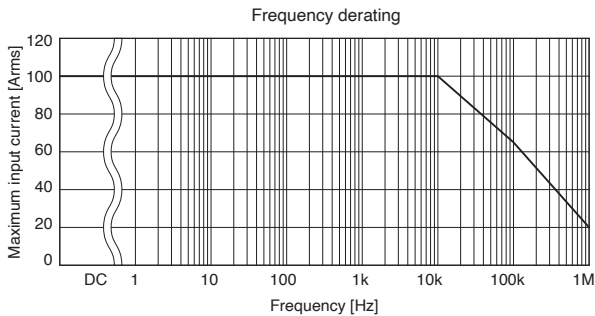

|   |   |
|---|---|
| <b>Output voltage</b>                           | 40 mV/A (= 2 V/50 A)  |
| <b>Operating temperature and humidity range</b> | -30°C to 85°C (-22°F to 185°F), 80% RH or less (no condensation)                                      |
| <b>Storage temperature and humidity range</b>   | -30°C to 85°C (-22°F to 185°F), 80% RH or less (no condensation)                                      |
| <b>Maximum rated voltage to ground</b>          | 1000 V AC/DC (50/60 Hz), measurement category III, anticipated transient overvoltage: 8000 V          |
| <b>Standards</b>                                | Safety: EN61010, EMC: EN61326   |
| <b>Cable length</b>                             | 3 m (9.84 ft.)  |
| <b>Dimensions</b>                               | 70 mm (2.76 in.) W x 100 mm (3.94 in.) H x 53 mm (2.09 in.) D (Excluding protruding parts and cables) |
| <b>Weight</b>                                   | Approx. 340 g (12.0 oz.)  |

## CT6872 CT6872-01

**NEW**



Product warranty period: 3 years  
Guaranteed accuracy period: 1 year

|  |                              |
|--|------------------------------|
| <b>Rated current</b>                     | 50 A AC/DC                   |
| <b>Frequency band</b>                    | DC to 10 MHz (-3 dB)         |
| <b>Diameter of measurable conductors</b> | Max. $\phi$ 24 mm (0.94 in.) |

### Accuracy

| Frequency                | Amplitude<br>$\pm$ (% of reading + % of full scale) | Phase   |
|--------------------------|---|---|
| DC                       | $\pm 0.03\% \pm 0.002\%$                            | -   |
| DC < f $\leq$ 16 Hz      | $\pm 0.1\% \pm 0.01\%$                              | $\pm 0.1^\circ$                                       |
| 16 Hz < f $\leq$ 45 Hz   | $\pm 0.05\% \pm 0.01\%$                             | $\pm 0.08^\circ$                                      |
| 45 Hz < f $\leq$ 66 Hz   | $\pm 0.03\% \pm 0.007\%$                            | $\pm 0.05^\circ$                                      |
| 66 Hz < f $\leq$ 100 Hz  | $\pm 0.04\% \pm 0.01\%$                             | $\pm 0.1^\circ$                                       |
| 100 Hz < f $\leq$ 500 Hz | $\pm 0.06\% \pm 0.01\%$                             | $\pm 0.15^\circ$                                      |
| 500 Hz < f $\leq$ 1 kHz  | $\pm 0.1\% \pm 0.01\%$                              | $\pm 0.4^\circ$                                       |
| 1 kHz < f $\leq$ 5 kHz   | $\pm 0.15\% \pm 0.02\%$                             | $\pm 0.4^\circ$                                       |
| 5 kHz < f $\leq$ 10 kHz  | $\pm 0.15\% \pm 0.02\%$                             | $\pm 0.5^\circ$                                       |
| 10 kHz < f $\leq$ 1 MHz  | $(0.012 \times f \text{ kHz})\% + 0.05\%$           | $\pm (0.04 \times f \text{ kHz})^\circ \pm 0.1^\circ$ |

The values above are when the input is a sine wave, the measuring instrument has an input resistance of 1 M $\Omega$   $\pm 10\%$ , the voltage to ground is 0 V, there is no external magnetic field, and the conductor is in the center of the sensor opening.  
Amplitude accuracy: defined 110% f.s. or less, or within the derating curve; DC < f < 10 Hz is the value by design.  
Phase accuracy: defined 110% f.s. or less, or within the derating curve; DC < f < 10 Hz is the value by design.  
Add  $\pm 0.01\%$  rdg. to the amplitude accuracy for input from 100% f.s. to 110% f.s.  
The CT6872-01 adds a phase accuracy of  $\pm(0.015 \times f)^\circ$  at a frequency of 1 kHz < f  $\leq$  1 MHz.

|   |   |
|---|---|
| <b>Temperature and humidity range for guaranteed accuracy</b> | 23°C $\pm 5^\circ$ C (73.4°F $\pm 41^\circ$ F), 80% RH or less  |
| <b>Effect of temperature</b>                                  | In ranges from -40°C to 18°C (-40°F to 64.4°F) and 28°C to 85°C (82.4°F to 185°F)<br>Amplitude sensitivity: $\pm 20$ ppm of rdg./°C<br>Offset voltage: $\pm 0.2$ ppm of f.s./°C                               |
| <b>Common-Mode Rejection Ratio (CMRR)</b>                     | (effect on output voltage and common mode voltage)<br>150 dB or greater (DC to 1 kHz)<br>140 dB or greater (1 kHz to 10 kHz)<br>120 dB or greater (10 kHz to 100 kHz)<br>100 dB or greater (100 kHz to 1 MHz) |
| <b>Linearity error</b>  | $\pm 2$ ppm   |
| <b>Offset error</b>   | $\pm 5$ ppm   |
| <b>Amplitude errors</b>                                       | DC: 7 ppm<br>10 Hz to 100 Hz: 0.005%<br>100 Hz to 1 kHz: 0.01%<br>1 kHz to 50 kHz: 0.1%<br>50 kHz to 100 kHz: 0.3%<br>100 kHz to 300 kHz: 1%<br>300 kHz to 1 MHz: 3%  |

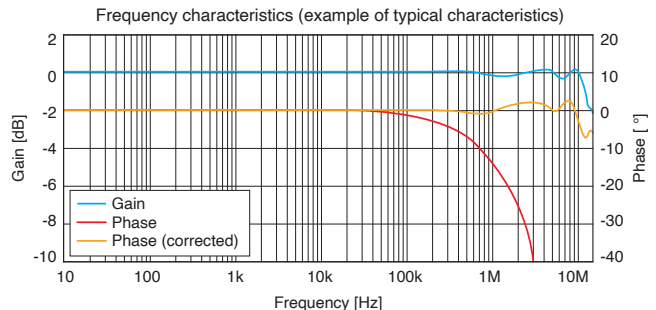
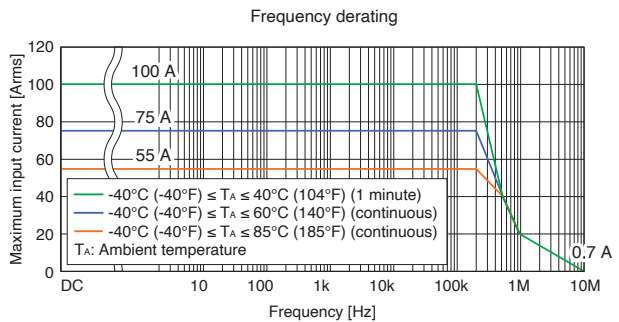

|   |   |
|---|---|
| <b>Output voltage</b>                           | 40 mV/A (= 2 V / 50 A)  |
| <b>Operating temperature and humidity range</b> | -40°C to 85°C (-40°F to 185°F), 80% RH or less (no condensation)                                      |
| <b>Storage temperature and humidity range</b>   | -40°C to 85°C (-40°F to 185°F), 80% RH or less (no condensation)                                      |
| <b>Maximum rated voltage to ground</b>          | 1000 V CAT III<br>Anticipated transient overvoltage: 8000 V   |
| <b>Standards</b>                                | Safety: EN61010, EMC: EN61326   |
| <b>Cable length</b>                             | CT6872: 3 m (9.84 ft.)<br>CT6872-01: 10 m (32.81 ft.)   |
| <b>Dimensions</b>                               | 70 mm (2.76 in.) W x 110 mm (4.33 in.) H x 53 mm (2.09 in.) D (excluding protruding parts and cables) |
| <b>Weight</b>                                   | CT6872: approx. 370 g (13.1 oz.)<br>CT6872-01: approx. 690 g (24.3 oz.)                               |

# CT6863-05



Product warranty period: 3 years  
Guaranteed accuracy period: 1 year

|  |                              |
|--|------------------------------|
| <b>Rated current</b>                     | 200 A AC/DC                  |
| <b>Frequency band</b>                    | DC to 500 kHz (-3 dB)        |
| <b>Diameter of measurable conductors</b> | Max. $\phi$ 24 mm (0.94 in.) |

## Accuracy

| Frequency                  | Amplitude<br>$\pm$ (% of reading + % of full scale) | Phase  |
|----------------------------|---|--|
| DC                         | $\pm 0.05\% \pm 0.01\%$                             | -  |
| DC < f $\leq$ 16 Hz        | $\pm 0.10\% \pm 0.02\%$                             | $\pm 0.3^\circ$                              |
| 16 Hz < f $\leq$ 400 Hz    | $\pm 0.05\% \pm 0.01\%$                             | $\pm 0.2^\circ$                              |
| 400 Hz < f $\leq$ 1 kHz    | $\pm 0.2\% \pm 0.02\%$                              | $\pm 0.5^\circ$                              |
| 1 kHz < f $\leq$ 5 kHz     | $\pm 0.7\% \pm 0.02\%$                              | $\pm 1.0^\circ$                              |
| 5 kHz < f $\leq$ 10 kHz    | $\pm 1\% \pm 0.02\%$                                | $\pm 1.0^\circ$                              |
| 10 kHz < f $\leq$ 50 kHz   | $\pm 2\% \pm 0.02\%$                                | $\pm (0.5 + 0.1 \times f \text{ kHz})^\circ$ |
| 50 kHz < f $\leq$ 100 kHz  | $\pm 5\% \pm 0.05\%$                                | $\pm (0.5 + 0.1 \times f \text{ kHz})^\circ$ |
| 100 kHz < f $\leq$ 300 kHz | $\pm 10\% \pm 0.05\%$                               | $\pm (0.5 + 0.1 \times f \text{ kHz})^\circ$ |
| 300 kHz < f $\leq$ 500 kHz | $\pm 30\% \pm 0.05\%$                               | -  |

The values above are when the input is a sine wave, the conductor is in the center of the sensor opening, and the measurement instrument's input resistance is 1 M $\Omega$  or higher.  
DC accuracy: defined at the rated value or less, or within the derating curve;  
DC < f < 5 Hz is the typical value by design.  
Phase accuracy: defined at the rated value or less, or within the derating curve;  
DC < f < 10 Hz is the typical value by design.

|   |  |
|---|--|
| <b>Temperature and humidity range for guaranteed accuracy</b> | 0°C to 40°C (32°F to 104°F), 80% RH or less  |
| <b>Effect of temperature</b>                                  | In ranges from -30°C to 0°C (-22°F to 32°F) and 40°C to 85°C (104°F to 185°F)<br>Amplitude sensitivity: $\pm 0.005\%$ rdg./°C or less<br>Offset voltage: $\pm 0.005\%$ f.s./°C or less |
| <b>Effect of common mode voltage</b>                          | 0.05% f.s. or less (1000 Vrms, DC to 100 Hz)   |

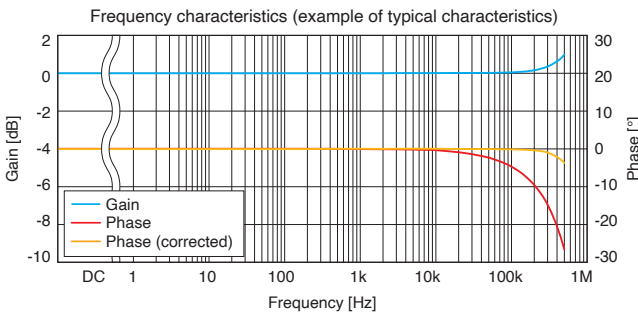
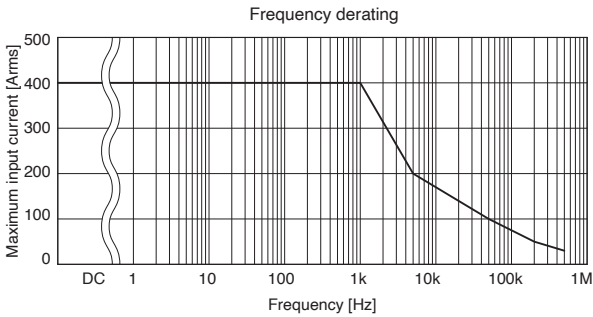

|   |   |
|---|---|
| <b>Output voltage</b>                           | 10 mV/A (= 2 V / 200 A)   |
| <b>Operating temperature and humidity range</b> | -30°C to 85°C (-22°F to 185°F), 80% RH or less (no condensation)                                      |
| <b>Storage temperature and humidity range</b>   | -30°C to 85°C (-22°F to 185°F), 80% RH or less (no condensation)                                      |
| <b>Maximum rated voltage to ground</b>          | 1000 V AC/DC (50/60 Hz), measurement category III, anticipated transient overvoltage: 8000 V          |
| <b>Standards</b>                                | Safety: EN61010, EMC: EN61326   |
| <b>Cable length</b>                             | 3 m (9.84 ft.)  |
| <b>Dimensions</b>                               | 70 mm (2.76 in.) W x 100 mm (3.94 in.) H x 53 mm (2.09 in.) D (excluding protruding parts and cables) |
| <b>Weight</b>                                   | Approx. 340 g (12.0 oz.)  |

# CT6873 CT6873-01

**NEW**



Product warranty period: 3 years  
Guaranteed accuracy period: 1 year

|  |                              |
|--|------------------------------|
| <b>Rated current</b>                     | 200 A AC/DC                  |
| <b>Frequency band</b>                    | DC to 10 MHz (-3 dB)         |
| <b>Diameter of measurable conductors</b> | Max. $\phi$ 24 mm (0.94 in.) |

## Accuracy

| Frequency                | Amplitude<br>$\pm$ (% of reading + % of full scale) | Phase   |
|--------------------------|---|---|
| DC                       | $\pm 0.03\% \pm 0.002\%$                            | -   |
| DC < f $\leq$ 16 Hz      | $\pm 0.1\% \pm 0.01\%$                              | $\pm 0.1^\circ$                                       |
| 16 Hz < f $\leq$ 45 Hz   | $\pm 0.05\% \pm 0.01\%$                             | $\pm 0.08^\circ$                                      |
| 45 Hz < f $\leq$ 66 Hz   | $\pm 0.03\% \pm 0.007\%$                            | $\pm 0.05^\circ$                                      |
| 66 Hz < f $\leq$ 100 Hz  | $\pm 0.04\% \pm 0.01\%$                             | $\pm 0.1^\circ$                                       |
| 100 Hz < f $\leq$ 500 Hz | $\pm 0.05\% \pm 0.01\%$                             | $\pm 0.15^\circ$                                      |
| 500 Hz < f $\leq$ 3 kHz  | $\pm 0.1\% \pm 0.01\%$                              | $\pm 0.4^\circ$                                       |
| 3 kHz < f $\leq$ 5 kHz   | $\pm 0.2\% \pm 0.02\%$                              | $\pm 0.4^\circ$                                       |
| 5 kHz < f $\leq$ 10 kHz  | $\pm 0.2\% \pm 0.02\%$                              | $\pm 0.5^\circ$                                       |
| 10 kHz < f $\leq$ 1 MHz  | $(0.018 \times f \text{ kHz})\% + 0.05\%$           | $\pm (0.04 \times f \text{ kHz})^\circ \pm 0.1^\circ$ |

The values above are when the input is a sine wave, the measuring instrument has an input resistance of 1 M $\Omega$   $\pm$ 10%, the voltage to ground is 0 V, there is no external magnetic field, and the conductor is in the center of the sensor opening.  
Amplitude accuracy: defined 110% f.s. or less, or within the derating curve; DC < f < 10 Hz is the value by design.  
Phase accuracy: defined 110% f.s. or less, or within the derating curve; DC < f < 10 Hz is the value by design.  
Add  $\pm 0.01\%$  rdg. to the amplitude accuracy for input from 100% f.s. to 110% f.s.  
The CT6873-01 adds a phase accuracy of  $\pm(0.015 \times f)$  at a frequency of 1 kHz < f  $\leq$  1 MHz.

|   |  |
|---|--|
| <b>Temperature and humidity range for guaranteed accuracy</b> | 23°C $\pm$ 5°C (73.4°F $\pm$ 41°F), 80% RH or less   |
| <b>Effect of temperature</b>                                  | In ranges from -40°C to 18°C (-40°F to 64.4°F) and 28°C to 85°C (82.4°F to 185°F)<br>Amplitude sensitivity: $\pm 15$ ppm of rdg./°C<br>Offset voltage: $\pm 0.1$ ppm of f.s./°C                                      |
| <b>Common-Mode Rejection Ratio (CMRR)</b>                     | (effect on output voltage and common mode voltage)<br>150 dB or greater (DC to 1 kHz)<br>140 dB or greater (1 kHz to 10 kHz)<br>120 dB or greater (10 kHz to 100 kHz)<br>100 dB or greater (100 kHz to 1 MHz)        |
| <b>Linearity errors</b>                                       | $\pm 2$ ppm  |
| <b>Offset error</b>   | $\pm 5$ ppm  |
| <b>Amplitude error</b>  | DC: $\pm 7$ ppm<br>10 Hz to 500 Hz: $\pm 0.005\%$<br>500 Hz to 3 kHz: $\pm 0.01\%$<br>3 kHz to 30 kHz: $\pm 0.1\%$<br>30 kHz to 100 kHz: $\pm 0.4\%$<br>100 kHz to 400 kHz: $\pm 1\%$<br>400 kHz to 1 MHz: $\pm 3\%$ |

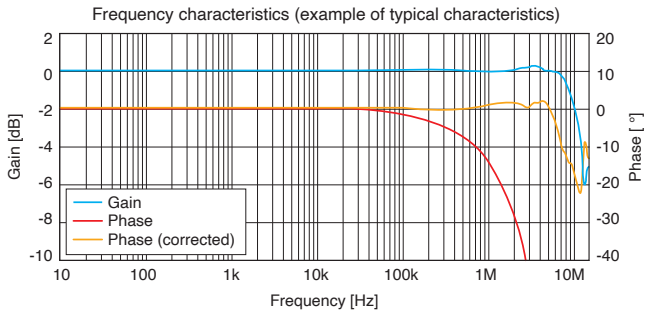
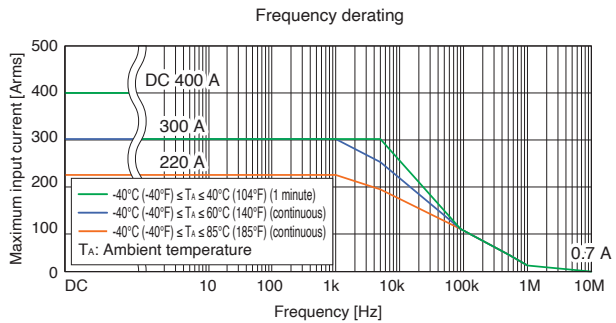

|   |   |
|---|---|
| <b>Output voltage</b>                           | 10 mV/A (= 2 V / 200 A)   |
| <b>Operating temperature and humidity range</b> | -40°C to 85°C (-40°F to 185°F), 80% RH or less (no condensation)                                      |
| <b>Storage temperature and humidity range</b>   | -40°C to 85°C (-40°F to 185°F), 80% RH or less (no condensation)                                      |
| <b>Maximum rated voltage to ground</b>          | 1000 V CAT III<br>Anticipated transient overvoltage: 8000 V   |
| <b>Standards</b>                                | Safety: EN61010, EMC: EN61326   |
| <b>Cable length</b>                             | CT6873: 3 m (9.84 ft.)<br>CT6873-01: 10 m (32.81 ft.)   |
| <b>Dimensions</b>                               | 70 mm (2.76 in.) W x 110 mm (4.33 in.) H x 53 mm (2.09 in.) D (excluding protruding parts and cables) |
| <b>Weight</b>                                   | CT6873: approx. 370 g (13.1 oz.)<br>CT6873-01: approx. 690 g (24.3 oz.)                               |

# CT6875A CT6875A-1



Product warranty period: 3 years  
Guaranteed accuracy period: 1 year

|  |  |
|--|--|
| <b>Rated current</b>                     | 500 AAC/DC   |
| <b>Frequency band</b>                    | CT6875A: DC to 2 MHz (±3 dB)<br>CT6875A-1: DC to 1.5 MHz (±3 dB) |
| <b>Diameter of measurable conductors</b> | Max. φ 36 mm (1.41 in.)  |

### Accuracy

| Frequency            | Amplitude<br>±(% of reading + % of full scale) | Phase           |
|----------------------|--|-----------------|
| DC                   | ±0.04% ±0.008%                                 | -               |
| DC < f < 16 Hz       | ±0.1% ±0.02%                                   | ±0.1°           |
| 16 Hz ≤ f < 45 Hz    | ±0.05% ±0.01%                                  | ±0.1°           |
| 45 Hz ≤ f ≤ 66 Hz    | ±0.04% ±0.008%                                 | ±0.08°          |
| 66 Hz < f ≤ 100 Hz   | ±0.05% ±0.01%                                  | ±0.1°           |
| 100 Hz < f ≤ 500 Hz  | ±0.1% ±0.02%                                   | ±0.2°           |
| 500 Hz < f ≤ 1 kHz   | ±0.2% ±0.02%                                   | ±0.4°           |
| 1 kHz < f ≤ 5 kHz    | ±0.4% ±0.02%                                   | ±0.5°           |
| 5 kHz < f ≤ 10 kHz   | ±0.4% ±0.02%                                   | ±(0.1 × f kHz)° |
| 10 kHz < f ≤ 50 kHz  | ±1.5% ±0.05%                                   | ±(0.1 × f kHz)° |
| 50 kHz < f ≤ 100 kHz | ±2.5% ±0.05%                                   | ±(0.1 × f kHz)° |
| 100 kHz < f ≤ 1 MHz  | ±(0.025 × f kHz)% ±0.05%                       | ±(0.1 × f kHz)° |

Amplitude accuracy: defined 110% f.s. or less, or within the derating curve;  
DC < f < 10 Hz is the value by design.  
Add ±0.01% rdg. to the amplitude accuracy for input from 100% f.s. to 110% f.s.  
For the CT6875A-1, add the following for frequencies of  
1 kHz < f ≤ 1 MHz (the frequency band is 1.5 MHz ±3 dB):  
Amplitude accuracy: ±(0.005 × f kHz)% rdg., Phase accuracy: ±(0.015 × f kHz)°

|   |   |
|---|---|
| <b>Temperature and humidity range for guaranteed accuracy</b> | 0°C to 40°C (32°F to 104°F), 80% RH or less   |
| <b>Effect of temperature</b>                                  | In ranges from -40°C to 0°C (-40°F to 32°F) and 40°C to 85°C (104°F to 185°F)<br>Amplitude sensitivity: ±20 ppm of reading / °C<br>Offset voltage: ±1 ppm of full scale / °C  |
| <b>Common-Mode Rejection Ratio (CMRR)</b>                     | (effect on output voltage and common mode voltage)<br>140 dB or greater (50/60 Hz)<br>120 dB or greater (100 kHz)   |
| <b>Linearity error</b>  | ±5 ppm  |
| <b>Offset error</b>   | ±5 ppm  |
| <b>Amplitude error</b>  | DC: ±10 ppm<br>10 Hz to 100 Hz: ±0.005%<br>100 Hz to 1 kHz: ±0.02%<br>1 kHz to 20 kHz: ±0.08%<br>20 kHz to 100 kHz: ±0.5%<br>100 kHz to 300 kHz: ±1%<br>300 kHz to 1 MHz: ±5% |

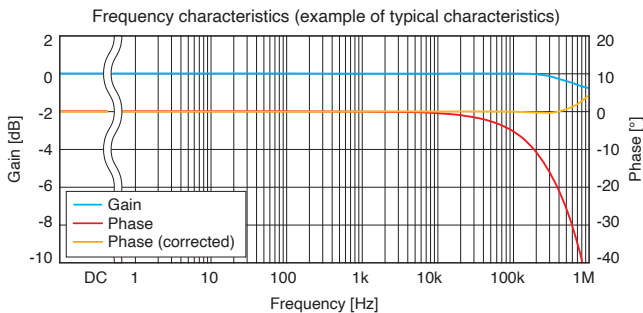
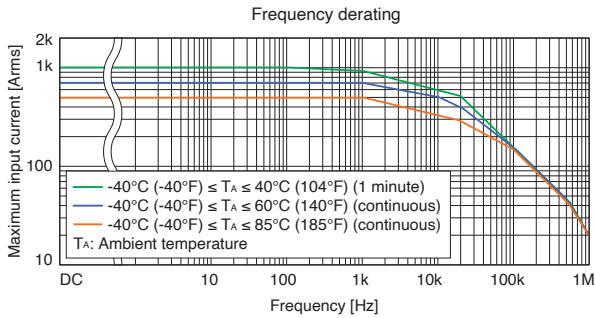

|   |  |
|---|--|
| <b>Output voltage</b>                           | 4 mV/A (= 2 V / 500 A)   |
| <b>Operating temperature and humidity range</b> | -40°C to 85°C (-40°F to 185°F), 80% RH or less (no condensation)                                       |
| <b>Storage temperature and humidity range</b>   | -40°C to 85°C (-40°F to 185°F), 80% RH or less (no condensation)                                       |
| <b>Maximum rated voltage to ground</b>          | 1000 V CAT III<br>Anticipated transient overvoltage: 8000 V  |
| <b>Standards</b>                                | Safety: EN61010, EMC: EN61326  |
| <b>Cable length</b>                             | CT6875A: 3 m (9.84 ft.)<br>CT6875A-1: 10 m (32.81 ft.)   |
| <b>Dimensions</b>                               | 160 mm (6.30 in.) W × 112 mm (4.41 in.) H × 50 mm (1.97 in.) D (excluding protruding parts and cables) |
| <b>Weight</b>                                   | CT6875A: approx. 0.8 kg (28.2 oz.)<br>CT6875A-1: approx. 1.1 kg (38.8 oz.)                             |

# CT6904A CT6904A-1



(CT6904A-1: build-to-order product)

Product warranty period: 3 years  
Guaranteed accuracy period: 1 year

|  |  |
|--|--|
| <b>Rated current</b>                     | 500 A AC/DC  |
| <b>Frequency band</b>                    | CT6904A: DC to 4 MHz (±3 dB)<br>CT6904A-1: DC to 2 MHz (±3 dB) |
| <b>Diameter of measurable conductors</b> | Max. φ 32 mm (1.25 in.)  |

### Accuracy

| Frequency             | Amplitude<br>±(% of reading + % of full scale) | Phase            |
|-----------------------|--|------------------|
| DC                    | ±0.025% ±0.007%                                | -                |
| DC < f < 16 Hz        | ±0.2% ±0.02%                                   | ±0.1°            |
| 16 Hz ≤ f < 45 Hz     | ±0.1% ±0.02%                                   | ±0.1°            |
| 45 Hz ≤ f ≤ 65 Hz     | ±0.02% ±0.007%                                 | ±0.08°           |
| 65 Hz < f ≤ 850 Hz    | ±0.05% ±0.007%                                 | ±0.12°           |
| 850 Hz < f ≤ 1 kHz    | ±0.1% ±0.01%                                   | ±0.4°            |
| 1 kHz < f ≤ 5 kHz     | ±0.4% ±0.02%                                   | ±0.4°            |
| 5 kHz < f ≤ 10 kHz    | ±0.4% ±0.02%                                   | ±(0.08 × f kHz)° |
| 10 kHz < f ≤ 50 kHz   | ±1% ±0.02%                                     | ±(0.08 × f kHz)° |
| 50 kHz < f ≤ 100 kHz  | ±1% ±0.05%                                     | ±(0.08 × f kHz)° |
| 100 kHz < f ≤ 300 kHz | ±2% ±0.05%                                     | ±(0.08 × f kHz)° |
| 300 kHz < f ≤ 1 MHz   | ±5% ±0.05%                                     | ±(0.08 × f kHz)° |

Amplitude accuracy and phase accuracy: defined 110% f.s. or less, or within the derating curve (continuous input at an ambient temperature of 50°C); DC < f < 10 Hz is the value by design.  
Add ±0.01% rdg. to the amplitude accuracy for input from 100% f.s. to 110% f.s.  
For the CT6904A-1, add the following for frequencies of  
50 kHz < f ≤ 1 MHz (the frequency band is 2 MHz ±3 dB):  
Amplitude accuracy: ±(0.015 × f) rdg.

|   |  |
|---|--|
| <b>Temperature and humidity range for guaranteed accuracy</b> | 23°C ±5°C (73°F ±9°F), 80% RH or less  |
| <b>Effect of temperature</b>                                  | In ranges from -10°C to 18°C (14°F to 64.4°F) or 28°C to 50°C (82.4°F to 122°F)<br>Amplitude sensitivity: ±20 ppm of reading / °C<br>Offset voltage: ±1 ppm of full scale / °C<br>Phase: ±0.01°/°C |
| <b>Common-Mode Rejection Ratio (CMRR)</b>                     | (effect on output voltage and common mode voltage)<br>140 dB or greater (50/60 Hz)<br>120 dB or greater (100 kHz)  |
| <b>Linearity error</b>  | ±5 ppm   |
| <b>Offset error</b>   | ±10 ppm  |

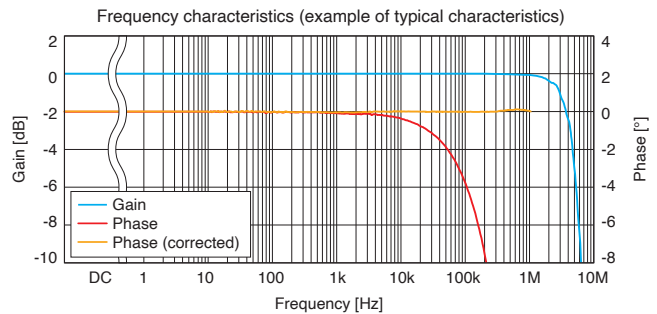
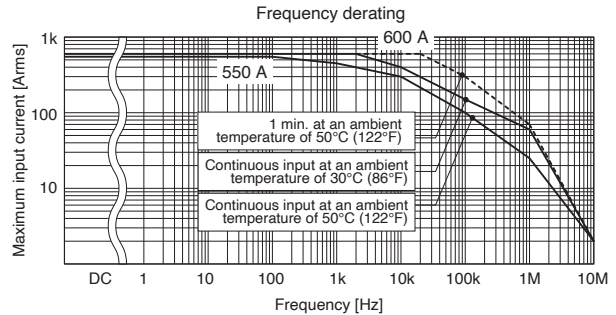

|   |  |
|---|--|
| <b>Output voltage</b>                           | 4 mV/A (= 2 V / 500 A)   |
| <b>Operating temperature and humidity range</b> | -10°C to 50°C (-14°F to 122°F), 80% RH or less (no condensation)                                   |
| <b>Storage temperature and humidity range</b>   | -20°C to 60°C (-4°F to 140°F), 80% RH or less (no condensation)                                    |
| <b>Maximum rated voltage to ground</b>          | 1000 V CAT III<br>Anticipated transient overvoltage: 8000 V  |
| <b>Standards</b>                                | Safety: EN61010, EMC: EN61326  |
| <b>Cable length</b>                             | CT6904A: 3 m (9.84 ft.) (including relay box)<br>CT6904A-1: 10 m (32.81 ft.) (including relay box) |
| <b>Dimensions</b>                               | 139 mm (5.47 in.) W × 120 mm (4.72 in.) H × 52 mm (2.05 in.) D (excluding protrusions and cables)  |
| <b>Weight</b>                                   | CT6904A: approx. 1.05 kg (37.0 oz.)<br>CT6904A-1: approx. 1.35 kg (47.6 oz.)                       |

# CT6904A-2 CT6904A-3

(Build-to-order product)



Product warranty period: 3 years  
Guaranteed accuracy period: 1 year

|  |  |
|--|--|
| <b>Rated current</b>                     | 800 AAC/DC   |
| <b>Frequency band</b>                    | CT6904A-2: DC to 4 MHz (±3 dB)<br>CT6904A-3: DC to 2 MHz (±3 dB) |
| <b>Diameter of measurable conductors</b> | Max. φ 32 mm (1.25 in.)  |

## Accuracy

| Frequency             | Amplitude<br>±(% of reading + % of full scale) | Phase            |
|-----------------------|--|------------------|
| DC                    | ±0.030% ±0.009%                                | -                |
| DC < f < 16 Hz        | ±0.2% ±0.025%                                  | ±0.1°            |
| 16 Hz ≤ f < 45 Hz     | ±0.1% ±0.025%                                  | ±0.1°            |
| 45 Hz ≤ f ≤ 65 Hz     | ±0.025% ±0.009%                                | ±0.08°           |
| 65 Hz < f ≤ 850 Hz    | ±0.05% ±0.009%                                 | ±0.12°           |
| 850 Hz < f ≤ 1 kHz    | ±0.1% ±0.013%                                  | ±0.4°            |
| 1 kHz < f ≤ 5 kHz     | ±0.4% ±0.025%                                  | ±0.4°            |
| 5 kHz < f ≤ 10 kHz    | ±0.4% ±0.025%                                  | ±(0.08 × f kHz)° |
| 10 kHz < f ≤ 50 kHz   | ±1% ±0.025%                                    | ±(0.08 × f kHz)° |
| 50 kHz < f ≤ 100 kHz  | ±1% ±0.063%                                    | ±(0.08 × f kHz)° |
| 100 kHz < f ≤ 300 kHz | ±2% ±0.063%                                    | ±(0.08 × f kHz)° |
| 300 kHz < f ≤ 1 MHz   | ±5% ±0.063%                                    | ±(0.08 × f kHz)° |

Amplitude accuracy and phase accuracy are specified by the following conditions:  
 · Rated value or less  
 · At 100Hz or more and within the range of "Continuous input at an ambient temperature of 50°C (122°F)" described in the frequency derating graph below  
 · For the CT6904A-3, add the following for frequencies of 50 kHz < f ≤ 1 MHz (frequency band is 2 MHz ±3):  
 Amplitude accuracy: ±(0.015 × f) rdg.

|   |   |
|---|---|
| <b>Temperature and humidity range for guaranteed accuracy</b> | 23°C ±5°C (73°F ±9°F), 80% RH or less   |
| <b>Effect of temperature</b>                                  | In ranges from -10°C to 18°C (14°F to 64.4°F) or 28°C to 50°C (82.4°F to 122°F)<br>Amplitude sensitivity: ± 50 ppm of reading / °C<br>Offset voltage: ±5 ppm of full scale / °C<br>Phase: ±0.01° / °C |
| <b>Common-Mode Rejection Ratio (CMRR)</b>                     | (effect on output voltage and common mode voltage)<br>140 dB or greater (50/60 Hz)<br>120 dB or greater (100 kHz)   |
| <b>Linearity error</b>  | ±12.5 ppm   |
| <b>Offset error</b>   | ±10 ppm   |

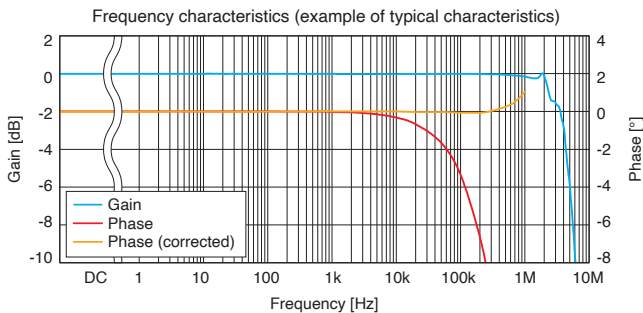
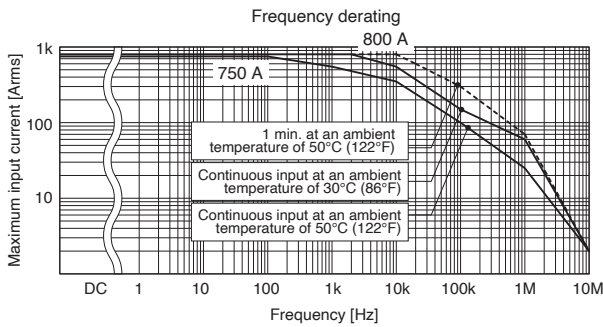

|   |  |
|---|--|
| <b>Output voltage</b>                           | 2 mV/A (= 2 V / 1000 A)  |
| <b>Operating temperature and humidity range</b> | -10°C to 50°C (-14°F to 122°F), 80% RH or less (no condensation)                                     |
| <b>Storage temperature and humidity range</b>   | -20°C to 60°C (-4°F to 140°F), 80% RH or less (no condensation)                                      |
| <b>Maximum rated voltage to ground</b>          | 1000 V CAT III<br>Anticipated transient overvoltage: 8000 V  |
| <b>Standards</b>                                | Safety: EN61010, EMC: EN61326  |
| <b>Cable length</b>                             | CT6904A-2: 3 m (9.84 ft.) (including relay box)<br>CT6904A-3: 10 m (32.81 ft.) (including relay box) |
| <b>Dimensions</b>                               | 139 mm (5.47 in.) W × 120 mm (4.72 in.) H × 52 mm (2.05 in.) D (excluding protrusions and cables)    |
| <b>Weight</b>                                   | CT6904A-2: approx. 1.15 kg (40.6 oz.)<br>CT6904A-3: approx. 1.45 kg (51.1 oz.)                       |

# CT6876A CT6876A-1



Product warranty period: 3 years  
Guaranteed accuracy period: 1 year

|  |  |
|--|--|
| <b>Rated current</b>                     | 1000 A AC/DC   |
| <b>Frequency band</b>                    | CT6876A: DC to 1.5 MHz (±3 dB)<br>CT6876A-1: DC to 1.2 MHz (±3 dB) |
| <b>Diameter of measurable conductors</b> | Max. φ 36 mm (1.41 in.)  |

## Accuracy

| Frequency            | Amplitude<br>±(% of reading + % of full scale) | Phase           |
|----------------------|--|-----------------|
| DC                   | ±0.04% ±0.008%                                 | -               |
| DC < f < 16 Hz       | ±0.1% ±0.02%                                   | ±0.1°           |
| 16 Hz ≤ f < 45 Hz    | ±0.05% ±0.01%                                  | ±0.1°           |
| 45 Hz ≤ f ≤ 66 Hz    | ±0.04% ±0.008%                                 | ±0.08°          |
| 66 Hz < f ≤ 100 Hz   | ±0.05% ±0.01%                                  | ±0.1°           |
| 100 Hz < f ≤ 500 Hz  | ±0.1% ±0.02%                                   | ±0.2°           |
| 500 Hz < f ≤ 1 kHz   | ±0.2% ±0.02%                                   | ±0.4°           |
| 1 kHz < f ≤ 5 kHz    | ±0.5% ±0.02%                                   | ±0.5°           |
| 5 kHz < f ≤ 10 kHz   | ±0.5% ±0.02%                                   | ±(0.1 × f kHz)° |
| 10 kHz < f ≤ 50 kHz  | ±2% ±0.05%                                     | ±(0.1 × f kHz)° |
| 50 kHz < f ≤ 100 kHz | ±3% ±0.05%                                     | ±(0.1 × f kHz)° |
| 100 kHz < f ≤ 1 MHz  | ±(0.03 × f kHz)% ±0.05%                        | ±(0.1 × f kHz)° |

· Amplitude accuracy and phase accuracy: defined 110% f.s. or less or within the derating curve;  
 · DC < f < 10 Hz is the value by design  
 · Add ±0.01% rdg. to the amplitude accuracy for input from 100% f.s. to 110% f.s.  
 · For the CT6876A-1, add the following for frequencies of 1 kHz < f ≤ 1 MHz (the frequency band is 1.2 MHz ±3 dB):  
 Amplitude accuracy: ±(0.005 × f kHz)% rdg., Phase accuracy: ±(0.015 × f kHz)°

|   |  |
|---|--|
| <b>Temperature and humidity range for guaranteed accuracy</b> | 0°C to 40°C (32°F to 104°F), 80% RH or less  |
| <b>Effect of temperature</b>                                  | In ranges from -40°C to 0°C (-40°F to 32°F) and 40°C to 85°C (104°F to 185°F)<br>Amplitude sensitivity: ±20 ppm of reading / °C<br>Offset voltage: ±1 ppm of full scale / °C |
| <b>Common-Mode Rejection Ratio (CMRR)</b>                     | (effect on output voltage and common mode voltage)<br>140 dB or greater (50/60 Hz)<br>120 dB or greater (100 kHz)  |
| <b>Linearity error</b>  | ±5 ppm   |
| <b>Offset error</b>   | ±5 ppm   |
| <b>Amplitude error</b>  | DC: ±10 ppm<br>10 Hz to 100 Hz: ±0.005%<br>100 Hz to 1 kHz: ±0.03%<br>1 kHz to 10 kHz: ±0.2%<br>10 kHz to 100 kHz: ±1%<br>100 kHz to 300 kHz: ±3%<br>300 kHz to 1 MHz: ±15%  |

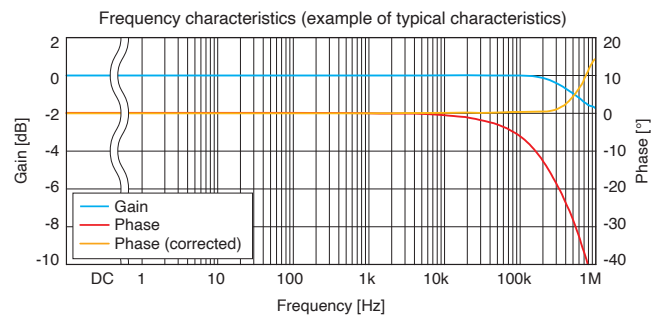
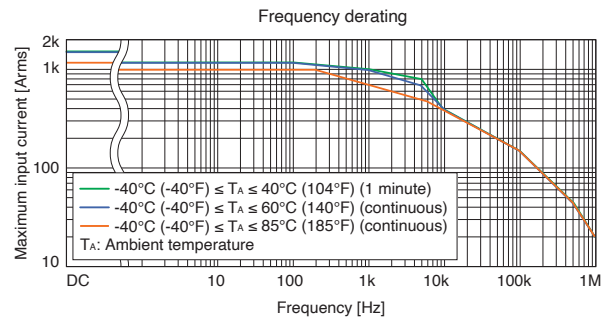

|   |  |
|---|--|
| <b>Output voltage</b>                           | 2 mV/A (= 2 V / 1000 A)  |
| <b>Operating temperature and humidity range</b> | -40°C to 85°C (-40°F to 185°F), 80% RH or less (no condensation)                                       |
| <b>Storage temperature and humidity range</b>   | -40°C to 85°C (-40°F to 185°F), 80% RH or less (no condensation)                                       |
| <b>Maximum rated voltage to ground</b>          | 1000 V CAT III<br>Anticipated transient overvoltage: 8000 V  |
| <b>Standards</b>                                | Safety: EN61010, EMC: EN61326  |
| <b>Cable length</b>                             | CT6876A: 3 m (9.84 ft.)<br>CT6876A-1: 10 m (32.81 ft.)   |
| <b>Dimensions</b>                               | 160 mm (6.30 in.) W × 112 mm (4.41 in.) H × 50 mm (1.97 in.) D (excluding protruding parts and cables) |
| <b>Weight</b>                                   | CT6876A: approx. 0.95 kg (33.5 oz.)<br>CT6876A-1: approx. 1.25 kg (44.1 oz.)                           |

# CT6877A CT6877A-1



Product warranty period: 3 years  
Guaranteed accuracy period: 1 year

|  |                         |
|--|-------------------------|
| <b>Rated current</b>                     | 2000 A AC/DC            |
| <b>Frequency band</b>                    | DC to 1 MHz             |
| <b>Diameter of measurable conductors</b> | Max. φ 80 mm (3.14 in.) |

### Accuracy

| Frequency             | Amplitude<br>±(% of reading + % of full scale) | Phase                 |
|-----------------------|--|-----------------------|
| DC                    | ±0.04% ±0.008%                                 | -                     |
| DC < f < 16 Hz        | ±0.1% ±0.02%                                   | ±0.1°                 |
| 16 Hz ≤ f < 45 Hz     | ±0.05% ±0.01%                                  | ±0.1°                 |
| 45 Hz ≤ f ≤ 66 Hz     | ±0.04% ±0.008%                                 | ±0.08°                |
| 66 Hz < f ≤ 100 Hz    | ±0.05% ±0.01%                                  | ±0.1°                 |
| 100 Hz < f ≤ 500 Hz   | ±0.1% ±0.02%                                   | ±0.2°                 |
| 500 Hz < f ≤ 1 kHz    | ±0.2% ±0.02%                                   | ±0.4°                 |
| 1 kHz < f ≤ 5 kHz     | ±0.5% ±0.02%                                   | ±(0.3 + 0.1 × f kHz)° |
| 5 kHz < f ≤ 10 kHz    | ±0.5% ±0.02%                                   | ±(0.3 + 0.1 × f kHz)° |
| 10 kHz < f ≤ 50 kHz   | ±1.5% ±0.05%                                   | ±(0.3 + 0.1 × f kHz)° |
| 50 kHz < f ≤ 100 kHz  | ±2.5% ±0.05%                                   | ±(0.3 + 0.1 × f kHz)° |
| 100 kHz < f ≤ 700 kHz | ±(0.025 × f)% ±0.05%                           | ±(0.3 + 0.1 × f kHz)° |

· Amplitude accuracy and phase accuracy: defined 110% f.s. or less, or within the derating curve, DC < f < 10 Hz is the value by design  
 · Add ±0.01% rdg. to the amplitude accuracy for input from 100% f.s. to 110% f.s.  
 · For the CT6877A-1, add the following for frequencies of 1 kHz < f ≤ 700 kHz:  
 Amplitude accuracy: ±(0.005 × f)% rdg., Phase accuracy: ±(0.015 × f)°

|   |  |  |
|---|--|--|
| <b>Temperature and humidity range for guaranteed accuracy</b> | 0°C to 40°C (32°F to 104°F), 80% RH or less  |  |
| <b>Effect of temperature</b>                                  | In ranges from -40°C to 0°C (-40°F to 32°F) and 40°C to 85°C (104°F to 185°F)<br>Amplitude sensitivity: ±15 ppm of reading / °C<br>Offset voltage: ±0.5 ppm of full scale / °C |  |
| <b>Common-Mode Rejection Ratio (CMRR)</b>                     | (effect on output voltage and common mode voltage)<br>140 dB or greater (50/60 Hz)<br>120 dB or greater (100 kHz)  |  |
| <b>Linearity error</b>  | ±10 ppm  |  |
| <b>Offset error</b>   | ±5 ppm   |  |
| <b>Amplitude error</b>  | DC: ±15 ppm  | 10 kHz to 100 kHz: ±1%<br>10 Hz to 100 Hz: ±0.01%<br>100 kHz to 300 kHz: ±2%<br>100 Hz to 1 kHz: ±0.04%<br>300 kHz to 700 kHz: ±10%<br>1 kHz to 10 kHz: ±0.25% |

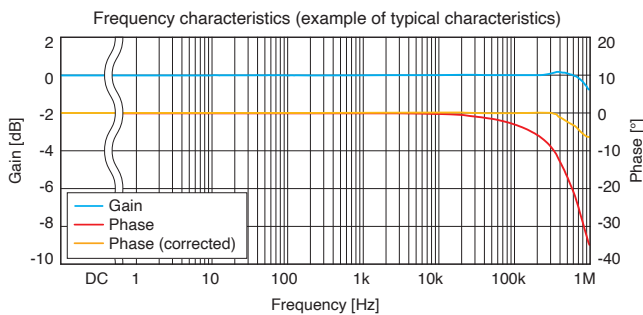
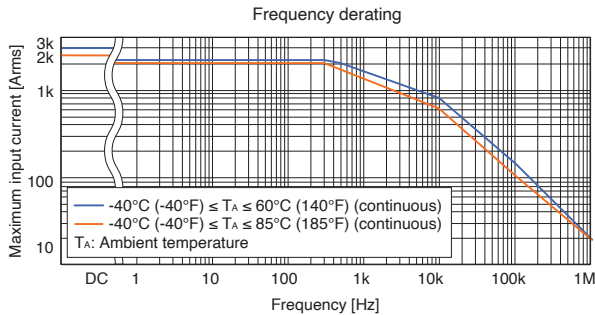

|   |   |
|---|---|
| <b>Output voltage</b>                           | 1 mV/A (= 2 V / 2000 A)   |
| <b>Operating temperature and humidity range</b> | -40°C to 85°C (-40°F to 185°F), 80% RH or less (no condensation)  |
| <b>Storage temperature and humidity range</b>   | -40°C to 85°C (-40°F to 185°F), 80% RH or less (no condensation)  |
| <b>Maximum rated voltage to ground</b>          | 1000 V CAT III<br>Anticipated transient overvoltage: 8000 V   |
| <b>Standards</b>                                | Safety: EN61010, EMC: EN61326   |
| <b>Cable length</b>                             | CT6877A: 3 m (9.84 ft.)<br>CT6877A-1: 10 m (32.81 ft.)  |
| <b>Dimensions</b>                               | 229 mm (9.02 in.) W × 232 mm (9.13 in.) H × 112 mm (4.41 in.) D (excluding protruding parts and cables) |
| <b>Weight</b>                                   | CT6877A: approx. 5 kg (176.4 oz.)<br>CT6877A-1: approx. 5.3 kg (187.0 oz.)                              |

# PW9100A-3 PW9100A-4



Product warranty period: 3 years  
Guaranteed accuracy period: 1 year

|                                     |                             |
|-------------------------------------|-----------------------------|
| <b>Rated current</b>                | 50 A AC/DC                  |
| <b>Frequency band</b>               | DC to 3.5 MHz               |
| <b>Input and measurement method</b> | Isolated input, DCCT* input |
| <b>Measurement terminals</b>        | Terminal block M6 screws    |

\*Direct Connection Current Transducer

### Accuracy

| Frequency             | Amplitude<br>±(% of reading + % of full scale) | Phase            |
|-----------------------|--|------------------|
| DC                    | ±0.02% ±0.007%                                 | -                |
| DC < f < 30 Hz        | ±0.1% ±0.02%                                   | ±0.3°            |
| 30 Hz ≤ f < 45 Hz     | ±0.1% ±0.02%                                   | ±0.1°            |
| 45 Hz ≤ f ≤ 65 Hz     | ±0.02% ±0.005%                                 | ±0.1°            |
| 65 Hz < f ≤ 500 Hz    | ±0.1% ±0.01%                                   | ±0.12°           |
| 500 Hz < f ≤ 1 kHz    | ±0.1% ±0.01%                                   | ±0.5°            |
| 1 kHz < f ≤ 5 kHz     | ±0.5% ±0.02%                                   | ±0.5°            |
| 5 kHz < f ≤ 20 kHz    | ±1% ±0.02%                                     | ±1°              |
| 20 kHz < f ≤ 50 kHz   | ±1% ±0.02%                                     | ±(0.05 × f kHz)° |
| 50 kHz < f ≤ 100 kHz  | ±2% ±0.05%                                     | ±(0.06 × f kHz)° |
| 100 kHz < f ≤ 300 kHz | ±5% ±0.05%                                     | ±(0.06 × f kHz)° |
| 300 kHz < f ≤ 700 kHz | ±5% ±0.05%                                     | ±(0.07 × f kHz)° |
| 700 kHz < f ≤ 1 MHz   | ±10% ±0.05%                                    | ±(0.07 × f kHz)° |

· Amplitude accuracy and phase accuracy: defined within the accuracy guarantee range shown in the derating figure below; DC < f < 10 Hz is the value by design.  
 · Add ±0.01% rdg. to the amplitude accuracy for input from 100% f.s. to 110% f.s.

|   |   |
|---|---|
| <b>Temperature and humidity range for guaranteed accuracy</b> | 23°C ±5°C (73°F ±9°F), 80% RH or less   |
| <b>Effect of temperature</b>                                  | In ranges from 0°C to 18°C (32°F to 64°F) and 28°C to 40°C (82°F to 104°F)<br>Amplitude sensitivity: ±20 ppm of reading / °C<br>Offset voltage: ±1 ppm of full scale / °C<br>Phase: ±0.01° / °C |
| <b>Common-Mode Rejection Ratio (CMRR)</b>                     | (effect on output voltage and common mode voltage)<br>120 dB or greater (50/60 Hz, 100 kHz)   |

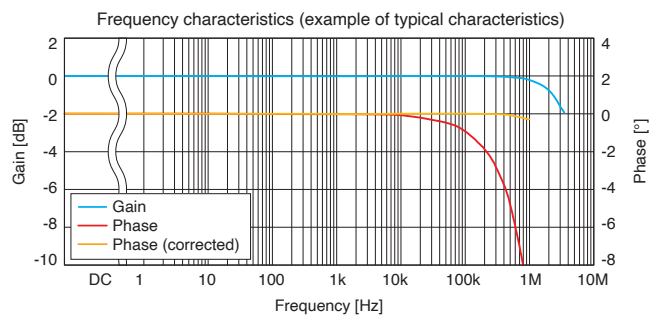
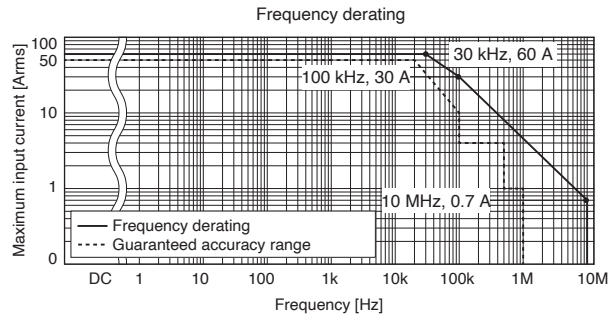

|   |  |
|---|--|
| <b>Output voltage</b>                           | 40 mV/A (= 2 V / 50 A)   |
| <b>Operating temperature and humidity range</b> | 0°C to 40°C (32°F to 104°F), 80% RH or less (no condensation)                  |
| <b>Storage temperature and humidity range</b>   | -10°C to 50°C (14°F to 122°F), 80% RH or less (no condensation)                |
| <b>Maximum rated voltage to ground</b>          | 600 V CAT III, 1000 V CAT II<br>Anticipated transient overvoltage: 6000 V      |
| <b>Standards</b>                                | Safety: EN 61010, EMC: EN 61326 Class A  |
| <b>Cable length</b>                             | 0.8 m (2.62 ft.)   |
| <b>Dimensions</b>                               | 430 mm (16.9 in.) W × 88 mm (3.46 in.) H × 260 mm (10.23 in.) D                |
| <b>Weight</b>                                   | PW9100A-3: approx. 3.7 kg (130.5 oz.)<br>PW9100A-4: approx. 4.3 kg (151.7 oz.) |



### CT6841-05



Product warranty period: 3 years  
Guaranteed accuracy period: 1 year

|  |                              |
|--|------------------------------|
| <b>Rated current</b>                     | 20 A AC/DC                   |
| <b>Frequency band</b>                    | DC to 1 MHz                  |
| <b>Diameter of measurable conductors</b> | Max. $\phi$ 20 mm (0.79 in.) |

#### Accuracy

| Frequency                  | Amplitude<br>$\pm$ (% of reading + % of full scale) | Phase  |
|----------------------------|---|--|
| DC                         | $\pm 0.3\% \pm 0.05\%^*$                            | -  |
| DC < f $\leq$ 100 Hz       | $\pm 0.3\% \pm 0.01\%$                              | $\pm 0.1^\circ$                              |
| 100 Hz < f $\leq$ 500 Hz   | $\pm 0.3\% \pm 0.02\%$                              | $\pm 0.2^\circ$                              |
| 500 Hz < f $\leq$ 1 kHz    | $\pm 0.5\% \pm 0.02\%$                              | $\pm 0.5^\circ$                              |
| 1 kHz < f $\leq$ 5 kHz     | $\pm 1.0\% \pm 0.02\%$                              | $\pm 1.0^\circ$                              |
| 5 kHz < f $\leq$ 10 kHz    | $\pm 1.5\% \pm 0.02\%$                              | $\pm 1.5^\circ$                              |
| 10 kHz < f $\leq$ 50 kHz   | $\pm 2.0\% \pm 0.02\%$                              | $\pm (0.5 + 0.1 \times f \text{ kHz})^\circ$ |
| 50 kHz < f $\leq$ 100 kHz  | $\pm 5.0\% \pm 0.05\%$                              | $\pm (0.5 + 0.1 \times f \text{ kHz})^\circ$ |
| 100 kHz < f $\leq$ 300 kHz | $\pm 10\% \pm 0.05\%$                               | $\pm (0.5 + 0.1 \times f \text{ kHz})^\circ$ |
| 300 kHz < f $\leq$ 500 kHz | $\pm 15\% \pm 0.05\%$                               | -  |
| 500 kHz < f < 1 MHz        | $\pm 30\% \pm 0.05\%$                               | -  |

\* $\pm 0.05\%$  f.s. after adjusting the offset voltage to  $\pm 0.5$  mV or less.

The values above are when the input is a sine wave, the conductor is in the center of the sensor opening, and the measurement instrument's input resistance is 1 M $\Omega$  or higher.  
Amplitude accuracy: defined at the rated value, or less or within the derating curve;  
DC < f < 5 Hz is the value by design.  
Phase accuracy: defined at the rated value or less or within the derating curve;  
DC < f < 10 Hz is the value by design.

|   |  |
|---|--|
| <b>Temperature and humidity range for guaranteed accuracy</b> | 0°C to 40°C (32°F to 104°F), 80% RH or less  |
| <b>Effect of temperature</b>                                  | In ranges from -40°C to 0°C (-40°F to 32°F) and 40°C to 85°C (104°F to 185°F)<br>Amplitude sensitivity: $\pm 0.01\%$ of reading / °C<br>Offset voltage: $\pm 0.005\%$ of full scale / °C |
| <b>Effect of common mode voltage</b>                          | 0.05% f.s. or less (1000 Vrms, DC to 100 Hz)   |

Frequency derating

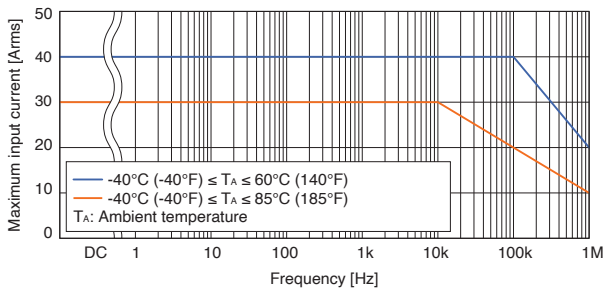

Frequency characteristics (example of typical characteristics)

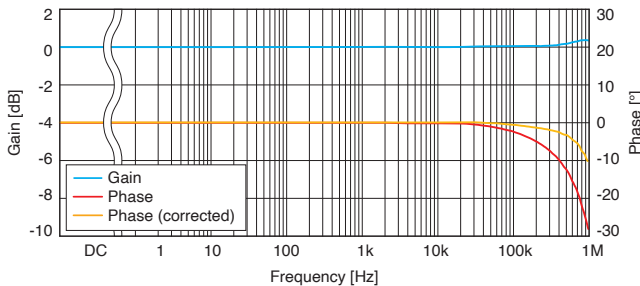

|   |   |
|---|---|
| <b>Output voltage</b>                           | 100 mV/A (= 2 V / 20 A)   |
| <b>Measurable conductors</b>                    | Insulated conductor   |
| <b>Operating temperature and humidity range</b> | -40°C to 85°C (-40°F to 185°F), 80% RH or less (no condensation)                                      |
| <b>Storage temperature and humidity range</b>   | -40°C to 85°C (-40°F to 185°F), 80% RH or less (no condensation)                                      |
| <b>Withstand voltage</b>                        | 4260 V AC<br>Withstand test current of 1 mA, 50/60 Hz, 1 min., between jaws and cable output terminal |
| <b>Standards</b>                                | Safety: EN 61010, EMC: EN 61326   |
| <b>Cable length</b>                             | 3 m (9.84 ft.)  |
| <b>Dimensions</b>                               | 153 mm (6.02 in.) W x 67 mm (2.64 in.) H x 25 mm (0.98 in.) D (excluding protruding parts and cables) |
| <b>Weight</b>                                   | Approx. 350 g (12.3 oz.)  |

### CT6843-05



Product warranty period: 3 years  
Guaranteed accuracy period: 1 year

|  |                              |
|--|------------------------------|
| <b>Rated current</b>                     | 200 A AC/DC                  |
| <b>Frequency band</b>                    | DC to 500 kHz                |
| <b>Diameter of measurable conductors</b> | Max. $\phi$ 20 mm (0.79 in.) |

#### Accuracy

| Frequency                  | Amplitude<br>$\pm$ (% of reading + % of full scale) | Phase  |
|----------------------------|---|--|
| DC                         | $\pm 0.3\% \pm 0.02\%^*$                            | -  |
| DC < f $\leq$ 100 Hz       | $\pm 0.3\% \pm 0.01\%$                              | $\pm 0.1^\circ$                              |
| 100 Hz < f $\leq$ 500 Hz   | $\pm 0.3\% \pm 0.02\%$                              | $\pm 0.2^\circ$                              |
| 500 Hz < f $\leq$ 1 kHz    | $\pm 0.5\% \pm 0.02\%$                              | $\pm 0.5^\circ$                              |
| 1 kHz < f $\leq$ 5 kHz     | $\pm 1.0\% \pm 0.02\%$                              | $\pm 1.0^\circ$                              |
| 5 kHz < f $\leq$ 10 kHz    | $\pm 1.5\% \pm 0.02\%$                              | $\pm 1.5^\circ$                              |
| 10 kHz < f $\leq$ 50 kHz   | $\pm 5.0\% \pm 0.02\%$                              | $\pm (0.5 + 0.1 \times f \text{ kHz})^\circ$ |
| 50 kHz < f $\leq$ 100 kHz  | $\pm 15\% \pm 0.05\%$                               | $\pm (0.5 + 0.1 \times f \text{ kHz})^\circ$ |
| 100 kHz < f $\leq$ 300 kHz | $\pm 15\% \pm 0.05\%$                               | $\pm (0.5 + 0.1 \times f \text{ kHz})^\circ$ |
| 300 kHz < f $\leq$ 500 kHz | $\pm 30\% \pm 0.05\%$                               | -  |

\* $\pm 0.02\%$  f.s. after adjusting the offset voltage to  $\pm 0.2$  mV or less

The values above are when the input is a sine wave, the conductor is in the center of the sensor opening, and the measurement instrument's input resistance is 1 M $\Omega$  or higher.  
Amplitude accuracy: defined at the rated value or less or within the derating curve;  
DC < f < 5 Hz is the value by design.  
Phase accuracy: defined at the rated value or less or within the derating curve;  
DC < f < 10 Hz is the value by design.

|   |  |
|---|--|
| <b>Temperature and humidity range for guaranteed accuracy</b> | 0°C to 40°C (32°F to 104°F), 80% RH or less  |
| <b>Effect of temperature</b>                                  | In ranges from -40°C to 0°C (-40°F to 32°F) and 40°C to 85°C (104°F to 185°F)<br>Amplitude sensitivity: $\pm 0.01\%$ of reading / °C<br>Offset voltage: $\pm 0.005\%$ of full scale / °C |
| <b>Effect of common mode voltage</b>                          | 0.05% f.s. or less (1000 Vrms, DC to 100 Hz)   |

Frequency derating

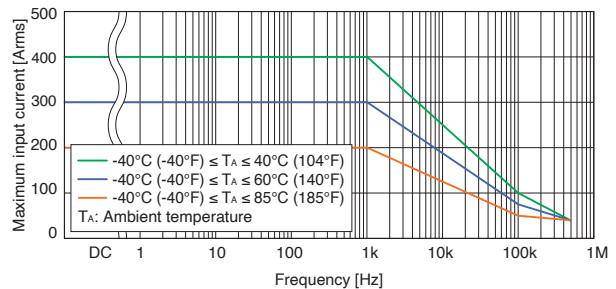

Frequency characteristics (example of typical characteristics)

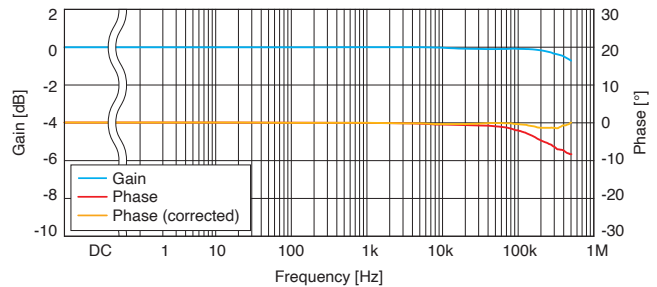

|   |   |
|---|---|
| <b>Output voltage</b>                           | 10 mV/A (= 2 V / 200 A)   |
| <b>Measurable conductors</b>                    | Insulated conductor   |
| <b>Operating temperature and humidity range</b> | -40°C to 85°C (-40°F to 185°F), 80% RH or less (no condensation)                                      |
| <b>Storage temperature and humidity range</b>   | -40°C to 85°C (-40°F to 185°F), 80% RH or less (no condensation)                                      |
| <b>Withstand voltage</b>                        | 4260 V AC<br>Withstand test current of 1 mA, 50/60 Hz, 1 min., between jaws and cable output terminal |
| <b>Standards</b>                                | Safety: EN 61010, EMC: EN 61326   |
| <b>Cable length</b>                             | 3 m (9.84 ft.)  |
| <b>Dimensions</b>                               | 153 mm (6.02 in.) W x 67 mm (2.64 in.) H x 25 mm (0.98 in.) D (excluding protruding parts and cables) |
| <b>Weight</b>                                   | Approx. 370 g (13.1 oz.)  |

## CT6844-05



Product warranty period: 3 years  
Guaranteed accuracy period: 1 year

|  |                              |
|--|------------------------------|
| <b>Rated current</b>                     | 500 A AC/DC                  |
| <b>Frequency band</b>                    | DC to 200 kHz                |
| <b>Diameter of measurable conductors</b> | Max. $\phi$ 20 mm (0.79 in.) |

## Accuracy

| Frequency                  | Amplitude<br>$\pm$ (% of reading + % of full scale) | Phase                                       |
|----------------------------|---|---|
| DC                         | $\pm 0.3\% \pm 0.02\%^*$                            | -   |
| DC < f $\leq$ 100 Hz       | $\pm 0.3\% \pm 0.01\%$                              | $\pm 0.1^\circ$                             |
| 100 Hz < f $\leq$ 500 Hz   | $\pm 0.3\% \pm 0.02\%$                              | $\pm 0.2^\circ$                             |
| 500 Hz < f $\leq$ 1 kHz    | $\pm 0.5\% \pm 0.02\%$                              | $\pm 0.5^\circ$                             |
| 1 kHz < f $\leq$ 5 kHz     | $\pm 1.0\% \pm 0.02\%$                              | $\pm 1.0^\circ$                             |
| 5 kHz < f $\leq$ 10 kHz    | $\pm 1.5\% \pm 0.02\%$                              | $\pm 1.5^\circ$                             |
| 10 kHz < f $\leq$ 50 kHz   | $\pm 5.0\% \pm 0.02\%$                              | $\pm(0.5 + 0.1 \times f \text{ kHz})^\circ$ |
| 50 kHz < f $\leq$ 100 kHz  | $\pm 15\% \pm 0.05\%$                               | $\pm(0.5 + 0.1 \times f \text{ kHz})^\circ$ |
| 100 kHz < f $\leq$ 200 kHz | $\pm 30\% \pm 0.05\%$                               | $\pm(0.5 + 0.1 \times f \text{ kHz})^\circ$ |

\* $\pm 0.02\%$  f.s. after adjusting the offset voltage to  $\pm 0.2$  mV or less

The values above are when the input is a sine wave, the conductor is in the center of the sensor opening, and the measurement instrument's input resistance is 1 M $\Omega$  or higher.  
Amplitude accuracy: defined at the rated value or less or within the derating curve;  
DC < f < 5 Hz is the value by design.  
Phase accuracy: defined at the rated value or less, or within the derating curve;  
DC < f < 10 Hz is the value by design.

|   |  |
|---|--|
| <b>Temperature and humidity range for guaranteed accuracy</b> | 0°C to 40°C (32°F to 104°F), 80% RH or less  |
| <b>Effect of temperature</b>                                  | In ranges from -40°C to 0°C (-40°F to 32°F) and 40°C to 85°C (104°F to 185°F)<br>Amplitude sensitivity: $\pm 0.01\%$ of reading / °C<br>Offset voltage: $\pm 0.005\%$ of full scale / °C |
| <b>Effect of common mode voltage</b>                          | 0.05% f.s. or less (1000 Vrms, DC to 100 Hz)   |

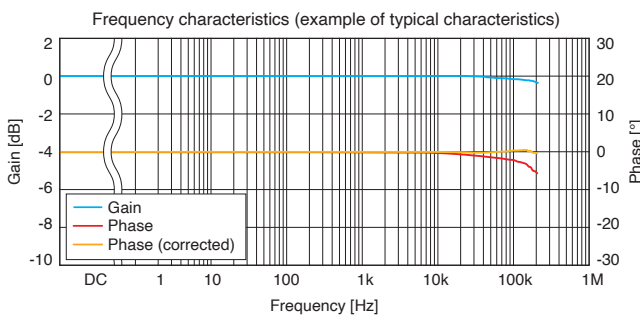
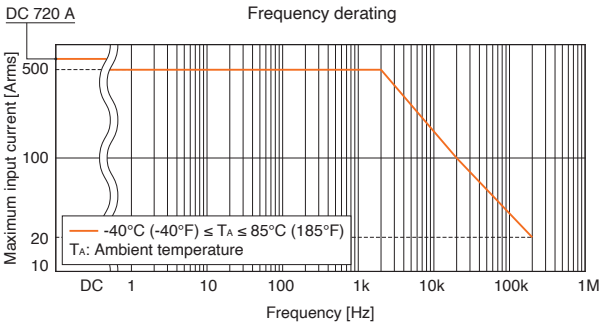

|   |   |
|---|---|
| <b>Output voltage</b>                           | 4 mV/A (= 2 V / 500 A)  |
| <b>Measurable conductors</b>                    | Insulated conductor   |
| <b>Operating temperature and humidity range</b> | -40°C to 85°C (-40°F to 185°F), 80% RH or less (no condensation)  |
| <b>Storage temperature and humidity range</b>   | -40°C to 85°C (-40°F to 185°F), 80% RH or less (no condensation)  |
| <b>Withstand voltage</b>                        | 4260 V AC<br>Withstand test current of 1 mA, 50/60 Hz, 1 min., between jaws and cable output terminal               |
| <b>Standards</b>                                | Safety: EN 61010, EMC: EN 61326   |
| <b>Cable length</b>                             | 3 m (9.84 ft.)  |
| <b>Dimensions</b>                               | 153 mm (6.02 in.) W $\times$ 67 mm (2.64 in.) H $\times$ 25 mm (0.98 in.) D (excluding protruding parts and cables) |
| <b>Weight</b>                                   | Approx. 400 g (14.1 oz.)  |

## CT6845-05



Product warranty period: 3 years  
Guaranteed accuracy period: 1 year

|  |                              |
|--|------------------------------|
| <b>Rated current</b>                     | 500 A AC/DC                  |
| <b>Frequency band</b>                    | DC to 100 kHz                |
| <b>Diameter of measurable conductors</b> | Max. $\phi$ 50 mm (1.97 in.) |

## Accuracy

| Frequency                 | Amplitude<br>$\pm$ (% of reading + % of full scale) | Phase                                 |
|---------------------------|---|---------------------------------------|
| DC                        | $\pm 0.3\% \pm 0.02\%^*$                            | -                                     |
| DC < f $\leq$ 100 Hz      | $\pm 0.3\% \pm 0.01\%$                              | $\pm 0.1^\circ$                       |
| 100 Hz < f $\leq$ 500 Hz  | $\pm 0.3\% \pm 0.02\%$                              | $\pm 0.2^\circ$                       |
| 500 Hz < f $\leq$ 1 kHz   | $\pm 0.5\% \pm 0.02\%$                              | $\pm 0.5^\circ$                       |
| 1 kHz < f $\leq$ 5 kHz    | $\pm 1.0\% \pm 0.02\%$                              | $\pm 1.5^\circ$                       |
| 5 kHz < f $\leq$ 10 kHz   | $\pm 1.5\% \pm 0.02\%$                              | $\pm 2.0^\circ$                       |
| 10 kHz < f $\leq$ 20 kHz  | $\pm 5.0\% \pm 0.02\%$                              | $\pm(0.2 \times f \text{ kHz})^\circ$ |
| 20 kHz < f $\leq$ 50 kHz  | $\pm 10\% \pm 0.05\%$                               | $\pm(0.2 \times f \text{ kHz})^\circ$ |
| 50 kHz < f $\leq$ 100 kHz | $\pm 30\% \pm 0.05\%$                               | $\pm(0.2 \times f \text{ kHz})^\circ$ |

\* $\pm 0.02\%$  f.s. after adjusting the offset voltage to  $\pm 0.2$  mV or less

The values above are when the input is a sine wave, the conductor is in the center of the sensor opening, and the measurement instrument's input resistance is 1 M $\Omega$  or higher.  
Amplitude accuracy: defined at the rated value or less, or within the derating curve;  
DC < f < 5 Hz is the value by design.  
Phase accuracy: defined at the rated value or less, or within the derating curve;  
DC < f < 10 Hz is the value by design.

|   |  |
|---|--|
| <b>Temperature and humidity range for guaranteed accuracy</b> | 0°C to 40°C (32°F to 104°F), 80% RH or less  |
| <b>Effect of temperature</b>                                  | In ranges from -40°C to 0°C (-40°F to 32°F) and 40°C to 85°C (104°F to 185°F)<br>Amplitude sensitivity: $\pm 0.01\%$ of reading / °C<br>Offset voltage: $\pm 0.005\%$ of full scale / °C |
| <b>Effect of common mode voltage</b>                          | 0.05% f.s. or less (1000 Vrms, DC to 100 Hz)   |

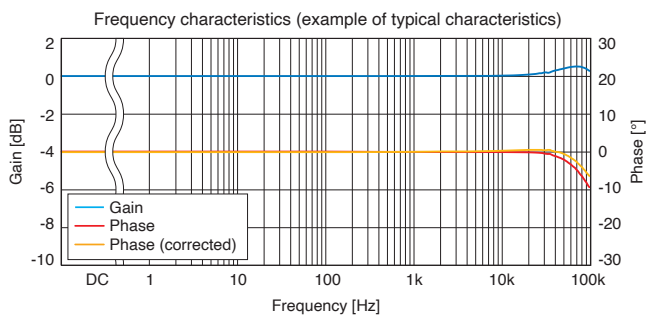
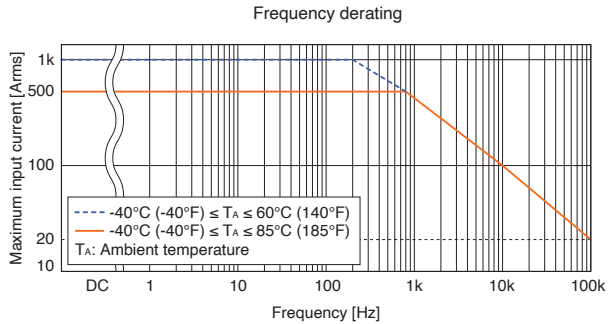

|   |  |
|---|--|
| <b>Output voltage</b>                           | 4 mV/A (= 2 V / 500 A)   |
| <b>Measurable conductors</b>                    | Insulated conductor  |
| <b>Operating temperature and humidity range</b> | -40°C to 85°C (-40°F to 185°F), 80% RH or less (no condensation)   |
| <b>Storage temperature and humidity range</b>   | -40°C to 85°C (-40°F to 185°F), 80% RH or less (no condensation)   |
| <b>Withstand voltage</b>                        | 4260 V AC<br>Withstand test current of 1 mA, 50/60 Hz, 1 min., between jaws and cable output terminal                |
| <b>Standards</b>                                | Safety: EN 61010, EMC: EN 61326  |
| <b>Cable length</b>                             | 3 m (9.84 ft.)   |
| <b>Dimensions</b>                               | 238 mm (9.37 in.) W $\times$ 116 mm (4.57 in.) H $\times$ 35 mm (1.38 in.) D (excluding protruding parts and cables) |
| <b>Weight</b>                                   | Approx. 860 g (30.3 oz.)   |

# CT6846-05



Product warranty period: 3 years  
Guaranteed accuracy period: 1 year

|  |                              |
|--|------------------------------|
| <b>Rated current</b>                     | 1000 A AC/DC                 |
| <b>Frequency band</b>                    | DC to 20 kHz                 |
| <b>Diameter of measurable conductors</b> | Max. $\phi$ 50 mm (1.97 in.) |

## Accuracy

| Frequency                | Amplitude<br>$\pm$ (% of reading + % of full scale) | Phase            |
|--------------------------|---|------------------|
| DC                       | $\pm 0.3\% \pm 0.02\%^*$                            | -                |
| DC < f $\leq$ 100 Hz     | $\pm 0.3\% \pm 0.01\%$                              | $\pm 0.1^\circ$  |
| 100 Hz < f $\leq$ 500 Hz | $\pm 0.5\% \pm 0.02\%$                              | $\pm 0.2^\circ$  |
| 500 Hz < f $\leq$ 1 kHz  | $\pm 1.0\% \pm 0.02\%$                              | $\pm 0.5^\circ$  |
| 1 kHz < f $\leq$ 5 kHz   | $\pm 2.0\% \pm 0.02\%$                              | $\pm 1.5^\circ$  |
| 5 kHz < f $\leq$ 10 kHz  | $\pm 5.0\% \pm 0.05\%$                              | $\pm 2.0^\circ$  |
| 10 kHz < f $\leq$ 20 kHz | $\pm 30\% \pm 0.10\%$                               | $\pm 10.0^\circ$ |

\* $\pm 0.02\%$  f.s. after adjusting the offset voltage to  $\pm 0.2$  mV or less

The values above are when the input is a sine wave, the conductor is in the center of the sensor opening, and the measurement instrument's input resistance is 1 M $\Omega$  or higher.  
Amplitude accuracy: defined at the rated value or less, or within the derating curve;  
DC < f < 5 Hz is the value by design.  
Phase accuracy: defined at the rated value or less, or within the derating curve;  
DC < f < 10 Hz is the value by design.

|   |   |
|---|---|
| <b>Temperature and humidity range for guaranteed accuracy</b> | 0°C to 40°C (32°F to 104°F), 80% RH or less   |
| <b>Effect of temperature</b>                                  | In ranges from -40°C to 0°C (-40°F to 32°F) and 40°C to 85°C (104°F to 185°F)<br>Amplitude sensitivity: $\pm 0.01\%$ of reading /°C<br>Offset voltage: $\pm 0.005\%$ of full scale / °C |
| <b>Effect of common mode voltage</b>                          | 0.05% f.s. or less (1000 Vrms, DC to 100 Hz)  |

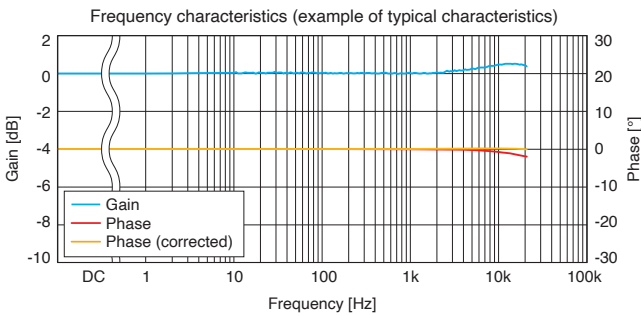
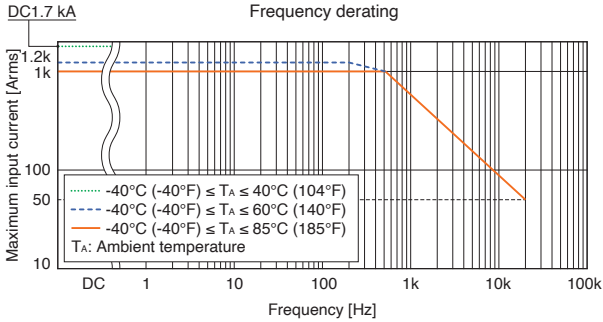

|   |  |
|---|--|
| <b>Output voltage</b>                           | 2 mV/A (= 2 V / 1000 A)  |
| <b>Measurable conductors</b>                    | Insulated conductor  |
| <b>Operating temperature and humidity range</b> | -40°C to 85°C (-40°F to 185°F), 80% RH or less (no condensation)                                       |
| <b>Storage temperature and humidity range</b>   | -40°C to 85°C (-40°F to 185°F), 80% RH or less (no condensation)                                       |
| <b>Withstand voltage</b>                        | 4260 V AC<br>Withstand test current of 1 mA, 50/60 Hz, 1 min., between jaws and cable output terminal  |
| <b>Standards</b>                                | Safety: EN 61010, EMC: EN 61326  |
| <b>Cable length</b>                             | 3 m (9.84 ft.)   |
| <b>Dimensions</b>                               | 238 mm (9.37 in.) W x 116 mm (4.57 in.) H x 35 mm (1.38 in.) D (excluding protruding parts and cables) |
| <b>Weight</b>                                   | Approx. 990 g (34.9 oz.)   |

# 9272-05



Product warranty period: 3 years  
Guaranteed accuracy period: 1 year

|  |                              |
|--|------------------------------|
| <b>Rated current</b>                     | 20 A AC, 200 A AC (2 ranges) |
| <b>Frequency band</b>                    | 1 Hz to 100 kHz              |
| <b>Diameter of measurable conductors</b> | $\phi$ 46 mm or less         |

## Accuracy

| Frequency                   | Amplitude<br>$\pm$ (% of reading + % of full scale) | Phase            |
|-----------------------------|---|------------------|
| 1 Hz $\leq$ f < 5 Hz        | $\pm 2.0\% \pm 0.10\%$                              | -                |
| 5 Hz $\leq$ f < 10 Hz       | $\pm 1.0\% \pm 0.05\%$                              | $\pm 1.0^\circ$  |
| 10 Hz $\leq$ f < 45 Hz      | $\pm 0.5\% \pm 0.02\%$                              | $\pm 0.5^\circ$  |
| 45 Hz $\leq$ f $\leq$ 66 Hz | $\pm 0.3\% \pm 0.01\%$                              | $\pm 0.2^\circ$  |
| 66 Hz < f $\leq$ 500 Hz     | $\pm 0.5\% \pm 0.02\%$                              | $\pm 0.5^\circ$  |
| 500 Hz < f $\leq$ 1 kHz     | $\pm 0.5\% \pm 0.02\%$                              | $\pm 1.0^\circ$  |
| 1 kHz < f $\leq$ 5 kHz      | $\pm 1.0\% \pm 0.05\%$                              | $\pm 2.0^\circ$  |
| 5 kHz < f $\leq$ 10 kHz     | $\pm 2.5\% \pm 0.10\%$                              | $\pm 3.0^\circ$  |
| 10 kHz < f $\leq$ 20 kHz    | $\pm 5\% \pm 0.1\%$                                 | $\pm 5.0^\circ$  |
| 20 kHz < f $\leq$ 50 kHz    | $\pm 5\% \pm 0.1\%$                                 | $\pm 15.0^\circ$ |
| 50 kHz < f $\leq$ 100 kHz   | $\pm 30\% \pm 0.1\%$                                | -                |

Accuracy is specified by the following conditions:  
• Less than or equal to the rated current of each current range  
• Within derating range of each current range  
The accuracy values above are for within the rated current for each range and inside of derating range. (The values are the values by design: amplitude at under 5 Hz and phase at under 10 Hz)

|   |  |
|---|--|
| <b>Temperature and humidity range for guaranteed accuracy</b> | 23°C $\pm$ 5°C (73°F $\pm$ 9°F), 80% RH or less    |
| <b>Effect of temperature</b>                                  | Amplitude sensitivity: $\pm 0.03\%$ of reading /°C |

## Frequency derating

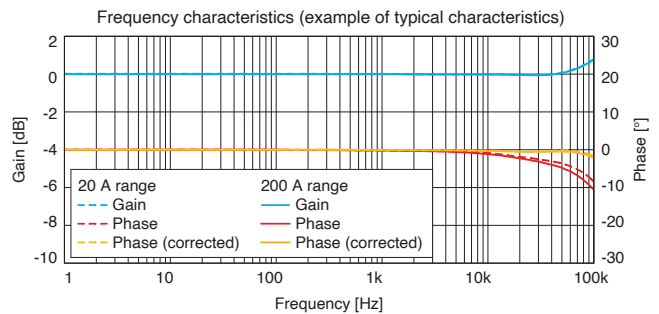
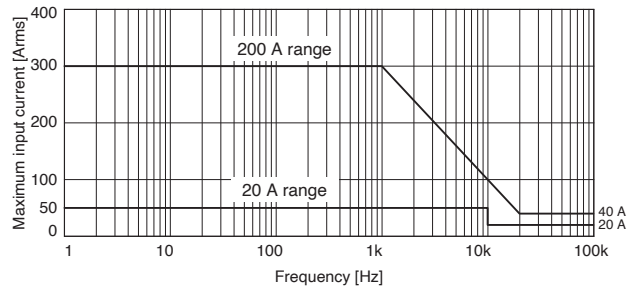

|   |   |
|---|---|
| <b>Output voltage</b>                           | 20 A range: 100 mV/A (= 2 V / 20 A)<br>200 A range: 10 mV/A (= 2 V / 200 A)                           |
| <b>Operating temperature and humidity range</b> | 0°C to 50°C (32°F to 122°F), 80% RH or less (no condensation)   |
| <b>Storage temperature and humidity range</b>   | -10°C to 60°C (14°F to 140°F), 80% RH or less (no condensation)                                       |
| <b>Maximum rated voltage to ground</b>          | 600 V AC CAT III (50/60 Hz)<br>Anticipated transient overvoltage: 6000 V                              |
| <b>Standards</b>                                | Safety: EN 61010, EMC: EN 61326 Class A   |
| <b>Cable length</b>                             | 3 m (9.84 ft.)  |
| <b>Dimensions</b>                               | 78 mm (3.07 in.) W x 188 mm (7.40 in.) H x 35 mm (1.38 in.) D (excluding protruding parts and cables) |
| <b>Weight</b>                                   | Approx. 450 g (15.9 oz.)  |

# CT6710



Product warranty period: 1 year  
Guaranteed accuracy period: 1 year

|  |  |
|--|--|
| <b>Rated current* (3 ranges)</b>         | 30 Arms, 5 Arms, 0.5 Arms AC/DC                    |
| <b>Frequency band</b>                    | DC to 50 MHz (-3dB)                                |
| <b>Diameter of measurable conductors</b> | Max. $\phi$ 5 mm (0.20 in.) (insulated conductors) |

\*DC or sine wave signals of 45 to 66 Hz, within maximum peak current for each range

|                             |  |
|-----------------------------|--|
| <b>Rise time</b>            | 7.0 ns or less (10% to 90%)  |
| <b>Output voltage</b>       | 0.1 V/A (30 A range)<br>1 V/A (5 A range)<br>10 V/A (0.5 A range)  |
| <b>Maximum peak current</b> | $\pm 50$ A peak* <sup>1</sup> (30 A range)<br>$\pm 7.5$ A peak (5 A range)<br>$\pm 0.75$ A peak (0.5 A range, $\geq 10$ MHz)<br>$\pm 0.3$ A peak (0.5 A range, $< 10$ MHz) |
| <b>Noise</b>                | 75 $\mu$ Arms or less* <sup>2</sup> (typical: 60 $\mu$ Arms)   |

\*1: Maximum 2 sec input; requires cooling time of at least 10 times longer than the time current has been input  
\*2: Does not apply to devices to which the probe is connected; applicable in the 0.5 A range and when used with 20 MHz bandwidth instrument devices

## Accuracy (amplitude)

| Range | Accuracy                     | typical                                   |
|-------|------------------------------|---|
| 30 A  | $\pm 3.0\%$ rdg. $\pm 1$ mV  | $\pm 1.0\%$ rdg $\pm 1$ mV ( $\leq 10$ A) |
| 5 A   | $\pm 3.0\%$ rdg. $\pm 1$ mV  | $\pm 1.0\%$ rdg $\pm 1$ mV                |
| 0.5 A | $\pm 3.0\%$ rdg. $\pm 10$ mV | $\pm 1.0\%$ rdg $\pm 10$ mV               |

The accuracy above is valid within the following conditions:  
Warm-up time: 30 minutes, operating environment of 23°C  $\pm$  5°C (73°F  $\pm$  9°F) at 80% RH or less, DC or sine wave signals of 45 to 66 Hz, within maximum peak current for each range

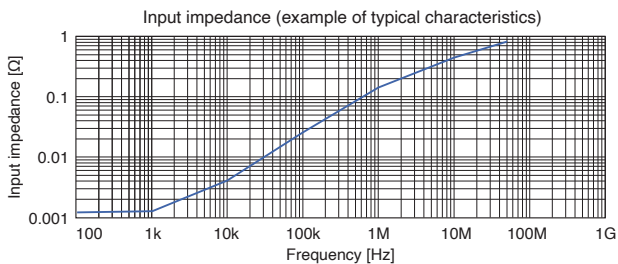
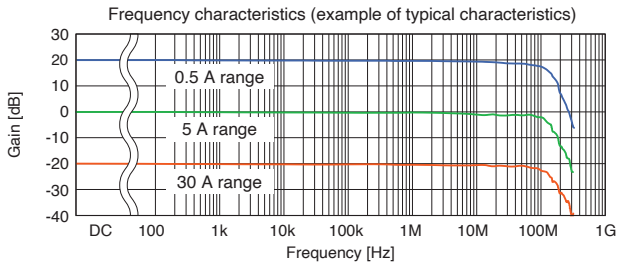
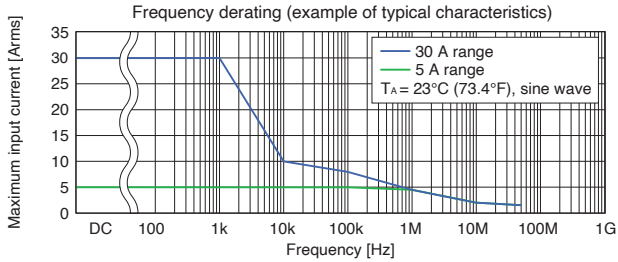

|   |   |
|---|---|
| <b>Operating temperature and humidity range</b> | 0°C to 40°C (32°F to 104°F), 80% RH or less (no condensation)   |
| <b>Storage temperature and humidity range</b>   | -10°C to 50°C (14°F to 122°F), 80% RH or less (no condensation)   |
| <b>Standards</b>                                | Safety: EN 61010, EMC: EN 61326   |
| <b>Maximum rated power</b>                      | 7.8 VA (continuous maximum input)   |
| <b>Cable length</b>                             | Sensor/junction box: 1500 mm (59.06 in.)<br>Junction box/termination unit: 150 mm (5.91 in.)<br>Power cord: 1000 mm (39.37 in.)   |
| <b>Dimensions</b>                               | Sensor: 155 mm (6.10 in.) W $\times$ 18 mm (0.71 in.) H $\times$ 26 mm (1.02 in.) D<br>Junction box: 45 mm (1.77 in.) W $\times$ 120 mm (4.72 in.) H $\times$ 25 mm (0.98 in.) D<br>Termination unit: 29 mm (1.14 in.) W $\times$ 83 mm (3.27 in.) H $\times$ 40 mm (1.57 in.) D (excluding BNC connector or protrusions) |
| <b>Weight</b>                                   | Approx. 370 g (13.1 oz.)  |

# CT6711



Product warranty period: 1 year  
Guaranteed accuracy period: 1 year

|  |  |
|--|--|
| <b>Rated current* (3 ranges)</b>         | 30 Arms, 5 Arms, 0.5 Arms AC/DC                    |
| <b>Frequency band</b>                    | DC to 120 MHz (-3dB)                               |
| <b>Diameter of measurable conductors</b> | Max. $\phi$ 5 mm (0.20 in.) (insulated conductors) |

\*DC or sine wave signals of 45 to 66 Hz, within maximum peak current for each range

|                             |  |
|-----------------------------|--|
| <b>Rise time</b>            | 2.9 ns or less (10% to 90%)  |
| <b>Output voltage</b>       | 0.1 V/A (30 A range)<br>1 V/A (5 A range)<br>10 V/A (0.5 A range)  |
| <b>Maximum peak current</b> | $\pm 50$ A peak* <sup>1</sup> (30 A range)<br>$\pm 7.5$ A peak (5 A range)<br>$\pm 0.75$ A peak (0.5 A range, $\geq 10$ MHz)<br>$\pm 0.3$ A peak (0.5 A range, $< 10$ MHz) |
| <b>Noise</b>                | 75 $\mu$ Arms or less* <sup>2</sup> (typical: 60 $\mu$ Arms)   |

\*1: Maximum 2 sec input; requires cooling time at least 10 times longer than the time current has been input  
\*2: Does not apply to devices to which the probe is connected; applicable in the 0.5 A range and when used with 20 MHz bandwidth instrument devices

## Accuracy (amplitude)

| Range | Accuracy                     | typical                                   |
|-------|------------------------------|---|
| 30 A  | $\pm 3.0\%$ rdg. $\pm 1$ mV  | $\pm 1.0\%$ rdg $\pm 1$ mV ( $\leq 10$ A) |
| 5 A   | $\pm 3.0\%$ rdg. $\pm 1$ mV  | $\pm 1.0\%$ rdg $\pm 1$ mV                |
| 0.5 A | $\pm 3.0\%$ rdg. $\pm 10$ mV | $\pm 1.0\%$ rdg $\pm 10$ mV               |

The accuracy above is valid within the following conditions:  
Warm-up time: 30 minutes, operating environment of 23°C  $\pm$  5°C (73°F  $\pm$  9°F) at 80% RH or less, DC or sine wave signals of 45 to 66 Hz, within maximum peak current for each range

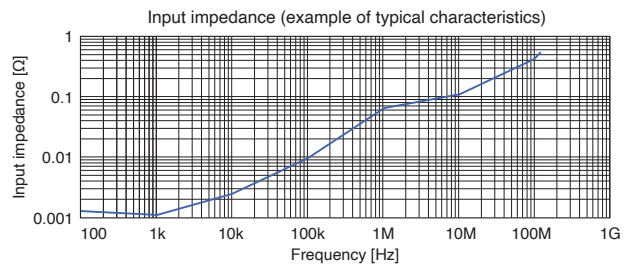
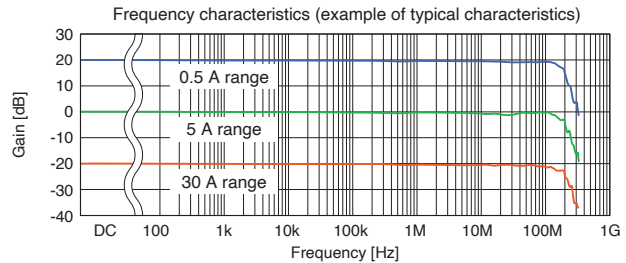
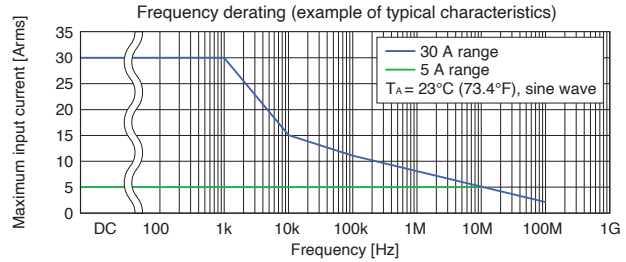

|   |   |
|---|---|
| <b>Operating temperature and humidity range</b> | 0°C to 40°C (32°F to 104°F), 80% RH or less (no condensation)   |
| <b>Storage temperature and humidity range</b>   | -10°C to 50°C (14°F to 122°F), 80% RH or less (no condensation)   |
| <b>Standards</b>                                | Safety: EN 61010, EMC: EN 61326   |
| <b>Maximum rated power</b>                      | 7.8 VA (continuous maximum input)   |
| <b>Cable length</b>                             | Sensor/junction box: 1500 mm (59.06 in.)<br>Junction box/termination unit: 150 mm (5.91 in.)<br>Power cord: 1000 mm (39.37 in.)   |
| <b>Dimensions</b>                               | Sensor: 155 mm (6.10 in.) W $\times$ 18 mm (0.71 in.) H $\times$ 26 mm (1.02 in.) D<br>Junction box: 45 mm (1.77 in.) W $\times$ 120 mm (4.72 in.) H $\times$ 25 mm (0.98 in.) D<br>Termination unit: 29 mm (1.14 in.) W $\times$ 83 mm (3.27 in.) H $\times$ 40 mm (1.57 in.) D (excluding BNC connector or protrusions) |
| <b>Weight</b>                                   | Approx. 370 g (13.1 oz.)  |

# CT6700



Product warranty period: 1 year  
Guaranteed accuracy period: 1 year

|  |  |
|--|--|
| <b>Rated current*</b>                    | 5 Arms   |
| <b>Frequency band</b>                    | DC to 50 MHz (-3dB)                                |
| <b>Diameter of measurable conductors</b> | Max. $\phi$ 5 mm (0.20 in.) (insulated conductors) |

\*DC or sine wave signals of 45 to 66 Hz, within maximum peak current for each range

|                             |  |
|-----------------------------|--|
| <b>Rise time</b>            | 7.0 ns or less (10% to 90%)                      |
| <b>Output voltage</b>       | 1 V/A  |
| <b>Maximum peak current</b> | $\pm 7.5$ A peak (non-continuous)                |
| <b>Noise</b>                | 75 $\mu$ Arms or less* (typical: 60 $\mu$ A rms) |

\*Does not apply to devices to which the probe is connected; applicable when used with 30 MHz bandwidth instrument devices

## Accuracy (amplitude)

| Accuracy                    | typical                     |
|-----------------------------|-----------------------------|
| $\pm 3.0\%$ rdg. $\pm 1$ mV | $\pm 1.0\%$ rdg. $\pm 1$ mV |

The accuracy above is valid within the following conditions:  
Warm-up time: 30 minutes, operating environment of 23°C  $\pm$  5°C (73°F  $\pm$  9°F) at 80% RH or less, DC or sine wave signals of 45 to 66 Hz, 0 Arms to 5 Arms

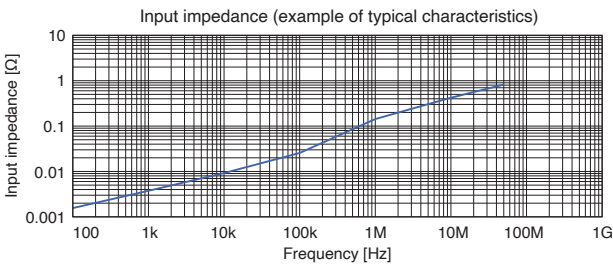
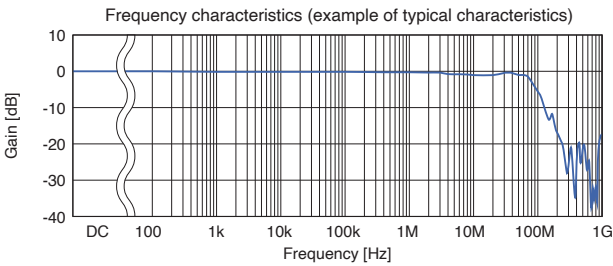
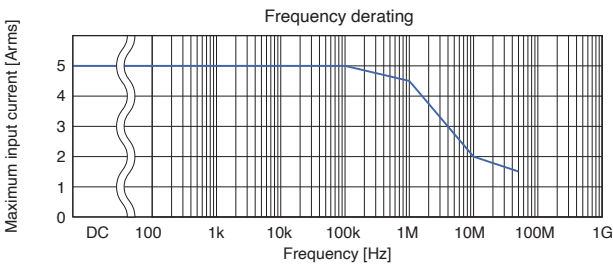

|   |  |
|---|--|
| <b>Operating temperature and humidity range</b> | 0°C to 40°C (32°F to 104°F), 80% RH or less (no condensation)  |
| <b>Storage temperature and humidity range</b>   | -10°C to 50°C (14°F to 122°F), 80% RH or less (no condensation)  |
| <b>Standards</b>                                | Safety: EN 61010, EMC: EN 61326  |
| <b>Maximum rated power</b>                      | 3.2 VA (continuous maximum input)  |
| <b>Cable length</b>                             | Sensor cable: 1500 mm (59.06 in.)<br>Power cord: 1000 mm (39.37 in.)   |
| <b>Dimensions</b>                               | Sensor: 155 mm (6.10 in.) W x 18 mm (0.71 in.) H x 26 mm (1.02 in.) D<br>Termination unit: 29 mm (1.14 in.) W x 83 mm (3.27 in.) H x 40 mm (1.57 in.) D (excluding BNC connector or protrusions) |
| <b>Weight</b>                                   | Approx. 250 g (8.8 oz.)  |

# CT6701



Product warranty period: 1 year  
Guaranteed accuracy period: 1 year

|  |  |
|--|--|
| <b>Rated current*</b>                    | 5 Arms   |
| <b>Frequency band</b>                    | DC to 120 MHz (-3dB)                               |
| <b>Diameter of measurable conductors</b> | Max. $\phi$ 5 mm (0.20 in.) (insulated conductors) |

\*DC or sine wave signals of 45 to 66 Hz, within maximum peak current for each range

|                             |  |
|-----------------------------|--|
| <b>Rise time</b>            | 2.9 ns or less (10% to 90%)                      |
| <b>Output voltage</b>       | 1 V/A  |
| <b>Maximum peak current</b> | $\pm 7.5$ A peak (non-continuous)                |
| <b>Noise</b>                | 75 $\mu$ Arms or less* (typical: 60 $\mu$ A rms) |

\*Does not apply to devices to which the probe is connected; applicable when used with 30 MHz bandwidth instrument devices

## Accuracy (amplitude)

| Accuracy                    | typical                     |
|-----------------------------|-----------------------------|
| $\pm 3.0\%$ rdg. $\pm 1$ mV | $\pm 1.0\%$ rdg. $\pm 1$ mV |

The accuracy above is valid within the following conditions:  
Warm-up time: 30 minutes, operating environment of 23°C  $\pm$  5°C (73°F  $\pm$  9°F) at 80% RH or less, DC or sine wave signals of 45 to 66 Hz, 0 Arms to 5 Arms

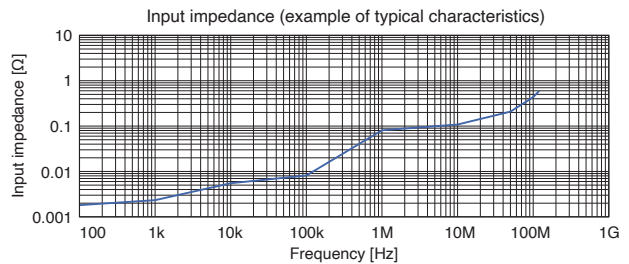
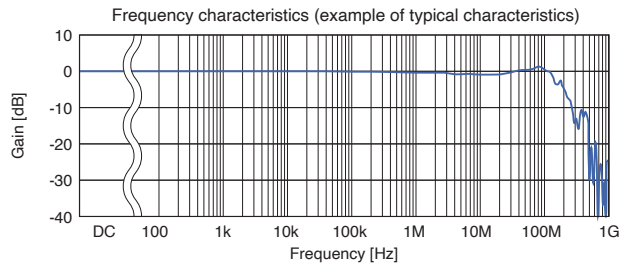
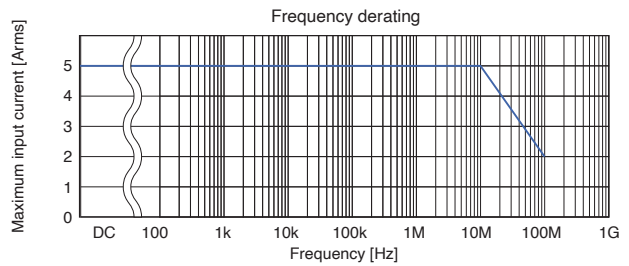

|   |  |
|---|--|
| <b>Operating temperature and humidity range</b> | 0°C to 40°C (32°F to 104°F), 80% RH or less (no condensation)  |
| <b>Storage temperature and humidity range</b>   | -10°C to 50°C (14°F to 122°F), 80% RH or less (no condensation)  |
| <b>Standards</b>                                | Safety: EN 61010, EMC: EN 61326  |
| <b>Maximum rated power</b>                      | 3.2 VA (continuous maximum input)  |
| <b>Cable length</b>                             | Sensor cable: 1500 mm (59.06 in.)<br>Power cord: 1000 mm (39.37 in.)   |
| <b>Dimensions</b>                               | Sensor: 155 mm (6.10 in.) W x 18 mm (0.71 in.) H x 26 mm (1.02 in.) D<br>Termination unit: 29 mm (1.14 in.) W x 83 mm (3.27 in.) H x 40 mm (1.57 in.) D (excluding BNC connector or protrusions) |
| <b>Weight</b>                                   | Approx. 250 g (8.8 oz.)  |

### 3273-50

Product warranty period: 1 year  
Guaranteed accuracy period: 1 year



|  |  |
|--|--|
| <b>Rated current*</b>                    | 30 Arms  |
| <b>Frequency band</b>                    | DC to 50 MHz (-3dB)                                |
| <b>Diameter of measurable conductors</b> | Max. $\phi$ 5 mm (0.20 in.) (insulated conductors) |

\*Refer to the graph for frequency derating characteristics.

|                             |                            |
|-----------------------------|----------------------------|
| <b>Rise time</b>            | 7.0 ns or less             |
| <b>Output voltage</b>       | 0.1 V/A                    |
| <b>Maximum peak current</b> | 50 A peak (non-continuous) |
| <b>Noise</b>                | 2.5 mArms or less*         |

\*Does not apply to devices to which the probe is connected;  
applicable when used with 20 MHz bandwidth instrument devices

#### Accuracy (amplitude)

|  |                             |                  |
|--|-----------------------------|------------------|
|  | to 30 Arms                  | to 50 A peak     |
|  | $\pm 1.0\%$ rdg. $\pm 1$ mV | $\pm 2.0\%$ rdg. |

The accuracy above is valid within the following conditions:  
Warm-up time: 30 minutes, operating environment of 23°C $\pm$  5°C (73°F  $\pm$  9°F) at 80% RH or less, DC or sine wave signals of 45 to 66 Hz, 0 Arms to 5 Arms

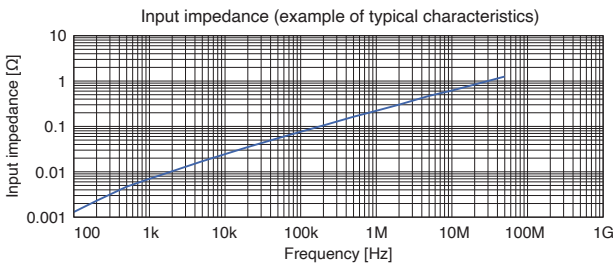
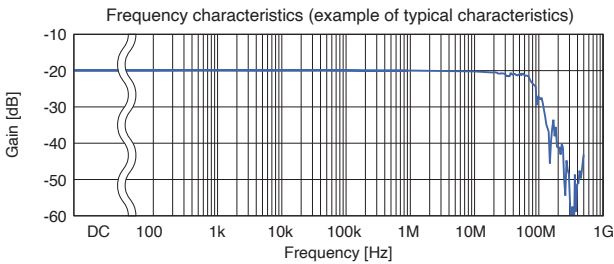
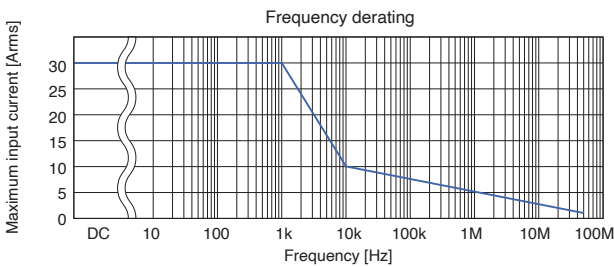

|   |  |
|---|--|
| <b>Operating temperature and humidity range</b> | 0°C to 40°C (32°F to 104°F), 80% RH or less (no condensation)  |
| <b>Storage temperature and humidity range</b>   | -10°C to 50°C (14°F to 122°F), 80% RH or less (no condensation)  |
| <b>Standards</b>                                | Safety: EN 61010, EMC: EN 61326  |
| <b>Maximum rated power</b>                      | 5.6 VA   |
| <b>Cable length</b>                             | Sensor cable: 1500 mm (59.06 in.)<br>Power cord: 1000 mm (39.37 in.)   |
| <b>Dimensions</b>                               | Sensor: 175 mm (6.89 in.) W $\times$ 18 mm (0.71 in.) H $\times$ 40 mm (1.57 in.) D<br>Termination unit: 27 mm (1.06 in.) W $\times$ 55 mm (2.17 in.) H $\times$ 18 mm (0.71 in.) D (excluding BNC connector or protrusions) |
| <b>Weight</b>                                   | Approx. 230 g (8.1 oz)   |

### 3276

Product warranty period: 1 year  
Guaranteed accuracy period: 1 year



|  |  |
|--|--|
| <b>Rated current*</b>                    | 30 Arms  |
| <b>Frequency band</b>                    | DC to 100 MHz (-3dB)                               |
| <b>Diameter of measurable conductors</b> | Max. $\phi$ 5 mm (0.20 in.) (insulated conductors) |

\*Refer to the graph for frequency derating characteristics.

|                             |                            |
|-----------------------------|----------------------------|
| <b>Rise time</b>            | 3.5 ns or less             |
| <b>Output voltage</b>       | 0.1 V/A                    |
| <b>Maximum peak current</b> | 50 A peak (non-continuous) |
| <b>Noise</b>                | 2.5 mArms or less*         |

\*Does not apply to devices to which the probe is connected;  
applicable when used with 20 MHz bandwidth instrument devices

#### Accuracy (amplitude)

|  |                             |                  |
|--|-----------------------------|------------------|
|  | to 30 Arms                  | to 50 A peak     |
|  | $\pm 1.0\%$ rdg. $\pm 1$ mV | $\pm 2.0\%$ rdg. |

The accuracy above is valid within the following conditions:  
Warm-up time: 30 minutes, operating environment of 23°C $\pm$  5°C (73°F  $\pm$  9°F) at 80% RH or less, DC or sine wave signals of 45 to 66 Hz, 0 Arms to 5 Arms

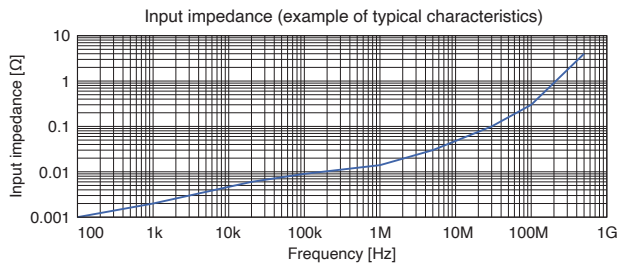
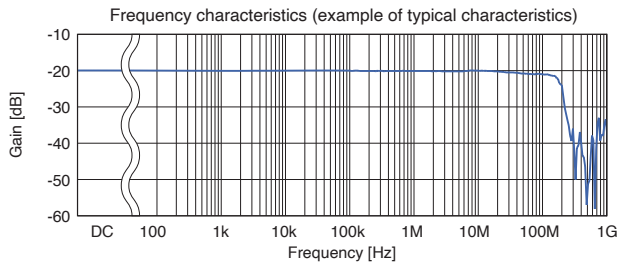
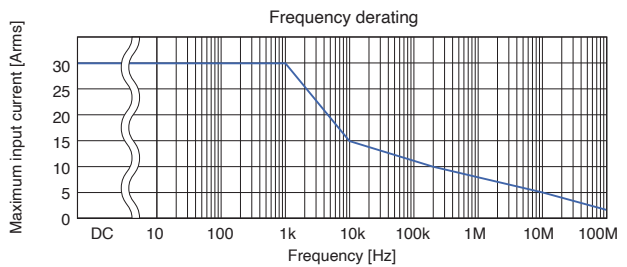

|   |  |
|---|--|
| <b>Operating temperature and humidity range</b> | 0°C to 40°C (32°F to 104°F), 80% RH or less (no condensation)  |
| <b>Storage temperature and humidity range</b>   | -10°C to 50°C (14°F to 122°F), 80% RH or less (no condensation)  |
| <b>Standards</b>                                | Safety: EN 61010, EMC: EN 61326  |
| <b>Maximum rated power</b>                      | 5.3 VA   |
| <b>Cable length</b>                             | Sensor cable: 1500 mm (59.06 in.)<br>Power cord: 1000 mm (39.37 in.)   |
| <b>Dimensions</b>                               | Sensor: 175 mm (6.89 in.) W $\times$ 18 mm (0.71 in.) H $\times$ 40 mm (1.57 in.) D<br>Termination unit: 27 mm (1.06 in.) W $\times$ 55 mm (2.17 in.) H $\times$ 18 mm (0.71 in.) D (excluding BNC connector or protrusions) |
| <b>Weight</b>                                   | Approx. 240 g (8.5 oz)   |

### 3274



Product warranty period: 1 year  
Guaranteed accuracy period: 1 year

|  |   |
|--|---|
| <b>Rated current*</b>                    | 150 Arms  |
| <b>Frequency band</b>                    | DC to 10 MHz (-3dB)                               |
| <b>Diameter of measurable conductors</b> | Max. $\phi$ 20 mm (0.79 in)(insulated conductors) |

\*The accuracy above is valid within the following conditions:  
DC or sine wave signals of 45 to 66 Hz, within maximum peak current for each range

|                             |                               |
|-----------------------------|-------------------------------|
| <b>Rise time</b>            | 35 ns or less                 |
| <b>Output voltage</b>       | 0.01 V/A                      |
| <b>Maximum peak current</b> | 300 A peak (non-continuous)*1 |
| <b>Noise</b>                | 25 mArms or less*2            |

\*1: 500 A peak with pulse width  $\leq$  30  $\mu$ s  
\*2: Does not apply to devices to which the probe is connected;  
when used with a 20 MHz bandwidth instrument devices

#### Accuracy (amplitude)

|                             |                  |
|-----------------------------|------------------|
| to 150 A                    | to 300 A peak    |
| $\pm 1.0\%$ rdg. $\pm 1$ mV | $\pm 2.0\%$ rdg. |

The accuracy above is valid within the following conditions:  
Warm-up time: 30 minutes, operating environment of 23°C $\pm$  5°C (73°F  $\pm$  9°F) at 80% RH or less, DC or sine wave signals of 45 to 66 Hz

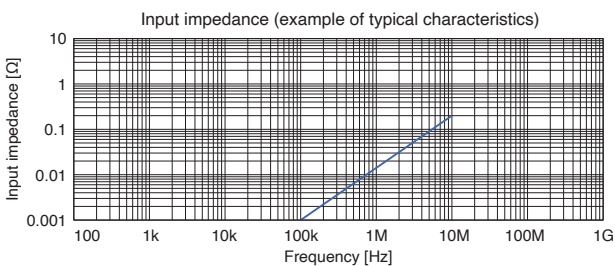
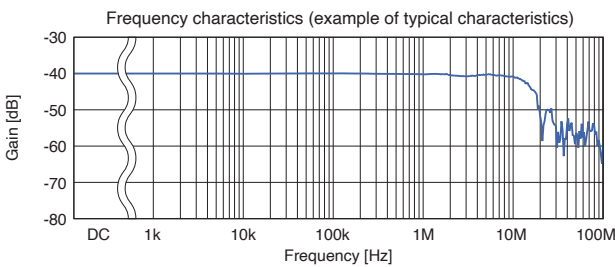
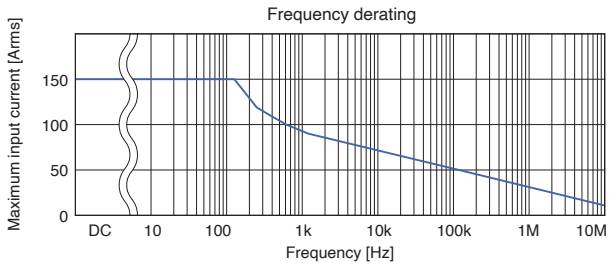

|   |  |
|---|--|
| <b>Operating temperature and humidity range</b> | 0°C to 40°C (32°F to 104°F), 80% RH or less (no condensation)  |
| <b>Storage temperature and humidity range</b>   | -10°C to 50°C (14°F to 122°F), 80% RH or less (no condensation)  |
| <b>Standards</b>                                | Safety: EN 61010, EMC: EN 61326  |
| <b>Maximum rated power</b>                      | 5.5 VA (continuous maximum input)  |
| <b>Cable length</b>                             | Sensor cable: 2000 mm (78.74 in.)<br>Power cord: 1000 mm (39.37 in.)   |
| <b>Dimensions</b>                               | Sensor: 176 mm (6.93 in.) W $\times$ 69 mm (2.72 in.) H $\times$ 27 mm (1.06 in.) D<br>Termination unit: 27 mm (1.06 in.) W $\times$ 55 mm (2.17 in.) H $\times$ 18 mm (0.71 in.) D (excluding BNC connector or protrusions) |
| <b>Weight</b>                                   | Approx. 500 g (17.6 oz)  |

### 3275



Product warranty period: 1 year  
Guaranteed accuracy period: 1 year

|  |   |
|--|---|
| <b>Rated current*</b>                    | 500 Arms  |
| <b>Frequency band</b>                    | DC to 2 MHz (-3dB)                                |
| <b>Diameter of measurable conductors</b> | Max. $\phi$ 20 mm (0.79 in)(insulated conductors) |

\*The accuracy above is valid within the following conditions:  
DC or sine wave signals of 45 to 66 Hz, within maximum peak current for each range

|                             |                             |
|-----------------------------|-----------------------------|
| <b>Rise time</b>            | 175 ns or less              |
| <b>Output voltage</b>       | 0.01 V/A                    |
| <b>Maximum peak current</b> | 700 A peak (non-continuous) |
| <b>Noise</b>                | 25 mArms or less*           |

\*Does not apply to devices to which the probe is connected;  
when used with a 20 MHz bandwidth instrument devices

#### Accuracy (amplitude)

|                             |                  |
|-----------------------------|------------------|
| to 500 A                    | to 700 A peak    |
| $\pm 1.0\%$ rdg. $\pm 5$ mV | $\pm 2.0\%$ rdg. |

The accuracy above is valid within the following conditions:  
Warm-up time: 30 minutes, operating environment of 23°C $\pm$  5°C (73°F  $\pm$  9°F) at 80% RH or less, DC or sine wave signals of 45 to 66 Hz

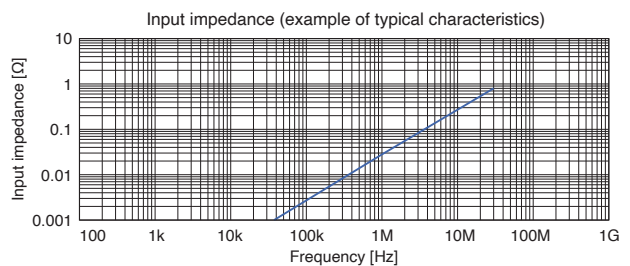
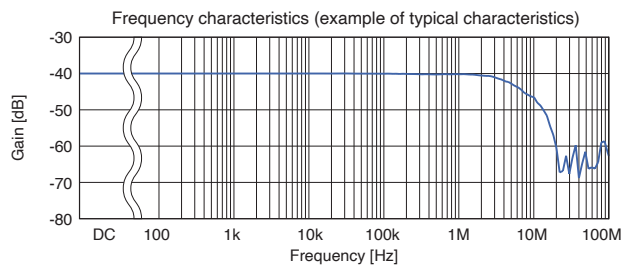
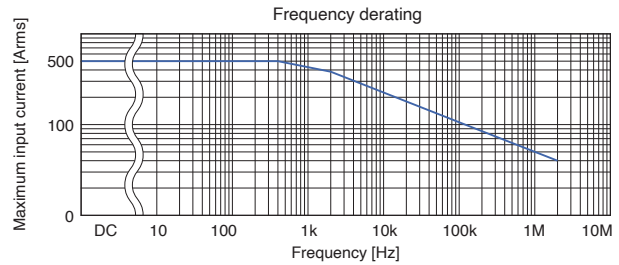

|   |  |
|---|--|
| <b>Operating temperature and humidity range</b> | 0°C to 40°C (32°F to 104°F), 80% RH or less (no condensation)  |
| <b>Storage temperature and humidity range</b>   | -10°C to 50°C (14°F to 122°F), 80% RH or less (no condensation)  |
| <b>Standards</b>                                | Safety: EN 61010, EMC: EN 61326  |
| <b>Maximum rated power</b>                      | 7.2 VA (continuous maximum input)  |
| <b>Cable length</b>                             | Sensor cable: 2000 mm (78.74 in.)<br>Power cord: 1000 mm (39.37 in.)   |
| <b>Dimensions</b>                               | Sensor: 176 mm (6.93 in.) W $\times$ 69 mm (2.72 in.) H $\times$ 27 mm (1.06 in.) D<br>Termination unit: 27 mm (1.06 in.) W $\times$ 55 mm (2.17 in.) H $\times$ 18 mm (0.71 in.) D (excluding BNC connector or protrusions) |
| <b>Weight</b>                                   | Approx. 520 g (18.3 oz)  |

| High-accuracy measurement (ME15W) |  |                 |
|-----------------------------------|--|-----------------|
| Pass-through types                | Rated current  | Frequency range |
| CT6862-05                         | 50 A   | DC to 1 MHz     |
| CT6872                            | 50 A   | DC to 10 MHz    |
| CT6872-01                         | 50 A   | DC to 10 MHz    |
| CT6863-05                         | 200 A  | DC to 500 kHz   |
| CT6873                            | 200 A  | DC to 10 MHz    |
| CT6873-01                         | 200 A  | DC to 10 MHz    |
| CT6875A                           | 500 A  | DC to 2 MHz     |
| CT6875A-1                         | 500 A  | DC to 1.5 MHz   |
| CT6904A                           | 500 A  | DC to 4 MHz     |
| CT6904A-1                         | 500 A  | DC to 2 MHz     |
| CT6904A-2                         | 800 A  | DC to 4 MHz     |
| CT6904A-3                         | 800 A  | DC to 2 MHz     |
| CT6876A                           | 1000 A   | DC to 1.5 MHz   |
| CT6876A-1                         | 1000 A   | DC to 1.2 MHz   |
| CT6877A                           | 2000 A   | DC to 1 MHz     |
| CT6877A-1                         | 2000 A   | DC to 1 MHz     |
| Clamp types                       | Rated current  | Frequency range |
| 9272-05                           | 20 A, 200 A  | 1 Hz to 100 kHz |
| CT6841-05                         | 20 A   | DC to 1 MHz     |
| CT6843-05                         | 200 A  | DC to 500 kHz   |
| CT6844-05                         | 500 A  | DC to 200 kHz   |
| CT6845-05                         | 500 A  | DC to 100 kHz   |
| CT6846-05                         | 1000 A   | DC to 20 kHz    |
| Direct-wired types                | Rated current  | Frequency range |
| PW9100A-3                         | 50 A   | DC to 3.5 MHz   |
| PW9100A-4                         | 50 A   | DC to 3.5 MHz   |
| Connection options                |  |                 |
| CT9555                            | 1 ch, external power supply, with waveform output function   |                 |
| CT9556                            | 1 ch, external power supply, with waveform/RMS output function                                     |                 |
| CT9557                            | 4 ch, external power supply, includes waveform/aggregated-waveform/aggregated-RMS output functions |                 |
| L9217                             | Isolated BNC terminals   |                 |
| 9165                              | Metallic BNC terminals   |                 |
| CT9904                            | Used with CT9557 added waveform output   |                 |
| CT9901                            | Converts ME15W terminal to PL23 terminal   |                 |
| CT9902                            | Used to extend cable length  |                 |
| Waveform observation (BNC)        |  |                 |
| High-sensitivity observation      | Rated current  | Frequency range |
| CT6710                            | 0.5 A, 5 A, 30 A   | DC to 50 MHz    |
| CT6711                            | 0.5 A, 5 A, 30 A   | DC to 120 MHz   |
| Observation of minuscule currents | Rated current  | Frequency range |
| CT6700                            | 5 A  | DC to 50 MHz    |
| CT6701                            | 5 A  | DC to 120 MHz   |
| Observation of large currents     | Rated current  | Frequency range |
| 3273-50                           | 30 A   | DC to 50 MHz    |
| 3276                              | 30 A   | DC to 100 MHz   |
| 3274                              | 150 A  | DC to 10 MHz    |
| 3275                              | 500 A  | DC to 2 MHz     |
| Connection options                |  |                 |
| 3269                              | 4 ch, external power supply, total output 2.5 A  |                 |
| 3272                              | 2 ch, external power supply, total output 600 mA   |                 |

| Grid power quality control (PL14) |  |                 |
|-----------------------------------|--|-----------------|
| Measurement of load current       | Rated current  | Frequency range |
| CT7126                            | 60 A   | 40 Hz to 2 kHz  |
| CT7131                            | 100 A  | 40 Hz to 2 kHz  |
| CT7731                            | 100 A  | DC to 5 kHz     |
| CT7631                            | 100 A  | DC to 10 kHz    |
| CT7736                            | 600 A  | DC to 5 kHz     |
| CT7636                            | 600 A  | DC to 10 kHz    |
| CT7136                            | 600 A  | 40 Hz to 5 kHz  |
| CT7742                            | 2000 A   | DC to 5 kHz     |
| CT7642                            | 2000 A   | DC to 10 kHz    |
| Measurement of large currents     | Rated current  | Frequency range |
| CT7044                            | 6000 A   | 10 Hz to 50 kHz |
| CT7045                            | 6000 A   | 10 Hz to 50 kHz |
| CT7046                            | 6000 A   | 10 Hz to 50 kHz |
| Measurement of leakage current    | Rated current  | Frequency range |
| CT7116                            | 6 A  | 40 Hz to 5 kHz  |
| Connection options                |  |                 |
| CT9920                            | Converts PL14 terminal to ME15W terminal                 |                 |
| L9095                             | Connects CM7290, CM7291 and instrument                   |                 |
| L0220-01                          | Extends a cable with a PL14 terminal, 2 m (6.56 ft.)     |                 |
| L0220-02                          | Extends a cable with a PL14 terminal, 5 m (16.40 ft.)    |                 |
| L0220-03                          | Extends a cable with a PL14 terminal, 10 m (32.81 ft.)   |                 |
| L0220-04                          | Extends a cable with a PL14 terminal, 20 m (65.62 ft.)   |                 |
| L0220-05                          | Extends a cable with a PL14 terminal, 30 m (98.43 ft.)   |                 |
| L0220-06                          | Extends a cable with a PL14 terminal, 50 m (164.04 ft.)  |                 |
| L0220-07                          | Extends a cable with a PL14 terminal, 100 m (328.08 ft.) |                 |

| Grid power quality control (BNC) |   |                 |
|----------------------------------|---|-----------------|
| Measurement of load current      | Rated current                             | Frequency range |
| 9694                             | 5 A                                       | 40 Hz to 5 kHz  |
| 9695-02                          | 50 A                                      | 40 Hz to 5 kHz  |
| 9660                             | 100 A                                     | 40 Hz to 5 kHz  |
| 9695-03                          | 100 A                                     | 40 Hz to 5 kHz  |
| 9010-50                          | 10 A - 500 A*1                            | 40 Hz to 1 kHz  |
| 9018-50                          | 10 A - 500 A*1                            | 40 Hz to 3 kHz  |
| 9132-50                          | 20 A - 1000 A*2                           | 40 Hz to 1 kHz  |
| 9661                             | 500 A                                     | 40 Hz to 5 kHz  |
| 9669                             | 500 A                                     | 40 Hz to 5 kHz  |
| Measurement of large currents    | Rated current                             | Frequency range |
| CT9667-01                        | 500 A, 5000 A                             | 10 Hz to 20 kHz |
| CT9667-02                        | 500 A, 5000 A                             | 10 Hz to 20 kHz |
| CT9667-03                        | 500 A, 5000 A                             | 10 Hz to 20 kHz |
| Measurement of leakage current   | Rated current                             | Frequency range |
| 9657-10                          | 10 A                                      | 40 Hz to 5 kHz  |
| 9675                             | 10 A                                      | 40 Hz to 5 kHz  |
| Connection options               |   |                 |
| 9219                             | Converts crimped terminal to BNC terminal |                 |
| L9910                            | Converts BNC terminal to PL14 terminal    |                 |
| 9704                             | Converts BNC terminal to banana terminal  |                 |

\*1: Can switch between ranges (10, 20, 50, 100, 200, 500 A AC )

\*2: Can switch between ranges (20, 50, 100, 200, 500, 1000 A AC )

Note: Company names and product names appearing in this brochure are trademarks or registered trademarks of various companies.

**HIOKI**  
HIOKI E. E. CORPORATION

**HEADQUARTERS**

81 Koizumi,  
Ueda, Nagano 386-1192 Japan  
<https://www.hioki.com/>



Scan for all regional contact information

DISTRIBUTED BY