

# DM7275

# DM7276

DM7275-01  
DM7275-02  
DM7275-03  
DM7276-01  
DM7276-02  
DM7276-03

# HIOKI

Instruction Manual

# PRECISION DC VOLTMETER

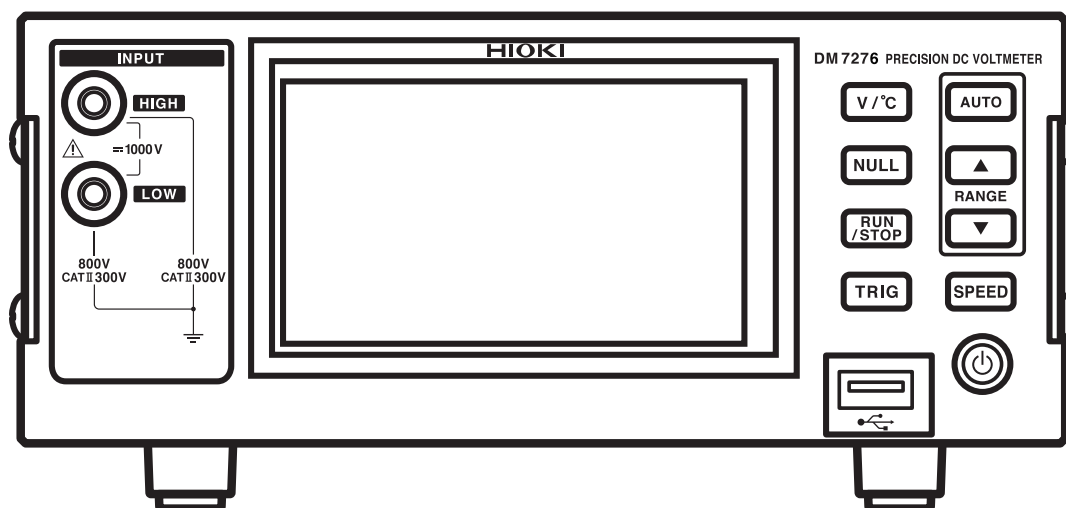

# EN



# Measurement process

This section describes voltage measurement as performed in a typical application.

Example use: Measuring a battery's voltage

## Preparations

### (1) Position the instrument as desired. (p.7)

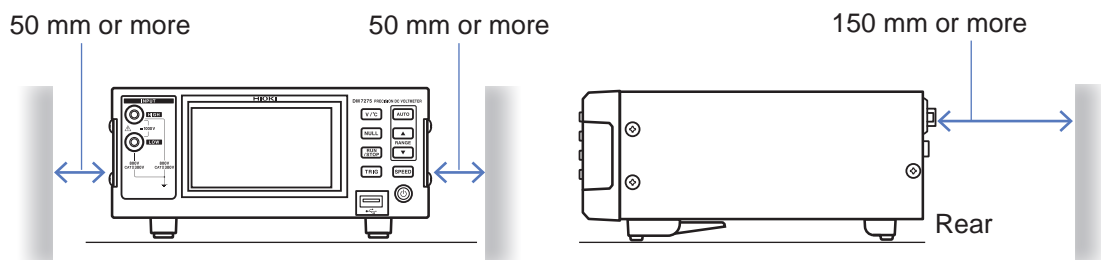

### (2) Perform the pre-measurement inspection. (p.24)

### (3) Connect the power cord. (p.25)

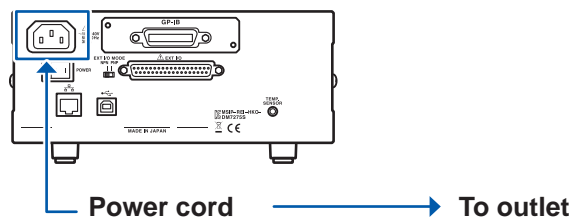

### (4) Connect the measurement cables to the measurement terminals. (p.26)

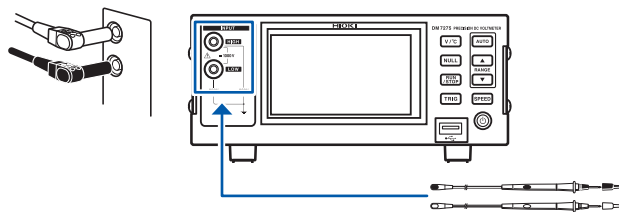

### (5) Connect the temperature sensor to the TEMP.SENSOR connector. (When performing temperature measurement or using the temperature compensation) (p.27)

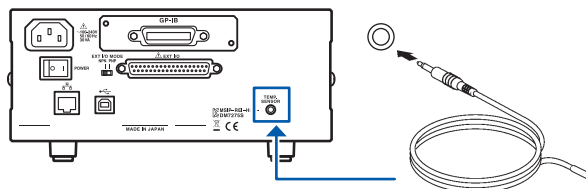

### (6) Configure and connect the external interface (as necessary).

- Using the USB interface (p.98)
- Using the RS-232C interface (p.100)
- Using the GP-IB interface (p.102)
- Using the LAN interface (p.104)
- Using a USB flash drive (p.115)
- Using the EXT I/O connector (p.125)

(7) Turn on the instrument. (p.28)

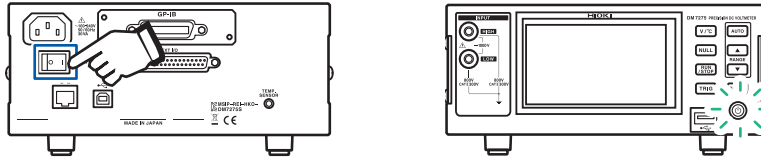

(8) Set the time and date. (p.30)

## Measurement

(9) Set the measurement range. (p.35) (default setting: AUTO range)

When using the auto-range setting, the instrument will automatically select the optimal range.  
To fix the range manually: Manual range (p.35)

(10) Set the measurement speed. (p.35) (default setting: MEDIUM)



(11) Switch the measured value display. (p.18) (default setting: V)



(12) Connect the measurement cables to the measurement target. (p.31)

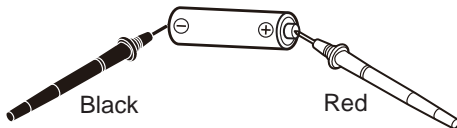

(13) Perform measurement. (p.37)

- To enable the trend display (time-axis display) or to display judgment results: (p.43)
- To display information other than measured values (error display): (p.46), (p.176)
- To assign names to measured values: (p.49)
- To hold the measured value display: (p.37), (p.70)
- To change the number of display digits: (p.48)

# Contents

Introduction.....	1	3.5 Measurement Error Displays (Displays Other Than Measured Values).....	46
Verifying Package Contents .....	2	■ Measurement error detection order .....	47
Safety Information .....	5	3.6 Changing the Number of Display Digits .....	48
Operating Precautions .....	7	3.7 Displaying Labels (Assigning Names to Measured Values).....	49
<b>1 Overview</b> .....	<b>13</b>	<b>4 Judging Measured Values</b> .....	<b>51</b>
1.1 Product Overview.....	13	4.1 To Obtain Accurate Judgments Even When the Polarity of the Measurement Target (Battery, etc.) Is Reversed.....	52
1.2 Features .....	13	4.2 Comparator Measurement (Using a Single Judgment Standard) .....	53
1.3 Part Names and Functions.....	14	■ To check judgments aurally .....	55
1.4 Screen Layout .....	16	■ To perform judgment after measured values stabilize .....	56
1.5 Operating the Instrument .....	17	■ To output judgment results to an external device or to print judgment results	56
■ Changing settings .....	17	4.3 BIN Measurement (Using Multiple Judgment Standards).....	57
■ Returning to the previous screen.....	17	■ To output judgment results to an external device or to print judgment results	59
■ Switching the measured value display.....	18	<b>5 Saving and Loading Measurement Conditions (Internal Memory)</b> .....	<b>61</b>
■ Changing the range .....	18	5.1 Saving Measurement Conditions (Panel Save Function).....	62
■ Changing the measurement speed.....	19	5.2 Loading Measurement Conditions (Panel Load Function).....	64
■ Starting measurement .....	20	5.3 Changing the Panel Name.....	65
1.6 How to Use This Manual.....	21	5.4 Deleting a Panel .....	66
<b>2 Preparing for Measurement</b> .....	<b>23</b>	<b>6 Useful Functionality</b> .....	<b>67</b>
2.1 Preparation Process .....	23	6.1 Obtaining Stable Measured Values.....	67
2.2 Performing the Pre-measurement Inspection.....	24	■ Setting the integration time .....	67
2.3 Connecting the Power Cord.....	25	■ Reducing measured value variability (smoothing function) .....	69
2.4 Connecting the Measurement Cables (to the Instrument).....	26	6.2 Auto-hold Function .....	70
2.5 Connecting the Temperature Sensor .....	27	6.3 Contact Check .....	71
2.6 Turning the Instrument On and Off .....	28	6.4 Switching the Input Resistance ....	76
2.7 Setting the Time and Date .....	30		
<b>3 Measurement</b> .....	<b>31</b>		
3.1 Connecting the Measurement Cables (Measurement Target) .....	31		
3.2 Setting the Measurement Range ..	35		
3.3 Setting the Measurement Speed...	36		
3.4 Starting Measurement .....	37		
■ Continuous measurement.....	37		
■ Trigger measurement (measurement with user-specified timing) .....	38		
■ Storage of measurement data in the instrument's internal memory.....	42		
■ Displaying trends, bar graphs, statistics, and judgment results .....	43		
■ Checking the voltage trend.....	45		

<b>6.5</b>	<b>Correcting Measured Values</b> .....	<b>77</b>		
	■ Adjusting the zero-point (NULL function)....	78		
	■ Compensating the effects of temperature (temperature compensation function).....	80		
	■ Correcting measured values using a linear expression (scaling function) .....	82		
<b>6.6</b>	<b>Statistical Calculations</b> .....	<b>84</b>		
	■ Displaying, clearing, and printing statistical calculation results .....	85		
<b>7</b>	<b>System Settings</b>	<b>87</b>		
<b>7.1</b>	<b>Key Lock (Disabling Instrument Operation)</b> .....	<b>87</b>		
<b>7.2</b>	<b>Buzzer Settings</b> .....	<b>88</b>		
<b>7.3</b>	<b>Adjusting the Screen Brightness</b> .	<b>89</b>		
<b>7.4</b>	<b>Changing the Screen Color</b> .....	<b>89</b>		
<b>7.5</b>	<b>Adjusting the Touch Panel Position</b> .....	<b>90</b>		
<b>7.6</b>	<b>Setting the Power Supply Frequency</b> .....	<b>90</b>		
<b>7.7</b>	<b>Selecting Startup Load Settings and a Panel</b> .....	<b>91</b>		
<b>7.8</b>	<b>Setting Output Formats</b> .....	<b>92</b>		
<b>7.9</b>	<b>Resetting the Instrument (Reverting the Instrument to its Factory Settings)</b> .....	<b>93</b>		
	■ List of default settings .....	94		
<b>8</b>	<b>Preparing to Use USB, RS-232C, GP-IB, and LAN Control</b>	<b>97</b>		
<b>8.1</b>	<b>Overview of Interfaces and Associated Features</b> .....	<b>97</b>		
<b>8.2</b>	<b>Preparing to Use an Interface (Connection and Settings)</b> .....	<b>98</b>		
	■ Using the USB interface .....	98		
	■ Using the RS-232C interface .....	100		
	■ Using the GP-IB interface .....	102		
	■ Using the LAN interface.....	104		
<b>8.3</b>	<b>Communications Settings</b> .....	<b>109</b>		
	■ Communications monitor (displaying communications commands).....	109		
	■ Setting the format for measurement .....	110		
	■ Setting the model name acquired by commands .....	110		
<b>9</b>	<b>Outputting Data</b>	<b>111</b>		
<b>9.1</b>	<b>Interface Settings</b> .....	<b>111</b>		
<b>9.2</b>	<b>Output Methods</b> .....	<b>112</b>		
<b>9.3</b>	<b>Data Output Settings</b> .....	<b>113</b>		
<b>10</b>	<b>Using a USB Flash Drive</b>	<b>115</b>		
<b>10.1</b>	<b>Overview</b> .....	<b>115</b>		
<b>10.2</b>	<b>Connecting a USB Flash Drive</b> ....	<b>116</b>		
<b>10.3</b>	<b>Setting the Interface</b> .....	<b>117</b>		
<b>10.4</b>	<b>Setting the Output Data Type</b> .....	<b>117</b>		
<b>10.5</b>	<b>Outputting Data (USB Flash Drive)</b> .....	<b>118</b>		
	■ Outputting measurement data or screenshots .....	118		
	■ Outputting all measurement data.....	119		
<b>10.6</b>	<b>Outputting and Loading Measurement Conditions (USB Flash Drive)</b> .....	<b>120</b>		
	■ Outputting measurement conditions .....	120		
	■ Loading measurement conditions.....	122		
<b>10.7</b>	<b>Files</b> .....	<b>123</b>		
	■ File format.....	123		
<b>11</b>	<b>External Control (EXT I/O)</b>	<b>125</b>		
<b>11.1</b>	<b>External Control Measurement Process</b> .....	<b>125</b>		
<b>11.2</b>	<b>Switching between Current Sink (NPN) and Current Source (PNP)</b> 126			
<b>11.3</b>	<b>Connections (Instrument and Control Device)</b> .....	<b>127</b>		
	■ Instrument connector and compatible connectors .....	128		
	■ Signal functions .....	129		
	■ Internal circuit architecture.....	133		
	■ Electrical specifications.....	134		
	■ Example connections.....	134		
<b>11.4</b>	<b>Configuring External Input and Output</b> .....	<b>136</b>		
	■ Input filter .....	136		
	■ EOM signal output type .....	137		
<b>11.5</b>	<b>Input Test/Output Test</b> .....	<b>138</b>		
<b>11.6</b>	<b>Timing Chart</b> .....	<b>139</b>		
	■ Timing from the start of measurement to acquisition of judgment results .....	139		
	■ Panel load timing .....	141		
	■ Output signal status when the instrument is turned on .....	142		

- Measurement process (starting measurement from an external device and loading judgment results)..... 142

## 12 Printing 143

- 12.1 Printer Settings ..... 144
- 12.2 Connecting the Printer to the Instrument..... 146
- 12.3 Configuring the Instrument..... 146
- 12.4 Printing..... 147
  - Print examples ..... 148

## 13 Specifications 151

- 13.1 General Specifications ..... 151
- 13.2 Measurement Specifications..... 152
  - Basic specifications ..... 152
  - Accuracy specifications ..... 155
- 13.3 Functional Specifications..... 157
- 13.4 Interface Specifications ..... 163

## 14 Maintenance and Service 167

- Calibration and repair ..... 167
- Transporting the instrument..... 167
- Replacement parts and their service lives 167
- 14.1 Q&A (Frequently Asked Questions) ..... 168
  - 1. General issues..... 168
  - 2. Measurements ..... 169
  - 3. Communications ..... 171
  - 4. EXT I/O ..... 173
  - Frequently Asked Questions for External Control (EXT I/O)..... 175
- 14.2 Cleaning ..... 175
- 14.3 Error Displays..... 176
- 14.4 Disposing of the Instrument ..... 180

## 15 License Information 181

### Appendix Appx.1

- Appx. 1 Block Diagram..... Appx.1
- Appx. 2 Measuring the Enclosure Potential of Laminated Lithium-ion Batteries..... Appx.2
  - Internal insulation defects in lithium-ion batteries .....Appx.2
  - Enclosure potential measurement .....Appx.3

### Appx. 3 Causes of Error in Voltage Measurement..... Appx.5

- Thermal electromotive force .....Appx.5
- Effects of input resistance.....Appx.6
- Effects of bias current .....Appx.6
- Effects of high-voltage measurement ..Appx.7
- Effects of burst noise .....Appx.7

### Appx. 4 Noise Countermeasures . Appx.8

- Effects of induced noise.....Appx.8
- Effects of conductive noise .....Appx.10

### Appx. 5 Self-calibration.....Appx.11

### Appx. 6 Measuring Multiple Targets ..... Appx.12

### Appx. 7 Rack Mounting ..... Appx.14

- Rack-mounting hardware reference figures .....Appx.14
- Installation instructions .....Appx.17

### Appx. 8 Outline Drawings ..... Appx.21

### Appx. 9 Calibration ..... Appx.22

### Appx. 10 Adjustment ..... Appx.23

### Index Ind.1

11

12

13

14

15

7

8

9

10

Appx.

Ind.





# Introduction

Thank you for purchasing the Hioki DM7275, DM7276 Precision DC Voltmeter. To obtain maximum performance from the instrument, please read this manual first, and keep it handy for future reference.

Model		Interface			
DM7275	DM7276	LAN	USB	GP-IB	RS-232C
DM7275-01	DM7276-01	✓	✓	-	-
DM7275-02	DM7276-02	✓	✓	✓	-
DM7275-03	DM7276-03	✓	✓	-	✓

✓: Available, -: Not available

## Registered trademarks

- Microsoft, Windows 7 and Windows 8 are either registered trademarks or trademarks of Microsoft Corporation in the United States and other countries.
- Teflon is a registered trademark of E. I. du Pont de Nemours and Company.

## Notations

<b>*</b>	Additional information is presented below.
<b>SET</b> (bold)	Names and keys on the screen are indicated with bold characters.
<b>[ ]</b>	Operation keys are indicate in <b>[ ]</b> square brackets.
Unless otherwise specified, "Windows" represents Windows 7 and Windows 8.	

## Accuracy

We define measurement tolerances in terms of f.s. (full scale), rdg. (reading) and dgt. (digit) values, with the following meanings:

<b>f.s.</b>	(Maximum display) The maximum displayable value.
<b>rdg.</b>	(Reading) The value currently being measured and indicated on the measuring instrument.
<b>dgt.</b>	(Resolution) The smallest displayable unit on a digital measuring instrument, i.e., the input value that causes the digital display to show a "1" as the least-significant digit.

See "Accuracy specifications" (p.155).

## Verifying Package Contents

- When you receive the instrument, inspect it carefully to ensure that no damage occurred during shipping. In particular, check the accessories, panel switches, buttons, keys and connectors. If damage is evident, or if it fails to operate according to the specifications, contact your authorized Hioki distributor or reseller.
- Store the packaging in which the instrument was delivered, as you will need it when transporting the instrument.

Check if the package contents are correct.

- DM7275 or DM7276

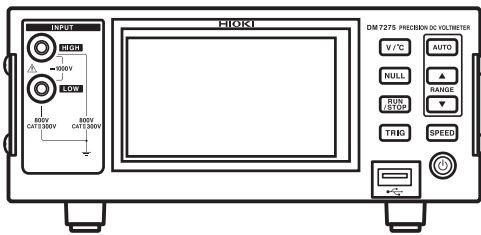

### Accessories

- Application disc (CD)



(Communication Command Instruction Manual (PDF) and USB Driver are included)

- The latest version can be downloaded from our web site.

- Power supply cord

- Instruction manual (this document)



Instruction manuals may also be available in other languages. Please visit our website at <http://www.hioki.com>.

## Options (Sold Separately)

The following options are available for the instrument. Contact your authorized Hioki distributor or reseller when ordering.

### Measurement cables (general voltage measurements)

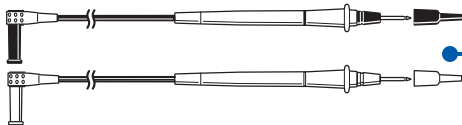

**L9207-10**  
**Test Lead**  
Pin diameter:  $\phi 2$  mm

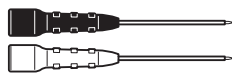

**L4933**  
**Contact Pin Set**  
Pin diameter:  $\phi 1$  mm



**L4934**  
**Small Alligator Clip Set**  
Maximum clip width:  $\phi 4$  mm

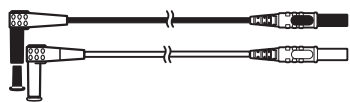

**L4930**  
**Connection Cable Set**  
Length: 1.2 m



**L4935**  
**Alligator Clip Set**  
Maximum clip width:  $\phi 25$  mm

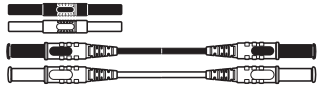

**L4931**  
**Extension Cable Set**  
Length: 1.5 m  
With coupling connector

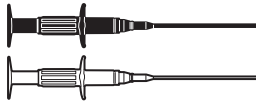

**9243**  
**Grabber Clip**  
Maximum clip width:  $\phi 2$  mm

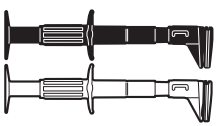

**L4936**  
**Bus Bar Clip Set**  
Maximum clip width:  $\phi 25$  mm  
(Objects to be measured which are 30 mm or less can be clipped.)

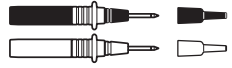

**L4932**  
**Test Pin Set**  
Pin diameter:  $\phi 2$  mm





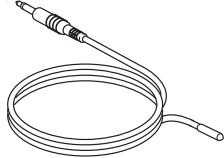

Measurement cable	Safety extra-low voltage	CATII*	CATIII*	CATIV*
L9207-10, L4932	-	1000 V	1000 V	600 V
L4930, L4931, L4935	-	-	1000 V	600 V
L4933	33 V AC/70 V DC	-	-	-
L4934	-	600 V	300 V	-
9243	-	-	1000 V	-
L4936	-	-	600 V	-

\*: Measurements over measuring instrument's rated voltage are not possible.  
See "Inspection before use" (p.7)

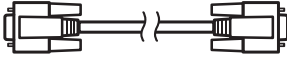
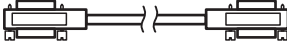
### Temperature measurements

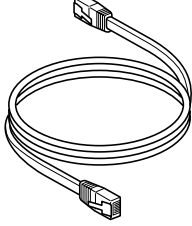
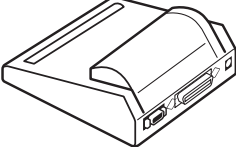
**Z2001**    Temperature Sensor

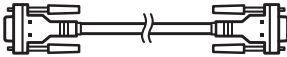

Communication interface			
<input type="checkbox"/>	<b>9637</b>	RS-232C Cable	 9 pins-9 pins/1.8 m/cross
<input type="checkbox"/>	<b>9151-02</b>	GP-IB Connector Cable	 2 m
<input type="checkbox"/>	<b>L1002</b>	USB Cable (A - B)	 A-B type
<input type="checkbox"/>	<b>9642</b>	LAN Cable	
For printing			
<input type="checkbox"/>	<b>9442</b>	Printer	
<input type="checkbox"/>	<b>9443-01</b>	AC Adapter	 For Japan
<input type="checkbox"/>	<b>9443-02</b>	AC Adapter	 For countries other than Japan
<input type="checkbox"/>	<b>1196</b>	Recording Paper	
<input type="checkbox"/>	<b>9444</b>	Connection Cable	 To connect the instrument and the 9442 printer

## Safety Information

This instrument is designed to conform to IEC 61010 Safety Standards, and has been thoroughly tested for safety prior to shipment. However, using the instrument in a way not described in this manual may negate the provided safety features.

Before using the instrument, be certain to carefully read the following safety notes.

### DANGER



**Mishandling during use could result in injury or death, as well as damage to the instrument. Be certain that you understand the instructions and precautions in the manual before use.**







### WARNING









- With regard to the electricity supply, there are risks of electric shock, heat generation, fire, and arc discharge due to short circuits. If persons unfamiliar with electricity measuring instrument are to use the instrument, another person familiar with such instruments must supervise operations.
- This instrument is measured on a live line. To avoid electric shock when measuring live lines, wear appropriate protective gear, such as insulated rubber gloves, boots and a safety helmet.

## Notations



In this manual, the risk seriousness and the hazard levels are classified as follows.

 <b>DANGER</b>	Indicates an imminent hazardous situation that will result in death or serious injury to the operator.
 <b>WARNING</b>	Indicates a potentially hazardous situation that may result in death or serious injury to the operator.
 <b>CAUTION</b>	Indicates a potentially hazardous situation that may result in minor or moderate injury to the operator or damage to the instrument or a malfunction.
<b>IMPORTANT</b>	Indicates information related to the operation of the instrument or maintenance tasks with which the operators must be fully familiar.
	Indicates a high voltage hazard. If a particular safety check is not performed or the instrument is mishandled, this may give rise to a hazardous situation; the operator may receive an electric shock, may get burnt or may even be fatally injured.
	Indicates a prohibited action.
	Indicates the action which must be performed.

## Symbols on the instrument

	Indicates cautions and hazards. When the symbol is printed on the instrument, refer to a corresponding topic in the Instruction Manual.
	Indicates a grounding terminal.
	Indicates DC (Direct Current).
	Indicates AC (Alternating Current).
	Indicates the ON side of the power switch.
	Indicates the OFF side of the power switch.

## Symbols for standards

	Indicates the Waste Electrical and Electronic Equipment Directive (WEEE Directive) in EU member states.
	Indicates that the product conforms to regulations set out by the EC Directive.

## Measurement categories

To ensure safe operation of measuring instruments, IEC 61010 establishes safety standards for various electrical environments, categorized as CAT II to CAT IV, and called measurement categories.

### DANGER



- Using a measuring instrument in an environment designated with a higher-numbered category than that for which the instrument is rated could result in a severe accident, and must be carefully avoided.
- Using a measuring instrument without categories in an environment designated with the CAT II to CAT IV category could result in a severe accident, and must be carefully avoided.

This instrument conforms to the safety requirements for CAT II 300 V measuring instruments.

**CAT II:** When directly measuring the electrical outlet receptacles of the primary electrical circuits in equipment connected to an AC electrical outlet by a power cord (portable tools, household appliances, etc.).

**CAT III:** When measuring the primary electrical circuits of heavy equipment (fixed installations) connected directly to the distribution panel, and feeders from the distribution panel to outlets.

**CAT IV:** When measuring the circuit from the service drop to the service entrance, and to the power meter and primary overcurrent protection device (distribution panel).

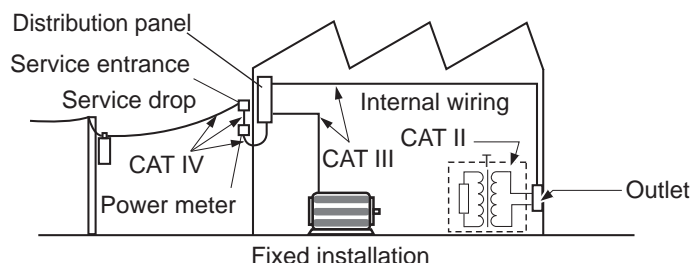

## Operating Precautions

Follow these precautions to ensure safe operation and to obtain the full benefits of the various functions.

### Inspection before use

#### **WARNING**

If the measurement cable or the instrument is damaged, there is a risk of electric shock. Before using the instrument perform the following inspection.



- Before using the instrument, make sure that the insulation on the cables are undamaged and that no bare conductors are improperly exposed. Using the instrument under such conditions could result in electric shock. Replace the cable with those specified by our company.
- To prevent an electric shock, confirm that the white portion (insulation layer) inside the cable is not exposed. If a color inside the cable is exposed, do not use the cable.
- Before using the instrument for the first time, verify that it operates normally to ensure that no damage occurred during storage or shipping. If you find any damage, contact your authorized Hioki distributor or reseller.

### Installation environment

#### **WARNING**

Installing the instrument in inappropriate locations may cause a malfunction of instrument or may give rise to an accident. Avoid the following locations.



- Exposed to direct sunlight or high temperature
- Exposed to corrosive or combustible gases
- Exposed to a strong electromagnetic field or electrostatic charge
- Near induction heating systems (such as high-frequency induction heating systems and IH cooking equipment)
- Susceptible to vibration
- Exposed to water, oil, chemicals, or solvents
- Exposed to high humidity or condensation
- Exposed to high quantities of dust particles

## Installation method

### ⚠ CAUTION



Do not place the instrument on an unstable table or an inclined place. Dropping or knocking down the instrument can cause injury or damage to the instrument.

- Install the instrument with the bottom facing down.
- To prevent overheating, be sure to leave the specified clearances around the instrument.

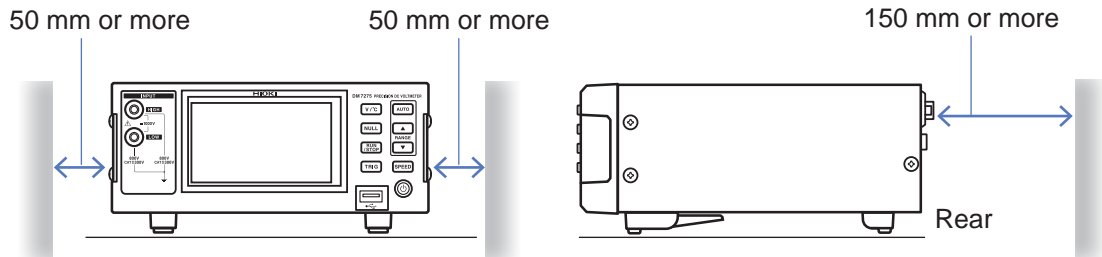

The stand can be used to lift the instrument's front panel. (p. 14)

The instrument can also be mounted on racks. (p. Appx. 14)

Unplugging the power cord kills power to the instrument. Be sure to provide enough unobstructed space to unplug the power cord immediately in an emergency.

## Handling the instrument

### ⚠ DANGER



To avoid electric shock, do not remove the instrument's case. The internal components of the instrument carry high voltages and may become very hot during operation.

### ⚠ CAUTION



To avoid damage to the instrument, protect it from physical shock when transporting and handling. Be especially careful to avoid physical shock from dropping.

This instrument may cause interference if used in residential areas. Such use must be avoided unless the user takes special measures to reduce electromagnetic emissions to prevent interference to the reception of radio and television broadcasts.

## Precautions when using the included application disc

- Exercise care to keep the recorded side of discs free of dirt and scratches. When writing text on a disc's label, use a pen or marker with a soft tip.
- Keep discs inside a protective case and do not expose to direct sunlight, high temperature, or high humidity.
- Hioki is not liable for any issues your computer system experiences in the course of using this disc.

## Before connecting a power cord

### ⚠ WARNING



To avoid electrical accidents and to maintain the safety specifications of this instrument, connect the power cord provided only to an outlet.



## Before connecting a measurement cable

### DANGER



Measurement cables should only be connected to the secondary side of a breaker. Any short-circuit current at the secondary side will be cut-off by the breaker. Connections should never be made to the primary side of a breaker, because unrestricted current flow could damage the instrument and facilities if a short circuit occurs.

### WARNING



To avoid electric shock and short-circuit accidents, use only the specified measurement cables to connect the instrument input terminals (HIGH and LOW terminals) to the circuit over 70 V DC to be tested.

## Before connecting a temperature sensor

### IMPORTANT

Connect the temperature sensor by inserting the plug all the way in the TEMP.SENSOR connector. Insufficient connection may cause larger errors in measured values.

## Before turning the power ON

### WARNING



Before turning the instrument on, make sure the supply voltage matches that indicated on its power connector. Connection to an improper supply voltage may damage the instrument and present an electrical hazard.

### CAUTION



Avoid using an uninterruptible power supply (UPS) or DC/AC inverter with rectangular wave or pseudo-sine-wave output to power the instrument. Doing so may damage the instrument.

## Before starting a measurement

### Voltage measurements

#### **DANGER**

- The maximum rated voltage between input terminals and the ground is as follows.  
CAT II: 300 V AC/DC  
No measurement category: 800 V AC/DC  
If their voltages are exceeded, this instrument will be damaged and personal injury will result. Therefore, do not perform measurement in this case.
-  Maximum input voltage of the voltage measurement terminals is 1000 V DC, 10<sup>5</sup> VHz AC, 1500 V peak. However, voltages over 800 V can be measured only if the circuit to be measured is isolated from the ground. If their voltages are exceeded, this instrument will be damaged and personal injury will result. Therefore, do not perform measurement in this case.
- To avoid electric shock, be careful to avoid shorting live lines with the measurement cables.

### Temperature measurements

#### **CAUTION**

-  To avoid damage to the instrument, do not apply voltage to TEMP.SENSOR connector.
- Temperature sensors are not waterproof. Do not soak the sensor in water.

#### **IMPORTANT**

- The object to be measured for temperature compensation and the temperature sensor should be given adequate time to adapt to the ambient temperature. If lesser time is given for adaptation to ambient temperature may cause larger errors.
- Handling temperature sensors with bare hands may cause induction noise resulting in unstable measured values.
- Temperature sensors are used to measure ambient temperature. Temperature sensors on the surface of the object to be measured cannot measure correct temperature of the object itself. If there is a large difference in temperature between the ambient temperature and temperature of the object to be measured, use an aluminum tape to attach the temperature sensor onto the object while ensuring that the object is not short-circuited.

## Before connecting the communication cables (USB, LAN, RS-232C, GP-IB)

#### **CAUTION**

-  Before connecting or disconnecting any communications cable, always turn off the instrument and equipment to be connected with. This may cause malfunction or damage.

## Before making a connection to the USB connector

### CAUTION



- To avoid equipment failure, do not disconnect the USB cable while communications are in progress.
- Use a common ground for both the instrument and the computer. Use of different ground circuits will result in a potential difference between the instrument's ground and the computer's ground. If the USB cable is connected while such a potential difference exists, it may result in equipment malfunction or failure.

## Before connecting to the RS-232C or GP-IB connectors

### CAUTION



- Use a common ground for the instrument, computer and programmable controller. Use of different ground circuits will result in a potential difference between the instrument's ground and grounds of the computer and programmable controller. If the communications cable is connected while such a potential difference exists, it may result in equipment malfunction or failure.
- After connecting the communications cable, tighten the screws on the connector securely. Failure to secure the connector could result in equipment malfunction or damage.

## Before connecting a USB flash drive

### CAUTION



- Inserting a USB flash drive upside down, backwards or in the wrong direction may damage the USB flash drive or the instrument.



- Some USB flash drives are susceptible to static electricity. Exercise care when using such products because static electricity could damage the USB flash drive or cause malfunction of the instrument.

With some USB flash drives, the instrument may not start up if power is turned on while the USB flash drive is inserted. In such a case, turn power on first, and then insert the USB flash drive. It is recommended to try out operation with a USB flash drive before starting to use it for actual measurements.

## Before switching the current sink (NPN) / current source (PNP)

### CAUTION



- Never switch between NPN and PNP while the instrument's power is on.



- Configure the NPN/PNP setting based on the externally connected device.

## Before connecting to the EXT I/O connector

### **WARNING**

To avoid electric shock or damage to the equipment, always observe the following precautions when connecting to EXT I/O connector.



- Always turn off the power to the instrument and to any devices to be connected before making connections.
- Be careful to avoid exceeding the rating of EXT I/O connector signal.

## Before connecting a printer

### **WARNING**



To avoid electric shock, turn off the power to all devices before plugging or unplugging any cable between the printer and the instrument.

## 1.1 Product Overview

The Hioki DM7275 and DM7276 Precision DC Voltmeters can measure DC voltages from lithium-ion batteries, electric double-layer capacitors, and other components as well as DC voltages output by sensors and other devices with a high degree of accuracy.

## 1.2 Features

### High-accuracy measurement

The DM7275 and DM7276 deliver the following basic accuracy (in the 10 V range):

<b>DM7275</b>	0.0020% rdg. +12 $\mu$ V
<b>DM7276</b>	0.0009% rdg. +12 $\mu$ V

The DM7276 can measure a 4 V lithium-ion battery with accuracy of 48  $\mu$ V.

### Contact check function

When this function is enabled, measured values are displayed only when the measurement cables are properly connected to the measurement target. It is particularly useful as a way to ensure highly reliable results when measuring the potential on the exterior of a lithium-ion battery.

### Temperature compensation

In addition to DC voltage, the DM7275/DM7276 can measure ambient temperature. When measuring a target that exhibits a high degree of temperature dependency, this function corrects voltage measured values using the measured temperature, making it possible to convert them to voltage values at a reference temperature.

### High-speed measurement and measured value memory

The DM7275/DM7276 can continuously save data to its 5000 data point internal memory at speeds of up to 1 ms. This capability can be used to monitor instantaneous voltage fluctuations or measure multiple targets.

### Extensive interface options

The DM7275/DM7276 provides USB, LAN, RS-232C\*, GP-IB\*, and EXT I/O interfaces, enabling its use in a variety of applications.

\*These interfaces are factory options that must be specified at the time of shipment.

### Intuitive user interface

The DM7275/DM7276 has a 4.3" color LCD and an intuitive, touch-panel based user interface. It also provides extensive analytical functionality, including statistical calculations and trend plots.

### Smooth integration into production lines

- Since the DM7275/DM7276's free power supply specifications can accommodate a power supply from 100 to 240 V, it can be easily deployed on production lines overseas.
- The instrument's communications monitor and EXT I/O test functions facilitate smooth debugging of testing systems.
- Judgment functions can be used to generate PASS/FAIL judgments based on the classification of measurement results into HI, IN, and LO categories (comparator function) or to rank targets into up to 10 categories (BIN function).

# 1.3 Part Names and Functions

## Front

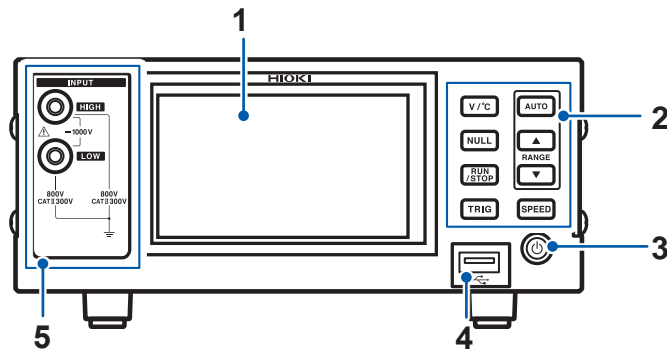

1	<b>Display (Touch panel)</b>	<b>View measured values, settings, and judgment results; configure instrument settings.</b>			
		<ul style="list-style-type: none"> <li>• Display the Settings screen and Measurement screen (measured values and judgment results) (p. 16).</li> <li>• Configure settings (p. 17).</li> </ul>			
2	<b>Operation keys</b>	<b>For more information: See “1.5 Operating the Instrument” (p. 17).</b>			
		<b>[V/°C] key</b>	Toggles display of temperature measured values.	<b>[AUTO] key</b>	Enables auto-range operation (to automatically select an appropriate range).
		<b>[NULL] key</b>	Adjusts the instrument’s zero-point.	<b>[RANGE] [▲] key</b>	Increases the range (to measure high voltages).
		<b>[RUN/STOP] key</b>	Starts and stops measurement.	<b>[▼] key</b>	Decreases the range (to measure at a higher degree of resolution).
		<b>[TRIG] key</b>	Starts measurement (to make measurements at the desired timing).	<b>[SPEED] key</b>	Changes the measurement speed.
3	<b>POWER button (p.28)</b>	<b>Switches the instrument’s power state.</b>	OFF: The instrument is off (no power is being supplied). RED: The instrument is in the SLEEP state (power is being supplied). GREEN: The instrument is on.		
4	<b>USB flash drive connector</b>	<b>Outputs measurement data, screen data, and measurement conditions; loads measurement conditions (p. 115).</b>			
5	<b>Voltage measurement terminals</b>	<b>Connect the measurement cables (p.26).</b>	HIGH terminal: Connect the red cable. LOW terminal: Connect the black cable.		
		See “Before connecting a measurement cable”(p.9).			

## Bottom

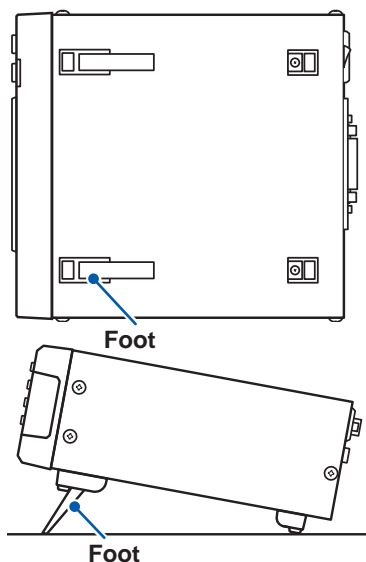

### When mounting the instrument in a rack

Be sure to collapse the feet all the way.

See: “Appx. 7 Rack Mounting” (p.Appx.14)

### When using the feet

Be sure to:

- Open the feet all the way, without stopping partway.
- Erect both feet.

Rear

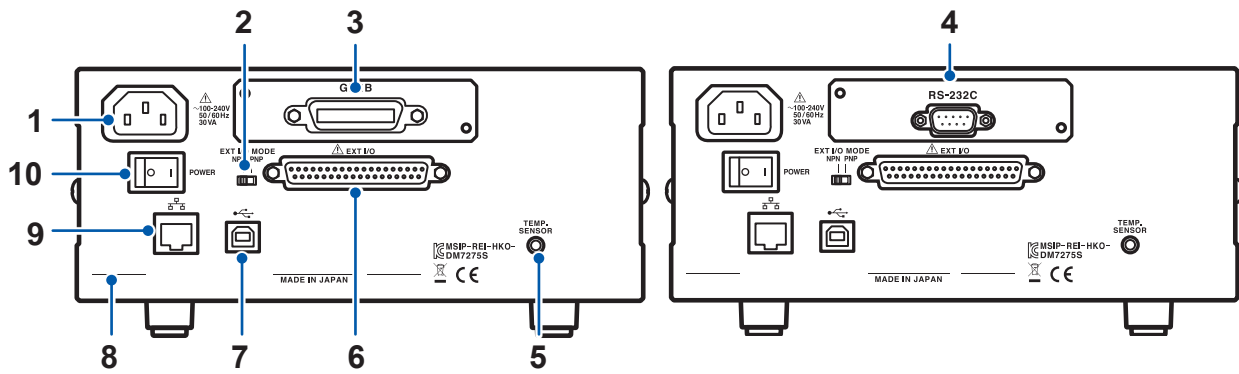

1

Overview

1	Power inlet	Connect the power cord (p.25). ⚠ See “Before connecting a power cord”(p.8).	
2	NPN/PNP switch	Switches the EXT I/O between NPN and PNP modes (p.126).	Left: Current sink (NPN) Right: Current source (PNP)
3	GP-IB connector	Used in GP-IB communications (p.102). Connect the instrument to a computer with a GP-IB cable.	
4	RS-232C connector	Used in RS-232C communications (p.100). Connect the instrument to a computer, programmable controller, printer, or other device with an RS-232C cable.	
5	TEMP.SENSOR connector	Used to measure temperature (p.27). Connect the Z2001 Temperature Sensor.	
6	EXT I/O connector	Used in external control (p.125). Connect the input signal from a programmable controller, I/O board, or other device to control the instrument. ⚠ See “Before connecting to the EXT I/O connector”(p.12).	
7	USB connector	Used in USB communications (p.98). Connect the instrument to a computer with a USB cable.	
8	Serial number	Do not remove the serial number as it is necessary for management purposes.	
9	LAN connector	Used in LAN communications (p.104). Connect the instrument to a computer with a LAN cable.	
10	Main power switch	Turns the instrument’s main power supply on and off (p.28).	○ : Main power supply off   : Main power on

Model		Interfaces			
DM7275	DM7276	LAN	USB	GP-IB	RS-232C
DM7275-01	DM7276-01	✓	✓	-	-
DM7275-02	DM7276-02	✓	✓	✓	-
DM7275-03	DM7276-03	✓	✓	-	✓

✓: Available, -: Not available

# 1.4 Screen Layout

## Measurement screen

## Settings screen

Touch the measurement parameter, measurement range, measurement speed, or **MENU** on the touch panel.

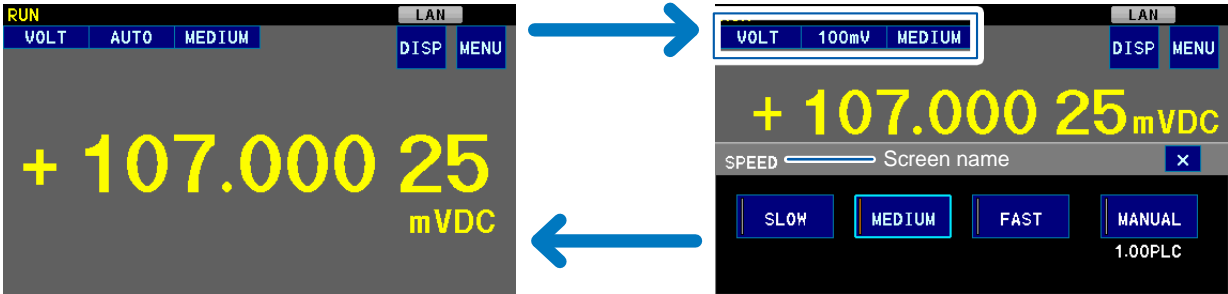

Touch **[x]** to close the screen.



Example: If you touch the measurement speed

## Measurement screen + sub-display selection

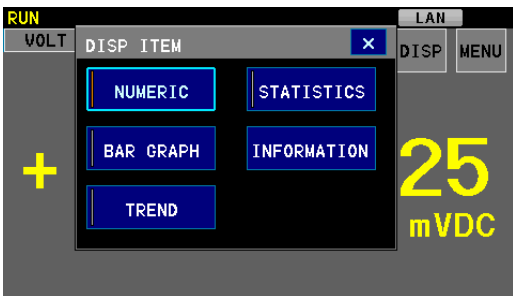

Touch the item you wish to display on the sub-display.  
See "Displaying trends, bar graphs, statistics, and judgment results"(p.43)

## Measurement screen + sub-display

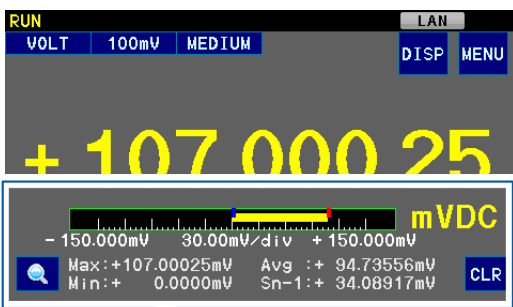

Touch **DISP.**

Sub-display

Example: If you touch **BAR GRAPH**



# 1.5 Operating the Instrument

The instrument is operated using the operation keys and the touch panel.

## Changing settings

Settings are changed using the touch panel.

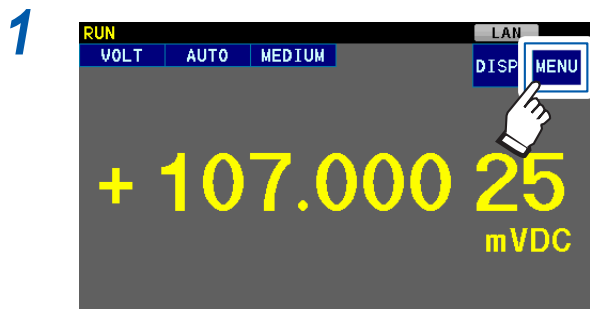

Touch **MENU**.

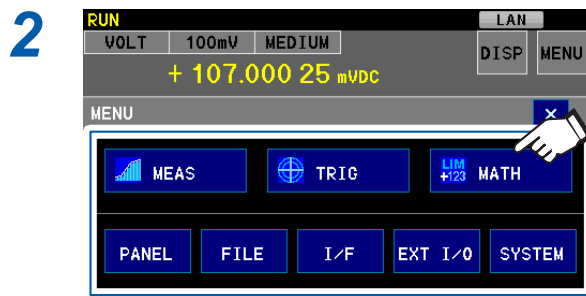

Touch a setting and change its value on the displayed Settings screen.

## Returning to the previous screen

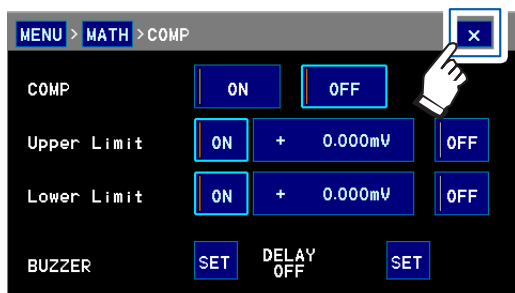

Or

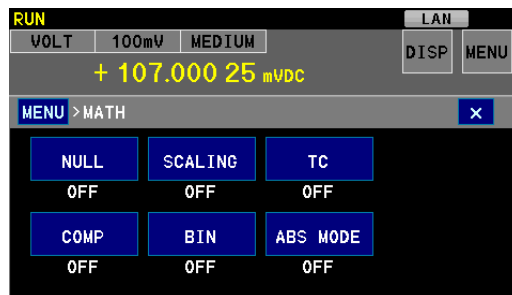
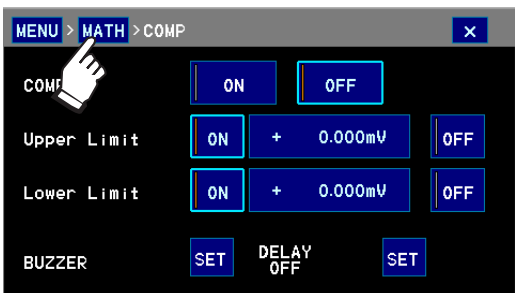

## Switching the measured value display

### Operation key



Each time the key is pressed, the measured values shown on the screen will switch between voltage only and voltage and temperature.

### Touch panel

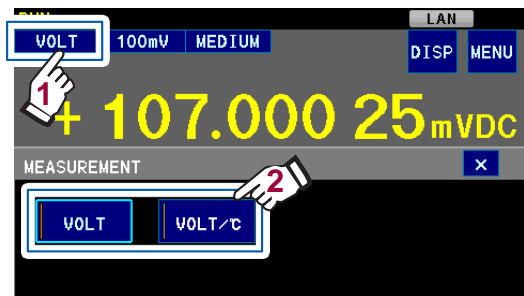

- When measuring temperature, connect the temperature sensor to the instrument in advance. (p.27)
- Temperature measured values are not shown on the trend display or settings screens.
- The instrument will continue to measure temperature internally even if the temperature is not being displayed on the screen.
- The temperature display is updated together with the voltage display.

## Changing the range

See “3.2 Setting the Measurement Range” (p.35).

### Operation keys



Causes the optimal range to be set automatically. (Auto-range operation)



RANGE



Switches the range.

### Touch panel

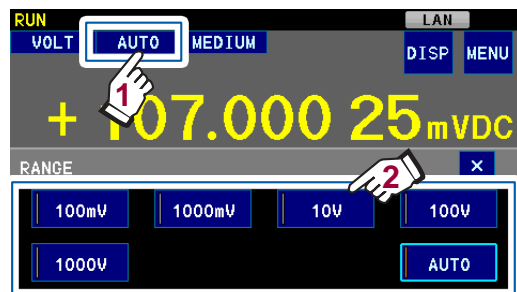

## Changing the measurement speed

See “3.3 Setting the Measurement Speed” (p.36).

### Operation key



Switches the measurement speed.

### Touch panel

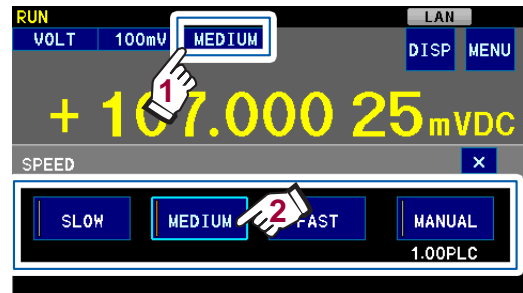

## Starting measurement

By default, the instrument is in the **RUN** state. In this state, measurement will continue automatically.

### Continuous measurement (default setting: **RUN** state)

See “Continuous measurement”(p.37).

#### **RUN** state

Measurement will continue automatically, and measurement data will be saved in the instrument's internal memory.



#### **STOP** state

Measurement will stop, and the last measured value will be saved.

### Making measurements at the desired timing

See “Trigger measurement (measurement with user-specified timing)”(p.38).

#### **Starting measurement**

Measurement can be started by either of the following methods:

- While in the **STOP** state, 
- While the trigger source is set to **EXTERNAL**, send the TRIG signal to the instrument from an external device.



After the set number of measurements (default setting: 1) have been performed, measurement will stop automatically.

Measurement data will be saved in the instrument's internal memory.

Up to 5000 measured values can be saved in the instrument's internal memory. Saved measured values can be displayed in graph form to illustrate the trend in voltage readings (trend display) or output to a USB flash drive.

# 1.6 How to Use This Manual

This manual describes how to display Settings screens as included in the broken border below. The indicated keys should be touched, starting on the Measurement screen.



Example: (Measurement screen) > MENU > MATH > COMP

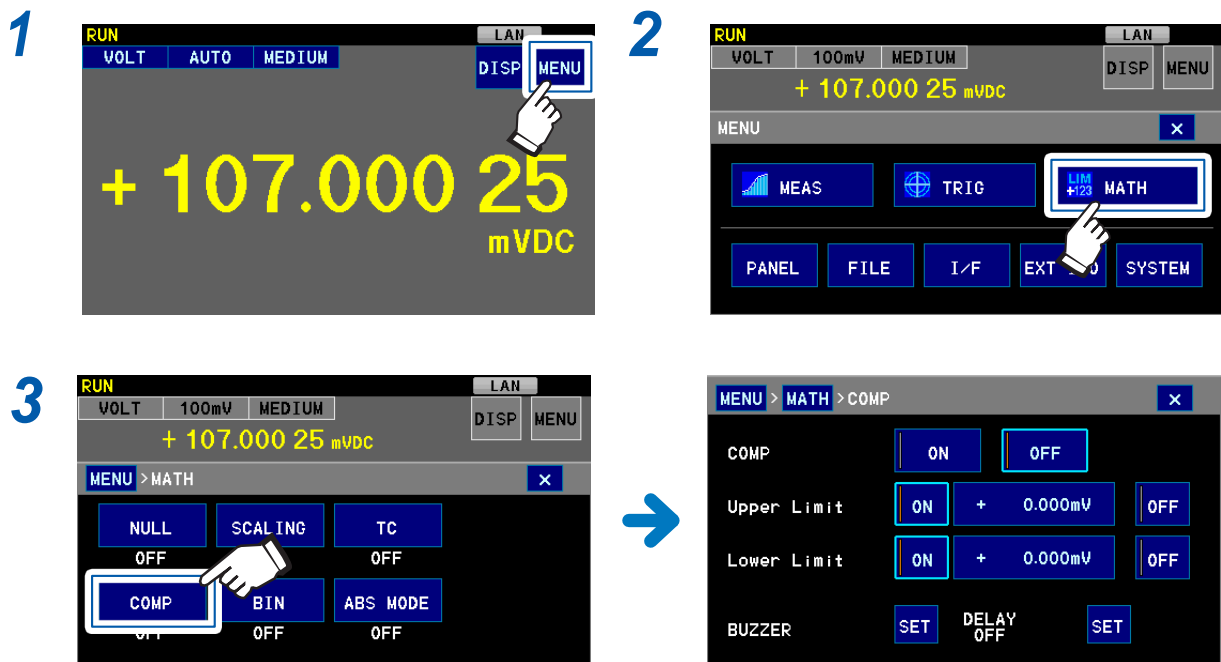



# 2

# Preparing for Measurement

## 2.1 Preparation Process

Before starting, read “Operating Precautions” (p.7) carefully.

For more information about rack mounting, see “Appx. 7 Rack Mounting” (p.Appx.14).

(1) Position the instrument as desired. (p.7).

(2) Perform the pre-measurement inspection. (p.24).

(3) Connect the power cord. (p.25).

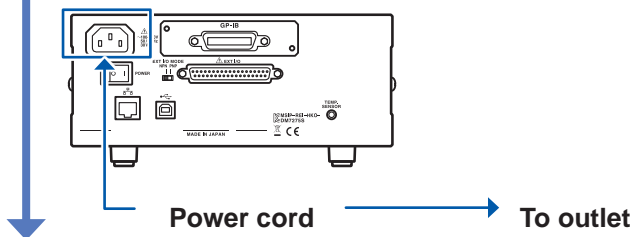

(4) Connect the measurement cables to the measurement terminals. (p.26).

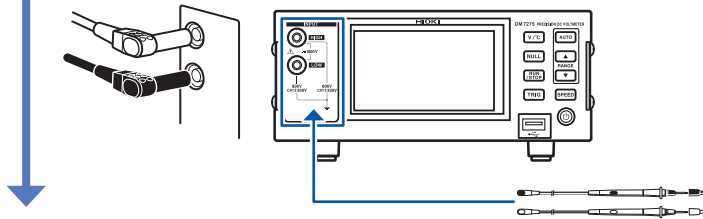

(5) Connect the temperature sensor to the TEMP.SENSOR connector. (When performing temperature measurement or using the temperature compensation function) (p.27)

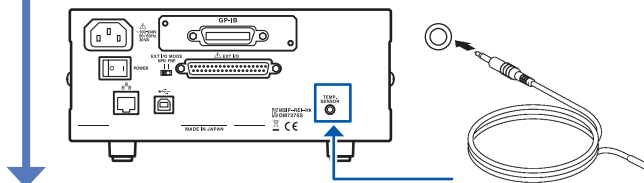

(6) Configure and connect the external interface (as necessary).

- Using the USB interface. (p.98)
- Using the RS-232C interface. (p.100)
- Using the GP-IB interface. (p.102)
- Using the LAN interface. (p.104)
- Using a USB flash drive (p.115)
- Using the EXT I/O connector (p.125)

(7) Turn on the instrument. (p.28).

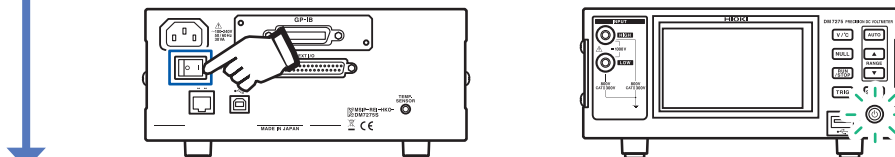

(8) Set the time and date. (p.30).

# 2

## 2.2 Performing the Pre-measurement Inspection

Before using the instrument, inspect the instrument to ensure that nothing has broken during storage or shipment and to verify proper operation. If you find any damage, contact your authorized Hioki distributor or reseller.

### 1 Inspecting peripheral equipment

Is there any damage to the power cord's insulation, or is there any metal exposed on the cord?

→  
Yes

If you find any damage, do not use the instrument as the damage may cause an electric shock or short-circuit. Contact your authorized Hioki distributor or reseller.

↓ No

Is there any damage to the insulation on the measurement cables, or is there any metal exposed on the cables?

→  
Yes

If you find any damage, it may cause a short-circuit or electric shock. Replace the damaged cables.

↓ No

### 2 Inspecting the instrument

Is there any damage to the instrument?

→  
Yes

If you find any damage, have the instrument repaired.

↓ No

**When you turn on the instrument**

Does the power button turn green or red?

→  
No

There may be a break in the power cord or damage to the instrument's internal components. Have the instrument repaired.

↓ Yes

Is the Measurement screen displayed after the self-test completes (after the model number is displayed)?

→  
An error is indicated.

The instrument's internal components may be damaged. Have the instrument repaired. See "14.1 Q&A (Frequently Asked Questions)" (p. 168) and "14.3 Error Displays" (p. 176).

↓ Yes

**This completes the inspection.**



## 2.3 Connecting the Power Cord

Before using the instrument, read “Before connecting a power cord” (p.8) carefully.

Connect the power cord to the instrument and a power outlet.

You will need: The power cord (instrument accessory)

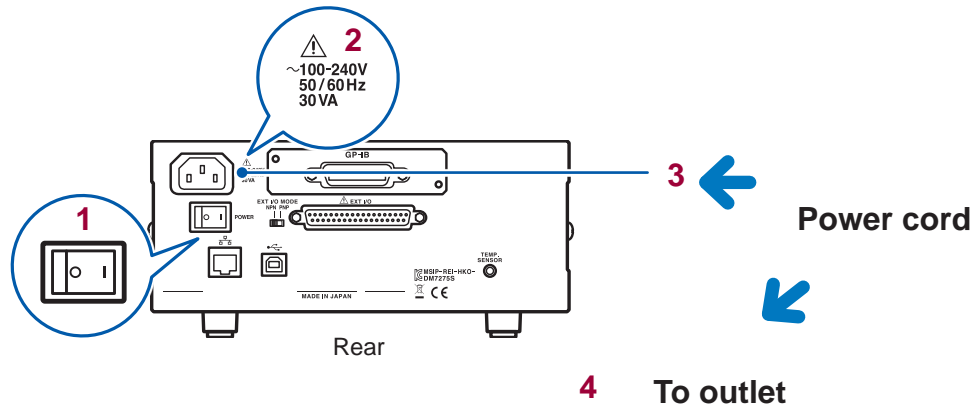

- 1** Turn off the main power switch.

---

- 2** Verify that the power supply voltage conforms to the instrument's specifications.

---

- 3** Connect the power cord to the power inlet on the instrument.

---

- 4** Connect the cord to the power outlet.

If the power supply is interrupted while the main power switch is in the “ON” position (for example, due to a circuit breaker tripping), the instrument will turn on automatically once power is restored.

## 2.4 Connecting the Measurement Cables (to the Instrument)

Before connecting the measurement cables, read “Before connecting a measurement cable” (p.9) carefully.

Connect the optional Hioki measurement cables to the instrument's measurement terminals.

Use only Hioki measurement cables. See “Options (Sold Separately)” (p.3) and “3.1 Connecting the Measurement Cables (Measurement Target)” (p.31).

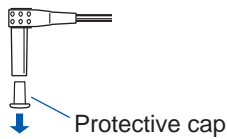

Each test lead plugs is covered by a protective cap.  
Remove this cap before use.

Connect as follows:

Plug	Terminal
Red	HIGH
Black	LOW

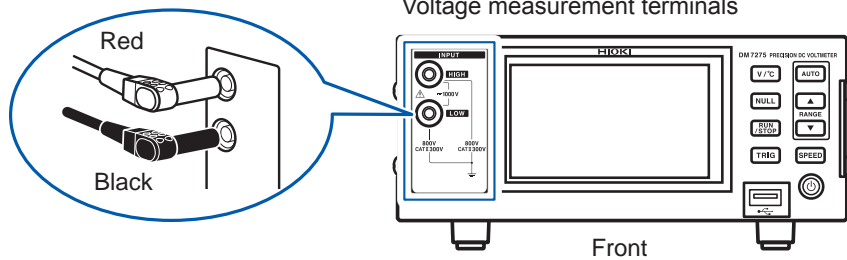

## 2.5 Connecting the Temperature Sensor

Before connecting the temperature sensor, read “Before connecting a temperature sensor” (p.9) carefully.

If you wish to measure temperature or use the temperature compensation function, connect the temperature sensor to the instrument's TEMP.SENSOR connector.

You will need: Z2001 Temperature Sensor (optional)

2

Preparing for Measurement

### (1) Connect the temperature sensor.

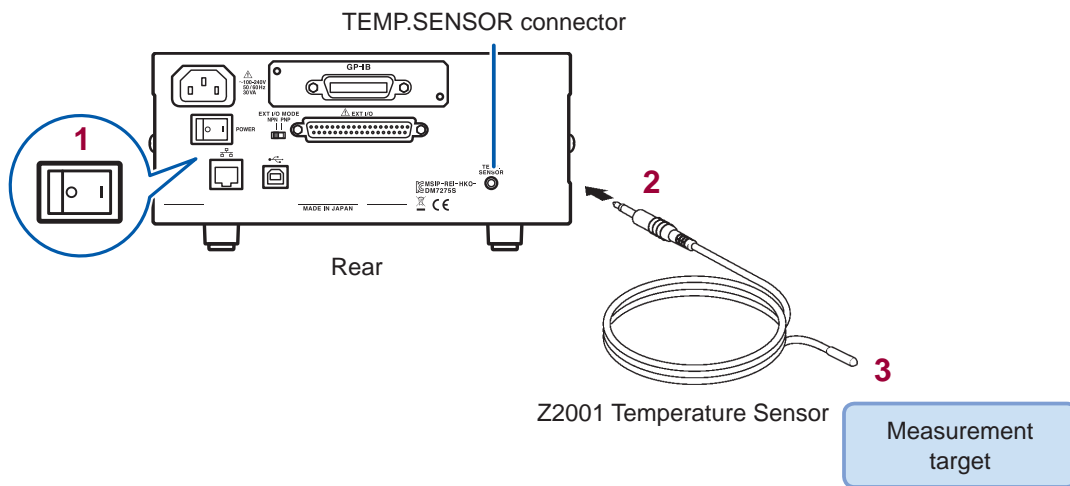

- 1** Turn off the main power switch.
- 2** Connect the temperature sensor to the TEMP.SENSOR connector.
- 3** Position the end of the temperature sensor close to the measurement target.
- 4** Press the [V/°C] key to display the temperature.

### (2) Verify the measured value.

After turning on the power, check whether the temperature measured value is correct.

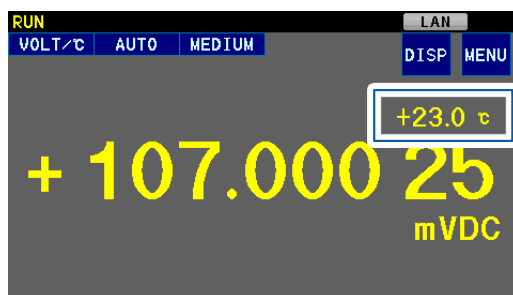

For more information: “Switching the measured value display” (p. 18), “Measured temperature is not displayed correctly.” (p. 171)

The temperature display is updated together with the voltage display.

## 2.6 Turning the Instrument On and Off

Before turning the instrument on, read “Before turning the power ON” (p.9) carefully.

Turn on the main power switch on the rear of the instrument. Once this switch has been turned on, the instrument can be turned on and off using the POWER button on the front panel.

The ability to use the POWER button on the front panel is convenient when embedding the instrument in an automated system or production line. If the instrument is in the SLEEP state when the main power switch is turned off, it will turn on in the SLEEP state when the main power switch is turned back on.

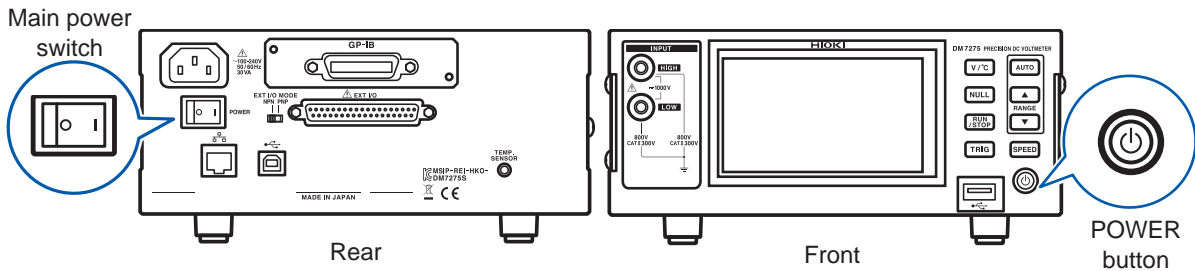

### Turning on the main power switch

Set the main power switch to “ON (I).”



The POWER button will turn red or green.



### Turning off the main power switch

Set the main power switch to “OFF (O).”



The POWER button will turn off.



Startup settings can be selected. See “7.7 Selecting Startup Load Settings and a Panel” (p.91)

### Placing the instrument in the SLEEP state

Press and hold the POWER button for about 2 seconds while the main power switch is in the “ON” position.



The POWER button will turn red.



**What is the SLEEP state?**  
When the instrument is off, it is in the SLEEP state. (Only the circuit used to turn on the POWER button's indicator lamp is operating.)

## Canceling the SLEEP state

Press the **POWER** button while the instrument is in the **SLEEP** state.



The **POWER** button will turn green.



Lighting-up in red



To make measurements at the accuracy described in the instrument's specifications, allow the instrument to warm up for at least 60 minutes after turning on the main power switch or canceling the SLEEP state.

When the main power switch is turned on or the SLEEP state is canceled, the self-test (a series of self-diagnostics performed by the instrument) will start automatically.

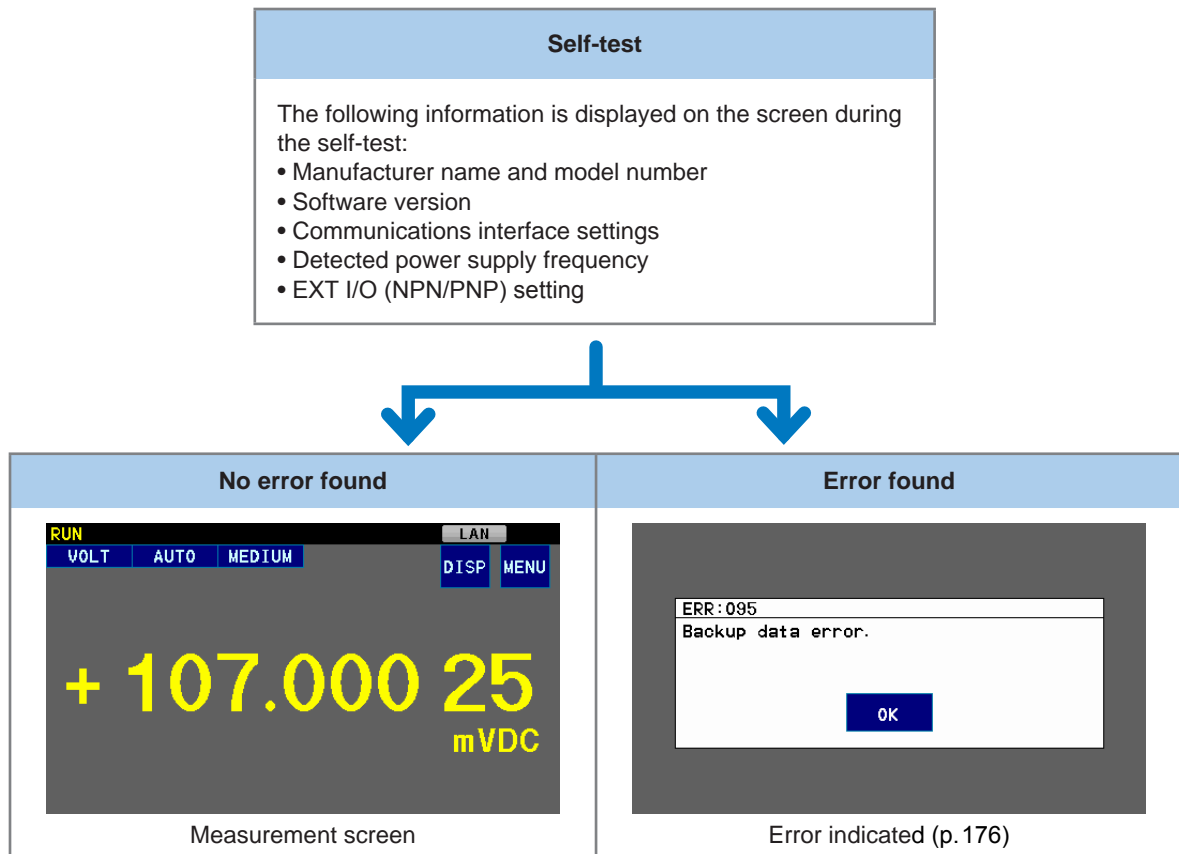

- The following options are available for the measurement conditions that are loaded after the self-test completes: “Use settings in effect when instrument was turned off,” “Use factory default settings,” and “Load specified panel.” (For more information about the default settings, see “7.7 Selecting Startup Load Settings and a Panel” (p.91).)
- The instrument’s power supply frequency setting is automatically set to the power supply’s frequency.  
(This setting can also be changed manually: See “7.6 Setting the Power Supply Frequency” (p.90).)

## 2.7 Setting the Time and Date

Before making measurements, set the instrument's time and date.

(Measurement screen) **MENU > SYSTEM**

1

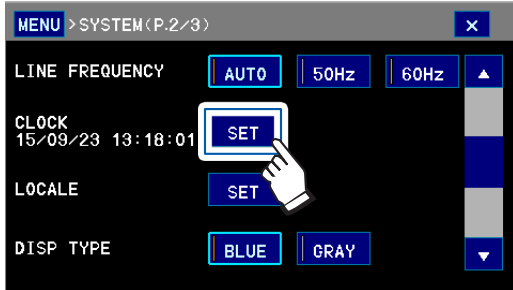

2

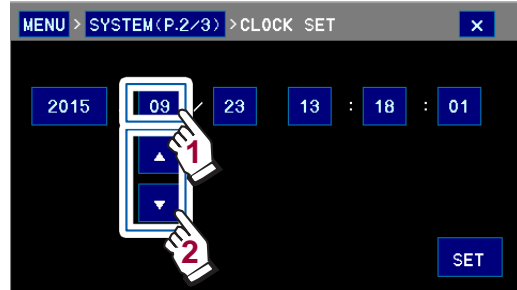

Example: Setting the month  
(Default setting: 12:00 am on January 1, 2015)

# 3

# Measurement

## 3.1 Connecting the Measurement Cables (Measurement Target)

Before connecting the measurement cables to the measurement target, read “Before connecting a measurement cable” (p.9) and “Before starting a measurement” (p.10) carefully.

Use Hioki’s optional test leads, contact pins, alligator clips, or other connectors as appropriate depending on the measurement target.

For more information: “Options (Sold Separately)” (p.3)

### Using the L9207-10 Test Lead

#### (1) About the L9207-10

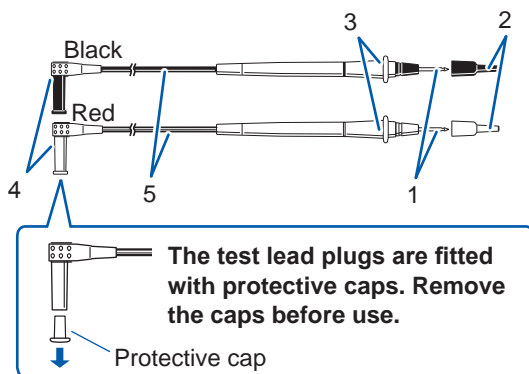

1	Metal pins	Connect the metal pins to the measurement target. With cap: 4 mm or less Without cap: 19 mm or less Thickness: Approx. 2 mm
2	Caps	Fit the caps to the metal pins to prevent short-circuits. The test leads can also be used with the caps removed.
3	Barriers	The barriers indicate the safe distance from the metal pins.  <div style="border: 1px solid red; padding: 5px; text-align: center;">During measurement, do not touch the area in front of the barriers.</div>
4	Plugs	Connect the plugs to the instrument's measurement terminals.
5	Cables	The cables have a double-insulated design. (Length: Approx. 900 mm; thickness: approx. 3.6 mm)  <div style="border: 1px solid red; padding: 5px; text-align: center;">If the white portion of the inside of the cable is exposed, replace the test leads with a new L9207-10 set.</div>

Remove the caps when using the test leads with the L4933 Contact Pin Set or the L4934 Small Alligator Clip Set.

**Removing the caps**

**Gripping the base of the cap gently, pull to remove.**  
Store caps after removal so as not to lose them.

**Fitting the caps**

**Pass the test lead metal pin through the hole in the cap and insert firmly all the way.**

(2) Example connections

L9207-10 Test Lead

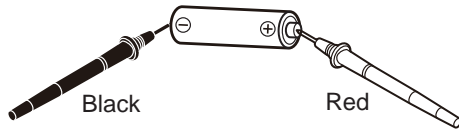

Connect, taking care to align the measurement cable colors with the measurement target's polarity.

L9207-10 Test Lead + L4933 Contact Pin Set

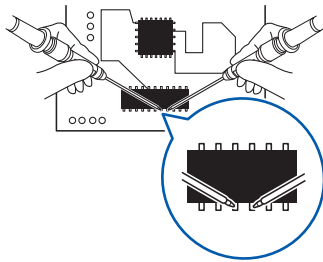

L4933 pin diameter:  $\phi 1.0$  mm

L9207-10 Test Lead + L9434 Small Alligator Clip Set

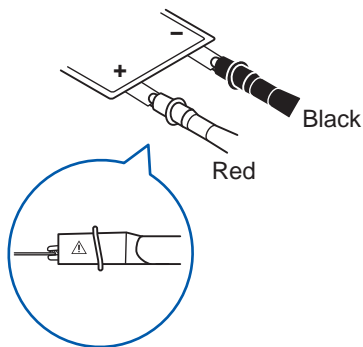

Connect, taking care to align the measurement cable colors with the measurement target's polarity.

L9434 maximum clip width: 2.0 mm



## Using the L4930 Connection Cable Set

Remove the protective caps before use.

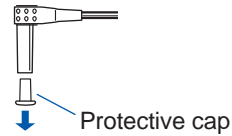

### Example connections

#### L4930 Connection Cable Set + L4931 Extension Cable Set

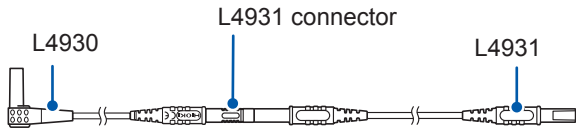

Connect using the L4931's rod-shaped connector.

#### L4930 Connection Cable Set + L4935 Alligator Clip Set

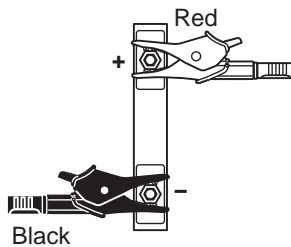

Connect, taking care to align the measurement cable colors with the measurement target's polarity. Clip at the middle of the clip.

#### L4930 Connection Cable Set + 9243 Grabber Clip

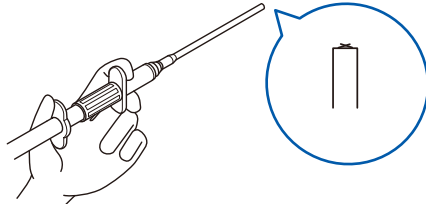

**1** Grip the 9243 as shown to the left.

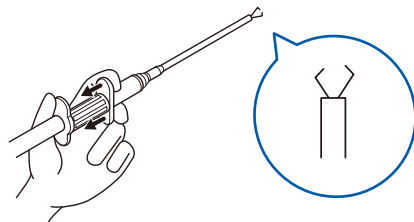

**2** Open the tip of the clip by depressing as you would the plunger of a syringe.

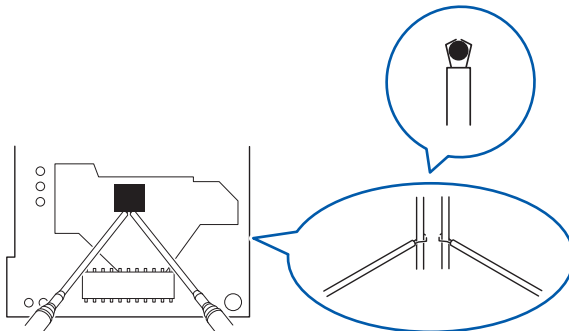

**3** Grip the measurement target with the clip.

The clip will close when you release your fingers.

L4930 Connection Cable Set + L4936 Bus Bar Clip Set

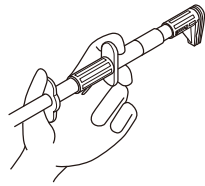

**1** Grip the L4936 as shown to the left.

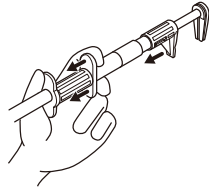

**2** Open the clip by depressing as you would the plunger of a syringe.

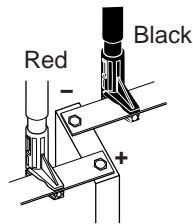

**3** Connect, taking care to align the measurement cable colors with the measurement target's polarity.

The clip will close when you release your fingers.

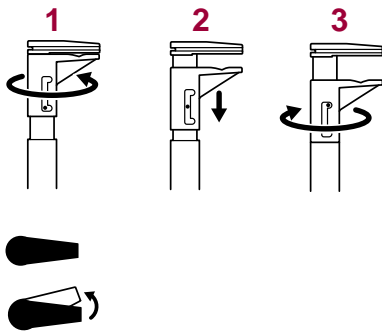

To apply the clip to a thick target:

- 1** Rotate the clip's lower jaw.
- 2** Lower the lower jaw.
- 3** Rotate the clip's lower jaw in the opposite direction.

In this configuration, the clip can be applied to a measurement target of 30 mm or less.

## 3.2 Setting the Measurement Range

By default, the range is set to **AUTO** (auto-range operation). In this setting, the range is automatically switched to an appropriate setting. You can also fix the range as desired (manual range operation).

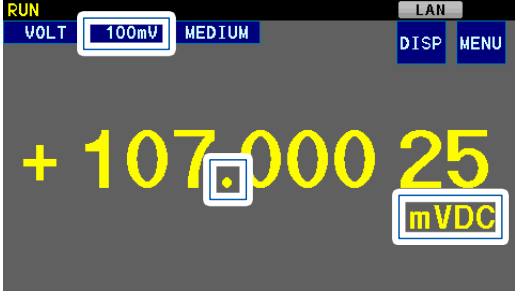
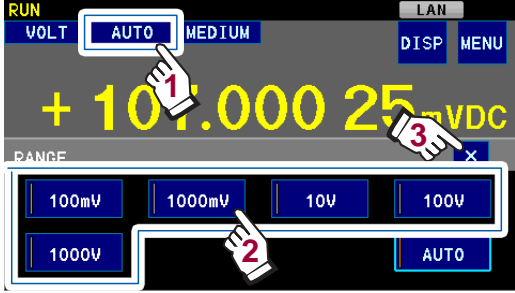
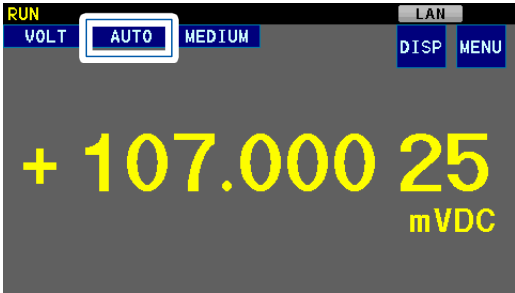
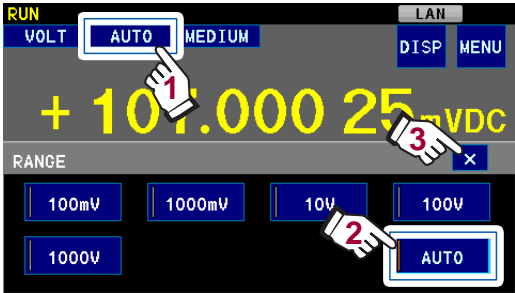
	Setting with the operation keys	Setting with the touch panel
Manual-range operation	<p>Press the [<b>▲▼</b>] keys. Each time you press one of the keys, the range, decimal point position, and unit will change (indicated by the boxes below).</p> 	
Auto-range operation	<p>Press the [<b>AUTO</b>] key.</p> 	

3

Measurement

Auto-range operation may not stabilize for some measurement targets. In this case, set the range manually.

### 3.3 Setting the Measurement Speed

The slower the measurement speed, the higher the measurement accuracy. In addition to setting the measurement speed to **FAST**, **MEDIUM**, or **SLOW**, you can set the integration time as desired. For more information: “Setting the integration time” (p.67)

The **FAST**, **MEDIUM**, and **SLOW** settings differ in terms of integration time as follows:

Setting	Integration time	Measurement speed	Measurement precision (Influence of external environment)
<b>FAST</b>	1 PLC*	Fast ↕ Slow	Low (Prone to influence of external environment)
<b>MEDIUM</b>	10 PLC		↕
<b>SLOW</b>	100 PLC		High (Resistant to influence of external environment)
<b>MANUAL</b> (p.67)	As set by user	As set by user	As set by user

\* PLC stands for power line cycle. The interval of 1 PLC is equivalent to one cycle of the supplied power source. If using the instrument in an area with 50 Hz power, 1 PLC = 1/50 = 20 ms. If using the instrument in an area with 60 Hz power, 1 PLC = 1/60 = 16.7 ms.

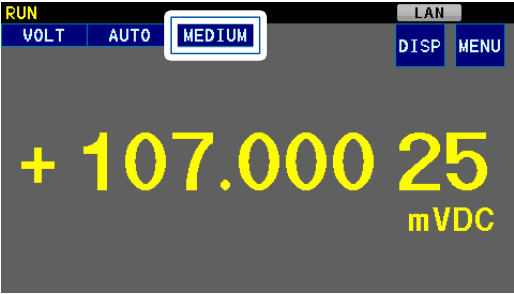
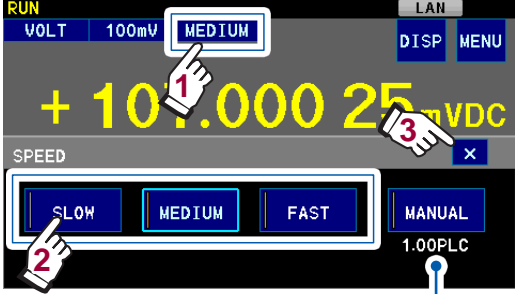
Setting with the operation keys	Setting with the touch panel
<p><b>Press the [SPEED] key.</b> The measurement speed will change each time the key is pressed (indicated by the box below).</p>  <p>You can set the desired integration time using the touch panel.</p>	 <p>See “Setting the integration time” (p.67)</p>

- If measurement is prone to the influence of the external environment: See “Appx. 4 Noise Countermeasures” (p.Appx.8) for more information.
- The instrument performs self-calibration between measurements. For more information about measurement times, see “11.6 Timing Chart” (p.139).

## 3.4 Starting Measurement

The instrument supports two types of measurement: continuous measurement and trigger measurement. By default, the instrument is configured to perform continuous measurement (in the **RUN** state).

### Continuous measurement

Once the measurement cables have been connected to the measurement target, the instrument will display measured values. Measurement data is saved in the instrument's internal memory (p.42).

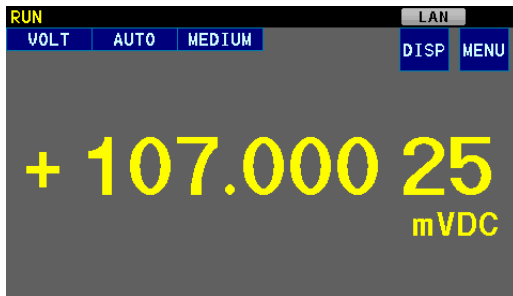

The display indicates something other than a measured value.	▶ See "3.5 Measurement Error Displays (Displays Other Than Measured Values)" (p.46)
If you wish to check the temperature	▶ See "Switching the measured value display" (p.18)
If you wish to convert to a measured value other than voltage	▶ See "6.5 Correcting Measured Values" (p.77)
If the measured value is not updated even when you connect the instrument to another measurement target	▶ Continuous measurement has stopped (the instrument is in the <b>STOP</b> state). Either start continuous measurement (by placing the instrument in the <b>RUN</b> state) or perform trigger measurement to update the measured value.

#### Stopping continuous measurement

Press the **[RUN/STOP]** key while the instrument is in the **RUN** state.

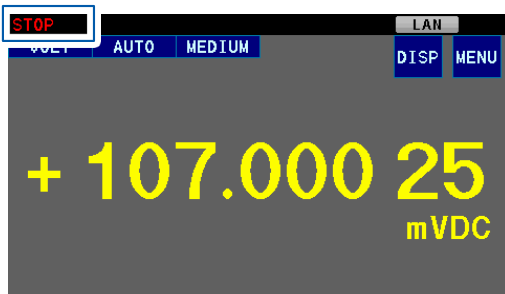

The instrument will switch to the **STOP** state.

The measured value will not be updated (instead, it will be fixed). If you wish to update the measured value, either perform trigger measurement (p.38) by pressing the **[TRIG]** key or resume continuous measurement.

#### Starting continuous measurement

Press the **[RUN/STOP]** key while the instrument is in the **STOP** state.

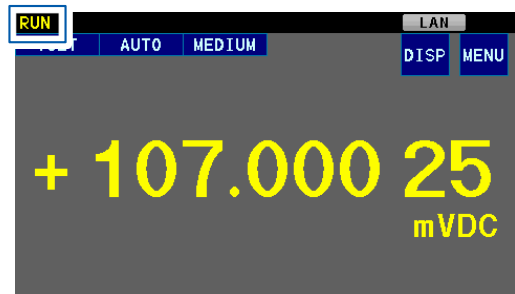

The instrument will switch to the **RUN** state.

The measured value will be continuously updated. Display values can be automatically held in order to make it easier to read measured values while operating in the **RUN** state.

For more information: "6.2 Auto-hold Function" (p.70)

## Trigger measurement (measurement with user-specified timing)

### Definition of trigger

Operation to start measurement is termed “inputting a trigger.” Measurement can be started by means of the following operations:

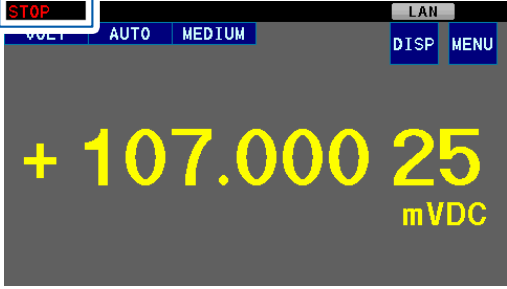
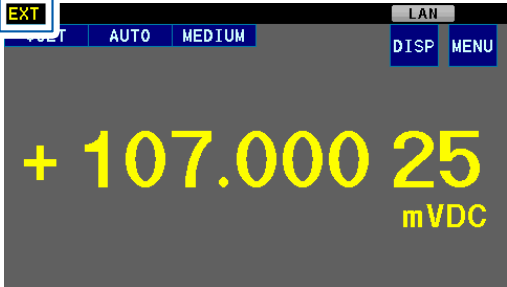
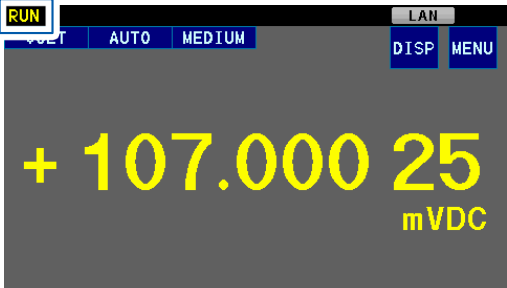
Instrument state	Trigger input method	Screen
<b>STOP</b>	Pressing the <b>[TRIG]</b> key The instrument will not accept the EXT I/O TRIG signal or the <b>*TRG</b> command.	 The screenshot shows the instrument's display in the STOP state. A red box highlights the 'STOP' indicator in the top left corner. The main display shows a measurement of '+ 107.000 25 mVDC'. The top status bar includes 'LAN', 'DISP', and 'MENU' buttons, and the bottom bar shows 'VOLT', 'AUTO', and 'MEDIUM'.
Trigger source: <b>EXTERNAL</b>	<ul style="list-style-type: none"> <li>Pressing the <b>[TRIG]</b> key</li> <li>Inputting the TRIG signal from the EXT I/O</li> <li>Sending the <b>*TRG</b> command</li> </ul>	 The screenshot shows the instrument's display in the EXT state. A red box highlights the 'EXT' indicator in the top left corner. The main display shows a measurement of '+ 107.000 25 mVDC'. The top status bar includes 'LAN', 'DISP', and 'MENU' buttons, and the bottom bar shows 'VOLT', 'AUTO', and 'MEDIUM'.
<b>RUN</b>	The trigger will be applied automatically, and measurement will continue.	 The screenshot shows the instrument's display in the RUN state. A red box highlights the 'RUN' indicator in the top left corner. The main display shows a measurement of '+ 107.000 25 mVDC'. The top status bar includes 'LAN', 'DISP', and 'MENU' buttons, and the bottom bar shows 'VOLT', 'AUTO', and 'MEDIUM'.

Inputting the trigger while the instrument is not in the **RUN** state will cause measurement to be performed the set number of times (the default setting is 1), after which the instrument will enter the standby state and wait for the next trigger.

Measurement data is stored in the instrument's internal memory (p.42).

The **RUN** state can be canceled by sending a communications command (**:INITIATE:CONTINUOUS OFF**) to the instrument via the RS-232C, USB, GP-IB, or LAN interface. For more information about commands, see the Communication Command Instruction Manual on the included application disc.

## Trigger function settings

### Trigger source

You can set whether to enable trigger input from an external device. Setting the trigger source to **EXTERNAL** enables use of the EXT I/O TRIG terminal as well as the **\*TRG** command. The default setting is **INTERNAL** (**RUN** state).

### Delay

You can set the delay time from trigger input until the start of measurement from 0 ms to 9999 ms in increments of 1 ms. The default setting is **PRESET** (0 ms).

Adjust the delay time for measurement targets that require some time to respond. Set a long delay time at first and then gradually shorten the time while viewing measured values.

### Measurement count

You can set how many measurements to perform for each trigger event from 1 to 5000. The default setting is 1. This setting is disabled while the instrument is in the **RUN** state.

(Measurement screen) **MENU > TRIG > SOURCE**

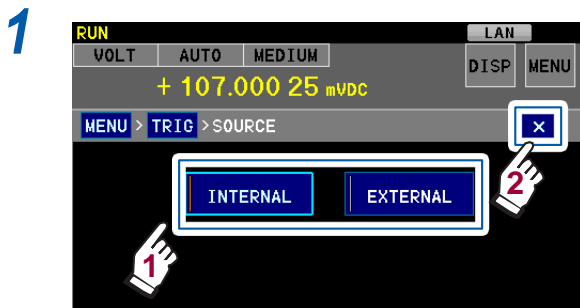

#### Setting the trigger source

<b>INTERNAL</b>	Sets the instrument to the RUN state (default setting).
<b>EXTERNAL</b>	Enables trigger input from an external device.

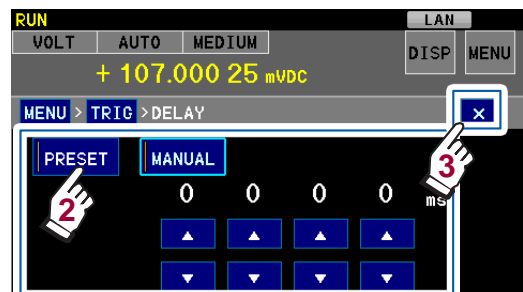
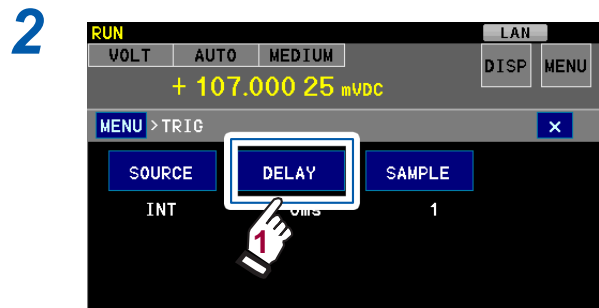

#### Setting the delay

<b>PRESET</b>	No delay time (0 ms) (default setting)
<b>MANUAL</b>	Sets the delay time.
<b>^</b>	Increases the setting by 1.
<b>v</b>	Decreases the setting by 1.

(Valid setting range: 0 ms to 9999 ms)

3

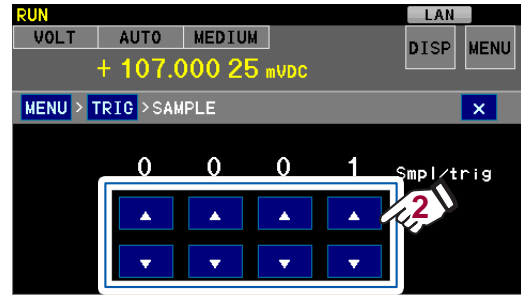
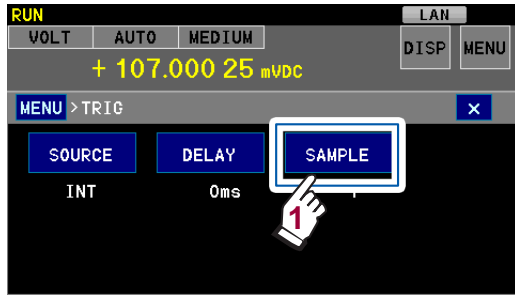

**Setting the measurement count**

- ▲ Increases the setting by 1.
- ▼ Decreases the setting by 1.

(Default setting: 1, valid setting range: 1 to 5000 measurements)

- One contact check and delay will be inserted after trigger input. Measurement will then continue without any delay until the next trigger input.
  - Self-calibration will not be performed until the set number of measurements is performed. In the event that the value obtained by multiplying the integration time by the measurement count is greater than 1 minute, manage the ambient temperature such that it does not vary more than  $\pm 1^{\circ}\text{C}$ . (For an example, see “Appx. 5 Self-calibration” (p.Appx.11))
- For more information: “Setting the integration time” (p.67), “6.3 Contact Check” (p.71)



## Trigger measurement operation (in the **STOP** state or when the trigger source is set to **EXTERNAL**; with contact check set to **ON**)

When the contact check function is set to **OFF**, no contact check will be performed after trigger input.

### Example 1: Measurement count of 1

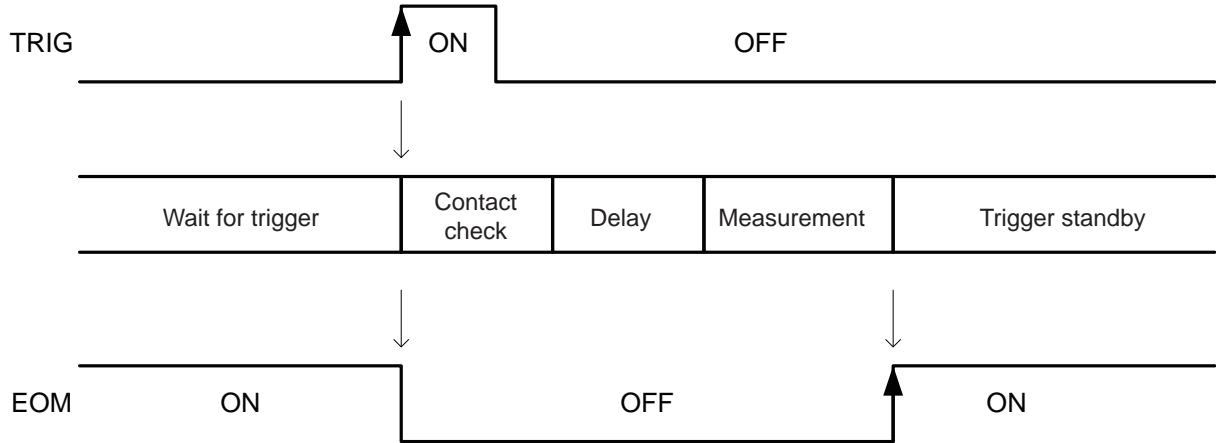

### Example 2: Measurement count of n

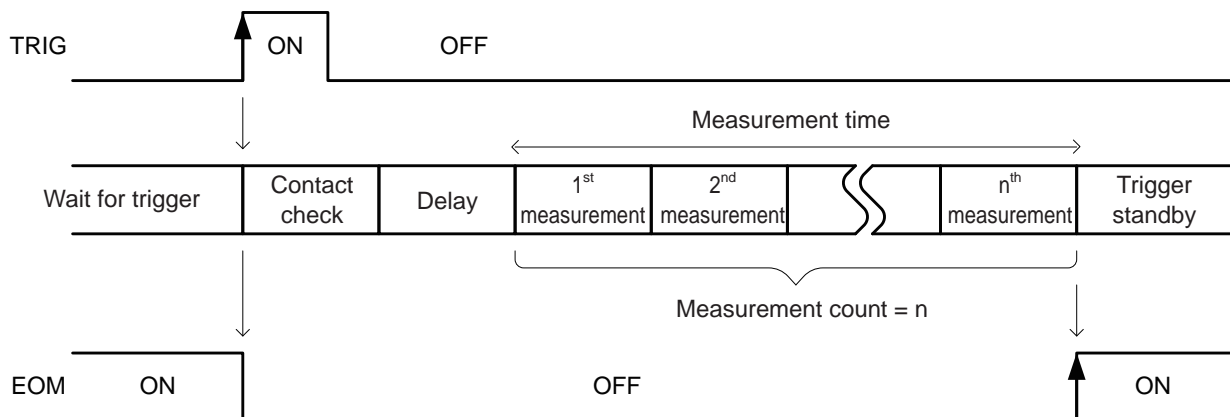

### Measurement time (reference value)

Integration time setting	Measurement time [ms]
0.02PLC	$0.4 \times n$
0.2PLC	(50 Hz) $4 \times n$ , (60 Hz) $3.2 \times n$
1PLC (FAST)	(50 Hz) $20 \times n$ , (60 Hz) $16.7 \times n$
10PLC (MEDIUM)	(50 Hz) $200 \times n$ , (60 Hz) $167 \times n$
100PLC (SLOW)	(50 Hz) $3900 \times n$ , (60 Hz) $3400 \times n$
ms	Integration time $\times n$

Measured values up to the (n-1)<sup>th</sup> measurement are not used in comparator or BIN judgment. Only the n<sup>th</sup> measured value is used in judgment output.

## Storage of measurement data in the instrument's internal memory

Measured values are always stored in the instrument's internal memory, which is structured as a ring buffer. Once all 5000 spaces in the internal memory are occupied by measured values, the oldest measured value will be deleted and replaced with the most recent measured value starting with the next measurement.

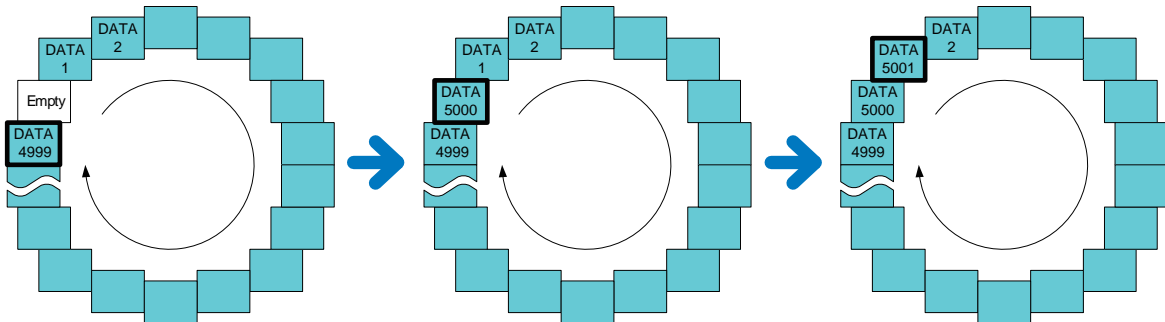

The contents of the instrument's internal memory can be checked using the trend display (p.43, p.45). To check values in a more detailed manner, output the data to a computer and use a spreadsheet or other software to open it.

### IMPORTANT

The instrument's internal memory is erased at the following times:

- When the instrument is reset
- When a panel is loaded
- When **CLR** is touched on the Trend Display screen
- When the memory is cleared using a remote command
- When the **:INITIATE:IMMEDIATE** command or the **:READ?** query is used
- When the instrument is turned off

### To output data from the instrument's internal memory

- Measurement data stored in the instrument's internal memory can be output to a USB flash drive. See "10 Using a USB Flash Drive" (p.115) , "Outputting all measurement data" (p.119)
- Communications commands can be used to download measurement data to a programmable controller or computer. See "8 Preparing to Use USB, RS-232C, GP-IB, and LAN Control" (p.97)
- Use the data output function to output the most recent measured value. See "9 Outputting Data" (p.111)

## Displaying trends, bar graphs, statistics, and judgment results

In addition to measured values, it is possible to display trends (voltage trends), bar graphs, statistics, and judgment results (for comparator measurement and BIN measurement) (on the sub-display).

1

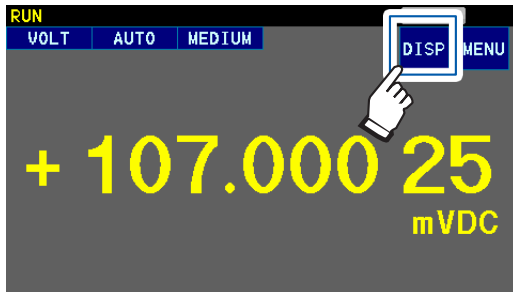

2

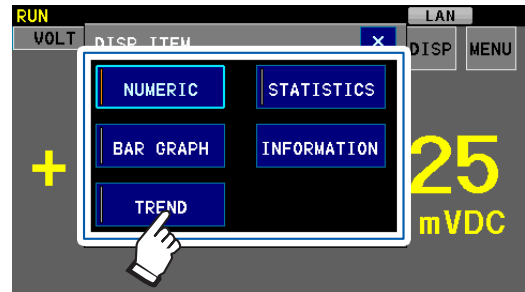

<b>NUMERIC</b>	Measured values only (When measured value judgment is enabled, measured values and judgment results will be displayed. See the following page for more information.)
<b>BAR GRAPH</b>	Bar graph display
<b>TREND</b>	Trend display (p.45)
<b>STATISTICS</b>	Statistics display (p.84)
<b>INFORMATION</b>	List of current settings

3

Measurement

- The trend display consists of the contents of the instrument's internal memory (up to 5000 values). Once the internal memory becomes full, data will be erased starting with the oldest values and replaced with the most recent values (the memory behaves like a ring buffer). See "Storage of measurement data in the instrument's internal memory" (p.42)
- You can check current settings by touching **INFORMATION**.

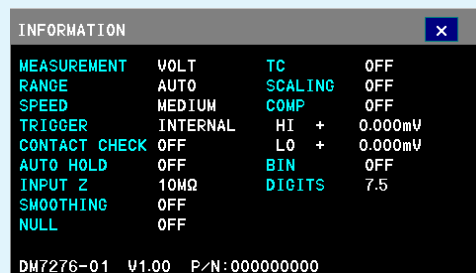

### When comparator measurement or BIN measurement is set to ON

When comparator measurement (p.53) or BIN measurement (p.57) is set to **ON**, the judgment results and sub-display are displayed automatically.

You can display the Settings screen by touching **SET** on the sub-display.

**Example: Displaying the Settings screen for comparator measurement**

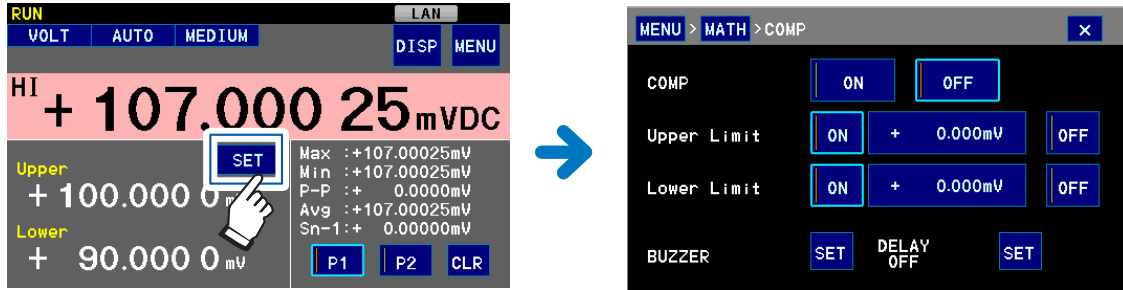

The screen display varies with the combination of comparator measurement and BIN measurement.

	Comparator OFF, BIN OFF	Comparator ON, BIN OFF	Comparator OFF, BIN ON
NUMERIC Normal display			
BAR GRAPH Bar graph display			
TREND Trend display			
STATISTICS Statistics display			

## Checking the voltage trend

The trend display (p.43) allows you to check up to 5000 data values stored in the instrument's internal memory as a graph.

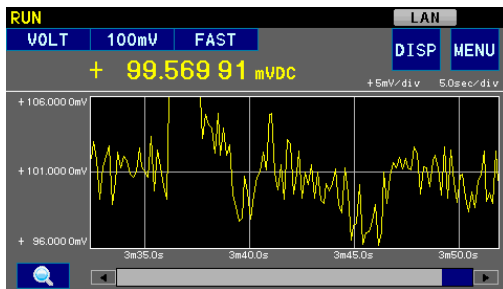

## Enlarging the waveform, adjusting the display position, and changing the time axis

Touch the magnifying glass icon to change the display.

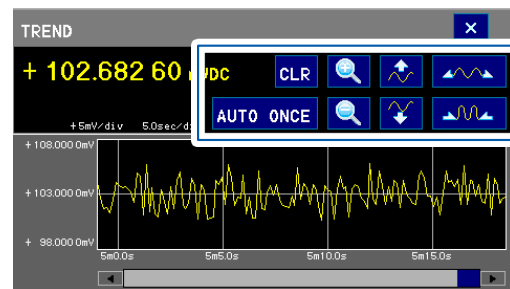
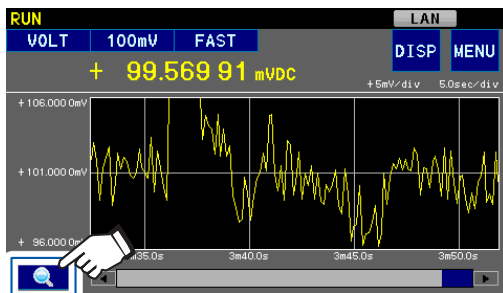

<b>CLR</b>	Clear the measured data.
<b>AUTO ONCE</b>	Sets the voltage axis to the optimal value based on the currently displayed waveform (performed once when the key is touched).
<b>+</b>	Enlarges the waveform.
<b>-</b>	Shrinks the waveform.
<b>↑</b>	Moves the display position up.
<b>↓</b>	Moves the display position down.
<b>↔</b>	Expands the time axis interval.
<b>←→</b>	Shrinks the time axis interval.

## 3.5 Measurement Error Displays (Displays Other Than Measured Values)

The instrument will display a message on the screen if it is unable to complete measurement normally. For more information: “14.3 Error Displays” (p. 176), “14.1 Q&A (Frequently Asked Questions)” (p. 168)

Measurement error	Display	Description	Solution and additional information
Over-range	+OvrRng -OvrRng	<ul style="list-style-type: none"> <li>This message is displayed in the following circumstances:               <ol style="list-style-type: none"> <li>When the measurement range has been exceeded Example: When 13 V is measured while using the 10 V range</li> <li>When A/D converter input during measurement exceeds the range Example: When a 20 Vpk AC signal is input while using the 10 V range</li> </ol> </li> <li>The comparator judgment when <b>+OvrRng</b> or <b>-OvrRng</b> is displayed will be <b>Hi</b> or <b>Lo</b> (p.54).</li> <li>The instrument will indicate <b>OvrRng</b> if the temperature exceeds the measurement range during measurement.</li> </ul>	Change the measurement range. See “3.2 Setting the Measurement Range” (p.35).
Contact error	NoCntct	<ul style="list-style-type: none"> <li>When the contact check (p.71) is set to <b>ON</b>, the instrument automatically checks the connection between the HIGH and LOW terminals. In the event of poor contact, this error will be displayed, and the ERR signal will be output from the EXT I/O terminal.</li> <li>If the measurement target is conductive paint, conductive rubber, or a similar material, the high resistance value between the HIGH and LOW terminals will cause this error to be continuously displayed, preventing measurement.</li> <li>Comparator and BIN judgments cannot be generated while this error is being displayed.</li> </ul>	<ul style="list-style-type: none"> <li>Check the contact between the measurement target and the metal pins.</li> <li>Replace the measurement cable.</li> <li>Change the contact check thresholds.</li> <li>If you wish to disable display of contact errors, set the contact check to <b>OFF</b>. See “6.3 Contact Check” (p.71).</li> </ul>
No measurement	-----	<ul style="list-style-type: none"> <li>This message is displayed when no measurements have been made since changing the measurement conditions.</li> <li>Comparator and BIN judgments cannot be generated while this error is being displayed.</li> </ul>	
Temperature sensor not connected	---.°C	Temperature measurement cannot be performed because the temperature sensor is not connected.	It is not necessary to connect the temperature sensor if you are not measuring temperature or using the temperature compensation (TC) function. If you do not wish to display the temperature, change to the voltage display. See “Switching the measured value display” (p. 18).

## Measurement error detection order

Measurement errors are detected in the order shown in the diagram below. The first error that is detected will be displayed on the screen and output as a signal from the EXT I/O.

Order	Measurement error detection		Screen display	EXT I/O connector
1	Temperature compensation error	→ Yes	Err.TC	ERR signal output
	↓ No			
2	Display: Higher than upper limit	→ Yes	+OvrRng	HI signal output (When comparator is ON)
	↓ No			
3	Display: Lower than lower limit	→ Yes	-OvrRng	LO signal output (When comparator is ON)
	↓ No			
4	Contact error	→ Yes	NoCntct	ERR signal output
	↓ No			
5	No measurement data	→ Yes	-----	No output

3

Measurement

## 3.6 Changing the Number of Display Digits

You can change the number of digits that are displayed.

(Measurement screen) **MENU** > **MEAS** > **DIGITS**

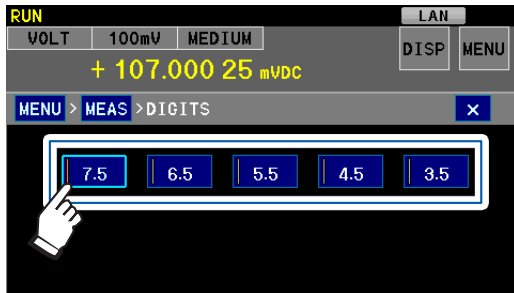

<b>7.5</b>	±12,000,000 dgt. (default setting)
------------	------------------------------------

<b>6.5</b>	±1,200,000 dgt.
------------	-----------------

<b>5.5</b>	±120,000 dgt.
------------	---------------

<b>4.5</b>	±12,000 dgt.
------------	--------------

<b>3.5</b>	±1,200 dgt.
------------	-------------

- When the number of display digits is decreased, digits that are not displayed are rounded off.
- Printed results are linked to the displayed digits.
- When the number of display digits is changed, only the displayed digits are used to generate comparator function and BIN function judgments. Digits that are not displayed are not used in making judgments.



## 3.7 Displaying Labels (Assigning Names to Measured Values)

You can assign user-specified strings to measured values by enabling the label display. This function provides a convenient way to indicate what each instrument is measuring when using multiple instruments.

(Measurement screen) **MENU > MEAS > LABEL**

1

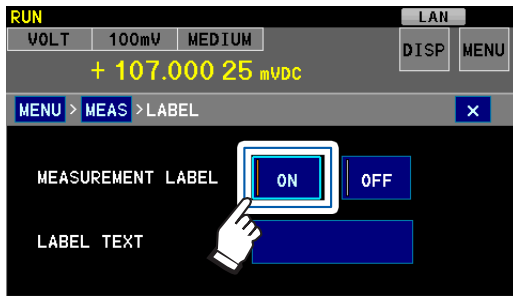

2

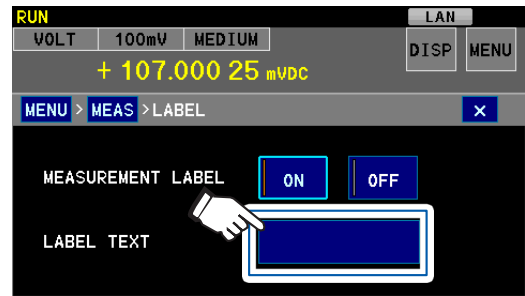

3

Measurement

3

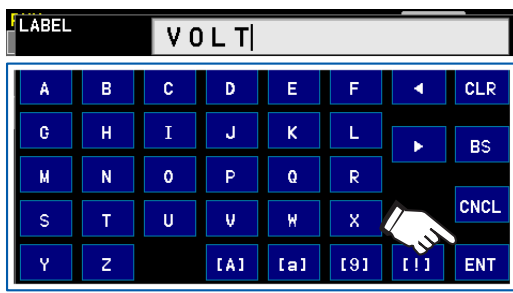

Enter text and touch **ENT**.

<b>CLR</b>	Deletes all entered text.
<b>BS</b>	Deletes the previous character.
<b>CNCL</b>	Cancels the setting and returns to the previous screen.
<b>&lt; &gt;</b>	Moves the cursor.
<b>[A]</b>	Switches to uppercase characters.
<b>[a]</b>	Switches to lowercase characters.
<b>[9]</b>	Switches to numerals.
<b>[!]</b>	Switches to symbols.

Up to eight characters may be entered.

Example label display

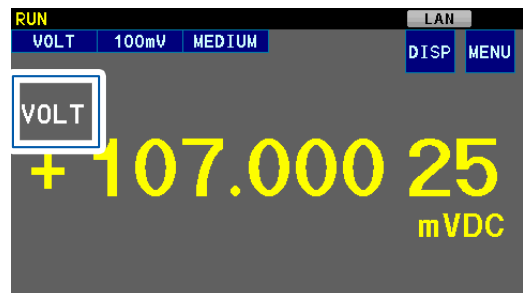

Labels cannot be displayed when the auto-hold function (p. 70) is enabled.



# 4

# Judging Measured Values

This chapter describes how to set judgment standards and perform comparator measurement (p.53) or BIN measurement (p.57). This functionality automatically compares measured values to the reference values and generates judgment results, making it convenient for tasks such as sorting (classifying) measurement targets or conducting shipping inspections.

Comparator measurement and BIN measurement provide the following capabilities:

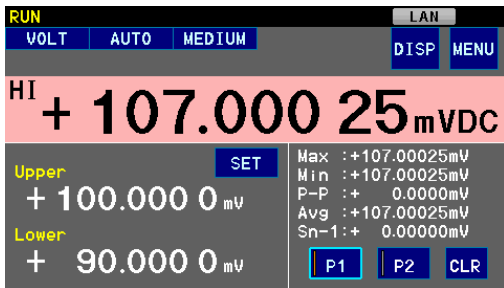
Displaying judgment results on the screen	Sounding the buzzer (comparator measurement only)
<p>“Displaying trends, bar graphs, statistics, and judgment results” (p.43)</p> 	<p>“To check judgments aurally” (p.55) (By default, the buzzer is disabled.)</p>
	Outputting judgment results
	<p>“9 Outputting Data” (p.111)</p>
	Enabling the absolute value judgment function
	<p>When measuring batteries, the sign of the voltage reading depends on the orientation of the battery’s electrodes. Consequently, it is necessary to repeat measurement when the battery’s orientation is changed.</p> <p>The DM7275/DM7276 provides an absolute value judgment function that, when enabled, makes it possible to perform comparator measurement or BIN measurement while ignoring the sign of measured values.</p> <p>See “4.1 To Obtain Accurate Judgments Even When the Polarity of the Measurement Target (Battery, etc.) Is Reversed” (p.52)</p>

# 4

Comparator measurement and BIN measurement use the same judgment method in which measured values are compared to previously set upper limit and lower limit values. It is also possible to set only an upper limit value or a lower limit value.

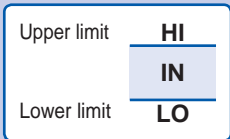
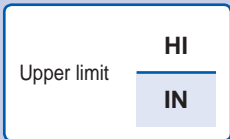
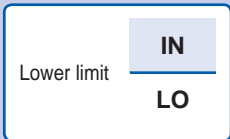
Upper limit and lower limit values	Upper limit value only	Lower limit value only
 <p>When (lower limit value ≤ measured value ≤ upper limit value), the instrument will generate an IN judgment.</p>	 <p>When (measured value ≤ upper limit value), the instrument will generate an IN judgment, including in the event of an over-range (-OvrRng).</p>	 <p>When (measured value ≥ lower limit value), the instrument will generate an IN judgment, including in the event of an over-range (+OvrRng).</p>

- Comparator measurement and BIN measurement cannot be performed simultaneously. When one is set to **ON**, the other will be automatically set to **OFF**.
- The lower limit value cannot be greater than the upper limit value. The instrument will display **ERR:001** if you attempt to set such a value.
- When both the upper limit value and lower limit value are set to **OFF**, IN judgment will be performed.

## 4.1 To Obtain Accurate Judgments Even When the Polarity of the Measurement Target (Battery, etc.) Is Reversed

By setting the absolute value judgment function to **ON**, voltage can be judged as a positive value even when it is negative.

(Measurement screen) **MENU > MATH > ABS MODE**

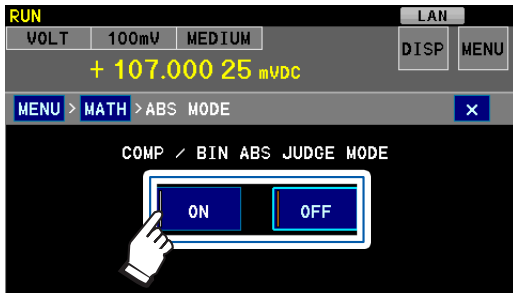

(Default setting: **OFF**)

**When the absolute value judgment function is enabled (example when both the upper limit and lower limit values are positive)**

### Upper limit and lower limit values

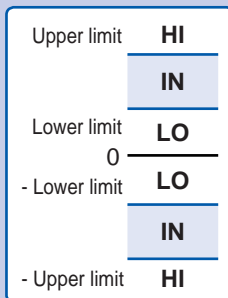

When (lower limit value  $\leq$  |measured value|  $\leq$  upper limit value), the instrument will generate an IN judgment.

### Upper limit value only

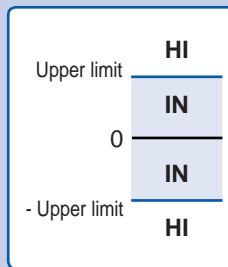

When (|measured value|  $\leq$  upper limit value), the instrument will generate an IN judgment.

### Lower limit value only

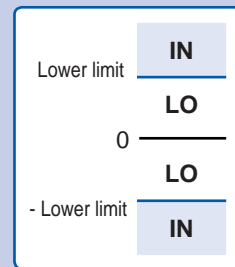

When (|measured value|  $\geq$  lower limit value), the instrument will generate an IN judgment, including in the event of an over-range (+OvrRng/-OvrRng) event.

## 4.2 Comparator Measurement (Using a Single Judgment Standard)

In comparator measurement, a pair of judgment standards (in the form of upper limit and lower limit values) is set. The instrument automatically compares measured values with the reference values and generates judgment results correspondingly. Judgment results of **HI** (larger than the upper limit value), **IN** (within the range defined by the upper limit and lower limit values), and **LO** (less than the lower limit value) can be displayed on the screen and output as a signal from the EXT I/O connector. This function can be used with both auto-range operation and fixed-range operation.

(Measurement screen) **MENU > MATH > COMP**

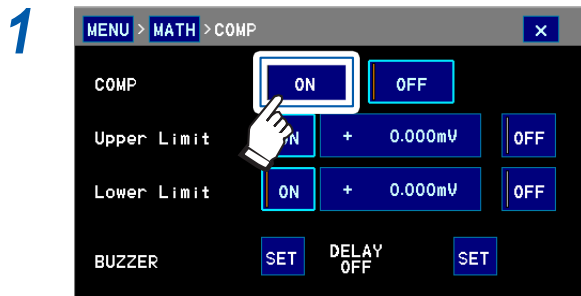

**1** Enable the comparator function.  
(Default setting: **OFF**)

When this function is set to **OFF**, upper limit and lower limit values are disabled even if they have been previously set.

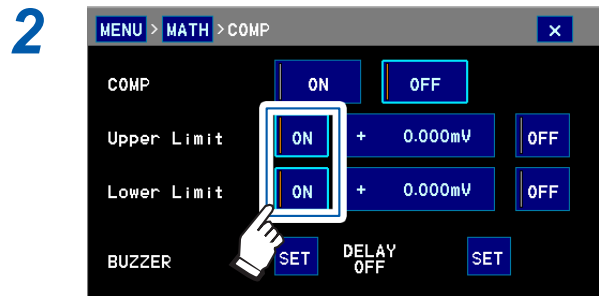

**2** Enable upper limit and lower limit values.  
(Default setting: **ON**)

When the upper limit and lower limit values are set to **OFF**, they are disabled even if they have been previously set.

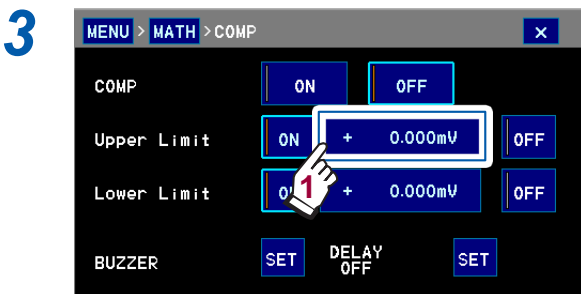

**3** Enter an upper limit value and touch **ENTER**.

<b>CLR</b>	Deletes the entire value.
<b>BS</b>	Deletes the previous character.
<b>CANCEL</b>	Cancels the setting and returns to the previous screen.

(Default setting: 0 V; valid setting range: -1000 V to 1000 V)

If the instrument is turned off before touching **ENTER**, the value being set will be lost, and the setting will revert to its previous value.

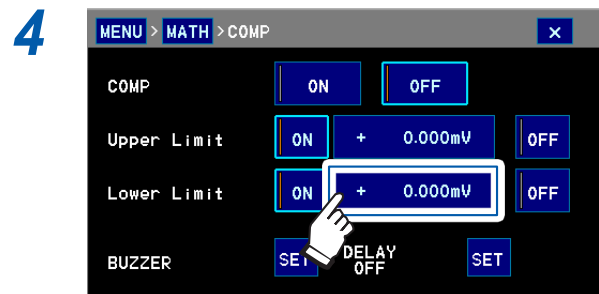

**4** Enter a lower limit value using the same method as for the upper limit value.  
(Default setting: 0 V; valid setting range: -1000 V to 1000 V)

4

Judging Measured Values

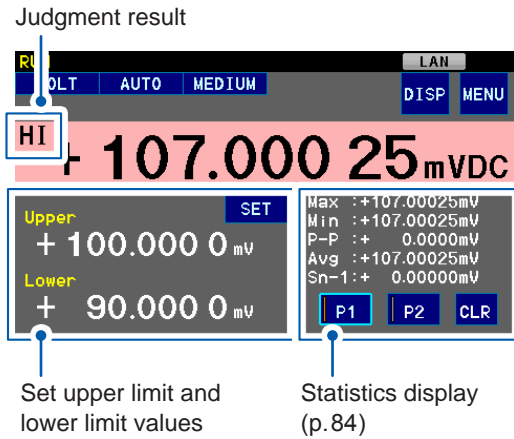

The judgment result and statistics sub-display are shown on the Measurement screen.

<b>P1, P2</b>	Toggles the statistics display.
<b>CLR</b>	Deletes the statistical calculation results.

Setting the comparator function to ON automatically sets the BIN function to OFF.

The following judgments may be shown when the instrument is not able to perform measurement normally:

Measured value display	Judgment
<b>+OvrRng</b>	<b>HI</b> (if only a lower limit value was set, <b>IN</b> )
<b>-OvrRng</b>	If the absolute value judgment function is disabled: <b>LO</b> (if only an upper limit value was set, <b>IN</b> ) If the absolute value judgment function is enabled: <b>HI</b> (if only a lower limit value was set, <b>IN</b> )
<b>NoCntct</b> or -----	-- (No judgment)

See "3.5 Measurement Error Displays (Displays Other Than Measured Values)" (p.46).

The Settings screen can be displayed from the Measurement screen's sub-display.

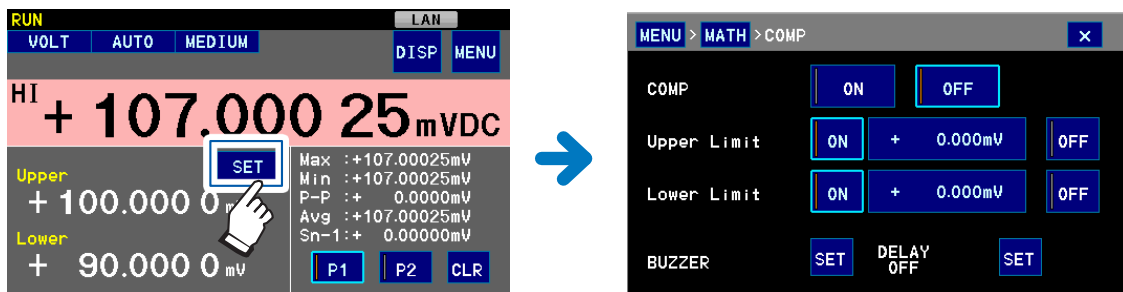

## To check judgments aurally

(Measurement screen) **MENU > MATH > COMP**

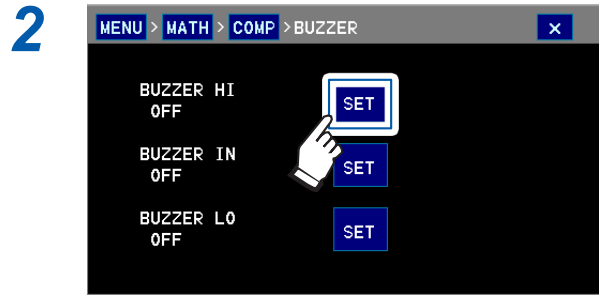
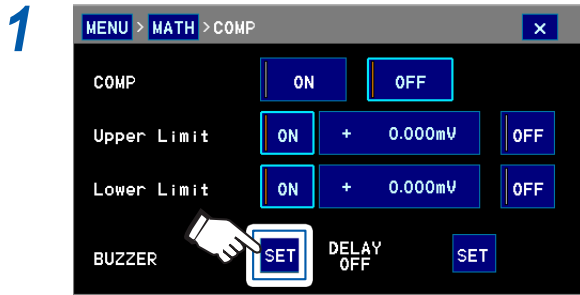

**BUZZER HI** Tone for HI judgments

**BUZZER IN** Tone for IN judgments

**BUZZER LO** Tone for LO judgments

Set the tone for each judgment and the number of tones to be sounded.

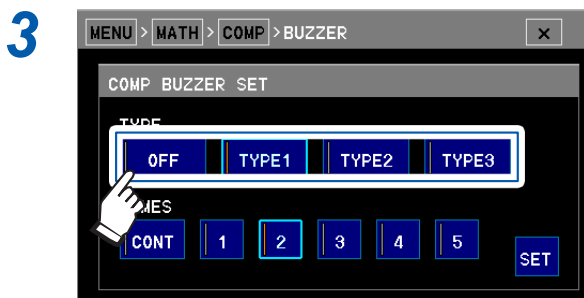

Select the type of judgment tone to use.  
(Default setting: **OFF**)

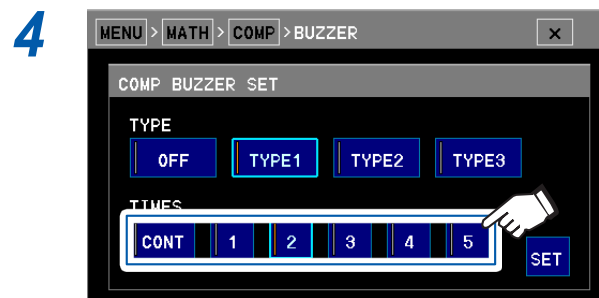

Select the number of times the selected tone should be sounded.

**CONT**: Continuous tone

(Default setting: 2)

When the contact check is set to **ON**, the buzzer will stop when the measurement cable is in the open state.

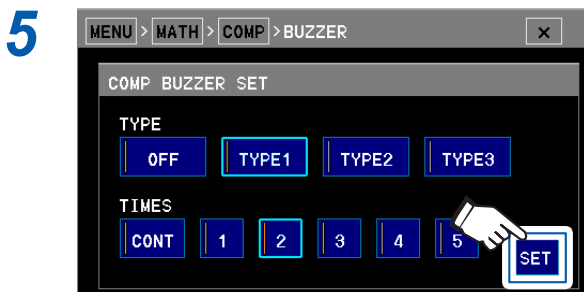

To change the buzzer volume: See “7.2 Buzzer Settings” (p.88).

4

Judging Measured Values

## To perform judgment after measured values stabilize

Since measured values may exhibit instability immediately after the instrument is connected to the measurement target when performing measurement manually, readings may temporarily exceed the judgment range.

When judgment delay is enabled, the judgment will be output after the same judgment is obtained the set number of times.

(Measurement screen) **MENU > MATH > COMP**

1

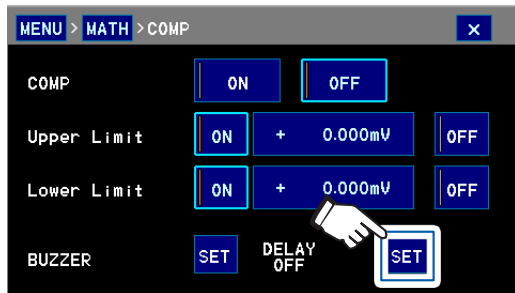

2

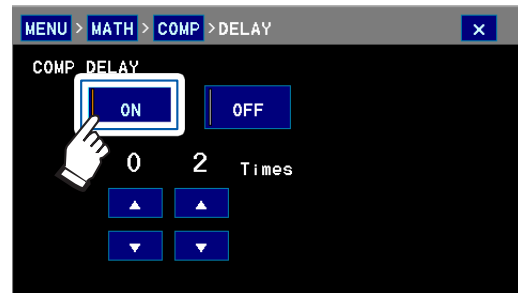

Enable the judgment delay.  
(Default setting: **OFF**)

3

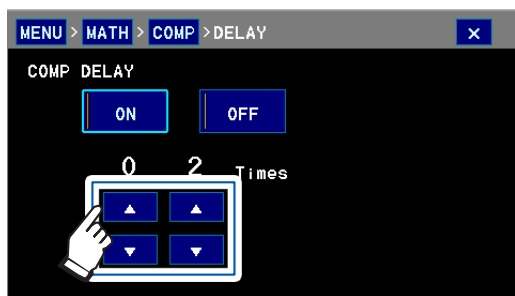

Select the desired number of judgment delays.  
(Default setting: 2)

## To output judgment results to an external device or to print judgment results

Set the comparator function to **ON**, configure external output (p. 111) or printing (p. 143), and prepare the associated equipment.



## 4.3 BIN Measurement (Using Multiple Judgment Standards)

In BIN measurement, multiple sets (up to 10, BIN0 to BIN9) of judgment standards (consisting of upper limit and lower limit values) are set. After each measurement, the instrument compares the measured value to multiple judgment standards and generates judgment results accordingly. This function provides a convenient way to group measurement targets into ranks.

The BIN number corresponding to the applicable judgment standard is displayed on the screen, and a signal can be output from the EXT I/O connector.

Measured values that do not fall under any BIN are indicated as **OB** (“out of bins”). This function can be used with both auto-range operation and fixed-range operation.

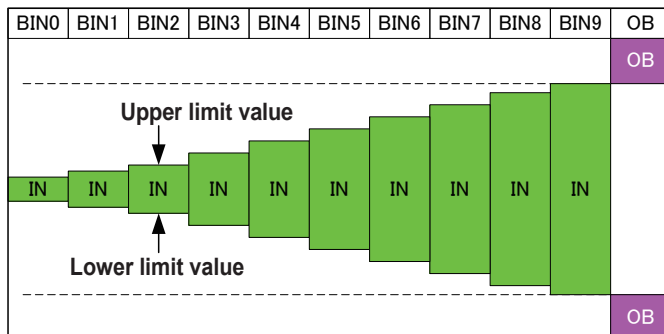
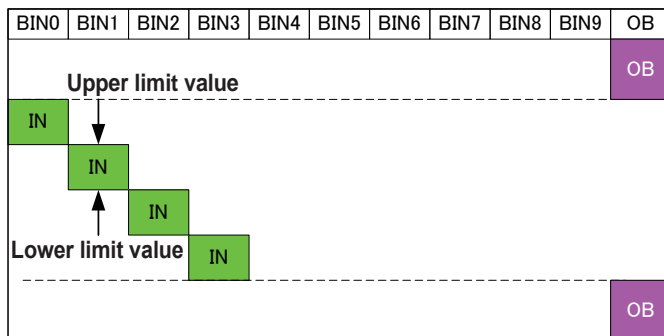

(Measurement screen) **MENU > MATH > BIN**

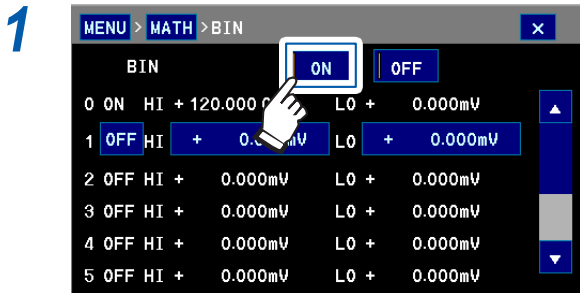

**Enable the BIN function.**

(Default setting: **OFF**)

When this function is set to **OFF**, upper limit and lower limit values are disabled even if they have been previously set.

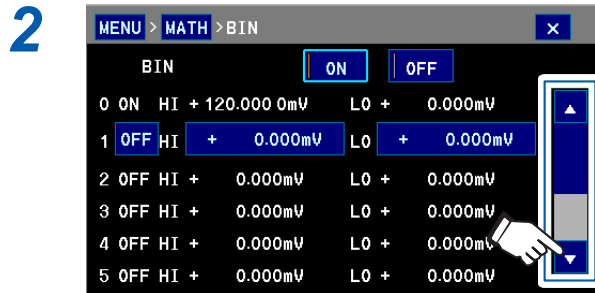

**Select a BIN number.**

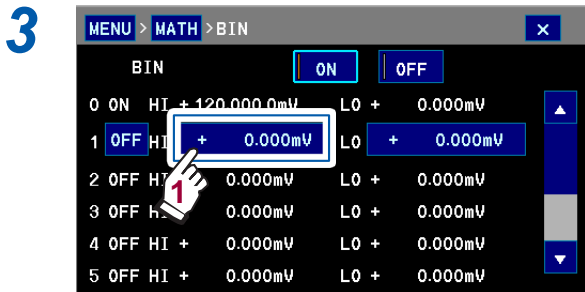

**Enter an upper limit value and touch ENTER.**

<b>CLR</b>	Deletes the entire value.
<b>BS</b>	Deletes the previous character.
<b>CANCEL</b>	Cancels the setting and returns to the previous screen.

(Default setting: 0 V; valid setting range: -1000 V to 1000 V)

If the instrument is turned off before touching **ENTER**, the value being set will be lost, and the setting will revert to its previous value.

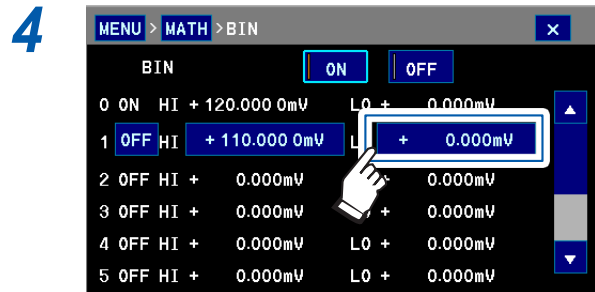

**Enter a lower limit value using the same method as for the upper limit value.**

(Default setting: 0 V; valid setting range: -1000 V to 1000 V)

5

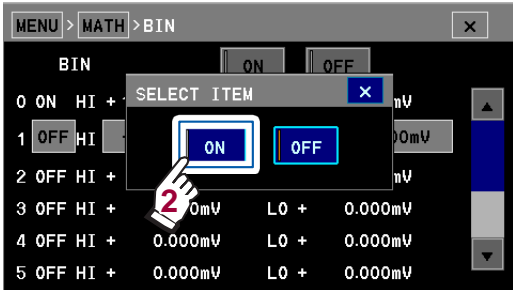
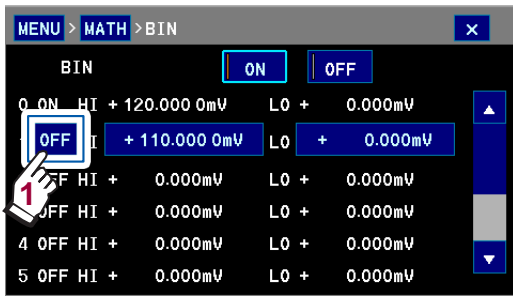

Enable the BIN number setting.

When the BIN number is set to **OFF**, upper limit and lower limit values are disabled even if they have been previously set.

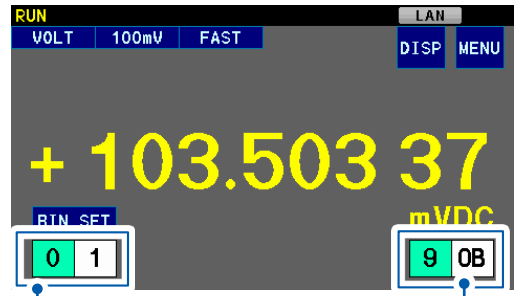

Judgment result

Set BIN number  
Green: Judgment complete  
White: Judgment in progress  
(BIN numbers set to OFF are not displayed.)

The judgment result and sub-display are shown on the Measurement screen.

Setting the BIN function to ON automatically sets the comparator function to OFF.

4

Judging Measured Values

The following judgments may be shown when the instrument is not able to perform measurement normally:

Measured value display	BIN judgment
+OvrRng	OB (out of range)
-OvrRng	OB (out of range)
NoCntct or -----	-- (No judgment)

See “3.5 Measurement Error Displays (Displays Other Than Measured Values)” (p.46).

The Settings screen can be displayed from the Measurement screen’s sub-display.

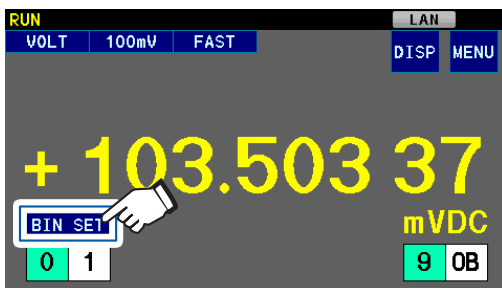

To check judgments aurally

Judgment tones do not sound during BIN measurement.

To output judgment results to an external device or to print judgment results

Set the BIN function to **ON**, configure external output (p.111) or printing (p.143), and prepare the associated equipment.



# Saving and Loading Measurement Conditions (Internal Memory)

The current measurement conditions can be saved to the instrument's internal memory (via the panel save function) and loaded from the instrument's internal memory (via the panel load function) as follows:

- By means of touch panel operation
- By sending communications commands from an external device
- By sending signals from an external device

A maximum of 30 panels (with panel numbers 01 through 30) can be saved. Panel data is maintained even when the instrument is turned off.

Measurement conditions can also be saved on a USB flash drive. See "10 Outputting and Loading Measurement Conditions (USB Flash Drive)" (p. 120).

## Information that can be saved with the panel save function

Save time and date	Measured value display	Range selection	Input resistance selection
Number of display digits	Integration time	Smoothing	Trigger settings (measurement count and delay)
NULL	Temperature compensation	Scaling	Contact check
Comparator	BIN	Absolute value judgment	Auto-hold
Label display	Sub-display		

## 5.1 Saving Measurement Conditions (Panel Save Function)

The panel save function saves the current measurement conditions in the instrument's internal non-volatile memory. You can select whether to save NULL values.

(Measurement screen) **MENU > PANEL**

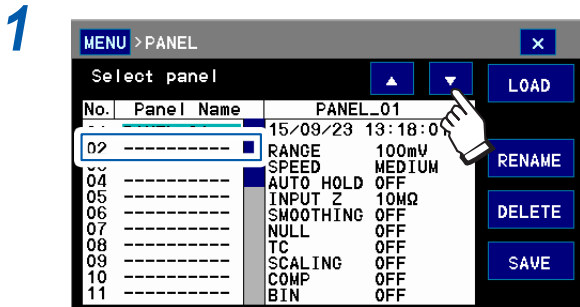

Select a panel number.

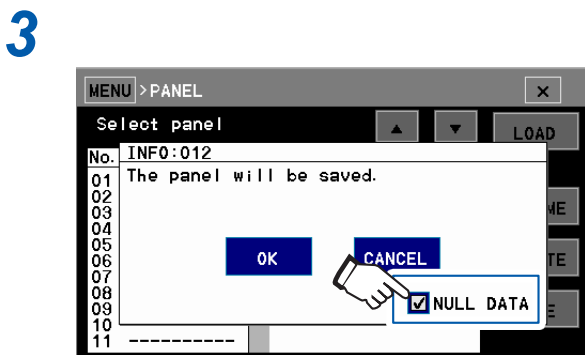
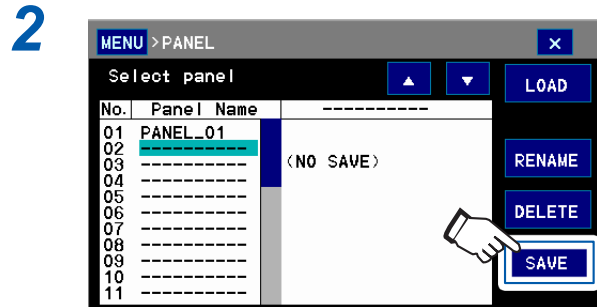

Select whether to save NULL values.

<b>Checked</b>	Saves NULL values.
<b>Not checked</b>	Does not save NULL values.

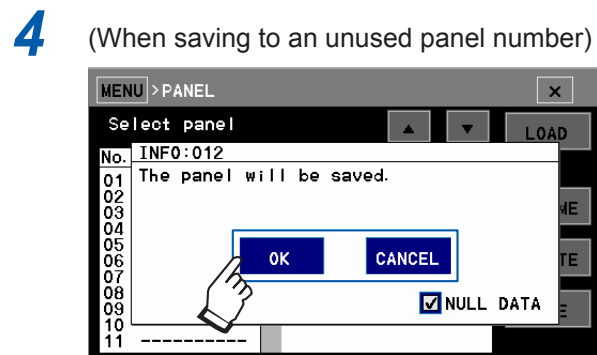

If you chose **OK** ⇒ Proceed to Step 5.

(When saving to a panel number that has already been used)

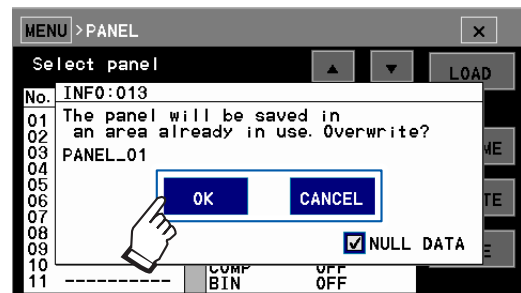

Touch **OK** to overwrite the previously saved data with the current measurement conditions.

## 5 (When saving to an unused panel number)

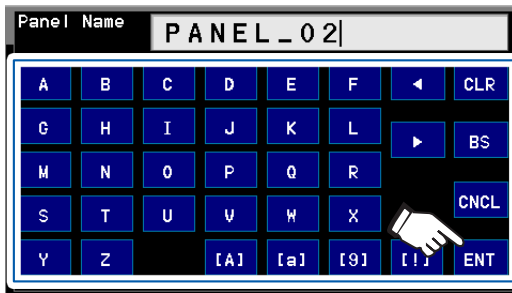

Enter the desired text and touch **ENT**.

Up to 10 characters may be entered.

The current measurement conditions will be saved as panel data.

<b>CLR</b>	Deletes all characters.
<b>BS</b>	Deletes the previous character.
<b>CNCL</b>	Cancels the setting and returns to the previous screen.
<b>&lt;&gt;</b>	Moves the cursor.
<b>[A]</b>	Switches to uppercase characters.
<b>[a]</b>	Switches to lowercase characters.
<b>[9]</b>	Switches to numerals.
<b>[!]</b>	Switches to symbols.

## 5.2 Loading Measurement Conditions (Panel Load Function)

The panel load function loads panel data that was previously saved in the instrument's internal memory.

Panel data can be loaded as follows:

- By means of touch panel operation
- By sending communications commands from an external device  
(See the Communication Command Instruction Manual on the included application disk.)
- By sending signals from an external device  
See "11 External Control (EXT I/O)" (p.125), "8 Preparing to Use USB, RS-232C, GP-IB, and LAN Control" (p.97)

This section describes how to load panel data using the touch panel.

(Measurement screen) **MENU > PANEL**

1

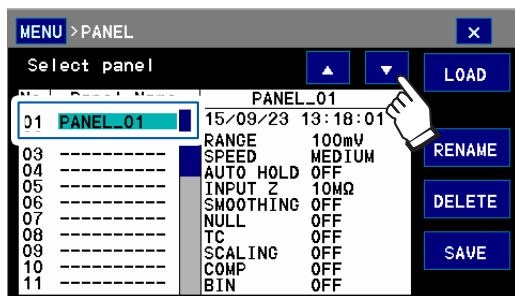

Select the panel data to load.

2

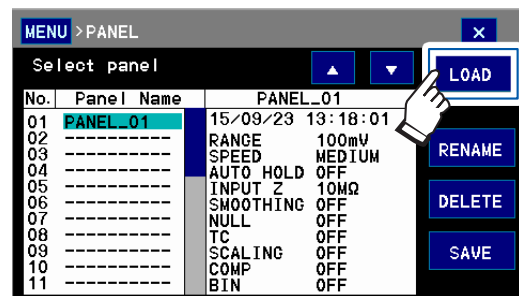

3

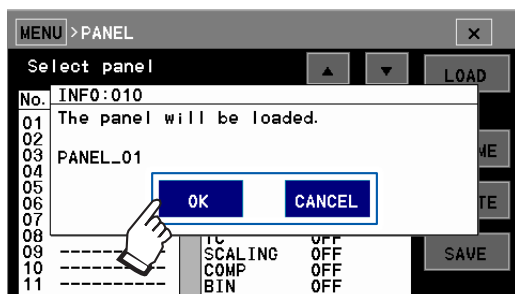

Touch **OK** to replace the current settings with the settings in the loaded panel data.



# 5.3 Changing the Panel Name

(Measurement screen) **MENU > PANEL**

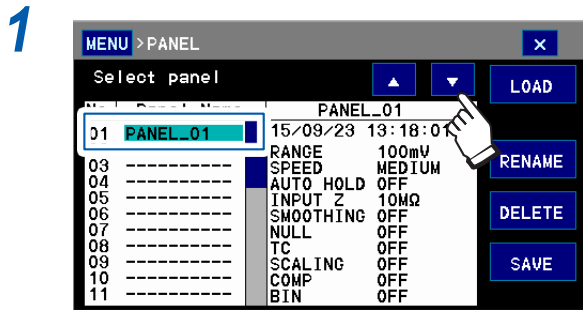

Select the panel data whose name you wish to change.

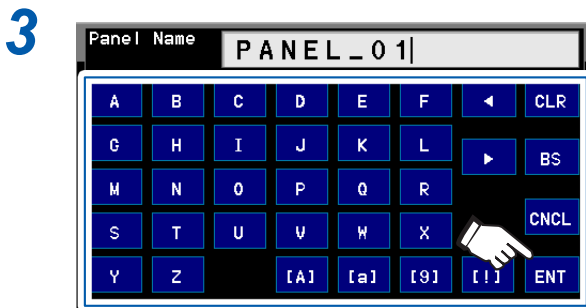
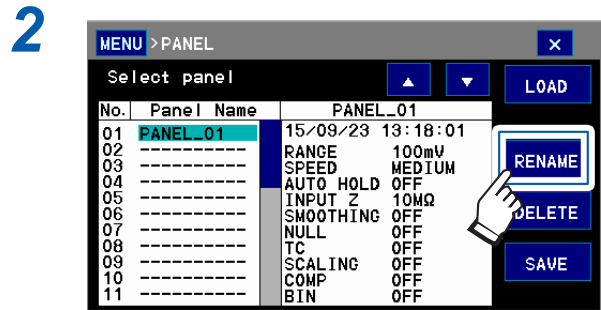

Enter the desired text and touch **ENT**.  
Up to 10 characters may be entered.

<b>CLR</b>	Deletes all characters.
<b>BS</b>	Deletes the previous character.
<b>CNCL</b>	Cancels the setting and returns to the previous screen.
<b>&lt;&gt;</b>	Moves the cursor.
<b>[A]</b>	Switches to uppercase characters.
<b>[a]</b>	Switches to lowercase characters.
<b>[9]</b>	Switches to numerals.
<b>[!]</b>	Switches to symbols.

**5**

Saving and Loading Measurement Conditions (Internal Memory)

## 5.4 Deleting a Panel

(Measurement screen) MENU > PANEL

1

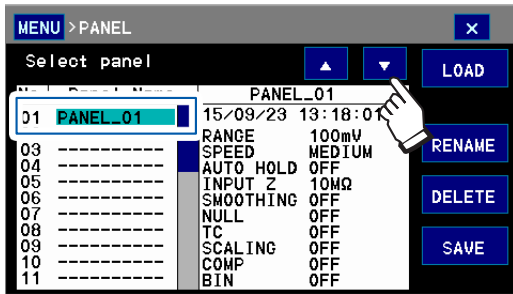

2

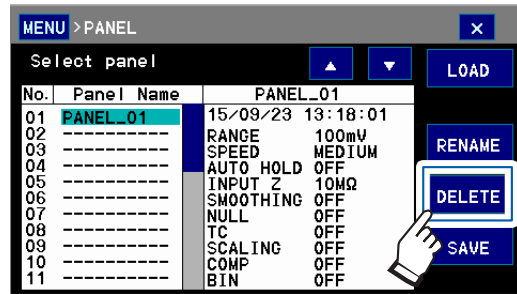

Select the panel data you wish to delete.

3

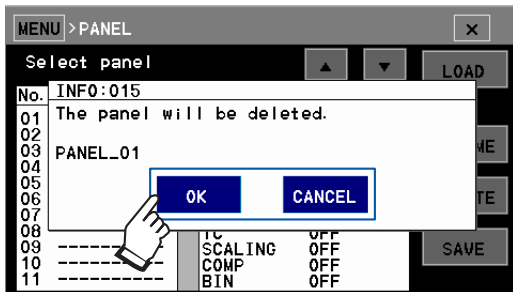

Touch **OK** to delete the selected panel data.

# 6

# Useful Functionality

## 6.1 Obtaining Stable Measured Values

### Setting the integration time

Readings for the measurement signal input to the instrument are averaged over the set time and displayed as measured values. The time over which the signal is averaged is known as the integration time and can be set as desired. In general, longer integration times yield more stable measured values.

Preset integration times have been assigned to the **FAST**, **MEDIUM**, and **SLOW** measurement speeds.

Unit	Setting	Integration time	Measurement speed	Measurement precision (Effect of external environment)
PLC	0.02 PLC	0.02 PLC*	Fast ↕ Slow	Low (More susceptible to effects) ↕ High (Less susceptible to effects)
	0.2 PLC	0.2 PLC		
	1 PLC (FAST)	1 PLC		
	10 PLC (MEDIUM)	10 PLC		
	100 PLC (SLOW)	100 PLC		
ms	1 ms to 9999 ms	As set	As set	As set

\* "PLC" stands for power line cycle, where 1 PLC is equivalent to the duration of one cycle of the power being supplied to the instrument. In areas with 50 Hz power, 1 PLC = 1/50 = 20 ms, while in areas with 60 Hz power, 1 PLC = 1/60 = 16.7 ms.

The unit in which the integration time is set can be switched between milliseconds and power line cycles.

This function is useful when the DC voltage you are measuring has superposed AC noise. You can improve the stability of measured values by setting the integration time to a whole multiple of the noise period.

Example: For a noise frequency of 40 Hz  
 Noise period = 1/40 = 25 ms  
 → Set the integration time to 25 ms, 50 ms, 75 ms, etc.

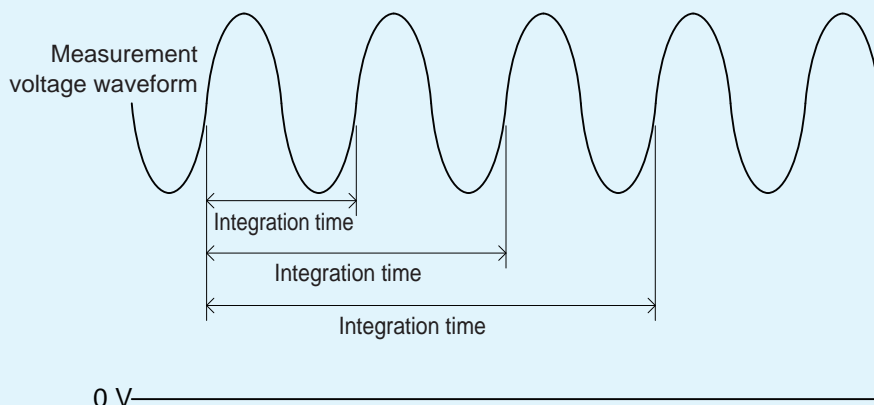

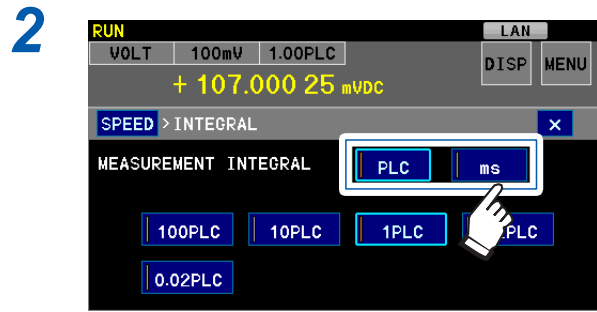
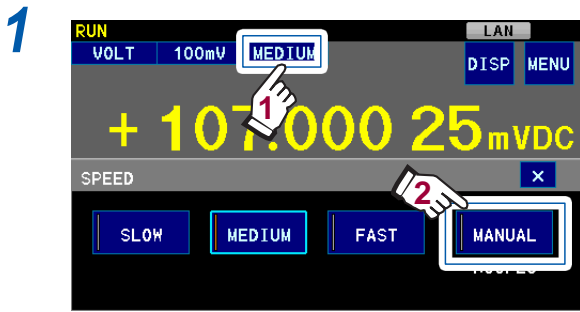

Select the unit.

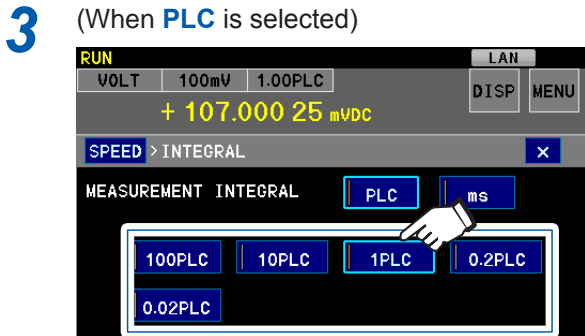

Select the integration time.  
(100 PLC, 10 PLC, 1 PLC, 0.2 PLC, 0.02 PLC)

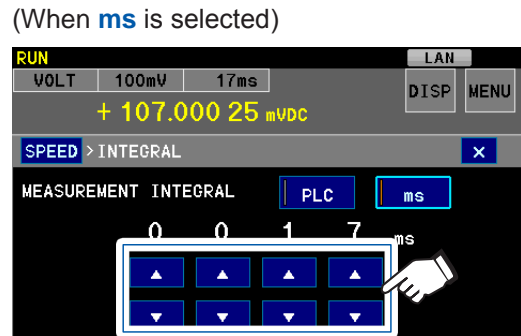

Select the integration time.

- ▲ Increases the value by 1.
- ▼ Decreases the value by 1.

(Valid setting range: 1 ms to 9999 ms)

- If the instrument is susceptible to the effects of the external environment: See “Appx. 4 Noise Countermeasures” (p.Appx.8).
- When the integration time is set to 0.02 PLC, an integration time of 0.4 ms will be used regardless of the power supply frequency.
- Even when a longer integration time is used, fluctuations on the order of several microvolts may be observed due to fluctuations in thermal electromotive force and the effects of burst noise. See “Appx. 3 Causes of Error in Voltage Measurement” (p.Appx.5)

## Reducing measured value variability (smoothing function)

This function averages multiple measured values to reduce measured value variability. It can only be enabled while the instrument is in the **RUN** state (p.37).

To reduce variability in a state other than the **RUN** state, adjust the integration time.

The smoothing function averages the most recent measured value the set number of times and displays the result (using a moving average). When the smoothing function is enabled, the display refresh speed does not change, but the response time increases.

Example: Display values (D1 to D4: measured values) when the smoothing count is set to 3

Measurement count	First measurement	Second measurement	Third measurement	Fourth measurement
Display value	D1	$(D1 + D2) / 2$	$(D1 + D2 + D3) / 3$	$(D2 + D3 + D4) / 3$

(Measurement screen) **MENU > MEAS > SMOOTHING**

1

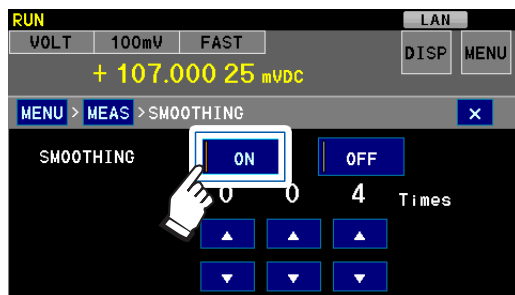

Enable the smoothing function.  
(Default setting: **OFF**)

2

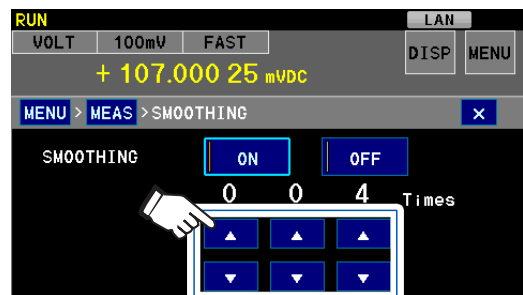

Set the smoothing count.

▲ Increases the value by 1.

▼ Decreases the value by 1.

(Valid setting range: 2 to 100; default setting: 4)

### Important

The smoothing memory is automatically erased at the following times:

- When the smoothing, temperature compensation, scaling, NULL, or trigger source setting is changed
- When the instrument is reset
- When the panel load function is used
- When a measurement error occurs
- When the instrument is turned off
- When the range is changed

## 6.2 Auto-hold Function

The auto-hold function is useful when you wish to check the measured value. The buzzer will sound once the measured value has stabilized (when the fluctuations in the measured value fall within the auto-hold range), and the display will be automatically held. The auto-hold range is specified as a percentage of the measurement range. Increasing the auto-hold range causes values to be held more quickly, while decreasing it takes more time but causes values to be held in a more stable state.

(Measurement screen) **MENU > MEAS > AUTO HOLD**

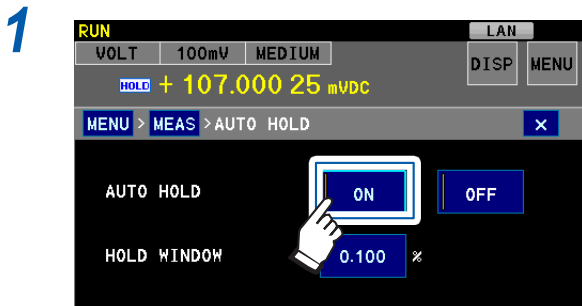

**Enable the auto-hold function.**  
(Default setting: **OFF**)

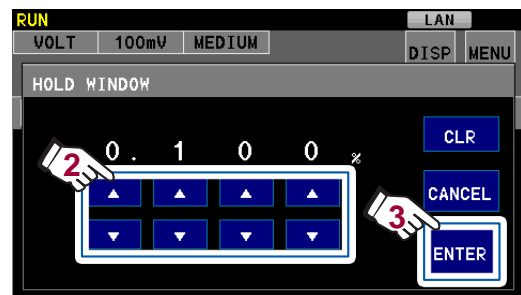
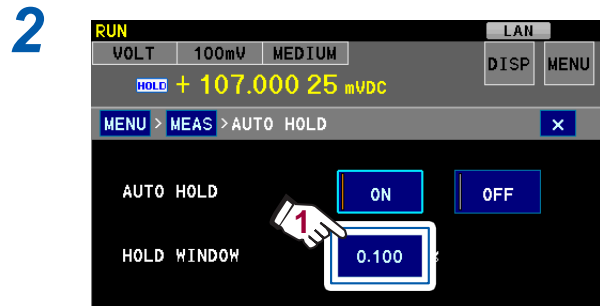

**Set the auto-hold range.**

<b>CLR</b>	Reverts the setting to its default value.
<b>CANCEL</b>	Cancels the setting and returns to the previous screen.

(Valid setting range: 0.001% to 1.000% of the range; default setting: 0.1%)

The **HOLD** icon will be displayed on the Measurement screen while the measured value is being held automatically.

The current measured value is displayed in real time.

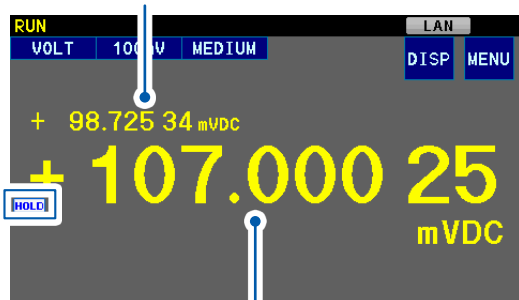

Measured value being automatically held

- When the auto-hold function is enabled, the measurement conditions change as follows: **RUN** state, **MEDIUM** integration time, **10 MΩ** input resistance, contact check **ON**.
- Measured values are not automatically held when they are 0.1% or less of the range. When measuring small values, select an appropriate range.

**The auto-hold state will be canceled in the following instances:**

- If the measurement cables are disconnected from the measurement target and then reconnected to the measurement target
- If the range or measurement speed (integration time) is changed

# 6.3 Contact Check

Enabling the contact check function lets you check the connection state between the HIGH and LOW terminals.

If the measurement cables become disconnected from the measurement target, the instrument will detect a contact error and display **NoCntct**. If the instrument displays **NoCntct**, check the contact state at the ends of the measurement cables and check for breaks in the cables.

Contact state	Good contact	Poor contact (indicated by broken red circle)
Measuring a battery's output voltage		
Measuring the potential across a battery's enclosure		
Instrument display	Measured value display 	NoCntct display 

The contact check function can be used with the 10 V range and lower ranges.

<b>Contact check can be enabled</b>	100 mV range, 1000 mV range, 10 V range
<b>Contact check cannot be enabled</b>	100 V range, 1000 V range

For more information: see "Contact check" in "Appx. 2 Measuring the Enclosure Potential of Laminated Lithium-ion Batteries" (p.Appx.2)

- Even if the contact check function is enabled, the instrument will display **OvrRng** without registering a contact error if its internal amplifier is in the over-range state, even if the measurement cable is unconnected. See "Measurement error detection order" (p.47) and "Appx. 1 Block Diagram" (p.Appx.1).
- For more information about contact check and delay timing, see "Trigger function settings" (p.39).

### Threshold

- The instrument's contact check threshold is specified as a capacitance value. It can be changed within the range of 0.5 nF to 50 nF (default setting: 1 nF).
- The following table provides approximate resistance value threshold equivalents for a number of contact check thresholds:

Threshold value setting	Resistance value threshold
0.5 nF	15 kΩ
5 nF	1.5 kΩ
50 nF	150 Ω

- If the capacitance between the HIGH and LOW terminals is less than the threshold value, the instrument will not display a measured value or perform judgment (contact error). Set a low threshold for small batteries and a high threshold for large batteries.
- The capacitance between the HIGH and LOW terminals can be monitored and used as a guideline when determining the threshold.

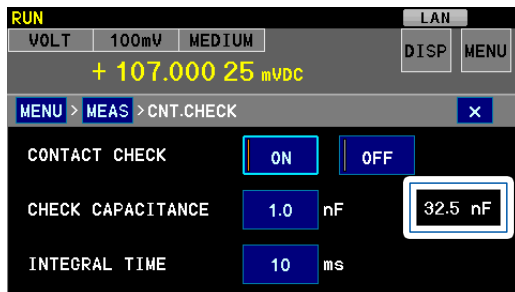

If the capacitance monitor value is the same as the contact check threshold, the instrument may either detect a contact error or display the measured value.

### Contact check integration time

The contact check integration time can be changed within the range of 1 ms to 100 ms (default setting: 10 ms). Use a low value when you wish to increase the measurement speed. Use a high value in environments with a large amount of noise.

- It is recommended to enable the contact check function when switching among multiple measurement targets at high speed as part of the measurement process and when measuring the potential across a battery's enclosure.
- Set an appropriate trigger delay (p. 39) when measuring the potential across a battery's enclosure. In particular, discharge time is required when the enclosure has been charged.



(Measurement screen) **MENU > MEAS > CNT.CHECK**

1

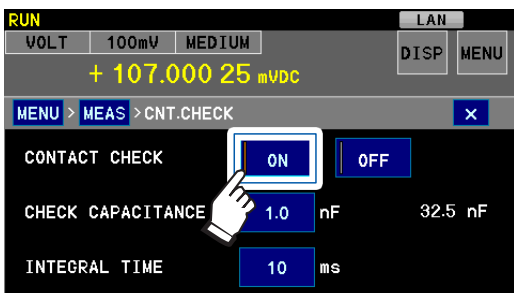

Enable the contact check function.  
(Default setting: **OFF**)

2

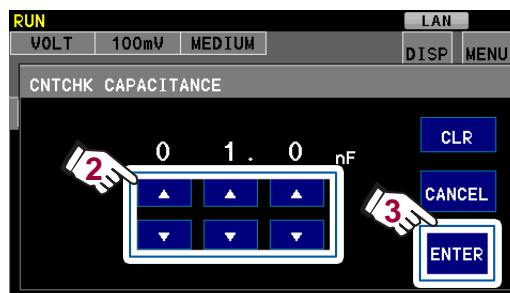
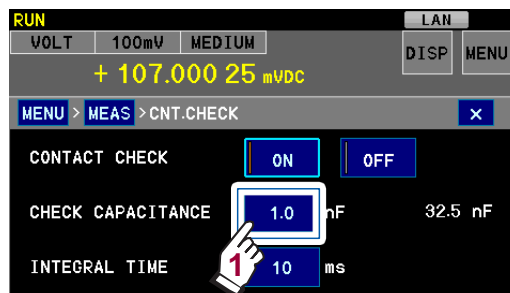

Set the threshold (capacitance).

- CLR** Reverts the setting to its default value.
- CANCEL** Cancels the setting and returns to the previous screen.

(Default setting: 1 nF; valid setting range: 0.5 nF to 50 nF)

3

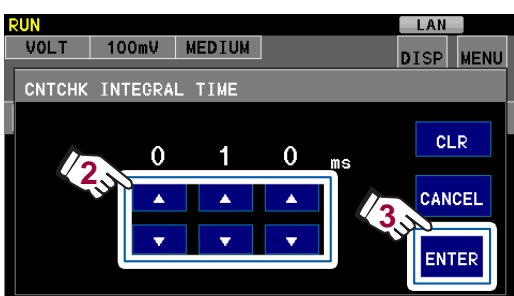
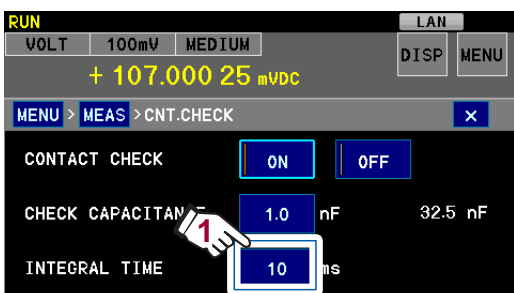

Set the contact check integration time.

- CLR** Reverts the setting to its default value.
- CANCEL** Cancels the setting and returns to the previous screen.

(Default setting: 10 ms)

6

Useful Functionality

### Contact check timing

Contact checks are performed before measurement starts. Enabling the contact check function causes the measurement time to increase. For more information: "11.6 Timing Chart" (p. 139)

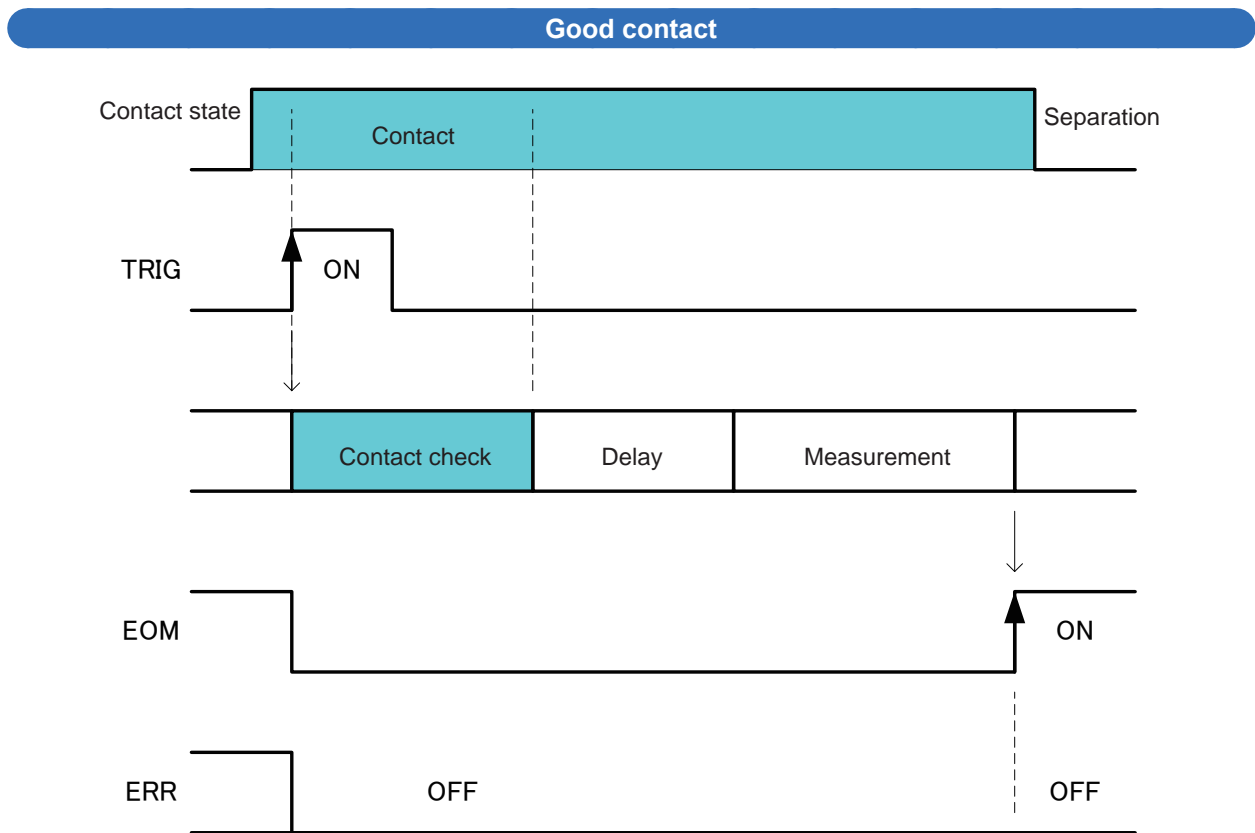

Poor contact

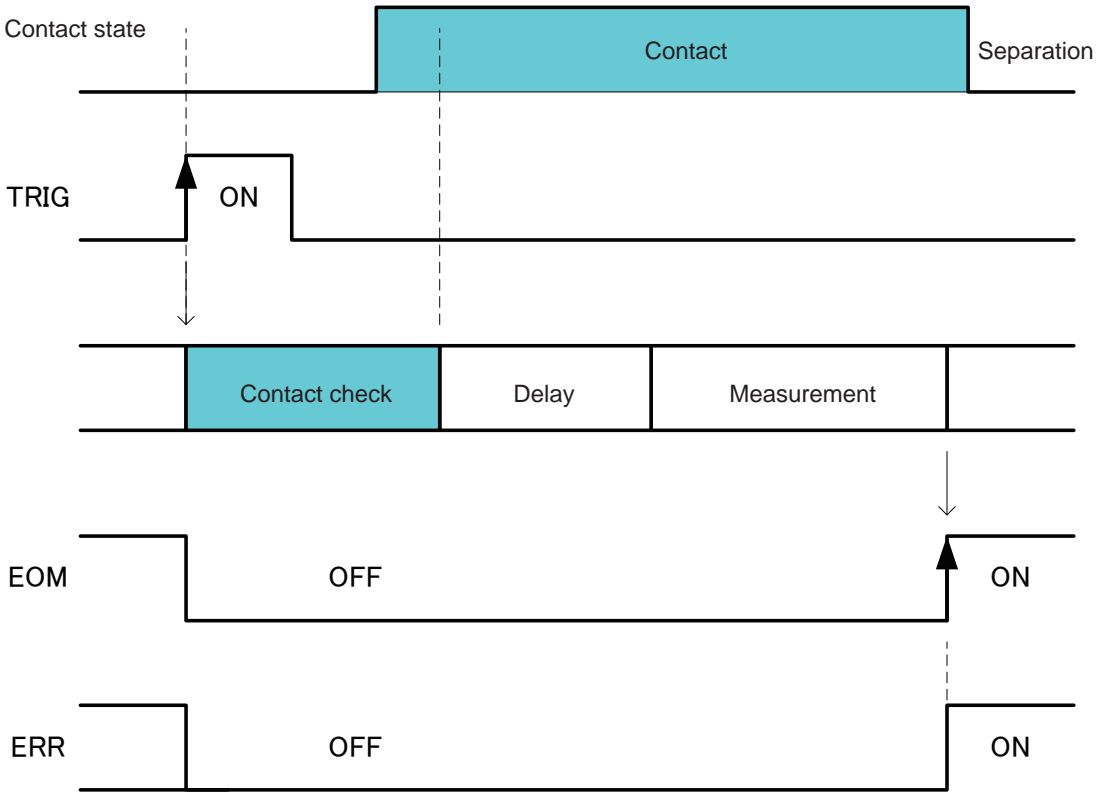

6

Useful Functionality

## 6.4 Switching the Input Resistance

The voltmeter's input resistance (internal resistance) can be switched.

(Measurement screen) **MENU > MEAS > INPUT Z**

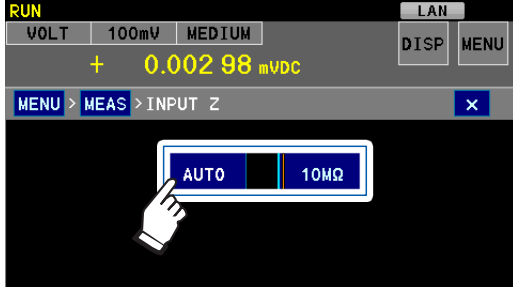

**AUTO** Auto mode

- 100 mV to 10 V range:  
10 GΩ or greater  
(Hi-Z will be displayed on the screen; see figure to right.)
- 100 V range and 1000 V range:  
10 MΩ

**10 MΩ** Fixed at 10 MΩ (default setting).

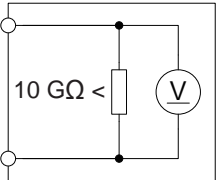
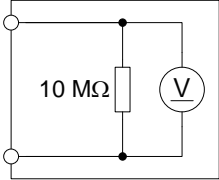
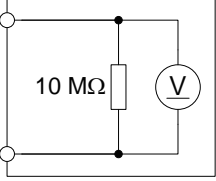
Measurement range	AUTO input resistance setting	10 MΩ input resistance setting
100 mV 1000 mV 10 V		
100 V 1000 V		

When the input resistance is set to 10 MΩ, measurement is more prone to the effects of the measurement target's output resistance (signal source resistance).

Example: a coin-shaped battery with an output resistance of 1 kΩ and an open voltage of 3 V when measured with the **10 MΩ** input resistance setting

$$\frac{10 \text{ M}\Omega}{10 \text{ M}\Omega + 1 \text{ k}\Omega} \times 3 = 2.9997 \text{ V}$$

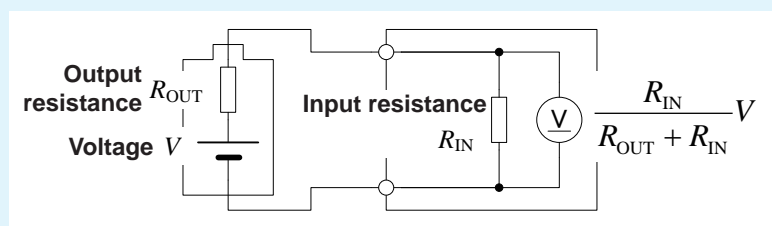

## 6.5 Correcting Measured Values

Measured values can be calculated using the zero-point adjustment function (NULL function), temperature compensation function, and scaling function.

Calculations are performed in the following order when these functions are enabled:

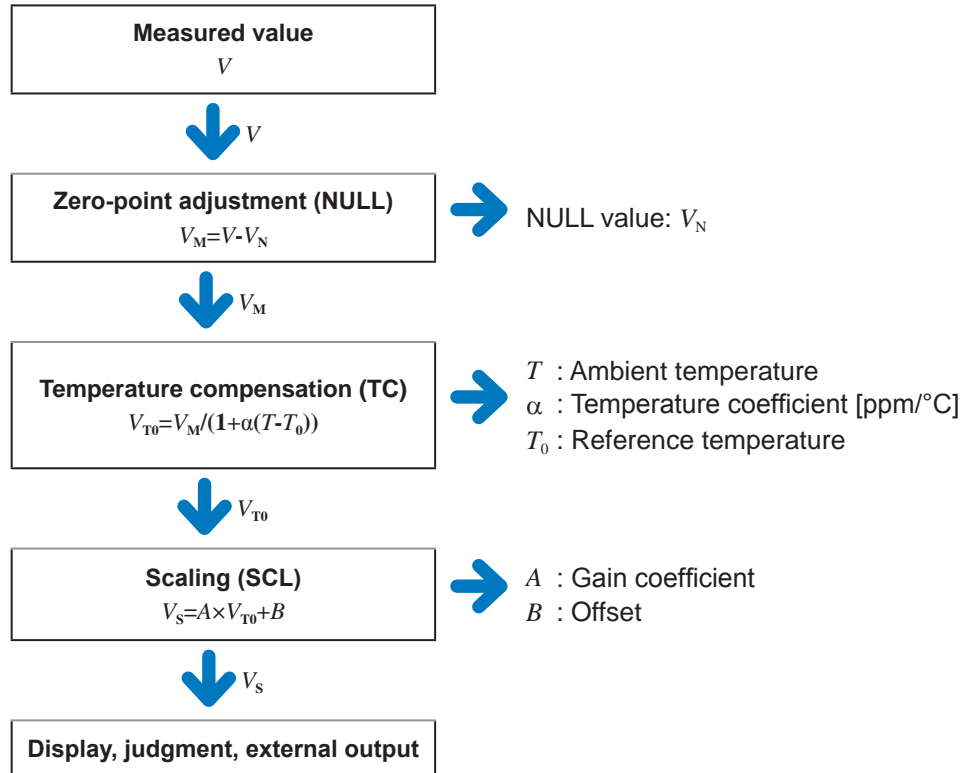

## Adjusting the zero-point (NULL function)

Pressing the **[NULL]** key causes the measured value that is currently displayed to be acquired as the NULL value ( $V_N$ ). Subsequently, the instrument will display the result of subtracting  $V_N$  from the measured value. You can also adjust the zero-point by setting a NULL value as desired.

### Adjusting the zero-point using the currently displayed measured value

**1** Press the **[NULL]** key.

**2**

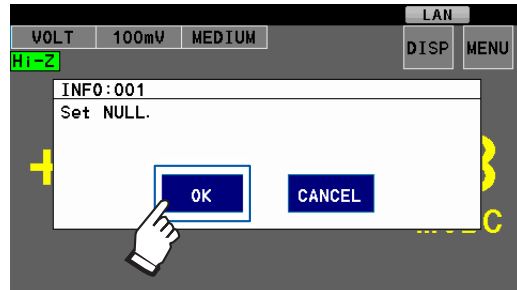

The zero-point will be adjusted.  
The **NULL** icon will be displayed on the Measurement screen.

Or

(Measurement screen) **MENU > MATH > NULL**

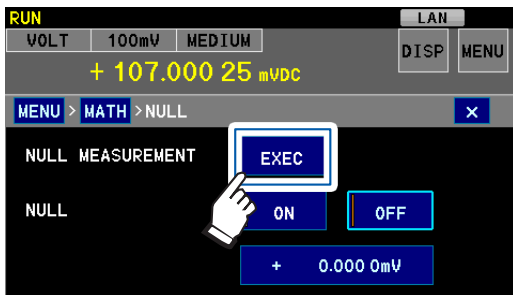

The zero-point will be adjusted.  
The **NULL** icon will be displayed on the Measurement screen.

Pressing the **[NULL]** key while the NULL function is in the ON state (while the **NULL** icon is being displayed) will disable the NULL function.

## Adjusting the zero-point using a user-set value

(Measurement screen) **MENU > MATH > NULL**

1

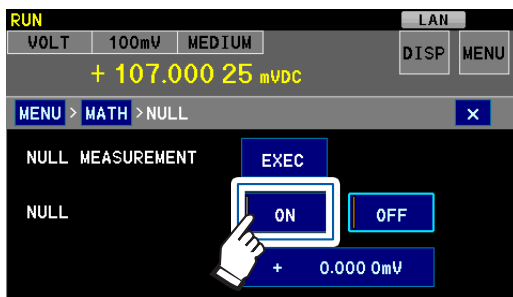

Enable the NULL function.

(Default setting: **OFF**)

2

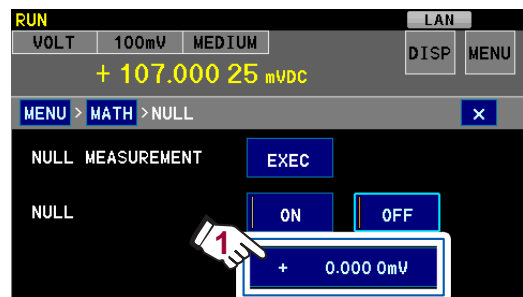

Enter a NULL value and touch **ENTER**.

<b>+/-</b>	Toggles between positive and negative values.
<b>CLR</b>	Deletes the entire value.
<b>BS</b>	Deletes the previous character.
<b>CANCEL</b>	Cancels the setting and returns to the previous screen.

(Default setting: 0 V; valid setting range: -1000 V to 1000 V)

The zero-point will be adjusted.

The **NULL** icon will be displayed on the Measurement screen.

Pressing the **[NULL]** key while the NULL function is in the ON state (while the **NULL** icon is being displayed) will disable the NULL function.

## Compensating the effects of temperature (temperature compensation function)

This function converts the voltage measured value to the voltage at a specific temperature (the reference temperature) using a user-defined temperature coefficient and displays the result. The temperature dependency of voltage varies greatly with the measurement target. Before using this function, measure the measurement target's temperature characteristics.

The voltage values  $V_T$  and  $V_{T_0}$  can be expressed as the voltage values of a measurement target at  $T^\circ\text{C}$  and  $T_0^\circ\text{C}$  (where the temperature coefficient at  $T_0^\circ\text{C}$  is  $\alpha_{T_0}$ ):

$V_{T_0} = \frac{V_T}{1 + \alpha_{T_0}(T - T_0)}$ <p> <math>V_T</math> : Observed voltage value [<math>\Omega</math>]  <math>T</math> : Current ambient temperature [<math>^\circ\text{C}</math>]  <math>V_{T_0}</math> : Voltage value after correction [<math>\Omega</math>]  <math>T_0</math> : Reference temperature [<math>^\circ\text{C}</math>]  <math>\alpha_{T_0}</math> : Temperature coefficient at <math>T_0</math> [<math>1/^\circ\text{C}</math>]                 </p>	
------------------------------------------------------------------------------------------------------------------------------------------------------------------------------------------------------------------------------------------------------------------------------------------------------------------------------------------------------------------------------------------------------------------------------------------------------------------------------------------------------	--

### Example:

Under the following conditions, the voltage value at  $20^\circ\text{C}$  is calculated as shown below:

- Current temperature:  $30^\circ\text{C}$
- Current battery voltage value (at  $30^\circ\text{C}$ ): 4 V
- Temperature coefficient at  $20^\circ\text{C}$ :  $100 \text{ ppm}/^\circ\text{C}$

$$\begin{aligned}
 V_{T_0} &= \frac{V_T}{1 + \alpha_{T_0}(T - T_0)} \\
 &= \frac{4}{1 + 100 \times 10^{-6} \times (30 - 20)} \\
 &= 3.996004
 \end{aligned}$$

- The temperature sensor only detects the ambient temperature. It cannot measure the measurement target's surface temperature.
- Allow the instrument to warm up adequately prior to measurement. Position the temperature sensor close to the measurement target and allow the temperature sensor and measurement target to adjust adequately to the ambient temperature before use.

(Measurement screen) **MENU > MATH > TC**

- 1 **Connect the Z2001 Temperature Sensor to the TEMP.SENSOR connector on the rear of the instrument (p.27).**

2

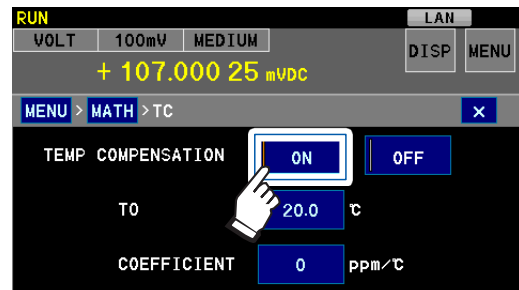

**Enable the temperature compensation function.**

(Default setting: **OFF**)



3

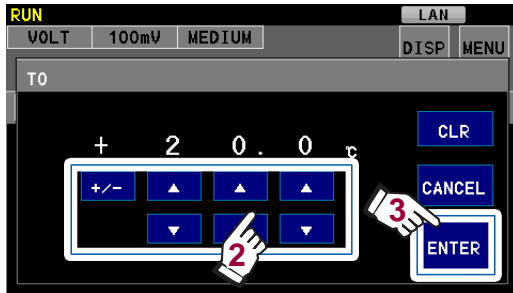
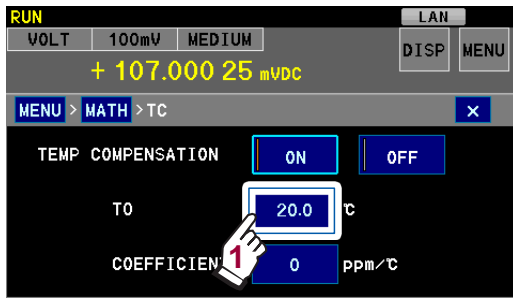

Set the reference temperature and touch **ENTER**.

(Default setting: 20°C; valid setting range: -10.0°C to 60°C)

4

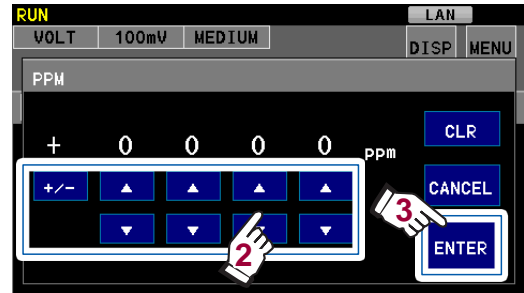
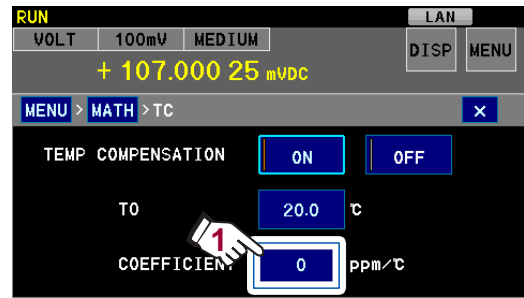

Set the temperature coefficient and touch **ENTER**.

(Default setting: 0 ppm/°C; valid setting range: -1000 V ppm/°C to 1000 ppm/°C)

<b>+/-</b>	Toggles between positive and negative values.
<b>^</b>	Increases the value by 1.
<b>v</b>	Decreases the value by 1.
<b>CLR</b>	Deletes the entire value.
<b>CANCEL</b>	Cancels the setting and returns to the previous screen.

The instrument's temperature compensation function corrects temperature by treating the temperature dependence of the measurement target as a linear function. The error will increase if the measurement target's temperature dependence diverges from that linear function. For example, if the temperature coefficient  $\alpha$  has been set so that the ambient temperature  $T_1$  is corrected to the reference temperature  $T_0$ , the error will increase if the ambient temperature changes to  $T_2$ . (See figure below.)

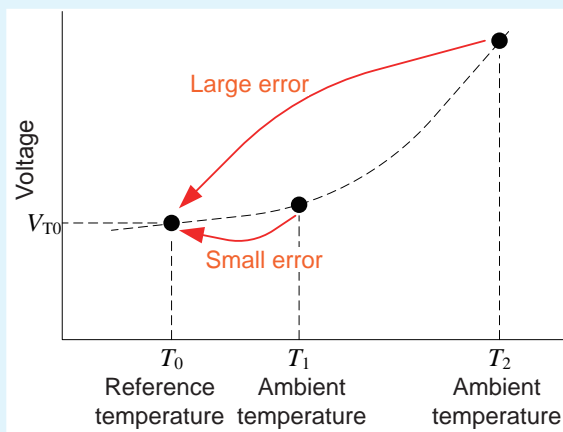

6

Useful Functionality

## Correcting measured values using a linear expression (scaling function)

This function corrects measured values using a linear function. Results are calculated as follows:  
 $V_S = A \times V_{T0} + B$  (where  $A$  is the gain coefficient,  $B$  is the offset,  $V_S$  is the value after scaling, and  $V_{T0}$  is the value after NULL calculation and temperature compensation).

In addition, you can convert measured values to other physical properties such as current or speed for display by changing the display unit to the desired string. This functionality is useful when correcting output from a current detection resistor (shunt resistor) or sensor.

(Measurement screen) **MENU > MATH > SCALING**

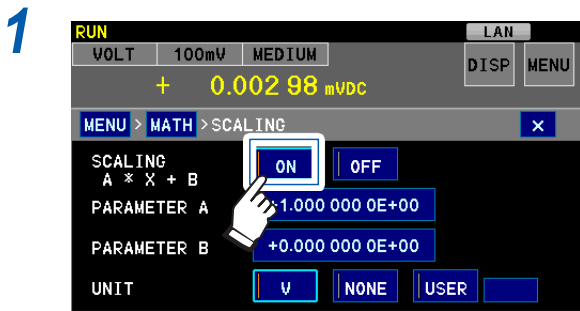

**Enable the scaling function.**  
 (Default setting: **OFF**)

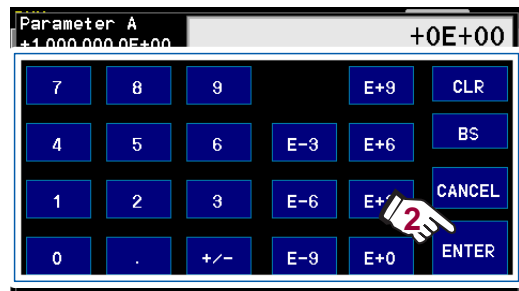
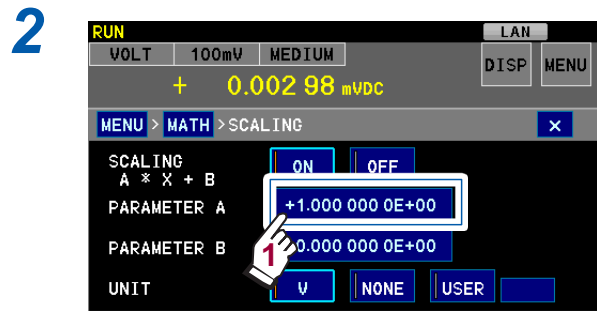

**Set the value of coefficient  $A$  and touch ENTER.**

**BS** Deletes the previous character.

**CLR** Deletes the entire value.

**CANCEL** Cancels the setting and returns to the previous screen.

(Default setting: 1)

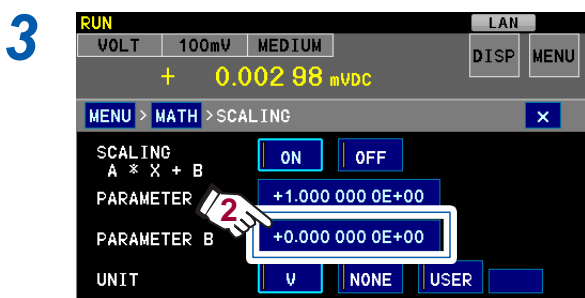

**Set the offset  $B$  value similarly.**  
 (Default setting: 0)

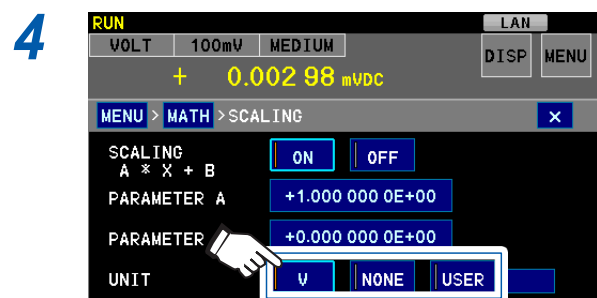

**Select the unit.**

**V** V (default setting)

**NONE** No unit

**USER** User-specified unit

**5** (When **USER** is selected)



Set the desired unit and touch **ENT**.

Up to three characters may be entered (not including SI prefixes\*).

<b>CLR</b>	Deletes the entire value.	<b>[A]</b>	Switches to uppercase characters.
<b>BS</b>	Deletes the previous character.	<b>[a]</b>	Switches to lowercase characters.
<b>CNCL</b>	Cancels the setting and returns to the previous screen.	<b>[9]</b>	Switches to numerals.
<b>&lt;&gt;</b>	Moves the cursor.	<b>[!]</b>	Switches to symbols.

\* The number of display digits will be adjusted so that the integer portion of the result of  $(A \times \text{pre-scaling maximum display} + |B|)$  is 2 to 4 digits long, and the SI prefix will be automatically added.

Example: For  $A = 1.5 \times 10^5$  and  $B = -0.5 \times 10^3$  in the 10 V range,

$$1.5 \times 10^5 \times 12 + 0.5 \times 10^3 = 1800500$$

Since adjusting the integer portion so that it is two to four digits long yields 1800.500k, the SI prefix "k" will be added.

## 6.6 Statistical Calculations

The instrument continually calculates statistics for a maximum of 1,000,000 measurement data points, and the results of those calculations can be displayed on the Measurement screen. (p.85)  
 In addition, the results can be printed. (p.143)

Statistical calculation stops once the number of data points reaches 1,000,000. It can be resumed by clearing the statistical calculation results.

### Definition of statistical calculations

The instrument calculates the average value, maximum value, difference between the maximum and minimum values, minimum value, population standard deviation, sample standard deviation, and process capability index.

Maximum value	$X \text{ max} = \text{MAX}(x_1, \dots, x_n)$
Minimum value	$X \text{ min} = \text{MIN}(x_1, \dots, x_n)$
Maximum value - Minimum value	$X \text{ max} - X \text{ min}$
Average value	$\bar{x} = \frac{\sum x}{n}$
Population standard deviation	$\sigma_n = \sqrt{\frac{\sum x^2 - n\bar{x}^2}{n}}$
Sample standard deviation	$\sigma_{n-1} = \sqrt{\frac{\sum x^2 - n\bar{x}^2}{n-1}}$
Process capability index* (variability)	$Cp = \frac{ UPP - LOW }{6\sigma_{n-1}}$
Process capability index* (bias)	$Cpk = \frac{ UPP - LOW  -  UPP + LOW - 2\bar{x} }{6\sigma_{n-1}}$

\* The process capability index expresses the ability of the process to achieve the target quality in terms of its quality variability and bias width. In general, process capability can be evaluated as indicated below based on the  $Cp$  and  $Cpk$  values:

Value	Process capability
$Cp$ and $Cpk > 1.33$	Adequate
$1.33 \geq Cp$ and $Cpk > 1.00$	Appropriate
$1.00 \geq Cp$ and $Cpk$	Inadequate

- “UPP” and “LOW” refer to the comparator’s upper limit and lower limit values.
- When the comparator function is set to **OFF**, the process capability index is not calculated.
- When the number of valid data points is 1, the sample standard deviation and process capability index will be displayed as 0.
- When  $\sigma_{n-1}$  is 0,  $Cp$  and  $Cpk$  will be 99.99.
- The upper limit for  $Cp$  and  $Cpk$  is 99.99. If either value is greater than 99.99, it will be displayed as 99.99.
- When  $Cpk$  is negative, it will be treated as 0.

## Displaying, clearing, and printing statistical calculation results

### DISP > STATISTICS

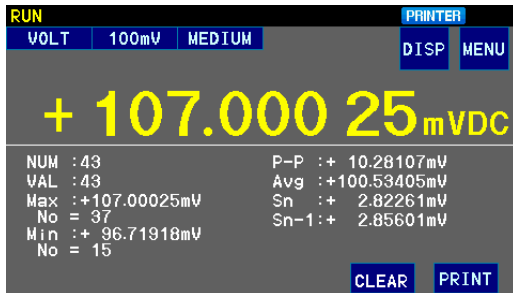

Example screen: When the BIN function and comparator function are set to **OFF** (The screen display varies with the BIN function and comparator function settings. (p.44))

**PAGE1** Displays PAGE1 (displayed only when the comparator function or BIN function is set to **ON**).

**PAGE2** Displays PAGE2 (displayed only when the comparator function or BIN function is set to **ON**).

**CLEAR** Clears the statistical calculation results.

**PRINT** Prints the statistical calculation results (displayed only when the INTERFACE is set to **PRINTER**).

### Screen when you touch **PAGE1**

(When the comparator function is **ON**)

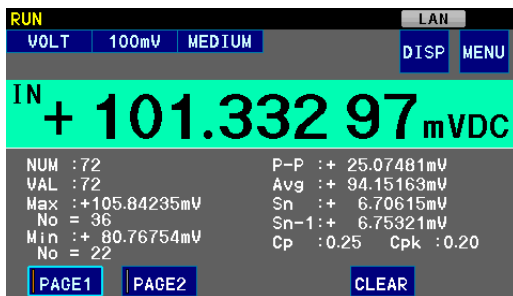

### Screen when you touch **PAGE2**

(When the comparator function is set to **ON**)

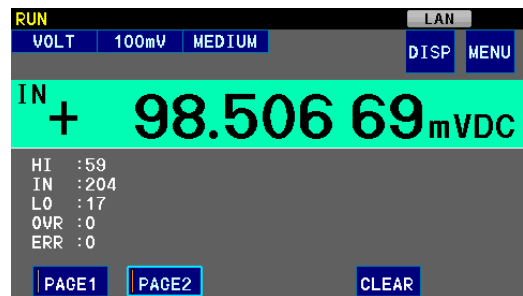

The count for each judgment result, the number of measured values outside the measurement range, and the number of errors are shown.

(When the BIN function is set to **ON**)

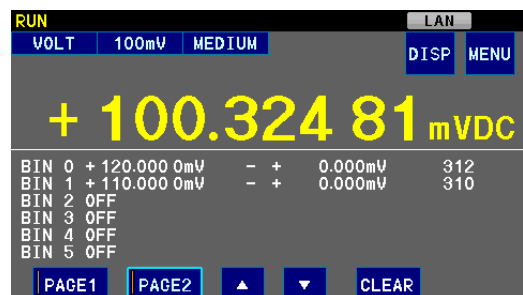

The count for each BIN number and the "Out of BINs" count are shown.

▲▼ Scrolls screen content.

<b>NUM</b>	Total number of data points
<b>VAL</b>	Number of valid data points
<b>Max No=</b>	Maximum value Index number
<b>Min No=</b>	Minimum value Index number
<b>P-P</b>	Maximum value - Minimum value
<b>Avg</b>	Average value
<b>Sn</b>	Population standard deviation
<b>Sn-1</b>	Sample standard deviation
<b>Cp</b>	Process capability index (variability)*
<b>Cpk</b>	Process capability index (bias)*

\*Displayed only when the comparator function is set to ON.

**The statistical calculation results are automatically cleared at the following times:**

- When the user clears the statistical calculation results
- When the user clears the statistical calculation results  
See “If you do not wish to clear the statistical calculation results every time they are printed” (p.86)
- When the user changes the measurement conditions (temperature compensation, scaling, NULL)
- When the user changes the comparator settings (p.53)
- When the user changes the BIN settings (p.57)
- When the instrument is reset (p.93)
- When measurement conditions are loaded using the panel load function
- When the instrument is turned off (p.28)

**Printing**

Touching **PRINT** prints the statistical calculation results.

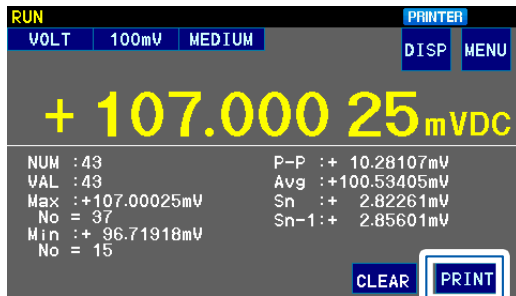

If there is no valid data, only the number of data points will be printed. If there is one valid data point, the sample standard deviation and process capability index will not be printed.

**If you do not wish to clear the statistical calculation results every time they are printed**

(Measurement screen) **MENU > I/F**

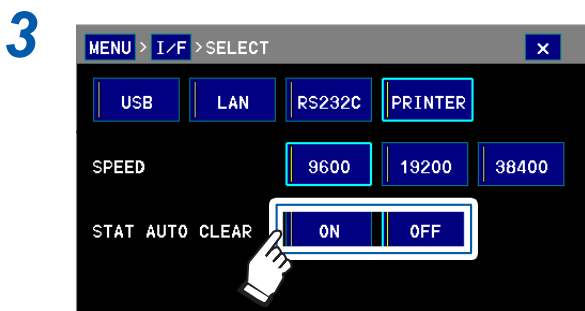
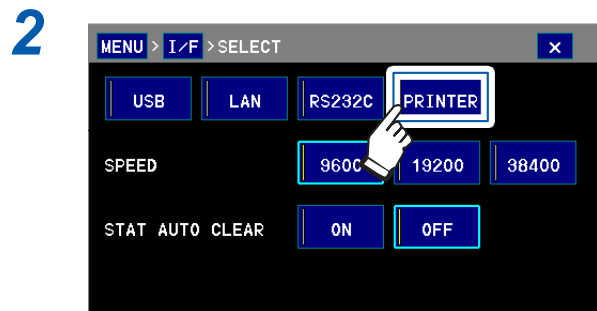
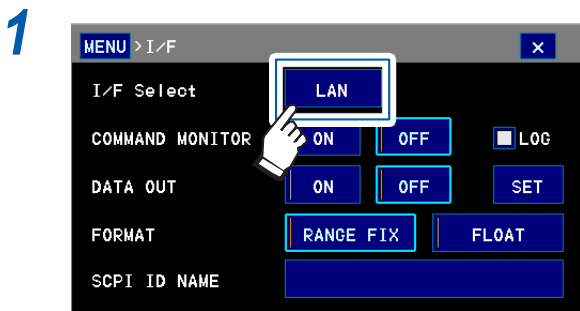

<b>ON</b>	Automatically clears the statistical calculation results every time they are printed.
<b>OFF</b>	Does not clear the statistical calculation results. (Default setting)

# 7 System Settings

## 7.1 Key Lock (Disabling Instrument Operation)

Operation of the instrument's keys and touch panel can be disabled by means of the key lock function.

(Measurement screen) **MENU > SYSTEM**

1

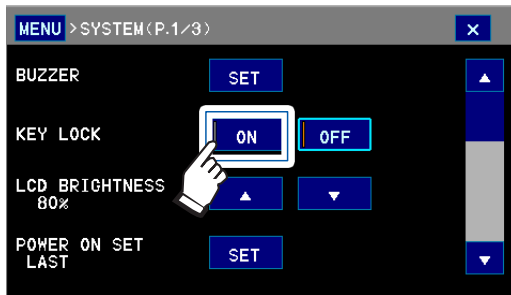

(Default setting: **OFF**)

2

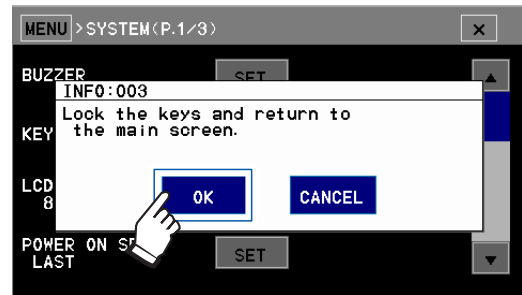

The key lock function will be enabled, and the display will return to the Measurement screen.

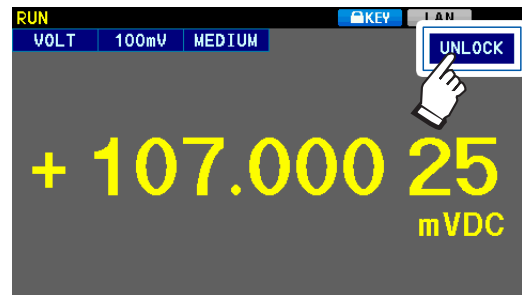

While the key lock function is enabled, the **KEY** icon will be displayed at the top of the screen.

**To cancel the key lock:**

**Touch and hold **UNLOCK** for at least 1 sec.**

The key lock function can also be enabled by the methods listed below, in which case the function cannot be canceled using the **UNLOCK** button on the touch panel.

- Turning on the EXT I/O's KEY\_LOCK signal (shorting the KEY\_LOCK pin and the ISO\_COM pin)
- Turning on the LOAD signal for a saved panel number

The **[TRIG]** key functions even when the key lock function is engaged.

## 7.2 Buzzer Settings

You can set the buzzer volume, operation tone, comparator judgment tone, and error tone. The volume setting applies to all buzzer tones.

For more information about how to set the comparator judgment tone, see “To check judgments aurally” (p.59).

(Measurement screen) **MENU > SYSTEM**

1

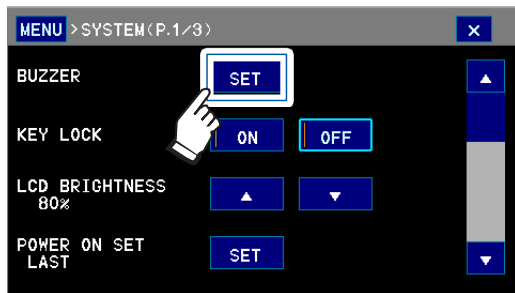

2

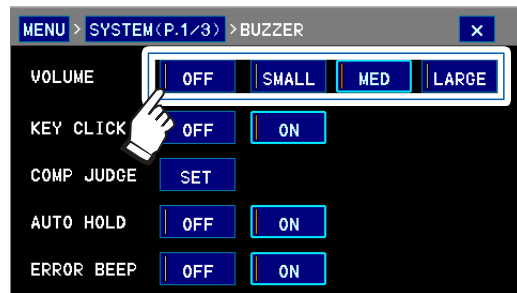

Set the volume.

<b>OFF</b>	No volume
<b>SMALL</b>	Low volume
<b>MED</b>	Normal volume (default setting)
<b>LARGE</b>	High volume

3

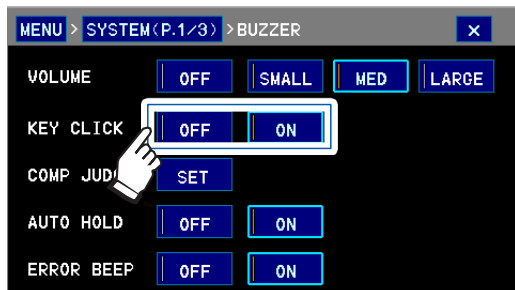

Set the operation tone.

<b>OFF</b>	Tone off (default setting)
<b>ON</b>	Tone on

4

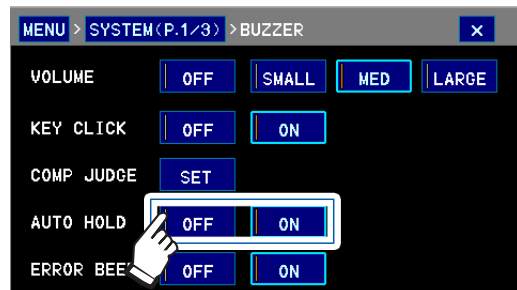

Set the auto-hold tone.

<b>OFF</b>	Tone off (default setting)
<b>ON</b>	Tone on

5

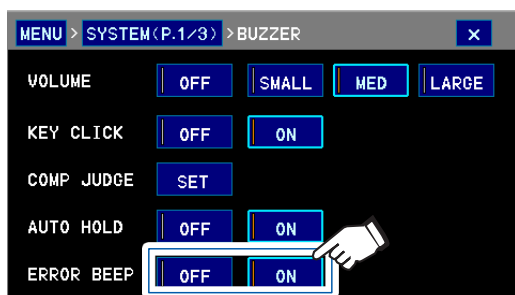

Set the error tone.

<b>OFF</b>	No tone (default setting)
<b>ON</b>	Tone on



## 7.3 Adjusting the Screen Brightness

You can adjust the screen brightness to suit the brightness of the location in which the instrument is being used.

(Measurement screen) **MENU** > **SYSTEM**

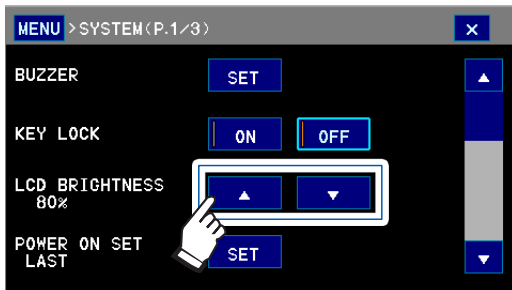

▲ Increases the screen brightness.

▼ Decreases the screen brightness.

(Default setting: 80% brightness)

## 7.4 Changing the Screen Color

You can change the screen color.

(Measurement screen) **MENU** > **SYSTEM**

**(BLUE)**

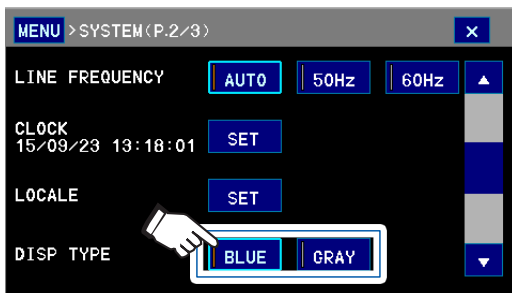

**BLUE** Blue screen (default setting)

**GRAY** Gray screen

**(GRAY)**

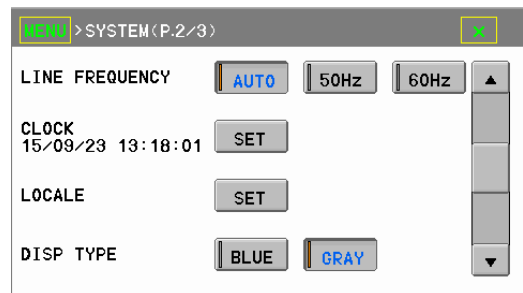

## 7.5 Adjusting the Touch Panel Position

You can adjust the touch panel position.

(Measurement screen) **MENU > SYSTEM**

1

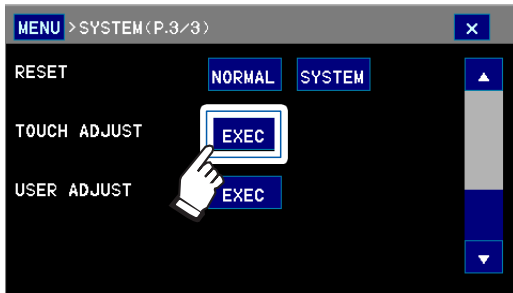

2

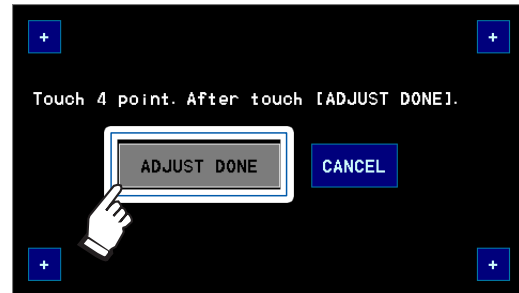

Touch **+** at each of the four corners and then touch **ADJUST DONE**.

If you fail to adjust the touch panel position, touch panel input will be improperly recognized. In this case, turn off the instrument and then turn it back on while holding down the **[AUTO]**, **[▲]**, and **[▼]** keys at the same time.

## 7.6 Setting the Power Supply Frequency

Although the power supply frequency is detected automatically under the default setting (**AUTO**), the frequency can also be set manually.

(Measurement screen) **MENU > SYSTEM**

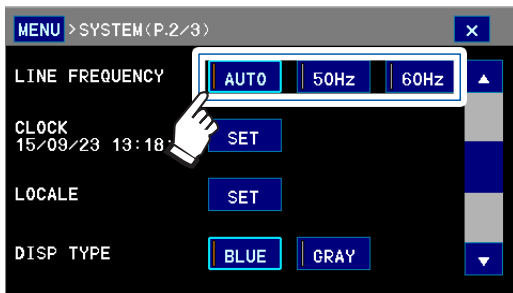

<b>AUTO</b>	Automatically detects the power supply frequency and sets it to either 50 Hz or 60 Hz as appropriate when the instrument is turned on or reset and when settings are changed (default setting).
<b>50 Hz</b>	Sets the power supply frequency to 50 Hz.
<b>60 Hz</b>	Sets the power supply frequency to 60 Hz.

- Set the power supply frequency accurately in order to stabilize measured values.
- When the automatic setting **AUTO** is used, the setting will not be changed even if the power supply frequency fluctuates other than when the instrument is turned on or reset.
- If the frequency varies from 50 Hz or 60 Hz, the closest frequency will be set automatically.  
Example: For a power supply frequency of 50.8 Hz → The instrument setting will be 50 Hz.  
For a power supply frequency of 59.3 Hz → The instrument setting will be 60 Hz.
- In the event of a detection error, the setting will be forcibly set to 50 Hz.

# 7.7 Selecting Startup Load Settings and a Panel

You can choose which settings to load when the instrument starts up.

(Measurement screen) **MENU > SYSTEM**

1

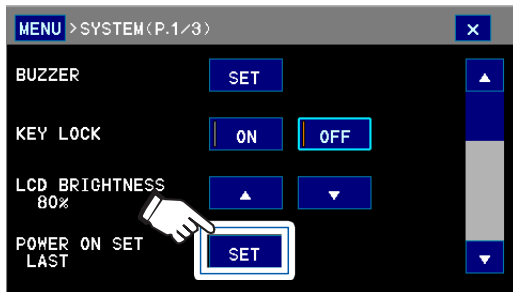

2

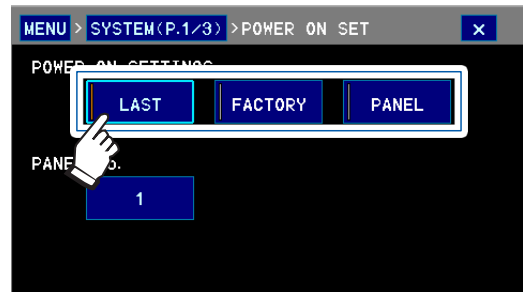

- LAST** Starts up with the last settings in use when the instrument was turned off (default setting).
- FACTORY** Starts up with the factory settings. Panel data, system and interface settings will not be initialized.
- PANEL** Loads the specified panel.

3

(When **PANEL** is selected)

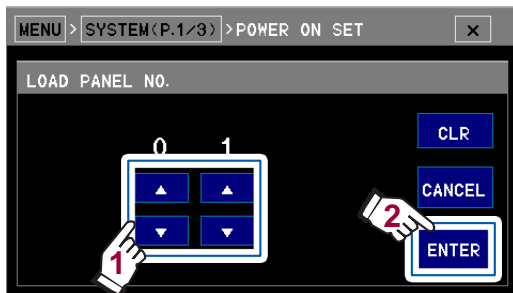

Specify the panel number.

- ^** Increases the value by 1.
- v** Decreases the value by 1.
- CLR** Resets the value to 0.
- CANCEL** Cancels the setting and returns to the previous screen.

Valid setting range: 1 to 30 (default setting: 1)

If a panel number that has not been saved is specified, the instrument will not load the panel and will instead start up with the settings that were in effect when it was turned off (same operation as for the **LAST** setting).

## 7.8 Setting Output Formats

The formats used for the screen display, USB flash drive output, print output, and USB keyboard output can be changed. However, when using USB keyboard output, the output data's delimiter must be set to TAB.

(Measurement screen) **MENU** > **SYSTEM** > **LOCALE**

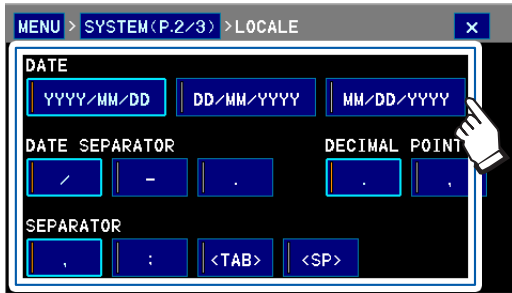

<b>DATE</b>	Output date <b>Y</b> : Year; <b>M</b> : month; <b>D</b> : day
<b>DATE SEPARATOR</b>	Date delimiter <b>/</b> : Slash <b>-</b> : Hyphen <b>.</b> : Period
<b>DECIMAL POINT</b>	Decimal point <b>.</b> : Period <b>,</b> : Comma
<b>SEPARATOR</b>	Output data delimiter <b>,</b> : Comma <b>;</b> : Semicolon <b>&lt;TAB&gt;</b> : Tab <b>&lt;SP&gt;</b> : Space

The default settings are as follows:

- Output date : YYYY-MM-DD  
 Example: 2015-01-01

---

- Date delimiter : Slash

---

- Decimal point : Period

---

- Output data : Comma delimiter

# 7.9 Resetting the Instrument (Reverting the Instrument to Its Factory Settings)

There are two types of reset:

**Reset**

Initializes the instrument to the factory settings. Panel data and interface settings will not be initialized.

There are three ways to trigger this reset:

- Selecting the reset command on the **SYSTEM** screen
- Turning on the instrument while holding down the **[AUTO]** and **[▲]** keys at the same time
- Issuing a communications command (**\*RST, :SYSTem:PRESet, :STATus:PRESet**)

**System reset**

Initializes all settings to the factory settings.

There are two ways to trigger this reset:

- Selecting the system reset command on the **SYSTEM** screen
- Turning on the instrument while holding down the **[AUTO]**, **[▲]**, and **[▼]** keys at the same time

- The clock setting will not be reset.
- For more information about communications commands, see the Communication Command Instruction Manual on the included application disc.

This section describes how to initiate a reset on the **SYSTEM** screen.

(Measurement screen) **MENU > SYSTEM**

1

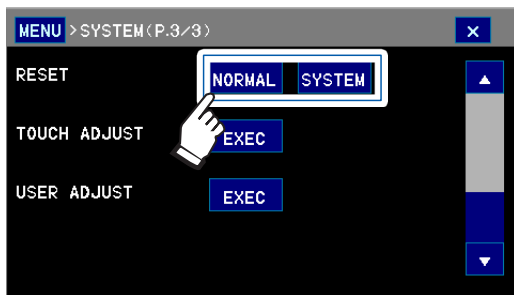

<b>NORMAL</b>	Performs a reset.
<b>SYSTEM</b>	Performs a system reset.

2

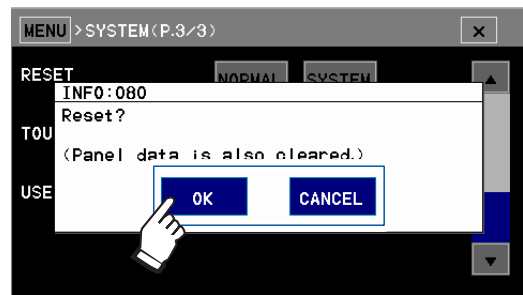

Touch **OK** to perform the reset.  
(Example screen: When **SYSTEM** is selected)

The Measurement screen will be displayed once the reset is complete.

7

System Settings

## List of default settings

Parameter	Default setting
Measured value display	V
Range switching	AUTO
Input resistance switching	10 MΩ
Number of display digits selection	7.5 digits
Integration time	10 PLC (MEDIUM)
Smoothing function	OFF Number of averaging iterations: 4
Trigger	Source: INTERNAL Number of measurements: 1 per trigger Delay: PRESET MANUAL time: 0 ms
NULL	OFF NULL value: 0 V
Temperature compensation	OFF Temperature coefficient: 0 ppm/°C Reference temperature: 20°C
Scaling	OFF A : 1 B : 0 Unit: V
Contact check	OFF Threshold: 1 nF Contact check integration time: 10 ms
Comparator	OFF Upper limit and lower limit values: 0 V, ON HIGH judgment tone: OFF IN judgment tone: OFF LOW judgment tone: OFF Number of tones: 2 Judgment delay: OFF Number of judgments: 2
BIN	OFF Upper limit and lower limit values: 0 V
Absolute value judgment	OFF
Auto-hold	OFF Hold range: 0.1% of range
Panel save/panel load	NULL value saving: ON
Label display	OFF Label: None
Data output	Automatic data output: OFF Output at judgment: ALL Measurement data: V°C Time and date: OFF
Key lock	OFF
Backlight	80% brightness
Power supply frequency	AUTO

Parameter	Default setting
Output format	Date: YYYYMMDD Date delimiter: Slash Decimal point: Period Data delimiter: Comma
Buzzer	Volume: MED Operation tone: ON Auto-hold tone: ON Error tone: ON
Communications monitor	OFF Log: OFF
Startup settings	Startup settings: LAST Panel: No. 01
EXT I/O	Input filter: OFF EOM output: HOLD





# Preparing to Use USB, RS-232C, GP-IB, and LAN Control

## 8.1 Overview of Interfaces and Associated Features

The instrument's USB, RS-232C, GP-IB, and LAN interfaces can be used to control the instrument and acquire data from it.

This chapter describes how to prepare to use this functionality, including how to configure associated settings.

For more information about how to control the instrument and acquire data from it, see the sections that best suite your application or intended use.

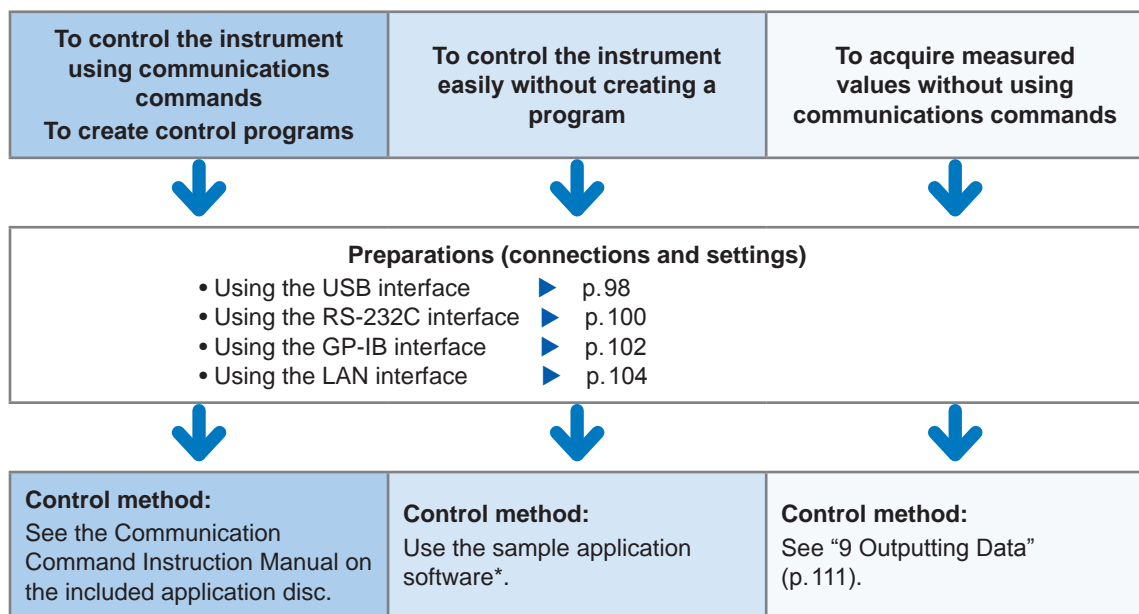

\*The software can be downloaded from our website (<http://www.hioki.com>).

Choose one interface to use. Communications control cannot be used at the same time. See "13.4 Interface Specifications" (p. 163)

### About communications time

- Display processing may lag depending on the frequency and content of communications processing.
- Consider the data transfer time when communicating with connected external devices.
  1. GP-IB, USB, and LAN transfer times vary with the connected external device.
  2. USB and LAN transfer times vary with communications quality.
  3. When using 1 start bit, 8 data bits, no parity, and 1 stop bit for a total of 10 bits and a transfer speed (baud rate) setting of N bps, the RS-232C transfer time will be roughly as follows:  
 Time required to transfer 1 character T (sec./character) = 10 [bits] / baud rate N [bps]  
 Example: For the string "ABCDE12345"  
 The two characters "CR+LF" will be added as a message terminator (delimiter), bringing the total of characters transferred to 12. Over a 9600 bps connection, the transfer time would be  $12 \times T = 12 \times 10/9600 = 12.5$  ms.
- For more information about command execution times, see the Communication Command Instruction Manual on the included application disc.

## 8.2 Preparing to Use an Interface (Connection and Settings)

### Using the USB interface

#### Preparation process

(1) Set the instrument's communications conditions.

(2) Install the USB driver on the computer. (p.99)  
(When using the **USB COM** setting only)

(3) Connect the USB cable. (p.99)

Before connecting the instrument to the computer, you must install the USB driver on the included CD-ROM on the computer. Connecting the instrument to the computer before the driver has been installed will cause the standard USB driver that Microsoft ships with Windows to be automatically installed. The instrument cannot communicate properly with the standard Windows USB driver.

#### (1) Set the communications conditions.

(Measurement screen) **MENU > I/F**

1

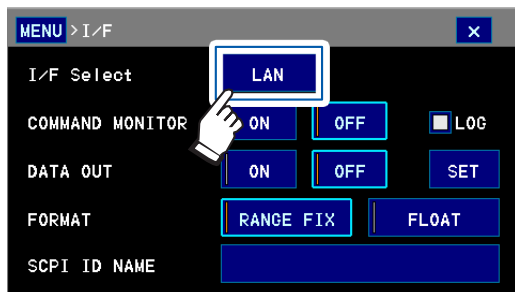

2

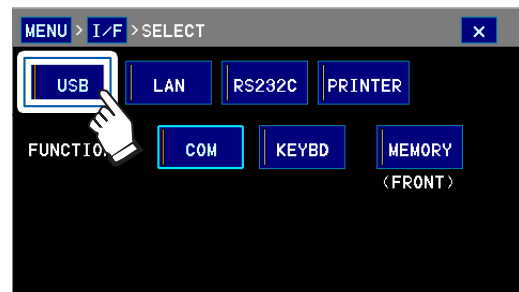

3

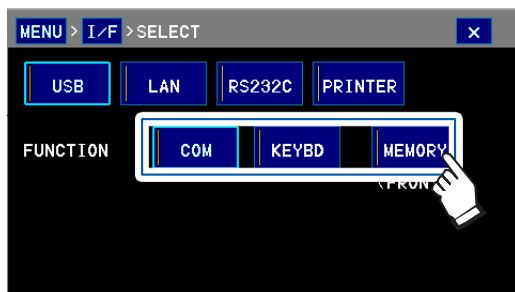

Select the transmission mode.

**COM**  
(Rear panel) (Default setting)  
Select if connecting the instrument to the computer with a USB cable and communicating using a virtual COM port (when outputting data using a terminal emulator or a user-created program).

**KEYBD**  
(Rear panel)  
Select if connecting the instrument to the computer with a USB cable and outputting data (when outputting data as if it were typed using a keyboard into a text editor or spreadsheet software).

**MEMORY**  
(Front panel)  
Select if outputting data to a USB flash drive. (p. 115)

## (2) Install the USB driver (when using the **USB COM** setting only)

Before connecting the instrument to the computer for the first time, install the instrument's dedicated USB driver. This step can be skipped if the driver has already been installed. The USB driver can be found on the included application disc or downloaded from our website (<http://www.hioki.com>).

### Installing the driver

**1** Log into the computer using an administrator account such as "Administrator."

**2** Exit all applications running on the computer.

**3** Execute **HiokiUsbCdcDriver.msi**.  
After executing the command, follow the instructions shown on the screen to install the driver.

Once the driver has been installed, the instrument will be recognized automatically when it is connected to the computer using a USB cable.

If executing the command from the included application disc, use the following command:

**X:\driver\HiokiUsbCdcDriver.msi**  
(X: CD-ROM drive letter)

Check which COM port the instrument is connected to using the computer's Device Manager.

In some environments, it may take some time for the dialog box to be displayed. Please wait for the dialog box.

- If the New Hardware Wizard window is displayed, select **No, not this time** and then select **Install the software automatically**.
- If you connect an instrument with a different serial number, you may be alerted that the computer has detected a new device. Follow the instructions on the screen to install the device driver.
- A message warning that the software has not acquired Microsoft® Windows® logo certification may be displayed. Continue to execute the software.

### Uninstalling the driver

(If you no longer need to use the driver)

Delete the **HIOKI USB CDC Driver** under **Add or Remove Programs** on the **Control Panel**.

## (3) Connect the USB cable.

Before connecting the USB cable, read "Before connecting the communication cables (USB, LAN, RS-232C, GP-IB)" (p. 10) and "Before making a connection to the USB connector" (p. 11) carefully.

Connect the USB cable to the instrument's USB connector.

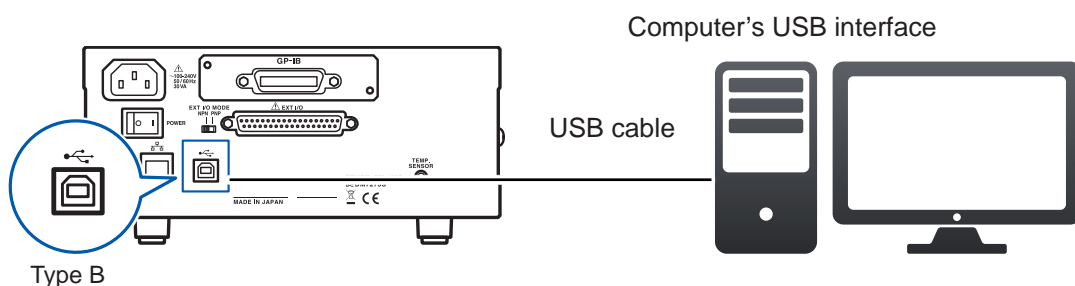

## Using the RS-232C interface

### Preparation process

(1) Set the instrument's communications conditions.

(2) Configure the external device that will be connected to the instrument.

(3) Connect the RS-232C cable. (p.101)

### (1) Set the communications conditions.

(Measurement screen) MENU > I/F

1

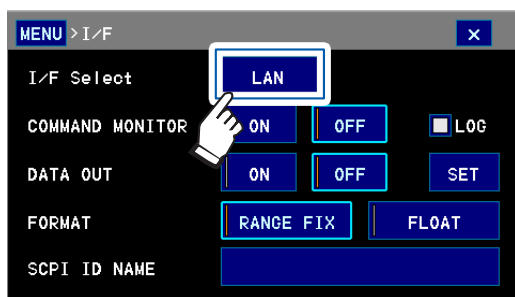

2

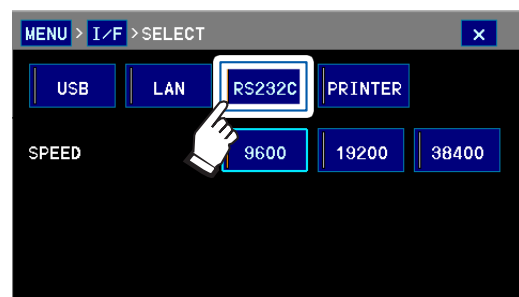

3

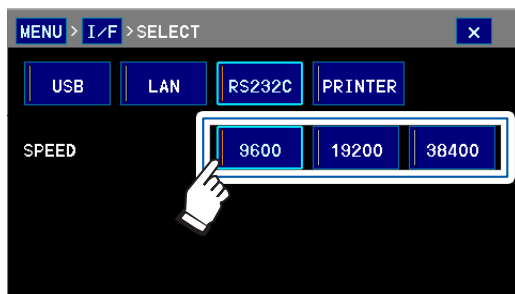

Select the transfer speed (baud rate).  
(Default setting: 9600 [bps])

### (2) Configure the external device that will be connected to the instrument (computer, programmable controller, etc.).

Be sure to configure the following settings on the device:

Method	Asynchronous
Transfer speed	9600 bps / 19200 bps / 38400 bps (same as instrument setting)
Stop bits	1
Data bits	8
Parity check	None
Flow control	None

### (3) Connect the RS-232C cable.

Before connecting the RS-232C cable, read “Before connecting the communication cables” (p. 10) and “Before connecting to the RS-232C or GP-IB connectors” (p. 11) carefully.

Connect the RS-232C cable to the RS-232C connector. When connecting the cable, be sure to tighten the fastening screws.

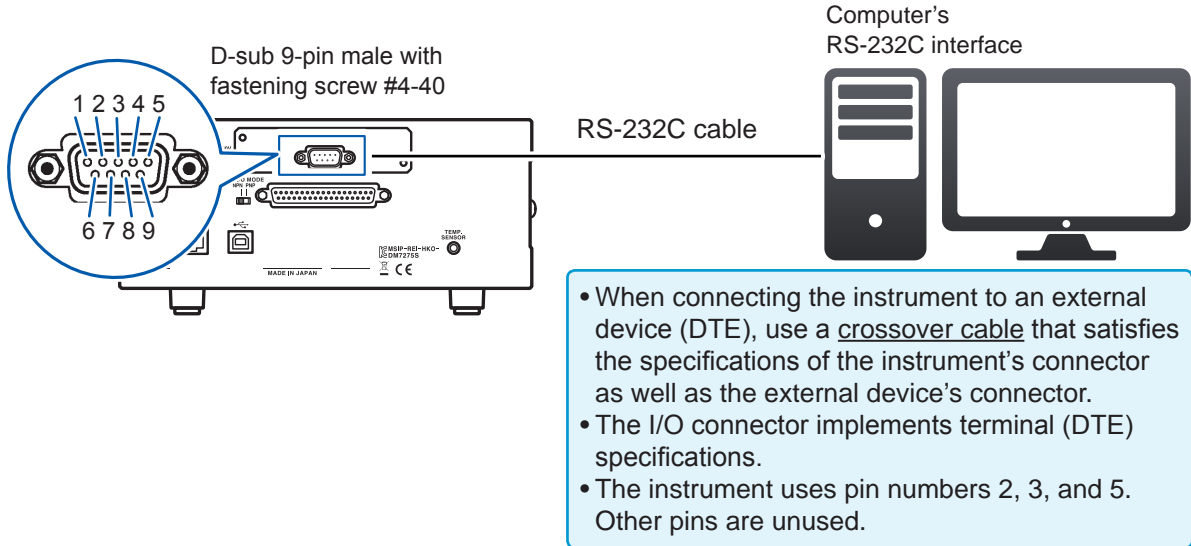

Pin no.	Signal name			Signal	Remarks
	Common name	EIA	JIS		
1	DCD	CF	CD	Data carrier detect	Not connected
2	RxD	BB	RD	Receive data	
3	TxD	BA	SD	Transmit data	
4	DTR	CD	ER	Data terminal ready	Fixed ON level (+5 to +9 V)
5	GND	AB	SG	Signal ground	
6	DSR	CC	DR	Data set ready	Not connected
7	RTS	CA	RS	Send request	Fixed ON level (+5 to +9 V)
8	CTS	CB	CS	Clear to send	Not connected
9	RI	CE	CI	Ring indicator	Not connected

#### When connecting the instrument to a computer

Use a D-sub 9-pin male to D-sub 9-pin male crossover cable.

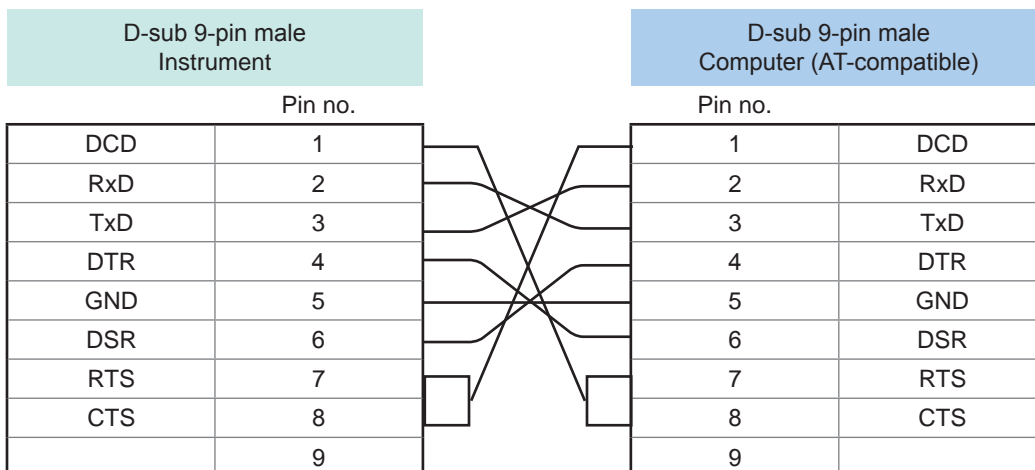

Recommended cable: Hioki 9637 RS-232C Cable (1.8 m)

## Using the GP-IB interface

### Preparation process

(1) Set the instrument's communications conditions.

(2) Connect the GP-IB cable.

### (1) Set the communications conditions.

(Measurement screen) MENU > I/F

1

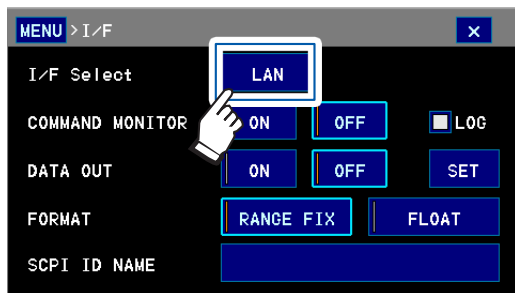

2

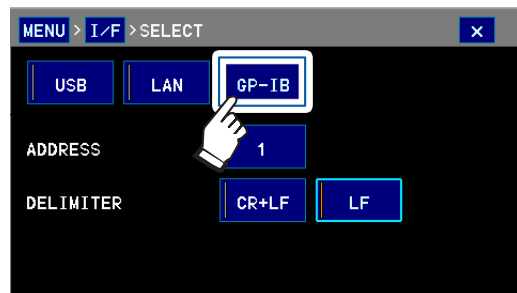

3

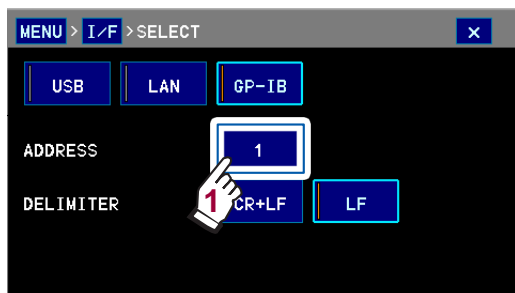

4

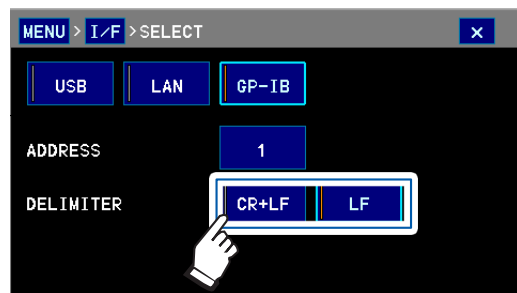

Select the message terminator.  
Default setting: LF

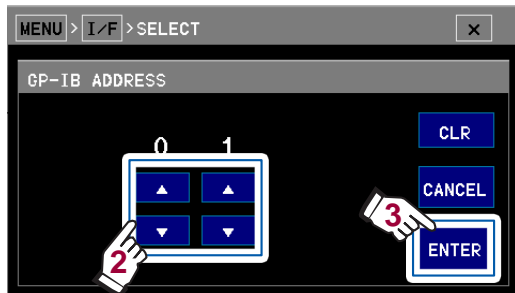

Set the address.

^	Increases the address by 1.
v	Decreases the address by 1.
CLR	Sets the address to 0.
CANCEL	Cancels the setting and returns to the previous screen.

(Default setting: 1, valid setting range: 1 to 30)

**(2) Connect the GP-IB cable.**

Before connecting the GP-IB cable, read “Before connecting the communication cables (USB, LAN, RS-232C, GP-IB)” (p. 10) and “Before connecting to the RS-232C or GP-IB connectors” (p. 11) carefully.

Connect the GP-IB connection cable to the instrument's GP-IB connector. When connecting the cable, be sure to tighten the fastening screws.

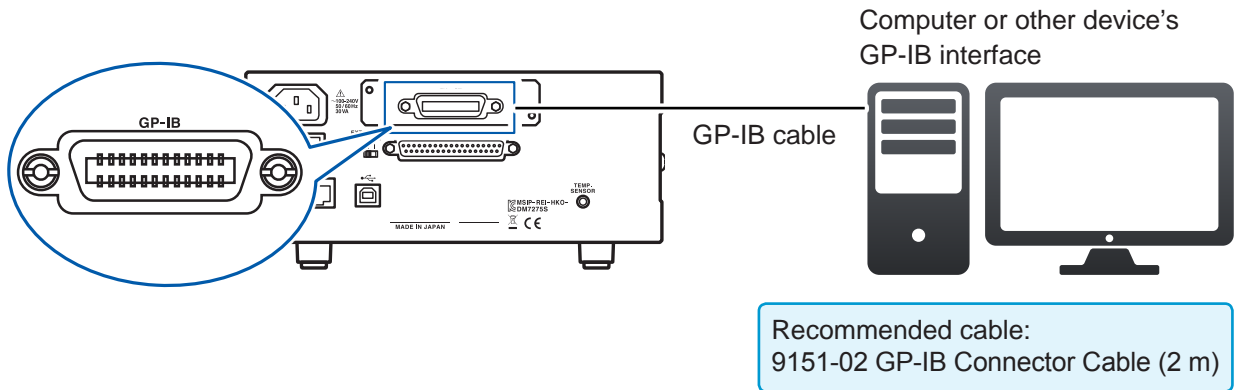

## Using the LAN interface

The instrument ships standard with an 100Base-TX Ethernet interface. You can control the instrument with a computer or other device by using a 10Base-T or 100Base-TX compatible LAN cable (up to 100 m) to connect the instrument to a network.

### Connecting the instrument and computers to a network

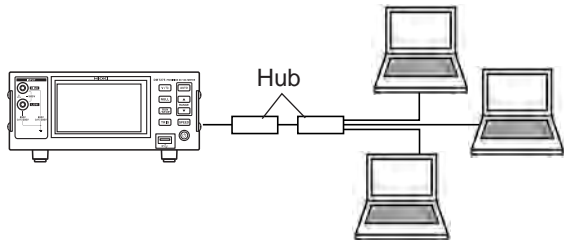

### Connecting the instrument to a single computer

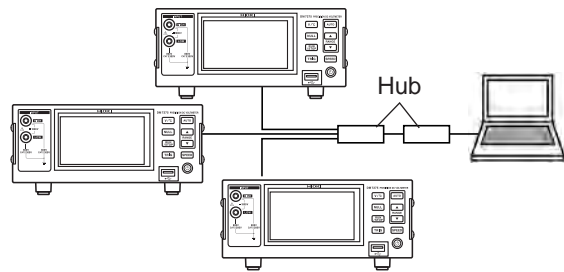
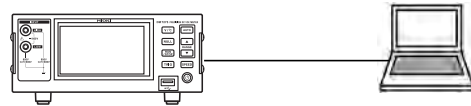

In addition, you can control the instrument using communications commands by creating a program and having it connect to the communications command port using TCP. (See the Communication Command Instruction Manual on the included application disc.)

## Preparation process

(1) Set the instrument's communications conditions. (p.105)



(2) Connect a LAN cable to the instrument. (p.108)



**(1) Set the communications conditions.****Check the settings before configuring them.**

The settings for both the instrument and external devices differ depending on whether you are connecting the instrument to an existing network or creating a new network consisting of the instrument and a single computer.

**Connecting the instrument to an existing network**

The following settings must be assigned in advance by the network system administrator (department). Be sure not to use settings that are already in use by another device.

- Instrument's address setting  
 IP address: ..... \_\_\_\_:\_\_\_\_:\_\_\_\_:\_\_\_\_  
 Subnet mask: ..... \_\_\_\_:\_\_\_\_:\_\_\_\_:\_\_\_\_
- Gateway  
 Whether to use a gateway: ..... Use / Do not use  
 IP address (if using): ..... \_\_\_\_:\_\_\_\_:\_\_\_\_:\_\_\_\_ (If not using, set to 0.0.0.0.)
- Port number used by communications commands: \_\_\_\_ (Default: 23)

**Creating a new network consisting of the instrument and a single computer**

(Using the instrument on a local network without any outside connection)

It is recommended to use the following addresses if there is no administrator, or if the settings are left to your discretion:

(Example settings)  
 IP addresses  
 Addresses should be assigned in order, for example:  
 Computer: 192.168.0.1  
 First instrument: 192.168.0.2  
 Second instrument: 192.168.0.3  
 Third instrument: 192.168.0.4  
  
 Subnet mask: ..... 255.255.255.0  
 Gateway: ..... OFF  
 Port number: ..... 23

### Settings

<b>IP Address</b>	This address is used to recognize individual devices that are connected to a network. Use an address that is not already in use by another device.
<b>Subnet Mask</b>	This setting is used to divide the IP address into an address that indicates the network and an address that indicates the device. Use the same subnet mask setting as other devices on the same network.
<b>Default Gateway</b>	<p><b>When connecting the instrument to a network</b>                  When the computer being used (or the device you are using to communicate with the instrument) is on a different network than the network to which the instrument is connected, specify a device to serve as the gateway by setting its IP address. If the instrument is on the same network as the computer, you should generally use the same default gateway setting as the computer.</p> <p><b>When connecting the instrument to a single computer or when not using a gateway</b>                  Set the IP address to <b>0.0.0.0</b>.</p>
<b>Port</b>	Specify the TCP/IP port number to use for communications command connections.

(Measurement screen) **MENU > I/F**

1

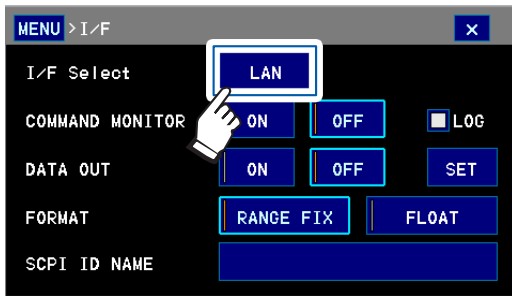

2

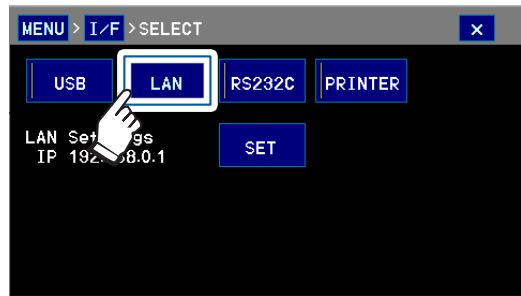

3

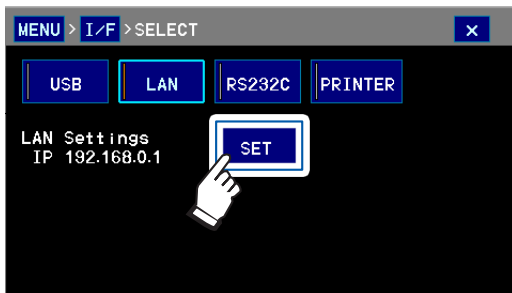

4

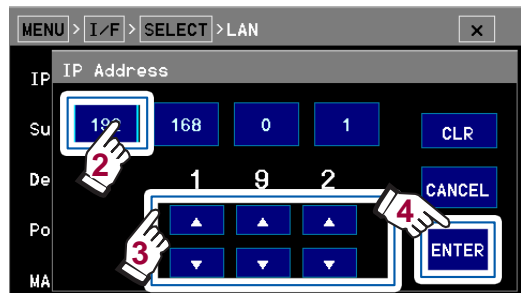
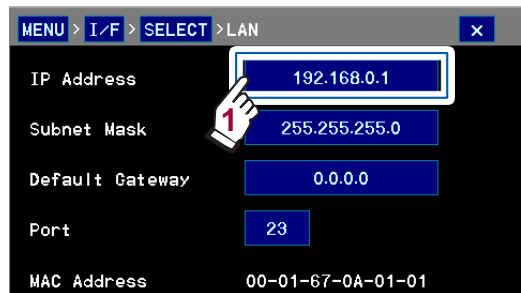

Set the IP address, subnet mask, gateway, and communications command port.

(Example screen: IP address setting)

▲	Increases the address by 1.
▼	Decreases the address by 1.
CLR	Sets the address to 0.
CANCEL	Cancels the setting and returns to the previous screen.

(Default settings: IP address [0.0.0.0], subnet mask [255.255.255.0], default gateway [0.0.0.0], communications command port [23])

## (2) Connect the LAN cable.

Before connecting the LAN cable, read “Before connecting the communication cables (USB, LAN, RS-232C, GP-IB)” (p. 10) carefully.

Connect the LAN cable to the instrument's LAN connector.

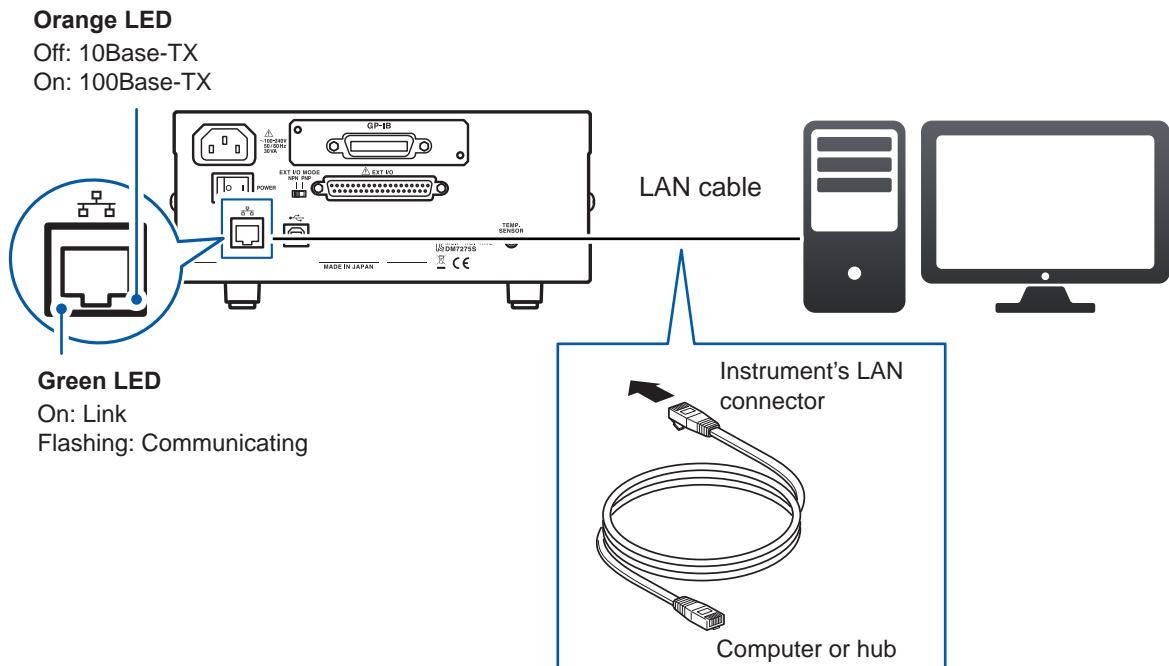

### Recommended cables

9642 LAN Cable (optional) or a 100Base-TX or 10Base-T compatible LAN cable (up to 100 m, straight or crossover cable)

If the green LED fails to light up after connecting a LAN cable, the instrument or connected device may be malfunctioning, or the LAN cable may have a break in it.

# 8.3 Communications Settings

## Communications monitor (displaying communications commands)

When using the communications monitor function, communications commands and query responses can be displayed on the screen.

(Measurement screen) **MENU > I/F**

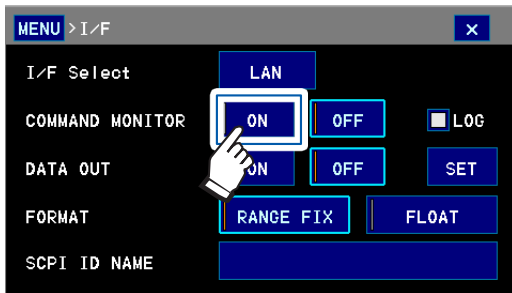

<b>ON</b>	Turns on the communications monitor display.
<b>OFF</b>	Turns off the communications monitor display (default setting).
<b>LOG</b>	When this checkbox is selected, communications commands and query responses are recorded on the USB flash drive.

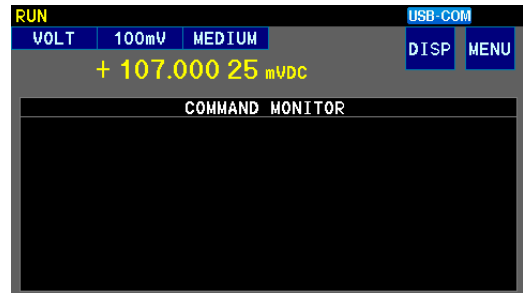

The communications monitor is displayed on the Measurement screen.

When selecting the **LOG** checkbox, set the interface to **USB MEMORY** and connect the USB flash drive to the front of the instrument. See "10 Using a USB Flash Drive" (p. 115)

### Messages shown in the communications monitor and their meanings

The following messages will be displayed if an error occurs during command execution:

<b>If a command error occurs (Illegal command, illegal argument format, etc.)</b>	> #CMD ERROR
<b>If an argument is out of range</b>	> #PARAM ERROR
<b>If an execution error occurs</b>	> #EXE ERROR

In addition, the approximate location of the error will also be displayed.

<b>Improper argument (10000 out of range)</b>	> :VOLT:DC:NPLC 10000 > # ^ PARAM ERROR
<b>Spelling error (RANGE misspelled as RENGE)</b>	> :VOLT:DC:RENGE 100 > # ^ CMD ERROR

- When an illegal character code is received, the character code will be displayed in hexadecimal notation enclosed in "<>." For example, the character 0xFF would be displayed as "<FF>," and the character 0x00 would be displayed as "<00>."
- The following messages will be displayed if an RS-232C interface error occurs:

<b>If an overrun error occurs (received data lost)</b>	#Overrun Error
<b>If a break signal is received</b>	#Break Error
<b>If a parity error occurs</b>	#Parity Error
<b>If a framing error occurs</b>	#Framing Error

- If multiple commands have been sent in series, the position of the error display may shift.
- If only hexadecimal characters are displayed or if one of the above messages is displayed when using the RS-232C interface, check the communications conditions or lower the communications speed and try again.

## Setting the format for measurement

You can set the format used by the instrument in response to measured value queries (:FETCh?, :READ?, etc.). When using the **FLOAT** setting, the instrument will automatically transition to the **STOP** state when transitioning to the REMOTE state.

(Measurement screen) **MENU > I/F**

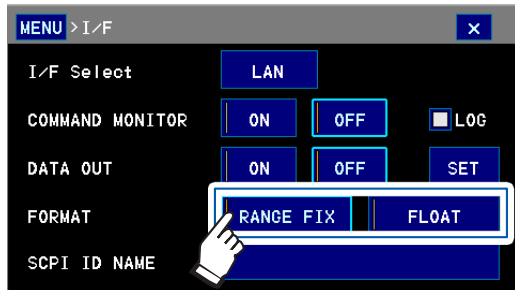

**RANGE FIX** Fixes the exponent part based on the measurement range (default setting).

**FLOAT** Uses floating-point notation.

- The output format cannot be changed using the data output function. (p. 114)
- Use the **FLOAT** setting if you require compatibility with an SCPI-compatible multimeter.
- For more information about the communications window, see the Communication Command Instruction Manual on the included application disc.

## Setting the model name acquired by commands

You can set the string returned to the external device when the instrument's model name is acquired with a communications command (\*IDN?). (When this parameter has not been set, the instrument will return **HIOKI, model name, serial number, software version**).

(Measurement screen) **MENU > I/F**

1

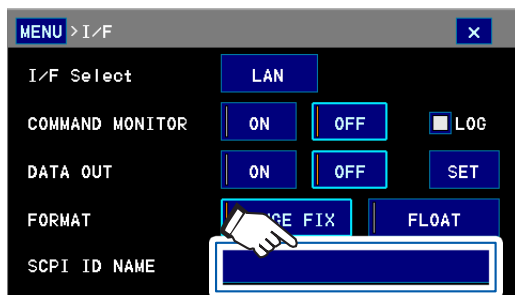

(Default setting: Blank)

2

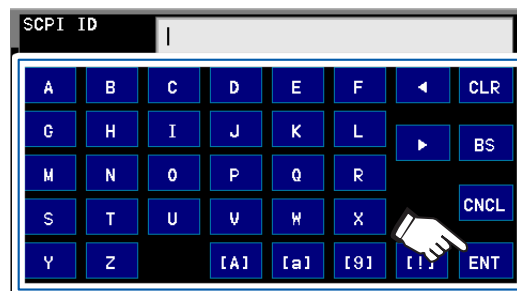

Enter the desired text and touch **ENT**.

Up to 127 characters can be entered.

**CLR** Deletes all characters. **[A]** Switches to uppercase characters.

**BS** Deletes the previous character. **[a]** Switches to lowercase characters.

**CNCL** Cancels the setting and returns to the previous screen. **[9]** Switches to numerals.

**<>** Moves the cursor. **[!]** Switches to symbols.

# 9 Outputting Data

When the data output setting is enabled, you can automatically output data to an external device such as a programmable controller or computer by pressing the **[TRIG]** key or inputting a trigger from the EXT I/O connector. (With this approach, there is no need to send a communications command.)

- When outputting data to the GP-IB interface, communications commands are used. See “Preparing to Use USB, RS-232C, GP-IB, and LAN Control” (p.97) and the Communication Command Instruction Manual on the included application disc.
- When outputting data to a USB flash drive, see “10 Using a USB Flash Drive” (p. 115).

## 9.1 Interface Settings

Set which interface to use.

(Measurement screen) **MENU > I/F > I/F Select**

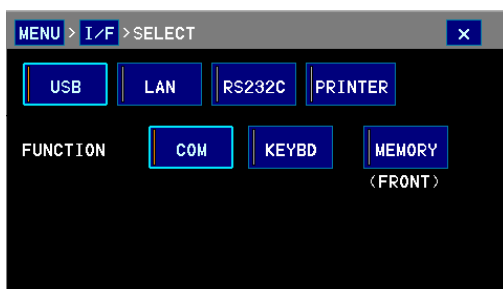

Setting	Overview
<b>USB COM</b>	Connect the instrument to a computer with a USB cable. Data can be captured with a terminal emulator or a user-created program.
<b>USB KEYBD</b>	Connect the instrument to a computer with a USB cable. Data can be output to a text editor or spreadsheet as if it were being typed on a keyboard.
<b>USB MEMORY</b>	When the <b>SAVE</b> key is touched, data will be output to the USB flash drive inserted into the receptacle on the front of the instrument. For more information about outputting data to a USB flash drive, see “10 Using a USB Flash Drive” (p. 115).
<b>LAN</b>	Connect the instrument to a computer with a LAN cable. Data can be captured with either a terminal emulator or a user-created program.
<b>RS-232C</b>	Connect the instrument to a computer’s COM port or a programmable controller with an RS-232C cable. Data can be captured with either a terminal emulator or a user-created program.
<b>PRINTER</b>	Connect the instrument to the optional 9442 Printer with an RS-232C cable. The data will be printed out.
<b>GP-IB</b>	Connect the instrument to a computer with a GP-IB cable. Data cannot be output automatically in this configuration.

## 9.2 Output Methods

### 1 Configure the interface and EXT I/O and connect the instrument.

- **USB COM, USB KEYBD:**  
See “Using the USB interface” (p.98).
- **RS-232C:**  
See “Using the RS-232C interface” (p.100).
- **LAN:**  
See “Using the LAN interface” (p.104).
- **PRINTER:**  
See “12 Printing” (p.143).
- **EXT I/O (when inputting the TRIG signal):**  
See “11 External Control (EXT I/O)” (p.125).

### 2 Configure the instrument.

- Set the automatic output setting (DATA OUT) to ON.**  
(When selecting **PRINTER**, this step is not necessary.)  
See “9.3 Data Output Settings” (p.113)

### 3 Prepare the device to which the instrument will be connected.

- **USB COM, LAN, RS-232C:**  
Place the device to which the instrument will be connected in the receive standby state. If connecting the instrument to a computer, launch the application and place it in the receive standby state.
- **USB KEYBD:**
  1. Launch the application, text editor, or spreadsheet.
  2. Place the cursor at the position in the text editor or other application at which you wish to enter the text.
  3. Set the input mode to half-byte characters.

Data cannot be output automatically to the GP-IB interface.

### 4 Output the data.

Press the **[TRIG]** key or input the EXT I/O TRIG signal.

Measurement will start with trigger input, and after measurement is complete, the measured value will be output.

If the instrument is in the **STOP** state or the trigger source is set to **EXTERNAL**, the number of output data points will be the same as the measurement count setting (1 sample per trigger to 5000 samples per trigger).

See “Trigger measurement (measurement with user-specified timing)” (p.38).



## 9.3 Data Output Settings

(Measurement screen) **MENU > I/F**

### 1 Enable automatic output.

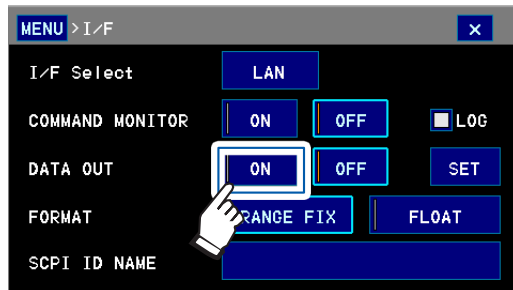

(Default setting: **OFF**)

When automatic output is set to **ON**, do not use communications commands. Doing so may cause measured value data to be sent twice.

### 2 (To change the information that will be output)

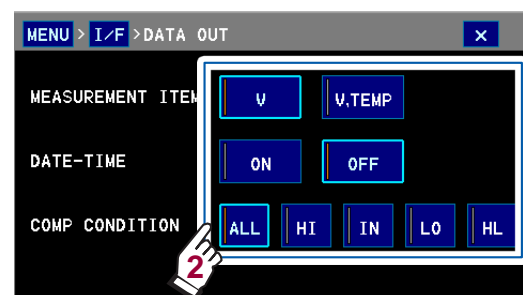
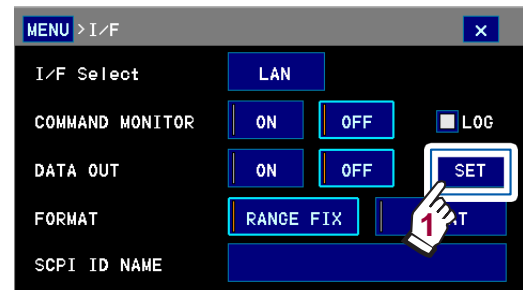

**MEASUREMENT ITEM** **V**: Voltage value (default setting)  
**V, TEMP**: Voltage value and temperature

**DATE-TIME** Measurement time and date (default setting: **OFF** [output disabled])

**COMP CONDITION** **ALL**: All judgments (default setting)  
**HI**: HI judgments  
**IN**: IN judgments  
**LO**: LO judgments  
**HL**: HI and LO judgments

- If comparator judgment or BIN measurement is set to **ON**, judgment results will also be output.
- When the interface is set to **USB KEYBD**, **DATE-TIME** is not output.

### 3 (To change the output format)

See “7.8 Setting Output Formats” (p.92).

## Output data format

Example: When the scaling function is OFF, the number of display digits is 7.5, and the output format is set to the decimal period

(The output data format varies depending on the scaling function setting, number of display digits setting, and output format setting.)

See “Correcting measured values using a linear expression (scaling function)” (p.82), “3.6 Changing the Number of Display Digits” (p.48), and “7.8 Setting Output Formats” (p.92).

### USB COM, USB KEYBD, RS-232C, LAN:

Voltage (units: mV, V)

Measured value range	Measured value	When +OvrRng or -OvrRng is displayed	At measurement error
100 mV	± □□□.□□□□□E-03	±990.00000E+35	+991.00000E+35
1 V	± □□□□.□□□□□E-03	±9900.0000E+34	+9910.0000E+34
10 V	± □□.□□□□□□E+00	±99.000000E+36	+99.100000E+36
100 V	± □□□.□□□□□□E+00	±990.00000E+35	+991.00000E+35
1000 V	± □□□□.□□□□□E+00	±9900.0000E+34	+9910.0000E+34

Temperature (unit: °C)

Measured value	When +OvrRng or -OvrRng is displayed	At measurement error
±□□.□□	±9.900E+37	+9.910E+37

### USB MEMORY:

Voltage (units: mV, V)

Measured value	When +OvrRng or -OvrRng is displayed	At measurement error
±□.□□□□□□□□E±0□	±9.9000000E+37	+9.9100000E+37

Temperature (unit: °C)

Measured value	When +OvrRng or -OvrRng is displayed	At measurement error
±□.□□□E+0□	±9.90E+37	+9.91E+37

If there are not enough digits in the integer portion, digits with the value of 0 will be added.

Example: If the measured value in the 1000 V range is 1 V, the value will be indicated as +0001.0000E+00. In the event of the +OvrRng or -OvrRng display, the value will be ±9.9E+37, and in the event of a measured value error, the value will be 9.91E+37.

For more information about output when the interface is set to **PRINTER**, see “Print examples” (p.148).

# 10 Using a USB Flash Drive

## 10.1 Overview

Measurement data, screenshots, and measurement conditions stored in the instrument's internal memory can be output to a USB flash drive. In addition, measurement conditions stored on a USB flash drive can be loaded into the instrument's internal memory. When using a USB flash drive, the USB connector on the rear of the instrument cannot be used.

<b>Outputting data</b>	Data is output from the instrument's internal memory to the USB flash drive.	
	Data that can be output	Remarks
	Measurement data (latest measured values only)	<ul style="list-style-type: none"><li>• Text format</li><li>• Up to 10000 data points</li></ul>
	Measurement data (all)	Up to 5000 data points
	Screenshot data	
	Current measurement conditions	Panel data can be output with measurement conditions.
<b>Loading measurement conditions</b>	Measurement conditions stored on a USB flash drive can be loaded into the instrument's internal memory. (Panel data can be loaded with measurement conditions.)	
<b>Displaying information about a USB flash drive</b>	The amount of space on the flash drive in use can be displayed.	

If the number of measurement data points exceeds 10000, the file will be segmented automatically.

### Data save time

Time may be required to save data depending on the type of USB flash drive and its internal file structure.

### Compatible USB flash drive specifications

<b>Connector</b>	USB Type A connector
<b>Electrical specifications</b>	USB 2.0
<b>Bus power</b>	Max. 500 mA
<b>Number of ports</b>	1
<b>Compatible USB flash drives</b>	Drives that support the USB Mass Storage Class (not VFAT compatible)

# 10.2 Connecting a USB Flash Drive

Before connecting, read “Before connecting a USB flash drive” (p. 11) carefully.

## Inserting the drive

Insert the USB flash drive into the instrument’s USB flash drive connector.

- Do not insert a USB flash drive that does not support the Mass Storage Class.
- Not all commercially available flash drives are supported.
- If the instrument does not recognize a USB flash drive, try a different drive.

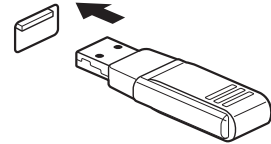

## Removing the drive

Verify that the instrument is not accessing the USB flash drive (to output or load data, etc.) and then pull it out of the connector.

It is not necessary to perform any “eject” operation on the instrument.

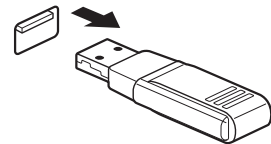

## Screen displays when using a USB flash drive

The **USB** icon will be displayed at the top right of the screen when a USB flash drive has been recognized by the instrument.

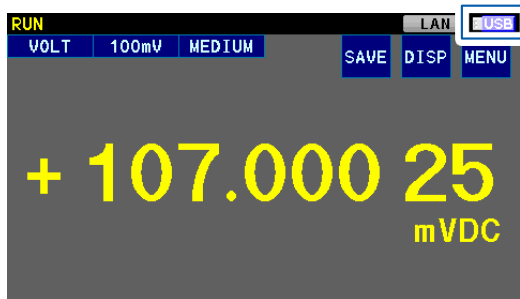

You can check the amount of available space on the USB flash drive as well as the drive’s capacity on the **File** screen.

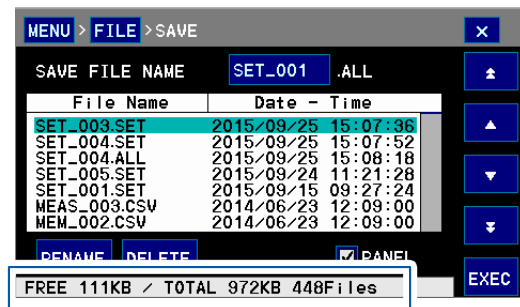

## 10.3 Setting the Interface

Before outputting data to a USB flash drive, you must set the interface to USB flash drive mode. When using a USB flash drive, the USB connector on the rear of the instrument cannot be used.

(Measurement screen) **MENU > I/F**

1

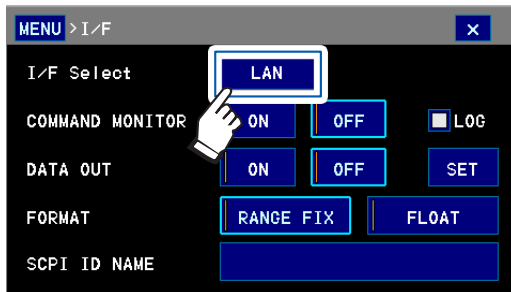

2

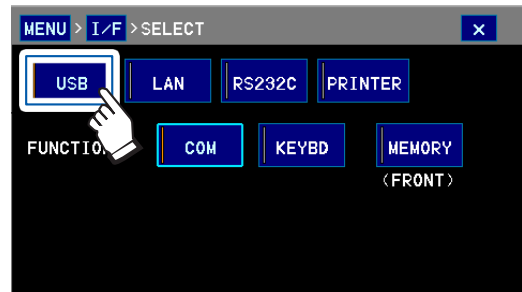

3

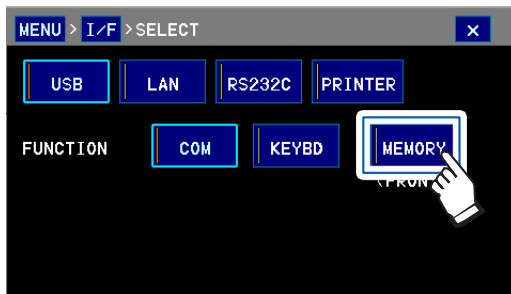

When **USB COM** or **USB KEYBD** is selected, data cannot be saved on a USB flash drive.

## 10.4 Setting the Output Data Type

This section describes how to set the type of data to output to the USB flash drive.

(Measurement screen) **MENU > FILE**

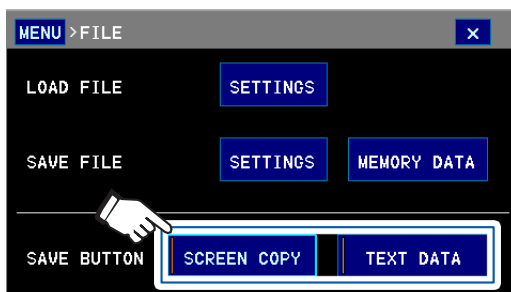

Select the output data type.

**SCREEN COPY** Outputs the contents of the instrument's screen as a BMP file.

**TEXT DATA** Outputs measured values as text data (default setting).

**To change the output format**  
See "7 Setting Output Formats" (p.92).

## 10.5 Outputting Data (USB Flash Drive)

### Outputting measurement data or screenshots

Touch **SAVE** to output the measurement data\* or screenshot\* as of the time you touched the button to the USB flash drive.

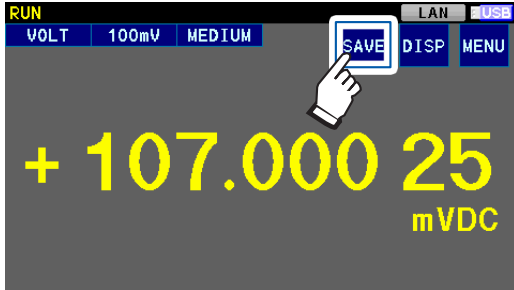

\*The output format reflects the output format setting (p.117).

You can also take a screenshot by pressing and holding the **[TRIG]** key for 2 seconds.  
(You can take screenshots with the **[TRIG]** key even if the output format is set to **TEXT DATA**.)

The following actions cause a new save file to be created:

- Inserting a USB flash drive while the instrument is on  
(Even if there are already files on the USB flash drive, a new folder will be created.)
- Turning on the instrument with a USB flash drive already inserted

Measurement data will be appended to a single file until the number of data points in the file reaches 10000, at which point a new file will be created automatically.

## Outputting all measurement data

All measurement data stored in the instrument's internal memory (up to 5000 data points) can be output at once to the USB flash drive.

(Measurement screen) **MENU > FILE**

1

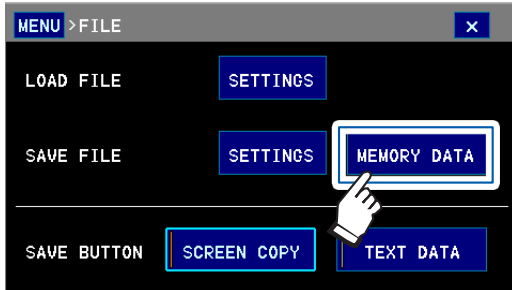

2

(To change the filename)

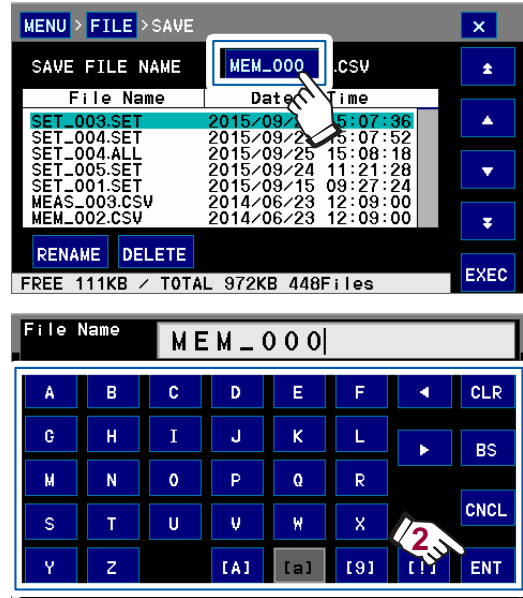

Enter text and touch **ENT**.

Up to 8 characters can be entered.

<b>CLR</b>	Deletes all characters.	<b>[A]</b>	Switches to uppercase characters.
<b>BS</b>	Deletes the previous character.	<b>[a]</b>	Switches to lowercase characters.
<b>CNCL</b>	Cancels the setting and returns to the previous screen.	<b>[9]</b>	Switches to numerals.
<b>&lt;&gt;</b>	Moves the cursor.	<b>[!]</b>	Switches to symbols.

3

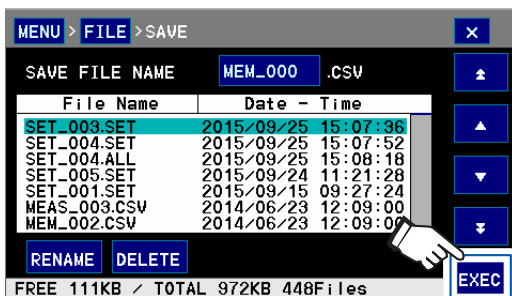

4

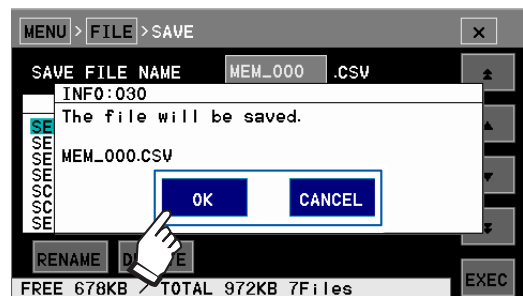

Touch **OK** to output the measurement data to the USB flash drive.

# 10.6 Outputting and Loading Measurement Conditions (USB Flash Drive)

## Outputting measurement conditions

The current measurement conditions as well as panel data saved on the instrument can be output to a USB flash drive. This function is convenient when you wish to back up settings or copy settings to multiple instruments. You can select whether to output panel data.

(Measurement screen) **MENU > FILE**

1

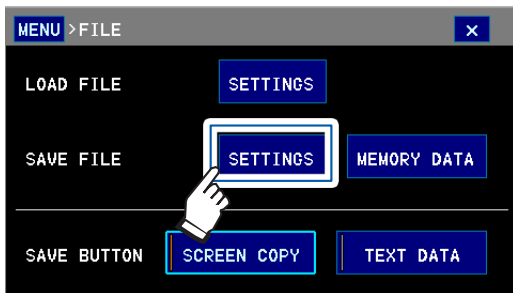

2

(To change the filename)

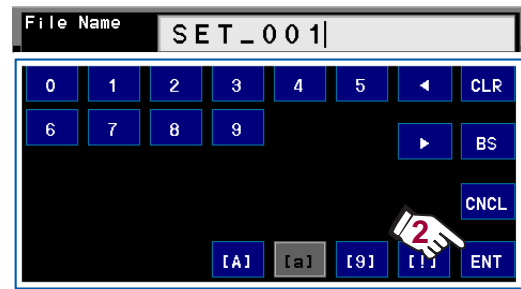
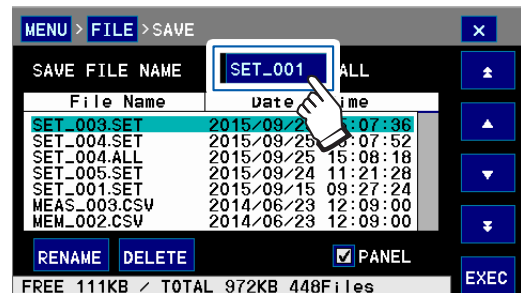

Enter text and touch **ENT**.

Up to 8 characters can be entered.

<b>CLR</b>	Deletes all characters.	<b>[A]</b>	Switches to uppercase characters.
<b>BS</b>	Deletes the previous character.	<b>[a]</b>	Switches to lowercase characters.
<b>CNCL</b>	Cancels the setting and returns to the previous screen.	<b>[9]</b>	Switches to numerals.
<b>&lt; &gt;</b>	Moves the cursor.	<b>[!]</b>	Switches to symbols.



3

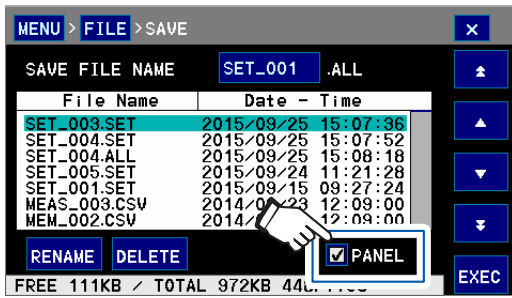

4

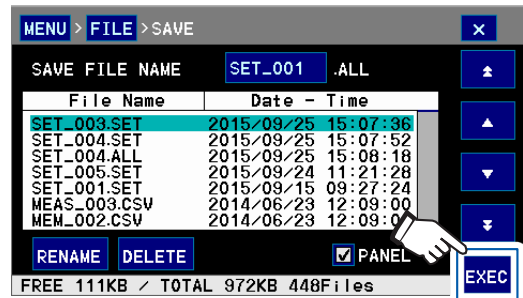

Select whether to output panel data.

<b>Checked</b>	Outputs panel data (default setting).
<b>Not checked</b>	Does not output panel data.

5

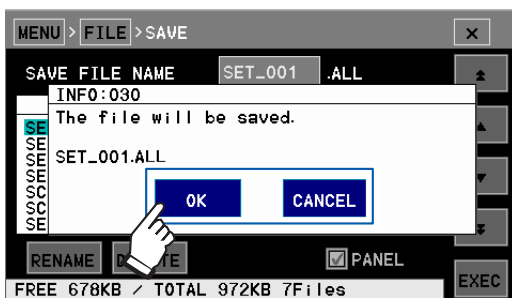

The output files have the following extensions:  
 .SET: Measurement conditions  
 .ALL: Measurement conditions and panel data

Touch **OK** to output the selected measurement conditions to the USB flash drive.

The output settings are recorded as textual communications commands in a settings file on the USB flash drive. This file can be sent as a command during initial configuration when writing a program to a connected instrument.

## Loading measurement conditions

This section describes how to load measurement conditions stored on a USB flash drive into the instrument. Communications settings are not loaded.

(Measurement screen) **MENU > FILE**

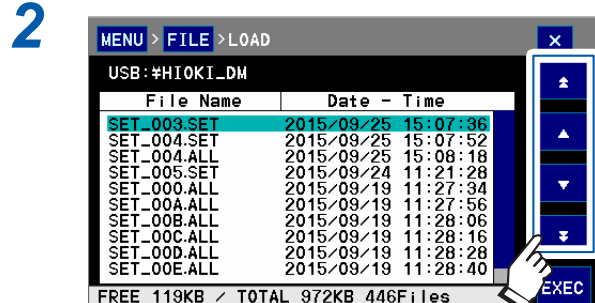
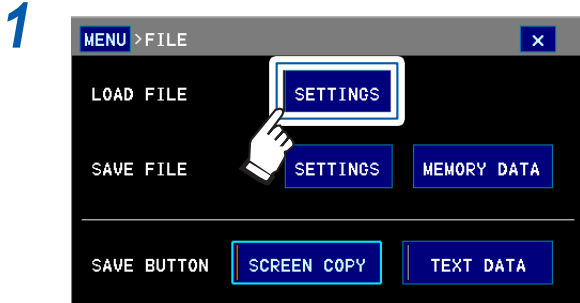

Select the measurement conditions.

File content varies with the extension:  
 .SET: Measurement conditions  
 .ALL: Measurement conditions and panel data

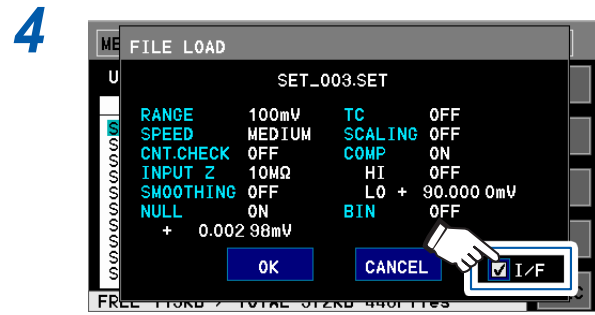
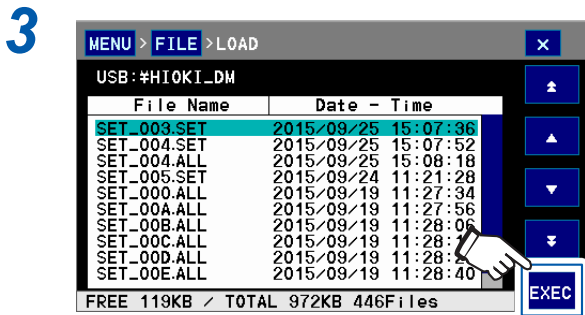

Select whether to load interface settings.

Checked	Loads interface settings.
Not checked	Does not load interface settings.

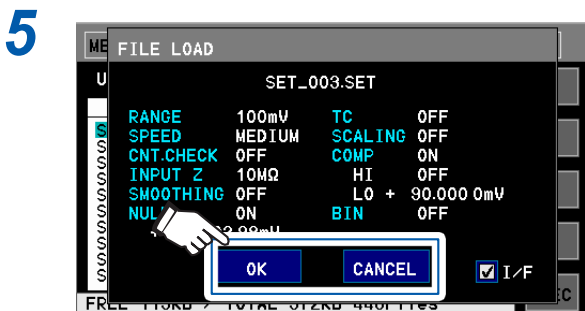

Touch **OK** to replace the instrument's settings with the loaded measurement settings.

## 10.7 Files

You can check the data stored on a USB flash drive on a computer. (USB flash drive contents cannot be checked using the instrument.)

### File format

Data is saved in the file format described below. The first time a USB flash drive is inserted into the instrument, the folder listed in the table below will be created automatically. (If the folder is deleted, it will be created automatically the next time the drive is inserted into the instrument.)

Folder name	Contents	Save filename	Extension
HIOKI_DM	<b>Output measurement data</b> See "Outputting measurement data or screenshots" (p. 118)	<b>MEAS_XXX</b> or user-specified filename	.CSV
	<b>Measurement data from the instrument's internal memory output collectively</b> See "Outputting all measurement data" (p. 119).	<b>MEM_XXX</b> or user-specified filename	.CSV
	<b>Screenshot data</b> See "Outputting measurement data or screenshots" (p. 118).	<b>SCRN_XXX</b>	.BMP
	<b>Measurement condition data</b> See "Outputting and Loading Measurement Conditions (USB Flash Drive)" (p. 120).	<b>SET_XXX</b> or user-specified filename	.SET
	<b>Measurement condition data and panel data</b> See "Outputting and Loading Measurement Conditions (USB Flash Drive)" (p. 120).	<b>SET_XXX</b> or user-specified filename	.ALL

XXX: Sequential number from 000 to 199

### Types and number of files used by the instrument

- The instrument cannot display two-byte characters (Japanese, etc.). Two-byte characters will be displayed as "??."
- Filenames used by the instrument have 8-character filenames and 3-character extensions (for example, "abcdefgh.csv").



The EXT I/O connector on the rear of the instrument provides the following functionality:

- Outputting signals such as the measurement complete signal (EOM signal) and judgment results signals (HI, IN, LO) from the instrument to an external device
- Controlling the instrument by inputting signals such as the TRIG and KEY\_LOCK signals from an external device.

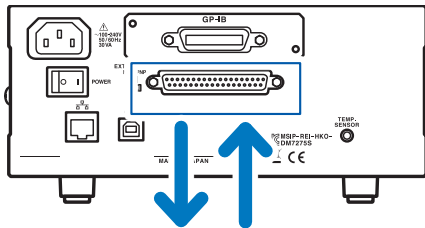

Outputting or inputting signals

All signals are isolated from the instrument's measurement circuitry and from ground (but share a common potential with the input and output common pins).

The instrument's input circuitry can be switched to support either current sink output (NPN) or current source output (PNP) (p. 126). Connect the instrument to a control system after reviewing the input and output ratings, internal circuit architecture, and safety precautions (p. 12), and be sure to use the instrument as designed.

## 11.1 External Control Measurement Process

### Preparations

(1) Check the input and output specifications of the external device that you are connecting to the instrument.

(2) Configure the instrument's NPN/PNP switch. (p. 126)

(3) Connect the external device to the instrument. (p. 127)

(4) Configure external input and output on the instrument. (p. 136)

(5) Test input and output. (p. 138)

### Measurement

Connect the instrument to the measurement target and perform measurement.

## 11.2 Switching between Current Sink (NPN) and Current Source (PNP)

Before using, read “Before switching the current sink (NPN) / current source (PNP)” (p. 11) carefully.

The NPN/PNP switch is used to change the type of programmable controller that can be supported. The instrument ships with the switch in the NPN position.

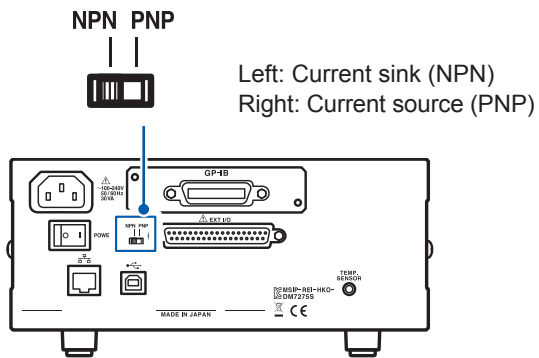

See “Internal circuit architecture” (p. 133).

	NPN/PNP switch setting	
	NPN	PNP
Input circuit	Supports programmable controllers that generate sink output.	Supports programmable controllers that generate source output.
Output circuit	Non-polar	Non-polar
ISO_5V power supply output	+5 V output	-5 V output

## 11.3 Connections (Instrument and Control Device)

Before connecting, read “Before connecting to the EXT I/O connector” (p. 12) carefully.

The EXT I/O interface can be used to perform the following types of control:

Capability		Operations (signals)
(1)	Acquiring comparator judgment results	Start measurement (TRIG signal) ↓ Measurement complete (EOM signal) ↓ Acquire judgment results (HI, IN, LO, ERR signals)
(2)	Acquiring BIN judgment results	Start measurement (TRIG signal) ↓ Measurement complete (EOM signal) ↓ Acquire measured values (BIN0 to BIN9 signals, OB signal, ERR signal)
(3)	Loading panel data	Specify panel (LOAD0 to LOAD4 signals) ↓ Start measurement after panel load operation (TRIG signal)
(4)	General-purpose input and output	:IO:INPut? command (IN0, IN1 signals) :IO:OUTPut? command (OUT0 to OUT7 signals)
(5)	Key lock	Enable key lock (KEY_LOCK signal)
(6)	Printing	Print (PRINT signal)

## Instrument connector and compatible connectors

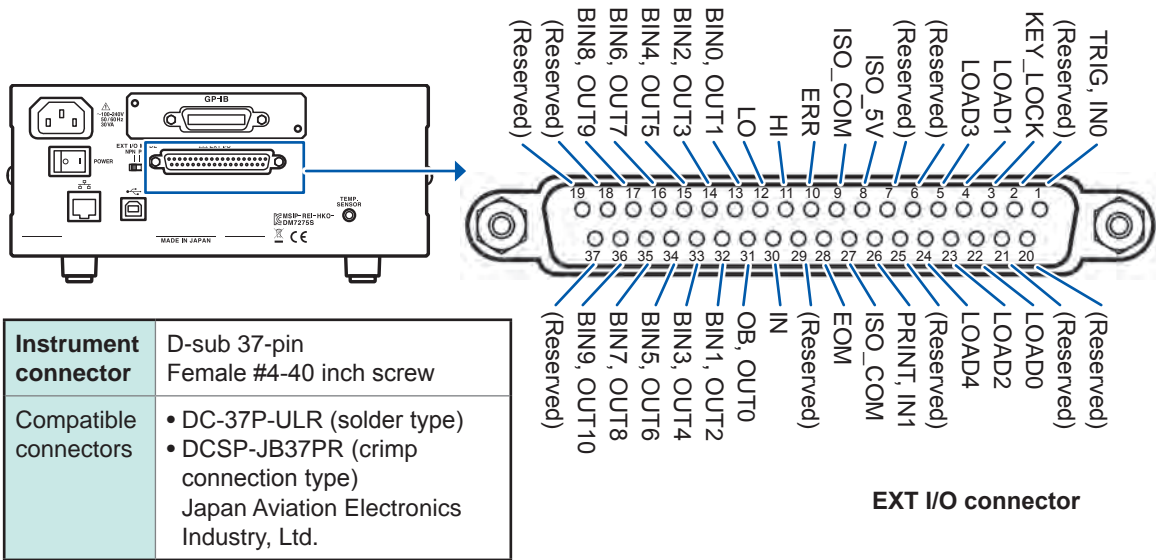

Pin	Signal	I/O	Function	Logic	Pin	Signal	I/O	Function	Logic
1	TRIG, IN0	IN	Trigger General-purpose input	Edge	20	(Reserved)	n/a	n/a	n/a
2	(Reserved)	n/a	n/a	n/a	21	(Reserved)	n/a	n/a	n/a
3	KEY_LOCK	IN	Key lock	Level	22	LOAD0	IN	Panel load	Level
4	LOAD1	IN	Panel load	Level	23	LOAD2	IN	Panel load	Level
5	LOAD3	IN	Panel load	Level	24	LOAD4	IN	Panel load	Level
6	(Reserved)	n/a	n/a	n/a	25	(Reserved)	n/a	n/a	n/a
7	(Reserved)	n/a	n/a	n/a	26	PRINT, IN1	IN	Measured value printing General-purpose input	Edge
8	ISO_5V	n/a	Isolated power supply +5 V (-5 V) output	n/a	27	ISO_COM	n/a	Isolated power supply common	n/a
9	ISO_COM	n/a	Isolated power supply common	n/a	28	EOM	OUT	Measurement complete	Level
10	ERR	OUT	Measurement error	Level	29	(Reserved)	n/a	n/a	n/a
11	HI	OUT	Comparator judgment	Level	30	IN	OUT	Comparator judgment	Level
12	LO	OUT	Comparator judgment	Level	31	OB, OUT0	OUT	BIN judgment General-purpose output	Level
13	BIN0, OUT1	OUT	BIN judgment General-purpose output	Level	32	BIN1, OUT2	OUT	BIN judgment General-purpose output	Level
14	BIN2, OUT3	OUT	BIN judgment General-purpose output	Level	33	BIN3, OUT4	OUT	BIN judgment General-purpose output	Level
15	BIN4, OUT5	OUT	BIN judgment General-purpose output	Level	34	BIN5, OUT6	OUT	BIN judgment General-purpose output	Level
16	BIN6, OUT7	OUT	BIN judgment General-purpose output	Level	35	BIN7, OUT8	OUT	BIN judgment General-purpose output	Level
17	BIN8, OUT9	OUT	BIN judgment General-purpose output	Level	36	BIN9, OUT10	OUT	BIN judgment General-purpose output	Level
18	(Reserved)	n/a	n/a	n/a	37	(Reserved)	n/a	n/a	n/a
19	(Reserved)	n/a	n/a	n/a					



The connector frame is connected to the instrument's rear panel (metal portion) as well as the power supply inlet's protective ground terminal.

When loading panel data by means of a command or touch panel operation, fix pins 4, 5, 22, 23, and 24 to ON or OFF (so that they are all either open or all shorted).

For more information about checking EXT I/O input and output, see "11.5 Input Test/Output Test" (p. 138).

## Signal functions

### (1) Isolated power supply output

Pin	Signal	NPN/PNP switch setting	
		NPN	PNP
8	ISO_5V	Isolated power supply +5 V	Isolated power supply -5 V
9, 27	ISO_COM	Isolated power supply common	Isolated power supply common

### (2) Input signals

Signal	Description	For more information
TRIG	<ul style="list-style-type: none"> <li>The instrument operates at the TRIG signal's ON edge.</li> </ul>	
	<ul style="list-style-type: none"> <li>Operation varies depending on the trigger source. When the trigger source is <b>EXTERNAL</b>: Measurement is performed the set number of times. When the trigger source is <b>INTERNAL</b>: The TRIG signal is ignored.</li> <li>Measurement must be delayed (by the delay time) after switching ranges or loading panel data in order for measured values to stabilize. The delay time varies with the measurement target.</li> </ul>	"3 Starting Measurement" (p.37)
	<ul style="list-style-type: none"> <li>When automatic output is set to <b>ON</b>, the measured value being held internally will be output immediately after TRIG signal input.</li> </ul>	"9 Data Output Settings" (p.113)
PRINT	By turning on the PRINT signal, it is possible to print the measured value and judgment result that are current as of the signal's edge.	"12 Printing" (p.147).
KEY_LOCK	When the KEY_LOCK signal is on, all instrument key operations and touch panel operations (except operation to cancel the key-lock state) are ignored.	"7 Key Lock (Disabling Instrument Operation)" (p.87)
LOAD0 to LOAD4	<ul style="list-style-type: none"> <li>Inputting the LOAD signal corresponding to the desired panel number for 10 ms will cause that panel to be loaded. Do not change the LOAD signal until the load or switching operation is complete. LOAD0 is the LSB, while LOAD4 is the MSB.</li> <li>The TRIG signal is ignored while panel load operation is being performed.</li> <li>The LOAD signal is valid even when the instrument is being controlled using communications commands (i.e., when the instrument is in the remote state).</li> <li>All key operations and touch panel operations are ignored while the LOAD signal for a panel number for which settings have been saved is on.</li> <li>When loading panel data by means of a command or touch panel operation, fix pins 4, 5, 22, 23, and 24 to ON or OFF (so that they are all either open or all shorted).</li> </ul>	<ul style="list-style-type: none"> <li>"(4) Signal table" (p.132)</li> <li>"5.2 Loading Measurement Conditions (Panel Load Function)" (p.64)</li> </ul>
IN0, IN1	These pins can be used as general-purpose input pins to monitor the status of input with the <code>:IO:INPut?</code> command.	Communication Command Manual on the included application disc.

Input signals are ignored while the Measurement screen is not being displayed and while errors and other messages are being displayed.

**(3) Output signals**

Signal	Description	For more information
<b>EOM</b>	This signal is output when measurement completes. The comparator judgment results, ERR signal, and BIN signal are updated when the EOM signal is output.	“EOM signal output type” (p.137)
<b>ERR</b>	This signal is output when a contact error (display: <b>NoCntct</b> ), temperature compensation error (display: <b>Err.TC</b> ), or other error occurs. All comparator judgment result output turns off while the ERR signal is output. The ERR signal is also output when the instrument encounters an internal circuitry error or a calculation results error.	“3.5 Measurement Error Displays (Displays Other Than Measured Values)” (p.46)
<b>HI, IN, LO</b>	These signals are used to output comparator judgment results.	
<b>OB, BIN0 to BIN9</b>	The BIN judgment results are output from pins 13 to 17 and pins 31 to 36 when BIN measurement is set to <b>ON</b> . If the results do not correspond to BIN0 to BIN9, the OB signal (pin 31) will turn on.	<ul style="list-style-type: none"> <li>• “4.3 BIN Measurement (Using Multiple Judgment Standards)” (p.57)</li> <li>• See explanation on following page.</li> </ul>
<b>OUT0 to OUT10</b>	Pins 13 to 17 and pins 31 to 36 can be used as general-purpose output pins while BIN measurement is set to OFF. Output signals can be controlled with the <b>:IO:OUTPut</b> command.	<ul style="list-style-type: none"> <li>• “4.3 BIN Measurement (Using Multiple Judgment Standards)” (p.57)</li> <li>• See explanation on following page.</li> <li>• Communication Command Manual on the included application disc.</li> </ul>

The TRIG signal is ignored while the measurement conditions are being changed.

**Output signal functionality can be switched when the BIN measurement setting is changed.**

When BIN measurement is set to **OFF** (default setting), these signals can be used as 11-bit general-purpose output pins in addition to being used for the purpose of acquiring comparator judgment results (HI, IN, LO).

When BIN measurement is set to **ON**, the BIN judgment results are output from pins 13 to 17 and pins 31 to 36.

See “4.3 BIN Measurement (Using Multiple Judgment Standards)” (p.57).

**When BIN measurement is [OFF]**

Pin	Signal	Pin	Signal
9	ISO_COM	28	EOM
10	ERR	29	
11	HI	30	IN
12	LO	31	OUT0
13	OUT1	32	OUT2
14	OUT3	33	OUT4
15	OUT5	34	OUT6
16	OUT7	35	OUT8
17	OUT9	36	OUT10
18		37	
19			

**When BIN measurement is [ON]**

Pin	Signal	Pin	Signal
9	ISO_COM	28	EOM
10	ERR	29	
11		30	
12		31	OB
13	BIN0	32	BIN1
14	BIN2	33	BIN3
15	BIN4	34	BIN5
16	BIN6	35	BIN7
17	BIN8	36	BIN9
18		37	
19			

(4) Signal table

**LOAD0 to LOAD4**

LOAD4	LOAD3	LOAD2	LOAD1	LOAD0	Panel number
OFF	OFF	OFF	OFF	OFF	-
OFF	OFF	OFF	OFF	ON	Panel 1
OFF	OFF	OFF	ON	OFF	Panel 2
OFF	OFF	OFF	ON	ON	Panel 3
OFF	OFF	ON	OFF	OFF	Panel 4
OFF	OFF	ON	OFF	ON	Panel 5
OFF	OFF	ON	ON	OFF	Panel 6
OFF	OFF	ON	ON	ON	Panel 7
OFF	ON	OFF	OFF	OFF	Panel 8
OFF	ON	OFF	OFF	ON	Panel 9
OFF	ON	OFF	ON	OFF	Panel 10
OFF	ON	OFF	ON	ON	Panel 11
OFF	ON	ON	OFF	OFF	Panel 12
OFF	ON	ON	OFF	ON	Panel 13
OFF	ON	ON	ON	OFF	Panel 14
OFF	ON	ON	ON	ON	Panel 15
ON	OFF	OFF	OFF	OFF	Panel 16
ON	OFF	OFF	OFF	ON	Panel 17
ON	OFF	OFF	ON	OFF	Panel 18
ON	OFF	OFF	ON	ON	Panel 19
ON	OFF	ON	OFF	OFF	Panel 20
ON	OFF	ON	OFF	ON	Panel 21
ON	OFF	ON	ON	OFF	Panel 22
ON	OFF	ON	ON	ON	Panel 23
ON	ON	OFF	OFF	OFF	Panel 24
ON	ON	OFF	OFF	ON	Panel 25
ON	ON	OFF	ON	OFF	Panel 26
ON	ON	OFF	ON	ON	Panel 27
ON	ON	ON	OFF	OFF	Panel 28
ON	ON	ON	OFF	ON	Panel 29
ON	ON	ON	ON	OFF	Panel 30
ON	ON	ON	ON	ON	-

## Internal circuit architecture

- Use ISO\_COM as the common pin for both input signals and output signals.
- If a large current will flow to common wiring, branch the output signal common wiring and input signal common wiring near the ISO\_COM pin.

### NPN setting

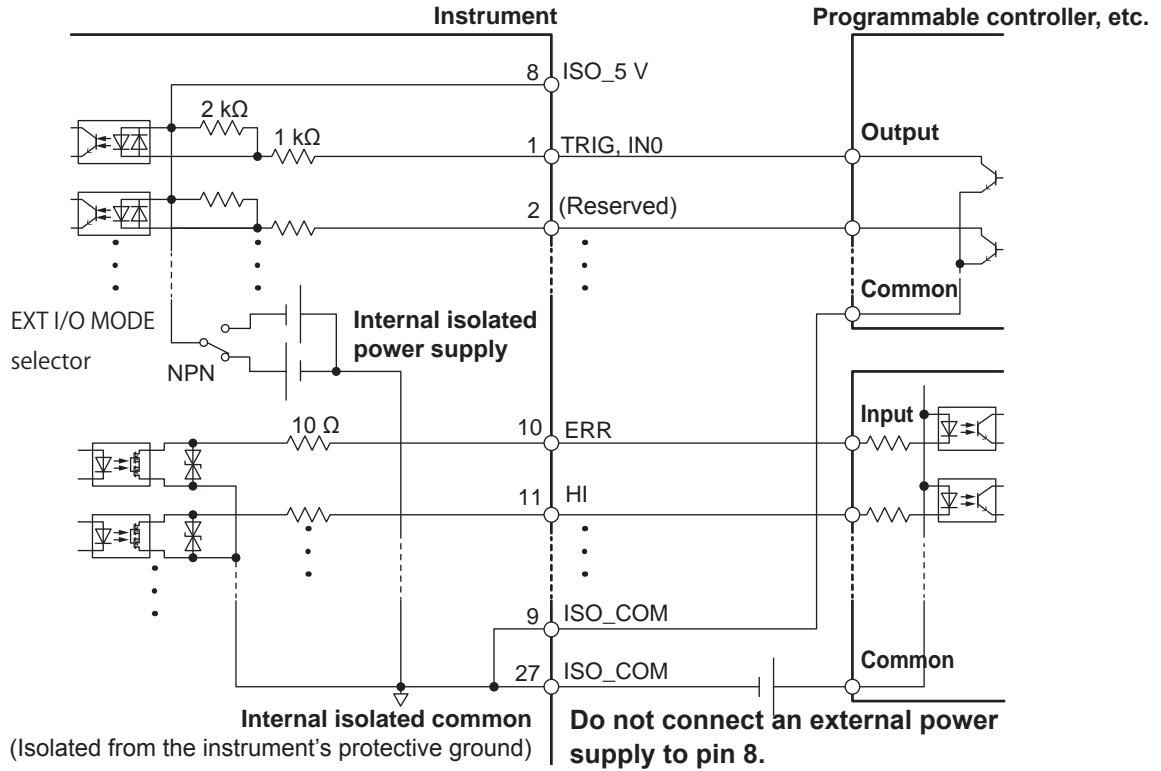

### PNP setting

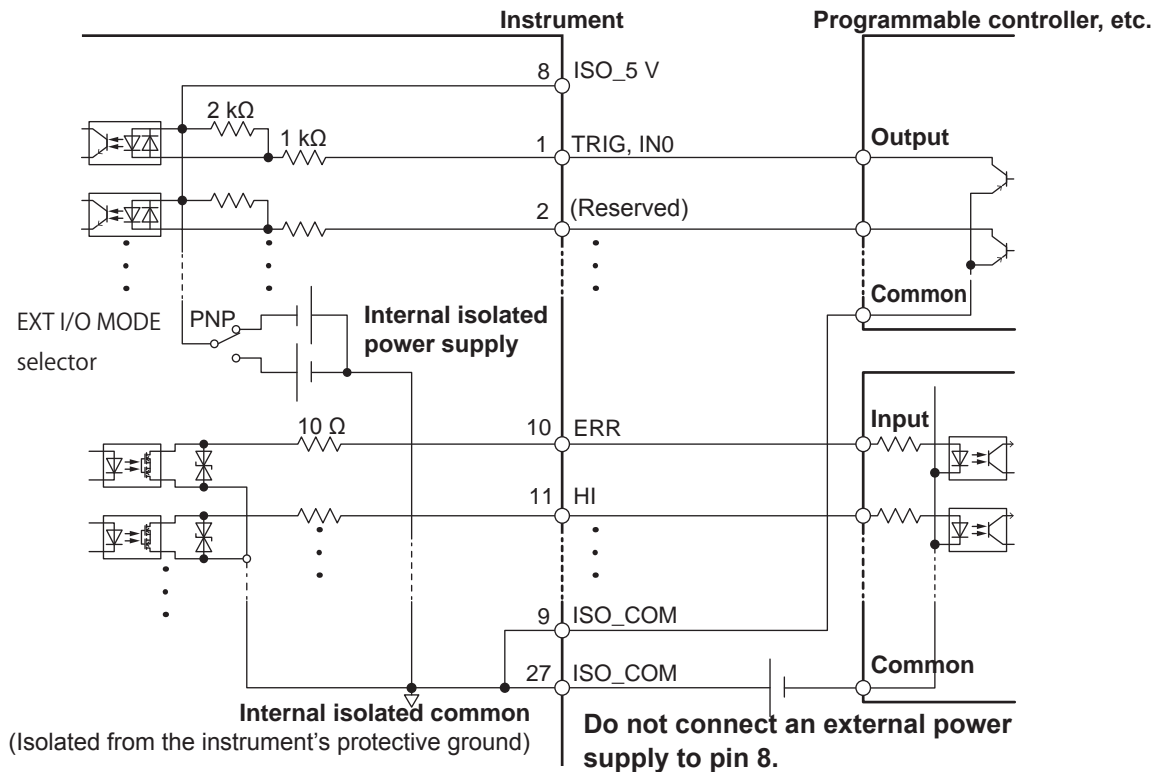

## Electrical specifications

<b>Input signals</b>	Input type	Photocoupler-isolated no-voltage contact input (current sink or current source)
	Input on	Residual voltage of 1 V or less, input on current of 4 mA (reference values)
	Input off	Open (interrupting current of 100 $\mu$ A or less)
<b>Output signals</b>	Output type	Photocoupler-isolated open drain output (non-polar)
	Maximum load voltage	30 V DC
	Maximum output current	50 mA/ch
	Residual voltage	1 V or less (load current of 50 mA) or 0.5 V or less (load current of 10 mA)
<b>Built-in isolated power supply</b>	Output voltage	Sink output: +5.0 V $\pm$ 0.8 V    Source output: -5.0 V $\pm$ 0.8 V
	Maximum output current	100 mA
	External power supply input	None
	Isolation	Floating from protective ground potential and measurement circuitry
	Insulation rating	50 V DC input-to-ground, 33 V AC rms, 46.7 V A peak or less

## Example connections

### Input circuitry

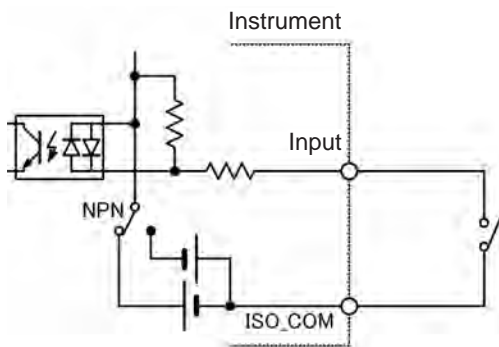

Connection to switch

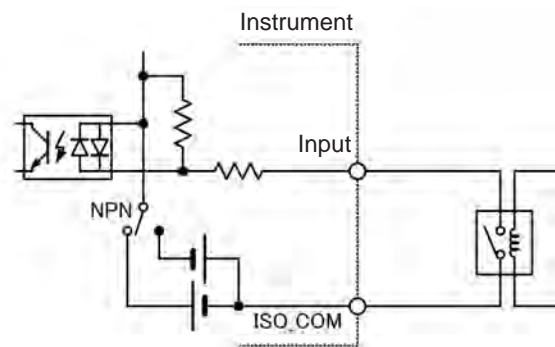

Connection to relay

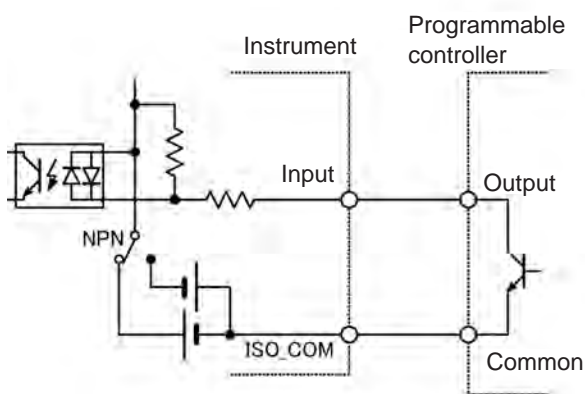

Connection to programmable controller (negative common output)

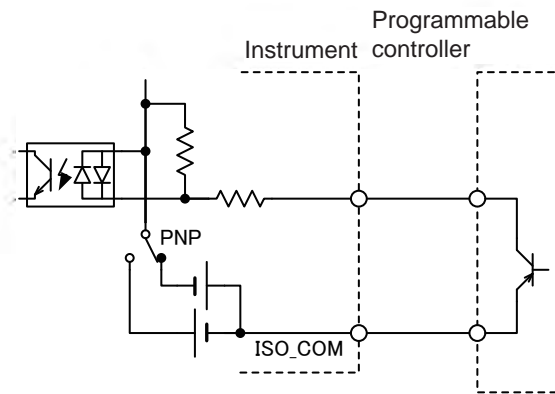

Connection to programmable controller (positive common output)

### Output circuitry

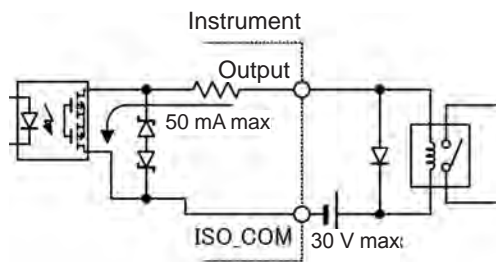

Connection to relay

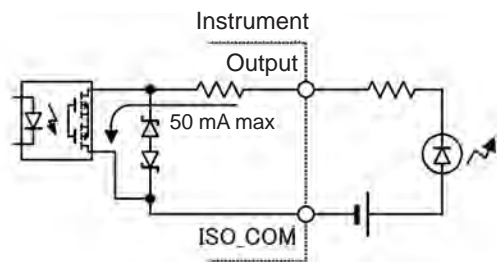

Connection to LED

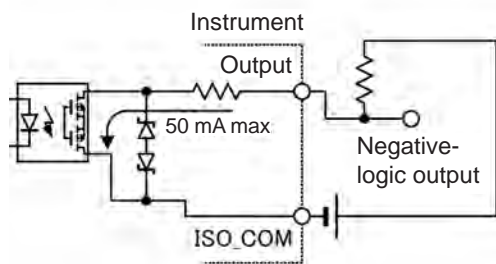

Negative-logic output

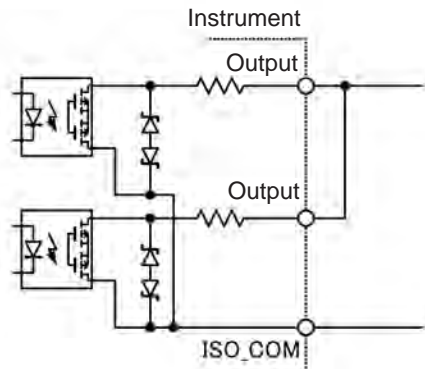

Wired or

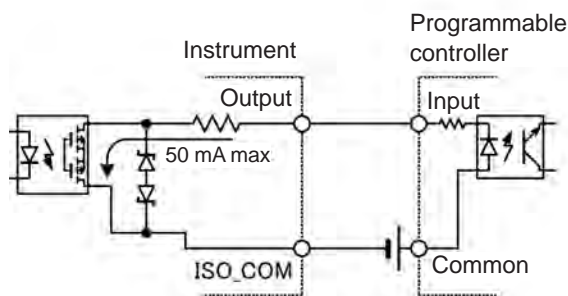

Connection to programmable controller (positive common input)

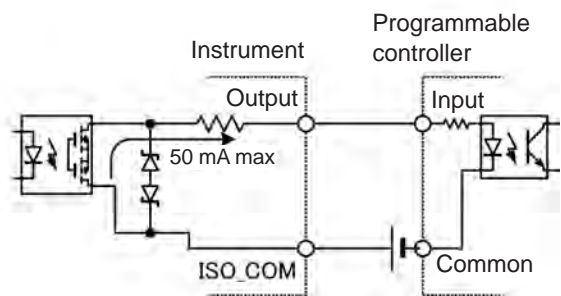

Connection to programmable controller (negative common input)

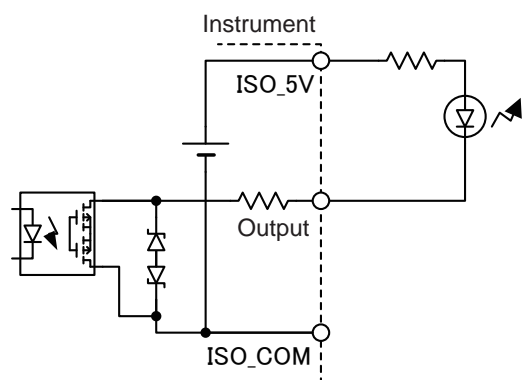

Connection to LED (using ISO\_5V, NPN setting)

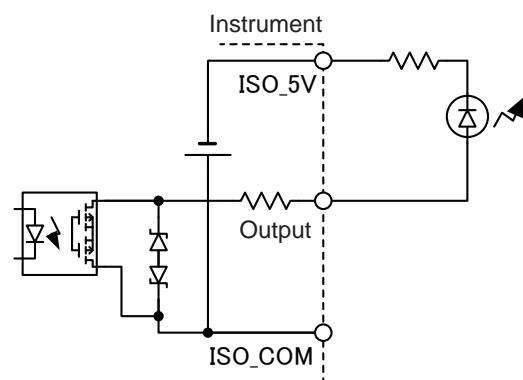

Connection to LED (using ISO\_5V, PNP setting)

# 11.4 Configuring External Input and Output

This section describes how to configure settings related to external input and output.

**Settings related to input**

- ▶ Trigger source: [EXTERNAL](#) p.39
- ▶ Input filter: p.136

**Settings related to output**

- ▶ “4.3 BIN Measurement (Using Multiple Judgment Standards)” (p.57)
- ▶ “6.3 Contact Check” (p.71)
- ▶ “EOM signal output type” (p.137)
- ▶ “12 Printing” (p.143)

## Input filter

The instrument’s filter function provides an effective way to eliminate chatter when connecting a foot switch or other device to the TRIG and PRINT signals.

(Measurement screen) **MENU > EXT I/O**

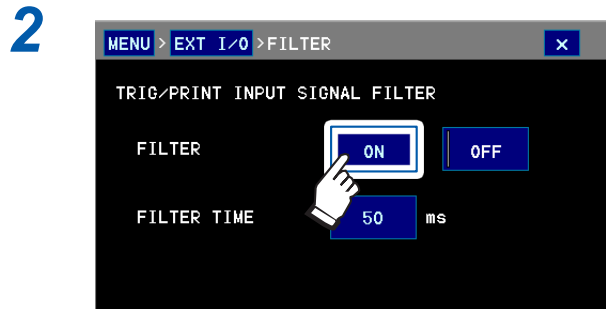
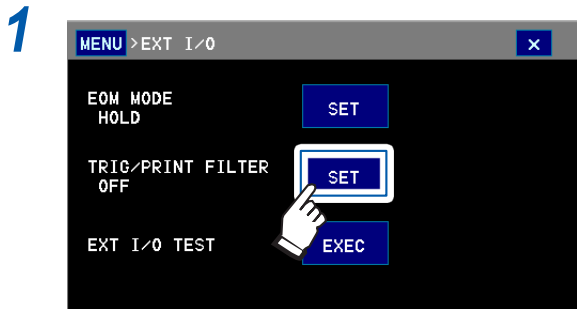

(Default setting: **OFF**)

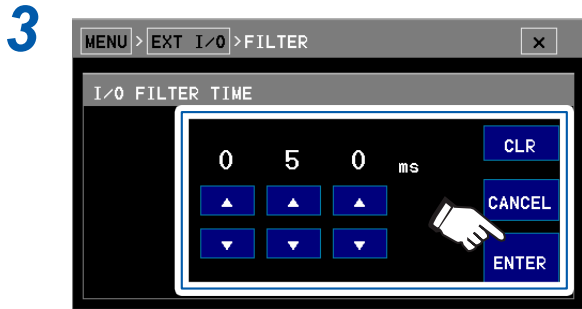

Set the response time and touch **ENTER**.

<b>▲</b>	Increases the value by 1.
<b>▼</b>	Decreases the value by 1.
<b>CLR</b>	Deletes all characters.
<b>CANCEL</b>	Cancels the setting and returns to the previous screen.

Valid setting range: 50 ms to 500 ms  
(Default setting: 50 ms)



### TRIG signal operation while the input filter is set to ON

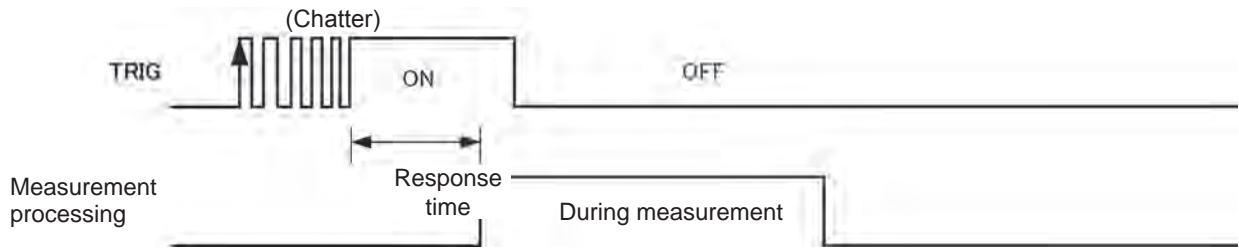

Hold the input signal until the response time has passed.

### EOM signal output type

You can choose to either hold the EOM signal's output until the next trigger is received or output the set pulse.

(Measurement screen) **MENU > EXT I/O**

1

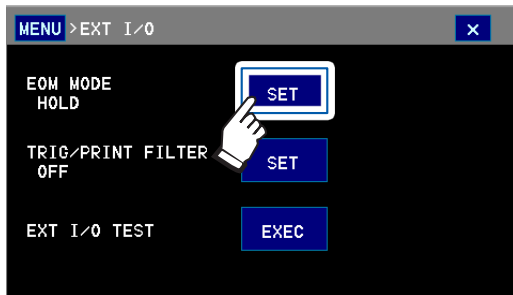

2

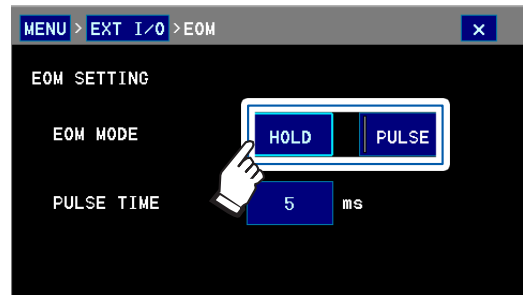

Select the output type.

**HOLD** Holds the EOM signal after measurement is complete (default setting).

**PULSE** Outputs a pulse with the set width after measurement is complete.

3

(After selecting **PULSE**)



Set the pulse width and touch **ENTER**.

**^** Increases the value by 1.

**v** Decreases the value by 1.

**CLR** Deletes all characters.

**CANCEL** Cancels the setting and returns to the previous screen.

Valid setting range: 1 ms to 100 ms  
(Default setting: 5 ms)

# 11.5 Input Test/Output Test

In addition to switching output signals on and off manually, you can view input signal status information on the instrument's screen.

(Measurement screen) **MENU > EXT I/O > EXT I/O TEST**

1

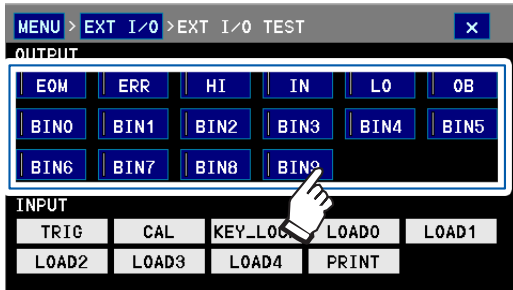

**Touch the signal you wish to output.**  
Check the connected device to verify that the signal is being output from the instrument.

2

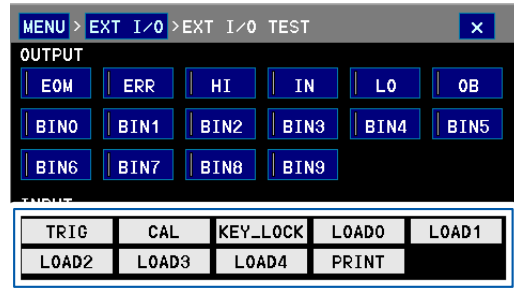

**Input a signal from the connected device.**  
The corresponding indicator will turn green to indicate the signal being input to the instrument.

## 11.6 Timing Chart

Each signal's level indicates whether the contact is in the on or off state. When using the current source (PNP) setting, the signal level will be the same as the EXT I/O connector's voltage level. When using the current sink (NPN) setting, the HI and LO voltage levels will be reversed.

11

External Control (EXT I/O)

### Timing from the start of measurement to acquisition of judgment results

#### Explanation of timing chart times

Symbol	Description	Time		
$T_0$	Time for which the TRIG signal is on	0.1 ms or greater		
$T_1$	Time for which the TRIG signal is off	1 ms or greater		
$T_2$	Trigger detection time	0.1 ms or less		
$T_3$	Contact check time	If contact check setting is: ON: Contact check integration time + 2 ms OFF: 0 ms		
$T_4$	Trigger delay time	0 to 9999 ms		
$T_5$	Acquisition time (external trigger)		50 Hz power	60 Hz power
		FAST (1 PLC)	27.2 ms	23.8 ms
		MEDIUM (10 PLC)	245 ms	205 ms
		SLOW (100 PLC)	3.92 sec.	3.37 sec.
		Other integration time: Integration time + 5.3 ms		
$T_6$	Acquisition time (internal trigger)		50 Hz power	60 Hz power
		FAST (1 PLC)	26.9 ms	23.5 ms
		MEDIUM (10 PLC)	245 ms	205 ms
		SLOW (100 PLC)	3.92 sec.	3.37 sec.
		Other integration time: Integration time + 5 ms		
$T_7$	Calculation time	0.1 ms		
$T_8$	Time from EOM signal output to next TRIG signal input	1 ms or greater		
$T_9$	EOM pulse width (external trigger)	1 ms to 100 ms		
$T_{10}$	EOM pulse width (internal trigger)	<p><b>50 Hz power frequency</b></p> $T_1 = 0.02 \text{ PLC to } 1 \text{ PLC: } 32.8 \text{ ms}$ $T_1 = 10 \text{ PLC, } 100 \text{ PLC: } 164 \text{ ms}$ $T_1 = \text{ms setting: } \text{INT}\{(T_1+39) \times 0.025\} \times 32.8$ <p><b>60 Hz power frequency</b></p> $T_1 = 0.02 \text{ PLC to } 1 \text{ PLC: } 29.4 \text{ ms}$ $T_1 = 10 \text{ PLC, } 100 \text{ PLC: } 147 \text{ ms}$ $T_1 = \text{ms setting: } \text{INT}\{(T_1+39) \times 0.025\} \times 29.4$ <p><math>T_1</math> : Integration time            INT (value): Integer portion of value after rounding down</p>		

**(1) When the trigger source is set to EXTERNAL and EOM output is set to HOLD**

Inputting the TRIG signal will cause the EOM signal to turn off and measurement to start. When measurement completes, the EOM signal will turn on and remain on until the next TRIG signal is input.

See “11 EOM signal output type” (p.137).

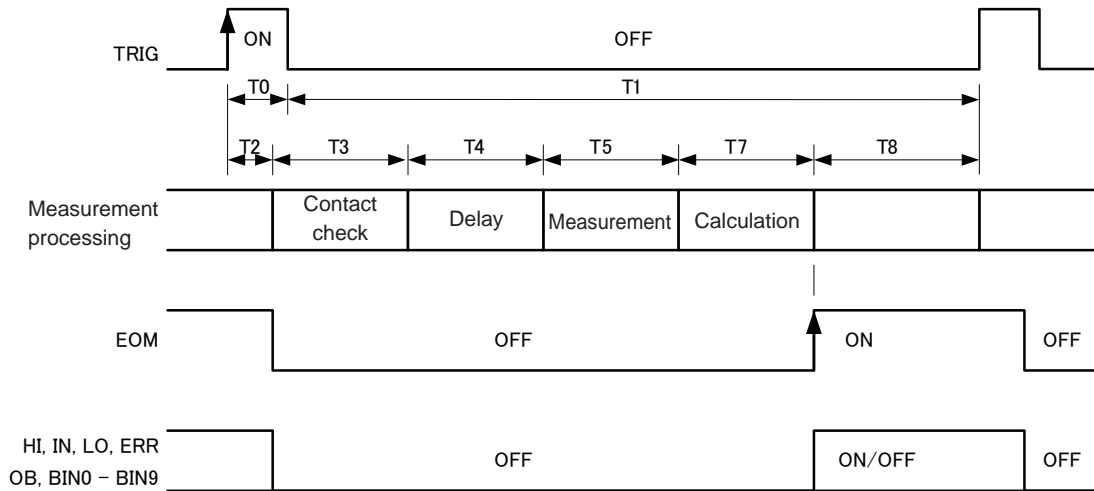

- The TRIG signal is ignored while the EOM signal is off (i.e., while measurement is in progress).
  - After changing settings, for example to switch ranges, allow processing time (100 ms) to elapse before inputting the TRIG signal.
  - The instrument will output the EOM signal as soon as the judgment result (HI, IN, LO, ERR, or BIN) has been finalized. If the connected external device’s input circuitry is characterized by a slow response, it may take time for the judgment result to be captured after the EOM signal is detected as having turned on.
- See “11 Measurement process (starting measurement from an external device and loading judgment results)” (p. 142).

**(2) When the trigger source is set to EXTERNAL and EOM output is set to PULSE**

The EOM signal will turn on when measurement completes. Once the EOM output pulse width (T9) has elapsed, the EOM signal will return to the off state. Inputting the TRIG signal while the EOM signal is on will cause the EOM signal to turn off and measurement to start.

See “EOM signal output type” (p. 137).

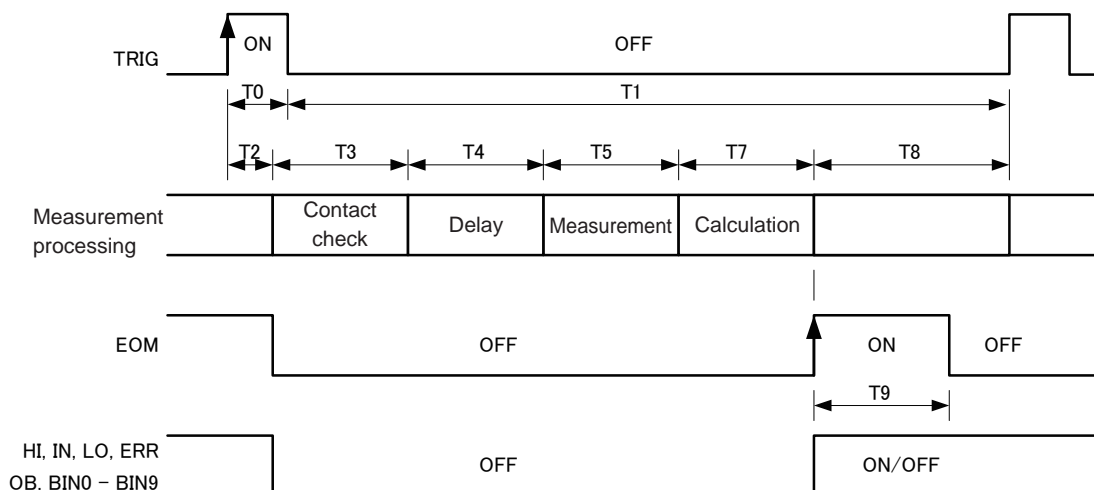

**(3) When the trigger source is set to INTERNAL while the instrument is in the RUN state**

The EOM signal will generate pulse output (with an output time measured in milliseconds). Once the HI, IN, LO, ERR, OB, or BIN0 to BIN9 signal turns on, it will remain on when measurement starts and will continue in that state until the next measurement completes.

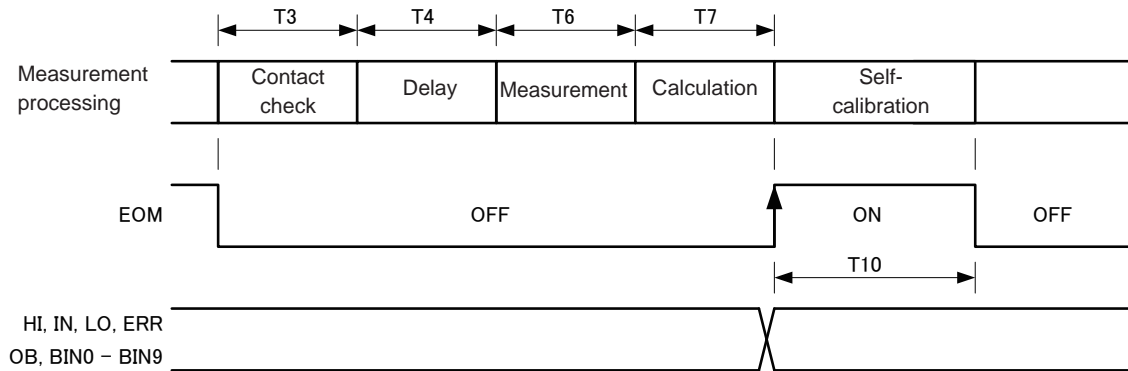

Measurement speed can be maximized with the following settings:

Setting		For more information
Contact check ( <b>CONTACT CHECK</b> )	<b>OFF</b>	"6.3 Contact Check" (p. 71)
Trigger delay ( <b>DELAY</b> )	<b>0 ms</b>	"Trigger measurement (measurement with user-specified timing)" (p.38)

In this case,  $t_{10} = 0$  ms.

**Panel load timing**

It is necessary to hold the LOAD signal for approximately 10 ms. The TRIG signal will be ignored while the panel load function is being completed.

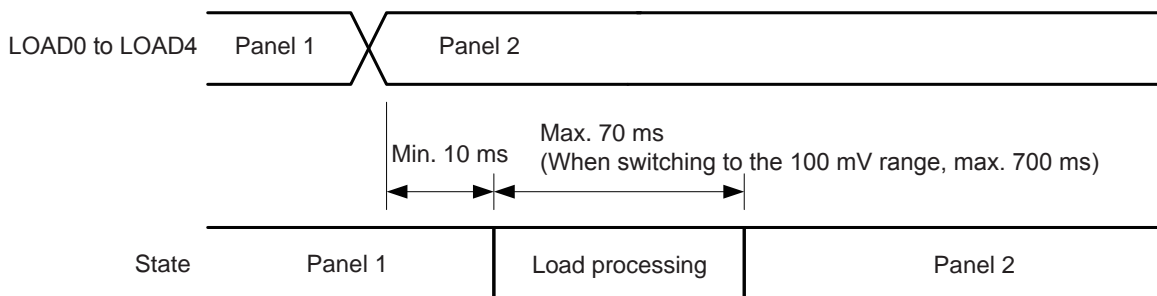

## Output signal status when the instrument is turned on

Once the display switches from the Startup screen to the Measurement screen after the instrument is turned on, the EOM signal will turn on. If EOM output is set to **PULSE**, the EOM signal will remain off.

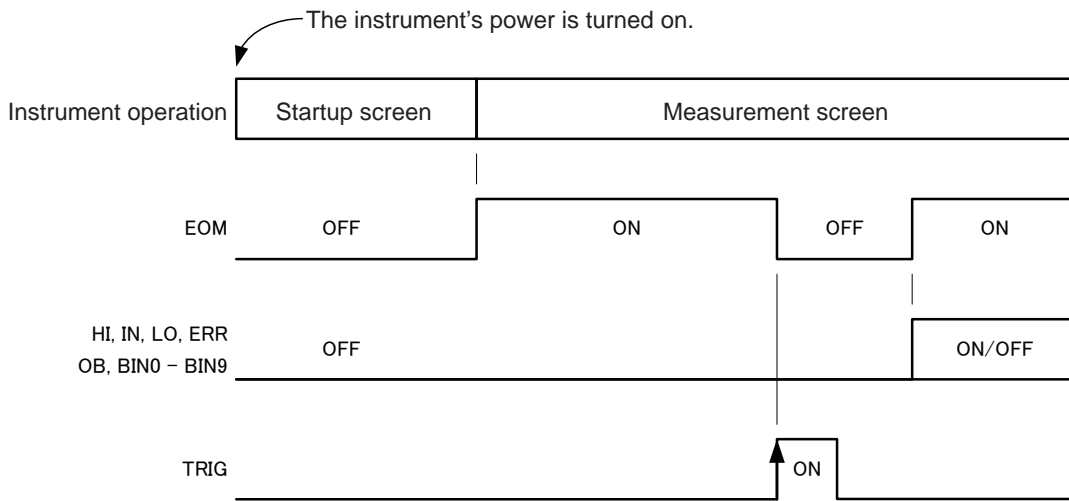

The above chart depicts instrument operation when the trigger source is set to **EXTERNAL** and EOM output is set to **HOLD**.

## Measurement process (starting measurement from an external device and loading judgment results)

This section describes the measurement process from the start of measurement to the acquisition of judgment results when inputting the trigger from an external device.

The instrument will output the EOM signal immediately once the judgment result (HI, IN, LO, ERR, or BIN) is finalized. If the connected external device's input circuitry is characterized by a slow response, it may take time for the judgment result to be captured after the EOM ON signal is detected.

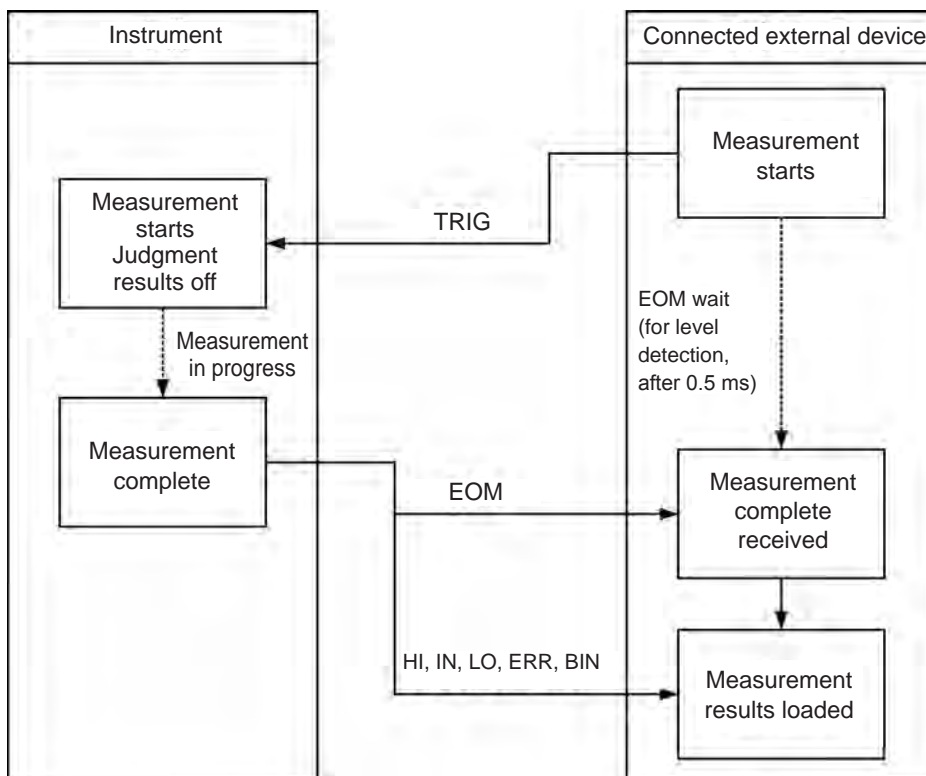

# 12 Printing

## Printing process

(1) Configure the printer. (p.144)



(2) Connect the printer to the instrument. (p.146)



(3) Configure the instrument. (p.146)



(4) Print (p.147)

- Measured values and judgment results
- List of measurement conditions and settings
- Statistical calculation results

12

Printing

## You will need:

9442 Printer

9443-01 AC Adapter (for Japan) or 9443-02 AC Adapter (for countries other than Japan)

1196 Recording Paper

9444 Connection Cable

- Use the optional 1196 Recording Paper (thermal paper, 10 rolls) or an equivalent product as printer paper.
- For more information about how to use the printer, see the instruction manual that came with it.

# 12.1 Printer Settings

**1** Turn off the 9442 Printer.

**2** Turn on the 9442 while holding down the **[ON LINE]** switch and release the switch once the printer starts printing.

The current settings will be printed. The following message will be printed after the settings:

Continue? :Push 'On-line SW'  
Write? :Push 'Paper feed SW'

**3** Press the **[ON LINE]** switch.  
The printer will print the message "Dip SW-1" and enter the software DIP SW1 setting state.

**4** Set DIP SW1 switch numbers 1 through 8 to on or off as indicated in the table below.

Example: Press the **[FEED]** switch to set the input method setting to SERIAL.

The input content will be printed each time you press the switch so that you can check the input results after each press. If you mistakenly enter the wrong setting, go back and repeat the process from Step 1.

Once you have finished setting switch No. 8, the following message will be printed again:

Continue? :Push 'On-line SW'  
Write? :Push 'Paper feed SW'

Set the parameters to the values indicated with check marks.

Switch no.	Function	ON (Press the <b>[ON LINE]</b> switch.)	OFF (Press the <b>[FEED]</b> switch.)
1	Input method setting	Parallel	Serial ✓
2	Print speed	Fast ✓	Slow
3	Auto-loading	Enable ✓	Disable
4	CR function	Carriage return	Line feed ✓
5	Setting command	Enable ✓	Disable
6	Print density (Set to 100%.)	-	OFF ✓
7		ON ✓	-
8		ON ✓	-



- 5** Set the DIP SW2 and DIP SW3 switches as described in the table below (see Steps 3 and 4).

Once you have finished setting DIP SW3 switch No. 8, the following message will be printed again:

Continue? :Push 'On-line SW'

Write? :Push 'Paper feed SW'

- 6** Press the [ON LINE] switch or the [FEED] switch.

This completes the configuration process, causing the following message to be printed:

Dip SW setting complete!!

### DIP SW2 settings

Set the parameters to the values indicated with check marks.

Switch no.	Function	ON (Press [ON LINE] switch.)	OFF (Press [FEED] switch.)
1	Print mode*	Normal print (40-row) ✓	Condensed print (80-row)
2	User-defined character backup	Enable ✓	Disable
3	Character type	Normal characters ✓	Special characters
4	Zero character	0 ✓	∅
5	International characters	ON ✓	-
6	Print density (Set to 100%.)	ON ✓	-
7		ON ✓	-
8		ON ✓	-

\* If you have configured time and date output as described in "9.3 Data Output Settings" (p.113), set to condensed print (80-row).

### DIP SW3 settings

Set the parameters to the values indicated with check marks.

Switch no.	Function	ON (Press [ON LINE] switch.)	OFF (Press [FEED] switch.)
1	No. of data bits	8 ✓	7
2	Parity	None ✓	Yes
3	Parity setting	Odd ✓	Even
4	Control flow	HW BUSY	XON/XOFF ✓
5	Baud rate (Set to 9600 bps.)	-	OFF ✓
6		ON ✓	-
7		ON ✓	-
8		ON ✓	-

## 12.2 Connecting the Printer to the Instrument

Before connecting, read “Before connecting a printer” (p. 12) carefully.

### Connection method

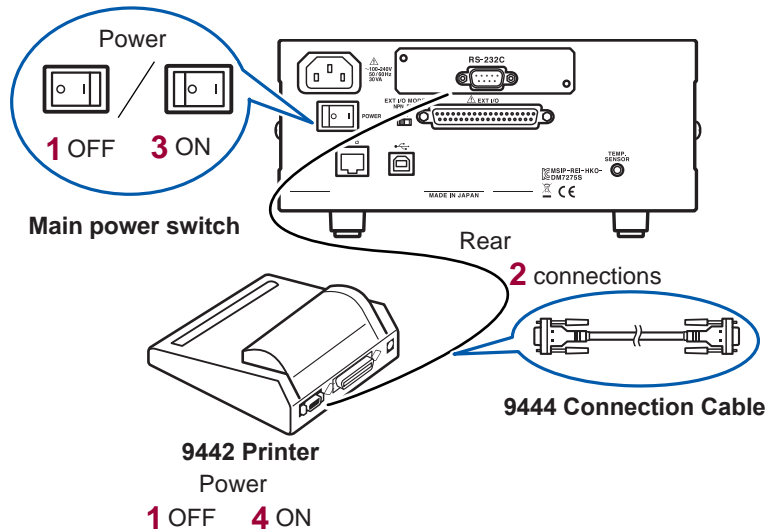

## 12.3 Configuring the Instrument

(Measurement screen) MENU > I/F

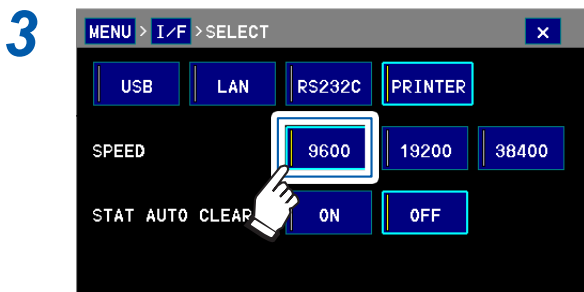
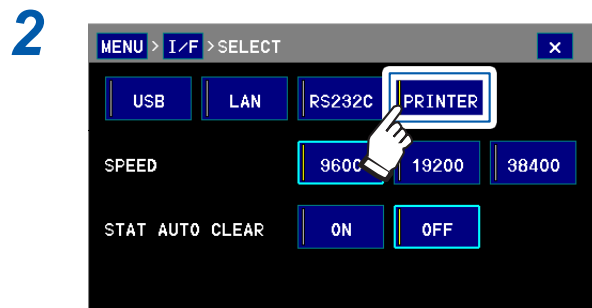
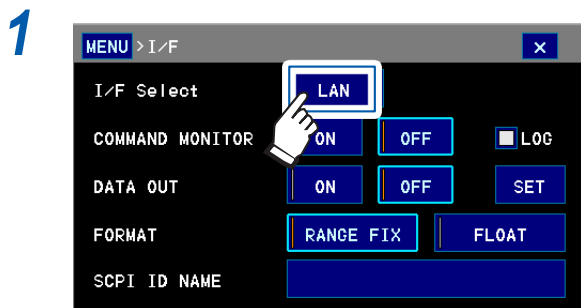

Select the same communications speed as the printer.

(Default setting: 9600 [bps])

## 12.4 Printing

Before printing, check the instrument's settings (p. 146) to be sure they are correct.

### Print parameters

The parameters that are set to be output as described in "9.3 Data Output Settings" (p. 113) will be printed. (Default setting: **V** [voltage value] only)

If the comparator function or BIN function is set to **ON**, judgment results will also be printed.

If you have configured the instrument to output the time and date, set the "DIP SW2 settings" (p. 145) print mode setting to condensed print (80-row).

### Output format

Printed data will conform to the format set as described in "7.8 Setting Output Formats" (p. 92).

### Printing from the instrument's touch panel

Touching **PRINT** will cause the data to be printed.

**To print measured values used in statistical calculations**  
See "Displaying, clearing, and printing statistical calculation results" (p. 85).

### Printing using external control

Turning the PRINT signal on with the instrument (by shorting the EXT I/O connector's ISO\_COM pin and PRINT pin) enables printing of measured values and judgment results.

#### To print data as desired

▶ Turn on the PRINT signal when you wish to print data.

#### To print after the completion of measurement using the trigger function

▶ Short the EOM signal with the PRINT signal before starting measurement. Then input the trigger while the trigger source is set to **EXTERNAL**. (p. 38)

#### To prevent print signal chatter

See "Input filter" (p. 136).

## Print examples

### ■ Voltage measured values, temperature measured values

- Voltage measured values

```
-1098.3825mV
- 0.05536mV
+ 199.6209mV
+ 395.2712mV
+ 998.5098mV
+1198.2109mV
+ 1.497850 V
NoCntct
+OvrRng
-OvrRng
```

- Voltage measured values, temperature measured values

```
- 0.04428mV ,+26.3C
+ 299.4894mV ,+26.3C
+1198.2750mV ,+26.3C
+ 1.497878 V ,+26.4C
NoCntct ,+26.4C
+OvrRng ,+26.4C
-OvrRng ,+26.4C
+ 898.7732mV ,-OvrRng
+ 898.7623mV ,+OvrRng
```

- Times, dates, and temperature measured values

```
2015/01/11 21:11:16 - 1.497762 V ,+26.4C
2015/01/11 21:11:22 - 998.6050mV ,+26.4C
2015/01/11 21:11:25 - 499.4504mV ,+26.4C
2015/01/11 21:11:28 - 0.07352mV ,+26.4C
2015/01/11 21:11:30 + 499.1823mV ,+26.4C
2015/01/11 21:11:33 + 998.5319mV ,+26.4C
2015/01/11 21:11:35 + 1.497883 V ,+26.4C
2015/01/11 21:12:25 NoCntct ,+26.4C
2015/01/11 21:12:39 +OvrRng ,+26.4C
2015/01/11 21:12:48 -OvrRng ,+26.4C
```

- Voltage measured values and temperature measured values (comparator on)

```
- 99.8674mV LO,+26.6C
+ 399.3989mV IN,+26.6C
+ 890.4667mV IN,+26.6C
+1098.4419mV HI,+26.6C
+OvrRng HI,+26.6C
```

- Times, dates, voltage measured values, and temperature measured values (comparator on)

```
2015/01/11 21:27:08 - 99.8460mV LO,+26.6C
2015/01/11 21:27:12 + 399.4024mV IN,+26.6C
2015/01/11 21:27:14 + 898.7182mV IN,+26.6C
2015/01/11 21:27:20 +1098.4661mV HI,+26.6C
2015/01/11 21:27:24 +OvrRng HI,+26.6C
2015/01/11 21:27:27 NoCntct ERR,+26.6C
```

- Voltage measured values and temperature measured values (BIN on)

```
- 99.8320mV OB,+26.8C
+ 99.8880mV 0 ,+26.9C
+ 199.7232mV 1 ,+26.8C
+ 399.4437mV 3 ,+26.8C
+ 599.1160mV 5 ,+26.9C
+ 798.8131mV 7 ,+26.9C
+ 998.6457mV 9 ,+26.9C
+1198.3677mV OB,+26.9C
+OvrRng OB,+26.9C
```

■List of measurement conditions and settings

```

MODEL          DM7276-03
FIRMWARE       V1.00
PRODUCT NO.    1234567890
MEASUREMENT    VOLT/C
RANGE          1000mV
SPEED          MEDIUM
TRIGGER        INTERNAL
CONTACT CHECK  ON
AUTO HOLD      OFF
INPUT Z        10MOhm
SMOOTHING      OFF
NULL           OFF
TC             OFF
SCALING        OFF
COMP           ON
  HI +1000.000mV
  LO +   0.000mV
BIN            OFF
DIGITS         7.5
    
```

■Statistical calculation results

- With comparator on

```

DATE - TIME 2015/01/11 23:32:08
NUM :117
VAL :100
Max :+1198.4368mV
  No = 64
Min : -299.46880mV
  No = 32
P-P :+1497.9056mV
Avg :+437.81887mV
Sn  :+367.66608mV
Sn-1:+369.51831mV
Cp  :0.45
Cpk :0.39
HI  :7
IN  :78
LO  :15
OVR :12
ERR :5
    
```

- With BIN on

```

DATE - TIME 2015/01/11 23:34:16
NUM :61
VAL :55
Max :+1198.0933mV
  No = 43
Min : -194.31234mV
  No = 17
P-P :+1392.4056mV
Avg :+520.12336mV
Sn  :+386.59372mV
Sn-1:+390.15687mV
BIN0 +100.0000mV - +   0.000mV 5
BIN1 +200.0000mV - +100.0000mV 3
BIN2 +300.0000mV - +200.0000mV 4
BIN3 +400.0000mV - +300.0000mV 3
BIN4 +500.0000mV - +400.0000mV 5
BIN5 +600.0000mV - +500.0000mV 1
BIN6 +700.0000mV - +600.0000mV 4
BIN7 +800.0000mV - +700.0000mV 12
BIN8 +900.0000mV - +800.0000mV 3
BIN9 +1000.0000mV - +900.0000mV 3
OB
    
```



# 13 Specifications

Scope: These specifications apply to the following products.

DM7275-01, DM7276-01 Precision DC Voltmeter

DM7275-02, DM7276-02 Precision DC Voltmeter (with GP-IB interface)

DM7275-03, DM7276-03 Precision DC Voltmeter (with RS-232C interface)

The information followed by “(-02 model)” is specific to the model DM7275-02 and DM7276-02 and the information followed by “(-03 model)” is specific to the model DM7275-03 and DM7276-03.

## 13.1 General Specifications

<b>Operating environment</b>	Indoors, Pollution Degree 2, altitude up to 2000 m (6562 ft.)
<b>Operating temperature and humidity</b>	0°C to 40°C (32°F to 104°F), 80% RH or less (no condensation)
<b>Storage temperature and humidity</b>	-10°C to 50°C (14°F to 122°F), 80% RH (no condensation)
<b>Standards</b>	<p><b>Safety:</b> EN61010</p> <p><b>EMC:</b> EN61326 Class A, EN61000-3-2, EN61000-3-3</p>
<b>Dielectric strength</b>	<p><b>Between [power supply L and N terminals] and [protective ground]:</b> 1500 V AC, 1 min. cutoff current of 10 mA</p> <p><b>Between [HIGH and LOW terminals] and [interface]:</b> 3600 V AC, 1 min. cutoff current of 10 mA</p> <p><b>Between [HIGH terminal and LOW terminal] and [protective ground]:</b> 2210 V AC, 1 min. cutoff current of 10 mA</p>
<b>Power supply</b>	<p><b>Rated supply voltage:</b> 100 V to 240 V AC commercial power (with fluctuations of ±10% relative to rated supply voltage) (predicted transient overvoltage: 2500 V)</p> <p><b>Rated power supply frequency:</b> 50 Hz/60 Hz</p> <p><b>Maximum rated power:</b> 30 VA</p>
<b>Backup battery service life</b>	Approx. 10 years (reference value at 23°C)
<b>Display</b>	Color 4.3" TFT with resistive membrane touch panel
<b>Keys</b>	V/°C, AUTO, ▲, ▼, SPEED, NULL, RUN/STOP, TRIG
<b>Buzzer</b>	At key entry and in response to comparator judgment results
<b>External interfaces</b>	<p><b>Interfaces:</b> Standard interfaces: LAN, USB host, USB device, EXT I/O Specified at time of order: GP-IB (-02 model), RS-232C (-03 model)</p> <p><b>Settings:</b> LAN / USB host (flash drive) / USB device (COM/Keyboard) / GP-IB (-02 model) / RS-232C (-03 model) / Printer (-03 model) (The USB host function can be used as long as the USB device setting is not being used.)</p> <p><b>Default settings:</b> USB host, LAN</p>
<b>Dimensions</b>	Approx. 215W × 88H × 232D mm (8.46"W × 3.46"H × 9.13"D) (excluding protruding parts)

<b>Mass</b>	<b>DM7275-01, DM7276-01:</b> Approx. 2.3 kg (81.1 oz.) <b>DM7275-02, DM7275-03, DM7276-02, DM7276-03:</b> Approx. 2.4 kg (84.7 oz.)
<b>Product warranty</b>	1 year
<b>Accessories</b>	See “Accessories” (p.2).
<b>Options</b>	See “Options (Sold Separately)” (p.3).

## 13.2 Measurement Specifications

### Basic specifications

<b>Measurement parameters</b>	DC voltage, temperature
<b>Measurement ranges</b>	<b>DC voltage:</b> ±120.000 00 mV (100 mV range) to ±1010.000 0 V (1000 V range) 5 ranges <b>Temperature:</b> -10.0°C to 60.0°C
<b>Maximum input voltage</b>	Voltage measurement terminals 1000 V DC (between HIGH and LOW terminals), 10 <sup>5</sup> VHz AC, 1500 Vpk However, measurement target must be isolated from ground when measuring voltages in excess of 800 V.
<b>Maximum rated input-to-ground voltage</b>	Voltage measurement terminals 800 V (predicted transient overvoltage: 3000 V between input and ground) Measurement category: II 300 V (predicted transient overvoltage: 2500 V between input and ground)
<b>Measurement methods</b>	<b>Voltage measurement:</b> ΣΔ conversion method <b>Temperature measurement:</b> Temperature Sensor Z2001
<b>Measurement terminals</b>	<b>Voltage measurement terminals:</b> Banana-style receptacles, at least 99.9% copper <b>Temperature measurement terminal</b> φ3.5 compact jack



**Noise rejection ratio  
(Voltage measurement)**

**CMRR:**  
 Signal source resistance: 1 kΩ  
 DC CMRR: 140 dB or greater  
 AC CMRR: 100 dB or greater (±1% of supplied power supply frequency, integration time of n × PLC setting)  
 (n: integer value; PLC: power line cycle)

**NMRR:**

Integration time setting	Power supply frequency setting ±0.1%	Power supply frequency setting ±1%
100PLC	120 dB or greater	100 dB or greater
10PLC	120 dB or greater	100 dB or greater
1PLC	55 dB or greater	35 dB or greater
Less than 1PLC	0 dB	0 dB

(PLC: power line cycle)

**Input bias current (25°C)  
(Voltage measurement)**

**100 mV range, 1 V range:**  
 Max. 30 pA  
**10 V range:**  
 Max. 50 pA  
**100 V range, 1000 V range:**  
 Max. 10 pA

**Common-mode current**

10 nA rms (reference value)

**Measurement times**

**Voltage measurement:**  
 RUN state: Single measurement time of T<sub>3</sub> + T<sub>4</sub> + T<sub>6</sub> + T<sub>7</sub> + T<sub>10</sub>  
 (tolerance of ±10% ±0.2 ms)  
 Other than RUN state: From trigger input until EOM turns on: T<sub>2</sub> + T<sub>3</sub> + T<sub>4</sub> + T<sub>5</sub> + T<sub>7</sub>  
 (tolerance of ±10% ±0.2 ms)  
 For an explanation of T<sub>0</sub> to T<sub>10</sub>, see “Separate table” (p.153).  
**Temperature measurement:**  
 200 ±20 ms (measured value update timing depends on the voltage measurement time)

**Separate table**

Parameter	Description	Time		
T <sub>0</sub>	Trigger signal on-time	0.1 ms or greater		
T <sub>1</sub>	Trigger signal off-time	1 ms or greater		
T <sub>2</sub>	Trigger detection time	0.1 ms or less		
T <sub>3</sub>	Contact check time	<ul style="list-style-type: none"> <li>• Off setting: 0 ms</li> <li>• On setting: Contact check integration time + 2 ms</li> </ul>		
T <sub>4</sub>	Delay time	0 ms to 9999 ms		
T <sub>5</sub>	Acquisition time (other than RUN state)		50 Hz power	60 Hz power
		FAST (1PLC)	27.2 ms	23.8 ms
		MEDIUM (10PLC)	245 ms	205 ms
		SLOW (100PLC)	3.92 s	3.37 s
		Integration time other than above: Integration time + 5.3 ms		

Parameter	Description	Time		
T <sub>6</sub>	Acquisition time (RUN state)		50 Hz power	60 Hz power
		FAST (1PLC)	26.9 ms	23.5 ms
		MEDIUM (10PLC)	245 ms	205 ms
		SLOW (100PLC)	3.92 s	3.37 s
		Integration time other than above: Integration time + 5 ms		
T <sub>7</sub>	Calculation time	0.1 ms		
T <sub>8</sub>	From EOM signal output to TRIG signal input	1 ms or greater		
T <sub>9</sub>	EOM pulse width (other than RUN state)	1 ms to 100 ms		
T <sub>10</sub>	EOM pulse width (RUN state)	<p><b>50 Hz power frequency</b>  <math>T_I=0.02\text{PLC to }1\text{PLC: }32.8\text{ ms}</math>  <math>T_I=10\text{PLC, }100\text{PLC: }164\text{ ms}</math>  <math>T_I=\text{ms setting INT}\{(T_I+39)\times 0.025\}\times 32.8</math></p> <p><b>60 Hz power frequency</b>  <math>T_I=0.02\text{PLC to }1\text{PLC: }29.4\text{ ms}</math>  <math>T_I=10\text{PLC, }100\text{PLC: }147\text{ ms}</math>  <math>T_I=\text{ms setting INT}\{(T_I+39)\times 0.025\}\times 29.4</math></p> <p><math>T_I</math> : Integration time                      INT (value): Rounds off the decimal portion of the value.</p>		

## Accuracy specifications

<b>Conditions of guaranteed accuracy</b>	<p><b>Guaranteed accuracy period:</b> 1 year</p> <p><b>Temperature and humidity for guaranteed accuracy:</b> 23°C ±5°C (73°F ±9°F), 80% RH or less</p> <p><b>Warm-up time:</b> 1 hr.</p> <p><b>Measurement cable</b> Low thermal electromotive force cable (FLUKE 5440A-7005)</p>
------------------------------------------	-------------------------------------------------------------------------------------------------------------------------------------------------------------------------------------------------------------------------------------------------------------------------------------------

<b>Voltage measurement accuracy</b>	<p><b>DM7275-01, DM7275-02, DM7275-03:</b> See "Separate table 1 (DM7275)" (p. 156).</p> <p><b>DM7276-01, DM7276-02, DM7276-03:</b> See "Separate table 2 (DM7276)" (p. 156).</p>
-------------------------------------	-------------------------------------------------------------------------------------------------------------------------------------------------------------------------------------------

**Additional errors:**

- Temperature coefficient  
From 0°C to 18°C and from 28°C to 40°C, add the following value per 1°C of temperature:  
100 mV to 10 V range: ±0.05 × measurement accuracy/°C  
100 V, 1000 V range: ±0.1 × measurement accuracy/°C
- Voltage coefficient error  
Add the following value to the rdg. error component if the voltage display value Vin exceeds ±300 V:  
DM7275: 0.0010% × (Vin / 1000)<sup>2</sup>  
DM7276: 0.0005% × (Vin / 1000)<sup>2</sup>
- Noise error (excluding effects of burst noise)

Integration time T <sub>I</sub>	Additional error
10 PLC ≤ T <sub>I</sub>	None
1 PLC ≤ T <sub>I</sub> < 10 PLC	0.0001% of range ± 0.5 μV
0.2 PLC ≤ T <sub>I</sub> < 1 PLC	0.0003% of range ± 1 μV
0.02 PLC ≤ T <sub>I</sub> < 0.2 PLC	0.0010% of range ± 2 μV

- Temperature compensation error  
When using temperature compensation, add the following value to the resistance measurement accuracy's rdg. error component:

$$\frac{-\alpha\Delta T}{1 + \alpha \times (T + \Delta T - T_0)} \times 100[\%]$$

T<sub>0</sub>: Reference temperature [°C]                      T: Current ambient temperature [°C]  
 ΔT: Temperature measurement accuracy    α: Temperature coefficient [1/°C]

- Measurement cable error  
Temperature difference of no greater than 1°C between the instrument and the measurement cable/measurement target  
Add individual error components if connecting cables in series.

L9207-10 Test Lead		
L4933	Contact Pin Set	10 μV
L4932	Test Pin Set	
L4934	Small Alligator Clip Set	7 μV
L4935	Alligator Clip Set	
9243	Grabber Clip	5 μV
L4936	Bus Bar Clip Set	
L4931	Extension Cable Set	3 μV
L4930	Connection Cable Set	2 μV

- Effects of radiative radio-frequency magnetic field: 3% of range at 10 V/m
- Effects of conductive radio-frequency magnetic field: 3% of range at 3 V

**Linearity:**

Linearity is already included in the voltage measurement accuracy and need not be added again.

$|V_{in}| \leq 300 \text{ V}$ : 0.0001% rdg. + 0.0001% f.s.

$|V_{in}| > 300 \text{ V}$ : 0.0001% rdg. + 0.0001% f.s. + voltage coefficient error

**Temperature measurement accuracy**

Accuracy specifications		Accuracy
Instrument accuracy	-10.0°C to 60.0°C	±0.2°C
Combined accuracy with Z2001	-10.0°C to 4.9°C	±0.7°C
	5.0°C to 35.0°C	±0.5°C
	35.1°C to 50.0°C	±0.7°C
	50.1°C to 60.0°C	±0.9°C

**Separate table 1 (DM7275)**

Range	Maximum display*	Maximum resolution	Measurement accuracy	Input resistance	
				AUTO	10 MΩ
100 mV	±120.000 00 mV	10 nV	±0.0030% rdg. ±2 μV	>10 GΩ	10 MΩ ±1%
1000 mV	±1200.000 0 mV	100 nV	±0.0020% rdg. ±3 μV	>10 GΩ	10 MΩ ±1%
10 V	±12.000 000 V	1 μV	±0.0020% rdg. ±12 μV	>10 GΩ	10 MΩ ±1%
100 V	±120.000 00 V	10 μV	±0.0030% rdg. ±0.8 mV	10 MΩ ±1%	10 MΩ ±1%
1000 V	±1010.000 0 V	100 μV	±0.0035% rdg. ±2 mV	10 MΩ ±1%	10 MΩ ±1%

\*Maximum input voltage: 1000 V peak

**Separate table 2 (DM7276)**

Range	Maximum display*	Maximum resolution	Measurement accuracy	Input resistance	
				AUTO	10 MΩ
100 mV	±120.000 00 mV	10 nV	±0.0015% rdg. ±2 μV	>10 GΩ	10 MΩ ±1%
1000 mV	±1200.000 0 mV	100 nV	±0.0011% rdg. ±3 μV	>10 GΩ	10 MΩ ±1%
10 V	±12.000 000 V	1 μV	±0.0009% rdg. ±12 μV	>10 GΩ	10 MΩ ±1%
100 V	±120.000 00 V	10 μV	±0.0020% rdg. ±0.8 mV	10 MΩ ±1%	10 MΩ ±1%
1000 V	±1010.000 0 V	100 μV	±0.0025% rdg. ±2 mV	10 MΩ ±1%	10 MΩ ±1%

\*Maximum input voltage: 1000 V peak

**Example calculation of voltage measurement accuracy**

Instrument: DM7276

Display value: 500 V

Measurement conditions: 1000 V range, integration time of 1 PLC, L9207-10 Test Lead

From Separate Table 2 (1000 V range)  $0.0025\% \times 500 \text{ V} + 2 \text{ mV} = 14.5 \text{ mV}$   
 Voltmeter coefficient error (see previous page)  $0.0005\% \times (500 \text{ V} / 1000 \text{ V})^2 \times 500 \text{ V} = 0.625 \text{ mV}$   
 Noise error (see previous page)  $0.0001\% \times 1000 \text{ V} + 0.5 \text{ μV} = 1.0005 \text{ mV}$   
 Measurement cable error (see previous page) 10 μV

Total error  $14.5 \text{ mV} + 0.625 \text{ mV} + 1.0005 \text{ mV} + 10 \text{ μV} = 16.1355 \text{ mV}$

After truncating digits that exceed the instrument's display digits, 16.1 mV

## 13.3 Functional Specifications

<b>Display measured values</b>	Settings	V, V°C	
	Default setting	V	
<b>Range switching</b>	Settings	AUTO, MANUAL	
	Default setting	AUTO	
<b>Input resistance switching</b>	Settings	10 MΩ, AUTO (100 V range and 1000 V range: fixed at 10 MΩ)	
	Default setting	10 MΩ	
<b>Display digit selection</b>	Settings	7 1/2 digits, 6 1/2 digits, 5 1/2 digits, 4 1/2 digits, 3 1/2 digits	
	Default setting	7 1/2 digits	
<b>Integration time</b>	Setting	Integration time unit: PLC, ms PLC setting range: 0.02, 0.2, 1, 10, 100 ms setting range: 1 ms to 9999 ms	
	Preset integration times	FAST: 1 PLC MEDIUM: 10 PLC SLOW: 100 PLC	
	Default setting	MEDIUM (10 PLC)	
<b>Smoothing function</b>	Operation	Displays the moving average of measured values in the RUN state.	
		$V_{smooth} = \frac{1}{A} \sum_{k=n}^{n+A-1} V_k$ <p> <math>V_{smooth}</math>: Average value    <math>A</math>: Number of averaging iterations  <math>n</math>: Number of measurements    <math>V_k</math>: <math>k^{\text{th}}</math> measured value </p>	
	Settings	Smoothing: ON, OFF Number of averaging iterations: 2 to 100	
	Default settings	Smoothing: OFF; number of averaging iterations: 4	
<b>Triggers</b>	<b>Continuous measurement</b>	Settings	RUN, STOP When set to STOP, single trigger from <b>[TRIG]</b> key
		Default setting	RUN
<b>Trigger source</b>	Setting	INTERNAL, EXTERNAL When using the EXTERNAL setting, TRIG signal input and <b>[TRIG]</b> key input are each treated as one trigger event.	
	Default setting	INTERNAL	
<b>Number of measurements</b>	Setting	1 per trigger to 5000 per trigger (Disabled when in the RUN state)	
	Default setting	1 per trigger	
<b>Delay</b>	Settings	Delay: PRESET, MANUAL PRESET time: 0 ms MANUAL time: 0 ms to 9999 ms	
	Default settings	Delay: PRESET; MANUAL time: 0 ms	
<b>NULL</b>	Calculation formula	$V_M = V - V_N$ $V_M$ : Measured value after NULL calculation $V$ : Voltage measured value $V_N$ : NULL value	
	Settings	NULL: ON, OFF NULL value: -1000 V to +1000 V (non-range-dependent value, acquired from current measured value or set as desired)	
	Default settings	NULL: OFF; NULL value: 0 V	

<b>Temperature compensation</b>	Calculation formulas	$V_{T_0} = V_M / (1 + \alpha (T - T_0))$ $V_{T_0}$ : Measured value after temperature compensation $V_M$ : Voltage measured value after NULL calculation $T$ : Temperature $\alpha$ : Temperature coefficient [ppm/°C] $T_0$ : Reference temperature
	Settings	Temperature compensation: ON, OFF Temperature coefficient: -1000 ppm/°C to +1000 ppm/°C Reference temperature: -10.0°C to 60.0°C
	Default settings	Temperature compensation: OFF Temperature coefficient: 0 [ppm/°C] Reference temperature: 20°C
<b>Scaling</b>	Calculation formulas	$V_S = A \times V_{T_0} + B$ $V_S$ : Value after scaling $V_{T_0}$ : Value after NULL calculation and temperature compensation $A$ : Gain coefficient $B$ : Offset
	Settings	Scaling: ON, OFF $A$ : 0 to $\pm 1.000\,000 \times 10^9$ $B$ : 0 to $\pm 1.000\,000 \times 10^9$ Unit: V, none, 3 characters as desired (not including SI prefixes) SI prefixes are automatically adjusted so that the integer portion of ( $A \times$ maximum display before scaling + $ B $ ) is from 2 to 4 digits long. Example: For 10 V range, $A = 1.5 \times 10^5$ , $B = -0.5 \times 10^3$ , $1.5 \times 10^5 \times 12 + 0.5 \times 10^3 = 1800\,500$ After adjustment so that the integer portion is from 2 to 4 digits long: 1800.500k → SI prefix is “k.”
	Default settings	Scaling: OFF $A$ : 1 $B$ : 0 Unit: V
<b>Over range indication</b>	An over range is indicated under the following conditions: <ul style="list-style-type: none"> <li>• When the measurement range is exceeded</li> <li>• When A/D converter input during measurement exceeds the input range</li> <li>• When the temperature compensation, NULL calculation or scaling results exceed the display range</li> </ul>	
<b>Contact check</b>	Operation	<ul style="list-style-type: none"> <li>• When the capacitance between HIGH and LOW terminals is less than the threshold, no detection is made, and no measured value is displayed.</li> <li>• On the contact check settings screen, the capacitance between the HIGH and LOW terminals can be monitored (monitor range: 0 nF to 60 nF [reference values]).</li> <li>• This function cannot be used in the 100 V or 1000 V range.</li> </ul>
	Detection signal	10 mV rms (reference value)
	Settings	Contact check: ON, OFF Threshold: 0.5 nF to 50 nF (reference values) Contact check integration time: 1 ms to 100 ms
	Default settings	Contact check: OFF Threshold: 1 nF Contact check integration time: 10 ms
<b>Self-calibration</b>	Operation	Self-calibration corrects for fluctuations in the measurement circuit. It cannot be disabled.

<b>Comparator</b>	Operation	<p><b>Judgment:</b>            HIGH judgment: Measured value &gt; upper limit value            IN judgment: Upper limit value <math>\geq</math> measured value <math>\geq</math> lower limit value            LOW judgment: Lower limit value &gt; measured value</p> <p><b>Judgment delay:</b>            Outputs judgment results once the same judgment has been made the set number of times. This setting is valid only when auto-hold operation is disabled and the instrument is in the RUN state.</p>
	Settings	<p>Comparator: ON, OFF (BIN: forced OFF)            Upper limit value and lower limit value: -1000 V to +1000 V (when the scaling function is set to ON, -1000 GV to 1000 GV), ON, OFF            (IN judgment when both the upper and lower limit values are set to OFF.)            Number of setting digits: 7            Judgment delay: ON, OFF            Judgment delay count: 2 to 10            Judgment tone: OFF, TYPE1, TYPE2, TYPE3            Number of beeps: 1 to 5, continuous</p>
	Default settings	<p>Comparator: OFF            Upper limit value and lower limit value: 0 V, ON            Judgment delay: OFF, 2            HIGH judgment tone: OFF            IN judgment tone: OFF            LOW judgment tone: OFF            Number of beeps: 2</p>
<b>BIN</b>	Judgment	<p>BIN nos. 0 to 9 (Out of BINs)            IN judgment: Upper limit value <math>\geq</math> measured value <math>\geq</math> lower limit value            OUT judgment: Lower limit value &gt; measured value, measured value &gt; upper limit value</p>
	Settings	<p>BIN: ON, OFF (COMP: forced OFF)            Upper limit value and lower limit value: -1000 V to +1000 V (when the scaling function is set to ON, -1000 GV to +1000 GV)            Number of setting digits: 7</p>
	Default settings	<p>BIN: OFF            Upper limit value and lower limit value: 0 V</p>
<b>Absolute value judgment</b>	Operation	Performs comparator judgment or BIN judgment while ignoring the sign of the measured value.
	Settings	Absolute value judgment: ON, OFF
	Default settings	Absolute value judgment: OFF
<b>Auto hold</b>	Operation	<p>Automatically holds the measured value when it falls within the hold range.            Measurement settings are fixed as follows:            Integration time: MEDIUM; input resistance: 10 M<math>\Omega</math>            Continuous measurement: RUN; contact check: ON</p>
	Settings	<p>Auto hold: ON, OFF            Hold range: 0.001% of the range to 1.000% of the range</p>
	Default settings	<p>Auto hold: OFF            Hold range: 0.1% of range</p>

<b>Panel save and panel load operation</b>	Number of panels	30
	Saved information	Time and date of save, measured value display, measurement range selection, input resistance selection, number of display digits, integration time, smoothing, trigger setting (measurement count, delay), NULL, temperature compensation, scaling, contact check, comparator, BIN, absolute value judgment, auto hold, label display, sub-display
	Panel name	User-defined, 10 characters
	Setting	NULL value save: ON, OFF
	Default setting	NULL value save: ON
<b>Label display</b>	Settings	Label display: ON, OFF Label: User-defined, 8 characters
	Default settings	Label display: OFF Label: none
<b>Measured value memory</b>	Display items	5000
	Memory contents	Elapsed time, voltage, temperature
<b>Sub-display</b>	Number of data points	Statistics, trend, bar graph
	Default setting	No sub-display
	Statistics	<b>Number of data points:</b> Statistics calculations: 1,000,000 data points (automatic stop) <b>Description of statistics:</b> Maximum value (index number), minimum value (index number), maximum value - minimum value, average value, sample standard deviation, population standard deviation, total number of data points, number of valid data points <ul style="list-style-type: none"> <li>• When the comparator is on Count for each judgment result, process capacity index</li> <li>• When BIN is on Count for each BIN number, "Out of BINs" count</li> </ul>
	Trend	Displays data in the instrument's measured value memory as a trend graph.
	Bar graph	Displays measured values as a bar graph.
<b>Data output</b>	Operation	<ul style="list-style-type: none"> <li>• Outputs data to the USB COM, USB keyboard, RS-232C, printer, or LAN interface. RUN state: Inputting the TRIG signal or pressing the <b>[TRIG]</b> key causes the current measured value to be output. Other than RUN state: Inputting the TRIG signal or pressing the <b>[TRIG]</b> key causes the measured value to be output once measurement completes. Auto-hold setting: The measured value is output while being held.</li> <li>• Data cannot be output to the GP-IB interface.</li> </ul>
	Settings	Automatic data output: ON, OFF Output at detection: ALL, HI, IN, LO, HL Data output format Measurement data: V, V°C Time and date: ON, OFF
	Default settings	Automatic data output: OFF Output at detection: ALL Measurement data: V Time and date: OFF



<b>Key lock</b>	Operation	When set from the front panel, all operations other than the cancellation key are disabled. Operation of the front panel is disabled while the KEY_LOCK signal is being input and while a valid LOAD signal is being input. The <b>[TRIG]</b> key functions while the key lock is engaged.
	Setting	ON, OFF
	Default setting	OFF
<b>Backlight</b>	Setting	Brightness: 0% to 100% (in 10% steps)
	Default setting	Brightness: 80%
<b>Clock</b>	Auto calendar, automatic detection of leap years, 24-hour format	
	Clock accuracy	±4 min/month
	Default state	00:00, January 1, 2015
<b>Supplied power supply frequency</b>	Settings	50 Hz, 60 Hz, AUTO
	Default setting	AUTO
<b>Output format</b>	Setting	Date: YYYYMMDD, DDMMYYYY, MMDDYYYY Date delimiter: Slash, hyphen, period Decimal point: Period, comma Data delimiter: Comma, semicolon, tab, space (Setting applies to screen display, USB flash drive output, USB keyboard output, and printer output.)
	Default settings	Date: YYYYMMDD Date delimiter: Slash Decimal point: Period Data delimiter: Comma
<b>Self-test</b>	ROM test, RAM test	
<b>Buzzer</b>	Settings	Volume: OFF, SMALL, MEDIUM, LARGE Key tone: ON, OFF Auto-hold tone: ON, OFF Error tone: ON, OFF
	Default settings	Volume: MEDIUM Key tone: ON Auto-hold tone: ON Error tone: ON
<b>Touch panel adjustment</b>	Adjusts for touch panel misalignment by setting the location of the top left and bottom right corners of the touch panel. The settings can be reverted to their factory defaults.	
<b>Measurement information</b>	Displayed information	Displays instrument settings.
<b>Communications monitor</b>	Operation	<ul style="list-style-type: none"> <li>Displays the data being sent and received with the LAN, USB, RS-232C, and GP-IB interface.</li> <li>Saves sent and received commands on the USB flash drive (log function).</li> </ul>
	Setting	Communications monitor: ON, OFF Log: ON, OFF
	Default setting	Communications monitor: OFF Log: OFF

<b>Measured value format</b>	Operation	Changes the format of responses to measured value queries. RANGE FIX setting: Exponential part fixed based on the measurement range FLOAT setting: Floating point (When using the FLOAT setting, the instrument automatically transitions to the STOP state when transitioning to the REMOTE state.)
	Setting	Measured value format: RANGE FIX, FLOAT
	Default setting	Measured value format: RANGE FIX
<b>SCPI ID</b>	Operation	Sets the response string for the <b>*IDN?</b> query.
	Setting	SCPI ID: Up to 127 characters
	Default setting	Blank (HIOKI, model name, serial number, software version)
<b>Remote</b>	<p>When communicating with the LAN, USB, RS-232C, or GP-IB interface, places the instrument in the remote state and disables touch panel and key operations. The <b>[TRIG]</b> key functions except while the instrument is in the RUN state. The remote state can be canceled as follows:</p> <ul style="list-style-type: none"> <li>• By pressing the <b>LOCAL</b> key on the touch panel</li> <li>• By cycling the instrument's power</li> <li>• By sending the <b>:SYSTEM:LOCa1</b> command with the LAN, USB, RS-232C, or GP-IB interface</li> <li>• By sending the <b>GTL</b> command with the GP-IB interface</li> </ul>	
<b>Startup settings</b>	Operation	Selects which settings to apply when the instrument is turned on.
	Settings	Startup setting: LAST, FACTORY, PANEL Panel: No. 01 to No. 30
	Default settings	Startup setting: LAST Panel: No. 01
<b>Reset</b>	Reset	Reverts all settings other than panel data and interface settings to their factory defaults. (Operation is the same as for the <b>*RST</b> , <b>:SYSTEM:PRESet</b> , <b>:STATus:PRESet</b> commands.)
	System reset	Reverts all settings to their factory defaults.

## 13.4 Interface Specifications

<b>LAN (standard equipment)</b>	Standard compliance	IEEE 802.3
	Transmission method	10BASE-T, 100BASE-TX (automatic detection) Full-duplex transmission
	Protocol	TCP/IP
	Connector	RJ-45
	Type of information sent and received	Settings and measurements via communications commands
	Settings	IP address, subnet mask, default gateway Communications command port: 1 to 9999
	Default settings	IP address: 0.0.0.0 Subnet mask: 255.255.255.0 Default gateway: 0.0.0.0 (none) Communications command port: 23
<b>USB device (standard equipment) (Not available when USB host is selected)</b>	Electrical specifications	USB 2.0 (full-speed)
	Connector	Series B receptacle
	Class	CDC class (USB COM), HID class (USB keyboard mode)
	Default setting	CDC class (USB COM)
<b>USB host (standard equipment) (Not available when USB device is selected)</b>	Class	Mass storage class (FAT16/32 support, no VFAT support)
	Capacity limit	Up to 128 GB (theoretical value)
	Saving of measured values	<ul style="list-style-type: none"> <li>Touching the <b>SAVE</b> key outputs the current measured value or screen (BMP format).</li> <li>All contents of measured value memory can be output to the USB flash drive from the File Operations screen.</li> </ul>
	File operations	Save settings (with or without panel information), load settings, delete, change name, display disk information
	Settings	Output format: TEXT, SCREEN
	Default settings	Default setting: TEXT
	<b>GP-IB (-02 model)</b>	Standard compliance
Interface actions		SH1, AH1, T6, L4, SR1, RL1, PP0, DC1, DT1, C0
Type of information sent and received		Settings and measurements via communications commands
Settings		Device address: 1 to 30 Delimiter: LF, CRLF
Default settings		Device address: 1 Delimiter: LF

<b>RS-232C (-03 model)</b>	Connector	D-sub 9-pin male with fastening screw #4-40
	Transmission method	Asynchronous, full duplex
	Transmission speeds	9600 bps, 19200 bps, 38400 bps
	Number of data bits	8
	Number of stop bits	1
	Parity bit	None
	Delimiters	Transmit: CRLF; receive: CR or CRLF
	Flow control	None
	Protocol	No control sequence
	Type of information sent and received	Settings and measurements via communications commands
	Setting	Transmission speed: 9600 bps, 19200 bps, 38400 bps
	Default setting	Transmission speed: 9600 bps
<b>Printer (-03 model)</b>	Supported printers	Interface: RS-232C Number of characters per line: At least 40 single-byte characters Communications speed: 9600 bps, 19200 bps, 38400 bps (as per RS-232C setting) Number of data bits: 8 Parity: None Number of stop bits: 1 Flow control: None Delimiter: CRLF Control codes: Must be capable of printing plain text directly.
	Setting	Clear statistical calculations: ON, OFF
	Default setting	Clear statistical calculations: OFF

<b>EXT I/O</b> (standard equipment)	Connector	D-sub 37-pin female with fastening screw #4-40
	Input	<p><b>Electrical specifications</b></p> <ul style="list-style-type: none"> <li>• Isolation Photocoupler-isolated no-voltage contact input (Support for current sink and source output)</li> <li>• Input on Residual voltage of 1 V or less Input on current: 4 mA (reference value)</li> <li>• Input off Open (breaking current of 100 <math>\mu</math>A or less)</li> <li>• Response time ON edge: Max. 0.1 ms OFF edge: Max. 1.0 ms</li> </ul> <hr/> <p><b>Input signals</b> TRIG, KEY_LOCK, LOAD0 to LOAD4, PRINT</p> <hr/> <p><b>Settings</b> Input filter: ON, OFF Input filter response time: 50 ms to 500 ms</p>
	Output	<p><b>Electrical specifications</b></p> <ul style="list-style-type: none"> <li>• Isolation Photocoupler-isolated open drain output (non-polar)</li> <li>• Maximum load voltage 30 V DC</li> <li>• Residual voltage 1 V or less (with load current of 50 mA) or 0.5 V or less (with load current of 10 mA)</li> <li>• Maximum output current 50 mA/channel</li> </ul> <hr/> <p><b>Output signals</b> EOM, HI, IN, LO, BIN0 to BIN9, OB, ERR</p> <hr/> <p><b>Settings</b> EOM output: HOLD, PULSE EOM pulse width: 1 ms to 100 ms</p>
	Power supply output	<p><b>Output voltage</b> Sink output support: 4.2 V to 5.8 V Source output support: -4.2 V to -5.8 V</p> <hr/> <p><b>Maximum output current</b> 100 mA</p> <hr/> <p><b>External power supply input</b> None</p> <hr/> <p><b>Isolation</b> Floating from protective ground potential and measurement circuit Terminal-to-ground voltage 50 V DC, 33 V rms AC, 46.7 V peak AC or less</p>
Default settings	<p>Input filter: OFF Input filter response time: 50 ms EOM output: HOLD EOM pulse width: 5 ms Current sink/source setting: Current sink (NPN) (factory default)</p>	



# 14 Maintenance and Service

## WARNING



Customers should not attempt to modify, disassemble or repair the instrument. Fire, electric shock and injury could result.

### Calibration and repair

The calibration frequency varies depending on the status of the instrument or installation environment. We recommend that the calibration frequency is determined in accordance with the status of the instrument or installation environment and that you request that calibration be performed periodically.

When calibration or repair is requested to Hioki, the settings will be returned to the default settings. Before requesting calibration or repair, we recommend saving the settings of the instrument in a USB flash drive.

### Transporting the instrument

- To ensure that the product arrives safely, use the original box and packaging from when you purchased it. However, do not use the original box if it is torn or otherwise damaged or the original packaging if it has been crushed. Instead, use standard, commercially available packaging materials to carefully pack the product in the same manner as it arrived after purchase.
- Please note that if you pack the product so that it is not adequately cushioned and it suffers damage during shipment, you will be billed for the cost of repair, even if the product is still within the warranty period.
- Be sure to disconnect all cables from the product before packing it.
- Exercise care that the product is not dropped or subject to other mechanical shock during shipment.

### Replacement parts and their service lives

The characteristics of some of the parts used in the product may deteriorate with extended use. To ensure the product can be used over the long term, it is recommended to replace these parts on a periodic basis.

When replacing parts, please contact your authorized Hioki distributor or reseller.

The service life of parts varies with the operating environment and frequency of use. Parts are not guaranteed to operate throughout the recommended replacement cycle.

Part Name	Recommended Replacement Cycle	Notes and Conditions
Electrolytic capacitors	Approx. 5 years	The PCB on which the part is mounted must be replaced.
LCD backlight (half-life of brightness)	Approx. 5 years	Based on 24 hours/day usage
Relays	Approx. 5 years	For range switching 10 times/h
Backup battery (lithium battery)	Approx. 10 years	If the date or time is not substantially accurate, the battery should be replaced.

## 14.1 Q&A (Frequently Asked Questions)

- If no measured value is displayed even when the metal pins of the measurement cable are shorted together, internal damage may have occurred. Contact your authorized Hioki distributor or reseller.
- If the instrument seems to be malfunctioning, check this section and then contact your authorized Hioki distributor or reseller.

### Troubleshooting contents

“1. General issues” (p. 168)

“2. Measurements” (p. 169)

“3. Communications” (p. 171)

“4. EXT I/O” (p. 173)

“Frequently Asked Questions for External Control (EXT I/O)” (p. 175)

If unable to resolve the issue, please contact your authorized Hioki distributor or reseller.

### 1. General issues

No.	Issue	Items to check	Possible causes → Solutions	See	
1-1	The instrument cannot be turned ON. (The display is blank.)	Color of the start button	Green	The screen may be too dark. → Adjust the screen brightness.	p. 89
			Red	The instrument is in the halt state. → Push the start button.	p. 28
			Does not light up (Light is OFF)	The instrument is not receiving power. → Check the continuity of the power cord. → Verify that the circuit breaker has not tripped. → Turn ON the main power switch (at the back of the instrument).	p. 28
				The supply voltage or frequency is not correct. → Check the power rating (100 V to 240 V AC, 50 Hz/60 Hz).	-
1-2	Key and touch panel cannot be operated.	Icon indication	<b>KEY</b> icon indication	The key has been locked. → Cancel the key lock. → Turn OFF the EXT I/O KEY_LOCK signal.	p. 87 p. 129
			<b>REMOTE</b> icon indication	The instrument is in the remote state. → Touch the <b>LOCAL</b> key to cancel the remote state.	CD*
1-3	Comparator/BIN judgment results are not displayed on the screen.	Measured value	Displayed	The comparator function and BIN function are <b>OFF</b> . → Set these functions to <b>ON</b> .	p. 51 p. 57
			Not displayed ( <b>NoCntct</b> or <b>-----</b> )	Judgment is not made if there is a contact error or if a measurement has not been done.	p. 46
1-4	There is no sound during operations.	Beep setting	<b>OFF</b>	The function is <b>OFF</b> . → Set the function to <b>ON</b> .	p. 88



No.	Issue	Items to check		Possible causes → Solutions	See
1-5	No judgment sound.	Buzzer setting for comparator function	<b>OFF</b>	The function is <b>OFF</b> . → Set the function to <b>ON</b> .	p.55
			<b>ON</b>	Buzzer volume is OFF. → Set the volume to a value other than <b>OFF</b> .	p.88
		-	BIN measurement → No judgment sound.	p.56	

\*: Communication Command Instruction Manual provided with the application disc

## 2. Measurements

No.	Issue	Items to check		Possible causes → Solutions	See	
2-1	Measurement values are not stable.	Effects of noise	May be susceptible to noise	See "Appx. 4 Noise Countermeasures"	p.Appx.8	
		Circuit to be measured	AC signal is superimposed.	See "6.1 Obtaining Stable Measured Values" (p.67).	p.67	
			Temperature is not stable (just manufactured, just unpacked, or is held by hand, etc.).	Leave the object to be measured to adapt to the ambient temperature.		
			Output resistance (internal resistance) of the object to be measured is high.	The instrument's bias current or input resistance is affecting measurement results. → If the range is 10 V or less, set the input resistance to AUTO.	p.76 p.Appx.5	
		Temperature compensation (TC)	<b>ON</b>	The temperature sensor is not appropriately positioned. → Move the temperature sensor closer to the measurement target. → Position the temperature sensor so that it is not affected by airflow. → If the measurement target responds to temperature changes more slowly than the temperature sensor, increase the temperature sensor's response time by covering it with something. The temperature sensor's response time is about 10 minutes (reference value).		p.10
				Temperature coefficient is not set appropriately. → Measure the temperature coefficient of the object to be measured in advance and set the value to the instrument.		p.80
			<b>OFF</b>	The measurement target's voltage value is fluctuating due to the temperature, for example, when the room temperature has not stabilized. → Turn <b>ON</b> temperature compensation (TC).		p.80

No.	Issue	Items to check		Possible causes → Solutions	See	
2-2	Measured value differ from expected value. (A negative value is displayed.)	Scaling function	<b>ON</b>	The offset setting is not correct. → Turn scaling <b>OFF</b> , or reconfigure the setting properly.	p.82	
		Measurement cable connection		Cable is not connected properly. → Check the connections.	p.26 p.31	
		See also No. 2-1.				
		NULL function	<b>ON</b>	Zero point is shifted. → Set the NULL function <b>OFF</b> , or reconfigure the settings properly.	p.78	
2-3	Measured value is not displayed. (For more information about measurement error displays, see p.46.)	Measured value	<b>NoCntct</b>	There is a break in the measurement cable. → Replace the measurement cables.	p.3	
				Metal pins (probes) of the measurement cable are worn or cables are cut. → Replace the measurement cables.	p.3	
				The metal pins (probes) are not in contact with the measurement target. → Clean or replace the metal pins (probes). → Increase the contact pressure.	p.31	
				The measurement target is made of a material such as conductive paint or conductive rubber, resulting in a high resistance value between the HIGH and LOW terminals. → Set the contact function to <b>OFF</b> , or use a smaller threshold.	p.71	
				(When measuring enclosure potential) Capacitance between battery electrode and enclosure is small. → Set the contact function to <b>OFF</b> , or use a smaller threshold.	p.71	
				<b>+OvrRng</b> <b>-OvrRng</b>	Measurement range does not cover the object to be measured. → Change the range or set it to auto-range.	p.35
				Nothing is displayed.	No range is selected during auto-range operation. → See No. 2-4.	-
				2-4	No range is selected during auto-range operation (no appropriate range is found).	Circuit to be measured
2-5	The auto-hold function is not working (hold operation is not being canceled).	Measured value	Not stabilizing.	→ See No. 2-1.	p.169	
			Does not change.	Incorrect range. → Select an appropriate range or use auto-range.	p.35	

No.	Issue	Items to check	Possible causes → Solutions	See	
2-6	Measured temperature is not displayed correctly.	Temperature sensor		There is a problem with the connection. → Connect the temperature sensor by inserting the plug all the way in. The specified temperature sensor has not been used. → Use the Z2001 Temperature Sensor.	p.27
				The temperature sensor is defective. → Replace the Z2001 Temperature Sensor.	-
		Sub-display	Trend and settings screens	Temperature cannot be displayed on the trend display or settings screens. → Close the trend display or settings screen.	p.16
2-6	Measured temperature is not displayed correctly.	<b>STOP</b> or <b>EXTERNAL</b> trigger		Temperature is updated based on the voltage. Temperature will not be updated when measurement is stopped. → Push <b>[TRIG]</b> key to execute triggered measurements or restart continuous measurements.	p.37 p.38

### 3. Communications

Operation can be easily confirmed by referring to “8.3 Communications Settings” (p.109).

No.	Issue	Items to check	Possible causes → Solutions	See	
3-1	The instrument is not responding at all.	Display	<b>REMOTE</b> icon is not displayed	Connection is not established. → Check whether the connector has been connected.	-
				→ Check whether the interface setting is correct.	p.98 p.100 p.102 p.104
				(USB)→ Install the driver in the control device.	p.98
				(RS-232C)→ Use a cross cable.	p.101
				(USB, RS-232C)→ Check the COM port number on the control device.	p.98 p.100
				(RS-232C)→ Use the same communication speed for the instrument and the control device.	p.100
		<b>REMOTE</b> icon is displayed	Commands are not accepted. → Check the software delimiter.	-	
→ (GP-IB) Check the message terminator setting. → (GP-IB) Check whether the address setting has been configured properly.	p.102				

Q&A (Frequently Asked Questions)

3-1	The instrument is not responding at all.	Green LED on the LAN connector on the rear of the instrument	Unlit	(LAN)→ Check the cable.	p. 108
				(LAN)→ Check that the LAN setting of the instrument and control device is the same.	p. 105
			Lit	(LAN)→ Check that the LAN setting of the instrument and control device is the same.	p. 105
3-2	An error occurred.	Display	Command error	The command is not recognized as a valid instruction. → Check the command spelling. (Space: x20H) → Do not append a question mark (?) to commands that are not queries. → (RS-232C) Use the same communications speed for the instrument and the control device.	CD* p. 100
				The input buffer (256 bytes) is full. → Insert a dummy query after sending several lines of commands. Example: Send *OPC? → Receive 1	CD*
			Execution error	The command string is correct, but the instrument is not able to execute it. Example: The data was spelled incorrectly. :VOLT:DC:RANG 10000 → Check the specifications of the command(s) in question.	
				The input buffer (256 bytes) is full. → Insert a dummy query after sending several lines of commands. Example: Send *OPC? → Receive 1	
3-3	No response to query.	Communication monitor	No response	" :TRIG:SOUR EXT" is used to send :READ? and the instrument is waiting for a trigger. → Check the command specifications.	CD*
			Response	The program is malfunctioning. → Check the receive portion of the program.	

\*: Communication Command Instruction Manual provided with the application disc

## 4. EXT I/O

Operation can be easily confirmed by referring to “11.5 Input Test/Output Test” (p. 138).

No.	Issue	Items to check		Possible causes → Solutions	See
4-1	The instrument is not operating at all.	“11.5 Input Test/Output Test” (p. 138)	IN/OUT displayed does not match the external device connected.	The wiring is incorrect. → Check the following on the EXT I/O again. <ul style="list-style-type: none"> <li>• A connector is disconnected.</li> <li>• The pin number is not correct.</li> <li>• ISO_COM pin wiring</li> <li>• NPN/PNP setting</li> <li>• Contact (or open collector) control (voltage is not used to control)</li> <li>• Power supply to external device (This instrument does not require a power supply.)</li> </ul>	p. 125
4-2	Trigger input does not work.	Trigger source	<b>INTERNAL</b>	<b>INTERNAL</b> setting does not accept a TRIG signal. Set the trigger source to <b>EXTERNAL</b> .	p. 39
		Duration of TRIG signal ON	Less than 0.1 ms	Duration of TRIG signal ON is short. → Ensure that the ON time is at least 0.1 ms.	-
		Duration of TRIG signal OFF	Less than 1 ms	Duration of TRIG signal OFF is short. → Ensure that the OFF time is at least 1 ms.	-
		Input filter for TRIG and PRINT signals	<b>ON</b>	A longer signal control time is required. → Increase the response time. → Turn <b>OFF</b> the filter function.	p. 136
		:INIT:CONT (command)	<b>OFF</b>	The instrument is not in the trigger wait state. → Send the <b>:INIT</b> or <b>:READ?</b> command.	CD*
4-3	Print is not enabled.	Interface setting	Other than <b>PRINT</b>	Setting to <b>PRINT</b> is required. → Set the interface to <b>PRINT</b> .	p. 146
		Input filter for TRIG and PRINT signals	<b>ON</b>	A longer signal control time is required. → Increase the response time. → Turn <b>OFF</b> the filter function.	p. 136
4-4	No panel can be loaded.	Panel number selected for LOAD signal	Is the panel saved?	Panel has not been saved for the panel number to be loaded. → Change the panel number or save the panel to the panel number selected as LOAD signal.	p. 62 p. 130

No.	Issue	Items to check		Possible causes → Solutions	See
4-5	EOM signal is not output.	Measured value	Not updated	See No. 3-2 above.	p. 168
		EOM signal logic		(The EOM signal turns ON once measurement is completed.)	-
		EOM signal setting	Pulse	The pulse output time is short and the controller cannot detect the EOM signal. → Increase the pulse output time of the EOM signal or set the output setting to "hold".	p. 137
Hold	The measurement time is short, and the interval during which the EOM signal is OFF cannot be detected. → Change the EOM signal output setting to "pulse".				
4-6	The Hi, IN and Lo signals are not output.	Comparator judgment results	Are not displayed	→ See No. 1-3 above.	p. 168

\*: Communication Command Instruction Manual provided with the application disc

## Frequently Asked Questions for External Control (EXT I/O)

Question	Instruction/Method
What is the required connection to input TRIG signal?	Short (ON) the TRIG pin and ISO_COM pin with a switch or open-collector output.
Which are the common ground pins for input and output signals?	The ISO_COM pins.
Are the common (signal ground) pins shared by both input and output?	Use ISO_COM pin as the shared common pin for input and output signals.
How to check whether the signal is output?	Check voltage waveforms with an oscilloscope. To do this, pull up (by several kΩ) the output pins such as EOM signal and comparator judgment results signal to the isolated power output (ISO_5V) of the instrument and confirm the voltage level.
How do I troubleshoot input (control) signal issues?	For example, if TRIG signal does not operate properly, bypass the Programmable Controller and short the TRIG pin directly to an ISO_COM pin. Take care not to short-circuit the power supply.
Are the comparator judgment signals (HI, IN, LO) retained during measurements (or will they be OFF)?	When the state is <b>RUN</b> and the trigger source is set to <b>INTERNAL</b> , judgment results are retained even during measurements. In the other cases, judgment results will be cleared once a measurement has started.
What is the condition to output the ERR signal?	An error is displayed in the following cases: <ul style="list-style-type: none"> <li>• Metal pin of the measurement cable is not in contact.</li> <li>• The contact is not stable</li> <li>• Metal pin of the measurement cable or object to be measured is dirty or has an oxide layer.</li> <li>• The measurement cables are cut.</li> <li>• Capacitance of the object to be measured is small.</li> </ul>
Is a direct connection to programmable controller available?	Direct connection is possible if the output circuit of the programmable controller supports relays or open collectors and the input circuit of the programmable controller supports contact input. (Before connecting, confirm that voltage and current ratings will not be exceeded.)
Can external I/O be used at the same time as RS-232C or other communication?	Yes. (Example: Set measurement conditions using communications and measure with TRIG signal of the EXT I/O.)
How should the external power be connected?	All the instrument's <b>EXT I/O</b> input and output signals operate from an internal isolated power source. Power need not be supplied from the programmable controller (supplying power to the ISO_5V terminal is prohibited).
Can free-running measurement values be acquired using a foot switch?	Measurement values can be acquired using the sample application. The sample application can be downloaded from our website ( <a href="http://www.hioki.com">http://www.hioki.com</a> ).

## 14.2 Cleaning

To clean the instrument and optional equipment, wipe gently with a soft cloth moistened with water or mild detergent.

Wipe the LCD gently with a soft, dry cloth.

## 14.3 Error Displays

The following messages are displayed on the screen when the instrument malfunctions or encounters an abnormal measurement state.

- If you feel that the instrument may be malfunctioning, contact your authorized Hioki distributor or reseller after reviewing the information provided in “Q&A (Frequently Asked Questions)” (p. 168).
- When an error is displayed on the LCD screen and service is required, please contact your authorized Hioki distributor or reseller.

Display		Description	Solution
<b>+OvrRng/-OvrRng</b>		Over-range	Select the appropriate range. (p. 35)
<b>NoCntct</b>		Contact error	Check the connections with the object to be measured. (p. 31) Or, adjust the threshold for the contact check. (p. 71)
<b>Err.TC</b>		Temperature compensation error	Connect a temperature sensor. (p. 27)
<b>ERR:001</b>	<b>Lower limit is higher than Upper limit.</b>	Cannot set because the lower limit value is greater than the upper limit value.	Set an upper limit value that is greater than the lower limit value. (p. 51)
<b>ERR:004</b>	<b>Unable to change the setting during auto-hold.</b>	When auto-hold function is enabled, settings for measurement speed and continuous mode cannot be changed.	Turn OFF the auto-hold function. (p. 70)
<b>ERR:005</b>	<b>Unable to set NULL due to an abnormal measurement value.</b>	When <b>OverRng</b> , <b>NoCntact</b> , or <b>-----</b> is displayed, NULL value cannot be obtained.	Return from the abnormal measurement state. (p. 46)
<b>ERR:030</b>	<b>Command error.</b>	Remote command syntax error. (String is incorrect or incorrect character code is used.)	Check if the commands are correct. (See the application disc provided.)
<b>ERR:031</b>	<b>Execution error. Invalid parameter.</b>	Remote command execution error. The parameter value is out of range.	Check if the parameters are correct.
<b>ERR:032</b>	<b>Execution error.</b>	Remote command execution error.	Check the execution error conditions for each command.
<b>ERR:050</b>	<b>The panel does not exist.</b>	Panels that have not been saved cannot be read.	Select a proper panel. (p. 61)
<b>ERR:051</b>	<b>The panel does not exist. Unable to rename.</b>	Name of panels that have not been saved cannot be changed.	Select a panel that has been saved. (p. 61)
<b>ERR:060</b>	<b>Cannot use USB memory. Set I/F function to USB-MEMORY.</b>	When <b>I/F</b> is set to <b>USB COM</b> , USB flash drive cannot be used.	Set the I/F to <b>USB MEMORY</b> . (p. 115)
<b>ERR:061</b>	<b>The drive is not ready. (No USB memory inserted)</b>	USB flash drive is not inserted.	Insert a USB flash drive. (p. 115)
<b>ERR:062</b>	<b>This format is not supported.</b>	Format of the USB flash drive is not correct.	Format the USB flash drive to FAT32.



	Display	Description	Solution
ERR:063	<b>Error while reading the USB memory.</b>	An error occurred while reading the USB flash drive.	The file may be damaged. Recover the file or use a different USB flash drive.
ERR:064	<b>Error while reading the configuration file.</b>	An error occurred while reading a setting file in the USB flash drive.	The file may be damaged. Recover the file or use a different USB flash drive.
ERR:065	<b>File not found.</b>	A valid file was not found in the USB flash drive.	Specify a proper file.
ERR:070	<b>No space available.</b>	There is no free space in the USB flash drive.	Delete unnecessary files to secure free space.
ERR:071	<b>Error occurred saving the file.</b>	An error occurred while saving data in the USB flash drive.	The file may be damaged. Recover the file or use a different USB flash drive.
ERR:076	<b>Error occurred deleting the file.</b>	An error occurred while deleting data in the USB flash drive.	The file may be damaged. Recover the file or use a different USB flash drive.
ERR:077	<b>Unable to rename the file because another file with the same name already exists.</b>	The file name cannot be changed as there are files with the same file name.	Specify a different file name.
ERR:078	<b>Error occurred renaming the file.</b>	An error occurred while changing a file name in the USB flash drive.	The file may be damaged. Recover the file or use a different USB flash drive.
ERR:079	<b>Error while reading the USB memory.</b>	An error occurred while reading the USB flash drive.	The file may be damaged. Recover the file or use a different USB flash drive.
ERR:080	<b>Unable to enter the adjustment mode.</b>	The mode cannot be changed to adjustment mode.	The Adjustment screen is not available for use by end-users.
ERR:090	<b>ROM check sum error.</b>	Check sum of the program ROM does not match.	Malfunction of the instrument. Request service.
ERR:091	<b>RAM error.</b>	The RAM failed.	Malfunction of the instrument. Request service.
ERR:092	<b>Memory access error. Turn off the power and restart after a while.</b>	Communication with memory failed.	Turn OFF the power and turn it ON again after some time.
ERR:093	<b>Memory test error.</b>	Memory failure.	Malfunction of the instrument. Request service.
ERR:094	<b>Adjustment data error.</b>	Adjustment data is not correct.	Malfunction of the instrument. Request service.
ERR:095	<b>Backup data error.</b>	Backup data is not correct.	Settings have been reset. Reconfigure measurement conditions and other settings.
ERR:096	<b>Failed to detect line frequency. Select line frequency.</b>	The power frequency has not been detected.	Check the voltage and frequency of the power supply. (p.90)
ERR:098	<b>"The clock is not set. Reset? (15-01-01 00:00:00)"</b>	Clock has not been set.	Replace the backup battery and set a clock.
ERR:099	<b>Failed to detect line frequency; will be set to 50 Hz.</b>	The power frequency has not been detected. The frequency will be set to 50 Hz.	Check the voltage and frequency of the power supply. (p.90)

Display		Description	Solution
ERR:999	Error	An error due to other reasons.	Malfunction of the instrument. Request service.
INFO:001	Set NULL.	Current measured values will be acquired as NULL.	-
INFO:002	NULL function will be turned off.	NULL function will be turned OFF.	-
INFO:003	Lock the keys and return to the main screen.	Enables the key lock and returns to the main screen.	-
INFO:004	The keys and touch panel are locked. Press [UNLOCK] 1 second to unlock.	Keys and touch panel have been locked. Hold the <b>UNLOCK</b> for one second.	-
INFO:005	The keys and touch panel are locked. Press [LOCAL] to unlock.	Keys and touch panel have been locked. Touch <b>LOCAL</b> .	-
INFO:006	The keys and touch panel are locked by an external I/O (LOAD signal).	Keys and touch panel have been locked by EXT I/O (LOAD signal).	-
INFO:010	The panel will be loaded.	The panel will be read.	-
INFO:011	Loading the panel...	The panel is being read.	-
INFO:012	The panel will be saved.	The panel will be saved.	-
INFO:013	The panel will be saved in an area already in use. Overwrite?	Overwrite an existing panel. Do you want to overwrite?	-
INFO:014	Saving the panel...	The panel is being saved.	-
INFO:015	The panel will be deleted.	The panel will be deleted.	-
INFO:030	The file will be saved.	The file will be saved.	-
INFO:031	The file already exists. Overwrite?	There is a file with the same file name. Do you want to overwrite?	-
INFO:032	The file will be renamed.	The file name will be changed.	-
INFO:033	The file will be deleted.	The file will be deleted.	-
INFO:034	Reading a file list (updating).	The file list is being read.	-
INFO:035	Loading the file.	The file is being read.	-
INFO:036	File load completed.	The file has been read.	-
INFO:037	Saving the file.	The file is being saved.	-
INFO:038	File save completed.	File save is completed.	-
INFO:039	The number of files exceeds 1000. Any files can't be displayed.	There are more than 1000 files. Some files are not shown in the file list. (The instrument can only process up to 1000 files.)	Delete some files so that there are 1000 or fewer files.
INFO:050	Printing...	Printing.	-
INFO:070	Copying the screen.	The screen is being copied.	-
INFO:071	Screen copy completed.	Screen copy is completed.	-
INFO:080	Reset?	Do you want to reset?	-

Display		Description	Solution
<b>INFO:081</b>	<b>Enter password for Adjustment Mode.</b>	Enter the password for adjustment mode.	-
<b>Err.Cal</b>		Compensation values for self-calibration are not correct. There is a failure in communicating with the A/D converter due to external noise or the instrument is malfunctioning.	If this error is displayed continuously, request for service.
<b>Err.AD</b>		A communication error with A/D converter. There is a failure in communicating with the A/D converter due to external noise or the instrument is malfunctioning.	If this error is displayed continuously, request for service.
<b>Err.REF</b>		Reference voltage error.	If this error is displayed continuously, request for service.

## 14.4 Disposing of the Instrument

The instrument uses a lithium battery as a backup for its clock. When disposing the instrument, remove the lithium battery and dispose the battery and instrument in accordance with local regulations.

### **WARNING**



To avoid electric shock, turn **OFF** the main power switch and disconnect the power cord and measurement cables before removing the lithium battery.

### Removing the Lithium Battery

#### Required tools:

- One Phillips screwdriver (No.1)
- One pair of tweezers (to remove the lithium battery)

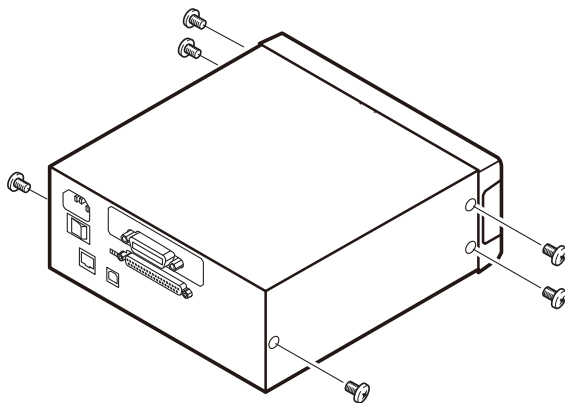

**1** Verify that the power to the instrument is **OFF** and unplug the power cord, and any other cords or cables.

**2** Remove the six screws from the sides.

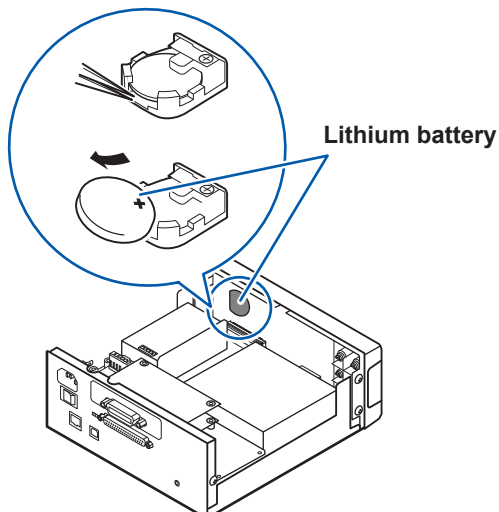

**3** Remove the cover.

**4** Insert the tip of the tweezers between the battery and the battery holder as shown in the picture and lift up on the battery to remove it.

### **CAUTION**



Exercise care not to short the positive and negative terminals. Doing so may cause sparks.

#### **CALIFORNIA, USA ONLY**

This product contains a CR Coin Lithium Battery which contains Perchlorate Material - special handling may apply.

See [www.dtsc.ca.gov/hazardouswaste/perchlorate](http://www.dtsc.ca.gov/hazardouswaste/perchlorate)

# 15 License Information

The instrument uses lwIP open-source software.

lwIP's License

lwIP is licenced under the BSD license:

Copyright (c) 2001-2004 Swedish Institute of Computer Science.  
All rights reserved.

Redistribution and use in source and binary forms, with or without modification, are permitted provided that the following conditions are met:

1. Redistributions of source code must retain the above copyright notice, this list of conditions and the following disclaimer.
2. Redistributions in binary form must reproduce the above copyright notice, this list of conditions and the following disclaimer in the documentation and/or other materials provided with the distribution.
3. The name of the author may not be used to endorse or promote products derived from this software without specific prior written permission.

THIS SOFTWARE IS PROVIDED BY THE AUTHOR ``AS IS AND ANY EXPRESS OR IMPLIED WARRANTIES, INCLUDING, BUT NOT LIMITED TO, THE IMPLIED WARRANTIES OF MERCHANTABILITY AND FITNESS FOR A PARTICULAR PURPOSE ARE DISCLAIMED. IN NO EVENT SHALL THE AUTHOR BE LIABLE FOR ANY DIRECT, INDIRECT, INCIDENTAL, SPECIAL, EXEMPLARY, OR CONSEQUENTIAL DAMAGES (INCLUDING, BUT NOT LIMITED TO, PROCUREMENT OF SUBSTITUTE GOODS OR SERVICES; LOSS OF USE, DATA, OR PROFITS; OR BUSINESS INTERRUPTION) HOWEVER CAUSED AND ON ANY THEORY OF LIABILITY, WHETHER IN CONTRACT, STRICT LIABILITY, OR TORT (INCLUDING NEGLIGENCE OR OTHERWISE) ARISING IN ANY WAY OUT OF THE USE OF THIS SOFTWARE, EVEN IF ADVISED OF THE POSSIBILITY OF SUCH DAMAGE.



# Appendix

## Appx. 1 Block Diagram

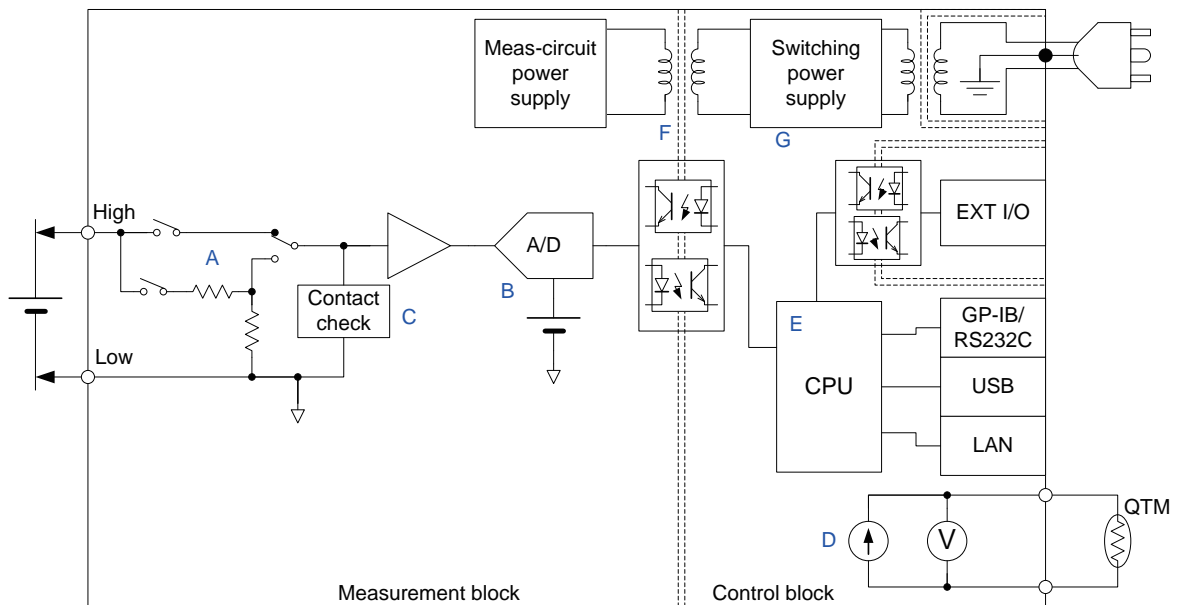

- The voltage detected between the HIGH and LOW terminals is adjusted appropriately and connected to a high-impedance amp. (A)  
From the 100 mV range to the 10 V range, the input resistance is switched between high-Z (10 G $\Omega$  or greater) and 10 M $\Omega$ . For the 100 V range and 1000 V range, the input resistance is fixed to 10 M $\Omega$ .
- The detected voltage adjusted in (A) is converted into a digital value by a high-stability reference voltage source and a high-resolution A/D converter. (B)
- The impedance between HIGH and LOW is measured by the contact check circuit. If the impedance is high, a contact error is determined to have occurred. The contact check function can be used from the 100 mV range to the 10 V range. (C)
- The instrument has a built-in temperature measurement circuit, making it possible to correct voltage measured values according to the temperature when measuring a target that exhibits a high degree of temperature dependence. (D)
- A high-speed CPU makes possible high-speed measurement and a speedy system response. (E)
- The measurement block is isolated from the control block, increasing the circuit's resistance to the effects of noise. (F)
- Use of a switching power supply with a wide input range from 100 V to 240 V enables stable measurement, even in environments in which stable power cannot be supplied. (G)

## Appx. 2 Measuring the Enclosure Potential of Laminated Lithium-ion Batteries

This appendix addresses measurement of the enclosure potential of laminated lithium-ion batteries, including a description of causes of such potentials and precautions that should be observed during measurement.

### Internal insulation defects in lithium-ion batteries

Internal insulation defects in lithium-ion batteries cause degraded characteristics and may lead to serious accidents under certain conditions. Lithium-ion batteries are prone to a variety of insulation defects, as described in the following table:

#### Internal insulation defects in laminated lithium-ion batteries

Defect location	Cause	Phenomenon
Between positive electrode and negative electrode	Penetration of separator due to metal deposition, contamination with metallic particles, fold misalignment, etc.	Increased self-discharging, abnormal heating
Between positive electrode and enclosure aluminum	Contamination with metallic particles, defective seal on aluminum laminated foil	The positive electrode's current collector is usually made from aluminum, making this an unlikely issue.
Between negative electrode and enclosure aluminum	Contamination with metallic particles, defective seal on aluminum laminated foil	The lithium-ion battery's performance may be degraded if cracks form in the enclosure aluminum's insulating film.
Between the electrolyte and the enclosure aluminum	Cracks in the aluminum laminated foil	The lithium-ion battery's performance may be degraded if there is a defect in the insulation between the negative electrode and the enclosure aluminum.

Insulation defects between the positive electrode and the negative electrode lead to increased self-discharging and abnormal heating of the battery. In general, they can be identified by a voltage drop after aging the battery for a period ranging from several days to several weeks.

Insulation defects between the enclosure aluminum and the positive electrode, negative electrode, or electrolyte are not immediately problematic since they do not form a closed loop through the enclosure aluminum.

When a lithium-ion battery is subject to repeated expansion and contraction due to charging and discharging, cracks more readily form in the insulating film that coats the surface of the aluminum laminated foil. Such cracks can lead to defective insulation between the electrolyte and enclosure aluminum. When an insulation defect occurs between the positive electrode or negative electrode and the enclosure aluminum, the likelihood of a closed loop being formed through the enclosure aluminum and the electrolyte increases.

In general, the standard electrode potentials of lithium-ion batteries are as shown in the following table:



**Standard electrode potential of materials used in lithium-ion batteries**

Area	Material	Standard electrode potential
Positive electrode	$\text{Li}_{(1-n)}\text{CoO}_2$	+1 V
Enclosure	Al	-1.7 V
Negative electrode	$\text{Li}_{(1-n)}\text{C}_6$	-2.9 V

Because the enclosure aluminum has a high potential relative to the negative electrode, the occurrence of an insulation defect between the negative electrode and the enclosure aluminum while another insulation defect is occurring between the electrolyte and the enclosure aluminum can trigger a reduction reaction of the aluminum enclosure, generating an Li-Al alloy. This alloy is extremely fragile, leading to the formation of pinholes in the enclosure aluminum. If moisture gets into the battery through these pinholes, it will react with the electrolyte to form a gas, causing a dramatic reduction in the service life of the lithium-ion battery.

On the other hand, if an insulation defect between the positive electrode and the enclosure aluminum occurs at the same time as another insulation defect between the electrolyte and the enclosure aluminum, the enclosure aluminum will undergo an oxidation reaction, and no unstable Li-Al alloy will be formed. In short, insulation defects between the positive electrode and the enclosure aluminum do not adversely affect the service life of lithium-ion batteries.

For the above reasons, the enclosure potential of laminated lithium-ion batteries is assessed by measuring the potential difference between the positive electrode and the enclosure aluminum in order to detect insulation defects between the negative electrode and the enclosure aluminum.

**Enclosure potential measurement**

When the potential difference between the positive electrode and the enclosure aluminum is measured, the voltage will vary depending on whether there are any internal insulation defects in the lithium-ion battery (see table below).

**Insulation defect locations and observed potentials**

Insulation defect location	Voltage observed between the positive electrode and the enclosure aluminum
Between positive electrode and enclosure aluminum	0 V
Between negative electrode and enclosure aluminum	Up to 4 V
Between electrolyte and enclosure aluminum	Up to 2.7 V
No insulation defect	Indeterminate

Observe the following precautions when measuring the enclosure potential.

**Input resistance**

The observed voltage will be indeterminate when you measure a non-defective lithium-ion battery with no insulation defects. Consequently, it is necessary to connect a resistor with a high resistance between the voltmeter’s HIGH and LOW terminals so as to determine the electrical potential. For this instrument, it is recommended to set the input resistance to **AUTO** and connect a resistor externally with a resistance of 10 MΩ to 1 GΩ between the voltmeter’s HIGH and LOW terminals. (p.76)

## Response time

The 63% response time can be calculated using the following formula, where  $R_p$  indicates the resistance between the HIGH and LOW terminals and  $C_p$  the capacitance between the lithium-ion battery's positive electrode and its enclosure aluminum:

$$\text{63\% response time} = C_p R_p$$

As an example, a  $C_p$  value of 10 nF and an  $R_p$  value of 100 M $\Omega$  would result in a 63% response time of 1 sec. Allow a stabilization time of  $(3 \times C_p R_p)$  to  $(5 \times C_p R_p)$  before measuring the voltage after connecting the probes to the measurement target.

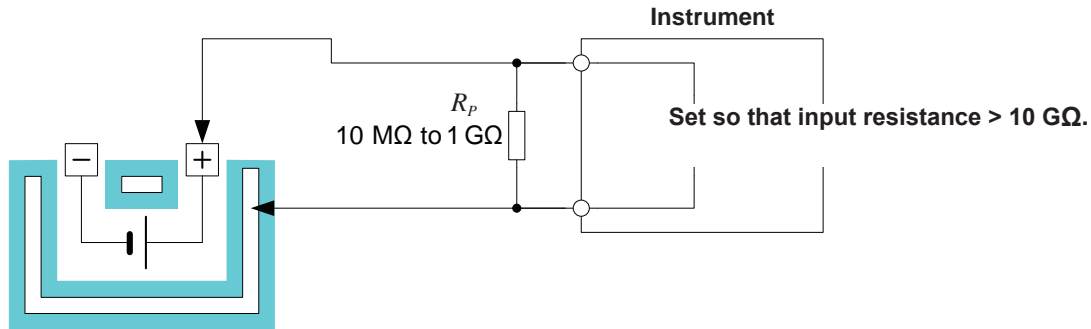

## Contact check

When performing enclosure potential measurement, a voltage reading close to 0 V generally indicates a non-defective target. However, the instrument will indicate a voltage close to 0 V even when the probes are not connected to the measurement target due to the resistance  $R_p$  connecting the HIGH and LOW terminals. Poor contact is a particular issue with the enclosure aluminum due to the fact that it is coated with an insulating film. Be sure to enable the instrument's contact check function so that you do not make judgments based on measured values obtained due to poor contact.

## Charge state

The observed voltage depends on the battery's charge state (SOC: State of charge). To increase the reproducibility of measurement, use as consistent a charge state as possible.

## Noise countermeasures

Since the output resistance for the observed voltage is extremely high, it is necessary to implement adequate noise countermeasures.

**(1) Use shielded wire for measurement cables and connect the shielding to the instrument's LOW terminal.**

Choose shielded wire that uses Teflon or polyethylene as an insulating material (between the shielding and the internal conductor). Shielding wire that uses polyvinyl chloride (PVC) as an insulating material will generate an error component due to its low insulation resistance.

**(2) Synchronize the instrument's integration time to the power supply cycle (PLC setting).**

**(3) Be sure to ground the instrument's power supply.**

## Appx. 3 Causes of Error in Voltage Measurement

### Thermal electromotive force

Thermal electromotive force is the potential difference that occurs at connections between different metals, for example between the measurement cable's metal pins and the measurement target. When this thermal electromotive force is large, an error will be introduced to measurements (see figure below).

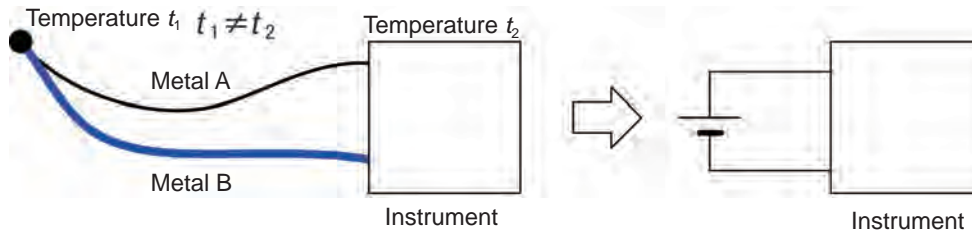

Figure. Occurrence of Thermal Electromotive Force

The magnitude of thermal electromotive force varies with the combination of metals involved. In general, the larger the temperature difference, the larger the thermal electromotive force.

Since the instrument's measurement terminals are made of copper, it is possible to minimize the effects of thermal electromotive force by using copper for contacts such as banana terminals and crimp terminals and as a wiring material. Typical banana terminals and crimp terminals use brass as a material, making them poorly suited for use when making precise, microvolt-scale measurements. Use cables with low electromotive force with copper terminals as measurement cables when calibrating the instrument.

#### Examples of high thermal electromotive force

- Setups in which the measurement circuit contains a fuse, temperature fuse, thermistor, bimetal components, or thermostat
- Setups in which single stable relay contacts are used to switch measurement circuits
- Setups in which the instrument is connected to the measurement target by means of alligator clips
- Setups in which the measurement terminals or measurement cable metal pins are held by hand
- Setups in which the temperature of the measurement target or instrument is unstable
- Setups in which different wiring materials are used for the HIGH and LOW terminals

**Thermal electromotive force relative to copper**

Metal	Thermal electromotive force ( $\mu\text{V}/^\circ\text{C}$ )
Nickel	-22.4
Platinum	-7.6
Aluminum	-3.4
Lead	-3.2
Brass	-1.6
Carbon	-0.6
Silver	-0.2
Zinc	0
Copper	0
Gold	0.2
Iron	12.2

Use a metal with a positive value for contacts facing copper and a metal with a negative value for the opposite side. (Chronological Scientific Table, 2006 Edition)

**Effects of input resistance**

When the measurement target has a large output resistance, measured values will be attenuated by the instrument’s input resistance. Caution is particularly warranted when selecting the 100 V range or the 1000 V range, or when fixing the input resistance to **10 M $\Omega$**  for the 100 mV range to the 10 V range.

Example: Measuring a coin battery with an open voltage of 3 V with the input resistance set to **10 M $\Omega$**  and a measurement target output resistance of 1 k $\Omega$

$$\frac{10 \text{ M}\Omega}{10 \text{ M}\Omega + 1 \text{ k}\Omega} \times 3 = 2.9997 \text{ V}$$

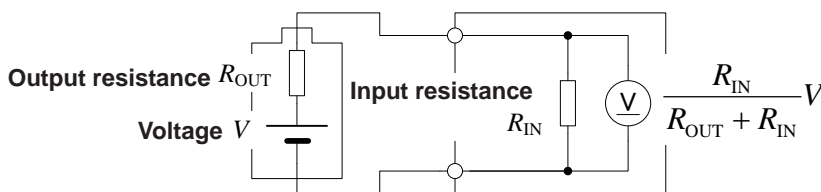

Figure. Effects of Input Resistance

**Effects of bias current**

A miniscule current flows to the instrument’s input terminal. This current, which is needed in order to drive the instrument’s measurement circuit, is known as a bias current. When the measurement target has a large output resistance, the measurement error caused by the bias current will increase in magnitude.

Example: Using a measuring instrument with a bias current of 30 pA when dividing a 100 mV voltage with a  $R_1 = R_2 = 1\text{ M}\Omega$  resistor yields the following measured value.

$$R_{\text{OUT}} = 1\text{ M}\Omega / 1\text{ M}\Omega = \frac{1\text{ M}\Omega \cdot 1\text{ M}\Omega}{1\text{ M}\Omega + 1\text{ M}\Omega} = 500\text{ k}\Omega$$

$$100\text{ mV} \times \frac{1\text{ M}\Omega}{1\text{ M}\Omega + 1\text{ M}\Omega} - 500\text{ k}\Omega \times 30\text{ pA} = 49.985\text{ mV}$$

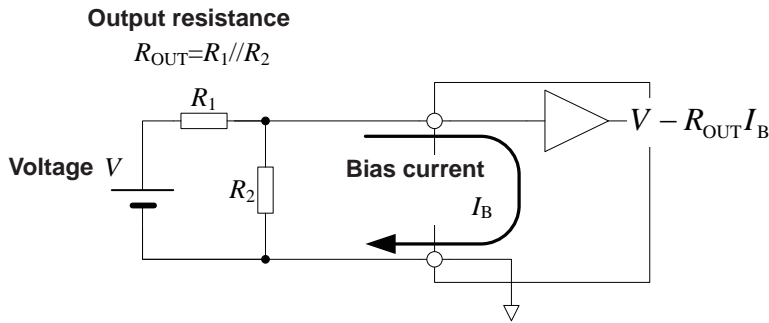

Figure. Effects of Bias Current

## Effects of high-voltage measurement

When a high voltage is measured, the instrument's internal resistance  $R_{\text{IN}}$  consumes power, generating heat.

$$\text{Power consumption } W = \frac{V^2}{R_{\text{IN}}}$$

The input resistance voltage division ratio varies with the amount of heat generated, and this variation affects measurement. The effect of heat on measured values is included in the instrument's specifications as the voltage coefficient error. Generally speaking, caution should be exercised when measuring voltages in excess of 300 V.

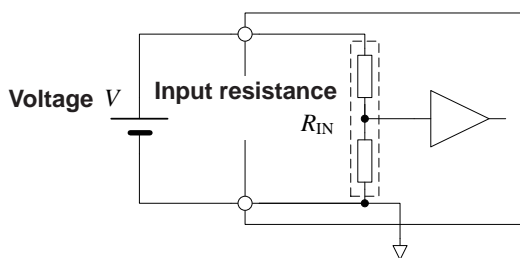

Figure. Effects of High-Voltage Measurement

## Effects of burst noise

Burst noise, which is generated by amplifiers used in signal conditioning (shown in A in "Appx. 1 Block Diagram" [p.Appx. 1]), consists of microvolt-order voltage shifts that last from several seconds to several minutes. This type of noise is believed to be caused by lattice defects and contamination in the amplifier. Although Hioki strives to carry out inspections to reduce burst noise, it is not possible to completely eliminate this type of noise.

In applications requiring precise measurement, use statistical techniques to ensure the required level of precision, for example by acquiring multiple data points over an extended period of time and then eliminating those measured values that deviate from the distribution.

# Appx. 4 Noise Countermeasures

## Effects of induced noise

A significant amount of noise may be generated by components and devices such as power cords, fluorescent lights, solenoid valves, and computer displays. The following phenomena may result in noise that affects resistance measurement:

1. Capacitive coupling from high-voltage circuits
2. Electromagnetic coupling from high-current circuits

### Capacitive coupling from high-voltage circuits

Current flowing in from a high-voltage circuit is dominated by the coupled capacitance. As an example, a current of about 38 nA will be induced when a 100 V commercial power line and wiring used to measure resistance undergo capacitive coupling at 1 pF:

$$i_N = \frac{V}{Z} = 2\pi \cdot 60 \cdot 1 \text{ pF} \cdot 100 \text{ V}_{\text{RMS}} = 38 \text{ nA}_{\text{RMS}}$$

The noise current is converted into the noise voltage  $R_{OUT}i_n$  by the output resistance  $R_{OUT}$ . If the output resistance is 1 kΩ, noise of 38 μV<sub>RMS</sub> will be superposed onto the detected voltage, causing a change in the measured value (see Figure 1).

$$V_{\text{DISPLAY}} = V + R_{OUT}i_N = V + 1 \text{ k}\Omega \cdot 38 \text{ nA}_{\text{RMS}} = V + 38 \text{ }\mu\text{A}_{\text{RMS}}$$

Close to high-voltage circuits, it is effective to shield measurement cables and the measurement target with a low-impedance line from the instrument (see Figure 2). The instrument's LOW terminal is a low-impedance line.

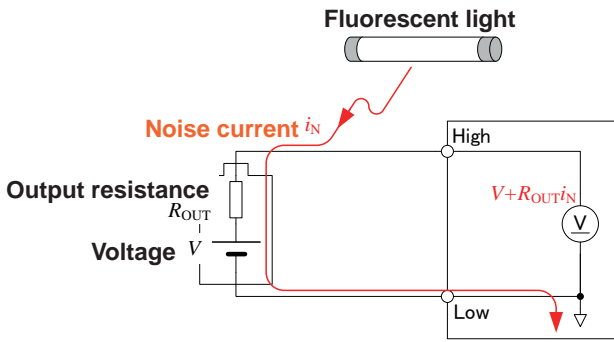

Figure 1. Noise Coupling from a High-voltage Circuit

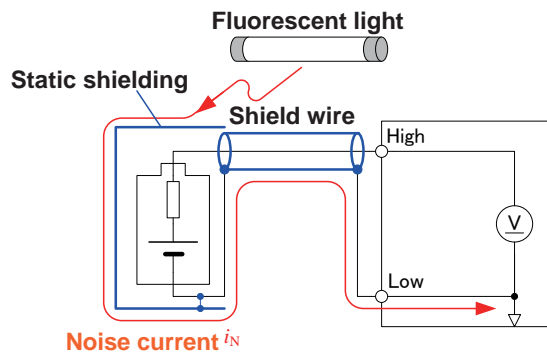

Figure 2. Noise Countermeasures Using Shielding

## Electromagnetic coupling from a high-current circuit

High-current circuits give off a magnetic field, and even larger magnetic fields may be generated by transformers or choke coils with a large number of turns. The voltage induced by a magnetic field is affected by distance and area (see Figure 3). A voltage of about 0.75  $\mu\text{V}$  will be generated in a 10  $\text{cm}^2$  loop positioned 10 cm away from a 1 A commercial power supply.

$$v_N = \frac{d\phi}{dt} = \frac{d\left(\frac{\mu_0 IS}{2\pi r}\right)}{dt} = \frac{4\pi \cdot 10^{-7} fI}{r}$$

$$= \frac{4\pi \cdot 10^{-7} \cdot 60 \text{ Hz} \cdot 0.001 \text{ m}^2 \cdot 1 \text{ A}_{\text{RMS}}}{0.1 \text{ m}} = 0.75 \mu\text{V}_{\text{RMS}}$$

To counter the effects of electromagnetic coupling, it is effective to keep voltage detection wires away from lines that are generating noise and to twist them together (see Figure 4).

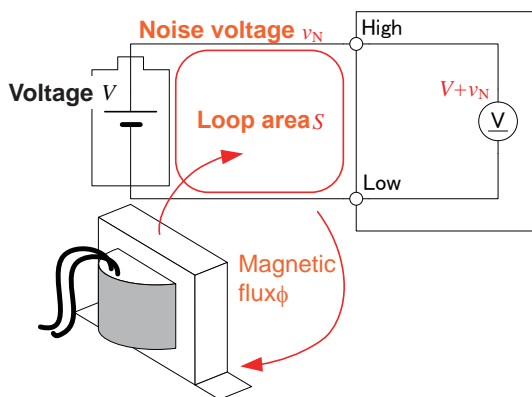

Figure 3. Noise Coupling from a High-current Circuit

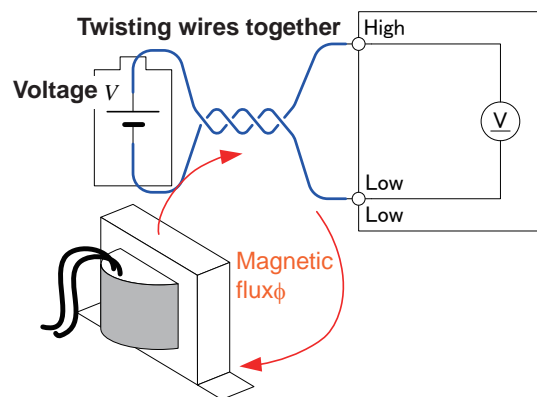

Figure 4. Noise Countermeasure: Twisting Wires Together

## If induced noise is caused by the commercial power supply

Induced noise caused by commercial power supplies can come not only from commercial power lines and power outlets, but also from fluorescent lights and household appliances. Such noise depends on the commercial power supply frequency and occurs at a frequency of 50 Hz or 60 Hz.

One method typically used to reduce the effects of noise caused by commercial power supplies is to set the integration time to a whole-number multiple of the power supply cycle (see Figure 5).

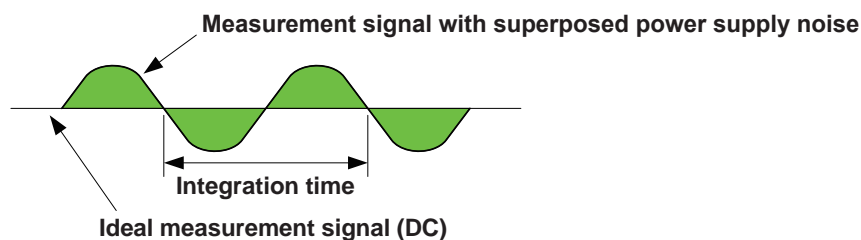

Figure 5. Averaging of Noise through Integration

Using the instrument with the power supply frequency set to 60 Hz in a region with 50 Hz power will cause measured value wobble even if the integration time is set in PLC units.

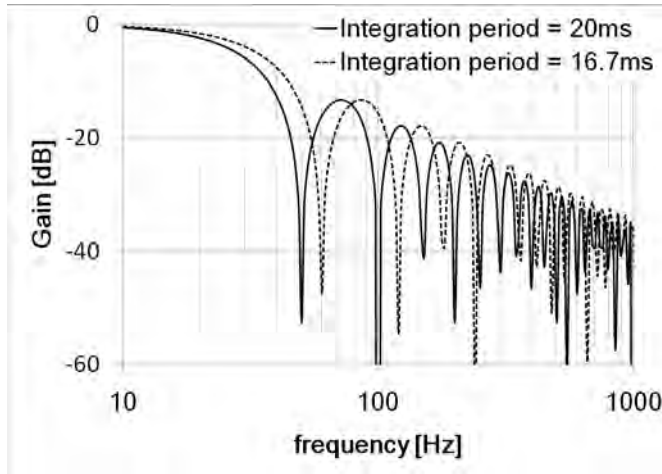

Figure 6. Noise Rejection Characteristics Using Integration

## Effects of conductive noise

Conductive noise embodies a channel of potential noise introduction that is separate from induced noise, which is superposed on measurement targets or measurement cables. Conductive noise is superposed on power lines or control lines such as USB. Various devices are connected to power lines, including motors, welding machines, and inverters. Large spike currents flow to the power supply while such equipment is operating, as well as when it starts and stops. These spikes combine with the power line’s wiring impedance to create a large spike voltage in the power line and the power supply’s ground line, and that spike voltage may affect measuring instruments.

Similarly, noise may be introduced from the control lines of connected external devices. Noise introduced from external devices’ power supplies and noise generated by DC-DC converters and other components inside external devices may enter the measuring instrument via its USB or EXT I/O wiring (see Figure 1).

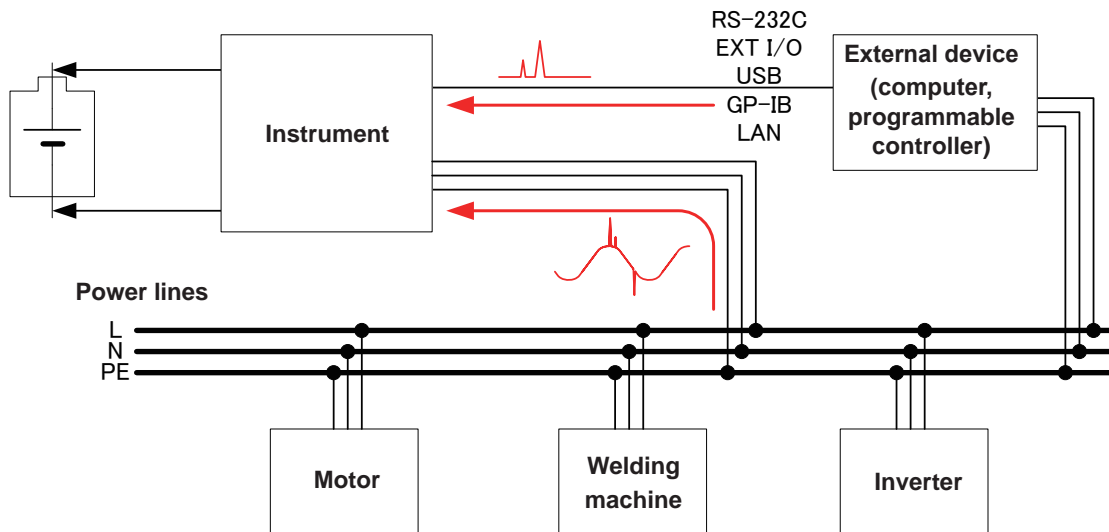

Figure 1. Ingress of Conductive Noise



An effective approach for dealing with conductive noise is to implement countermeasures while monitoring the results with the Hioki 3145 Noise HiLogger. Once the offending circuit has been identified, the countermeasures depicted in Figure 2 provide an effective way to address the issue.

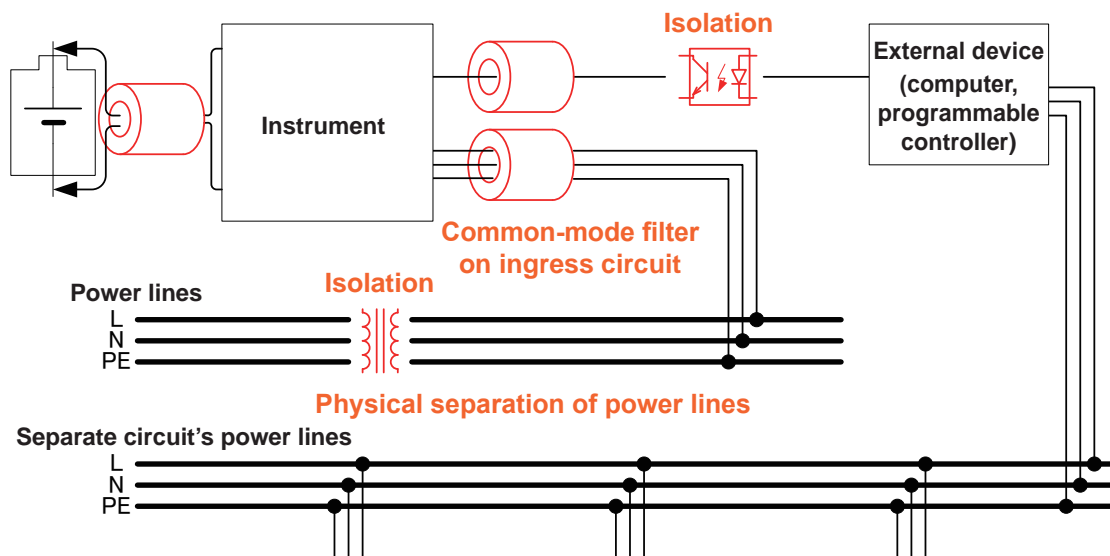

Figure 2. Conductive Noise Countermeasures

### Physically separating power lines

It is desirable that powered devices, welders, and similar equipment be connected to a power supply on a separate circuit than the instrument.

### Inserting a common-mode filter (EMI choke) into the ingress circuit

For maximum effectiveness, choose a common-mode filter with high impedance. The more filters are added, the more effective this measure will be.

### Isolation

Photoisolation of control lines is an effective noise countermeasure. It is also effective to isolate power lines with a noise-suppressing transformer. Please note that use of a common ground line across the isolation will reduce the effectiveness of this approach.

## Appx. 5 Self-calibration

The instrument's self-calibration function serves to maintain measurement precision by correcting for fluctuations in the internal measurement circuitry. The instrument is designed for automatic self-calibration.

Specific operation depends on the measurement state (p.37)

<b>RUN state</b>	▶ Self-calibration is performed between measurements.
<b>STOP state and when using the EXTERNAL trigger source</b>	▶ Self-calibration is performed continuously while waiting for a trigger. When a trigger is input, self-calibration stops, and measurement starts. Once measurement is complete, self-calibration resumes. If the trigger function's "number of measurements" parameter is set to a value other than 1, self-calibration will resume after the set number of measurements has been performed.

## Appx. 6 Measuring Multiple Targets

To measure multiple targets with a single instrument, you will need to provide an external switching relay. Please note the following important considerations when designing the switching device:

### Relay selection

**(1) Choose a relay with low thermal electromotive force.**

Thermal electromotive force increases in the following order:

Latching < OptoMOS relays < Single-stable (high sensitivity) relays < Single-stable relays

**(2) Choose a relay that delivers stable contact performance even under minuscule load.**

Power relays experience poor contact under conditions of minuscule load. Be sure to use a relay designed for use with low signals or an OptoMOS relay.

**(3) Choose a relay whose contacts have a rated voltage that is at least 200% greater than the switching voltage.**

A relay with a rated voltage of 110 V will support a switching voltage of 55 V or less.

**(4) When using an OptoMOS relay, choose a relay with a small output pin capacitance.**

When the capacitance, calculated by multiplying the output pin capacitance by the number of contacts, increases, the contact check function will generate a result of “connected” even when all contacts are open.

**(5) When the instrument’s input resistance is set to 10 M $\Omega$ , measured values may decrease due to the effects of contact resistance.**

Example: An error of 1 ppm will occur if the contact resistance is 10  $\Omega$  and the input resistance is 10 M $\Omega$ .

**(6) Examples of appropriate relays**

Panasonic ATXS20620: High sensitivity, 4.5 V single-stable, suitable for use with minuscule loads

Panasonic AT26620: 4.5 V latching, suitable for use with minuscule loads

Panasonic AQW216: OptoMOS relay, max. 120  $\Omega$  on-resistance, 50 pF output pin capacitance

## Taking steps to prevent short-circuits

Exercise caution concerning the following so as to avoid shorting the measurement target:

- (1) Design the switching device so that all contacts are off when it is turned on and off.
- (2) Allow an interval of time when all contacts are off when switching contacts (“break before make”).
- (3) Insert a fuse into the measurement line.

Avoid use of fuses with a rating of 1 A or less and resettable fuses as they have a large thermal electromotive force.

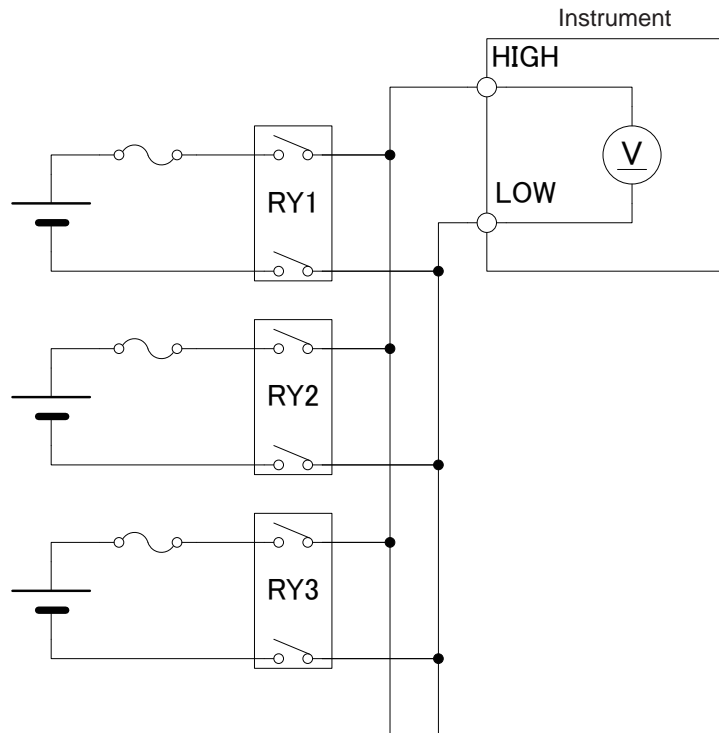

# Appx. 7 Rack Mounting

Rack-mounting hardware can be attached to the instrument after removing the screws on the sides.

## Rack-mounting hardware reference figures

### Spacer (EIA- and JIS-compliant)

This spacer should be installed between the instrument and the rack-mounting hardware. Two are required.

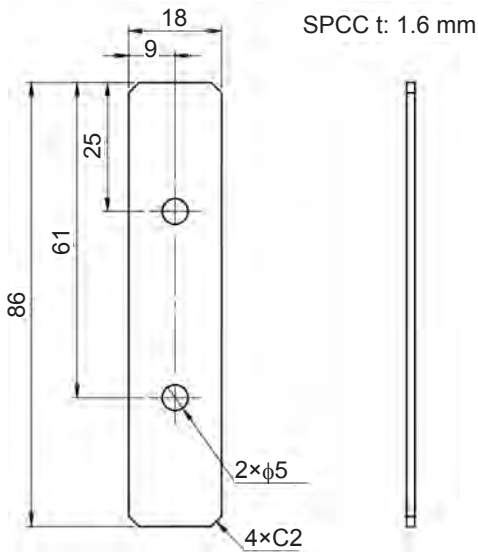

### Rack-mounting bracket (EIA-compliant, to mount 1 instrument)

Two are required (one on the left and one on the right).

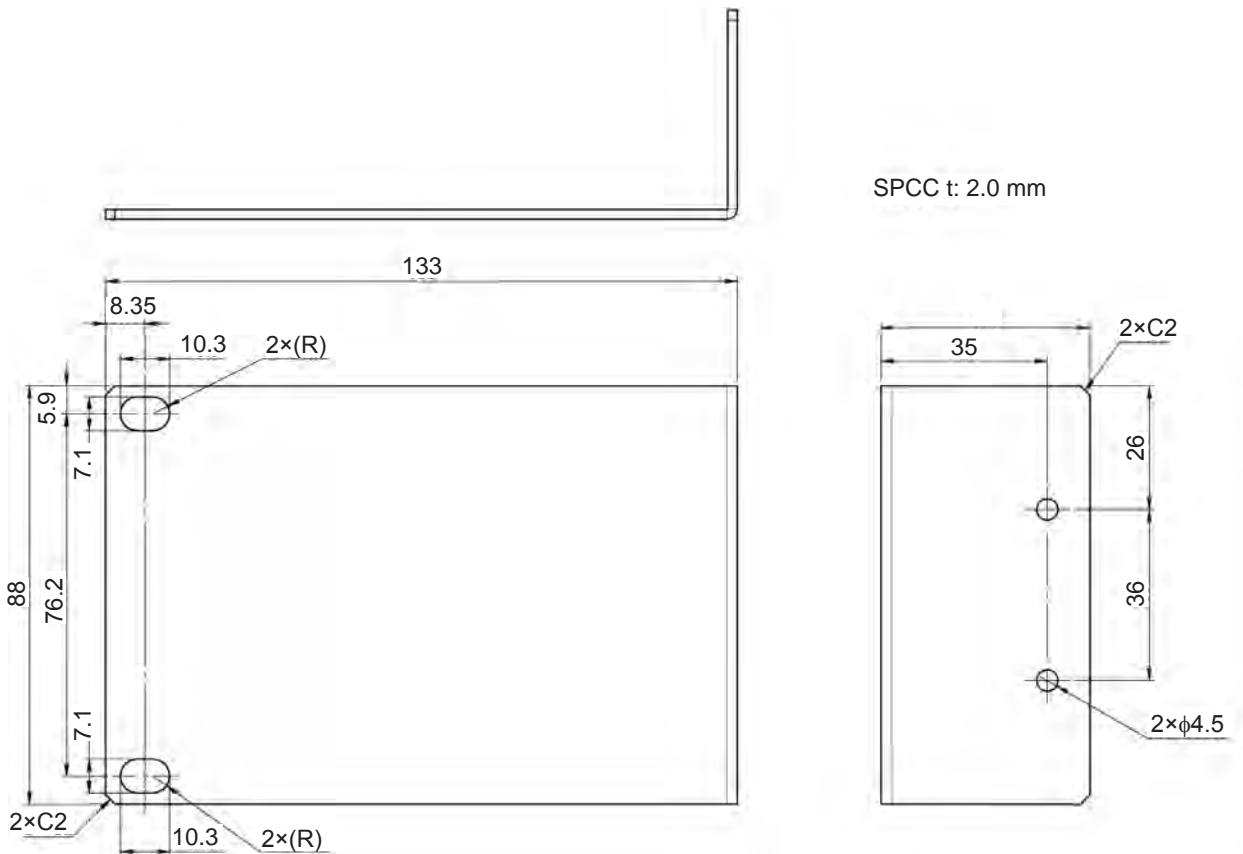

**Rack-mounting bracket (EIA-compliant, to mount 2 instruments)**

Two are required (one on the left and one on the right).

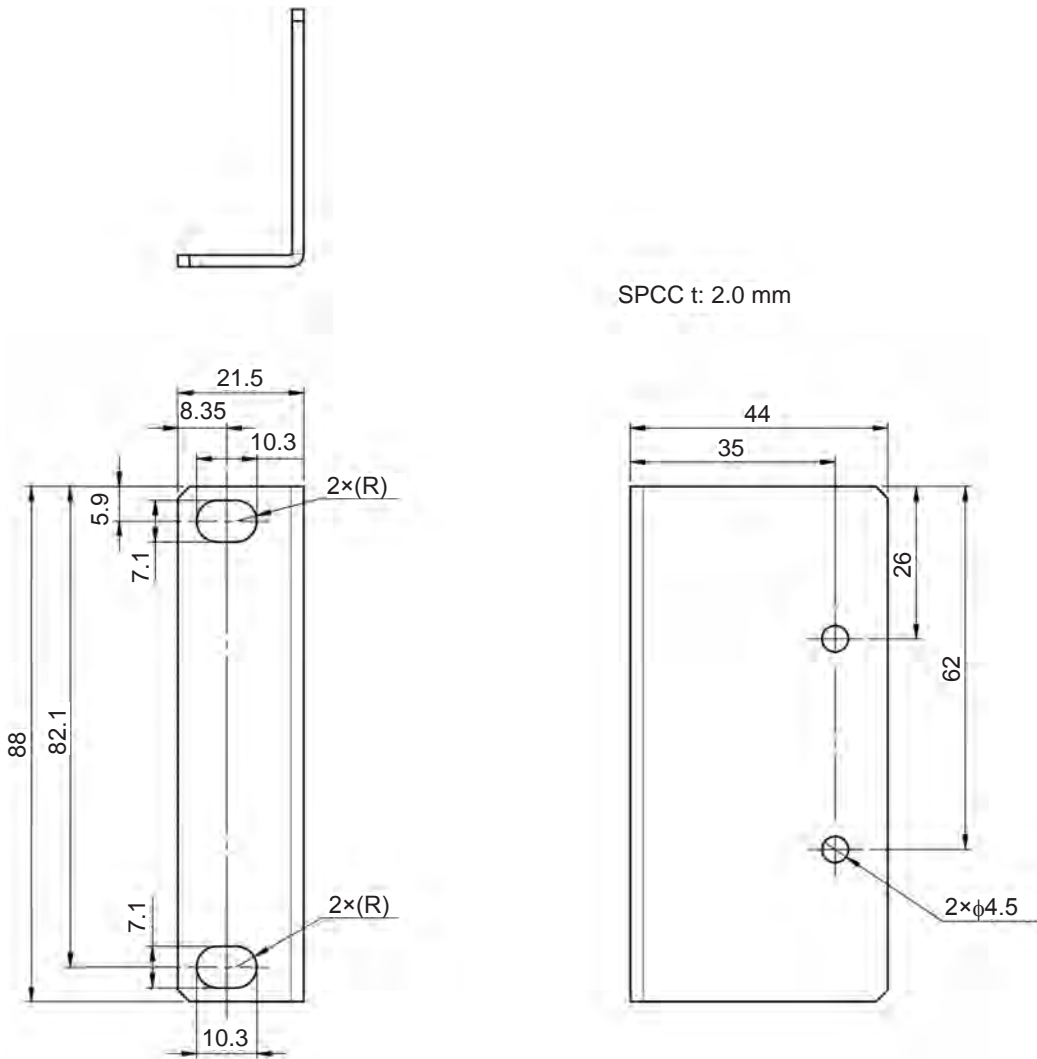

**Rack-mounting bracket (JIS-compliant, to mount 1 instrument)**

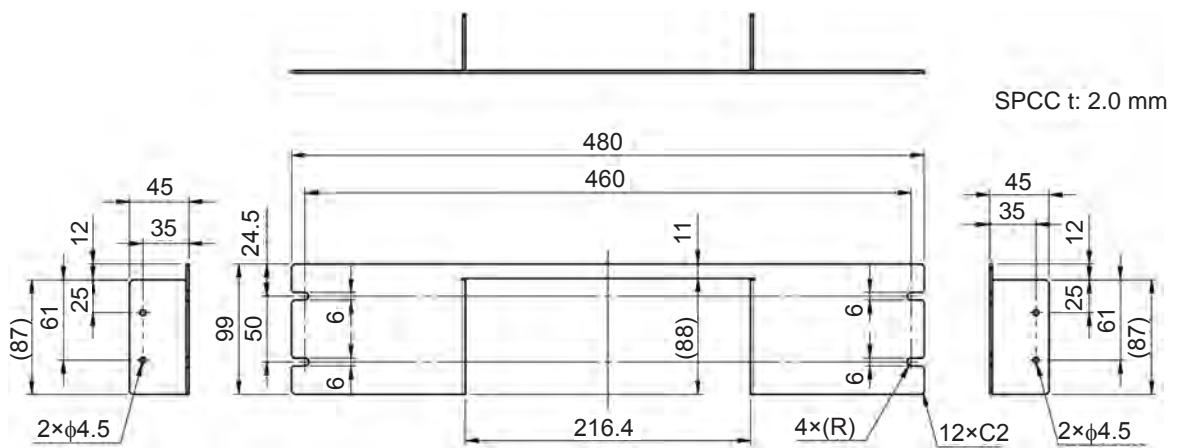

**Rack-mounting bracket (JIS-compliant, to mount 2 instruments)**

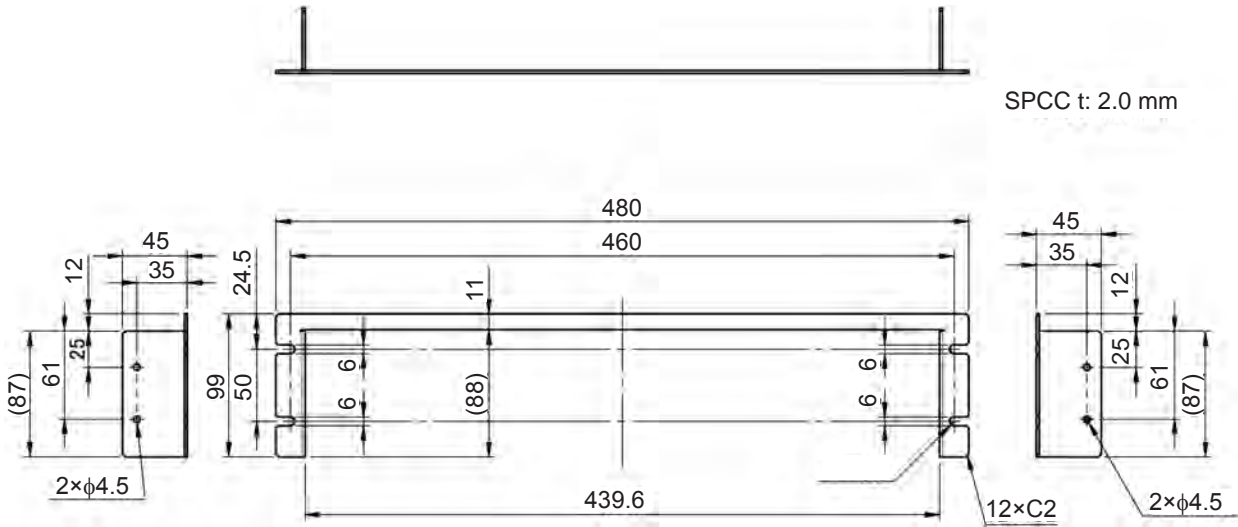

**Connecting bracket (EIA- and JIS-compliant)**

Two are required (same design used on both left and right).

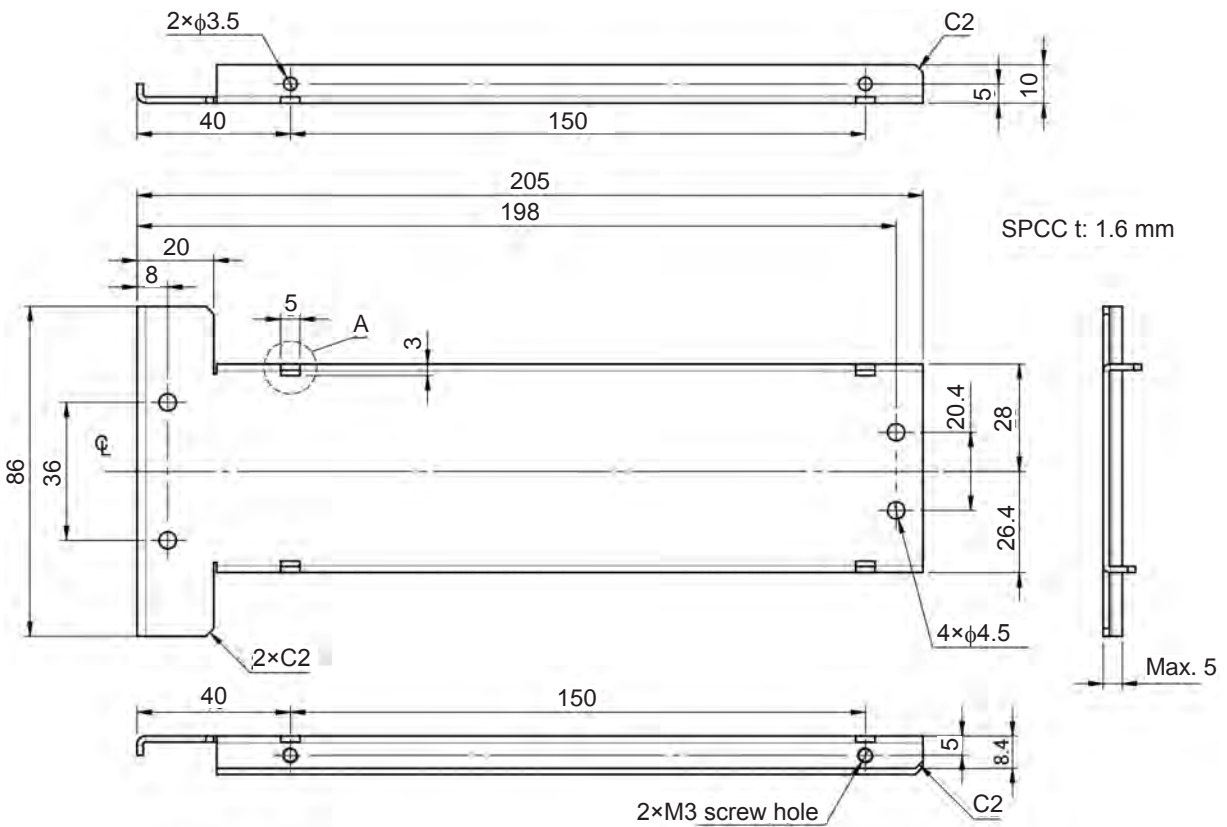

Notches (one of which can be found in area labeled A) serve to prevent distortion of the shape of the hole caused by flexing (total of four).

## Installation instructions

Be careful not to lose the parts removed from the instrument as you may need to use them again.

### WARNING

To prevent damage to the instrument and electric shock, observe the following precautions when choosing screws:



- When installing the rack-mounting brackets on the sides of the instrument, use screws with a nominal length that does not exceed the thickness of the bracket by more than 3.5 mm (so that the screw does not protrude into the instrument by more than 3.5 mm).
- When removing the rack-mounting brackets and restoring the instrument to its bench-top configuration, use the screws with which the instrument shipped at the time of purchase (feet: M3 × 8 mm; sides: M4 × 6 mm). If those screws are lost or damaged, please contact your authorized Hioki distributor or reseller.

When installing the instrument in a rack, use a commercially available shelf or other suitable part to ensure adequate strength.

### (1) Remove the feet on the bottom of the instrument and the screws from the side covers.

Screws (bottom: four M3 × 8 mm screws; sides: four M4 × 6 mm screws)

1

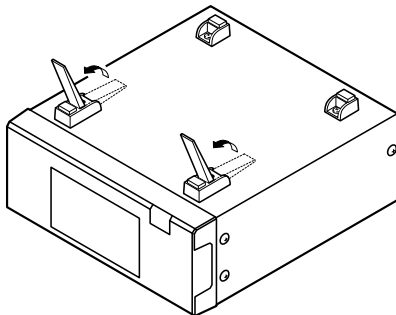

2

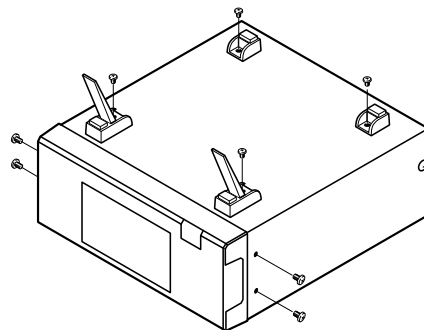

## (2) Attach the rack-mounting brackets.

For one instrument

### EIA-compliant hardware

You will need: Four M4 × 10 mm screws

Insert a spacer on both sides of the instrument and attach the rack-mounting brackets.

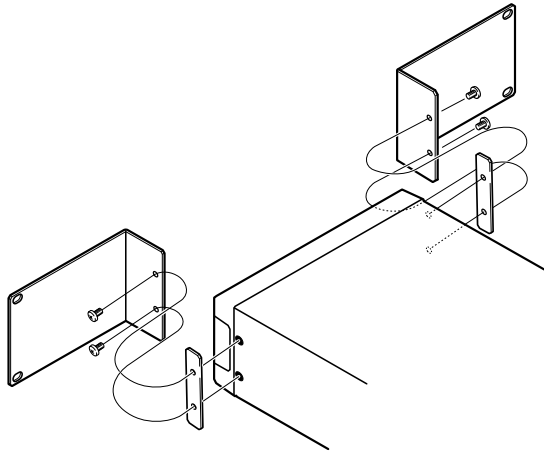

### JIS-compliant hardware

You will need: Four M4 × 10 mm screws

Insert a spacer on both sides of the instrument and attach the rack-mounting brackets with the M4 × 10 mm screws.

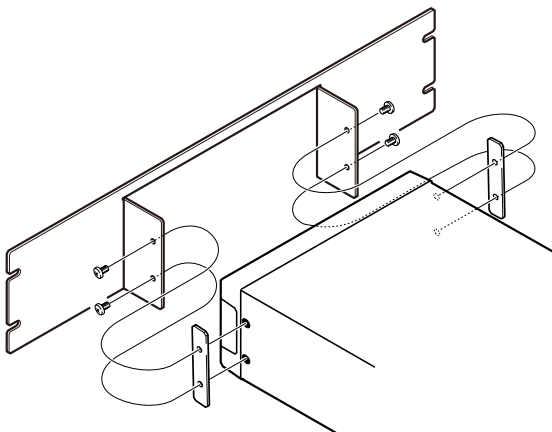



## For two instruments

## EIA-compliant hardware

You will need: Ten M4 × 10 mm screws and four M3 × 6 mm screws

- 1 Insert a spacer on the outside of each instrument (no spacers are needed where the connecting brackets will be attached) and attach the rack-mounting brackets with the MR × 10 mm screws (total of four).
- 2 Attach the connecting brackets to the inside of each instrument using the M4 × 10 mm screws (total of six).
- 3 Position the instruments so that the connecting brackets are aligned and secure them together with the four M3 × 6 mm screws (on top and bottom).

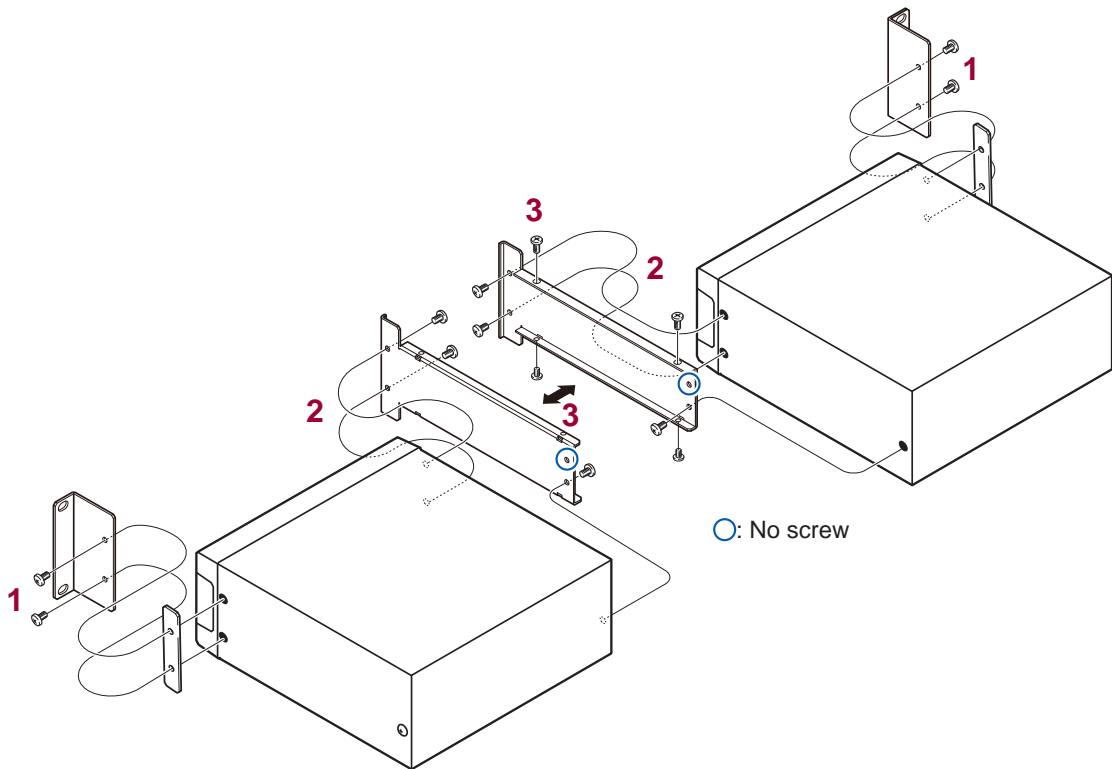

### JIS-compliant hardware

You will need: Ten M4 × 10 mm screws and four M3 × 6 mm screws

- 1** Attach a connecting bracket to the inside of each instrument with M4 × 10 mm screws (total of six).
- 2** Position the instruments so that the connecting brackets are aligned and secure them together with the four M3 × 6 mm screws (on top and bottom).
- 3** Insert a spacer on the outside of each instrument (no spacers are needed where the connecting brackets are attached) and attach the rack-mounting bracket with the M4 × 10 mm screws (total of four).

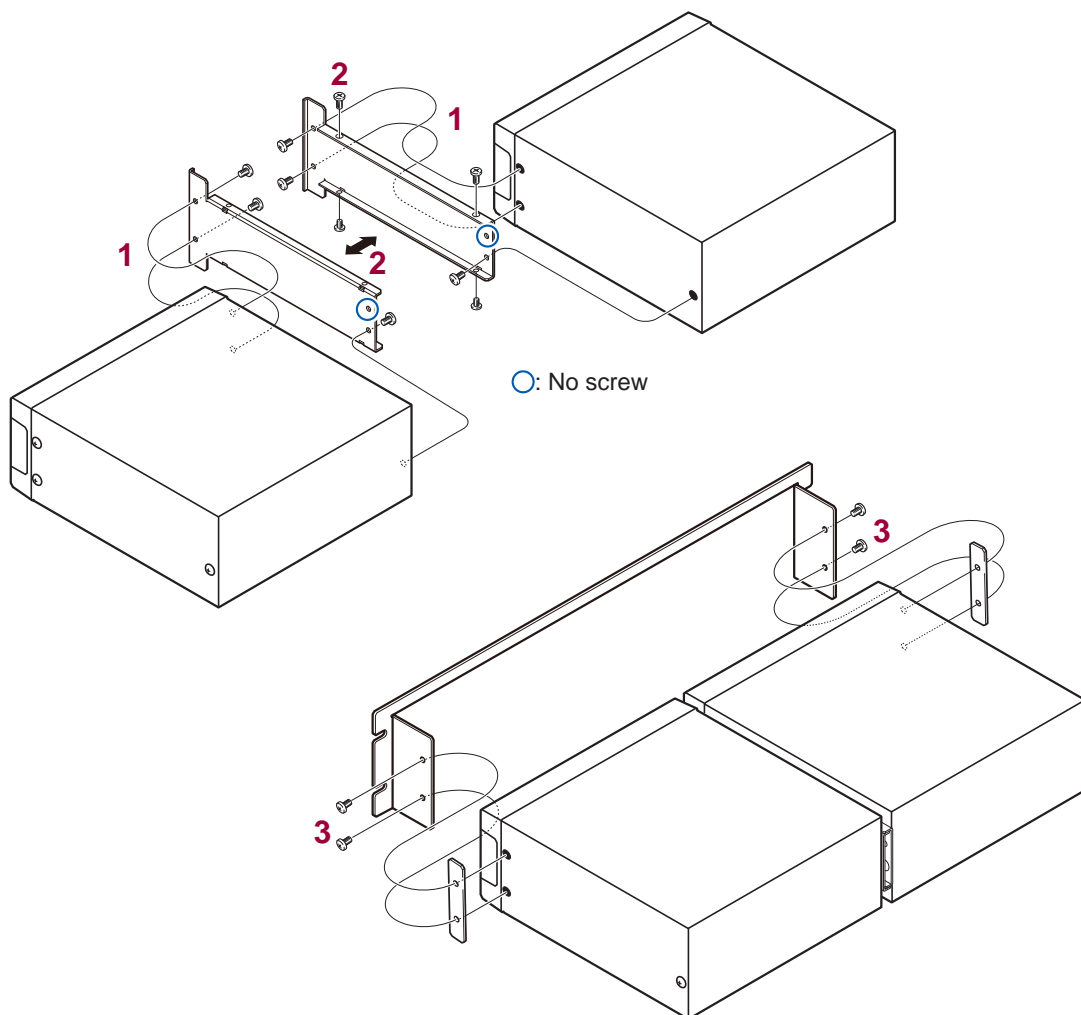

# Appx. 8 Outline Drawings

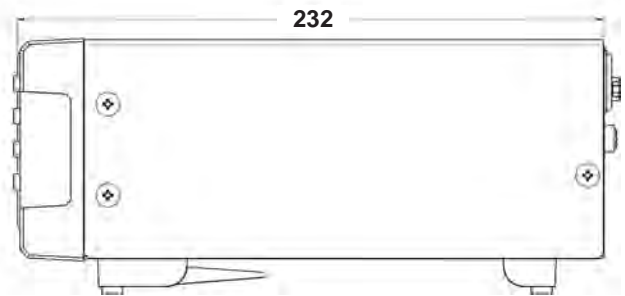
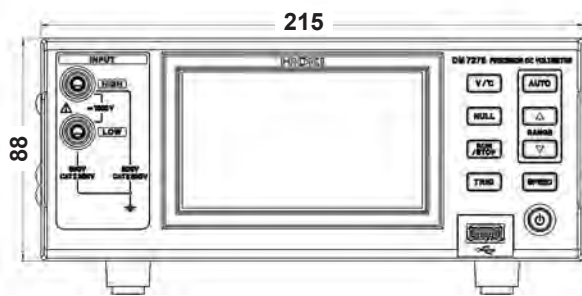
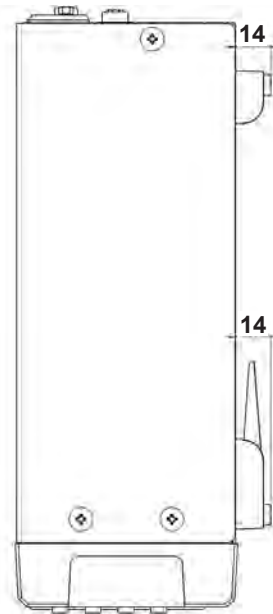
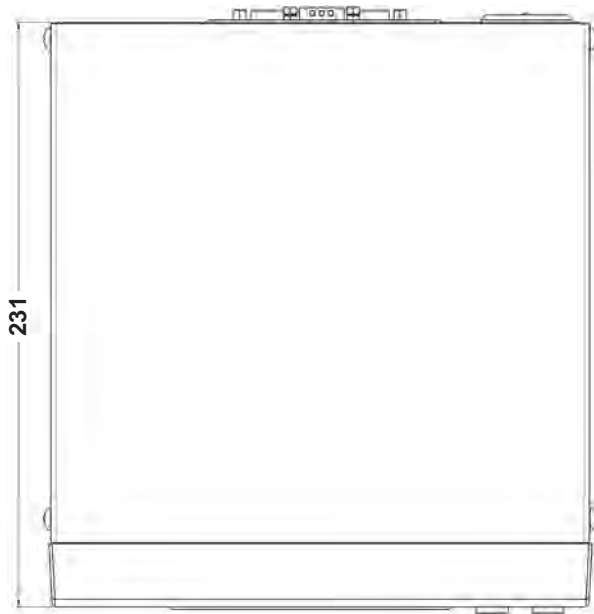

(Unit: mm)

## Appx. 9 Calibration

### Calibration conditions

- Ambient temperature and humidity: 23°C ±5°C, 80% RH or less
- 60 min. warm-up time
- Power supply: 100 to 240 V ±10%, 50 Hz/60 Hz, distortion rate of 5% or less
- External magnetic field close to that characterizing terrestrial magnetism
- Settings initialized with reset

### Calibration equipment and calibration points

Measurement function	Range	Calibration point	Equipment
DC voltage	100 mV	0 mV, +100 mV	Fluke multi-function calibration instrument 5730A equivalent
	1000 mV	0 mV, +1000 mV	
	10 V	0 V, +10 V	Fluke low-thermal-electromotive-force cable 5440A-7005 equivalent
	100 V	0 V, +100 V	
	1000 V	0 V, +1000 V	
Temperature		25°C: 2186.0 Ω (±0.1%) input	Fluke multi-product calibrator 5520A equivalent

### Connection methods

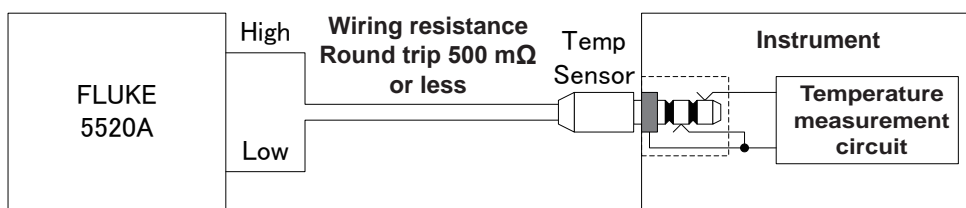
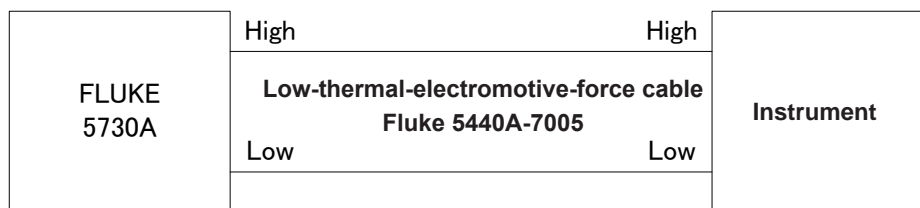

#### Voltmeter calibration

Use all copper wiring and twist the high and low wires together. Measured values are particularly prone to the effects of thermal electromotive force when using alligator clips for connections.

#### Thermometer calibration

Connect the sleeve side of the temperature measurement circuit to the low side of the calibration device.

## Appx. 10 Adjustment

The adjustment screen accessible on the **MENU > SYSTEM** screen is used by Hioki for repair and adjustment purposes. It is not for customer use.

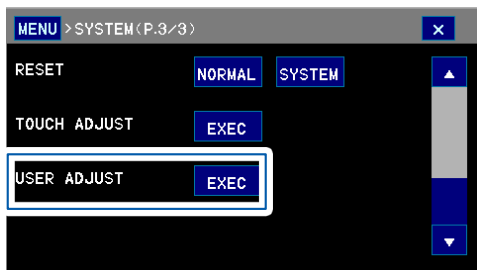



# Index

## A

ABS MODE.....	52
Absolute value judgment function.....	52
Acquiring measured values .....	97
Adjusting touch panel position.....	90
Application disc.....	2, 8
AUTO.....	35
Auto-hold .....	70

## B

Backlight.....	89
Bar graphs.....	43
BIN measurement	
Judgment results.....	44
Settings.....	57
Block diagram.....	Appx.1
Button .....	14
Buzzer .....	88

## C

Calibration .....	167, Appx.22, Appx.23
Causes of error.....	Appx.5
Cleaning .....	175
Clock.....	30
Communication cables .....	4, 10
Communication command instruction manual.....	2
Communications commands .....	97, 109, 110
Communications time .....	97
COMP.....	53
Comparator measurement	
Judgment results.....	44
Settings.....	53
Compensation .....	77
Contact check.....	71
Continuous measurement .....	37
Current Sink (NPN) and Current Source (PNP) .....	126

## D

Date.....	30
Display digits .....	48
Disposing.....	180

## E

Enclosure potential of batteries .....	72, Appx.2
EOM signal .....	130
Error displays.....	176
External control.....	125
External input and output	
Configuring.....	136
Example connections .....	134
EXT I/O.....	125

Connector.....	15
Pin layout .....	128

## F

FAST.....	36
Feet .....	14
Files.....	123
Filter.....	136

## G

GP-IB	
Cable.....	4
Connection .....	103
Connector.....	15
Settings .....	102

## H

Hold .....	70
------------	----

## I

Input resistance .....	76
Input test/output test .....	138
Inspection .....	24
Installation .....	7
Integration time.....	67
Interface settings .....	111
Internal circuit architecture .....	133

## J

Judgment.....	51
Measurement error.....	54, 59
Judgment results .....	43
Judgment tones	
BIN measurement .....	59
Comparator measurement .....	55

## K

Key lock.....	87
---------------	----

## L

LABEL .....	49
Labels.....	49
LAN	
Cable.....	4
Connection .....	108
Connector.....	15
Settings .....	105
List of default settings.....	94

Loading	
From internal memory (panel data).....	61
From USB flash drive (panel data).....	122
LOAD signal .....	129

## M

---

Main power switch.....	15
MANUAL.....	36
Measured value is fixed.....	37
Measurement cables .....	3, 9, 26, 31
Measurement count.....	39
Measurement error.....	46
Measurement range .....	18, 35
Measurement screen.....	16
Measurement speed.....	19, 36
Measuring enclosure potential.....	Appx.2
MEDIUM.....	36

## N

---

Names .....	49
Network .....	104
Noise .....	Appx.8
NPN .....	126
NULL .....	78
Number of display digits .....	48

## O

---

Operation keys .....	14
Options .....	3
Outline drawings.....	Appx.21
Outputting	
Data.....	111, 118
Measurement conditions.....	120
Outputting and print of judgment results	
Comparator measurement .....	56, 59

## P

---

PANEL.....	62, 65
Panel save	
Information that can be saved.....	61
Settings .....	62
PNP .....	126
Power cord .....	25
Power supply.....	28
Power supply frequency .....	90
Printer	
Option.....	4
Print.....	143
Print examples.....	148
Printing .....	143
Program.....	97
Programmable controller .....	126

## Q

---

Q&A.....	168
----------	-----

## R

---

Rack .....	Appx.14
Range.....	18, 35
Repair.....	167
Replacement parts .....	167
Resetting .....	93
RS-232C	
Cable.....	4
Connection.....	101
Connector.....	15
Settings .....	100
RUN.....	20, 37

## S

---

Sample application software.....	97
Saving	
Measurement conditions .....	61
Scaling.....	82
Screen .....	14, 16
Screen brightness.....	89
Screen color .....	89
Screenshots.....	118
Serial number .....	15
Service lives .....	167
Settings screen.....	16
Signal.....	129
SLOW .....	36
Smoothing .....	69
Specifications .....	151
Speed .....	19, 36
Statistical calculations .....	84
STATISTICS .....	43, 85
Statistics display.....	43
STOP.....	20, 37
Storage	
Measurement data .....	42
Sub-display.....	43
Symbols on the instrument.....	6

## T

---

Temperature compensation.....	80
Temperature display .....	18
Temperature sensor.....	27
Test leads .....	3, 9, 26, 31
Time.....	30
Timing chart.....	139
Touch panel .....	90
Transporting .....	167
Trends .....	43, 45
Trigger .....	38



TRIG signal..... 129

## U

---

### USB

Cable..... 4  
Connection..... 99  
Connector..... 15  
Settings..... 98  
USB driver..... 99  
USB flash drive  
Connector..... 14  
How to use..... 115

## V

---

Variability..... 69  
Voltage trends..... 43

## W

---

Waveform..... 45  
When the instrument starts up..... 91

## Z

---

Zero-point..... 78



# Warranty Certificate

Model	Serial No.	Warranty period One (1) year from date of purchase (___ / ___)
-------	------------	-------------------------------------------------------------------

This product passed a rigorous inspection process at Hioki before being shipped.

In the unlikely event that you experience an issue during use, please contact the distributor from which you purchased the product, which will be repaired free of charge subject to the provisions of this Warranty Certificate. This warranty is valid for a period of one (1) year from the date of purchase. If the date of purchase is unknown, the warranty is considered valid for a period of one (1) year from the product's date of manufacture. Please present this Warranty Certificate when contacting the distributor.

Accuracy is guaranteed for the duration of the separately indicated guaranteed accuracy period.

1. Malfunctions occurring during the warranty period under conditions of normal use in conformity with the Instruction Manual, product labeling (including stamped markings), and other precautionary information will be repaired free of charge, up to the original purchase price. Hioki reserves the right to decline to offer repair, calibration, and other services for reasons that include, but are not limited to, passage of time since the product's manufacture, discontinuation of production of parts, or unforeseen circumstances.
2. Malfunctions that are determined by Hioki to have occurred under one or more of the following conditions are considered to be outside the scope of warranty coverage, even if the event in question occurs during the warranty period:
  - a. Damage to objects under measurement or other secondary or tertiary damage caused by use of the product or its measurement results
  - b. Malfunctions caused by improper handling or use of the product in a manner that does not conform with the provisions of the Instruction Manual
  - c. Malfunctions or damage caused by repair, adjustment, or modification of the product by a company, organization, or individual not approved by Hioki
  - d. Consumption of product parts, including as described in the Instruction Manual
  - e. Malfunctions or damage caused by transport, dropping, or other handling of the product after purchase
  - f. Changes in the product's appearance (scratches on its enclosure, etc.)
  - g. Malfunctions or damage caused by fire, wind or flood damage, earthquakes, lightning, power supply anomalies (including voltage, frequency, etc.), war or civil disturbances, radioactive contamination, or other acts of God
  - h. Damage caused by connecting the product to a network
  - i. Failure to present this Warranty Certificate
  - j. Failure to notify Hioki in advance if used in special embedded applications (space equipment, aviation equipment, nuclear power equipment, life-critical medical equipment or vehicle control equipment, etc.)
  - k. Other malfunctions for which Hioki is not deemed to be responsible

**\*Requests**

- Hioki is not able to reissue this Warranty Certificate, so please store it carefully.
- Please fill in the model, serial number, and date of purchase on this form.

13-09

**HIOKI E.E. CORPORATION**

81 Koizumi, Ueda, Nagano 386-1192, Japan

TEL: +81-268-28-0555

FAX: +81-268-28-0559





- Please visit our website at [www.hioki.com](http://www.hioki.com) for the following:
  - Regional contact information
  - The latest revisions of instruction manuals and manuals in other languages.
  - Declarations of Conformity for instruments that comply with CE mark requirements.
- All reasonable care has been taken in the production of this manual, but if you find any points which are unclear or in error, please contact your supplier or the International Sales and Marketing Department at Hioki headquarters.
- In the interests of product development, the contents of this manual are subject to revision without prior notice.
- The content of this manual is protected by copyright.  
No reproduction, duplication or modification of the content is permitted without the authorization of Hioki E.E. Corporation.

**HIOKI**  
HIOKI E. E. CORPORATION

---

### HEADQUARTERS

81 Koizumi, Ueda, Nagano 386-1192, Japan  
TEL +81-268-28-0562 FAX +81-268-28-0568  
[os-com@hioki.co.jp](mailto:os-com@hioki.co.jp)  
(International Sales Department)

**[www.hioki.com](http://www.hioki.com)**

### HIOKI USA CORPORATION

[hioki@hiokiusa.com](mailto:hioki@hiokiusa.com) [www.hiokiusa.com](http://www.hiokiusa.com)

### HIOKI (Shanghai) SALES & TRADING CO., LTD.

[info@hioki.com.cn](mailto:info@hioki.com.cn) [www.hioki.cn](http://www.hioki.cn)

### HIOKI INDIA PRIVATE LIMITED

[hioki@hioki.in](mailto:hioki@hioki.in) [www.hioki.in](http://www.hioki.in)

### HIOKI SINGAPORE PTE. LTD.

[info@hioki.com.sg](mailto:info@hioki.com.sg)

1502EN