

HIOKI

IR3455

Instruction Manual

HIGH VOLTAGE INSULATION TESTER



EN

Oct. 2016 Edition 1
IR3455A961-00 16-10H



Contents

Introduction	1
Verifying Package Contents / Open the case ..	1
Safety Information	5
Operating Precautions	9

1 Overview **19**

1.1 Product Overview	19
1.2 Features	21
1.3 Measurement Overview	23
1.4 Names and Functions of Parts	29
1.5 Screen Setup	33

2 Measurement Preparations **35**

2.1 Supplying Power	35
2.1.1 Installing or Replacing the Battery.....	36
2.1.2 Installing the Battery Pack (Rechargeable nickel-hydrogen battery)	39
2.1.3 Connecting the AC Adapter.....	45
2.1.4 Charging the Battery Pack	47
2.2 Turning Power On and Off	50
2.2.1 Auto Power Off	51
2.3 Setting and Checking Date and Time ..	52
2.3.1 Setting Date and Time.....	52
2.3.2 Checking Date and Time.....	55
2.4 Connecting Test Lead	56
2.5 Connecting Temperature Sensor	58

3 Measurement 59

3.1	Pre-Operation Inspection	59
3.2	Measuring Insulation Resistance	62
3.2.1	Starting Measurement.....	64
3.2.2	Ending Measurement.....	70
3.2.3	Checking and Deleting Held Data.....	72
3.2.4	Automatic Discharge Function	73
3.2.5	Switching to Leakage Current Indication	74
3.2.6	Insulation Resistance Measurement Basis	75
3.2.7	Use of GUARD Terminal.....	77
3.3	Measuring Voltage	79
3.4	Measuring Temperature	82
3.4.1	Measurement Procedure	82

4 Advanced Measurement 85

4.1	Using Timer	85
4.1.1	Setting Timer/Conducting Insulation Resistance Measurement	85
4.2	Displaying PI and DAR	89
4.3	Temperature Compensation (TC)	93
4.3.1	Performing Temperature Compensation	93
4.3.2	Exiting Temperature Compensation Mode	96
4.4	Step Voltage Test	97
4.4.1	Setting and Conducting a Step Voltage Test	98
4.4.2	Viewing Detailed Data of Each Step after Step Voltage Test	101
4.4.3	Exiting Step Voltage Test Mode.....	103

5 Recording Measurement Data (Memory Function) 105

5.1	Recording Measurement Data	107
5.1.1	Manual Recording (Recording result of one measurement session)	107
5.1.2	Logging Recording (Recording at regular intervals)	110
5.2	Checking Recorded Data	118
5.3	Deleting Recorded Data	123
5.3.1	Deleting Data of Chosen No.....	123
5.3.2	Deleting all Data	124

6 Other Functions 125

6.1	Changing and Checking Interval Setting for PI Calculation	125
6.1.1	Changing Interval Setting	125
6.1.2	Checking Interval Setting	127
6.2	Changing and Checking Voltage Application Time for Step Voltage Test	128
6.2.1	Changing Time Setting.....	128
6.2.2	Checking Time Setting	130
6.3	Entering Temperature and Humidity Measured with External Thermometer and Hygrometer	131
6.3.1	Entering and Saving	132
6.3.2	Clearing Indications of Temperature and Humidity Stored Data	135
6.4	Communicating with PC	136
6.4.1	Installing Data Analysis Software for 3455	137
6.4.2	Installing Driver.....	138
6.4.3	Downloading Data to Save to PC/ Setting up Instrument on PC	139

7 Specifications 141

7.1	General Specifications	141
7.2	Measurement Specifications	146
7.2.1	Insulation Resistance Measurement	146
7.2.2	Leakage Current Measurement	149
7.2.3	Voltage Measurement	150
7.2.4	Temperature Measurement	151
7.3	9750-01/-02/-03/-11/-12/-13 and 9751-01/-02/-03 ALLIGATOR CLIPs Specifications	152

8 Maintenance and Service 153

8.1	Troubleshooting	154
8.2	Cleaning	156
8.3	Error Display	156
8.4	Performing System Reset	158
8.5	Discarding the Instrument	159

Appendix 163

Appendix 1	Test Voltage Characteristic Graph	163
Appendix 2	Example of Insulation Resistance Criteria	164
Appendix 3	Example of PI Criteria (Polarization Index)	164
Appendix 4	Temperature Compensation Table	165

Introduction

Thank you for purchasing the Hioki IR3455 High Voltage Insulation Tester. To obtain maximum performance from the instrument, please read this manual first, and keep it handy for future reference.

◆ Registered trade mark

- Microsoft and Windows are either registered trademarks or trademarks of Microsoft Corporation in the United States and other countries.
- Adobe and Adobe Reader are trademarks of Adobe Systems Incorporated.

Verifying Package Contents / Open the case

When you receive the instrument, inspect it carefully to ensure that no damage occurred during shipping. In particular, check the accessories, panel switches, and connectors. If damage is evident, or if it fails to operate according to the specifications, contact your authorized Hioki distributor or reseller.

◆ Open the case

Appearance of Case

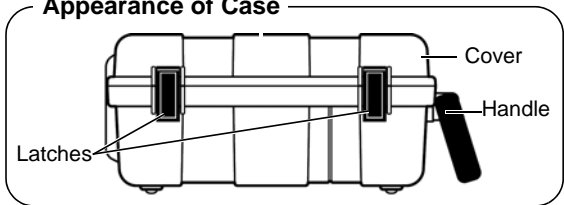

Open the case by releasing the two latches.
(See next page.)

Procedure

1. Draw the latch outwards with your finger.

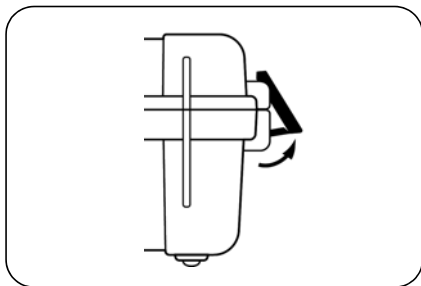

2. While raising the entire latch, place a finger on the top of the latch and pull it out.

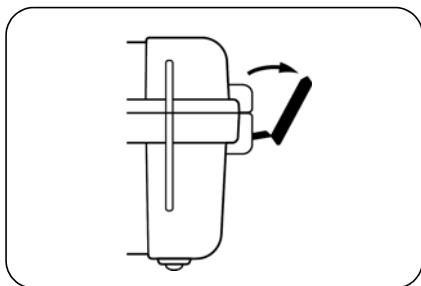

Main Unit

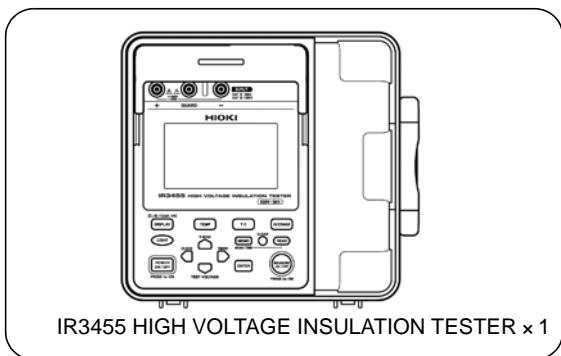

Accessories



9750-01,-02,-03 TEST LEAD (Red, Black, Blue)
Lead length Approx. 3 m x 1 each



9751-01,-02,-03 ALLIGATOR CLIP (Red, Black, Blue)
x 1 each



Instruction Manual
(This book) x 1



LR6 alkaline battery x 6

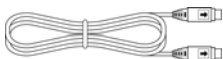

USB Cable x 1



CD (Data Analysis
Software for 3455)* x 1

*The latest version can be downloaded
from our web site.

Options



9750-11,-12,-13 TEST LEAD

(Red, Black, Blue Lead length Approx. 10 m)
The specifications for the 9750-11 and 9750-12 models differ from the standard specifications in regards to temperature characteristics.

❖ See 7.2 "Measurement Specifications" (page 146).



9631-01,-05 TEMPERATURE SENSOR

Used for temperature measurement.

9631-01: Lead length Approx. 1 m

9631-05: Lead length Approx. 5 cm



9459 BATTERY PACK

(Rechargeable nickel-hydrogen battery)

The 9753 AC ADAPTER is required for charging.

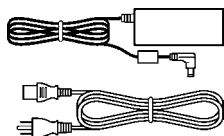

9753 AC ADAPTER

Input: 100 to 240 VAC

Output: 12 V DC, 3.33 A

Safety Information

This instrument is designed to conform to IEC 61010 Safety Standards, and has been thoroughly tested for safety prior to shipment. However, using the instrument in a way not described in this manual may negate the provided safety features.

Before using the instrument, be certain to carefully read the following safety notes:







Mishandling during use could result in injury or death, as well as damage to the instrument. Be certain that you understand the instructions and precautions in the manual before use.





- **Protective gear**
This instrument measures live lines. To prevent electric shock, use appropriate protective insulation and adhere to applicable laws and regulations.
- **With regard to the electricity supply, there are risks of electric shock, heat generation, fire, and arc flash due to short circuits. Individuals using an electrical measuring instrument for the first time should be supervised by a technician who has experience in electrical measurement.**

Symbols on the instrument

	Indicates cautions and hazards. When the symbol is printed on the instrument, refer to a corresponding topic in the Instruction Manual.
	Indicates that dangerous voltage may be present at this terminal.
	Indicates a double-insulated device.
	Indicates DC (Direct Current).
	Indicates AC (Alternating Current).

Symbols for standards

	Indicates that the product conforms to regulations set out by the EC Directive.
	Indicates the Waste Electrical and Electronic Equipment Directive (WEEE Directive) in EU member states.

Measurement categories

To ensure safe operation of measuring instruments, IEC 61010 establishes safety standards for various electrical environments, categorized as CAT II to CAT IV, and called measurement categories.

⚠ DANGER



- Using a measuring instrument in an environment designated with a higher-numbered category than that for which the instrument is rated could result in a severe accident, and must be carefully avoided.
- Never use a measuring instrument that lacks category labeling in a CAT II to CAT IV measurement environment. Doing so could result in a serious accident.

CAT II	Primary electrical circuits in equipment connected to an AC electrical outlet by a power cord (portable tools, household appliances, etc.) CAT II covers directly measuring electrical outlet receptacles.
CAT III	Primary electrical circuits of heavy equipment (fixed installations) connected directly to the distribution panel, and feeders from the distribution panel to outlets.
CAT IV	The circuit from the service drop to the service entrance, and to the power meter and primary overcurrent protection device (distribution panel).

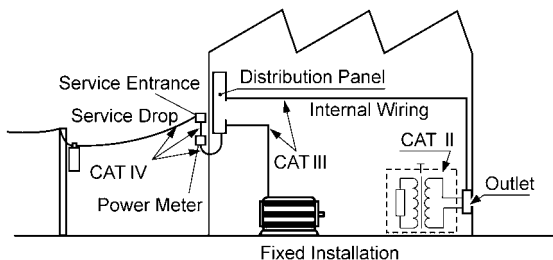

Operating Precautions

Follow these precautions to ensure safe operation and to obtain the full benefits of the various functions.

Preliminary Checks

Before using the instrument, verify that it operates normally to ensure that no damage occurred during storage or shipping. If you find any damage, contact your authorized Hioki distributor or reseller.

WARNING

If the test lead or the instrument is damaged, there is a risk of electric shock. Perform the following inspection before using the instrument:

- Before using the instrument check that the coating of the test leads are neither ripped nor torn and that no metal parts are exposed. Using the instrument under such conditions could result in electric shock. Replace the test leads with those specified by our company.
- Verify that the instrument operates normally to ensure that no damage occurred during storage or shipping. If you find any damage, contact your authorized Hioki distributor or reseller.
- To prevent an electric shock, confirm that the white or red portion (insulation layer) inside the cable is not exposed. If a color inside the cable is exposed, do not use the cable.

Precautions during shipment

During shipment of the instrument, handle it carefully so that it is not damaged due to a vibration or shock.

Placement

Operating temperature and humidity range: P.141
Temperature and humidity range for guaranteed accuracy:
P.148 to P.150

WARNING

Installing the instrument in inappropriate locations may cause a malfunction of instrument or may give rise to an accident. Avoid the following locations:

- Exposed to direct sunlight or high temperature
- Exposed to corrosive or combustible gases
- Exposed to a strong electromagnetic field or electrostatic charge
- Near induction heating systems (such as high-frequency induction heating systems and IH cooking equipment)
- Susceptible to vibration
- Exposed to water, oil, chemicals, or solvents
- Exposed to high humidity or condensation
- Exposed to high quantities of dust particles

⚠ DANGER**Observe the following to avoid electric shock and short circuits.**

- Before connecting or disconnecting the test leads to/from the instrument, be sure to disconnect the test leads from the object under test and turn off power.
- Do not perform measurement with the battery cover removed.
- Do not use the shutter if it is broken.
- To avoid electric shock, do not remove the instrument's case. The internal components of the instrument carry high voltages and may become very hot during operation.
- Do not use the instrument in environments containing ignitable gases, explosive powders, etc. (Risk of explosion)
- Do not place the instrument on an unstable table or an inclined place. Dropping or knocking down the instrument can cause injury or damage to the instrument.
- Do not use the instrument with circuits that exceed its ratings or specifications. Doing so may damage the instrument or cause it to become hot, resulting in bodily injury/electric shock.

**⚠ WARNING**

- Before using the instrument, inform those around you of your intention to do so.
- To prevent instrument damage or electric shock, use only the screw for securing the battery cover in place that are originally installed. If you have lost a screw or find that a screw is damaged, please contact your Hioki distributor for a replacement.

 CAUTION

- This instrument is designed for use indoors. It can be operated at temperatures between -10 to 50°C (14 to 122°F) without degrading safety.
- To avoid damage to the instrument, protect it from physical shock when transporting and handling. Be especially careful to avoid physical shock from dropping.
- If the protective functions of the instrument are damaged, either remove it from service or mark it clearly so that others do not use it inadvertently.
- Touching any of the high-voltage points inside the instrument is very dangerous. Customers are not allowed to modify, disassemble, or repair the instrument. Doing so may cause fire, electric shock, or injury.
- Place the cover on the instrument when not in use.
- To avoid damage to the instrument, do not connect an external device to the USB terminal or the temperature sensor terminal.
- The cable is hardened under the 0 degree or colder environment. Do not bend or pull it to avoid tearing its shield or cutting cable.
- This instrument is not drip-proof. Water droplets on the grip or connector may result in malfunctions.
- The protection rating for the enclosure of this device (based on EN60529) is *IP40.

This indicates the degree of protection provided by the enclosure of the device against use in hazardous locations, entry of solid foreign objects, and the ingress of water.

4: Protected against access to hazardous parts with wire measuring 1.0 mm in diameter. The equipment inside the enclosure is protected against entry by solid foreign objects larger than 1.0 mm in diameter.
0: The equipment inside the enclosure is not protected against the harmful effects of water.

NOTE

- After use, always turn off the power.

- **Standby State**

The use of "standby state" in this manual means that measurement is not being performed and that no parameters are set. This includes the state in which

HOLD is on.

- If the instrument is exposed to an abrupt large variation in temperature, condensation may occur, resulting in measurement errors.

Leave the instrument in a new environment for a while before starting measurement.

Measurement

DANGER

- It is recommend to make measurements on the secondary side of distribution panels. Measuring the primary side, where the current capacity is much larger, could cause damage to the instrument or panel in the event of a short-circuit.
- Do not short the two measurement lines with the metal portion of the tips of the test leads. Doing so may cause arcing or otherwise result in a serious accident.
- To avoid short circuit or electric shock, do not touch the metal parts of the connecting cable clips.

WARNING

- To prevent electric shock, when measuring the voltage of a power line use only the specified test lead.
- The optional test leads provided with this instrument conform to the safety standard EN61010. Use a test lead in accordance with its defined measurement category and rated voltage.

CAUTION

To avoid damage to the instrument, do not apply voltage or current to temperature probe.

Electrical Units

1 T Ω (Tera ohm)	=1000 G Ω	=10 ¹² Ω
1 G Ω (Giga ohm)	=1000 M Ω	=10 ⁹ Ω
1 M Ω (Mega ohm)	=1000 k Ω	=10 ⁶ Ω
1 mA (Milliampere)	=0.001 A	=10 ⁻³ A
1 μ A (Micro ampere)	=0.001 mA	=10 ⁻⁶ A
1 nA (Nano ampere)	=0.001 μ A	=10 ⁻⁹ A

CD precautions

- Exercise care to keep the recorded side of discs free of dirt and scratches. When writing text on a disc's label, use a pen or marker with a soft tip.
- Keep discs inside a protective case and do not expose to direct sunlight, high temperature, or high humidity.
- Hioki is not liable for any issues your computer system experiences in the course of using this disc.

Handling the Battery Pack

**WARNING**

Be sure to observe the following precautions. Incorrect handling may result in liquid leaks, heat generation, ignition, bursting and other hazards:

- The battery pack contains lye, which may cause blindness if it comes into contact with the eyes. Should battery liquid get into your eyes, avoid rubbing them. Flush them with water and seek immediate medical attention.
- When storing the instrument, make sure no objects that could short-circuit the connectors are placed near them.

⚠ CAUTION

Observe the following to avoid damage to the instrument:

- Use the battery pack in an ambient temperature range of 0 to 40°C and charge it in an ambient temperature range of 0 to 40°C.
- If the battery pack fails to finish charging within the stipulated time, disconnect the AC adapter to stop charging and contact your dealer or Hioki representative.
- Consult your dealer or nearest service station should liquid leaks, strange odor, heat, discoloration, deformation and other abnormal conditions occur during use, charging or storage. Should these conditions occur during use or charging, turn off and disconnect the instrument immediately.
- Do not expose the instrument to water and do not use it in excessively humid locations or locations exposed to rain.
- Do not expose the instrument to strong impacts and do not throw it around.

Heed the following instructions to avoid battery performance drop or leakage.

- Do not mix old and new batteries, or different types of batteries.
- Pay attention to the polarity markings "+-", so that you do not insert the batteries the wrong way around.
- Do not use batteries after their recommended expiry date.
- Do not leave a depleted batteries inside the instrument.
- Replace batteries only with the specified type.
- Remove the batteries or battery pack from the instrument if it is to be stored for a long time.

NOTE

- The battery pack is a consumable. If you are able to use the instrument for only a limited period of time despite the battery pack being properly charged, the battery pack's service life is at an end, and it should be replaced.
- When a battery pack that has not been used for a long time is used, charging may end before the battery pack is fully charged. In such a case, repeat charging and discharging a number of time before use. (A battery pack may also be in such a state immediately after purchase.)
- The life of the battery pack (when capacity is 60% or more of initial capacity) is approximately 500 charge-discharge cycles. (The life differs depending on the conditions of use.)
- To prevent battery pack deterioration when the battery will not be used for 1 month or longer, remove it and store it in a dry location with an ambient temperature range of between -20°C to 30°C. Be sure to discharge and charge it every two months. Long-term storage at low battery capacity will reduce performance.
- When a battery pack is used, the instrument turns off automatically when the capacity drops. Leaving the instrument in this state for a long time may lead to over discharge so be sure to turn off the power switch on the instrument.
- The charging efficiency of the battery pack deteriorates at high and low temperatures.

Overview

1

1.1 Product Overview

The IR3455 is an insulation resistance tester with a wide measurement range, for use in such environments involving low to high voltage.

The instrument has the functions and purposes given below.

Function	Purpose	Reference page
(Basic)		
Insulation resistance measurement	To test the insulation resistance of an electrical facility.	❖ 3.2 (P.62)
Voltage measurement	To measure the voltage of an external circuit, e.g., commercial power supply.	❖ 3.3 (P.79)
Temperature measurement	To measure a temperature	❖ 3.4 (P.82)
(Applied)		
Timer	To automatically end measurement after a predetermined time.	❖ 4.1 (P.85)
Display PI and DAR values	To check whether the insulation resistance increases with time after a voltage is applied. [When the PI (polarization index) value or the DAR (dielectric absorption ratio) value is close to 1, the instrument determines that the insulation of the object to be measured has deteriorated.]	❖ 4.2 (P.89)
Temperature compensation (TC)	To obtain the insulation resistance at various temperatures varied from the actual environmental temperature at which measurement is performed.	❖ 4.3 (P.93)

Function	Purpose	Reference page
Step voltage test	To determine whether the insulation resistance of an object changes according to test voltage applied.	❖ 4.4 (P.97)
Memory	To save the measurement data.	❖ 5 (P.105)
PC Communication	To create tables or graphs of the data saved in the memory for reports, etc.	❖ 6.4 (P.136)

1.2 Features

- ◆ **Wide test voltage range**

Generates a wide range of test voltages, from 250 V to 5 kV
The voltage may be chosen from the commonly used presets of 250 V, 500 V, 1 kV, 2.5 kV, and 5 kV; or set to a desired level by increments or decrements of 25 V or 100 V.

 - ❖ 3.2 "Measuring Insulation Resistance" (page 62)

- ◆ **Insulation diagnoses**

For automatic calculation and indication of PI (polarization index) and DAR (dielectric absorption ratio), step voltage testing, and temperature compensation.

 - ❖ 4 "Advanced Measurement" (page 85)

- ◆ **Large memory**

Stores up to 100 manual records and 10 logging records. The stored data may be displayed on the LCD or downloaded to a PC.

 - ❖ 5 "Recording Measurement Data (Memory Function)" (page 105)
 - 6.4 "Communicating with PC" (page 136)

- ◆ **Large, clear display**

The large display provides easy viewing. Measurements may also be displayed using a logarithmic bar graph, offering the feel of an analog meter.
The LCD is backlit, enabling measurement in poor lighting conditions.

◆ **PC software with report creation/printing feature**

The instrument has a USB interface. Data stored in the memory may be downloaded to PC using the data download software.

The same software also enables reports to be created and printed with ease.

❖ 6.4 "Communicating with PC" (page 136)

◆ **Compact hard case**

The case is durable—designed to withstand the toughest of working conditions, compact, and highly portable.

◆ **Dual battery power supply**

The instrument can be powered by either alkaline or rechargeable nickel-hydrogen batteries. (Selectable via switch)

❖ 2.1.1 "Installing or Replacing the Battery" (page 36)

2.1.2 "Installing the Battery Pack (Rechargeable nickel-hydrogen battery)" (page 39)

1.3 Measurement Overview

This instrument is designed for measurement of the following:

- Purpose : Inspection of high-voltage electrical facilities
Location : High-voltage receiving station or transforming station
Test object : Large motors, transformers, cables, etc.
- **Measures insulation resistance, voltage and temperature.**
 - **Stores measurement data in the internal memory.**
 - **Downloads data to a PC for table, graph, or report creation.**

Measurement condition

When measuring insulation resistance, ensure that power supply to the object under test is turned off.

You will need:

- IR3455 HIGH VOLTAGE INSULATION TESTER
- AA alkaline batteries (LR6), or 9459 BATTERY PACK
- 9750-01,-02,-03 TEST LEAD
- 9751-01,-02,-03 ALLIGATOR CLIP
- 9631-01,-05 TEMPERATURE SENSOR (for temperature measurement)

Flow of measurement

① Prepare for measurement

→2 "Measurement Preparations" (page 35)

Before starting measurement, check the following:

- The power supply method.
- The power ON/OFF method.
- That date and time are set.
- Connection of test leads, temperature sensor, and USB cable.

② Start measurement.



- ☐ Insulation Resistance Measurement
→3.2 "Measuring Insulation Resistance" (page 62)

1. Make sure that power supply to the object under test is turned off.



2. Press the  key to turn on  2.2 (page 50) the instrument.



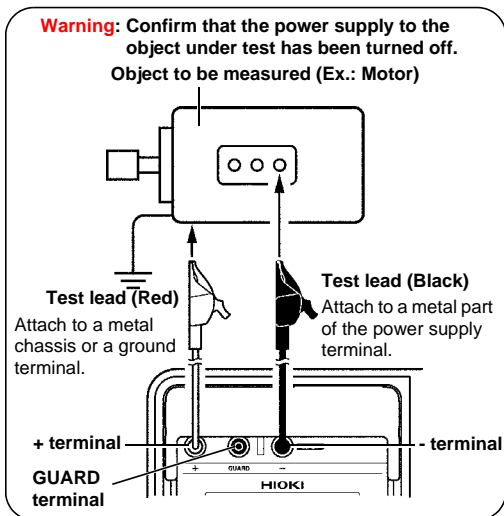

3. Connect the test leads into the "+" and "-" terminals of the instru-  2.4 (page 56) ment and to the object to be  3.2.1 (page 64) tested.



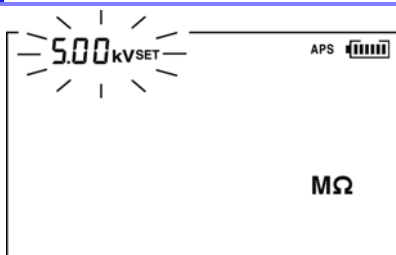

4. Press the  key and set the test voltage. [❖ 3.2.1 \(page 64\)](#)



5. Press the  key to generate a voltage and start measurement. [❖ 3.2.1 \(page 64\)](#)



6. Read the indication. [❖ 3.2.1 \(page 64\)](#)

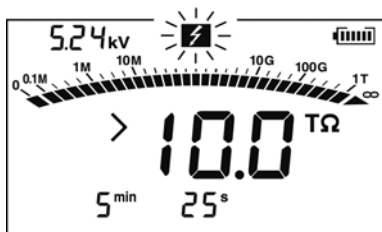

7.

Press the  key to stop voltage generation and measurement.

❖ 3.2.2 (page 70)



8.

The automatic discharge function is activated.

❖ 3.2.4 (page 73)



9.

Measurement is terminated when the voltage falls below 10 V.

- Voltage Measurement
→ 3.3 "Measuring Voltage" (page 79)

1. Connect the test leads into the "+" and "-" terminals of the instrument and to the object to be tested.

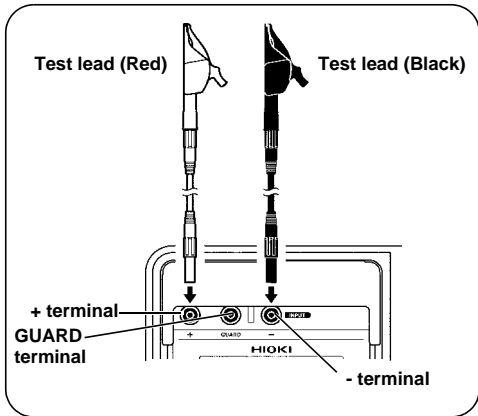

2. Read the indication.

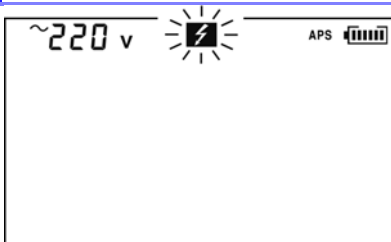

- ☐ Temperature Measurement
→ 3.4 "Measuring Temperature" (page 82)

1. Insert the temperature sensor into the temperature sensor terminal of the instrument.

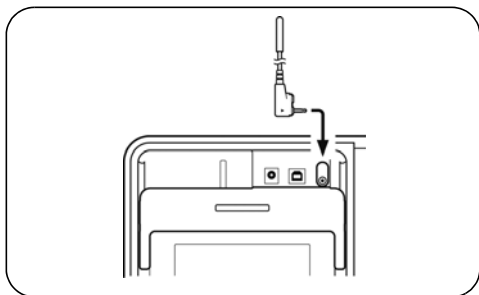

2. Read the indication.

25.0°C



3. Press the **ENTER** key to stop temperature measurement.

TEMP HOLD
25.0°C

③ Record measurement data

→5 "Recording Measurement Data (Memory Function)"

Insulation resistance and temperature measurement data are held after measurement is completed.

This data will be cleared if power is turned off. To store the data, use the memory function.

1.4 Names and Functions of Parts

Front

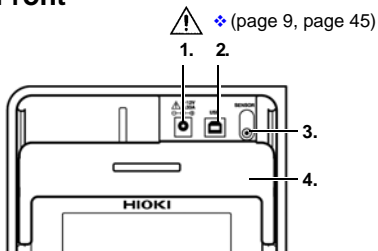

Slide the shutter.

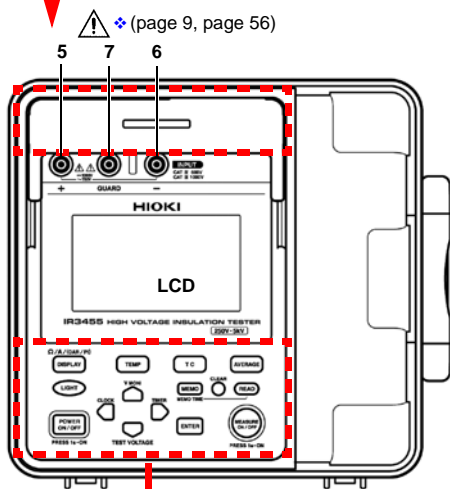

❖ (page 31)





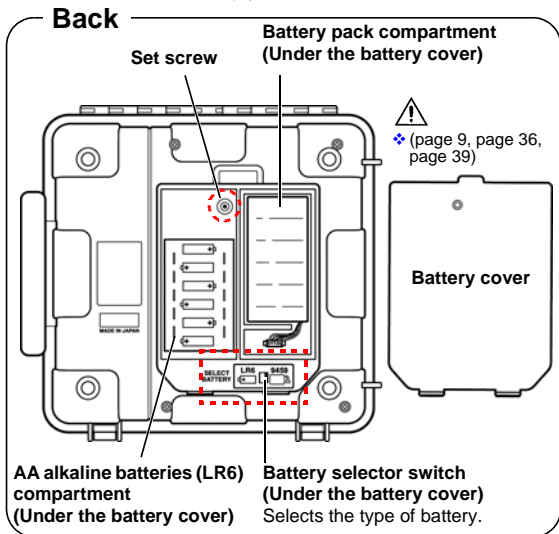

Name	Function
1 AC adapter terminal	Connect the AC adapter to this terminal. ❖ 2.1.3 "Connecting the AC Adapter" (page 45)
2 USB terminal	Connect the USB Cable to this terminal. ❖ 6.4.3 "Downloading Data to Save to PC/ Setting up Instrument on PC" (page 139)
3 Temperature sensor terminal	Connect the temperature sensor to this terminal. ❖ 2.5 "Connecting Temperature Sensor" (page 58)
4 Shutter	Prevents connection to other terminals when test leads are connected to the measurement terminals - a safety feature.
5 + measurement terminal*	Connect the red test lead to this terminal. ❖ 2.4 "Connecting Test Lead" (page 56)
6 - measurement terminal*	Connect the black test lead to this terminal. ❖ 2.4 "Connecting Test Lead" (page 56)
7 GUARD terminal	Connect the blue test lead to this terminal. ❖ 3.2.7 "Use of GUARD Terminal" (page 77)

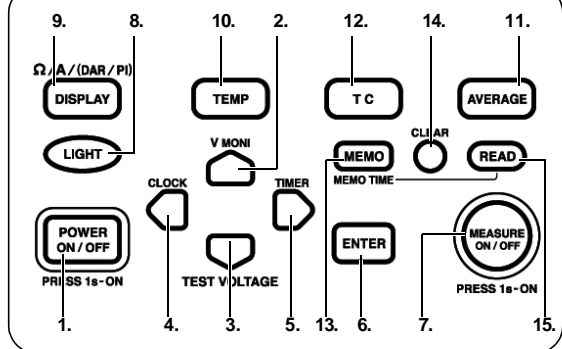







*These are referred to simply as + and - terminals.



Operating panel



Key	Function
1 	Used to turn power on/off.
2  V MONI	Used to toggle between set voltage and monitor voltage after resistance measurement.
3  TEST VOLTAGE	Used to set test voltage.
4  CLOCK	<ul style="list-style-type: none"> Used to make fine adjustments to test voltage. Used to move the cursor to change units, values, etc.
5  TIMER	<ul style="list-style-type: none"> Used to display the date and time. Used to set the date and time.
6 	<ul style="list-style-type: none"> Used to make fine adjustments to test voltage. Used to move the cursor to change units, values, etc.
6 	<ul style="list-style-type: none"> Used to confirm entries. Used to stop temperature measurement.

Key	Function
7  (Warning lamp)	<ul style="list-style-type: none"> Used to start and stop of resistance measurement. Blinks when a voltage is generated. Blinks when a voltage of 50 V or more is input or when discharging is performed.
8 	<ul style="list-style-type: none"> Turns the LCD backlight on/off. LCD backlight automatically extinguishes after 30 seconds.
9 	<ul style="list-style-type: none"> Changes measurement units on the LCD. When measuring resistance: This key toggles between display of current and resistance on the LCD When the resistance value is held: This key changes LCD display in the following sequence: resistance → current → DAR 1 min/15s → DAR 1 min/30s → PI → resistance → current → ...
10 	<ul style="list-style-type: none"> Used to view held temperature data. Used to enter the temperature of an external thermometer.
11 	Used to reduce drift of resistance or current reading.
12 	Used to enter the temperature compensation mode.
13 	<ul style="list-style-type: none"> Used to store data in the memory. Used to display the date and time data was stored in the memory.
14 	Used to delete data in the memory.
15 	Used to display data in the memory.

Test lead and alligator clip

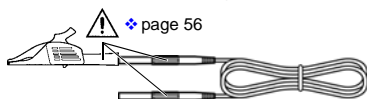

1.5 Screen Setup

All On

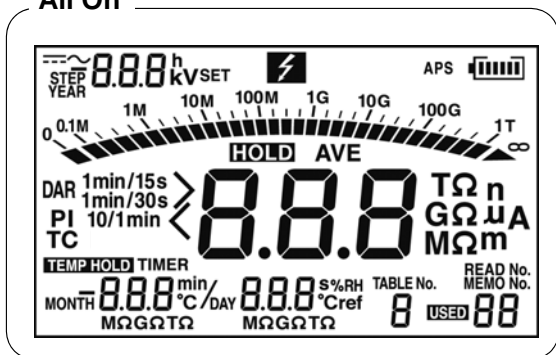

Measuring Voltage

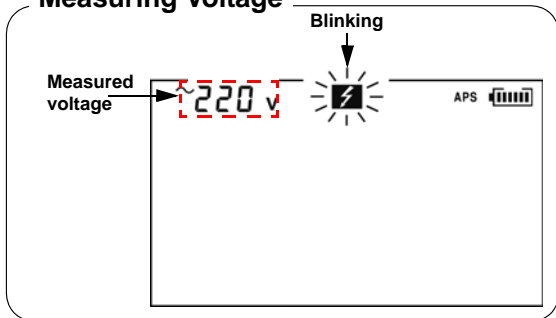

❖ 3.3 "Measuring Voltage" (page 79)

Measuring Temperature

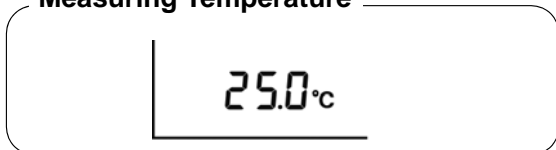

❖ 3.4 "Measuring Temperature" (page 82)

Measuring Insulation Resistance

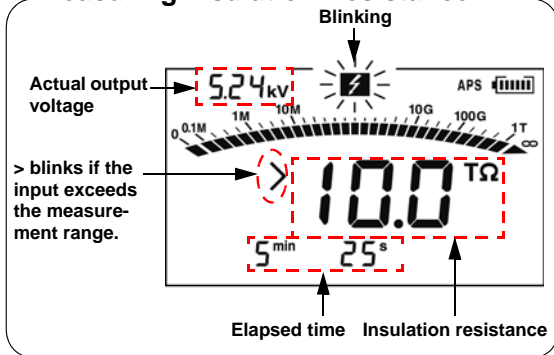

❖ 3.2 "Measuring Insulation Resistance" (page 62)



The screen is switched over with the

DISPLAY key.

Leakage Current Display

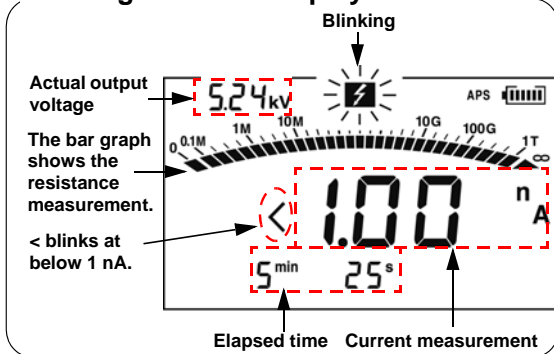

❖ 3.2.5 "Switching to Leakage Current Indication" (page 74)

Measurement Preparations

2

2.1 Supplying Power

This instrument can be powered by the following:



- AA alkaline batteries (LR6)
 - ❖ See 2.1.1 "Installing or Replacing the Battery" (page 36).
- 9459 BATTERY PACK (Option)
 - ❖ See 2.1.2 "Installing the Battery Pack (Rechargeable nickel-hydrogen battery)" (page 39), and 2.1.4 "Charging the Battery Pack" (page 47)
- 9753 AC ADAPTER (Option)
 - ❖ See 2.1.3 "Connecting the AC Adapter" (page 45).

2.1.1 Installing or Replacing the Battery

WARNING

- To avoid electric shock, turn off the power switch and disconnect the test leads before replacing the batteries.
- Do not mix old and new batteries, or different types of batteries. Also, be careful to observe battery polarity during installation. Otherwise, poor performance or damage from battery leakage could result.
- After replacing the batteries, reattach the battery cover and secure the screw before using the instrument.
- Battery may explode if mistreated. Do not short-circuit, recharge, disassemble or dispose of in fire.
- Handle and dispose of batteries in accordance with local regulations.

NOTE

- When the battery status indicator  is low, replace the batteries.
- The  indicator lights up when the remaining battery capacity is low. In this case, measurement is not possible. Replace the batteries.
- Use the specified batteries only. Do not use manganese batteries, for example, since operating time will be greatly reduced.
- To avoid corrosion and damage to this instrument from battery leakage, remove the batteries from the instrument if it is to be stored for a long time.

Procedure

1. Turn off power and disconnect all the test leads from the instrument.
❖ See 2.2 "Turning Power On and Off" (page 50).
2. Loosen the set screw on the rear of the instrument and remove the battery cover.

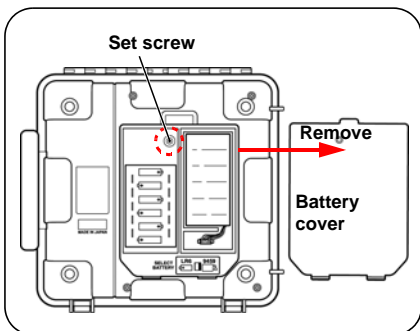

3. Place six LR6 alkaline batteries into the battery compartment. (Replace all six at the same time)

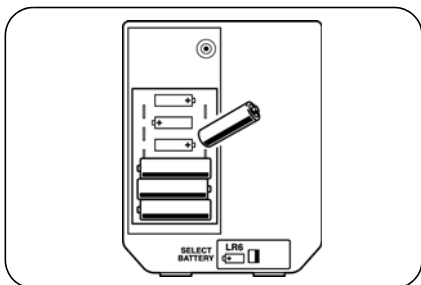

4. Turn the battery selector switch to LR6.
When the power is turned on, "LR6" appears on the top left of the screen.
❖ See 2.2 "Turning Power On and Off" (page 50).

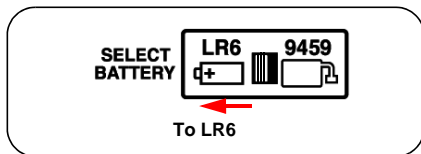

5. Replace the battery cover and tighten the set screw.

2.1.2 Installing the Battery Pack (Rechargeable nickel-hydrogen battery)

- Use the optional 9459 BATTERY PACK. The operating time is longer than that with alkaline batteries, and the pack is rechargeable.
- Battery pack is dispatched in an uncharged state. Charge before use.
- ❖ Procedure→See 2.1.4 "Charging the Battery Pack" (page 47).

WARNING

- For battery operation, use only the Hioki Model 9459 BATTERY PACK. We do not take any responsibility for accidents or damage related to the use of any other batteries.
- To avoid heat buildup, rupture, or leakage of the battery, do not use if damaged, wires are exposed, or the battery/instrument connector is damaged.
- To avoid electric shock, be sure to disconnect the test leads from the instrument, turn off power, and disconnect the AC adapter from the instrument, before installing or removing the battery pack.
- Battery may explode if mistreated. Do not short-circuit, disassemble or dispose of in fire. Do not recharge alkaline batteries. Handle and dispose of batteries in accordance with local regulations.

CAUTION

Take care not to step on the battery pack power cable, as this may damage it.

NOTE

- If the battery pack is not used for an extended period of time, remove it from the instrument and store at a temperature between -20 to 30°C, to prevent deterioration.

Charge the battery at least every 2 months. If the battery pack is left for a long period of time in a low state of charge, its performance will be degraded.

- When the battery status indicator is low, charge the battery pack.
- The battery pack is subject to self-discharge. Be sure to charge the battery pack before initial use. If the battery capacity remains very low after correct recharging, the useful battery life is at an end.
- The life of the battery pack is 500 charging cycles, i.e., about one year.

**Installation
Procedure**

Tools: Phillips screwdriver

-
1. Turn off power and disconnect the test leads, AC adapter and USB cable from the instrument.
 - ❖ See 2.2 "Turning Power On and Off" (page 50).

2. Loosen the set screw on the rear of the instrument and remove the battery cover.

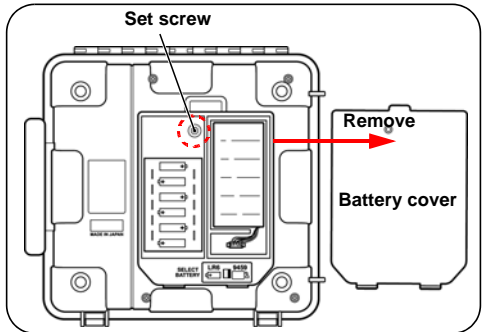

3. Connect the battery pack to the instrument. (Align the protrusions.)

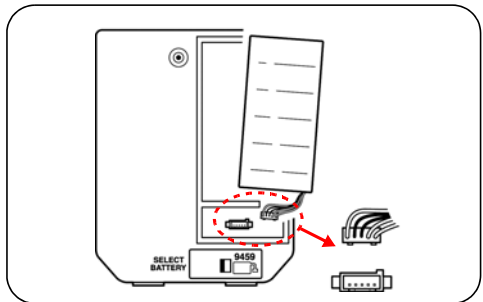

- Place the battery pack in the battery pack compartment.
- Turn the battery selector switch to 9459. When the power is turned on, "bP" appears on the top left of the screen.
[See 2.2 "Turning Power On and Off" \(page 50\).](#)

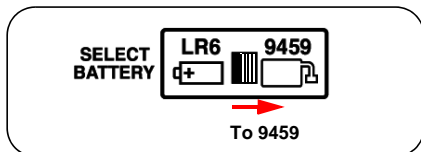

- Replace the battery cover and tighten the set screw.
(Be careful not to catch the battery pack cable in the battery cover, to prevent damaged wiring.)

Replacement Procedure Tools: Phillips screwdriver

1. Turn off power and disconnect the test leads, AC adapter, and USB cable from the instrument.
❖ See 2.2 "Turning Power On and Off" (page 50).
2. Loosen the set screw on the rear of the instrument and remove the battery cover.

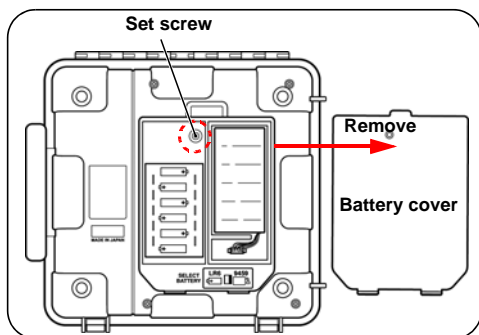

3. Disconnect the plug of the battery pack from the connector of the instrument.

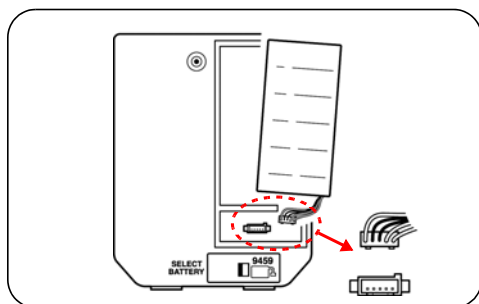

4. Connect the new battery pack to the instrument. (Align the protrusions.)
5. Place the battery pack in the battery pack compartment.
6. Turn the battery selector switch to 9459. When the power is turned on, "bP" appears on the top left of the screen.
[See 2.2 "Turning Power On and Off" \(page 50\).](#)

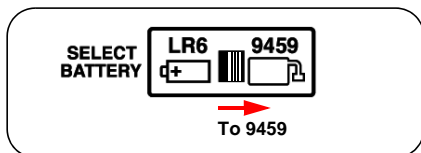

7. Place the battery cover and tighten the screw.

2.1.3 Connecting the AC Adapter

- Optional 9753 AC ADAPTER can be used.
- When the AC adapter is connected to the instrument, you can charge the battery pack, communicate with a PC, perform temperature measurement, and edit the settings. However, you cannot measure insulation resistance, leakage current or voltage.

WARNING

- Turn the instrument off before connecting the AC adapter to the instrument and to AC power.
- Use only the specified Model 9753 AC ADAPTER. AC adapter input voltage range is 100 V to 240 V AC at 50 Hz/60 Hz. To avoid electrical hazards and damage to the instrument, do not apply voltage outside of this range.
- To avoid electrical accidents and to maintain the safety specifications of this instrument, connect the power cord provided only to an outlet.

NOTE

The AC adapter cannot be used when performing measurement using instrument leads.

Procedure

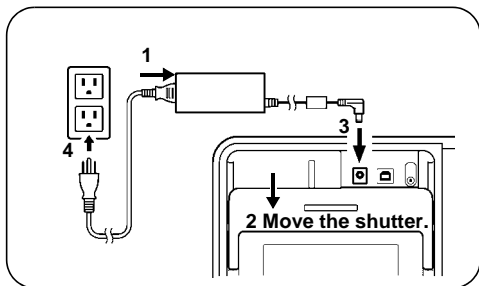

1. Insert the power cord into the AC adapter.
2. Move the shutter of the instrument to reveal the AC adapter terminal.
3. Insert the output cable of the AC adapter into the AC adapter terminal.
4. Make sure that the commercial power source voltage matches the rated supply voltage of the AC adapter. Insert the plug into the AC outlet.

When the AC adapter is connected to the instrument, power is supplied from the AC adapter. When both the battery and the AC adapter are connected to the instrument, the battery is not used. If the battery pack is installed, when the AC adapter is connected to the instrument, power of the instrument is automatically turned on and charging of the battery pack begins.

2.1.4 Charging the Battery Pack

The 9459 BATTERY PACK can be charged while installed in the instrument, using the optional 9753 AC ADAPTER. Short charge time: Approx. 3 hours (at 23°C room temperature)

NOTE

- Carry out battery charging at an ambient temperature between 10°C and 40°C. However, the ambient temperature may influence the charging efficiency. Outside this range, not only is the charging capacity reduced, but also there is a possibility of reduced performance or electrolyte leakage.
- The battery pack cannot be charged when test leads are connected to the instrument.
- The battery pack will be charged regardless of the battery selector switch position.
- Communication with a PC and temperature measurement are available during charging. But, insulation resistance measurement and voltage measurement are not available.
- Only use the specified battery charger.
- Do not recharge a fully-charged battery pack. If the battery pack is over-charged, a deterioration in performance or battery fluid leakage may result.
- During rapid charging, if the power supply is suspended approximately for more than 100 msec, the battery status indicator may show full charge even though it is not. In that case, disconnect and then connect AC adapter before starting to charge again.

Procedure

1. Install the battery pack.
❖ See 2.1.2 "Installing the Battery Pack (Rechargeable nickel-hydrogen battery)" (page 39).
2. Move the shutter to reveal the AC adapter terminal.

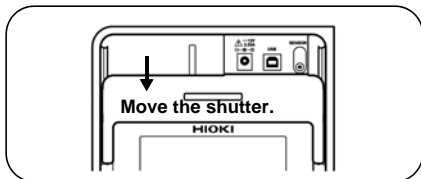

3. Connect the AC adapter to the AC adapter terminal.

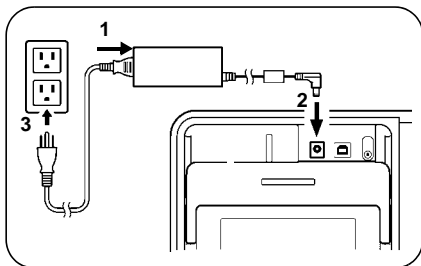

Rapid charging begins. During rapid charging, the battery status indicator blinks.

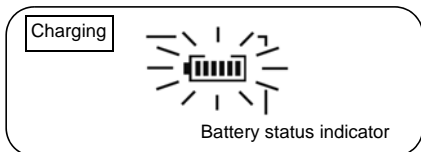

❖ See 2.1.3 "Connecting the AC Adapter" (page 45).

If the AC adapter is connected to the instrument when the instrument is off, the instrument is automatically turned on and rapid charging begins.

-
4. When rapid charging is completed, the battery status indicator changes from blinking to continuously lit. After rapid charging finishes, the battery is trickle-charged (maintained in a fully-charged state).

2.2 Turning Power On and Off

◆ Turning power On

Press and hold the  key for around one second.

After all the screen indications light, the version and the position of the battery selector switch appear and then the instrument enters the standby state.

Indicates the position of the battery selector switch.

bP: Using the Model 9459 BATTERY PACK

Lr6: Using the LR6 alkaline batteries

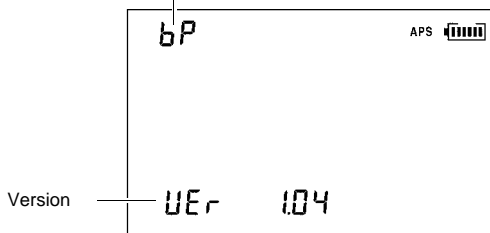

The instrument recalls the settings that were present before power was last turned off.

NOTE

When the battery status indicator  is low, replace the battery.

❖ See 2.1.1 "Installing or Replacing the Battery" (page 36).

If the batteries or the battery pack is running low, [**LObAt**] is indicated. The instrument turns off if use is continued.

◆ Turing power off

Press the  key.

The screen is switched off and power is turned off.

2.2.1 Auto Power Off

- Power is automatically turned off around 10 minutes after the last operation. This function, however, is not available during insulation resistance measurement.
- [APS] will start blinking around 30 seconds before power is turned off.
- Auto power off is re-enabled upon turning power on again. ([APS] lights up.)
- When the AC adapter is connected to the instrument, auto power off is disabled.
- When the timer is set or when the instrument is in the step voltage test mode, auto power off is disabled.



Canceling Auto Power Off

Turn on power while holding down the



key.

2.3 Setting and Checking Date and Time

Set the time and date before use of the instrument. Use the Gregorian calendar.

2.3.1 Setting Date and Time

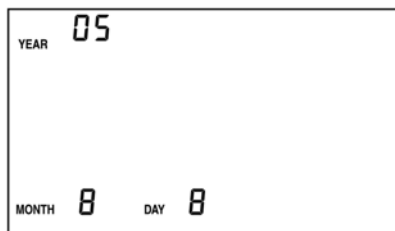

Procedure

1. When the instrument is in a standby state, press the  key. Year, month, and day appear.



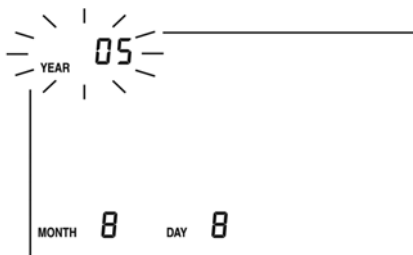





2. Hold down  key for more than one second. The Year starts blinking.





3. Pressing   moves the blinking cursor. Place the cursor at the digit, value, etc., you wish to change. Year, month, day, hour, and minutes can be changed.

The year-month-day screen and the hour-minute-second screen are switched to and from each other in the procedure below.

Year-month-day ↓ Hour-minute-second	<ul style="list-style-type: none"> • When year [YEAR] is blinking, press the  key. • When day [DAY] is blinking, press the  key.
Hour-minute-second ↓ Year-month-day	<ul style="list-style-type: none"> • When hour [h] is blinking, press the  key. • When minute [min] is blinking, press the  key.

4. Press   to change the number. Hold down for fast increase/decrease.

5. The entry is confirmed by pressing the  key, after which the display returns to the standby screen.

The clock starts to run from zero seconds as soon as  key is pressed.

**Date and time can be set on a PC.**

- The date and time can be set on a PC using the data analysis software for model 3455.
- The data analysis software for model 3455 must be installed on the PC.
- ❖ Details → See 6.4 "Communicating with PC" (page 136).

2.3.2 Checking Date and Time

Procedure

1. When the instrument is in the standby state, press the  key. Year, month, and day appear.

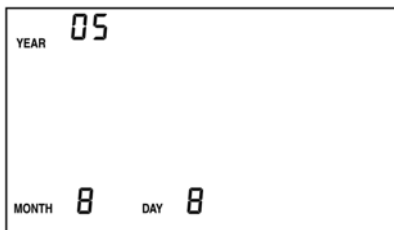

2. Press the  key. Hours, minutes, and seconds appear.

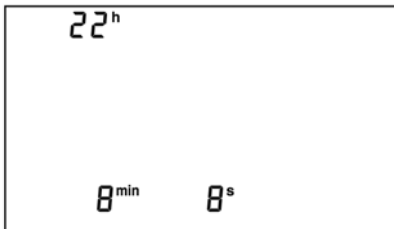

3. Pressing  key returns to the standby screen.

2.4 Connecting Test Lead

DANGER

- To avoid electrical accidents, remove power from the circuit before connecting the test leads.
- To avoid electric shock, never use the instrument if the shutter is broken.

WARNING

Only use Hioki-specified test leads with the instrument. Safe measurement is not possible with other cords.

NOTE

Test leads cannot be connected to the instrument if the AC adapter, a temperature sensor, or USB cable is connected.

Procedure

1. Connect the alligator clip to the end of each test lead. Insert it fully.

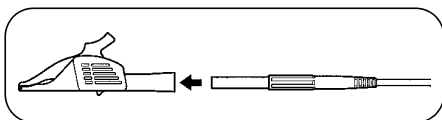

2. Move the shutter to reveal the + and - terminals.

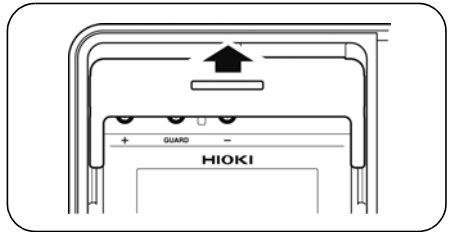

3. Connect the red test lead to the + terminal and the black test lead to the - terminal. For insulation resistance measurement, connect the blue test lead to the GUARD terminal if necessary. Check that the test leads are fully inserted.

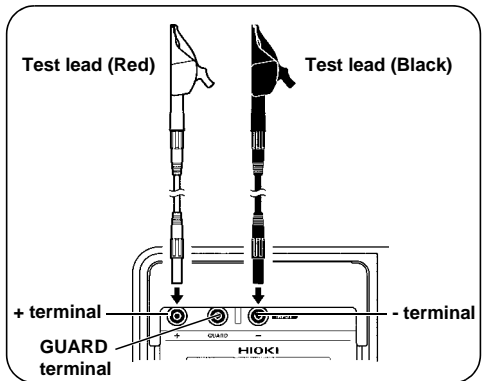

❖ GUARD terminal → See 3.2.7 "Use of GUARD Terminal" (page 77).

2.5 Connecting Temperature Sensor

⚠ CAUTION

Temperature sensors may be damaged by high voltage or static electricity. Do not expose the temperature sensor to excessive impact, or allow the cable to be bent, since malfunction or faulty connection may result.

NOTE

Temperature sensors cannot be used simultaneously with test leads.

Procedure

1. Move the shutter to reveal the temperature sensor terminal.

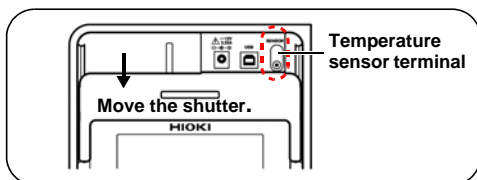

2. Connect the temperature sensor to the temperature sensor terminal.
Temperature measurement begins automatically.

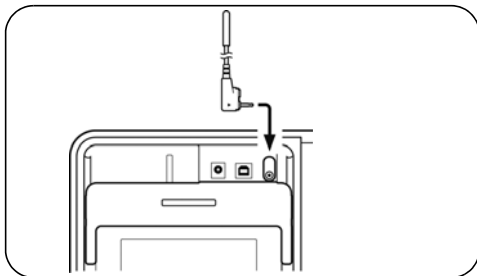

Measurement

3

3.1 Pre-Operation Inspection

Before using the instrument, verify that it operates normally to ensure that no damage occurred during storage or shipping. If you find any damage, contact your authorized Hioki distributor or reseller.

WARNING

Before using the instrument, make sure that the insulation on the test leads and cables is undamaged and that no bare conductors are improperly exposed. Using the product in such conditions could cause an electric shock, so contact your authorized Hioki distributor or reseller for replacements.

NOTE

Make sure the terminals are clean and dry. Wipe with a dry cloth to remove any moisture, since measurement errors may result if moisture is present.

❖ See 8.2 "Cleaning" (page 156).



Checking for damage

Confirm that the instrument chassis, shutter, test leads, and clips are not damaged.

Do not used if damaged.



Checking test voltage and resistance reading

Equipment



- 20 M Ω resistor that provides a voltage of 5 kV
- High-voltage meter with an input resistance of 1,000 M Ω or more, and capable of measuring up to 5.5 kV DC

**Inspection
Procedure**

1. Clip the resistor with the red and black test leads connected to the instrument.
2. Also, clip the resistor with the test lead of the high-voltage meter.
3. Set the test voltage of the instrument to [5.00 kV].
❖ See 3.2 Measuring Insulation Resistance, Procedure 5. (page 66) to (page 66).
4. Hold down  key for more than one second to start insulation resistance measurement.
5. Check to see if the reading of the high-voltage meter is somewhere between 5 kV and 5.5 kV.
6. Check to see if the voltage reading of the instrument is somewhere between 5 kV and 5.5 kV.

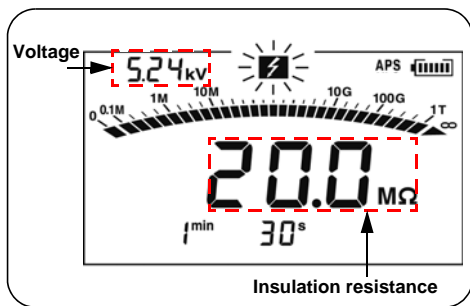
7. Check to see if the insulation resistance reading of the instrument is 20 M Ω .



8. Stop insulation resistance measurement.
 ❖ See 3.2.2 "Ending Measurement" (page 70).
9. Short-circuit the tips of the clips of the red and black test leads of the instrument.
10. Press the  key to see if the test voltage setting is [5.00 kV].
11. Hold down the  key for more than one second to start insulation resistance measurement.
12. Check to see if the insulation resistance reading of the instrument is 0.00 M Ω .
If a problem exists, discontinue use of the instrument.

3.2 Measuring Insulation Resistance



Observe the following to avoid electric shock and short circuits.

A. Do not use the instrument if the shutter is broken.



B. Check Table 1 before connecting test leads to the instrument.

C. Check to see if the object under test is not live or electrically charged using a high-voltage detector or other similar instrument, before connecting test leads to it.

Table 1





Check item	Result	Action
Are the  mark and  key lamp off?	Off	Connect test leads to the instrument and check C. above. If safe to proceed, connect the test leads to the object under test. → Go to Table 2.
	Blinking	Press the  key to stop voltage generation.

Table 2

Check item	Result	Action
Are the  mark and  key lamp blinking?	Not blinking	Measurement may be commenced
	Blinking	Immediately disconnect the test leads from the object under test and turn off power to the object or discharge the electric charge using a discharge rod.

⚠ WARNING

- When measuring insulation resistance, dangerous voltage is applied to the measurement terminals. To avoid electric shock, do not touch the terminals and test leads.
- Do not touch the object under test or disconnect the test leads after measurement has been completed until the automatic discharge function is completed. Electric shock may result due to high voltage and stored charge.

❖ See 3.2.4 "Automatic Discharge Function" (page 73).

- Power of the instrument may be turned off during measurement even if the  key is not pressed, for instance, due to battery consumption. In such case, the automatic discharge function may not operate. Discharge the object under test using a discharge rod for high voltage.

⚠ CAUTION

- To avoid damage to objects under test, be sure to check the test voltage before starting measurement.
- When repeating measurement, press the  key before next measurement to check the test voltage.
- To avoid damage to the instrument during discharge, do not measure the insulation resistance between the terminals of capacitors (with a capacitance of over 4 μF).
- To avoid damage to the instrument, do not short-circuit the tips of the clips of the red test lead (+ terminal) and the blue test lead (GUARD terminal).

3.2.1 Starting Measurement

Procedure

1. Connect the alligator clip to the end of each test lead. Insert it fully.

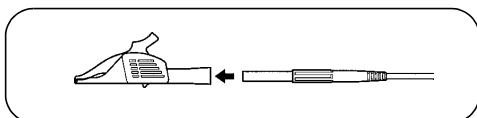

2. Move the shutter to reveal the + and - terminals.

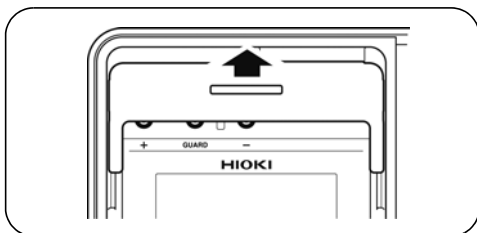

3. Connect the red test lead to the + terminal and the black test lead to the - terminal. Connect the blue test lead to the GUARD terminal if necessary. Fully insert the test leads.
❖ See 3.2.7 "Use of GUARD Terminal" (page 77).

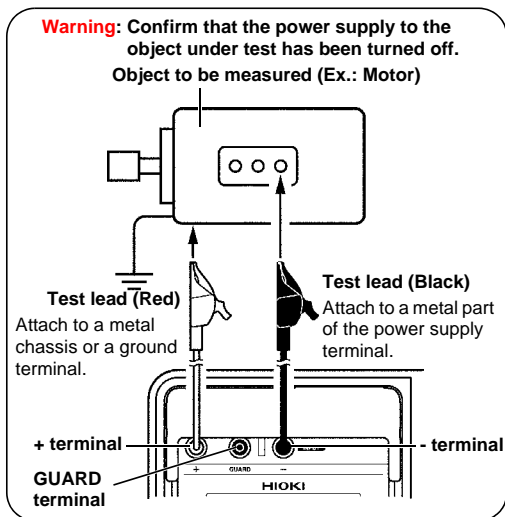





4. Clip the alligator clip at the end of each test lead to the object under test.

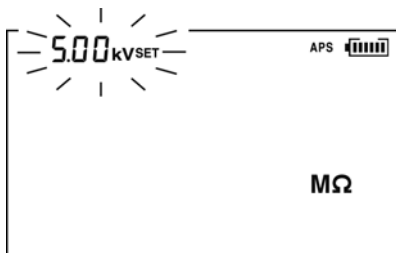

3.2 Measuring Insulation Resistance

5. Press the  key, after which the voltage display starts blinking.



6. The test voltage is chosen from 250 V, 500 V, 1.00 kV, 2.50 kV, and 5.00 kV using the   keys.

7. Pressing   keys, you can make fine adjustment of the test voltage setting.

For step voltage testing, hold down the  key, which will display [STEP]. For non-stepped insulation resistance measurement, press the  key and choose a voltage.



8. Press the  key to set the test voltage.

The voltage indication will change from blinking to continuous.
This test voltage is now set.

9. Hold down the  key for more than

one second.

A voltage is generated and measurement begins.

The  mark and  key lamp starts blinking.

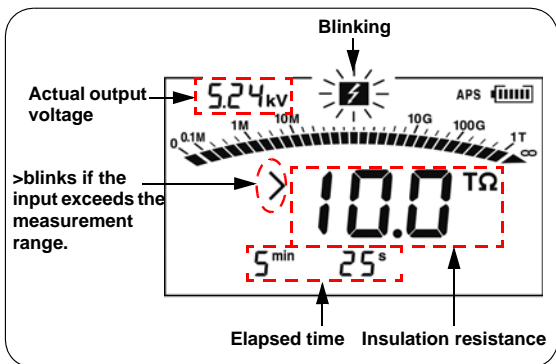

If **>** blinks, the input value is out of measurement range.

Example: **> 10.0 TΩ** means "larger than 10.0 TΩ."

- During measurement, [SET] is turned off in the voltage indication field and the indication changes from the set voltage to the actual output voltage. A voltage approximately 5% higher than the set level is output.
- To view the set voltage during measurement, press the  key. The set voltage is displayed for approximately 2 seconds.
- During measurement, if the output voltage is lower than the set level, the voltage indication blinks.
- Under the resistance indication appears time elapsed from the start of measurement.

10. Read the indication.

- If the indication is unstable, press the **AVERAGE** key. The average of the measurements is shown.
 - ❖ See "Average function" (page 69).
- Resistance indication is switched to leakage current indication by pressing the **DISPLAY** key.
 - ❖ See 3.2.5 "Switching to Leakage Current Indication" (page 74).
- When the timer has been set, remaining time is displayed.
 - ❖ See 4.1 "Using Timer" (page 85).

⚠ CAUTION

Do not allow test leads to contact each other or place objects on test leads, to avoid measurement errors and malfunctions.

NOTE

- Be sure to clean test leads after use. If test leads are soiled, they may deteriorate.
- Insulation resistance is unstable. The indication may not stabilize with some objects.
- Due to factors such as capacitance of objects under test, resistance values may start low, then rise gradually and settle out.
- During measurement, if the resistance of the object suddenly drops or if the test lead tips are short-circuited, the instrument stops voltage generation as a safety measure. (This applies to a test voltage of 1.1 kV or more.)

◆ **The state not to be started the measurement**

When the display reflects the following state, insulation resistance measurement cannot be started.

- The setting value is blinking to indicate that the instrument being set up
- The **HOLD** mark is blinking
- While **[TC]** is lit, the actual measurement temperature is shown as [- - -]
- An error message is displayed

◆ **Average function**

If the indication is unstable, the average of the measurement is shown.

Pressing the **AVERAGE** key toggles **[AVE]** on/off.

While **[AVE]** is on, display update interval is four seconds, normally.

But in the following case, the interval is one second even if **[AVE]** is on.

- During 15 seconds after the measurement started
- During 5 to 10 seconds after the measurement range changed

3.2.2 Ending Measurement



Procedure

1. Press the  key with the test leads connected to the object under test.



The last measurement is held.
(**HOLD** lights up.)

2. Immediately after measurement has been completed, the discharge circuit in the instrument automatically discharges the electric charge remaining in the object under test.

❖ See 3.2.4 "Automatic Discharge Function" (page 73).

3. During discharge, the  mark and  key lamp blinks.

The voltage indication shows the progress of discharge.

4. When the voltage falls to about 10 V, the instrument stops discharging and the  mark and  key lamp are turned off.

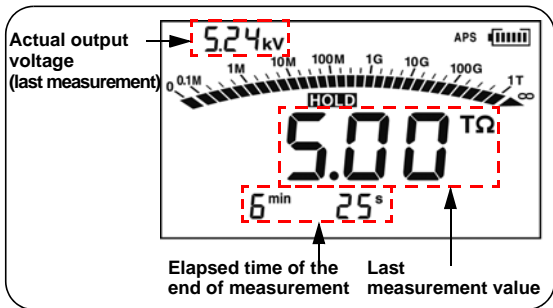

- If the  key is pressed during measurement, automatic discharge is performed before power is turned off.
- If the battery runs low during measurement, the instrument automatically stops measurement. Automatic discharge is performed and then [LObAt] appears on the screen.

5. To restart measurement, press the  key to check the set test voltage before resuming measurement.

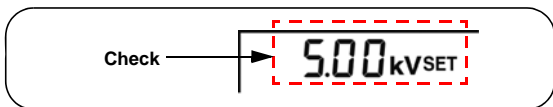

3.2.4 Automatic Discharge Function

- When insulation resistance with a capacitance component is measured, this component remains charged with a high-voltage equivalent to the test voltage, which is dangerous.
- This instrument automatically discharges remaining electric charge using the internal circuit after measurement.
- Make sure that the test leads are connected to the measured object when pressing the  key to stop measurement.
- Discharging stops when the residual voltage falls below 10 V. The discharge time varies depending on the capacitance.

WARNING

After the voltage has been decreased by the instrument's automatic discharge function, the voltage in the measurement area may rise again due to the remaining charge in the capacitor CA shown in the diagram in section 3.2.6. Take great care when touching the object under test.

3.2.5 Switching to Leakage Current Indication

Insulation resistance indication may be switched to leakage current indication.

During measurement

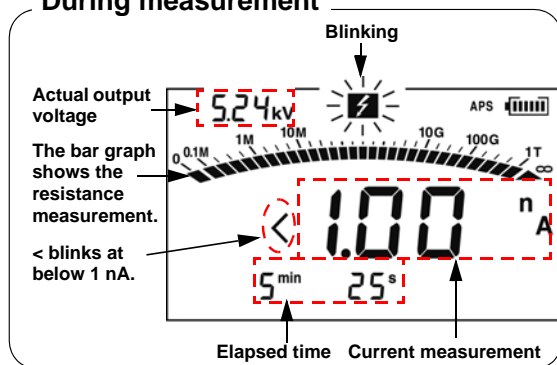

- ◆ **Before measuring insulation resistance and after setting test voltage (**HOLD** indicator is off.)**

Every time the **DISPLAY** key is pressed, the indication changes in the order: resistance → current → PI → resistance → etc.

- ◆ **Measuring insulation resistance**

Every time **DISPLAY** key is pressed, the indication changes in the order: resistance → current → resistance → current → etc.

◆ Holding data after measurement

Every time **DISPLAY** key is pressed, the indication changes in the order: resistance → current → DAR 1 min/15s → DAR 1 min/30s → PI → resistance → current → etc.

❖ PI/DAR → See 4.2 "Displaying PI and DAR" (page 89).

If the indication is unstable, press the **AVERAGE** key. The average of the measurements is shown.
 [< 1.00 nA] means "below 1.00 nA."

3.2.6 Insulation Resistance Measurement Basis

When a high DC voltage is applied to an object under test, a leakage current flows.

The insulation resistance instrument measures the applied voltage V and the combined leakage current I and then calculates the insulation resistance R .

Calculation formula $R = V/I$

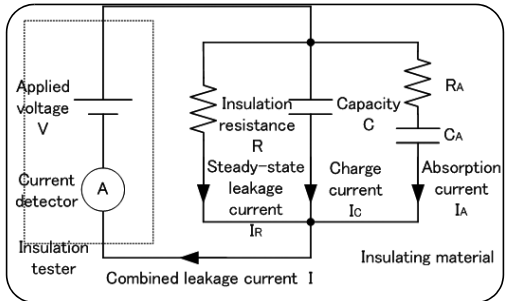

I_C and I_A gradually decrease after the voltage is applied.

 **Reproducibility of insulation resistance measurement**

When measuring the same object repeatedly, the insulation resistance or leakage current indications may differ. This is caused by polarization*, which occurs when a voltage is applied to an insulating material.

An insulating material is represented by an equivalent circuit as shown by the diagram on the previous page.

Absorption current due to relatively slow polarization is represented by I_A , as shown in the diagram above. It takes time for the polarization caused by the previous measurement disappear. Until it does, electric charge remains in CA as shown in the diagram. The electric charge level in CA differs at the start of previous measurement and at the start of next measurement and thus absorption current I_A differs, too. Further, the combined leakage current and insulation resistance vary from measurement to measurement. This will be become more apparent for higher insulation resistance values.

To ensure reproducibility of measurement, leave a sufficient time interval between measurement sessions. Further, the ambient temperature and humidity should not vary.

*Polarization: the phenomenon in which positive and negative charges on the atoms of a material move in opposite directions causing a shift of the center when an electric field is applied to the material.

3.2.7 Use of GUARD Terminal

◆ Measurement unaffected by surface electrical resistance

A GUARD terminal is used to prevent the surface electrical resistance of an insulating material affecting measurement, enabling correct measurement of the entire volume resistivity of the material.

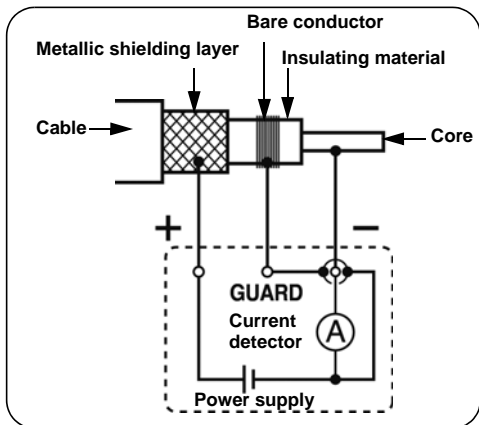

When testing the insulation of a cable, as shown in the diagram above, wind a bare conductor around the surface of the insulating material and connect the conductor to the GUARD terminal. This prevents the leakage current on the surface of the insulating material flowing into the current detector, which enables the actual resistance of the entire volume of the insulating material to be measured.

◆ Measurement using G (GUARD) terminal grounding

G terminal grounding is used for measuring the insulation resistance between the core and the metallic shielding layer of a high-voltage cable with the cable connected to other high-voltage equipment. The diagram below shows an example of measurement.

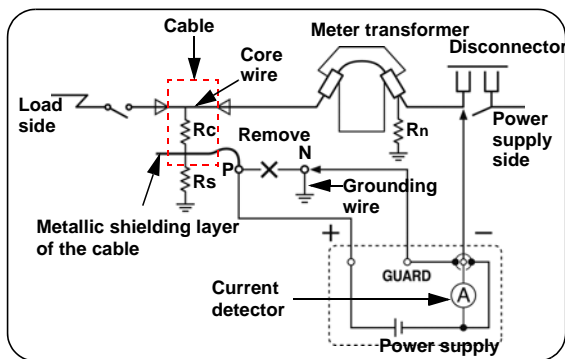

R_c : Insulation resistance of the insulating material of the high-voltage cable (Between core and metallic shielding layer)

R_s : Insulation resistance of the sheath of the high-voltage cable (Between metallic shielding layer and ground)

R_n : Insulation resistance between insulator or high-voltage equipment and ground

Influence of R_s and R_n is removed and solely R_c is measured.

Reference → High-voltage power receiving facility code 2002

3.3 Measuring Voltage

The instrument measures the voltage of an external circuit, e.g., commercial power supply. AC and DC are distinguished automatically.



To prevent damage to the instrument and personal injury, observe the precautions below.

- Maximum rated voltage to ground: 1,000 V AC (CAT III), 600 V AC (CAT IV)
- Do not conduct measurement exceeding these voltages to ground.
- Maximum input voltage: 750 V AC, 1,000 V DC
Do not conduct measurement exceeding this maximum input voltage.
- Maximum input frequency: 70 Hz
Do not conduct measurement exceeding this maximum input frequency.

- Do not short-circuit a line voltage applied with the tip of test lead.



Do not clamp two lines.

- Do not use the instrument if the shutter is broken.



Procedure

1. Connect alligator clips to the ends of test leads. Insert it fully.

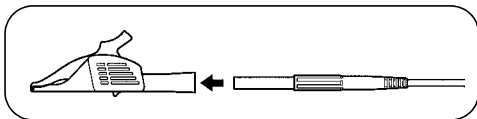

2. Move the shutter to reveal the + and - terminals.

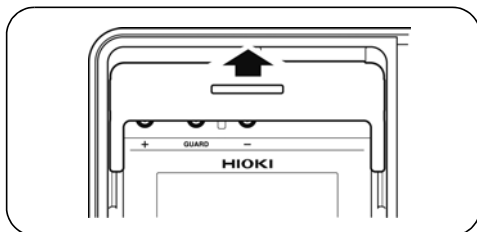

3. Connect the red test lead to the + terminal and the black test lead to the - terminal. Fully insert the test leads.

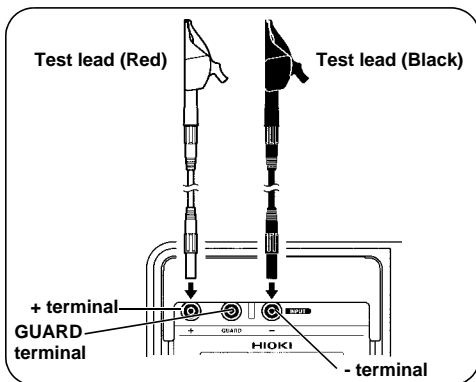

4. Clip the ends of the test leads to the circuit to be tested. When the voltage exceeds 50 V, the  mark and



key lamp blink.

5. Read the voltage indication.



The key is not used.

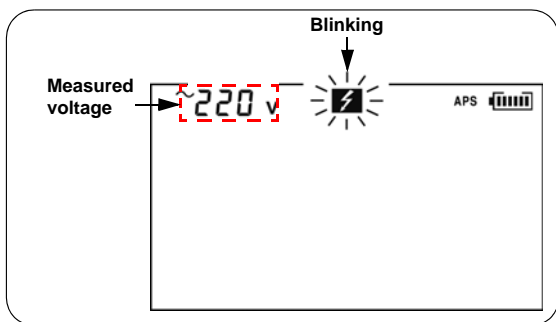

3.4 Measuring Temperature

3.4.1 Measurement Procedure

**WARNING**

Do not attempt to measure the temperature of objects carrying a voltage. Doing so will result in a short-circuit accident or an electrocution accident.

**CAUTION**

Temperature sensors may be damaged by high voltage or static electricity. Do not expose the temperature sensor to excessive impact, or allow the cable to be bent, since malfunction or faulty connection may result.

Procedure

1. Move the shutter to reveal the temperature sensor terminal.

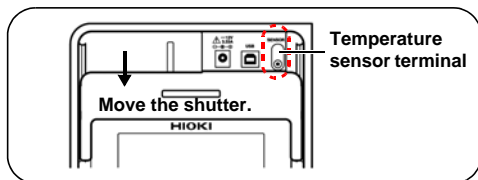

2. Connect the temperature sensor to the temperature sensor terminal.

3.4 Measuring Temperature

Temperature measurement begins automatically.

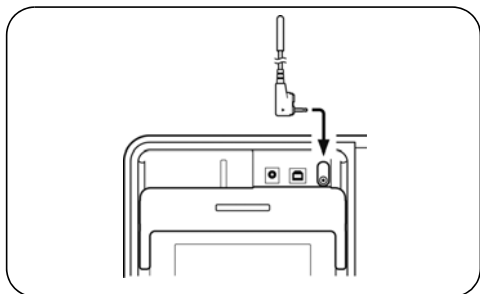

3. Read the temperature indication.

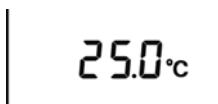

4. Press **ENTER** key or disconnect the temperature sensor to stop measurement.

TEMP HOLD lights up and the last measurement is held.



**After measuring temperature
(When the resistance is not measured.)**

- ❖ Detailing the above display → See 6.3.2 "Clearing Indications of Temperature and Humidity Stored Data" (page 135).

- If temperature measurement is stopped using the **ENTER** key, measurement may be resumed by pressing the **TEMP** key.
- When an insulation resistance measurement is held, if the temperature sensor is disconnected, the temperature indication switches to the elapsed time indication at the time of insulation resistance measurement. To display the held temperature instead of the elapsed time, press the **TEMP** key. (The temperature will blink.)



**After measuring temperature
(Disconnecting the temperature sensor,
resistance value is held)**

- Held measurement values are cleared when power is turned off. To save the data, use the memory function.
- ❖ See 5.1.1 "Manual Recording (Recording result of one measurement session)" (page 107).
- Settings cannot be edited during temperature measurement. To edit settings, stop temperature measurement.
- [OF] means exceeding 70.0°C.
[-OF] means below -10.0°C.

Advanced Measurement

4

4.1 Using Timer



What is it used for?

Used to set the instrument to automatically stop at a specified time.

If the timer is set during insulation resistance measurement, the measurement automatically ends at the set time. Selectable time: 30 sec. to 30 min. (When setting over 1 minute, time increments or decrements in minutes.)

4.1.1 Setting Timer/Conducting Insulation Resistance Measurement



Procedure

1. When the instrument is in a standby state, press the  key.

The time indication will blink.



2. Press the   key to set the time.

-
3. Press the  key to confirm the entry. If the  key is pressed without pressing the  key, the instrument returns to a standby state with the time unchanged.

When the timer is successfully set, the [TIMER] indicator lights.

-
4. Holding down the  key for longer than one second generates a test voltage, and measurement begins.

At the bottom of the screen, remaining time to completion of measurement is displayed.

-
5. After the set time has elapsed, the instrument automatically stops measurement.

If the  key is pressed, the instrument immediately stops measurement regardless of the remaining time.

Elapsed time at the completion of measurement is displayed at the bottom of the screen.

When the timer is set, auto power off is disabled.

◆ Timer not used



Procedure

1. When the instrument is in a standby state, press the  key.

The time indication will blink.



2. Press the  key to select - - min - - s.

- - min - - s is also selected by pressing the   key.

3. Press the  key to confirm the entry.

[TIMER] indicator is turned off.



◆ Checking set time

Procedure

1. When the instrument is in a standby state, press the  key.

The currently set time blinks. Check the time.



2. Press the  or  key to return to the previous screen.

4.2 Displaying PI and DAR



What is it used for?

Used to check whether insulation resistance increases with time after a voltage is applied.

(When the PI value or the DAR value is close to 1, the instrument determines that the insulation of the object under test is deteriorated.)

- The instrument automatically calculates and displays PI (polarization index) and DAR (dielectric absorption ratio), which are used as the criteria to determine the quality of insulation.

Both measurements show a degree of change in insulation resistance with time after a test voltage is applied.

- ❖ [Appendix 3 "Example of PI Criteria \(Polarization Index\)" \(page 164\)](#)
- PI and DAR are calculated using the formulae below from resistance values measured twice after a voltage is applied. For PI, the measurement interval may be user-set.
- ❖ [See 6.1 "Changing and Checking Interval Setting for PI Calculation" \(page 125\).](#)

$$\text{PI 10/1min} = \frac{\text{Resistance 10 min. after voltage application}}{\text{Resistance 1 min. after voltage application}}$$

$$\text{DAR 1min/15s} = \frac{\text{Resistance 1 min. after voltage application}}{\text{Resistance 15 sec. after voltage application}}$$

$$\text{DAR 1min/30s} = \frac{\text{Resistance 1 min. after voltage application}}{\text{Resistance 30 sec. after voltage application}}$$

NOTE To determine DAR, press the **AVERAGE** key to turn off **[AVE]** on the screen before starting measurement.

Procedure

-
1. Measure insulation resistance.

To determine PI, continue measurement for 10 minutes (for a default time setting).

To determine DAR, continue measurement for one minute.

-
2. Stop measurement.

-
3. Press the **DISPLAY** key several times to display PI, DAR 1 min/15 s, or DAR 1 min/30 s.

Every time the **DISPLAY** key is pressed the indication on the LCD changes in the order of resistance → current → DAR 1 min/15 s → DAR 1 min/30 s → PI → resistance → current →, etc.

Measurement Interval
Right: 1st
Left : 2nd

DAR 1min/15s

Resistance
Right: 1st measurement
Left : 2nd measurement

Measurement Interval
1st : 1 min.
2nd : 10 min.

PI 10/1min

Resistance
Right: 1st 30 GΩ
Left : 2nd 60 GΩ

Substitute into the formula; **PI 10/1min=Resistance 10 min. after voltage application divided by resistance 1 min. after voltage application.**
PI in the example above is: **2.00=60.0 GΩ / 30.0 GΩ**

NOTE

- If measurement ends before the set time elapses, [- - -] appears on the screen.
- When [TC] is on (temperature compensation mode), PI and DAR cannot be displayed.
- In the step voltage test mode, PI or DAR cannot be displayed.

 **Blinking resistance indication on PI or DAR display screen**

When the resistance indication blinks, the displayed reading may be incorrect. (Insulation resistance changed rapidly before end of set specified time, affecting measurement range so that the internal circuit failure to respond)

When the resistance reading blinks, regard the PI or DAR value as a reference. Perform measurement again.

The table below shows special indications for PI and DAR.

PI, DAR	Conditions
---	<ul style="list-style-type: none"> • One or more resistance values could not be acquired. ([- -] appears in the resistance field.) • One or more resistance values exceeded measurement range. ([OF] appears in the resistance field.) • The 1st measurement was 0.00 MΩ.
>999	PI or DAR is larger than 999.
<0.01	PI or DAR is smaller than 0.01.

4.3 Temperature Compensation (TC)



What is it used for?

Used to acquire insulation resistance at a temperature differing from the actual temperature at which measurement is performed.

- The instrument converts measured resistance to the resistance at a reference temperature and displays the result.
 - There are 10 compensation methods (compensation tables) available depending on the object under test and its characteristics. Choose the appropriate temperature compensation table.
 - The reference temperature may be set to an arbitrary level. The selectable reference temperature ranges vary depending on the compensation table used.
 - The convertible measurement temperature ranges also vary depending on the compensation table used.
- ❖ See Appendix 4 "Temperature Compensation Table" (page 165).

4.3.1 Performing Temperature Compensation

Procedure

1. Measure temperature and insulation resistance. The measurements are held upon completion.
(Either may be measured first.)
 - ❖ 3.2 "Measuring Insulation Resistance" (page 62)
See 3.4 "Measuring Temperature" (page 82).
The temperature may also be entered with keys.
 - ❖ See 6.3 "Entering Temperature and Humidity Measured with External Thermometer and Hygrometer" (page 131).

In the step voltage test mode ([STEP] is on), temperature compensation is unavailable. Exit the step voltage test mode.

 - ❖ See 4.4.3 "Exiting Step Voltage Test Mode" (page 103).

2. Press the **TC** key.

[TABLE No.] blinks.

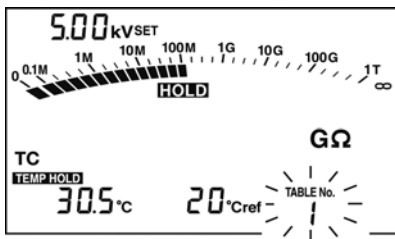

3. Choose a table No. from 0 to 9 using the **←** **→** key.

4. Press the **ENTER** key to confirm the choice of table No.
The reference temperature blinks.

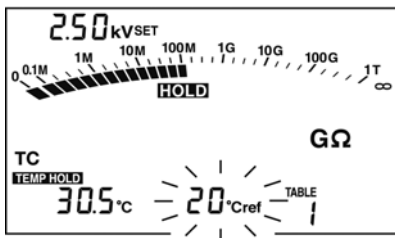

5. Adjust the reference temperature using the **←** **→** key.

If the **←** **→** keys are held down simultaneously, the reference temperature is returned to its default.

(40°C for table 9 and 20°C for the rest.)

6. Press the **ENTER** key to confirm the reference temperature. **[TC]** lights up and the instrument enters temperature compensation mode. The LCD displays the resistance at the reference temperature converted from the measurement.

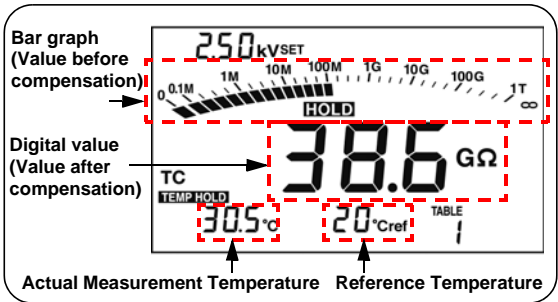

The bar graph shows the value before compensation.

NOTE



- If the resistance before compensation exceeds the measurement range, it cannot be converted and the LCD displays [---].
- After the instrument is placed in temperature compensation mode, measurement or input of temperature and measurement of insulation resistance may be conducted.
- However, if the instrument is placed in temperature compensation mode when the temperature is not held (**TEMP HOLD** is off), measure or enter temperature before measuring resistance. You cannot measure resistance first.

4.3 Temperature Compensation (TC)

NOTE

- Resistance measured by the step voltage test cannot be converted using temperature compensation.
- In temperature compensation mode, leakage current may be displayed by pressing the  key but it cannot be corrected for.

Press the keys shown in the table below to switch the indication.

Indications to be switched	Keys used
Insulation resistance (after compensation) ↔ Leakage current (no compensation)	 key
Temperature / Reference temperature ↔ Elapsed time	 key
Setup screen of actual measurement temperature ↔ Standby state	 key

4.3.2 Exiting Temperature Compensation Mode

Procedure Press the  key.

[TC] is turned off and the instrument exits temperature compensation mode.

4.4 Step Voltage Test



What is it used for?

Used to determine the effect of the test voltage level on insulation resistance of an object.

◆ What is a step voltage test?

- The instrument increases the test voltage gradually and monitors the resultant insulation resistance and leakage current.
- If the insulation resistance decreases as the test voltage increases, the object under test is damp or unclean and requires attention.
(Reference standard → IEEE43-2000 Recommended Practice for Testing Insulation Resistance of Rotating Machinery)

◆ Overview of test

- The test voltage is increased in 5 steps at regular intervals during insulation resistance measurement. The resistance measurement and the current measurement are acquired once at the end of every step.
- The test voltage is applied in one of the two orders below.
STEP2.50 kV: 500 V → 1 kV → 1.5 kV → 2 kV → 2.5 kV
STEP5.00 kV: 1 kV → 2 kV → 3 kV → 4 kV → 5 kV



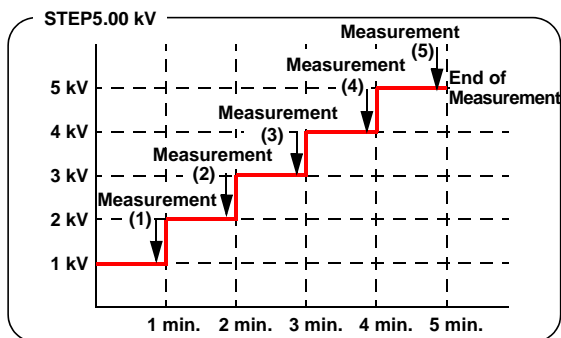

- The voltage is increased when one minute has passed at each voltage step. When 5 minutes has passed in total, measurement automatically stops.



- The voltage application time is adjustable.
- ❖ See 6.2 "Changing and Checking Voltage Application Time for Step Voltage Test" (page 128).
- The voltage application time cannot be varied for each step.

4.4.1 Setting and Conducting a Step Voltage Test

Procedure

- Press the  key in standby state, and the voltage indication will blink.
- Press the  key to choose [STEP2.50 kVSET] or [STEP5.00 kVSET].
 - The voltage value will advance rapidly if the key is held down.
 - Choosing [5.00 kVSET] with the  key and then pressing the  key is a shortcut to select STEP.

3. Press the **ENTER** key.

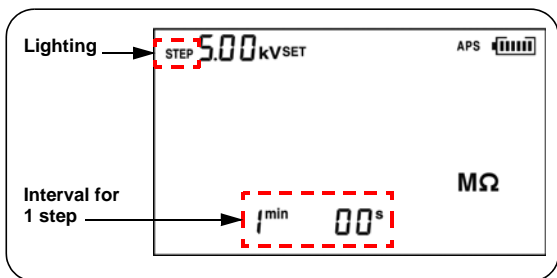

The voltage indication will stop blinking and the instrument enters the step voltage test mode.



4. To start the step voltage test, hold down the



key for more than one second.

The  mark and the  key start blinking, and insulation resistance or leakage current appears on the screen. (Press the **DISPLAY** key to toggle between them.)

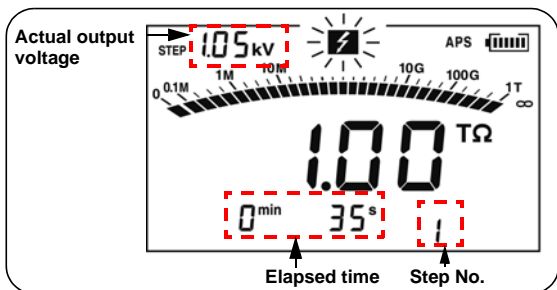

- The test voltage rises at regular intervals and the test stops automatically.

The last data is held and displayed.
(**HOLD** lights up.)

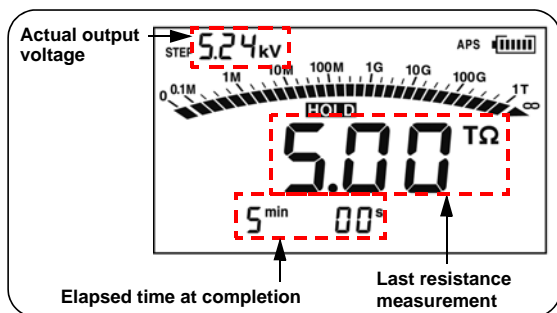

NOTE

- While **[TC]** is on (temperature compensation mode), **STEP** cannot be selected.

Press the **[TC]** key to turn off the **[TC]** indicator.

- To view the set voltage during measurement, press the **[V MON]** key. The set voltage is displayed for approximately 2 seconds.

- After the test, pressing the **[V MON]** key switches between the last output voltage and the test voltage.
- When the instrument is in the step voltage test mode, auto power off is disabled.

4.4.2 Viewing Detailed Data of Each Step after Step Voltage Test



Procedure

1. When the instrument is in standby state after step voltage test, press the  key.

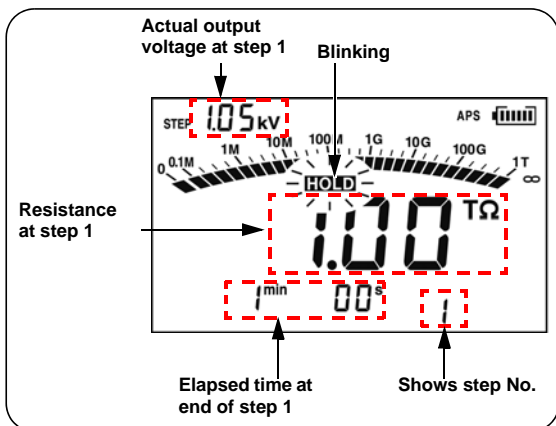
HOLD will blink and the LCD displays the details of the step voltage test data. The first page shows the data at the test voltage for step 1.



2. To display other detailed data, use the following keys.



Indications to be switched	Keys used
Voltages and data at 5 steps	 key
Insulation resistance ↔ leakage current	 key
Elapsed time to the ↔Temperature/ step currently displayed Humidity (Temperature and humidity are measured immediately before or after the test.)	 key

Test voltage (setting) and actual output voltage are toggled automatically.

3. If the  key is pressed on the detailed data screen, the **HOLD** indicator changes from blinking to continuously lit and the LCD returns to the standby screen.

4.4.3 Exiting Step Voltage Test Mode

Procedure

1. Press the  key in standby state, and the voltage indication will blink.
2. To turn off the [STEP] indicator, press the  key several times.
3. Press the  key.
The voltage indication changes from blinking to constantly lit.
The instrument exits the step voltage test mode and returns to normal measurement mode for insulation resistance.

Recording Measurement Data (Memory Function)

5

The instrument stores measurement data, settings, date and time in the internal memory.

Data is not erased when the power is shut off.

There are two recording methods. (Combinable)

Manual recording:	Stores held data
Logging recording:	Stores insulation resistance data at regular intervals.

- The content of a manual records are viewable on the LCD of the instrument.
Further, the records can be downloaded to a PC using the PC software.
- For logging records, only the last value is viewable on the LCD of the instrument. The entire record is viewable on a PC using the PC software.
❖ See 6.4 "Communicating with PC" (page 136).
- Add data No. to data to record. The data No. serves as the address in the memory. The table shows the data No. numbering system.

Recording method	Data No.
Manual recording	A0 - A9, b0 - b9, C0 - C9, d0 - d9, E0 - E9, F0 - F9, H0 - H9, J0 - J9, n0 - n9, P0 - P9 (100 numbers in total)
Logging recording	Lr0 - Lr9 (10 numbers in total. Up to 360 loggings per data No.)

- The table below shows storable data.

Recording method	Type of data	Data stored in one record: record 1
Manual recording	Standard measurement data (Data when neither [TC] nor [STEP] is on)	Data No., year/month/day/hour/minute/second (at the end of resistance measurement), elapsed time, temperature, humidity, test voltage (setting), actual output voltage, resistance (last) / (after 15 sec.) / (after 30 sec.) / (after 1 min.), PI, DAR (1 min/30 s), DAR (1 min/15 s), user-set interval for PI x 2, and, resistance at user-set interval x 2
	Temperature compensation data (Data when [TC] is on)	Data No., year/month/day/hour/minute/second (at the end of resistance measurement), elapsed time, temperature, humidity, test voltage (set value), actual output voltage, resistance (last), Reference temperature, Resistance after compensation, and, table No.
	Step voltage test data (Data when [STEP] is on)	Data No., year/month/day/hour/minute/second (at the end of test), Step time, temperature, humidity, test voltage (set value), actual output voltage x 5, Resistance x 5
Logging recording	-----	year/month/day/hour/minute/second (at the start of logging recording), Measuring interval, temperature, humidity, test voltage (set value), actual output voltage x 360 times, Resistance x 360 times

NOTE

- In step voltage test resistance measurements, only the last measurement at the end of each step is recorded.
- Voltage measurement data cannot be recorded.
- Temperatures are not stored as logging records.

5.1 Recording Measurement Data

5.1.1 Manual Recording (Recording result of one measurement session)

After measurement has been completed, store the data.

- The data numbers available for manual recording are divided into 10 groups (10 records per group), thus up to 100 records can be stored.

A0 - A9, b0 - b9, C0 - C9, d0 - d9, E0 - E9,
F0 - F9, H0 - H9, J0 - J9, n0 - n9, P0 - P9

- There are three types of data: standard measurement data, temperature compensation data, and step voltage test data. These three data sets are stored separately.

Operation Flow

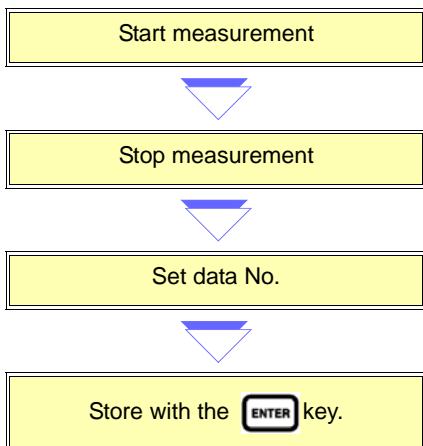

Procedure

1. Measure insulation resistance or temperature and stop measurement. (Temperature and humidity can also be entered by key operation.)

NOTE



Temperature only or temperature and humidity may be stored as a manual record. The instrument, however, has to be in the standard measurement mode (both [STEP] and [TC] off). They cannot be recorded in the step voltage test mode ([STEP] on) or in the temperature compensation mode ([TC] on).

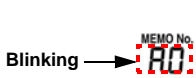

- ❖ Change voltage setting → 3.2.1 Procedure 5. to (page 66)
- ❖ Exit temperature compensation mode → 4.3.2 "Exiting Temperature Compensation Mode" (page 96)
- ❖ Enter temperature/humidity by key operation. → 6.3 "Entering Temperature and Humidity Measured with External Thermometer and Hygrometer" (page 131)

2. Press the  key.



[MEMO No.] lights up and the No. of the last stored No. will blink.



3. Choose data No. using the   key.

Press the   key to display a data number of another group.



Example: . . . ↔ A0 ↔ b0 ↔ C0 ↔ . . .

If the  and  keys are held down simultaneously, the lowest number among the available data numbers appears.

4. Press the  key.

[MEMO No.] blinks and data is recorded.
If a number with **USED** indicator is chosen, existing data will be overwritten with new data.

NOTE

- Temperature may be measured either before or after insulation resistance measurement.
 - If **USED** is indicated for a data No., data is already recorded under the number. (In manual recording, data can be overwritten.)
 - If  is not pressed and the  key is pressed, the LCD returns to the previous screen without recording data.
 - If step voltage test is stopped at any time, data cannot be recorded.
 - If compensated resistance is indicated as [E11] in the temperature compensation mode, data cannot be recorded.
- ❖ About [E11] → 8.3 "Error Display" (page 156)
- Do not turn off power while [MEMO No.] is blinking. Data will be lost.

5.1.2 Logging Recording (Recording at regular intervals)

The instrument stores insulation resistance data at set intervals.

- A total of 10 data numbers are used for logging records; Lr0 to Lr9.
- Each record contains up to 360 loggings.
Selectable recording intervals:
15 sec., 30 sec., 1 min., 2 min., 5 min.
- Maximum number of loggings and maximum recording time vary depending on set recording interval.
(The timer is off.)

Recording interval	Maximum number of loggings	Maximum recording time
15 sec.	360 times	90 min.
30 sec.	360 times	3 hours
1 min.	360 times	6 hours
2 min.	250 times	8 hours and 20 min.
5 min.	100 times	8 hours and 20 min.



- When the timer is set, the instrument automatically stops measurement after the set time has elapsed.
Selectable time: 30 sec. to 30 min. or OFF (When setting to more than 1 minute, the time increments or decrements by 1 minute.)

NOTE

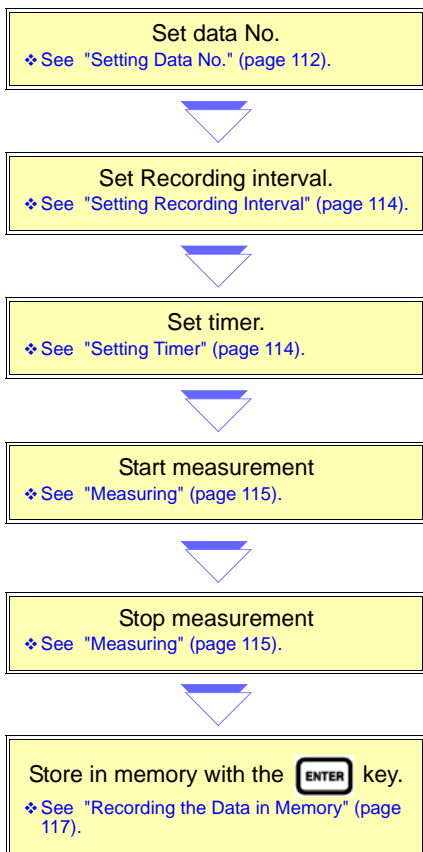
- Continuous recording time is determined by the battery charge level
- If the battery charge level becomes low during measurement, [**LobAt**] appears and the instrument records the measurement data to that point.
- When a low resistance is measured, more power is consumed, thus the instrument may not be able to measure data equal to the maximum number of loggings.
- We recommend the 9459 BATTERY PACK (optional) when performing logging recording, since this pack has a larger capacity.

Operation Flow

Exiting Setup Screen or Logging Recording Mode

- To exit the setup screen, press the  key. No changes will be made to the settings.
- To exit the logging recording mode, press the  key.

Setting Data No.

When held data is displayed, logging recording cannot be selected.

Hold down the  key for more than one second to erase the held data and then perform the operation below.

Procedure

1. Press the  key in standby state. [MEMO No.] lights up and the available No. next to the last stored No. blinks.

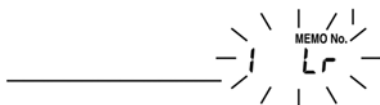



NOTE

Logging recording is not available in the step voltage test mode (the voltage setting is STEP) or in the temperature compensation mode ([TC] is on).

- ❖ Change the voltage setting → 3.2.1 Procedure 5. - (page 66)
- ❖ Exit temperature compensation mode. → 4.3.2 "Exiting Temperature Compensation Mode" (page 96)

2. Press the   key to display a data No., choosing from [Lr0 - Lr9].

When temperature and/or humidity are already held, if the   key is pressed, the data number of another group appears.

Example: . . . ↔ n0 ↔ P0 ↔ Lr0 ↔ A0 ↔ b0 ↔ . . .

NOTE If **USED** is indicated for a data No., data is already recorded under that number. In logging recording, data cannot be overwritten.
Delete the existing data first and then record new data.

3. Press the  key.
Data No. [Lr] changes to continuously lit, and time blinks.

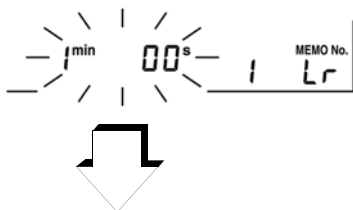

Setting Recording Interval

Procedure

4. Press the  key to display a desired recording interval.



5. Press the  key.

6. The time changes from blinking to continuous and the instrument enters the logging recording mode.





Setting Timer

7. Set the timer.
(Selectable time: 30 sec. to 30 min. or OFF)

Press the  key.

The [TIMER] indicator, time, and TIMER blink.



8. Press the   key to set the time.
If not using the timer, press the  key.
-- min -- s appears.

9. Press the  key.

The instrument returns to the standby state, in which logging recording is available.



The time displayed is the recording interval.



Measuring

Procedure

10. Start insulation resistance measurement.
❖ See 3.2 "Measuring Insulation Resistance"
(page 62 to 78)

The first data is acquired when the first recording interval has elapsed after measurement has started.

-
11. Insulation resistance measurement stops under one of the three conditions below.
1. Time equal to recording interval x maximum number of loggings has elapsed.
 2. The set time of the timer has elapsed.
 3. The  key is pressed.

After measurement has been completed, the data No. blinks.

Data is not stored in the memory at this point.

- If measurement is stopped before the first recording interval elapses, no logging records are acquired and [MEMO No.] and the data No. are turned off.
- When the data No. blinks upon completion of measurement, if [LObAt] appears due to low battery or if power is turned off by the auto power off, the data will be stored in the memory.

-
12. Measure temperature, if necessary. This may be omitted.
Temperature and humidity measured with external thermometer and hygrometer may be entered by key operation.
- ❖ See 3.4 "Measuring Temperature" (page 82).
 - ❖ See 6.3 "Entering Temperature and Humidity Measured with External Thermometer and Hygrometer" (page 131).



Recording the Data in Memory

Procedure

13. Press the  key, after which [MEMO No.] will blink, then extinguish.

The logging data has been stored in the memory.

NOTE Temperature, voltage, and leakage current are not stored as logging records.

5.2 Checking Recorded Data

- The content of a manual record is viewed on the LCD of the instrument.
 - For logging records, only the last value is viewed on the LCD of the instrument. The entire record is viewed on a PC using PC software.
- ❖ See 6.4 "Communicating with PC" (page 136).

Procedure

1. Press the  key in standby state.
([MEMO No.] must be off.)

[READ No.] lights up and data No. and data blink.



2. Press the  key to choose the No. of the data you wish to view. The data stored under the number appears.

Press the  key to display the data number of another group.

Example: . . ↔ A0 ↔ b0 ↔ C0 . .

The recording method of the displayed record is identified as follows.

Data No. is not [Lr]	Manual recording data
Data No. is [Lr]	Logging recording data





The type of manual record is identified as follows.

When neither [STEP] or [TC] is off.	Standard measurement data
When [TC] is on.	Temperature compensation data
When [STEP] is on.	Step voltage test data





For logging records, only the last data is displayed.

- To view data not displayed on the screen, press the keys shown in the table below

◆ Standard Measurement Data

Indications to be switched	Keys used
<p><u>Manual recording</u></p> <p>Insulation resistance → Leakage current ↓ ↑ DAR 1 min/15 s ↓ PI (10/1 min) ← DAR 1 min/30 s</p> <p><u>Logging recording</u></p> <p>Insulation resistance ↔ Leakage current</p>	 key
Elapsed time ↔ Temperature/humidity	 key
Date of measurement ↔ Measurement time ↔ Data	 key <small>MEMO TIME</small>
Return to the standby screen.	 key
Test voltage setting ↔ Actual output voltage (Ex. 5.00 kVSET ↔ 5.25 kV)	Automatic switching

◆ Temperature Compensation Data

Indications to be switched	Keys used
Insulation resistance (after compensation) ↔ Leakage current (no compensation)	 key
Elapsed time ↔ Actual measurement temperature/Reference temperature	 key
Date of measurement ↔ Measurement time ↔ Data	 key MEMO TIME
Return to the standby screen.	 key
Test voltage setting ↔ Actual output voltage (Ex. 5.00 kVSET ↔ 5.25 kV)	Automatic switching
Resistance before compensation ↔ Resistance after compensation Actual measurement temperature/Humidity ↔ Reference temperature/ Table number	 key

NOTE

The leakage current and the bar graph displayed as temperature compensation data are those before compensation.

◆ Step Voltage Test Data

There are two screens showing step voltage test data; Representative data screen and detailed data screen.





Screen	Content of screen	Identification of screen
Representative data	Data of last step	HOLD is off.
Detailed data	Data of every step	HOLD blinks

Temperature, humidity, date and time are viewable on either screen.

Representative Data Screen

When step voltage test data is displayed, the representative data screen appears first, showing data of the last step.







Press the keys shown in the table below to switch the indication.

Indications to be switched	Keys used
Elapsed time ↔ Temperature/Humidity	 key
Date of measurement ↔ Measurement time ↔ Data	 key
Go to the detailed data screen.	 key
Return to the standby screen.	 key
Test voltage setting ↔ Actual output voltage (Ex. 5.00 kVSET ↔ 5.25 kV)	Automatic switching

Detailed Data Screen

Press the  key on the representative data screen, after which **HOLD** will blink and reveal the detailed data screen. The LCD shows the data from the first step.

Press the keys shown in the table below to switch the indication.

Indications to be switched	Keys used
Switch to data of another step.	 key
Insulation resistance ↔ Leakage current	 key
Elapsed time to each step ↔ Temperature/humidity	 key
Date of measurement ↔ Measurement time ↔ Data	 key MEMO TIME
Go to the representative data screen.	 key
Return to the standby screen.	 key
Test voltage setting ↔ Actual output voltage (Ex. 5.00 kVSET ↔ 5.25 kV)	Automatic switching

NOTE

As leakage current data is not stored in the memory, it is calculated again from the voltage and the resistance to display. The recalculated data may vary from the leakage current before recording by $\pm 1\%$.
When the resistance is 0.00 M Ω , [- - -] appears.

5.3 Deleting Recorded Data

5.3.1 Deleting Data of Chosen No.

Select the data to be deleted, and delete only this selection.

Procedure

1. Press the  key in standby state.

2. Press the  key to display the number of the data to delete.

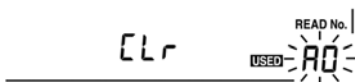

3. Press the  key.

[CLr] appears.



4. After pressing the  key, [CLr] blinks and the data is deleted.



If the  key is pressed without the  key being pressed, the LCD returns to the previous screen without deleting the data.

5.3.2 Deleting all Data

Delete all the manual records and logging records simultaneously.

Procedure

1. Press the **READ** key in a standby state.

2. Press the **CLEAR** key twice.

[ALL CLR] appears.

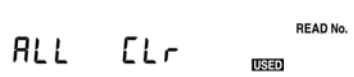

3. Press the **ENTER** key, and [ALL CLR] blinks and all the data are deleted.

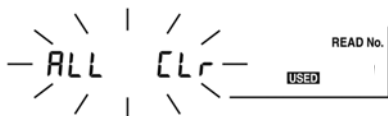

If the **READ** key is pressed without the **ENTER** key being pressed, the LCD returns to the previous screen without deleting the data.

Other Functions

6

6.1 Changing and Checking Interval Setting for PI Calculation

Two intervals required to display the PI value may be changed to user-set intervals.

Selectable range: 1 min. to 30 min.

(Default t1=1 min., t2=10 min.)

6.1.1 Changing Interval Setting



Procedure

1. Press the  key several times while in standby state to display PI.

2. Press the  key.

The first interval blinks.
([t1] lights up.)





3. Set the timer using the   key.

4. Press the  key.

The first interval is confirmed and the second interval will blink. ([t2] lights up.)



5. Set the timer using the   key.
The 2nd interval must be longer than the 1st interval.

6. Press the  key.

The 2nd interval is confirmed and the LCD returns to the PI display screen.
Setting of intervals has been completed.

- When the intervals are not at their defaults, [10/1 min] is off on the PI display screen.
- If insulation resistance is measured in this state, the instrument displays PI calculated from resistance measurements at the set intervals.
- After the interval setting has been changed, PI of the data measured before the change cannot be displayed.
- If the  key is pressed during setting, the instrument returns to a standby state without changing the setting.





The intervals can also be set up on a PC.

- The intervals can be set up on a PC using the data analysis software for 3455.
- The data analysis software for 3455 must be installed on the PC.
- ❖ Details → See 6.4 "Communicating with PC" (page 136).

6.1.2 Checking Interval Setting

Procedure

1. Press the  key several times while in standby state to display PI.

2. Press the  key.

The setting of the first interval [t1] will blink. Check the setting.



3. Press the  key.

The setting of the second interval [t2] will blink. Check the setting.



4. Press the  or  key.





The LCD returns to the PI display screen.

6.2 Changing and Checking Voltage Application Time for Step Voltage Test

- Change the voltage application time for step voltage test. Selectable presets: 30 sec., 1 min., 2 min., 5 min. (Default is 1 min.)
- The voltage application time to set up is the application time for a voltage step, not the total application time for 5 steps.

6.2.1 Changing Time Setting

Procedure

1. Press the  key while in standby state, and the voltage indication will blink.
2. Press the  key to choose [STEP2.50 kVSET] or [STEP5.00 kVSET].
 - If the key is held down the voltage value changes rapidly.
 - Choosing [5.00 kVSET] with the  key and then pressing the  key is a shortcut to select STEP.

3. Press the  key.

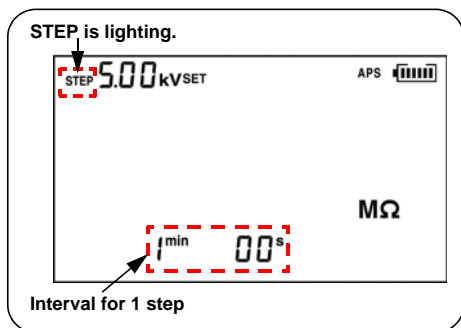

The voltage indication changes from blinking to continuously lit, and the instrument enters the step voltage test mode.

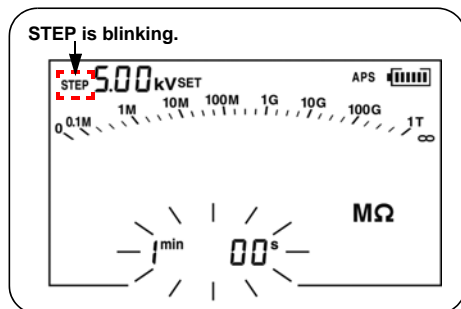

4. Press the  key.

STEP and the time will blink.



5. Set the time using the   key.

- Press the **ENTER** key.
The time changes from blinking to continuously lit.
Setting of the time has been completed.

- ◆ **The time can also be set up on a PC**
- The time can be set up on a PC using the data analysis software for 3455.
 - The data analysis software for 3455 must be installed on the PC.
 - ❖ Details → See 6.4 "Communicating with PC" (page 136).

6.2.2 Checking Time Setting

Procedure

- Press the **TEST VOLTAGE** key while in standby state, and the voltage indication will blink.
- Choose a step voltage test mode ([**STEP2.50 kVSET**] or [**STEP5.00 kVSET**]) and press the **ENTER** key.
The time for one step appears.

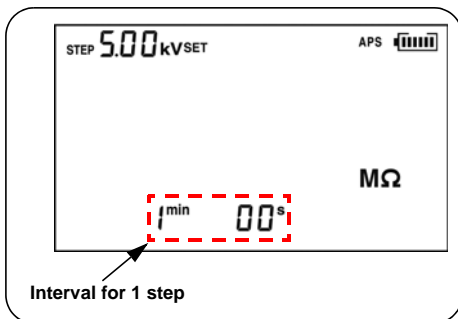

6.3 Entering Temperature and Humidity Measured with External Thermometer and Hygrometer

Enter temperature and humidity measured with external thermometer and hygrometer instead of the temperature measuring function of the instrument.

- Disconnect the temperature sensor before entering the data.
- After entering temperature and humidity, record them using the memory function.
- Details of memory function
 - ❖ Details of memory function →
See 5 "Recording Measurement Data (Memory Function)" (page 105).
- Input range: Temperature -10.0 to 70.0°C
Humidity 0.0 to 99.9% RH

Operation Flow

Enter temperature/humidity.

- ❖ See "Entering Temperature and Humidity" (page 132).



Save temperature/humidity data.

- ❖ See "Saving Temperature and Humidity Data" (page 134).

6.3.1 Entering and Saving



Entering Temperature and Humidity

Procedure



1. Press the  key in standby state.



The temperature will blink.



2. Enter temperature using the  

  keys.

  keys: Move the cursor.

  keys: Raise and lower.

3. Press the  key.

The humidity will blink.

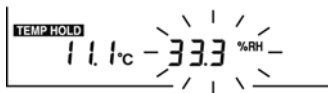



When [TC] is on, the instrument returns to the standby state without indicating humidity.

4. Enter humidity using the

 keys.

 keys: Move the cursor.

 keys: Raise and lower.

5. Press the  key.

The instrument holds the entered temperature and humidity values.

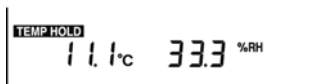

NOTE



- Even if humidity is held, when the temperature sensor is connected, the humidity is not displayed
- When resistance and current values are still in memory or when the instrument is in the step voltage test mode, the temperature and humidity indications are turned off after being entered and the time lights up.
- If the  key is pressed when the temperature and humidity indications are blinking, the instrument returns to the standby state before they are entered.



Saving Temperature and Humidity Data

Save the temperature and humidity data in the memory.

Procedure

6. Press the  key.
MEMO TIME
7. Press the  keys to choose a data No.
8. Press the  key.
[MEMO No.] will blink and the data is recorded.





NOTE

When only temperature and humidity are stored in the memory, they are recorded as standard measurement data. Resistance, voltage and other data are recorded as - - -.

6.3.2 Clearing Indications of Temperature and Humidity Stored Data

To turn off the **TEMP HOLD** indicator and clear stored temperature and humidity data, follow the procedure below.

Procedure

1. If a temperature sensor is connected to the instrument, disconnect the sensor.
2. Press the  key while in the standby state.
The temperature will blink.
3. Press the  key.
The temperature is indicated as [- - -°C].
4. Press the  key.
The humidity indicator will blink.
5. Press the  key.
The humidity is indicated as [- - - %RH].
6. Press the  key.

NOTE

This procedure only clears the indications on the screen and does not delete the temperature and humidity data stored in the memory.

❖ Delete data → See 5.3 "Deleting Recorded Data" (page 123).

6.4 Communicating with PC



What is it used for?

Used to make a table or graph of the data stored in the memory or create a report.

Data saved in the memory may be downloaded to a PC and the instrument settings may be changed using a PC.

- The data analysis software for 3455 (PC software) must be installed on the PC.
- Insulation resistance measurement, leakage current measurement, or voltage measurement cannot be performed while the instrument is communicating with a PC.

◆ Recommended System Requirements

OS	Windows XP/Vista (32bit) Windows 7/8/10 (32bit/64bit) CPU : Pentium III, 500 MHz or faster Display : 1024x768 resolution monitor, 32-bit color recommended Memory : 128 MB of memory or more
HDD space	Min. 30 MB free disk space
Interface	USB Ver2.0 (full speed) Connectable to one IR3455 unit.

◆ Functions of Data Analysis Software for 3455

- Transmits memory data to a PC from the instrument.
- Displays received data and logging records, and makes graphs of step voltage test data.
- Creates/prints out reports.
- Edits the settings of the instrument on a PC.
- Saves the data (CSV format)
- Copies and pastes the graph
- Saves the report in RTF format (non-Windows8/10-compliant)

◆ Settings Editable on PC

- Date and time
- PI Interval
- Voltage application time for step voltage test

6.4.1 Installing Data Analysis Software for 3455

Before connecting the instrument to a PC for the first time, be sure to install the data analysis software for 3455 on the PC.

Procedure

1. Insert the CD into the CD-ROM drive.
2. Run the [**X:/English/Data_Analysis_Software_for_3455Eng.exe**]
([X] represents the letter of the CD-ROM drive, and may differ from computer to computer.)
3. Install the software by following the on-screen instructions.
Refer to the user's manual which is included in CD.

NOTE

"Data Analysis Software for 3455" can be downloaded from the HIOKI website
URL → <http://www.hioki.com/>

6.4.2 Installing Driver

Installation procedure

1. Log in as "administrator" or as other such administrative authority.
2. Before installing, close all applications currently running on the computer.
3. Execute the [**driverSetup_English.msi**] file inside the [**USB Driver**] on the CD, and follow the instructions as shown on the screen to start the installation.
A warning message will be displayed because it would not qualify for the "Certified for Windows" logos, but ignore it and continue the installation.
4. After installation is completed, the instrument will automatically be recognized by the computer when connected with a USB cable. If a search wizard screen for new hardware is displayed, select [**No, not this time**] to confirm Windows Update connection and select [**Install the software automatically**].
Even when connecting instruments of different serial numbers, you may be notified that a new device has been detected. Follow the instructions on the screen and install the device driver.

6.4.3 Downloading Data to Save to PC/ Setting up Instrument on PC

NOTE Use a 2-m or shorter USB cable to avoid noise.
Do not connect to the instrument if test leads are still connected.

Procedure

1. Move the shutter to reveal the USB terminal.

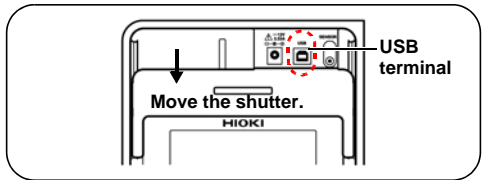

2. Connect the USB Cable to the USB terminal.

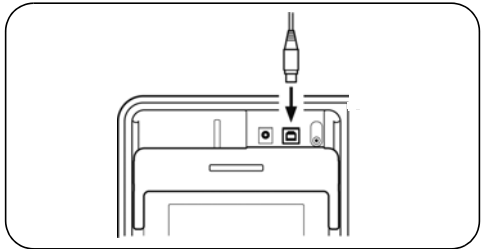

3. Click the **[Start]** button and choose **[Programs]**-**[HIOKI]**-**[3455]**-**[Data Analysis Software for 3455 English]**.
❖ Operation → See the help function or the user's manual of the data analysis software for 3455.

- NOTE**
- One IR3455 unit is connected to one PC.
 - Do not disconnect the USB Cable during data transmission, to avoid transmission errors.



About the "Data Analysis Software for 3455 User's Manual"

- To open the user's manual, click [**Start**] and then select [**Programs**] - [**HIOKI**] - [**3455**] - [**Data Analysis Software For 3455 User's Manual**].
- NOTE**
- The user's manual is stored in the [**English**] folder on the supplied CD.
 - To view the user's manual, PDF viewer such as Adobe Reader must be installed on your computer.

Specifications

7

7.1 General Specifications

Operating temperature and humidity	-10°C to 40°C (14°F to 104°F), less than 80% RH (no condensation) 40°C to 50°C (104°F to 122°F), at 50°C and below relative with linear decrease up to 50% RH (Battery pack charge: 0°C to 40°C, less than 80% RH)
Storage temperature and humidity	-10°C to 50°C (14°F to 122°F), less than 90% RH (no condensation) Battery pack: -20°C to 30°C, less than 80% RH (no condensation)
Guaranteed accuracy period	1 year
Operating environment	Indoors, Pollution degree 2, Up to 2000 m (6562 ft.) ASL
Measuring method	DC voltage application (insulation resistance) and mean-value rectification (voltage)
A-D conversion	Double integral
Display	LCD with backlight displaying up to a count of 999
Overflow indication	>, OF
Underflow indication	<, -OF
Display update rate	<ul style="list-style-type: none"> • Insulation resistance/leakage current: Once/sec. (0.25 times/sec. if averaging function used) • Output voltage monitor: Twice/sec. • Voltage measurement: Fourth/sec. • Temperature measurement: Once/sec. • Bar graph: Twice/sec.

Terminals	(1) Insulation resistance/voltage measurement: +, -, GUARD (GUARD terminal is used for insulation resistance/leakage current measurement only.) (2) Other: Temperature sensor, USB, and AC adapter (1) and (2) are mutually exclusive.
Power supply	<ul style="list-style-type: none"> • AA alkaline battery (LR6) × 6, Rated supply voltage 1.5 VDC × 6 • 9459 BATTERY PACK Rated supply voltage 7.2 VDC (Rechargeable, NiMH) • 9753 AC ADAPTER Rated supply voltage 100 to 240 VAC (Voltage fluctuations of ±10% are taken into account.), Rated supply frequency 50/60 Hz, Output rating 12 VDC, 3.33 A
Maximum rated power	15 VA (when AC adapter is used), 6 VA (when battery or battery pack is used)
Life of back up battery	Approx. 10 years (reference data at 23°C)
Continuous operating time	Alkaline battery: Approx. 5 hours 9459 BATTERY PACK: Approx. 9 hours (Conditions: Generating 5 kV, Open between + & - terminals, backlight off, and reference data at 23°C)
Maximum input voltage	750 VAC, 1000 VDC
Maximum input frequency	70 Hz
Maximum rated voltage to earth	Measurement category III 1000 V, Measurement category IV 600 V, (anticipated transient overvoltage 8000 V)
Overload protection	1000 VAC, 1200 VDC 1 min. Between + & - terminals
Dustproof and waterproof	IP40 (EN60529) When the USB port is covered by the shutter
Maximum capacitance load	4 μF
Dimensions	Approx. 260W × 251H × 120D mm (Approx. 10.2"W×9.9"H×4.7"D) (Not including handle and protrusions)

Mass	Approx. 2.8 kg (Approx. 98.8 oz.) (Including the accessories; test leads, alligator clips and alkaline battery)
Standards	Safety EN61010 EMC EN61326
Product warranty period	3 years
Accessories	<ul style="list-style-type: none"> • 9750-01 TEST LEAD (Red, Approx. 3 m) 1 • 9750-02 TEST LEAD (Black, Approx. 3 m) 1 • 9750-03 TEST LEAD (Blue, Approx. 3 m, for GUARD) 1 • 9751-01 ALLIGATOR CLIP (Red) 1 • 9751-02 ALLIGATOR CLIP (Black) 1 • 9751-03 ALLIGATOR CLIP (Blue, for GUARD) 1 • Instruction Manual 1 • AA alkaline battery (LR6) 6 • USB Cable 1 • CD (Data Analysis Software for 3455).... 1
Options	<ul style="list-style-type: none"> • 9631-01 TEMPERATURE SENSOR (Thermistor, Molded type, Approx. 1 m) • 9631-05 TEMPERATURE SENSOR (Thermistor, Molded type, Approx. 5 cm) • 9750-11 TEST LEAD (Red, Approx. 10 m) • 9750-12 TEST LEAD (Black, Approx. 10 m) • 9750-13 TEST LEAD (Blue, Approx. 10 m, for GUARD) • 9459 BATTERY PACK • 9753 AC ADAPTER
Interface	<ul style="list-style-type: none"> • USB ver. 2.0 (full speed) • Used for communications using PC application software (Data Analysis Software for 3455)
PC application software	<ul style="list-style-type: none"> • Transmits data in memory from the instrument to PC. • Edits the instrument settings on PC. • Features report function.

❖ Specifications of Model 9750 and 9751→
See 7.3 "9750-01/-02/-03/-11/-12/-13 and 9751-01/-02/-03 ALLIGATOR CLIPS Specifications" (page 152).

Additional Functions

- **Temperature compensation function**
- **PI/DAR display function**
- **Step voltage test function**
- **Data memory function**
Manual recording (100 records), logging recording (10 records), recording, recall display, single record deletion, all records deletion, data transfer to PC using software
- **Temperature/humidity input function**
(Temperature input range: -10.0°C to 70.0°C , Humidity input range: 0.0% to 99.9% RH)
- **Timer function**
Enabled for insulation resistance/leakage current measurement. (Selectable time: 30 sec. to 30 min. or OFF)
- **Elapsed time display function**
Enabled for insulation resistance/leakage current measurement.
- **Clock function**
Displays year, month, day, hours, minutes and seconds; auto calendar; automatic leap year correction; 24-hour clock; and lithium battery backup (clock accuracy: ± 100 ppm)
- **Averaging function**
Averages insulation resistance/current leakage measurement values.
- **Data hold function**
Retains and displays the last data upon completion of measurement.
(Items retained: Insulation resistance (with/without temperature compensation), leakage current, elapsed time, PI, DAR, actual output voltage, step voltage test result, and temperature)
- **Automatic discharge function**
- **Warning display function** for voltage generation
- **Warning display function** for live line
If a 50 V or higher voltage is input to the +

and - terminals, the  mark and



key lamp blinks.

**Additional
Functions**

- **LCD backlight function**
- **Auto power off function**
- **Buzzer function**
- **Communications function**
- **Battery pack charge function**
Charges the 9459 BATTERY PACK using the 9753 AC ADAPTER.
Rapid charging time: Approx. 3 hours (at 23°C)
- **System reset**

7.2 Measurement Specifications

Values measured: Insulation resistance, leakage current, voltage, and temperature

7.2.1 Insulation Resistance Measurement

Measurement test voltage Selectable range: 250 V DC to 5.00 kV DC
 Setting method:

- Choose from test voltage presets (250 V, 500 V, 1 kV, 2.5 kV, 5 kV)
- Fine adjustment (between 250 V and 1 kV with a resolution of 25 V or between 1 kV and 5 kV with a resolution of 100 V.)

Output voltage accuracy

- -0% and +10% of setting
- Applies when the instrument measures a resistance equal to or higher than the result of division of test voltage (set value) by rated measuring current.

*Rated measuring current:

Electric current that can be generated with the set test voltage is maintained.

Test voltage (setting)	Rated measuring current* (Tolerance: -0%,+10%)
250 V to 1.00 kV	1 mA
1.10 kV to 2.50 kV	0.5 mA
2.60 kV to 5.00 kV	0.25 mA

Short-circuit current 2 mA or less

Output voltage monitor function Display range: 0 V to 999 V, 0.98 kV to 5.50 kV
 Monitored value accuracy: $\pm 5\%$ rdg. ± 5 dgt.
 (Actual output voltage is within the tolerance of the output voltage accuracy given above.)

Measuring range Resistance obtained by dividing the value of the range from 0.00 M Ω to the test voltage (set value) by 0.5 nA (Measuring range varies according to test voltage.)

Preset Test Voltage Measuring Range

Preset test voltage (setting)	Measuring range
250 V	0.00 M Ω to 500 G Ω
500 V	0.00 M Ω to 1.00 T Ω
1 kV	0.00 M Ω to 2.00 T Ω
2.5 kV	0.00 M Ω to 5.00 T Ω
5 kV	0.00 M Ω to 10.0 T Ω

Resistance Ranges

Auto range

Resistance range name	Measuring range
10 M Ω range	0.00 M Ω to 9.99 M Ω
100 M Ω range	9.0 M Ω to 99.9 M Ω
1000 M Ω range	90 M Ω to 999 M Ω
10 G Ω range	0.90 G Ω to 9.99 G Ω
100 G Ω range	9.0 G Ω to 99.9 G Ω
1000 G Ω range	90 G Ω to 999 G Ω
10 T Ω range	0.90 T Ω to 9.99 T Ω

When a value below the lower limit of each range is displayed, the accuracy is not guaranteed

Measurement Accuracy

Temperature and humidity range for guaranteed accuracy:
0°C to 28°C, less than 80% RH (no condensation)

Measuring range	Measurement accuracy
Equal to or less than the resistance obtained by dividing the test voltage (set value) by 100 nA.	$\pm 5\% \text{rdg.} \pm 5 \text{dgt.}$
Greater than the resistance calculated by dividing the test voltage (setting value) by 100 nA, less than or equal to the resistance calculated by dividing the test voltage (setting value) by 1 nA, or less than or equal to 500 G Ω	$\pm 20\% \text{rdg.} \pm 5 \text{dgt.}$
Greater than the resistance calculated by dividing the test voltage (setting value) by 1 nA, or within the range of 501 G Ω to 9.99 T Ω	$\pm 30\% \text{rdg.} \pm 50 \text{dgt.}$

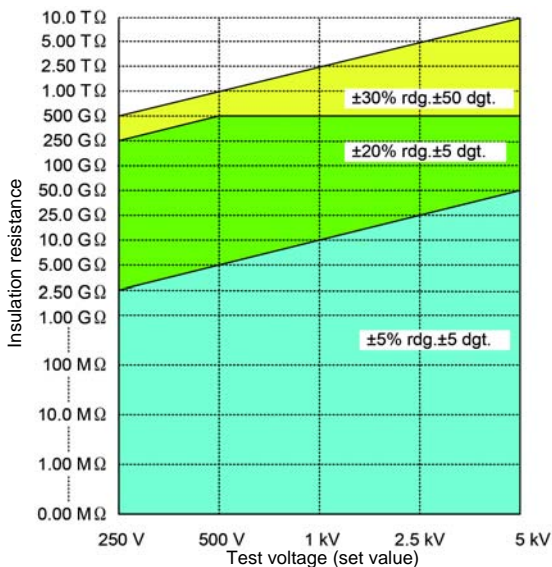

Temperature characteristics	Measurement accuracy $\times 1$ is added to the accuracy. When the 9750-11, 9750-12 TEST LEAD (10 m) is used, a resistance of 501 G Ω or more is not guaranteed. (with an ambient temperature outside the range of 0°C to 28°C)
Response time	Within 15 sec. (This is the period of time after measurement has started until the displayed value falls within the specified accuracy range, when averaging is not used.)

7.2.2 Leakage Current Measurement

Electric current is measured with the test voltage generated, as in insulation resistance measurement.

Measuring range: 1.00 nA to 1.20 mA

Current Ranges and Measurement Accuracy

- Auto range
- Temperature and humidity range for guaranteed accuracy: 0°C to 28°C less than 80% RH (no condensation)

* When a value below the lower limit of each range is displayed, the accuracy is not guaranteed

Current range name	Measuring range*	Measurement accuracy
10 nA range	1.00 nA - 9.99 nA	$\pm 15\%$ rdg. ± 1 nA
100 nA range	9.0 nA - 99.9 nA	$\pm 15\%$ rdg. ± 5 dgt.
1000 nA range	90 nA - 999 nA	$\pm 2.5\%$ rdg. ± 5 dgt.
10 μA range	0.90 μ A - 9.99 μ A	
100 μA range	9.0 μ A - 99.9 μ A	
1 mA range	90 μ A - 999 μ A, 0.90 mA - 1.20 mA	

Temperature characteristics	Measurement accuracy $\times 1$ is added to the accuracy. When the 9750-11, 9750-12 TEST LEAD (10 m) is used, the accuracy is not guaranteed if the current is below the value obtained by dividing the test voltage (set value) by 500 G Ω . (with an ambient temperature outside the range of 0°C to 28°C)
Response time	Within 15 sec. (This is the period of time after measurement has started until the displayed value falls within the specified accuracy range, when averaging is not used.)

7.2.3 Voltage Measurement

Temperature and humidity range for guaranteed accuracy:
23 \pm 5°C less than 80% RH (no condensation)

Measuring range	± 50 VDC to ± 1.00 kVDC, 50 VAC to 750 VAC
Frequency	DC / 50Hz / 60Hz
Measurement accuracy	$\pm 5\%$ rdg. ± 5 dgt.
Input resistance	10 M Ω or more
Temperature characteristics	Measurement accuracy $\times 0.5$ is added to the measurement accuracy. (when the ambient temperature is not 23 \pm 5°C)
Response time	Within 3 sec.

7.2.4 Temperature Measurement

Temperature and humidity range for guaranteed accuracy:
 $23 \pm 5^{\circ}\text{C}$ less than 80% RH (no condensation)

Measurement Range, Accuracy

Accuracy when using with the 9631 TEMPERATURE SENSOR

Measuring range	Measurement accuracy
-10.0°C to -0.1°C	$\pm 1.5^{\circ}\text{C}$
0.0°C to 40.0°C	$\pm 1.0^{\circ}\text{C}$
40.1°C to 70.0°C	$\pm 1.5^{\circ}\text{C}$

When the 9631-05 TEMPERATURE SENSOR is used, the accuracy is guaranteed within 0.0°C to 40.0°C .

Temperature characteristics	Measurement accuracy $\times 0.5$ is added to the measurement accuracy. (when the ambient temperature is not $23 \pm 5^{\circ}\text{C}$)
Response time	Approx. 100 sec. Including the period of time for the response of the 9631-01, 9631-05 TEMPERATURE SENSORS. (Reference value: Period of time until 90% of the change in temperature is reflected in the indication)
Influence of radioactive RF electromagnetic field	$\pm 2^{\circ}\text{C}$ at 3V/m

7.3 9750-01/-02/-03/-11/-12/-13 and 9751-01/-02/-03 ALLIGATOR CLIPs Specifications

Operating temperature and humidity -10°C to 50°C (14°F to 122°F), less than 80% RH (no condensation)

Operating environment Indoors, Pollution degree 2, Up to 2000 m (6562 ft.) ASL

Storage temperature and humidity -10°C to 50°C (14°F to 122°F), less than 90% RH (no condensation)

Maximum rated voltage to earth 5000 VDC/2 mA
(insulation resistance measurement)
1000 VAC
Measurement category III
600 VAC
Measurement category IV
Anticipated transient overvoltage 8000 V

Rated voltage 1000 VAC, 5000 VDC

Rated current 10 A

Applicable Standards
Safety EN61010

9750-01/-02/-03/-11/-12/-13 TEST LEADs and 9751-01/-02/-03 ALLIGATOR CLIPs are exclusively for use with IR3455 and IR3455-30.

Maintenance and Service

8

- If damage is suspected, check the "Troubleshooting" section before contacting your authorized Hioki distributor or reseller.
- The instrument contains a built-in backup lithium battery, which offers a service life of about 10 years. If the date and time deviate substantially when the instrument is switched on, it is the time to replace that battery. Contact your authorized Hioki distributor or reseller.
- The life of the battery pack is 500 charging cycles or approximately one year of use. If the operating time is extremely short after the battery pack has been charged correctly, replace it with a new battery pack.
- Do not replace the lithium battery. This will void the guarantee.

Shipment

When transporting the instrument be sure to observe the following precautions:

- To avoid damage to the instrument, remove the batteries from the instrument. Moreover, be sure to pack in a double carton. Damage occurring during transportation is not covered by the warranty.
- When sending the instrument for repair, be sure to include details of the problem.

Calibrations

The calibration period varies depending on the status of the instrument or installation environment. We recommend that the calibration period be determined in accordance with the status of the instrument or installation environment. Please contact your Hioki distributor to have your instrument periodically calibrated.

8.1 Troubleshooting

If the instrument is not working correctly, check the troubleshooting table below first before contacting authorized Hioki distributor or reseller.

Problem	Check Item	Action	Reference Section
Power is not turned on	<ul style="list-style-type: none"> •Is the battery installed? •Is battery power low? 	Install new battery	❖ 2.1.1 (P.36)
	Is the battery polarity correct?	Check the polarity	❖ 2.1.1 (P.36)
	Is the battery pack charged?	Charge the battery pack.	❖ 2.1.4 (P.47)
	Is the battery selector switch in the correct position?	Check the position of the battery selector switch.	❖ 2.1.1 (P.36) ❖ 2.1.2 (P.39)
Battery pack is not charged.	Is the power plug of the AC adapter inserted fully?	Is the power plug of the AC adapter inserted fully?	❖ 2.1.3 (P.45)
	Is the battery pack installed?	Install the battery pack.	❖ 2.1.2 (P.39)
Resistance measurement value is incorrect.	Is the test lead damaged?	Replace the test lead.	-
	Is the test lead inserted fully?	Insert the test lead fully.	❖ 2.4 (P.56)
	Are the test leads connected to the correct terminals?	Check the terminals.	❖ 2.4 (P.56)

Problem	Check Item	Action	Reference Section
Monitored voltage during resistance measurement is low.	Is the resistance small?	The output voltage is lowered for measurement of low resistance values.	❖ Appendix 1 (P.163)
Temperature is not measured.	Is the sensor inserted fully?	Insert the sensor fully.	❖ 2.5 (P.58)
Resistance is not measured in temperature compensation mode.	Have you measured temperature first?	Measure temperature before resistance.	❖ 4.3 (P.93)
The instrument cannot communicate with the PC.	Is the USB cable connector inserted fully?	Insert the USB cable connector fully.	❖ 6.4 (P.136)
Power fails upon measuring insulation resistance.	Is the battery power low?	Replace with new battery.	❖ 2.1.1 (P.36)
	Is the battery pack charged?	Charge the battery pack.	❖ 2.1.4 (P.47)
	Is the GUARD terminal short-circuited with the test lead connected to the + terminal?	Check the connection to the test lead clips.	❖ 3.2.1 Procedure 3. (P.65)

If the cause is unknown, try resetting the system.

❖ See 8.4 "Performing System Reset" (page 158).

8.2 Cleaning

To clean the instrument, wipe it gently with a soft cloth moistened with water or mild detergent.

Wipe the instrument with a dry cloth for finishing.

NOTE Wipe the LCD gently with a soft, dry cloth.

8.3 Error Display



Error display	Details	Action
rEC Err	Data stored in the memory is corrupted or missing.	Delete the data.
rEC Full	Memory data are stored under all the data numbers and there is no vacant No.	Delete or replace data.
n0 AdJ	Internal memory error has occurred.	This requires repair.
LObAt	AA batteries or battery pack is low.	Replace the batteries or charge the battery pack.
Err00	Internal ROM error has occurred.	This requires repair.
Err01	Internal memory error has occurred.	

Error display	Details	Action
	When power is turned on for the first time after the backup battery is replaced, Err02 appears.	Reinstall the battery.
Err02	If Err02 appears even after the battery has been reinstalled, the life of the backup battery has expired, the battery is faulty, or some other cause exists.	This requires repair. (Err03 to Err05 may be temporarily displayed during discharging after measurement, but this does not indicate a malfunction.)
Err03	Voltage measurement error has occurred.	
Err04	Current measurement error has occurred.	
Err05	Temperature measurement error has occurred.	
Err06	The discharge circuit is faulty.	
E11	<p>Details: The actual temperature for temperature compensation exceeds the convertible range or the reference temperature exceeds the selectable range..</p> <p>Action: Perform temperature compensation within the temperature ranges specified in the tables in Appendix 4 "Temperature Compensation Table" (page 165).</p>	

8.4 Performing System Reset

System reset returns the settings of the instrument to their defaults (excluding date and time), but this will not clear the memory data.

Procedure

1. While holding down the  key in standby state, press the  key. [rESet] appears.
2. Press the  key, and [rESet] will blink and the LCD returns to the standby screen. System reset is complete.

The table below shows the default settings.

Setting Items	Settings
Resistance/current	Resistance
Test voltage	250 V
Timer	OFF
PI interval	t1=1 min., t2=10 min.
Temperature compensation	OFF
Table No. displayed first when temperature compensation is selected.	0
Reference temperature for temperature compensation	20°C for table No. 0 to 8 40°C for table No. 9
Step voltage test	OFF
Duration of one step in step voltage test	1 min.
Logging recording interval	1 min.
Average	OFF
Auto power off	ON

8.5 Discarding the Instrument

When disposing of this instrument, remove the lithium battery and dispose of battery and instrument in accordance with local regulations.

 **WARNING**

- To avoid electric shock or malfunction of the instrument, do not attempt to use the instrument again by installing a new lithium battery.
- Keep batteries away from children to prevent accidental swallowing.

CALIFORNIA, USA ONLY

Perchlorate Material - special handling may apply.
See www.dtsc.ca.gov/hazardouswaste/perchlorate

Removal of Lithium Battery

Tools: Phillips screwdriver, hexagonal wrench, and tweezers

1. Turn off power to the instrument and remove the AA batteries and battery pack.
 - ❖ See 2.1.1 "Installing or Replacing the Battery" (page 36), and 2.1.2 "Installing the Battery Pack (Rechargeable nickel-hydrogen battery)" (page 39)
2. Remove the four set screws on the rear of the instrument and remove the lower casing.

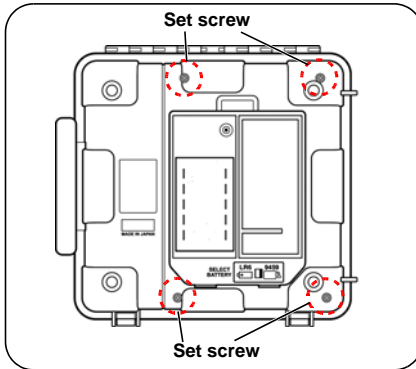

3. Remove the screw and pin holding the two printed circuit boards, and remove them.
The PCB nearest the LCD should not be removed.

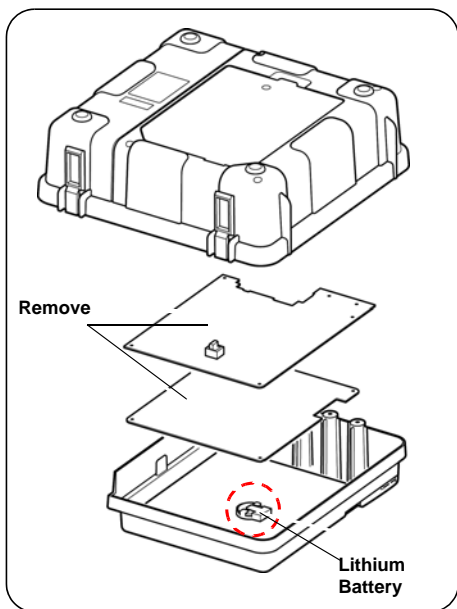

4. The battery is located on the remaining PCB as shown in the illustration on the previous page.

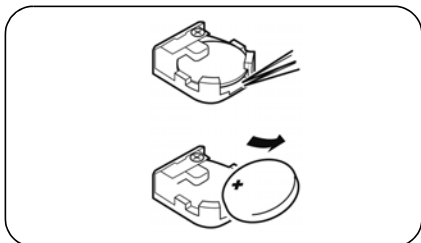

Insert tweezers or other similar pointed tool between the battery and the battery holder. Raise the battery to remove.

Appendix

Appendix 1 Test Voltage Characteristic Graph

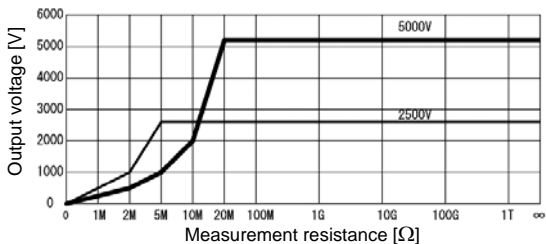
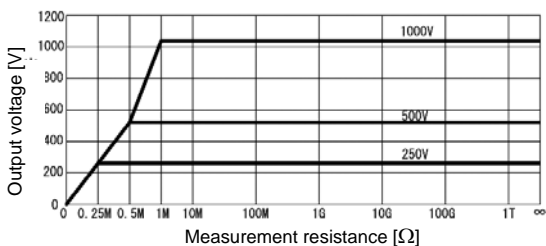

Appendix 2 Example of Insulation Resistance Criteria

Primary criteria for insulation resistance of high-voltage cable (as a rough guide)

Part of cable	Measurement voltage [V]	Insulation resistance [M Ω]	Judgment
Insulator	5,000	5,000 or more	Non-defective
		500 to below 5,000	Needs attention
		below 500	Defective
Sheath	500 or 250	1 or more	Non-defective

High-voltage power receiving facility code 2002

Appendix 3 Example of PI Criteria (Polarization Index)

IEEE43-2000 Recommended Practice for Testing Insulation Resistance of Rotating Machinery recommends the criteria as shown in the table below for insulation resistance testing of a motor.

Heat resistance class	Recommended lowest PI
Class A	1.5 or more
Class B	2.0 or more
Class F	2.0 or more
Class H	2.0 or more

Appendix 4 Temperature Compensation Table

The temperature compensation function uses the tables below.

- Tables No.0 to 8 are based on Chinese standards.
- Table No.9 is based on the US IEEE standards.

Table No.0

Object under test	Oil-impregnated power transformer
Selectable reference temperature range	-10 to 70°C (default 20°C)
Convertible range of actual temperature used for measurement	-10.0 to 70.0°C
Compensation formula	$R_{tref} = 1.5^{(t - t_{ref})/10} \times R_t$ <p> R_{tref} : Resistance after compensation for reference temperature of t_{ref}°C R_t : Resistance measured at the temperature of t°C t_{ref} : Reference temperature [°C] t : Actual temperature used for measurement [°C] </p>

Source → GB50150-91 Standard for hand-over test of electric equipment, electric equipment installation engineering (Chinese)

Reference → DL/T596-1996 Power installation preventive maintenance code (Chinese)

Table No.1

Object under test	Motor stator winding: thermoplastic insulating material
Selectable reference temperature range	5 to 75°C, (default 20°C)
Convertible range of actual temperature used for measurement	5.0 to 70.0°C
Compensation formula	<p>Converted to a resistance value at the reference temperature using the formula below and result displayed.</p> $R_{tref} = 2^{(t - t_{ref})/10} \times R_t$ <p> <i>R_{tref}</i> : Resistance after compensation for reference temperature of <i>t_{ref}</i>°C <i>R_t</i> : Resistance measured at the temperature of <i>t</i>°C <i>t_{ref}</i> : Reference temperature [°C] <i>t</i> : Actual temperature used for measurement [°C] </p>

Source →GB50150-91 Standard for hand-over test of electric equipment, electric equipment installation engineering (Chinese)

Table No.2

Object under test	Motor stator winding: Class B thermostetting insulating material
Selectable reference temperature range	5 to 100°C, (default 20°C)
Convertible range of actual temperature used for measurement	5.0 to 70.0°C
Compensation formula	<p>Converted to a resistance value at the reference temperature using the formula below and result displayed.</p> $R_{tref} = 1.6^{(t - t_{ref})/10} \times R_t$ <p> <i>R_{tref}</i> : Resistance after compensation for reference temperature of <i>t_{ref}</i>°C <i>R_t</i> : Resistance measured at the temperature of <i>t</i>°C <i>t_{ref}</i> : Reference temperature [°C] <i>t</i> : Actual temperature used for measurement [°C] </p>

Source →GB50150-91 Standard for hand-over test of electric equipment, electric equipment installation engineering (Chinese)

Table No.3 to 8

Object under test	Power cable (Classified in one of the tables No.3 to 8 depending on material and operating voltage.)
Selectable reference temperature range	Selectable range of each table is as follows. Set to 20°C by default. Table No.3: -5 to 40°C Table No.4: -5 to 36°C Table No.5: 1 to 40°C Table No.6: 0 to 40°C Table No.7: 0 to 40°C Table No.8: 0 to 40°C
Convertible range of actual temperature used for measurement	The selectable ranges are as shown above.
Compensation formula	<ul style="list-style-type: none"> • Converted to a resistance value at the reference temperature using the formula below and result displayed. • Use the coefficients shown in the "Temperature Conversion Coefficient for Power Cables" (page 169). $R_{tref} = A_t / A_{tref} \times R_t$ <p> A_{tref} : Coefficient at the reference temperature of t_{ref}°C A_t : Coefficient at the actual measurement temperature of t°C R_{tref} : Resistance after compensation for reference temperature of t_{ref}°C R_t : Resistance measured at the temperature of t°C t_{ref} : Reference temperature [°C] t : Actual measurement temperature [°C] (The decimals are rounded in compensation mode.) </p>

Temperature Conversion Coefficient for Power Cables

Coefficient A						
Temperature [°C]	Oil filled insulated cable	Polyvinyl chloride insulated cable		Natural rubber	Natural butadiene styrene	Butyl rubber
		1 to 3 kV	6 kV			
	Table No.3	Table No.4	Table No.5	Table No.6	Table No.7	Table No.8
-5	0.08	0.016	-	-	-	-
-4	0.09	0.019	-	-	-	-
-3	0.10	0.024	-	-	-	-
-2	0.11	0.029	-	-	-	-
-1	0.13	0.032	-	-	-	-
0	0.14	0.042	-	0.38	0.27	0.34
1	0.16	0.048	0.25	0.40	0.28	0.35
2	0.18	0.054	0.26	0.42	0.29	0.38
3	0.20	0.070	0.27	0.44	0.31	0.40
4	0.22	0.077	0.28	0.46	0.33	0.42
5	0.24	0.091	0.29	0.48	0.36	0.44
6	0.26	0.109	0.31	0.51	0.39	0.46
7	0.30	0.124	0.33	0.54	0.42	0.49
8	0.33	0.151	0.36	0.57	0.45	0.52
9	0.37	0.183	0.37	0.60	0.48	0.54
10	0.41	0.211	0.38	0.63	0.51	0.58
11	0.44	0.249	0.41	0.67	0.54	0.61
12	0.49	0.292	0.48	0.71	0.58	0.64
13	0.52	0.340	0.52	0.74	0.62	0.68
14	0.56	0.402	0.58	0.79	0.66	0.72
15	0.61	0.468	0.59	0.82	0.70	0.76
16	0.64	0.547	0.63	0.85	0.75	0.81
17	0.73	0.638	0.74	0.88	0.80	0.85
18	0.82	0.744	0.78	0.92	0.86	0.90

Temperature Conversion Coefficient for Power Cables

Coefficient A						
Temperature [°C]	Oil filled insulated cable	Polyvinyl chloride insulated cable		Natural rubber	Natural butadiene styrene	Butyl rubber
		1 to 3 kV	6 kV			
	Table No.3	Table No.4	Table No.5	Table No.6	Table No.7	Table No.8
19	0.91	0.857	0.85	0.96	0.93	0.96
20	1	1	1	1	1	1
21	1.09	1.17	1.11	1.06	1.11	1.07
22	1.18	1.34	1.20	1.13	1.23	1.14
23	1.26	1.57	1.40	1.20	1.36	1.22
24	1.33	1.81	1.80	1.27	1.51	1.30
25	1.44	2.08	1.90	1.35	1.68	1.38
26	1.55	2.43	2.05	1.44	1.87	1.45
27	1.68	2.79	2.40	1.54	2.08	1.55
28	1.76	3.22	2.70	1.65	2.31	1.65
29	1.92	3.71	3.80	1.77	2.57	1.77
30	2.09	4.27	4.10	1.90	2.86	1.89
31	2.25	4.92	4.45	2.03	3.18	2.00
32	2.42	5.60	5.20	2.17	3.53	2.15
33	2.60	6.45	5.80	2.32	3.91	2.32
34	2.79	7.42	7.60	2.47	4.33	2.50
35	2.95	8.45	8.28	2.65	4.79	2.69
36	3.12	9.70	8.50	2.85	5.29	2.90
37	3.37	-	9.66	3.10	5.83	3.13
38	3.58	-	11.60	3.35	6.44	3.38
39	4.06	-	14.50	3.63	7.18	3.65
40	4.53	-	16.00	3.95	8.23	3.94

Source → Electric wire and cable handbook (China) China Machine Press

Table No.9

Object under test	Rotating machinery
Selectable reference temperature range	20 to 60°C, (Default 40°C)
Convertible range of actual temperature used for measurement	20 to 60°C
Compensation formula	<p>Converted to a resistance value at the reference temperature using the formula below and result displayed.</p> $R_{tref} = 0.5^{(t_{ref} - t)/10} \times R_t$ <p> <i>R</i>_{tref} : Resistance after compensation for reference temperature of t_{ref}°C <i>R</i>_t : Resistance measured at the temperature of t°C t_{ref} : Reference temperature [°C] t : Actual temperature used for measurement [°C] </p>

Source → IEEE Std 43-2000 Recommended Practice for Testing Insulation Resistance of Rotating Machinery (U.S.A.)

Warranty Certificate

HIOKI

Model	Serial No.	Warranty period Three (3) years from date of purchase (___ / ___)
-------	------------	--

This product passed a rigorous inspection process at Hioki before being shipped.

In the unlikely event that you experience an issue during use, please contact the distributor from which you purchased the product, which will be repaired free of charge subject to the provisions of this Warranty Certificate. This warranty is valid for a period of three (3) years from the date of purchase. If the date of purchase is unknown, the warranty is considered valid for a period of three (3) years from the product's date of manufacture. Please present this Warranty Certificate when contacting the distributor. Accuracy is guaranteed for the duration of the separately indicated guaranteed accuracy period.

1. Malfunctions occurring during the warranty period under conditions of normal use in conformity with the Instruction Manual, product labeling (including stamped markings), and other precautionary information will be repaired free of charge, up to the original purchase price. Hioki reserves the right to decline to offer repair, calibration, and other services for reasons that include, but are not limited to, passage of time since the product's manufacture, discontinuation of production of parts, or unforeseen circumstances.
2. Malfunctions that are determined by Hioki to have occurred under one or more of the following conditions are considered to be outside the scope of warranty coverage, even if the event in question occurs during the warranty period:
 - a. Damage to objects under measurement or other secondary or tertiary damage caused by use of the product or its measurement results
 - b. Malfunctions caused by improper handling or use of the product in a manner that does not conform with the provisions of the Instruction Manual
 - c. Malfunctions or damage caused by repair, adjustment, or modification of the product by a company, organization, or individual not approved by Hioki
 - d. Consumption of product parts, including as described in the Instruction Manual
 - e. Malfunctions or damage caused by transport, dropping, or other handling of the product after purchase
 - f. Changes in the product's appearance (scratches on its enclosure, etc.)
 - g. Malfunctions or damage caused by fire, wind or flood damage, earthquakes, lightning, power supply anomalies (including voltage, frequency, etc.), war or civil disturbances, radioactive contamination, or other acts of God
 - h. Damage caused by connecting the product to a network
 - i. Failure to present this Warranty Certificate
 - j. Failure to notify Hioki in advance if used in special embedded applications (space equipment, aviation equipment, nuclear power equipment, life-critical medical equipment or vehicle control equipment, etc.)
 - k. Other malfunctions for which Hioki is not deemed to be responsible

***Requests**

- Hioki is not able to reissue this Warranty Certificate, so please store it carefully.
- Please fill in the model, serial number, and date of purchase on this form.

16-01 EN

HIOKI E.E. CORPORATION

81 Koizumi, Ueda, Nagano 386-1192, Japan
TEL: +81-268-28-0555
FAX: +81-268-28-0559

- Please visit our website at www.hioki.com for the following:
 - Regional contact information
 - The latest revisions of instruction manuals and manuals in other languages.
 - Declarations of Conformity for instruments that comply with CE mark requirements.
- All reasonable care has been taken in the production of this manual, but if you find any points which are unclear or in error, please contact your supplier or the International Sales and Marketing Department at Hioki headquarters.
- In the interests of product development, the contents of this manual are subject to revision without prior notice.
- The content of this manual is protected by copyright.
No reproduction, duplication or modification of the content is permitted without the authorization of Hioki E.E. Corporation.

HIOKI

HEADQUARTERS

81 Koizumi, Ueda, Nagano 386-1192, Japan
TEL +81-268-28-0562 FAX +81-268-28-0568
os-com@hioki.co.jp
(International Sales Department)

www.hioki.com

HIOKI USA CORPORATION

hioki@hiokiusa.com www.hiokiusa.com

HIOKI (Shanghai) Sales & Trading Co.,Ltd.

info@hioki.com.cn www.hioki.cn

HIOKI SINGAPORE PTE. LTD.

info-sg@hioki.com.sg www.hioki.com

HIOKI KOREA CO., LTD.

info-kr@hioki.co.jp www.hiokikorea.com

1604EN