

# **HIOKI**

---

---

Communication Instruction Manual

**IM3523**

**IM3533**

**IM3533-01**

**IM3536**

**LCR METER**

**IM3570**

**IM7580**

**IMPEDANCE ANALYZER**

**IM3590**

**CHEMICAL**

**IMPEDANCE ANALYZER**

**HIOKI E. E. CORPORATION**

November 2014 Revised edition 6 IM3570A983-06 14-11H

---



\*600329706\*



# Contents

Introduction.....	1	3.4 RS-232C Connection and Settings (when connected to the Z3001) .....	26
Safety Information .....	1	■ Connecting the RS-232C Cable .....	26
		■ Setting RS-232C .....	27
<b>Chapter 1 Specifications</b>	<b>3</b>	3.5 LAN Settings and Connection (when connected to the Z3002) .....	29
1.1 RS-232C Specifications .....	3	■ LAN Settings .....	29
1.2 GP-IB Specifications .....	4	■ Connecting a LAN Cable .....	33
1.3 USB Specifications .....	4	3.6 Remote Mode .....	34
1.4 LAN Specifications .....	4		
<b>Chapter 2 Model IM3570/ IM3536 Connection and Setting</b>	<b>5</b>	<b>Chapter 4 Model IM3533/ IM3533-01/ IM3590 Connection and Setting</b>	<b>35</b>
2.1 Overview of Communication .....	5	4.1 Overview of Communication .....	35
2.2 RS-232C Connection and Settings .....	7	4.2 USB Settings and Connection .....	37
■ Connecting the RS-232C Cable .....	7	■ Setting USB .....	37
■ Setting RS-232C .....	8	■ Connecting the USB Cable .....	38
2.3 GP-IB Connection and Settings .....	9	4.3 GP-IB Connection and Settings (when connected to the Z3000) .....	39
■ Connecting the GP-IB Cable .....	9	■ Connecting the GP-IB Cable .....	39
■ Setting GP-IB .....	9	■ Setting GP-IB .....	39
2.4 USB Settings and Connection .....	11	4.4 RS-232C Connection and Settings (when connected to the Z3001) .....	41
■ Setting USB .....	11	■ Connecting the RS-232C Cable .....	41
■ Connecting the USB Cable .....	12	■ Setting RS-232C .....	42
2.5 LAN Settings and Connection .....	13	4.5 LAN Settings and Connection (when connected to the Z3002) .....	43
■ LAN Settings .....	13	■ LAN Settings .....	43
■ Connecting a LAN Cable .....	18	■ Connecting a LAN Cable .....	48
2.6 Remote Mode .....	19	4.6 Remote Mode .....	49
<b>Chapter 3 Model IM3523 Connection and Setting</b>	<b>21</b>		
3.1 Overview of Communication .....	21	<b>Chapter 5 Model IM7580 Connection and Setting</b>	<b>51</b>
3.2 USB Settings and Connection .....	22	5.1 Overview of Communication .....	51
■ Setting USB .....	22	5.2 USB Settings and Connection .....	53
■ Connecting the USB Cable .....	23	■ Setting USB .....	53
3.3 GP-IB Connection and Settings (when connected to the Z3000) .....	24	■ Connecting the USB Cable .....	54
■ Connecting the GP-IB Cable .....	24	5.3 LAN Settings and Connection .....	55
■ Setting GP-IB .....	24	■ LAN Settings .....	55
		■ Connecting a LAN Cable .....	60

**Contents**

---

---

5.4 GP-IB Connection and Settings  
(when connected to the Z3000) .....61

- Connecting the GP-IB Cable ..... 61
- Setting GP-IB ..... 61

5.5 RS-232C Connection and Settings  
(when connected to the Z3001) .....63

- Connecting the RS-232C Cable ..... 63
- Setting RS-232C ..... 64

5.6 Remote Mode .....65

---

**Appendix** **A 1**

Appendix 1 Checking the USB Virtual  
COM Port ..... A 1

## Introduction



This instruction manual provides details on the communication interfaces of the IM3523, IM3533, IM3533-01, IM3536 LCR Meter, IM3570, IM7580 Impedance Analyzer and IM3590 Chemical Impedance Analyzer. In this document, the "instrument" means the IM3523, IM3533, IM3533-01, IM3536, IM3570, IM7580 and IM3590.

## Safety Information

This manual contains information and warnings essential for safe operation of the instrument and for maintaining it in safe operating condition. Before using it, be sure to carefully read the following safety precautions.

### Safety Symbols

The following symbols in this manual indicate the relative importance of cautions and warnings.

 <b>WARNING</b>	Indicates that incorrect operation presents a significant hazard that could result in serious injury or death to the user.
 <b>CAUTION</b>	Indicates that incorrect operation presents a possibility of injury to the user or damage to the product.
<b>NOTE</b>	Advisory items related to performance or correct operation of the product.

### Notation

#### Symbols in this manual

	Indicates the prohibited action.
(p. )	Indicates the location of reference information.
*	Indicates that descriptive information is provided below.
[ ]	Menus, commands, dialogs, buttons in a dialog, and other names on the screen and the keys are indicated in brackets.
<b>CURS</b> (Bold character)	Bold characters within the text indicate operating key labels.
<b>Windows</b>	Unless otherwise specified, "Windows" represents Windows Vista, Windows 7 or Windows 8.
<b>Dialogue</b>	Dialogue box represents a Windows dialog box.

#### Mouse Operation

Click:	Press and quickly release the left button of the mouse.
Right-click:	Press and quickly release the right button of the mouse.
Double click:	Quickly click the left button of the mouse twice.
Drag:	While holding down the left button of the mouse, move the mouse and then release the left button to deposit the chosen item in the desired position.



# Specifications

# Chapter 1

## 1.1 RS-232C Specifications

Transmission Method	Communication method: Full duplex Synchronous method: Start-stop synchronization	
Transmission Speed	9600 bps, 19200 bps, 38400 bps, 57600 bps	
Data Bits	8 bits	
Parity	None	
Stop bit	1 bits	
Message terminator (delimiter)	CR+LF, CR	
Flow control	Hardware (RTS/CTS control), software (XON/XOFF control) "Handshake (About Buffer Flow Control)" (p. 3) IM7580: Software (XON/XOFF control only)	
Electrical Specifications	Input voltage level	5 to 15 V ..... ON -15 to -5 V ..... OFF
	Output voltage level	5 to 9 V ..... ON -9 to -5 V ..... OFF

### Handshake (About Buffer Flow Control)

#### Control during Receiving

##### When using hardware (RTS/CTS control):

- When the data in the receive buffer exceeds 85% of the buffer, CA(RTS) is set to OFF and the controller is notified that there is not much space remaining in the buffer.
- Processing of the data in the buffer continues, and then CA(RTS) is set to ON and the controller is notified that there is sufficient remaining space in the buffer when the amount of data becomes less than 25%.

##### When using software (XON/XOFF control):

- When the data in the receive buffer exceeds 75% of the buffer, XOFF(13H) is sent and the controller is notified that there is not much space remaining in the buffer.
- Processing of the data in the buffer continues, and then XON(11H) is sent and the controller is notified that there is sufficient remaining space in the buffer when the amount of data becomes less than 25%.

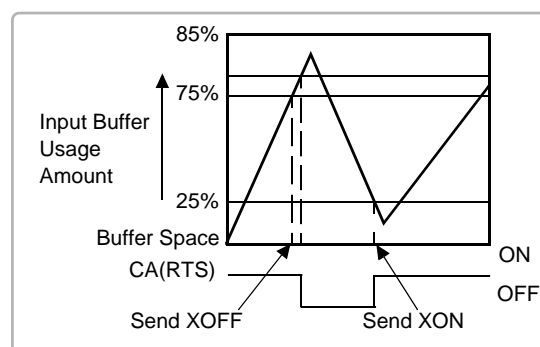

#### Control during Sending

##### When using hardware (RTS/CTS control):

- When CB(CTS) is confirmed to be OFF, the sending of data is halted. When it is confirmed to be ON, the sending of data is resumed.

##### When using software (XON/XOFF control):

- When XOFF is received, the sending of data is halted. When XON is received, the sending of data is resumed.

## 1.2 GP-IB Specifications

SH1	Supports all source handshake functions.
AH1	Supports all acceptor handshake functions.
T6	Supports standard talker functions. Supports serial poll functions. Talk only mode is not supported. Supports the talker cancel function by MLA (My Listen Address).
L4	Supports standard listener functions. Listener only mode is not supported. Supports the listener cancel function by MTA (My Talk Address).
SR1	Supports all service request functions.
RL1	Supports all remote/local functions.
PP0	Parallel poll functions are not supported.
DC1	Supports all device clear functions.
DT1	Supports all device trigger functions.
C0	Controller functions are not supported.

Code used: ASCII code

## 1.3 USB Specifications

Connector	Series B receptacle
Compliance standard	USB2.0 (Full Speed/High Speed)
No. of ports	1
Class	Communication class
Supported OS	Windows Vista, 7 , 8

## 1.4 LAN Specifications

Connector	RJ-45 connector × 1
Compliance standard	IEEE 802.3-compliant Ethernet
Transfer system	10BASE-T/ 100BASE-TX Auto detected IM7580: 10BASE-T/ 100BASE-TX/ 1000BASE-T Auto detected
Protocol	TCP/IP
Function	Command control



# Model IM3570/ IM3536 Connection and Setting

## Chapter 2

### 2.1 Overview of Communication

You can control the instrument with communication commands from a computer via the GP-IB, RS-232C, USB, and LAN interfaces.

There are the following four communication methods. To enable communication, the communication conditions need to be set on the instrument.

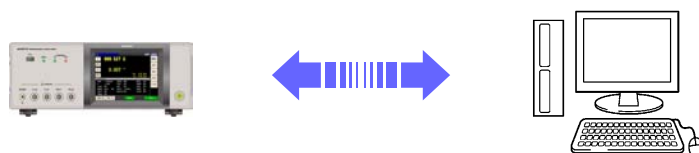

#### RS-232C communication (p. 7)

Printer can be connected to enable printing measurement values and screens.

#### GP-IB communication (p. 9)

- Commands common to IEEE-488-2 1987 (requirement) can be used.
- The instrument complies with the following standard. (Compliance standard: IEEE-488.1 1987)
- The instrument has been designed with reference to the following standard. (Reference standard: IEEE-488.2 1987)

#### USB communication (p. 11)

The instrument is communication class compatible.

#### LAN communication (p. 13)

Command control using the TCP/IP protocol is possible.

#### **! WARNING**

- Always turn both devices OFF when connecting and disconnecting an interface connector. Otherwise, an electric shock accident may occur.
- To avoid damage to the instrument, do not short-circuit the terminal and do not input voltage to the terminal.
- Failure to fasten the connectors properly may result in sub-specification performance or damage to the equipment.

### Screen Displayed while Setting Interfaces

When you set an interface, the icon for the set interface is displayed on the right side of the screen.

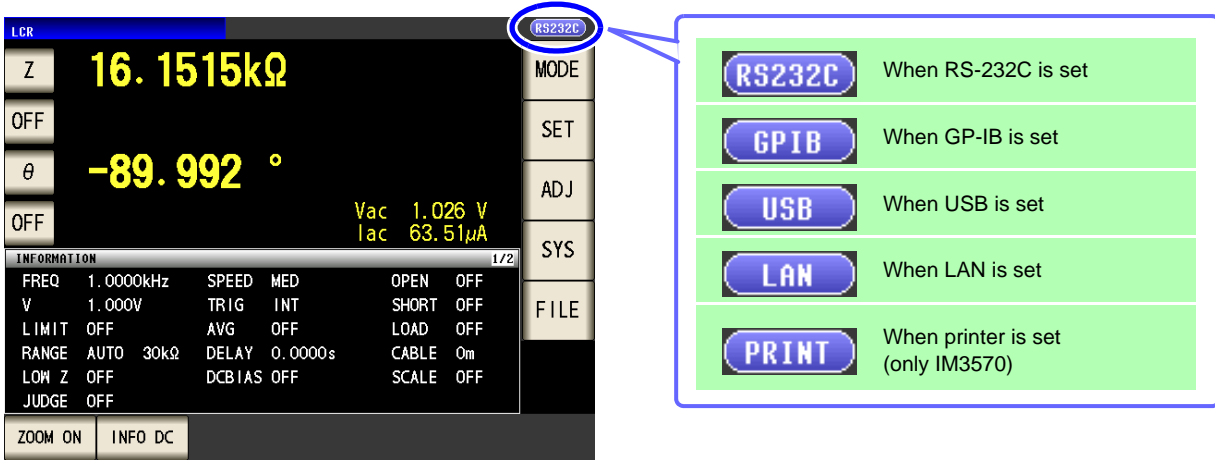

## 2.2 RS-232C Connection and Settings

### Connecting the RS-232C Cable

Connect the RS-232C cable to the RS-232C connector.  
(Recommended cable: 9637 RS-232C cable)

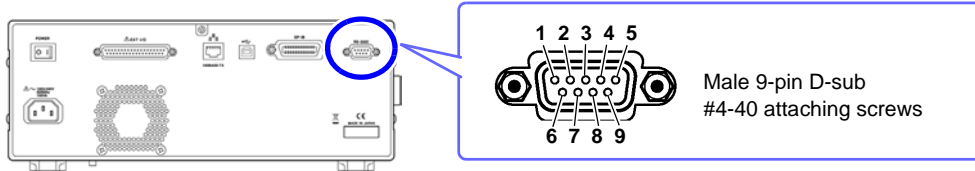

To connect the instrument to a controller (DTE), use a **crossover cable** compatible with the connectors on both the instrument and the controller. The I/O connector is a DTE (Data Terminal Equipment) configuration.

Connector (D-sub) Pin No.	Interchange Circuit Name	CCITT Circuit No.	EIA Abbreviation	JIS Abbreviation	Common Abbreviation
1	Unused				
2	Received Data	104	BB	RD	RxD
3	Transmitted Data	103	BA	SD	TxD
4	Data Terminal Ready	108/2	CD	ER	DTR
5	Signal Ground	102	AB	SG	GND
6	Unused				
7	Request to Send	105	CA	RS	RTS
8	Clear to Send	106	CB	CS	CTS
9	Unused				

#### Example: Connecting to a DOS/V PC

Specification: D-sub 9-pin female and female connector, reverse connection

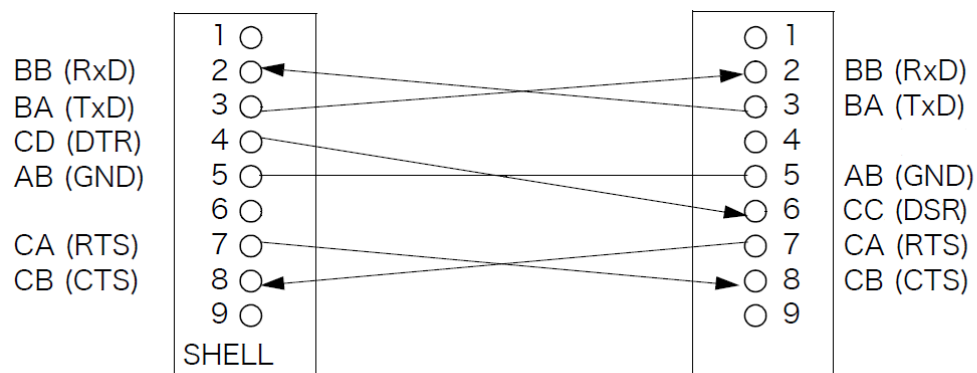

**NOTE** Hardware control will not work properly if you use a cable that has CA(RTS) and CB(CTS) short-circuited.

Setting RS-232C

Procedure

You can configure the setting from any of **LCR** mode, **ANALYZER** mode (only IM3570).

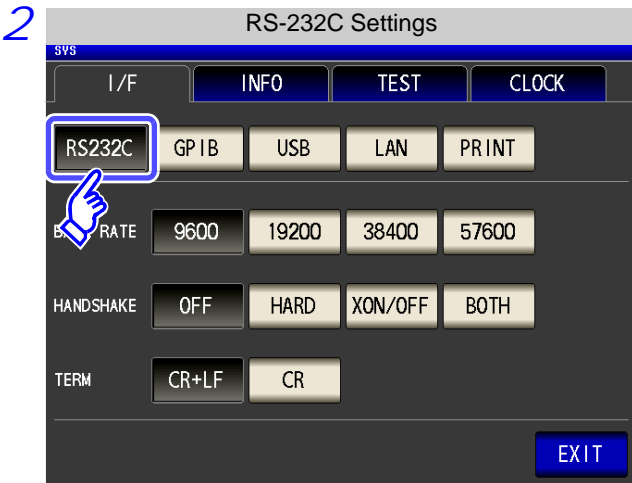
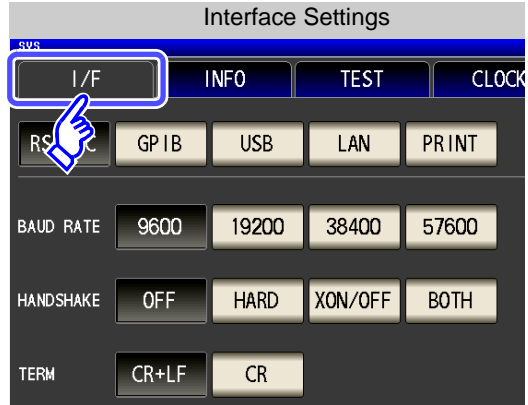
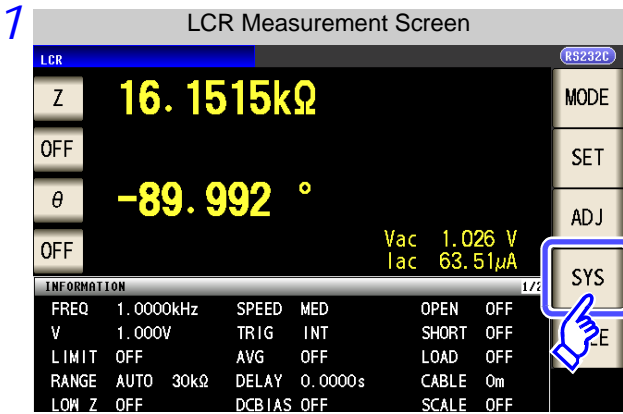

Press **RS232C**.

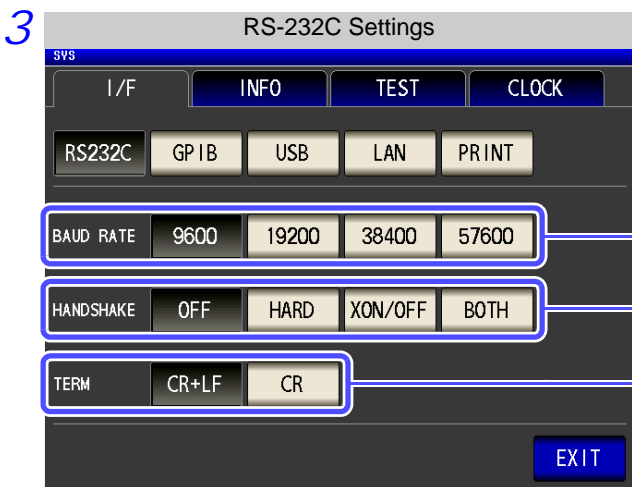

Select the baud rate setting.

Select the handshake setting.

- No flow control
- Hardware (RTS/CTS control)
- Software (XON/XOFF control)
- Hardware + software

Select the terminator setting.

- CR+LF
- CR

4 Press **EXIT** to confirm the setting.

## 2.3 GP-IB Connection and Settings

### Connecting the GP-IB Cable

Connect the GP-IB cable to the GP-IB connector.

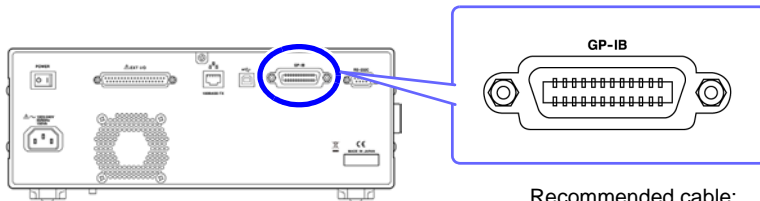

Recommended cable:  
9150-02 GP-IB connection cable (2 m)

### Setting GP-IB

**Procedure**

You can configure the setting from any of **LCR** mode, **ANALYZER** mode (only IM3570).

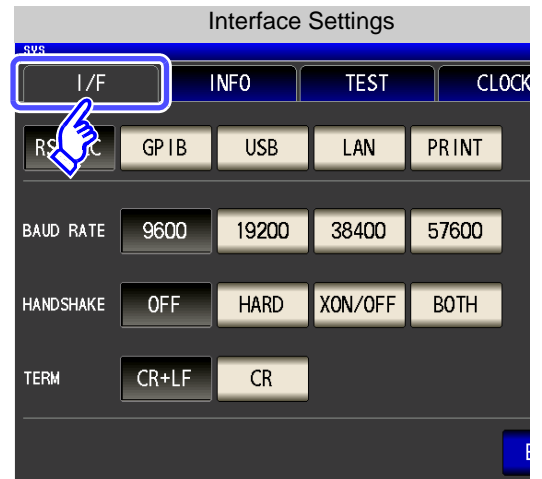
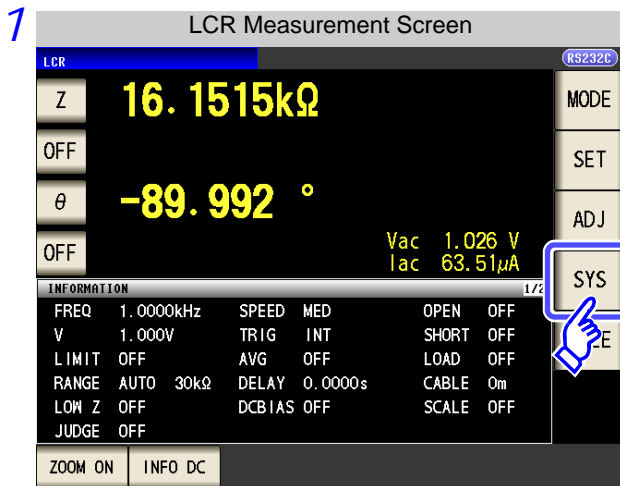

# 10

## 2.3 GP-IB Connection and Settings

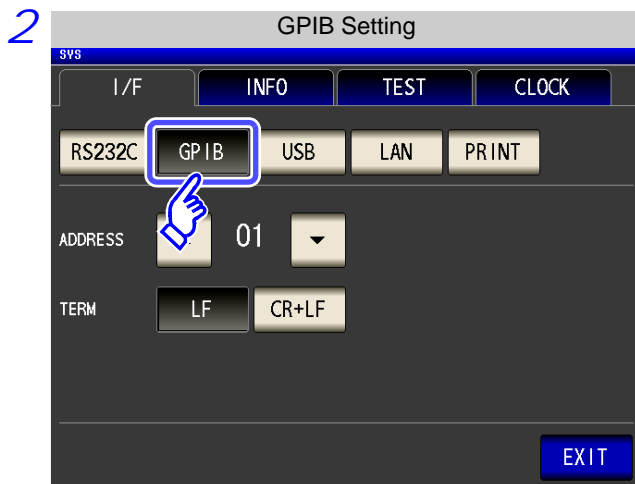

Press .

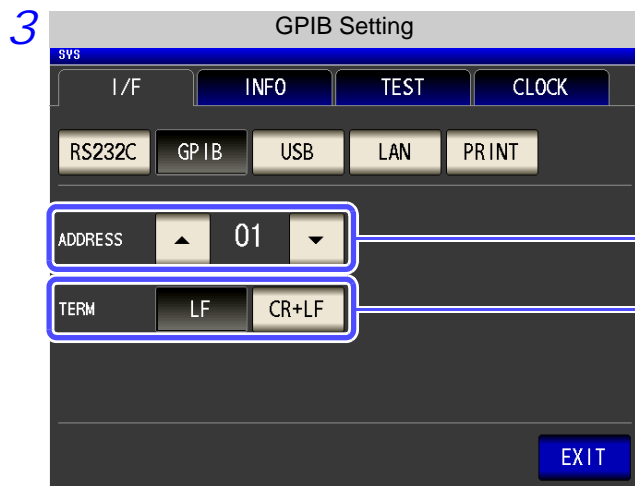

Use or to set the GP-IB address.

Select the terminator setting.

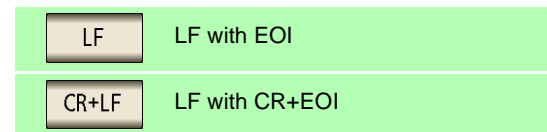

4 Press to confirm the setting.

## 2.4 USB Settings and Connection

**NOTE** To connect the instrument to a computer the first time, a dedicated USB driver must be installed. Before connecting the instrument to the computer, install the USB driver. The USB driver can be downloaded from the bundled CD, or our web site. (<http://www.hioki.com>) The USB driver is compatible with the Windows Vista (32-bit, 64-bit version), Windows 7 (32-bit, 64-bit version), and Windows 8 (32-bit, 64-bit version) operating systems. Additionally, do not put the computer into the sleep state while the instrument is connected to the computer.

### Setting USB

**Procedure**

You can configure the setting from any of **LCR** mode, **ANALYZER** mode (only IM3570).

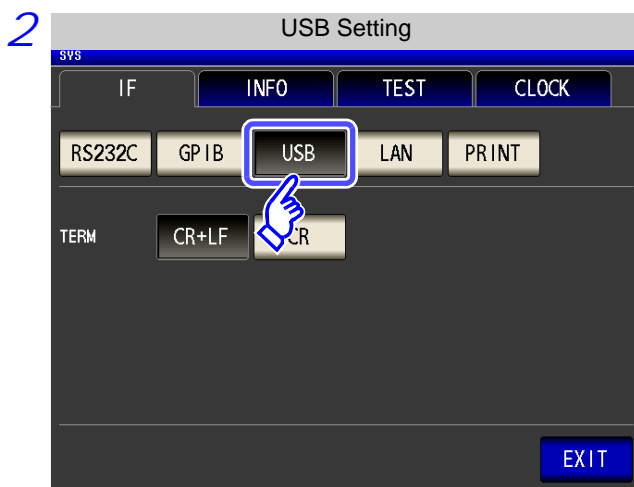
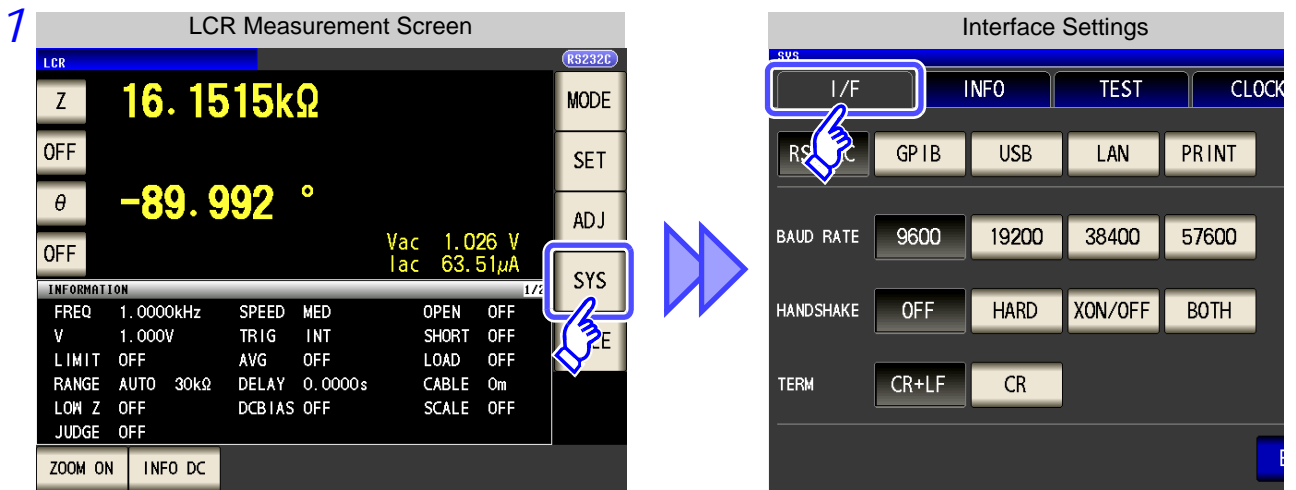

Press **USB**.

# 12

## 2.4 USB Settings and Connection

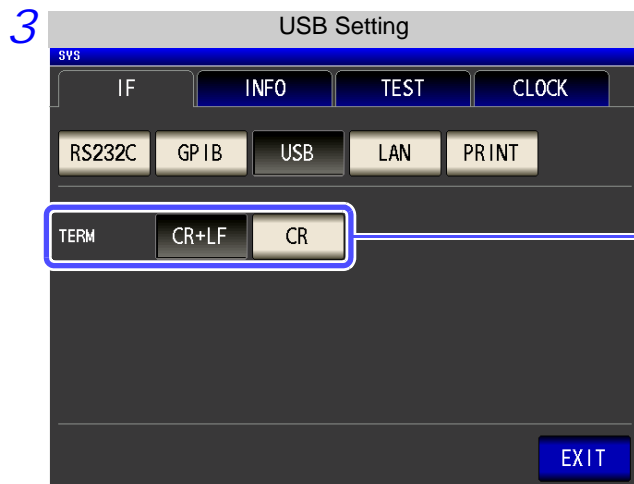

Select the terminator setting.

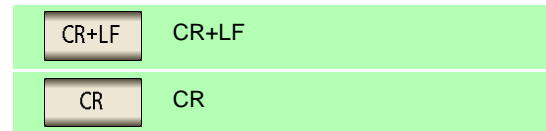

4 Press **EXIT** to confirm the setting.

### Connecting the USB Cable

Connect a USB cable (commercially available USB cable) to the USB port of the instrument.

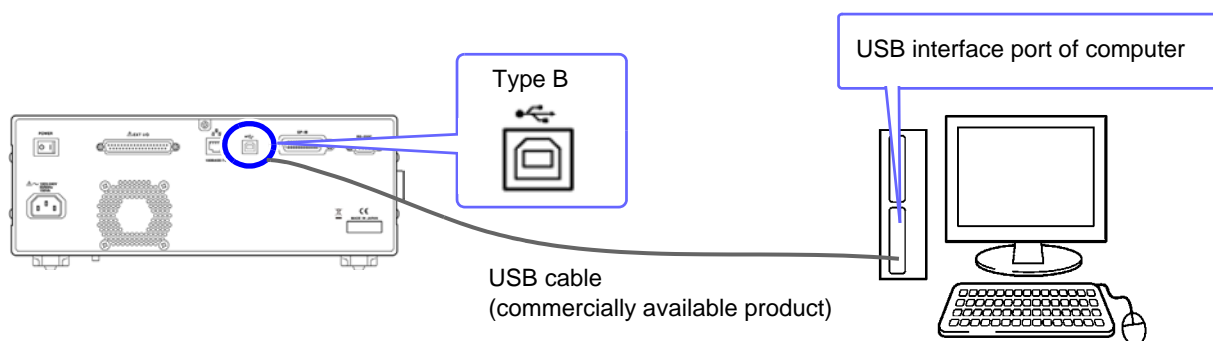

### **CAUTION**

- To avoid faults, do not disconnect or reconnect the USB cable during instrument operation.
- Connect the instrument and the computer to a common earth ground. Using different grounds could result in potential difference between the instrument and the computer. Potential difference on the USB cable can result in malfunctions and faults.



## 2.5 LAN Settings and Connection

### LAN Settings

You can perform command control using the TCP/IP protocol.  
Set the instrument to match your network environment in advance.

- NOTE**
- Make these settings before connecting to a network. Changing settings while connected can duplicate IP addresses of other network devices, and incorrect address information may otherwise be presented to the network.
  - The instrument does not support DHCP (automatic IP address assignment) on a network.

### Setting Items

IP address	Identifies each device connected on a network. Each network device must be set to a unique address. The instrument supports IP version 4, with IP addresses indicated as four decimal octets, e.g., "192.168.0.1".
Subnet mask	This setting is for separating the IP address into the network address that indicates the network and the host address that indicates the instrument. On this instrument, the subnet mask is represented as four decimal numbers separated by "." such as "255.255.255.0."
Default Gateway	When the computer and instrument are on different but overlapping networks (subnets), this IP address specifies the device to serve as the gateway between the networks. If the computer and instrument are connected one-to-one, no gateway is used, and the instrument's default setting "0.0.0.0" can be kept as is.

### Network Environment Configuration

#### Example 1. Connecting the instrument to an existing network

When connecting the instrument to an existing network, the network settings need to be confirmed in advance.

An IP address which is not the same as that of another network device needs to be assigned.  
Confirm the following items with the network administrator, and write them down.

IP Address	_____ . _____ . _____ . _____
Subnet Mask	_____ . _____ . _____ . _____
Default Gateway	_____ . _____ . _____ . _____

#### Example 2. Connecting multiple instruments to a single computer using a hub

When building a local network with no outside connection, the following private IP addresses are recommended.

Example of private IP address:

IP Address ..... Computer: 192.168.0.100

Instrument: 192.168.0.1, 192.168.0.2, 192.168.0.3...

(Set an IP address that differs from that of other network devices.)

Subnet Mask ..... 255.255.255.0

Default Gateway ..... OFF(0.0.0.0)

#### Example 3. Connecting one instrument to a single computer using the 9642 LAN Cable

The 9642 LAN Cable can be used with its supplied connection adapter to connect one instrument to one computer, in which case the IP address is freely settable. Use the recommended private IP addresses.

IP Address ..... Computer: 192.168.0.100

Instrument: 192.168.0.1 (Set to a different IP address than the computer.)

Subnet Mask ..... 255.255.255.0

Default Gateway ..... OFF(0.0.0.0)

## 2.5 LAN Settings and Connection

### Procedure

You can configure the setting from any of **LCR** mode, **ANALYZER** mode (only IM3570).

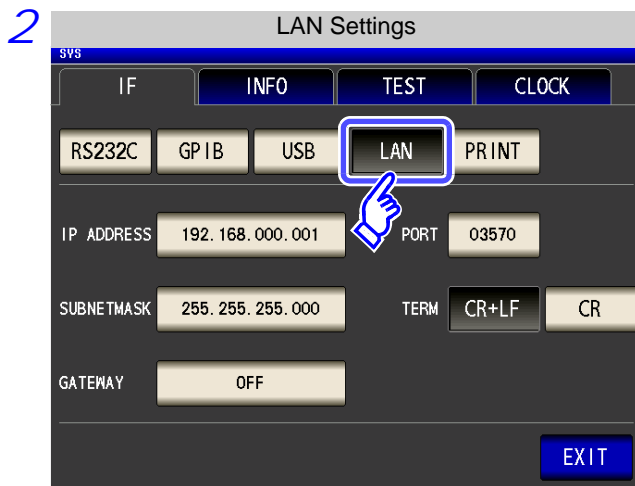
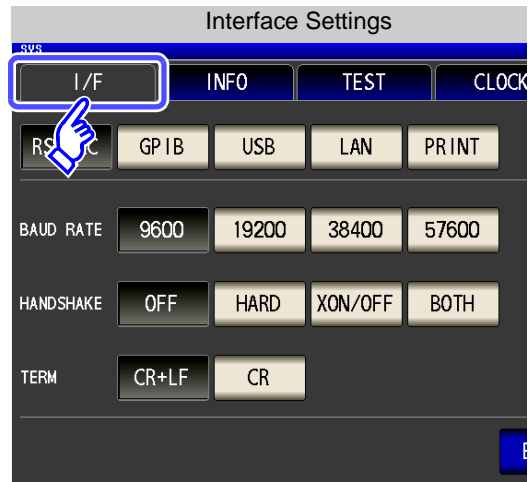
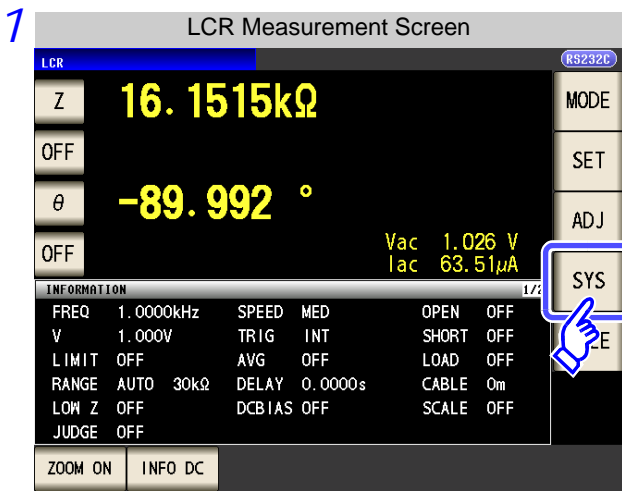

Press **LAN**.

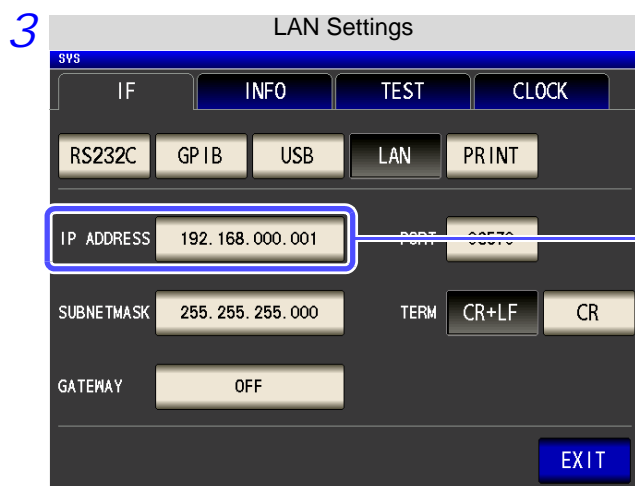

Select the IP address.

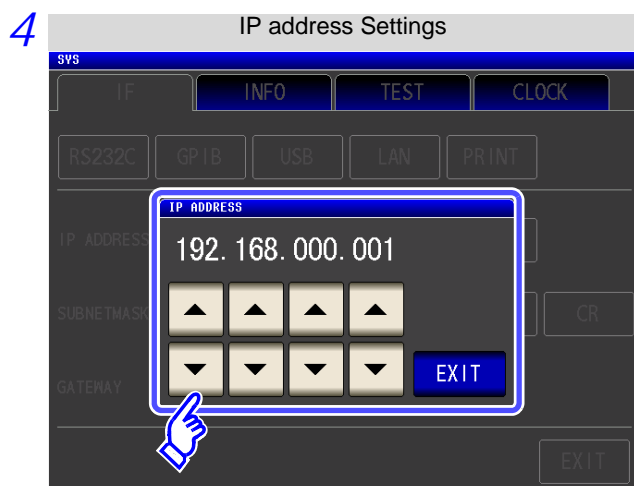

Use or to set the IP address.

Press to confirm the setting.

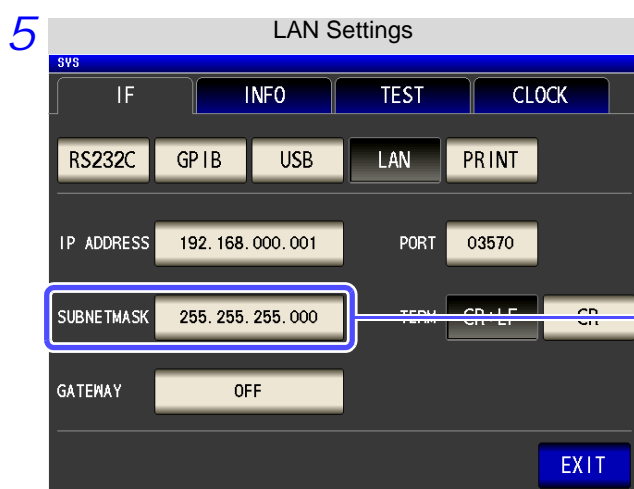

Select the subnet mask.

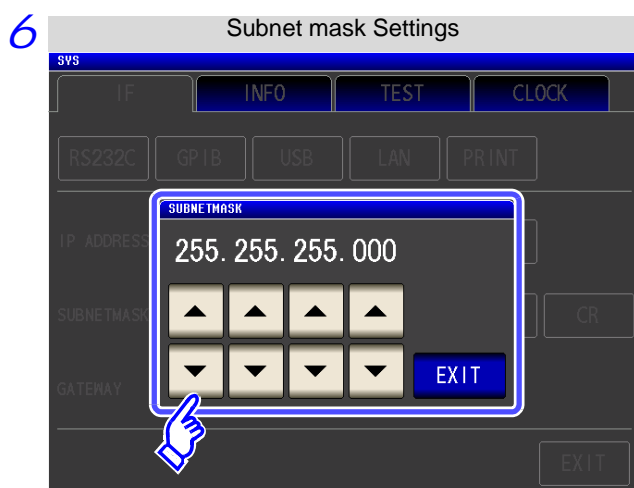

Use or to set the subnet mask, and press to confirm the setting.

**NOTE** Any of the following 30 subnet masks can be set for the instrument.

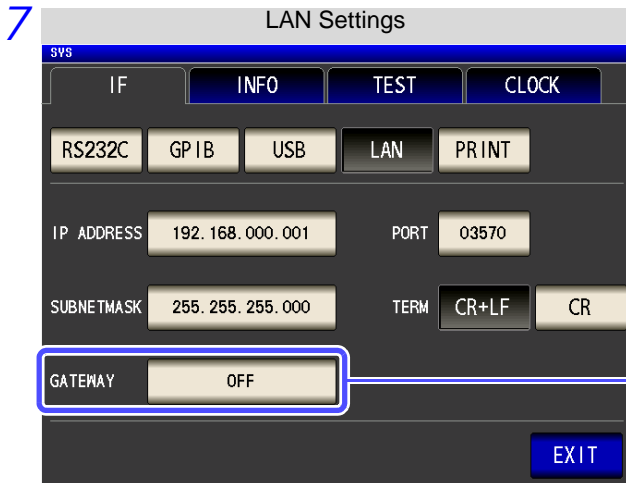

128.000.000.000	255.128.000.000	255.255.128.000	255.255.255.128
192.000.000.000	255.192.000.000	255.255.192.000	255.255.255.192
224.000.000.000	255.224.000.000	255.255.224.000	255.255.255.224
240.000.000.000	255.240.000.000	255.255.240.000	255.255.255.240
248.000.000.000	255.248.000.000	255.255.248.000	255.255.255.248
252.000.000.000	255.252.000.000	255.255.252.000	255.255.255.252
254.000.000.000	255.254.000.000	255.255.254.000	
255.000.000.000	255.255.000.000	255.255.255.000 (Initial setting)	

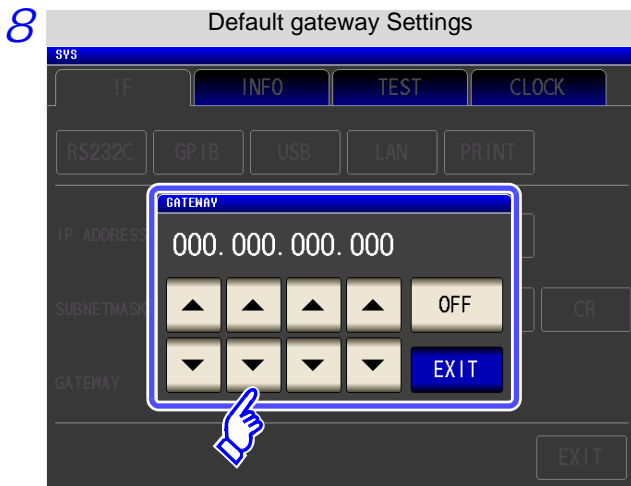

Select the default gateway.

If the default gateway does not need to be set, for example, when connecting the instrument and computer on a one-to-one basis using a cross cable, leave this set to OFF.



Use  or  to set the default gateway.

Press  to confirm the setting.

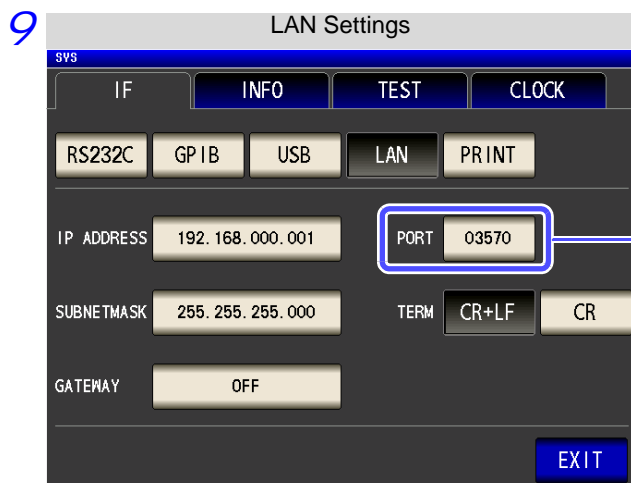

Select the port number.

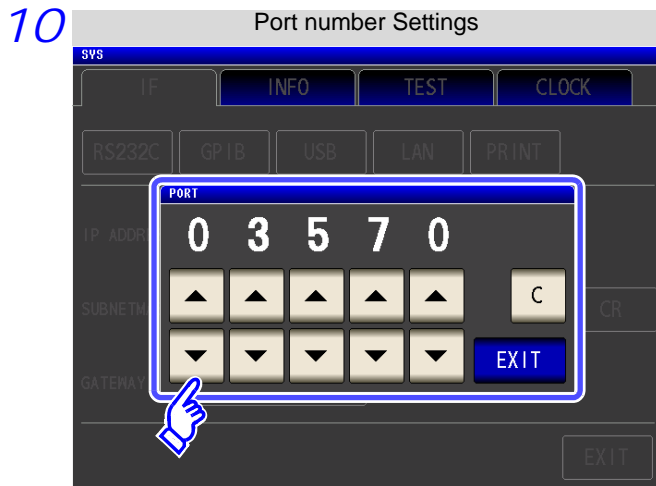

Use or to set the port number to use for communication commands.

Settable range : 1024 to 65535

Press to confirm the setting.

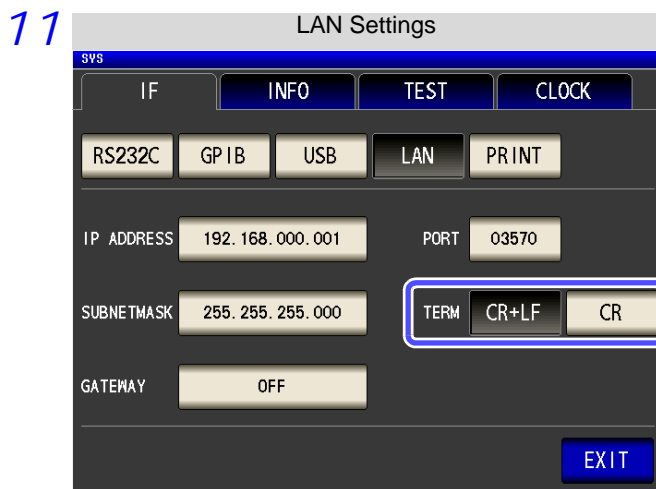

Select the terminator setting.

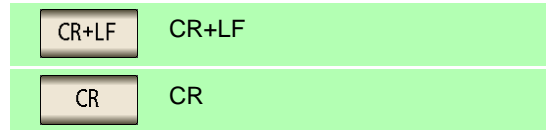

12 Press to confirm the setting.

### Connecting a LAN Cable

Use a LAN cable to connect the instrument and computer.

#### Required items:

When connecting the instrument to an existing network (prepare any of the following):

- Straight-through Cat 5, 100BASE-TX-compliant Ethernet cable (up to 100 m, commercially available).  
For 10BASE communication, a 10BASE-T-compliant cable may also be used.
- Hioki 9642 LAN Cable (option)  
(A cross adapter cannot be used.)

When connecting one instrument to a single computer (prepare one of the following):

- 100BASE-TX-compliant cross-over cable (up to 100 m)
- 100BASE-TX-compliant straight-through cable with cross-over adapter (up to 100 m)
- Hioki 9642 LAN Cable (option)

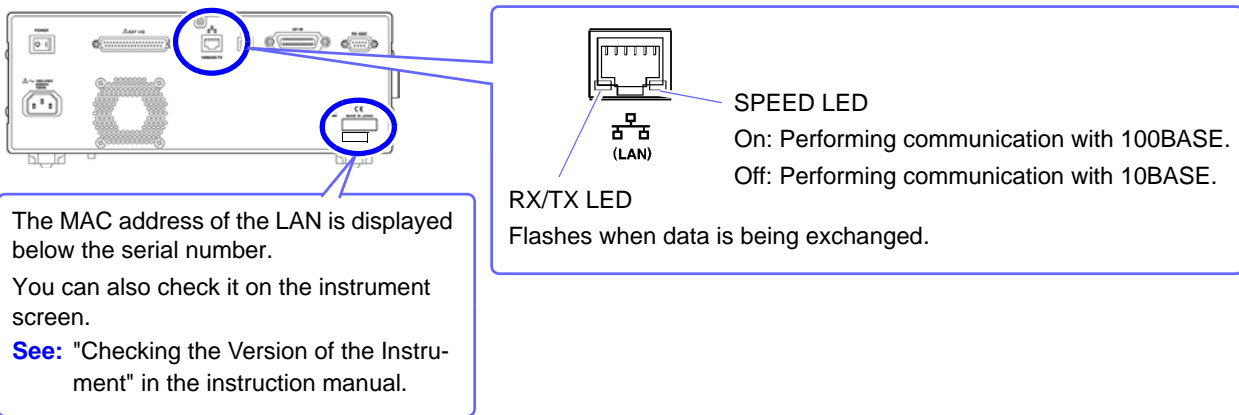

#### When connecting the instrument to a single computer (connect the instrument to the computer)

Connecting with the 9642 LAN Cable and crossover adapter (supplied with the 9642)

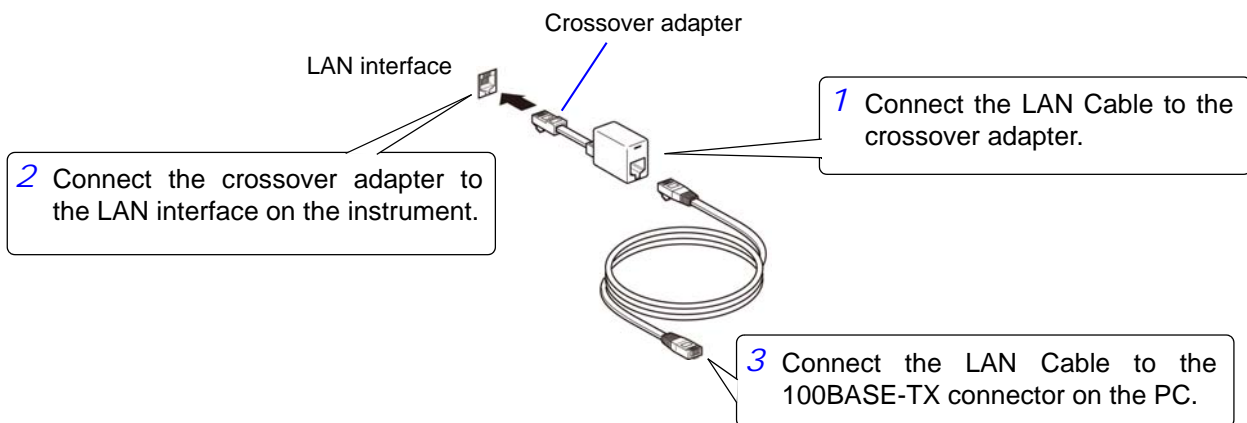

## 2.6 Remote Mode

When you connect a device to an interface and start communication, the mode becomes remote mode (remote operation state) and the keys on the LCD are disabled.

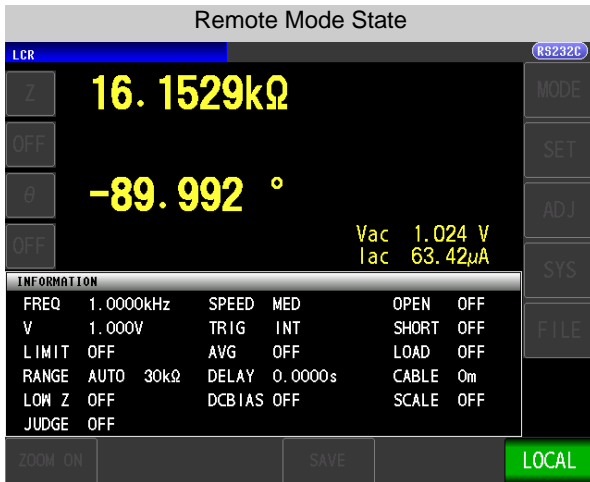

All of the keys except LOCAL are disabled.

### Canceling Remote Mode

#### Procedure

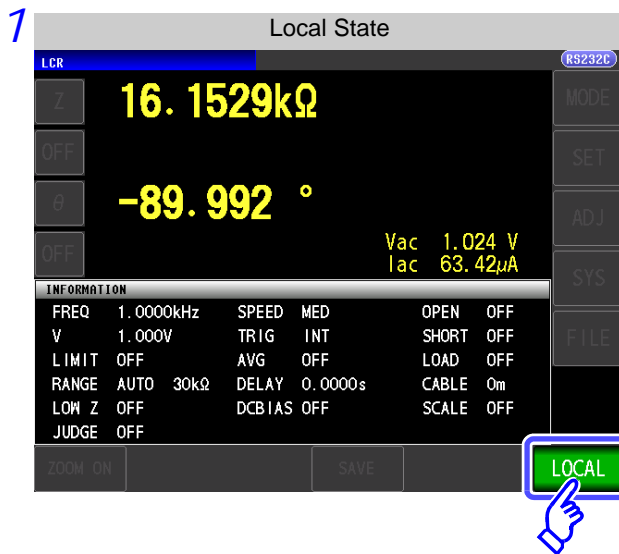

Press LOCAL to return to the normal state (local state).

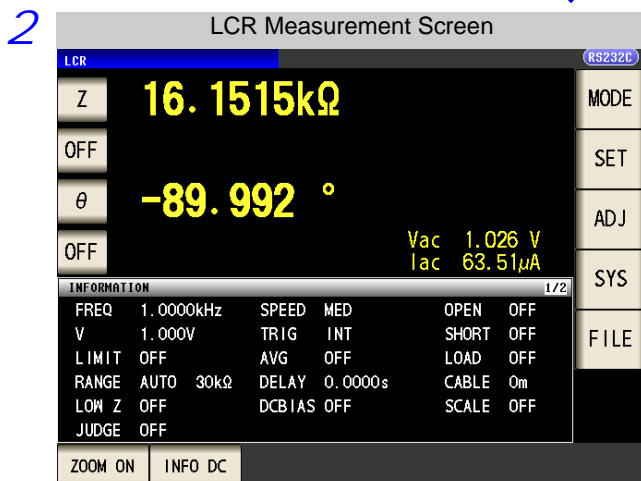

The measurement screen is redisplayed.





# Model IM3523 Connection and Setting

## Chapter 3

### 3.1 Overview of Communication

You can control the instrument with communication commands from a computer via the USB, GP-IB, RS-232C and LAN interfaces.

There are the following four communication methods. To enable communication, the communication conditions need to be set on the instrument.

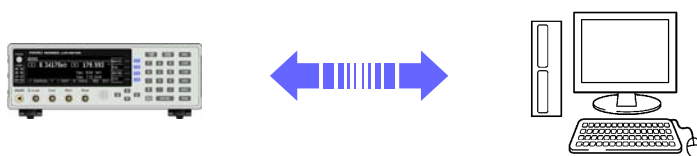

#### USB communication (p. 22)

The instrument is communication class compatible.

#### GP-IB communication (when connected to the Z3000) (p. 24)

- Commands common to IEEE-488-2 1987 (requirement) can be used.
- The instrument complies with the following standard. (Compliance standard: IEEE-488.1 1987)
- The instrument has been designed with reference to the following standard. (Reference standard: IEEE-488.2 1987)

#### RS-232C communication (when connected to the Z3001) (p. 26)

Printer can be connected to enable printing measurement values and screens.

#### LAN communication (when connected to the Z3002) (p. 29)

Command control using the TCP/IP protocol is possible.

#### **! WARNING**

- Always turn both devices OFF when connecting and disconnecting an interface connector. Otherwise, an electric shock accident may occur.
- To avoid damage to the instrument, do not short-circuit the terminal and do not input voltage to the terminal.
- Failure to fasten the connectors properly may result in sub-specification performance or damage to the equipment.

# 3.2 USB Settings and Connection

**NOTE** To connect the instrument to a computer the first time, a dedicated USB driver must be installed. Before connecting the instrument to the computer, install the USB driver. The USB driver can be downloaded from the bundled CD, or our web site. (<http://www.hioki.com>) The USB driver is compatible with the Windows XP (32-bit version), Windows Vista (32-bit, 64-bit version), and Windows 7 (32-bit, 64-bit version) operating systems. Additionally, do not put the computer into the sleep state while the instrument is connected to the computer.

## Setting USB

**1** Open the SYSTEM screen.

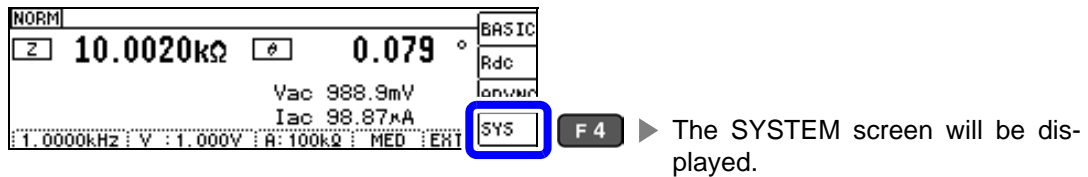

**2** Select USB as the interface. The display will vary with the installed options.

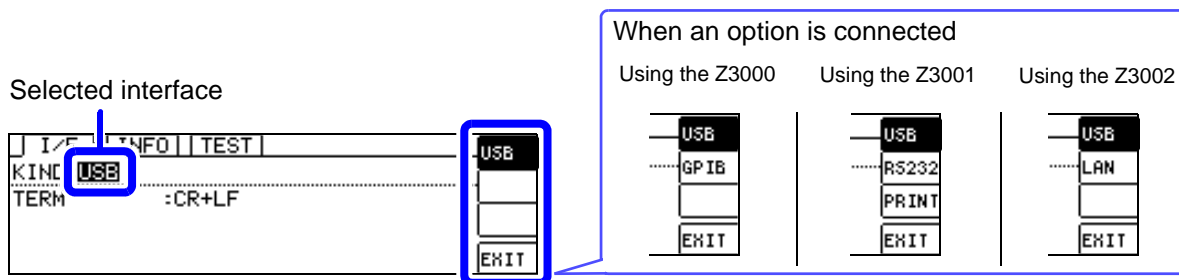

**3** Select the terminator setting.

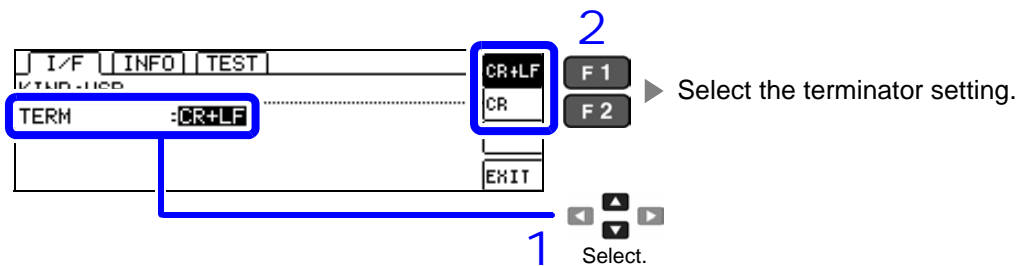

**4** You will return to the measurement screen.

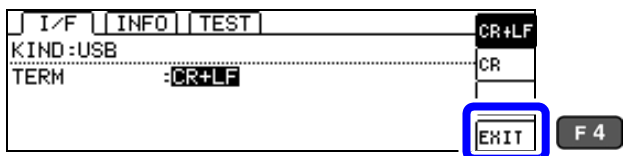

## Connecting the USB Cable

Connect a USB cable (commercially available USB cable) to the USB port of the instrument.

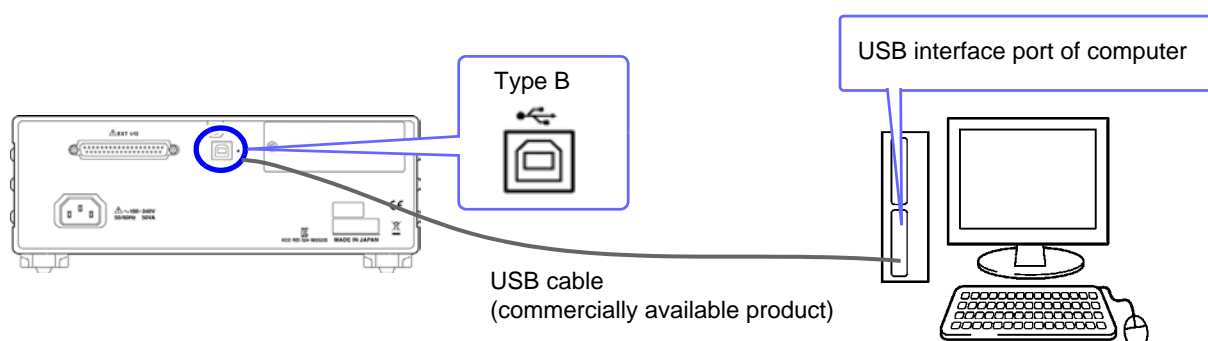

### **CAUTION**

- To avoid faults, do not disconnect or reconnect the USB cable during instrument operation.
- Connect the instrument and the computer to a common earth ground. Using different grounds could result in potential difference between the instrument and the computer. Potential difference on the USB cable can result in malfunctions and faults.

# 3.3 GP-IB Connection and Settings (when connected to the Z3000)

## Connecting the GP-IB Cable

Connect the GP-IB cable to the GP-IB connector.

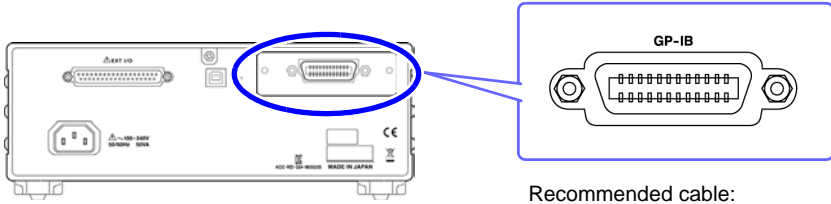

Recommended cable:  
9150-02 GP-IB connection cable (2 m)

## Setting GP-IB

1 Open the SYSTEM screen.

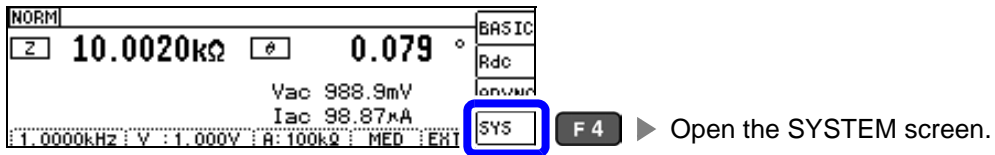

2 Select GP-IB as the interface.

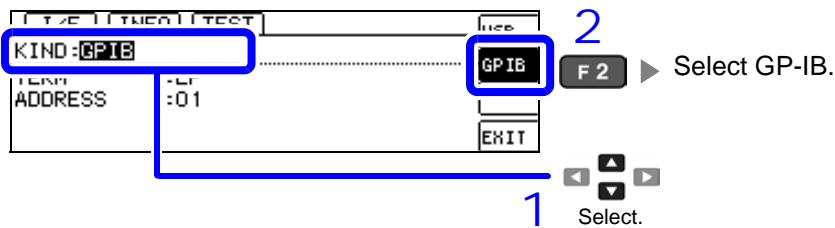

**3** Select the terminator setting.

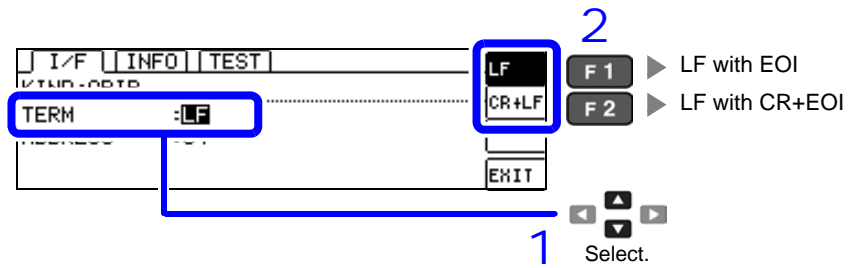

**4** Set the GP-IB address.  
Valid setting range: 0 to 30

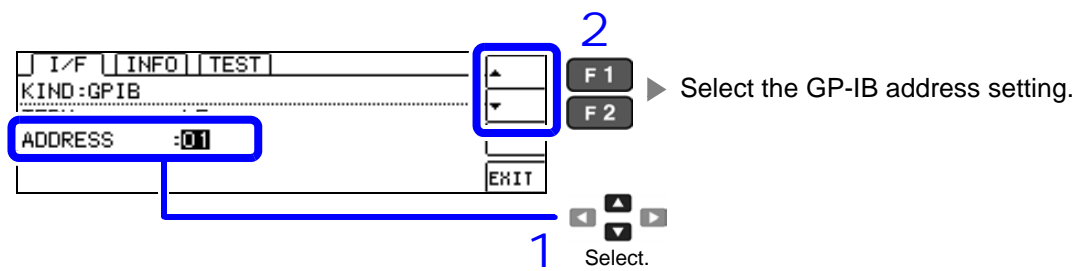

**5**

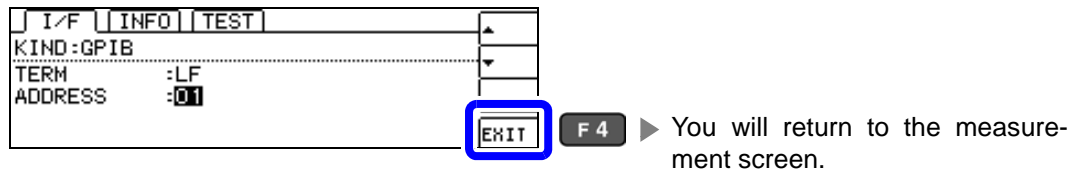

# 3.4 RS-232C Connection and Settings (when connected to the Z3001)

## Connecting the RS-232C Cable

Connect the RS-232C cable to the RS-232C connector.  
(Recommended cable: 9637 RS-232C cable)

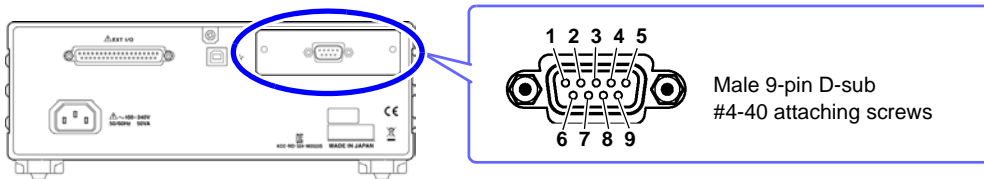

To connect the instrument to a controller (DTE), use a **crossover cable** compatible with the connectors on both the instrument and the controller. The I/O connector is a DTE (Data Terminal Equipment) configuration.

Connector (D-sub) Pin No.	Interchange Circuit Name	CCITT Circuit No.	EIA Abbreviation	JIS Abbreviation	Common Abbreviation
1	Unused				
2	Received Data	104	BB	RD	RxD
3	Transmitted Data	103	BA	SD	TxD
4	Data Terminal Ready	108/2	CD	ER	DTR
5	Signal Ground	102	AB	SG	GND
6	Unused				
7	Request to Send	105	CA	RS	RTS
8	Clear to Send	106	CB	CS	CTS
9	Unused				

### Example: Connecting to a DOS/PC

Specification: D-sub 9-pin female and female connector, reverse connection

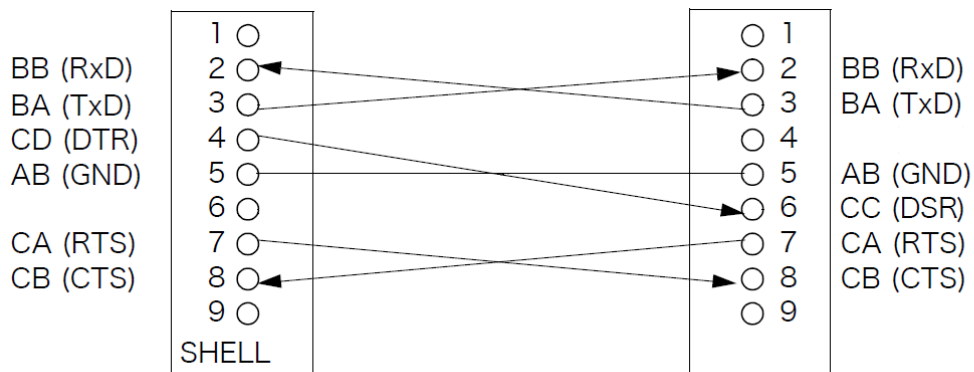

**NOTE** Hardware control will not work properly if you use a cable that has CA(RTS) and CB(CTS) short-circuited.

Setting RS-232C

1 Open the SYSTEM screen.

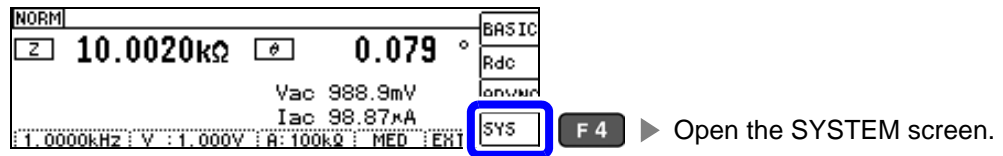

2 Select RS-232C as the interface.

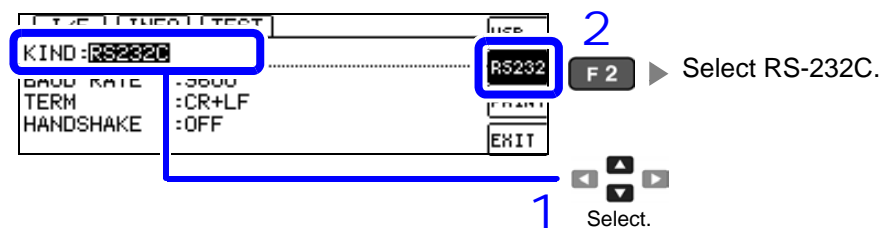

3 Select from the following baud rate setting.  
9600, 19200, 38400, 57600

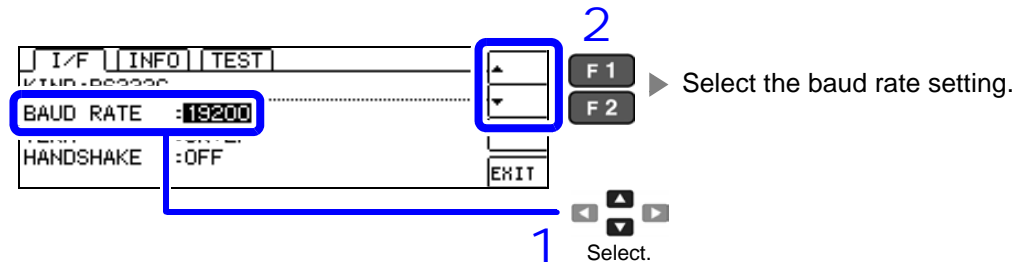

4 Select the terminator setting.

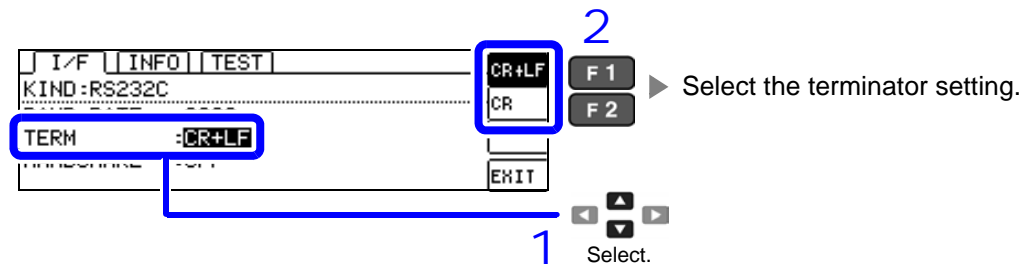

### 5 Select the handshake setting.

1 Select.

2 Select the handshake setting.

OFF	No flow control
HARD	Hardware (RTS/CTS control)
XON/OFF	Software (XON/XOFF control)
BOTH	Hardware + software

### 6

1 You will return to the measurement screen.



## 3.5 LAN Settings and Connection (when connected to the Z3002)

### LAN Settings

You can perform command control using the TCP/IP protocol.  
Set the instrument to match your network environment in advance.

- NOTE**
- Make these settings before connecting to a network. Changing settings while connected can duplicate IP addresses of other network devices, and incorrect address information may otherwise be presented to the network.
  - The instrument does not support DHCP (automatic IP address assignment) on a network.

### Setting Items

IP address	Identifies each device connected on a network. Each network device must be set to a unique address. The instrument supports IP version 4, with IP addresses indicated as four decimal octets, e.g., "192.168.0.1".
Subnet mask	This setting is for separating the IP address into the network address that indicates the network and the host address that indicates the instrument. On this instrument, the subnet mask is represented as four decimal numbers separated by "." such as "255.255.255.0".
Default Gateway	When the computer and instrument are on different but overlapping networks (subnets), this IP address specifies the device to serve as the gateway between the networks. If the computer and instrument are connected one-to-one, no gateway is used, and the instrument's default setting "0.0.0.0" can be kept as is.

### Network Environment Configuration

#### Example 1. Connecting the instrument to an existing network

When connecting the instrument to an existing network, the network settings need to be confirmed in advance.

An IP address which is not the same as that of another network device needs to be assigned.

Confirm the following items with the network administrator, and write them down.

IP Address	_____ . _____ . _____ . _____
Subnet Mask	_____ . _____ . _____ . _____
Default Gateway	_____ . _____ . _____ . _____

#### Example 2. Connecting multiple instruments to a single computer using a hub

When building a local network with no outside connection, the following private IP addresses are recommended.

Example of private IP address:

IP Address ..... Computer: 192.168.0.100

Instrument: 192.168.0.1, 192.168.0.2, 192.168.0.3...

(Set an IP address that differs from that of other network devices.)

Subnet Mask ..... 255.255.255.0

Default Gateway ..... OFF(0.0.0.0)

#### Example 3. Connecting one instrument to a single computer using the 9642 LAN Cable

The 9642 LAN Cable can be used with its supplied connection adapter to connect one instrument to one computer, in which case the IP address is freely settable. Use the recommended private IP addresses.

IP Address ..... Computer: 192.168.0.100

Instrument: 192.168.0.1 (Set to a different IP address than the computer.)

Subnet Mask ..... 255.255.255.0

Default Gateway ..... OFF(0.0.0.0)

# 30

## 3.5 LAN Settings and Connection (when connected to the Z3002)

**1** Open the SYSTEM screen.

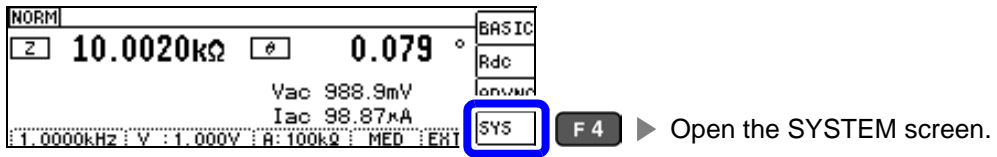

**2** Select LAN as the interface.

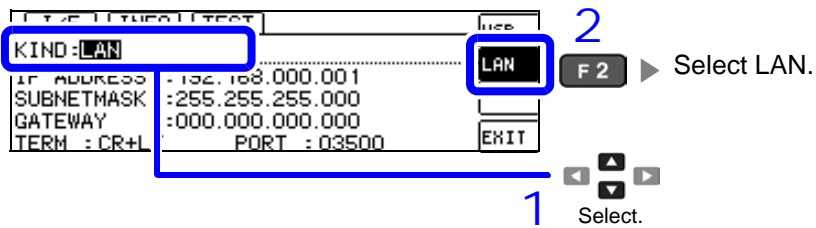

**3** Select the IP address.

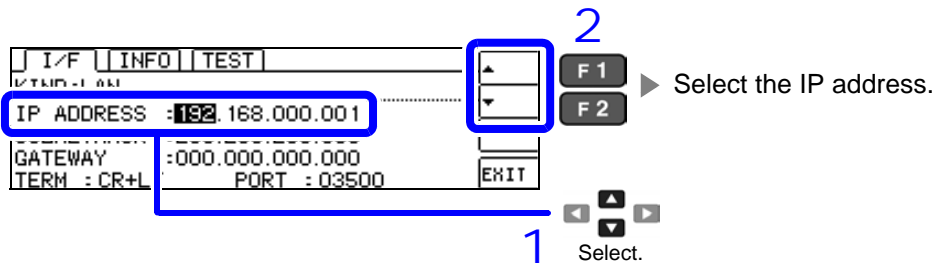

#### 4 Select the subnet mask.

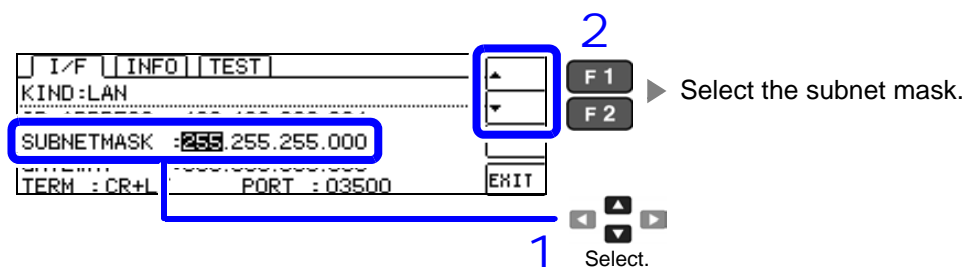

**NOTE** Any of the following 30 subnet masks can be set for the instrument.

128.000.000.000	255.128.000.000	255.255.128.000	255.255.255.128
192.000.000.000	255.192.000.000	255.255.192.000	255.255.255.192
224.000.000.000	255.224.000.000	255.255.224.000	255.255.255.224
240.000.000.000	255.240.000.000	255.255.240.000	255.255.255.240
248.000.000.000	255.248.000.000	255.255.248.000	255.255.255.248
252.000.000.000	255.252.000.000	255.255.252.000	255.255.255.252
254.000.000.000	255.254.000.000	255.255.254.000	
255.000.000.000	255.255.000.000	255.255.255.000 (Initial setting)	

#### 5 Select the default gateway.

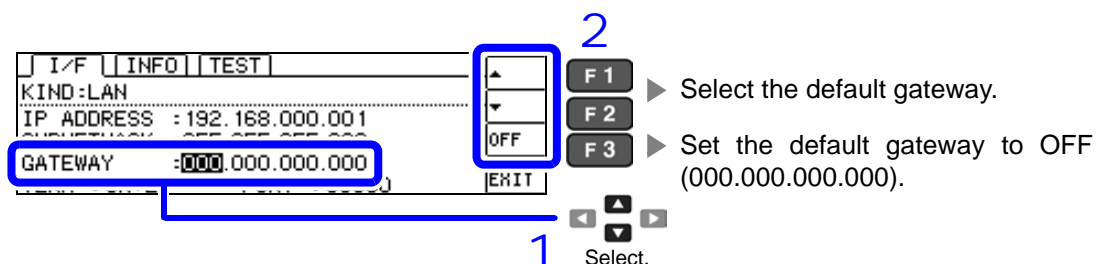

If the default gateway does not need to be set, for example, when connecting the instrument and computer on a one-to-one basis using a cross cable, leave this set to OFF.

#### 6 Select the terminator setting.

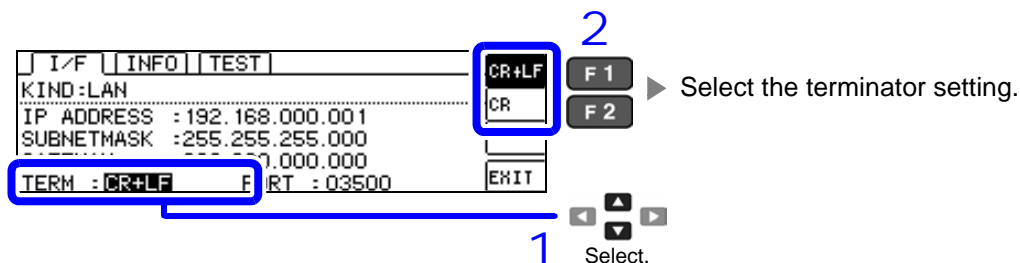

### 7 Select the port number. Settable range : 1024 to 65535

The screenshot shows a terminal window with the following text:

```
| I/F | INFO | TEST |
KIND:LAN
IP ADDRESS :192.168.000.001
SUBNETMASK :255.255.255.000
GATEWAY :000
TERM : CR+LF
```

The 'PORT' field is highlighted with a blue box and contains '03500'. A blue arrow labeled '1' points from the 'PORT' field to a 'Select.' button (represented by a square with a downward arrow). A blue box labeled '2' encloses the 'CLEAR' and 'EXIT' buttons. To the right of the terminal window, there are three function key buttons: 'F1', 'F2', and 'F3'. 'F1' is labeled 'Select the port number.' and 'F3' is labeled 'Revert the setting to the default value.'

### 8

The screenshot shows the same terminal window as in step 7, but with the 'PORT' field now containing '03500'. A blue box labeled 'EXIT' encloses the 'EXIT' button. A blue arrow labeled 'F4' points from the 'EXIT' button to the text 'You will return to the measurement screen.'

## Connecting a LAN Cable

Use a LAN cable to connect the instrument and computer.

### Required items:

When connecting the instrument to an existing network (prepare any of the following):

- Straight-through Cat 5, 100BASE-TX-compliant Ethernet cable (up to 100 m, commercially available).  
For 10BASE communication, a 10BASE-T-compliant cable may also be used.
- Hioki 9642 LAN Cable (option)  
(A cross adapter cannot be used.)

When connecting one instrument to a single computer (prepare one of the following):

- 100BASE-TX-compliant cross-over cable (up to 100 m)
- 100BASE-TX-compliant straight-through cable with cross-over adapter (up to 100 m)
- Hioki 9642 LAN Cable (option)

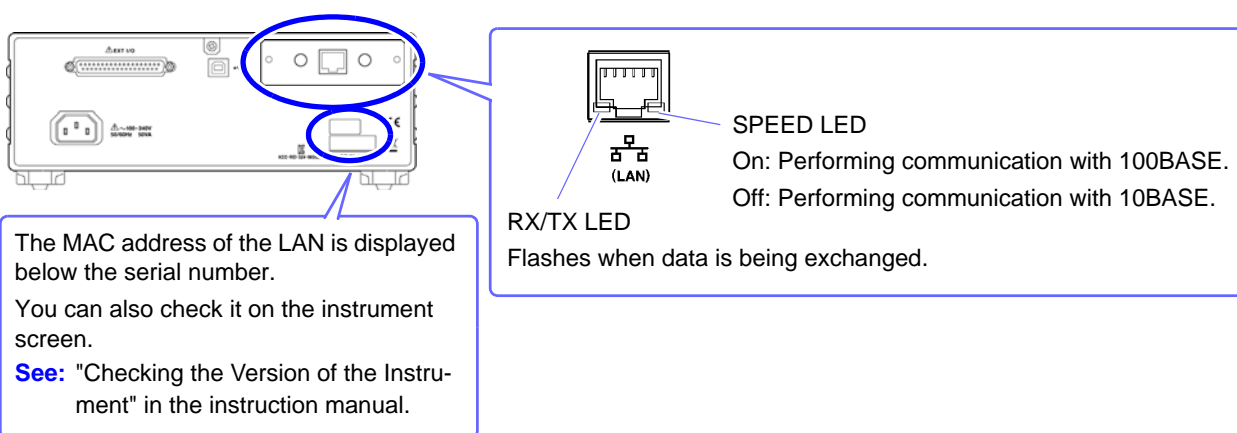

### When connecting the instrument to a single computer (connect the instrument to the computer)

Connecting with the 9642 LAN Cable and crossover adapter (supplied with the 9642)

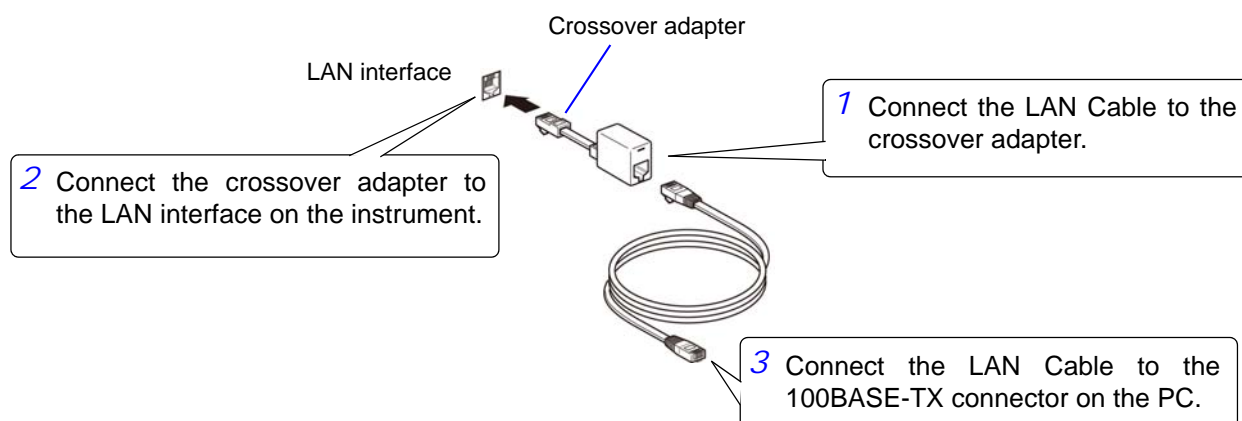

## 3.6 Remote Mode

When you connect a device to an interface and start communication, the mode becomes remote mode (remote operation state) and the keys on the LCD are disabled.

### Remote status

NORM		LOCAL	
Z	10.0020kΩ	∅	0.079 °
Vac 988.9mV		Iac 98.87μA	
: 1.0000kHz : V : 1.000V : R : 100kΩ : MED : EXT :			

**F 1** Keys other than [F1] are disabled.

## Canceling Remote Mode

1

NORM		LOCAL	
Z	10.0020kΩ	∅	0.079 °
Vac 988.9mV		Iac 98.87μA	
: 1.0000kHz : V : 1.000V : R : 100kΩ : MED : EXT :			

**F 4** ▶ You will return to the measurement screen.

2

NORM		BASIC	
Z	10.0020kΩ	∅	0.079 °
Vac 988.9mV		Iac 98.87μA	
: 1.0000kHz : V : 1.000V : R : 100kΩ : MED : EXT :			
		Rdc	ADVNC
		SYS	

You will return to the measurement screen.

# Model IM3533/ IM3533-01/ IM3590 Connection and Setting

## Chapter 4

### 4.1 Overview of Communication

You can control the instrument with communication commands from a computer via the USB, GP-IB, RS-232C and LAN interfaces.

There are the following four communication methods. To enable communication, the communication conditions need to be set on the instrument.

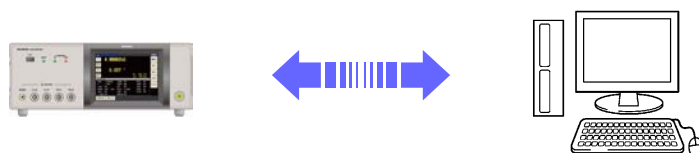

#### USB communication (p. 37)

The instrument is communication class compatible.

#### GP-IB communication (when connected to the Z3000) (p. 39)

- Commands common to IEEE-488-2 1987 (requirement) can be used.
- The instrument complies with the following standard. (Compliance standard: IEEE-488.1 1987)
- The instrument has been designed with reference to the following standard. (Reference standard: IEEE-488.2 1987)

#### RS-232C communication (when connected to the Z3001) (p. 41)

Printer can be connected to enable printing measurement values and screens.

#### LAN communication (when connected to the Z3002) (p. 43)

Command control using the TCP/IP protocol is possible.



#### **WARNING**

- Always turn both devices OFF when connecting and disconnecting an interface connector. Otherwise, an electric shock accident may occur.
- To avoid damage to the instrument, do not short-circuit the terminal and do not input voltage to the terminal.
- Failure to fasten the connectors properly may result in sub-specification performance or damage to the equipment.

## Screen Displayed while Setting Interfaces

When you set an interface, the icon for the set interface is displayed on the right side of the screen.

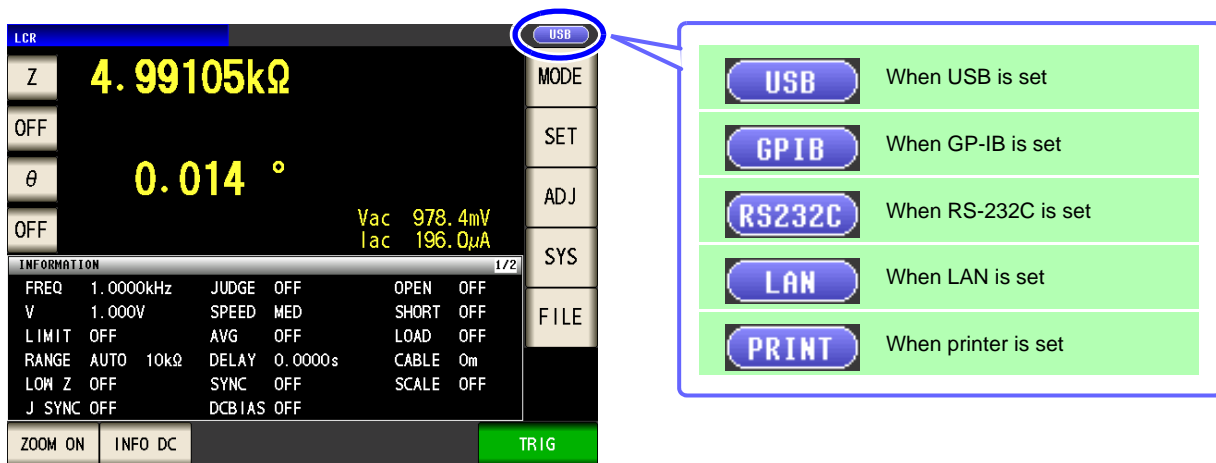



# 4.2 USB Settings and Connection

**NOTE** To connect the instrument to a computer the first time, a dedicated USB driver must be installed. Before connecting the instrument to the computer, install the USB driver. The USB driver can be downloaded from the bundled CD, or our web site. (<http://www.hioki.com>) The USB driver is compatible with the Windows XP (32-bit version), Windows Vista (32-bit, 64-bit version), and Windows 7 (32-bit, 64-bit version) operating systems. Additionally, do not put the computer into the sleep state while the instrument is connected to the computer.

## Setting USB

The display will vary with the installed options.

**Procedure**

You can configure the setting from any of **LCR** mode, **ANALYZER** mode and **TRANSFORMER** mode.

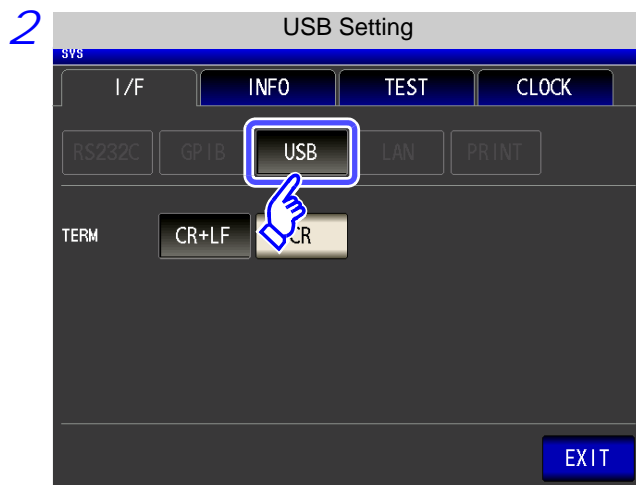
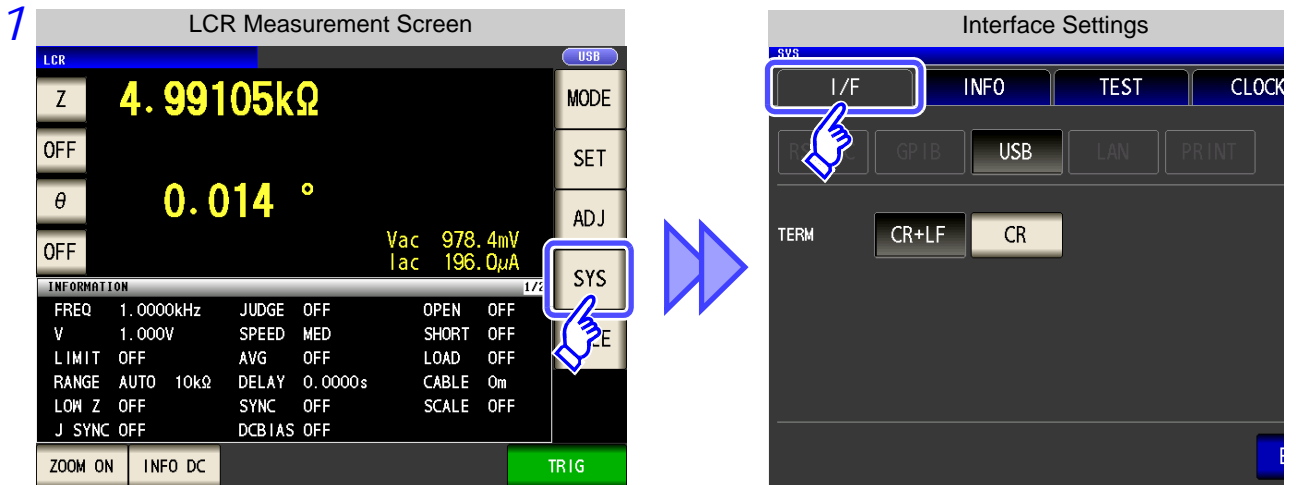

Press **USB**.

When an option is connected

Using the Z3000

Using the Z3001

Using the Z3002

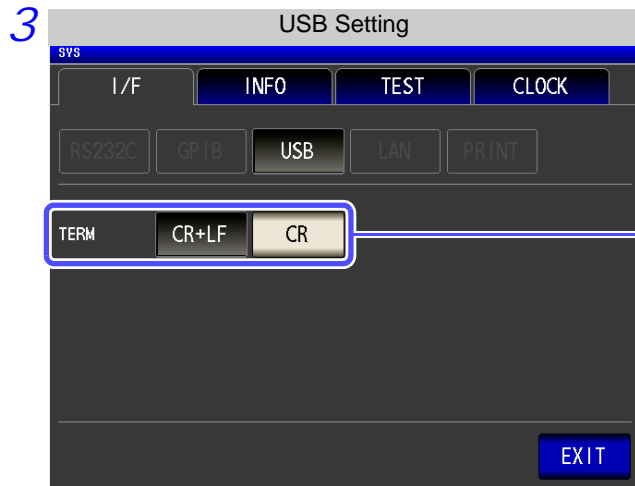

Select the terminator setting.

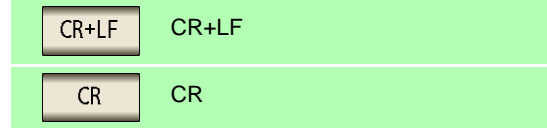

4 Press **EXIT** to confirm the setting.

### Connecting the USB Cable

Connect a USB cable (commercially available USB cable) to the USB port of the instrument.

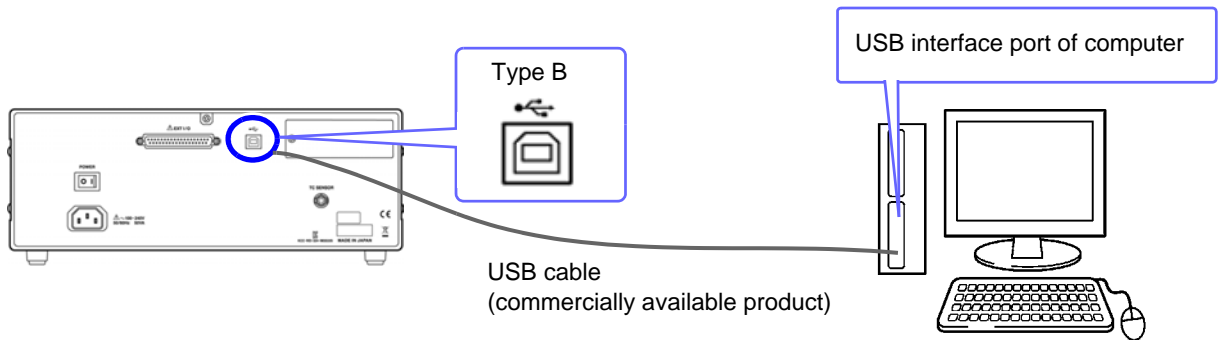

#### **CAUTION**

- To avoid faults, do not disconnect or reconnect the USB cable during instrument operation.
- Connect the instrument and the computer to a common earth ground. Using different grounds could result in potential difference between the instrument and the computer. Potential difference on the USB cable can result in malfunctions and faults.

# 4.3 GP-IB Connection and Settings (when connected to the Z3000)

## Connecting the GP-IB Cable

Connect the GP-IB cable to the GP-IB connector.

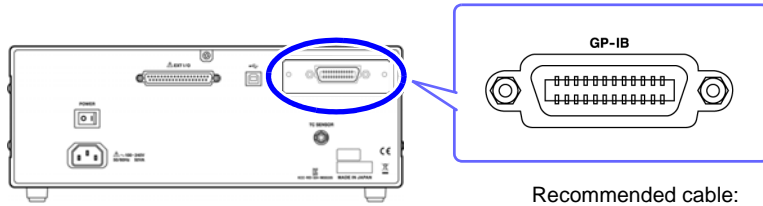

Recommended cable:  
9150-02 GP-IB connection cable (2 m)

## Setting GP-IB

### Procedure

You can configure the setting from any of **LCR** mode, **ANALYZER** mode and **TRANSFORMER** mode.

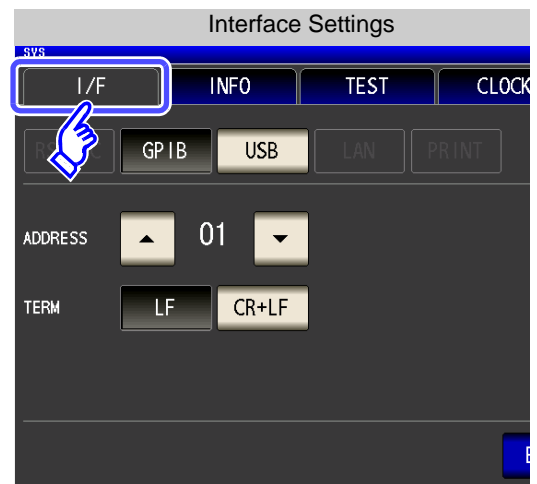
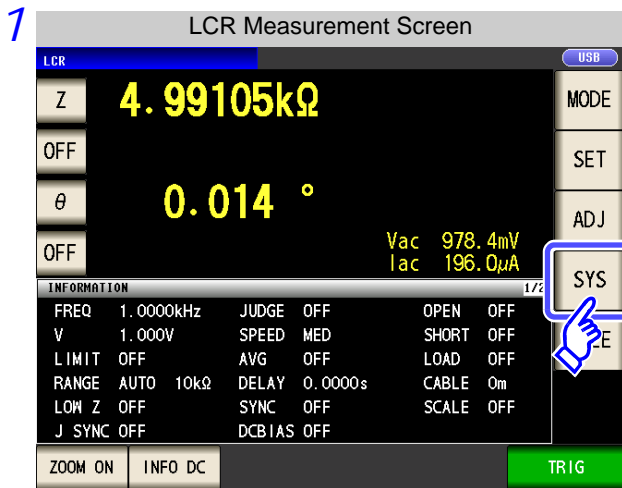

### 4.3 GP-IB Connection and Settings (when connected to the Z3000)

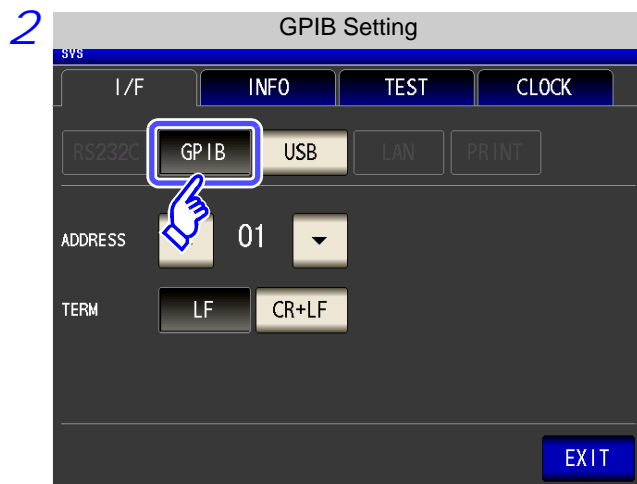

Press  .

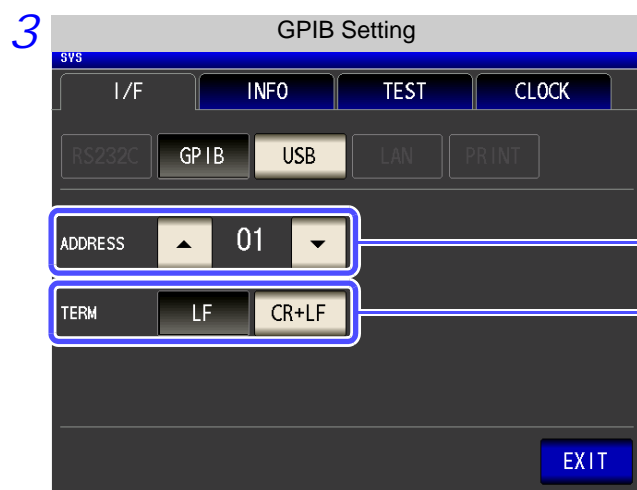

Use  or  to set the GP-IB address.

Select the terminator setting.

 LF with EOI

 LF with CR+EOI

4 Press  to confirm the setting.

## 4.4 RS-232C Connection and Settings (when connected to the Z3001)

### Connecting the RS-232C Cable

Connect the RS-232C cable to the RS-232C connector.  
(Recommended cable: 9637 RS-232C cable)

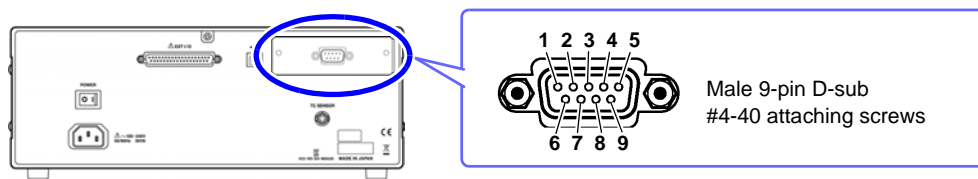

To connect the instrument to a controller (DTE), use a **crossover cable** compatible with the connectors on both the instrument and the controller. The I/O connector is a DTE (Data Terminal Equipment) configuration.

Connector (D-sub) Pin No.	Interchange Circuit Name	CCITT Circuit No.	EIA Abbreviation	JIS Abbreviation	Common Abbreviation
1	Unused				
2	Received Data	104	BB	RD	RxD
3	Transmitted Data	103	BA	SD	TxD
4	Data Terminal Ready	108/2	CD	ER	DTR
5	Signal Ground	102	AB	SG	GND
6	Unused				
7	Request to Send	105	CA	RS	RTS
8	Clear to Send	106	CB	CS	CTS
9	Unused				

#### Example: Connecting to a DOS/V PC

Specification: D-sub 9-pin female and female connector, reverse connection

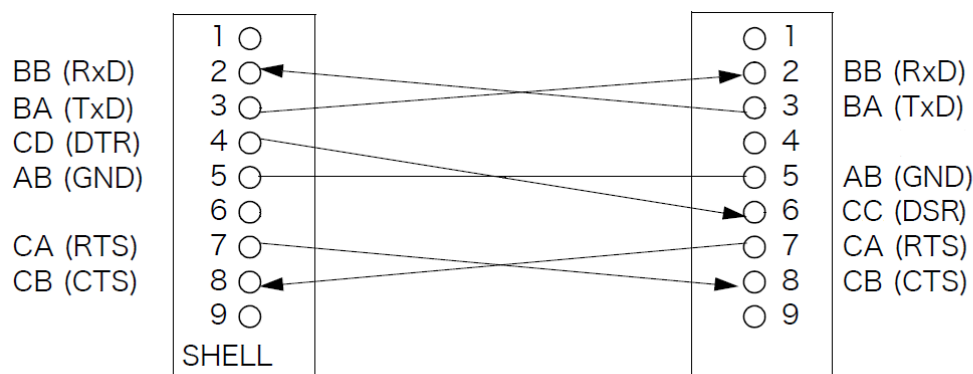

**NOTE** Hardware control will not work properly if you use a cable that has CA(RTS) and CB(CTS) short-circuited.

**Setting RS-232C**

**Procedure** You can configure the setting from any of **LCR** mode, **ANALYZER** mode and **TRANSFORMER** mode.

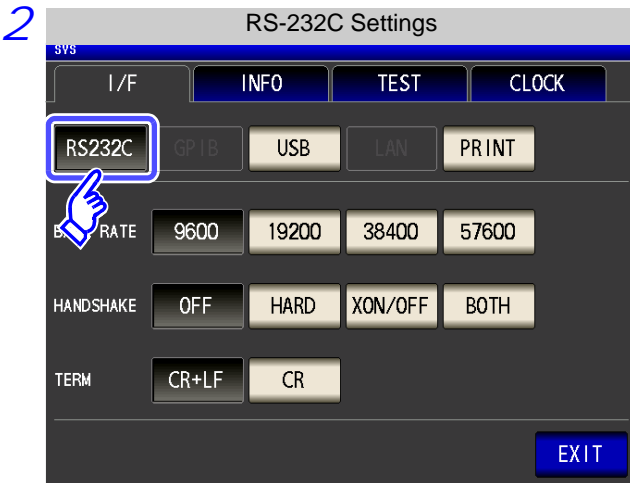
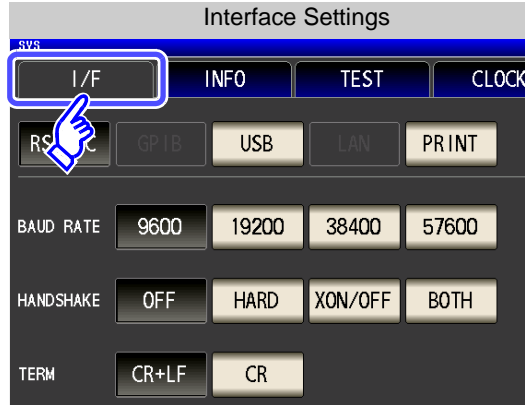
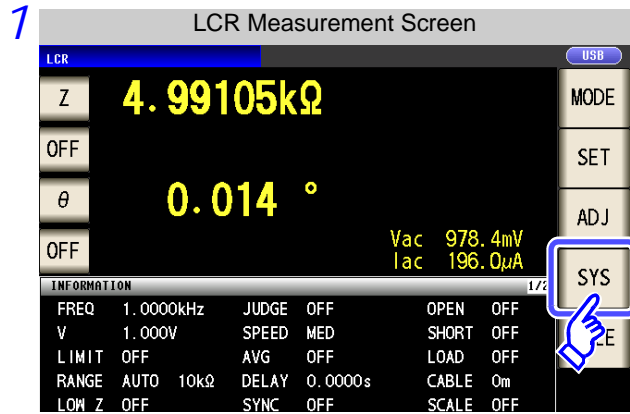

Press **RS232C**.

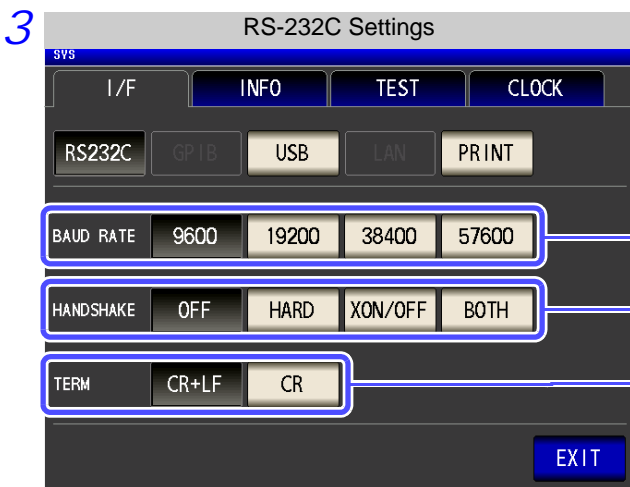

Select the baud rate setting.

Select the handshake setting.

- No flow control
- Hardware (RTS/CTS control)
- Software (XON/XOFF control)
- Hardware + software

Select the terminator setting.

- CR+LF
- CR

4 Press **EXIT** to confirm the setting.

## 4.5 LAN Settings and Connection (when connected to the Z3002)

### LAN Settings

You can perform command control using the TCP/IP protocol.  
Set the instrument to match your network environment in advance.

- NOTE**
- Make these settings before connecting to a network. Changing settings while connected can duplicate IP addresses of other network devices, and incorrect address information may otherwise be presented to the network.
  - The instrument does not support DHCP (automatic IP address assignment) on a network.

### Setting Items

IP address	Identifies each device connected on a network. Each network device must be set to a unique address. The instrument supports IP version 4, with IP addresses indicated as four decimal octets, e.g., "192.168.0.1".
Subnet mask	This setting is for separating the IP address into the network address that indicates the network and the host address that indicates the instrument. On this instrument, the subnet mask is represented as four decimal numbers separated by "." such as "255.255.255.0."
Default Gateway	When the computer and instrument are on different but overlapping networks (subnets), this IP address specifies the device to serve as the gateway between the networks. If the computer and instrument are connected one-to-one, no gateway is used, and the instrument's default setting "0.0.0.0" can be kept as is.

### Network Environment Configuration

#### Example 1. Connecting the instrument to an existing network

When connecting the instrument to an existing network, the network settings need to be confirmed in advance.

An IP address which is not the same as that of another network device needs to be assigned.  
Confirm the following items with the network administrator, and write them down.

IP Address	_____ . _____ . _____ . _____
Subnet Mask	_____ . _____ . _____ . _____
Default Gateway	_____ . _____ . _____ . _____

#### Example 2. Connecting multiple instruments to a single computer using a hub

When building a local network with no outside connection, the following private IP addresses are recommended.

Example of private IP address:

IP Address ..... Computer: 192.168.0.100

Instrument: 192.168.0.1, 192.168.0.2, 192.168.0.3...

(Set an IP address that differs from that of other network devices.)

Subnet Mask ..... 255.255.255.0

Default Gateway ..... OFF(0.0.0.0)

#### Example 3. Connecting one instrument to a single computer using the 9642 LAN Cable

The 9642 LAN Cable can be used with its supplied connection adapter to connect one instrument to one computer, in which case the IP address is freely settable. Use the recommended private IP addresses.

IP Address ..... Computer: 192.168.0.100

Instrument: 192.168.0.1 (Set to a different IP address than the computer.)

Subnet Mask ..... 255.255.255.0

Default Gateway ..... OFF(0.0.0.0)

4.5 LAN Settings and Connection (when connected to the Z3002)

Procedure

You can configure the setting from any of **LCR** mode, **ANALYZER** mode and **TRANSFORMER** mode.

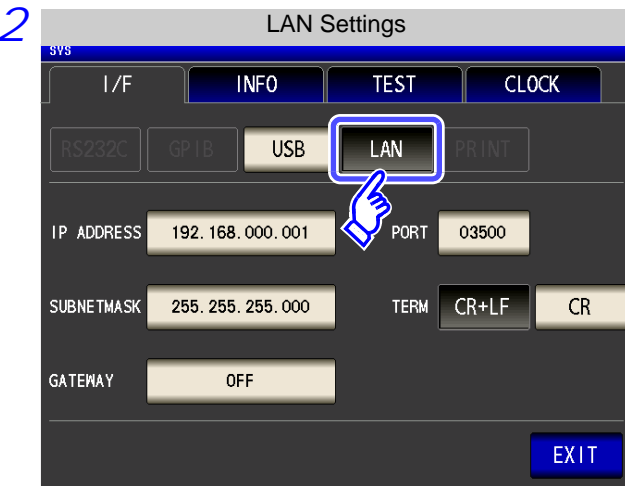
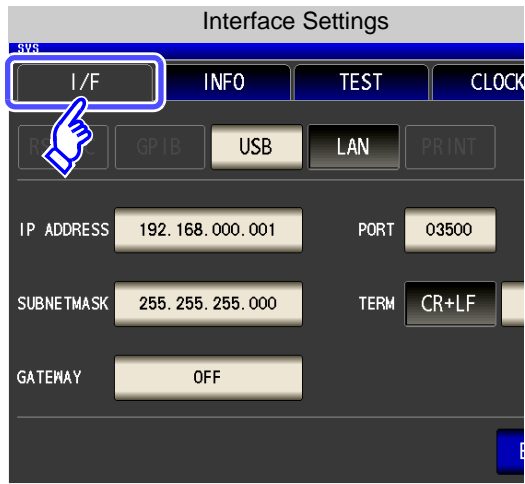
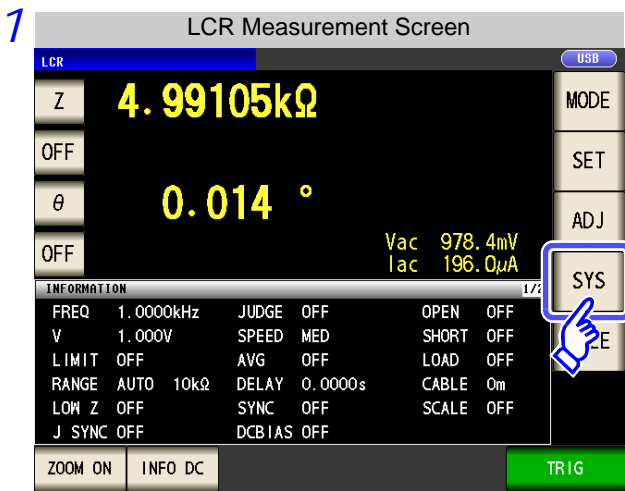

Press **LAN**.

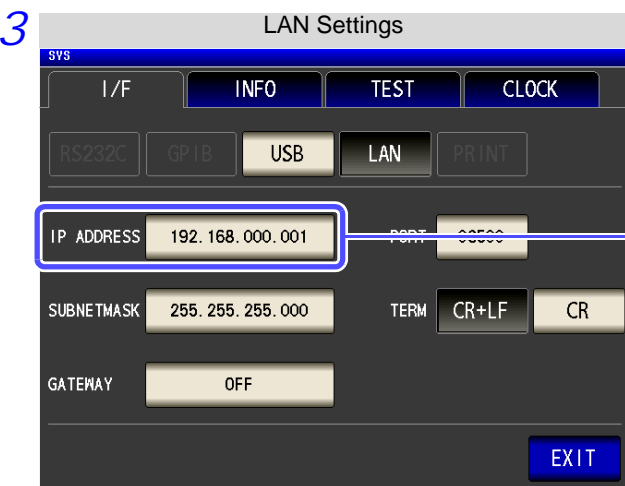

Select the IP address.



### 4.5 LAN Settings and Connection (when connected to the Z3002)

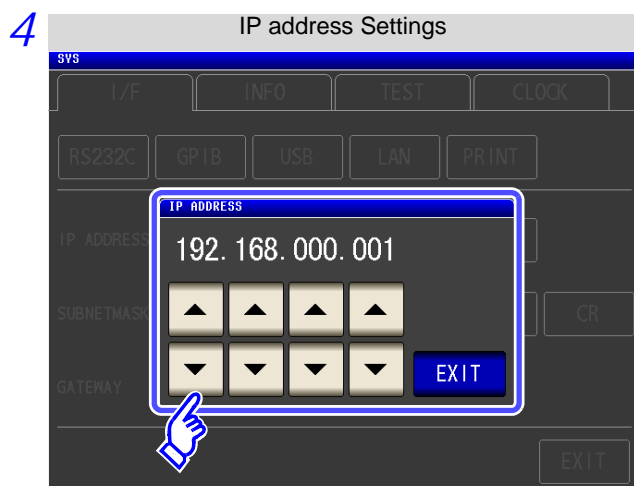

Use or to set the IP address.

Press to confirm the setting.

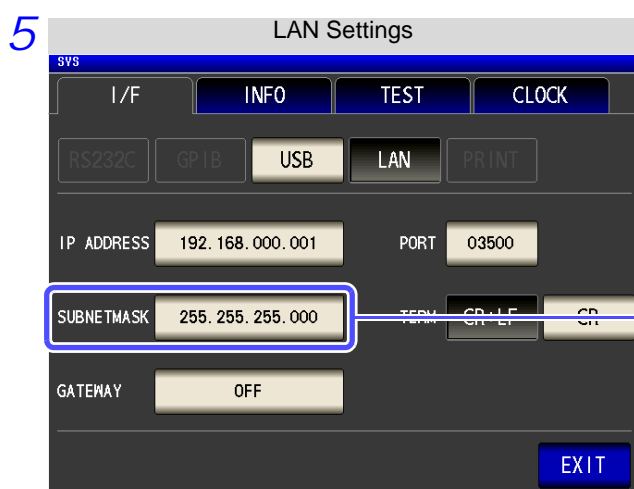

Select the subnet mask.

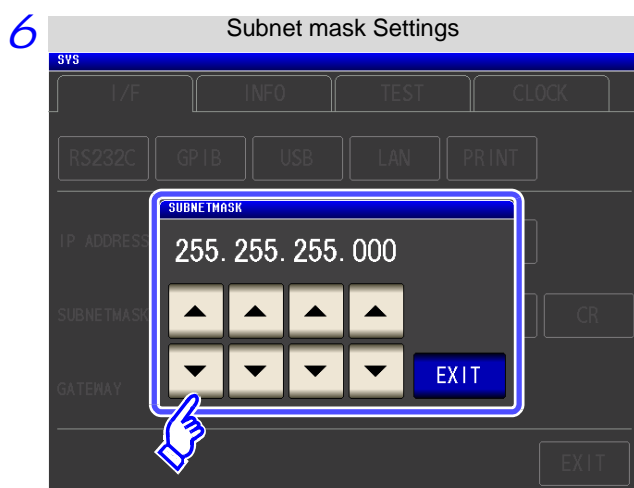

Use or to set the subnet mask, and press to confirm the setting.

**NOTE** Any of the following 30 subnet masks can be set for the instrument.

128.000.000.000	255.128.000.000	255.255.128.000	255.255.255.128
192.000.000.000	255.192.000.000	255.255.192.000	255.255.255.192
224.000.000.000	255.224.000.000	255.255.224.000	255.255.255.224
240.000.000.000	255.240.000.000	255.255.240.000	255.255.255.240
248.000.000.000	255.248.000.000	255.255.248.000	255.255.255.248
252.000.000.000	255.252.000.000	255.255.252.000	255.255.255.252
254.000.000.000	255.254.000.000	255.255.254.000	
255.000.000.000	255.255.000.000	255.255.255.000 (Initial setting)	

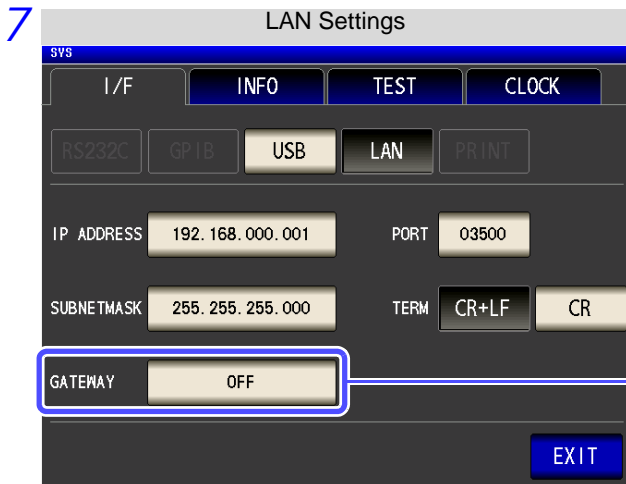

## 4.5 LAN Settings and Connection (when connected to the Z3002)

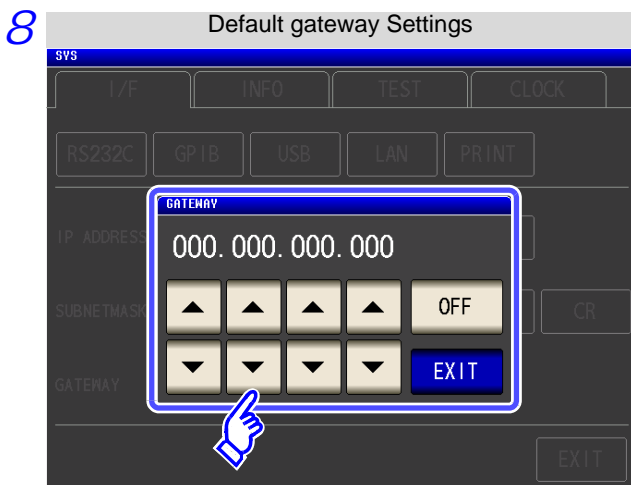

Select the default gateway.

If the default gateway does not need to be set, for example, when connecting the instrument and computer on a one-to-one basis using a cross cable, leave this set to OFF.



Use  or  to set the default gateway.

Press  to confirm the setting.

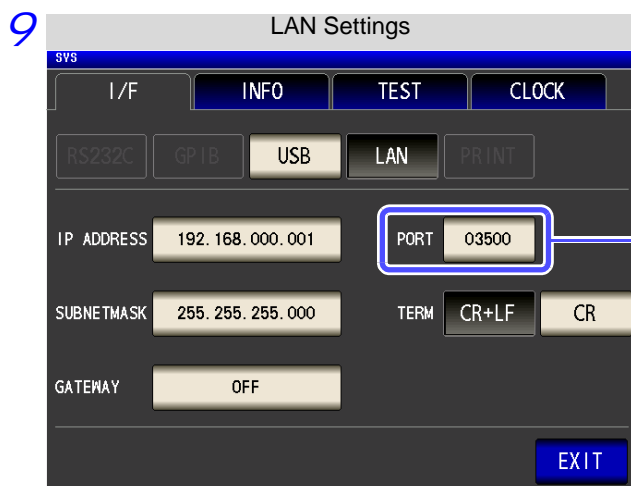

Select the port number.

4.5 LAN Settings and Connection (when connected to the Z3002)

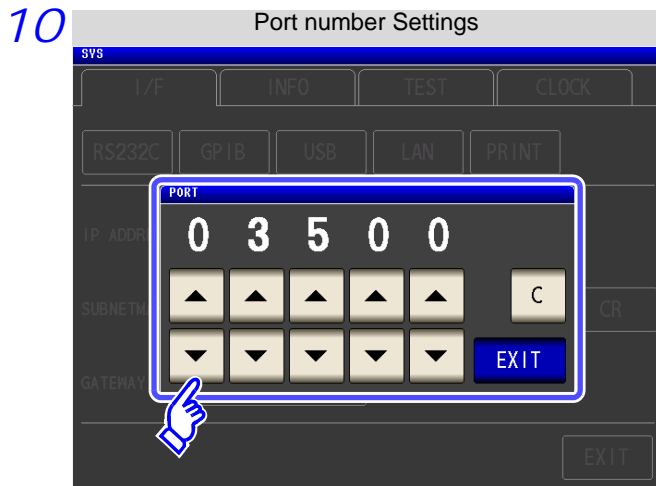

Use or to set the port number to use for communication commands.

Settable range : 1024 to 65535

Press to confirm the setting.

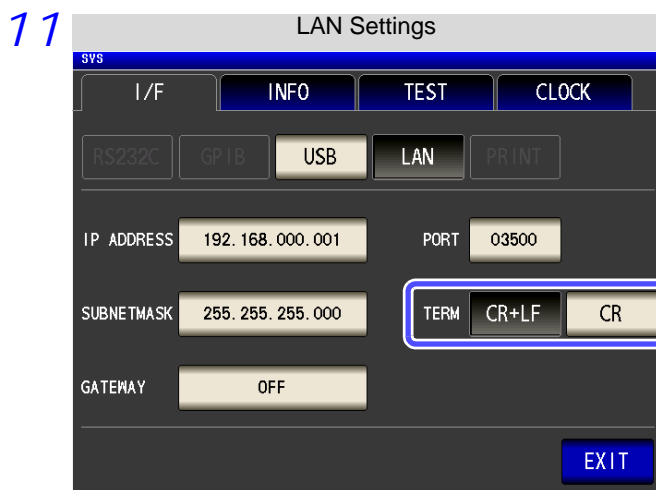

Select the terminator setting.

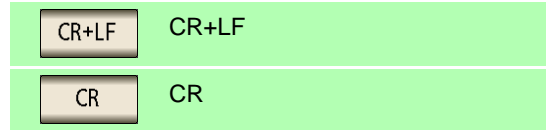

12 Press to confirm the setting.

## Connecting a LAN Cable

Use a LAN cable to connect the instrument and computer.

### Required items:

When connecting the instrument to an existing network (prepare any of the following):

- Straight-through Cat 5, 100BASE-TX-compliant Ethernet cable (up to 100 m, commercially available). For 10BASE communication, a 10BASE-T-compliant cable may also be used.
- Hioki 9642 LAN Cable (option)  
(A cross adapter cannot be used.)

When connecting one instrument to a single computer (prepare one of the following):

- 100BASE-TX-compliant cross-over cable (up to 100 m)
- 100BASE-TX-compliant straight-through cable with cross-over adapter (up to 100 m)
- Hioki 9642 LAN Cable (option)

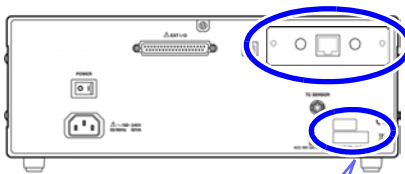

The MAC address of the LAN is displayed below the serial number.  
You can also check it on the instrument screen.  
**See:** "Checking the Version of the Instrument" in the instruction manual.

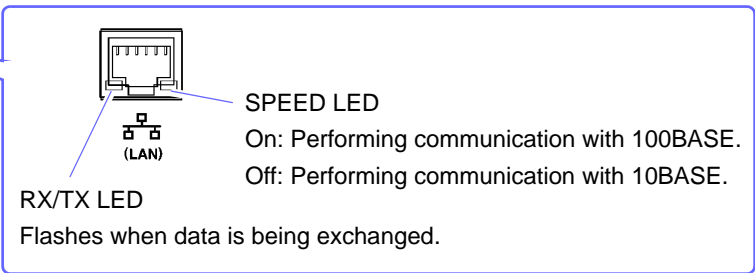

### When connecting the instrument to a single computer (connect the instrument to the computer)

Connecting with the 9642 LAN Cable and crossover adapter (supplied with the 9642)

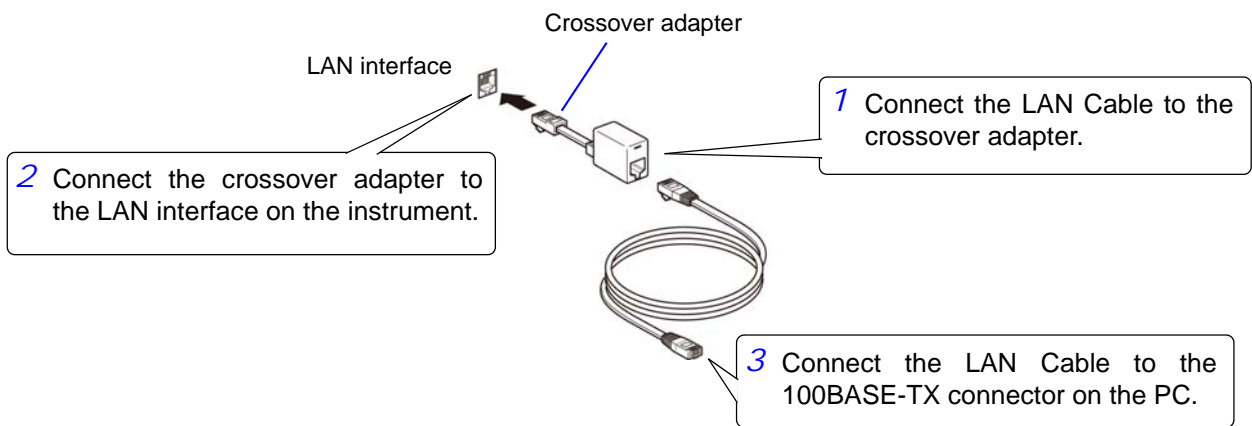

## 4.6 Remote Mode

When you connect a device to an interface and start communication, the mode becomes remote mode (remote operation state) and the keys on the LCD are disabled.

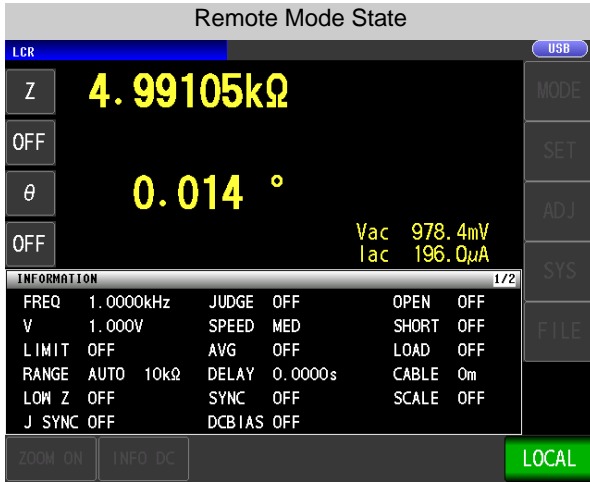

All of the keys except **LOCAL** are disabled.

### Canceling Remote Mode

#### Procedure

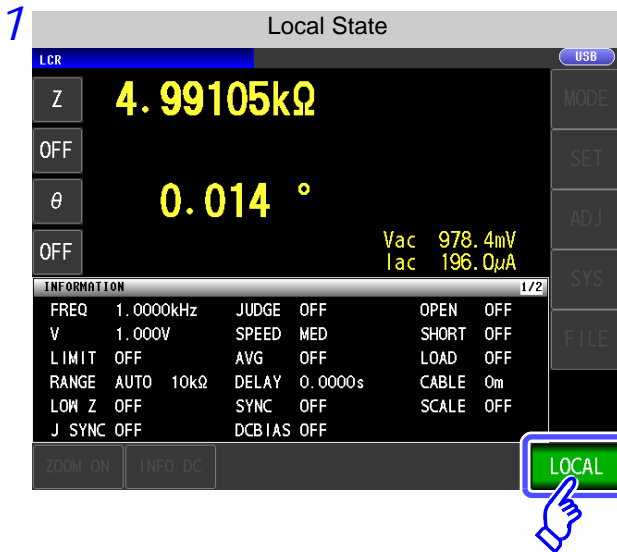

Press **LOCAL** to return to the normal state (local state).

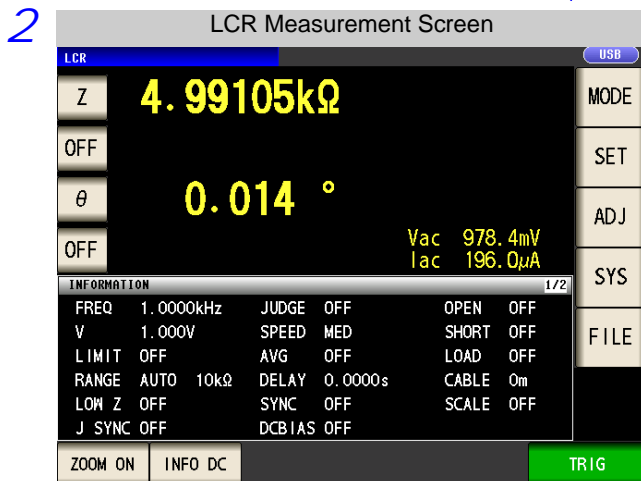

The measurement screen is redisplayed.



# Model IM7580 Connection and Setting

## Chapter 5

### 5.1 Overview of Communication

You can control the instrument with communication commands from a computer via the USB, GP-IB, RS-232C and LAN interfaces.

There are the following four communication methods. To enable communication, the communication conditions need to be set on the instrument.

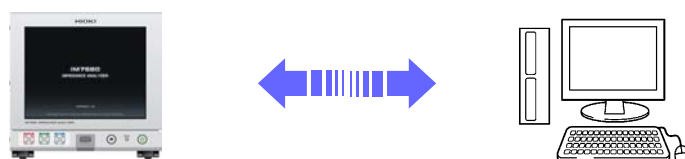

#### USB communication (p. 53)

The instrument is communication class compatible.

#### LAN communication (p. 55)

Command control using the TCP/IP protocol is possible.

#### GP-IB communication (when connected to the Z3000) (p. 61)

- Commands common to IEEE-488-2 1987 (requirement) can be used.
- The instrument complies with the following standard. (Compliance standard: IEEE-488.1 1987)
- The instrument has been designed with reference to the following standard. (Reference standard: IEEE-488.2 1987)

#### RS-232C communication (when connected to the Z3001) (p. 63)



- WARNING**
- Always turn both devices OFF when connecting and disconnecting an interface connector. Otherwise, an electric shock accident may occur.
  - To avoid damage to the instrument, do not short-circuit the terminal and do not input voltage to the terminal.
  - Failure to fasten the connectors properly may result in sub-specification performance or damage to the equipment.

## Screen Displayed while Setting Interfaces

When you set an interface, the icon for the set interface is displayed on the right side of the screen.



<b>USB</b>	When USB is set
<b>GPIB</b>	When GP-IB is set
<b>RS232C</b>	When RS-232C is set
<b>LAN</b>	When LAN is set



## 5.2 USB Settings and Connection

**NOTE** To connect the instrument to a computer the first time, a dedicated USB driver must be installed. Before connecting the instrument to the computer, install the USB driver. The USB driver can be downloaded from the bundled CD, or our web site. (<http://www.hioki.com>) The USB driver is compatible with the Windows Vista (32-bit, 64-bit version), Windows 7 (32-bit, 64-bit version) and Windows 8 (32-bit, 64-bit version) operating systems. Additionally, do not put the computer into the sleep state while the instrument is connected to the computer.

### Setting USB

The display will vary with the installed options.

#### Procedure

You can configure the setting from any of **LCR** mode, **ANALYZER** mode and **TRANSFORMER** mode.

1

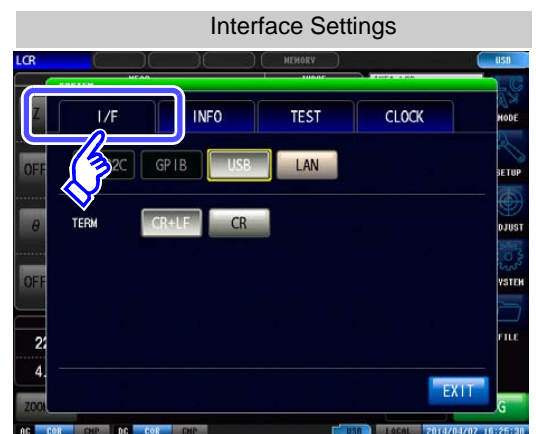

2



Press **USB** .



Select the terminator setting.

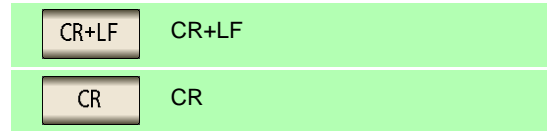

4 Press **EXIT** to confirm the setting.

### Connecting the USB Cable

Connect a USB cable (commercially available USB cable) to the USB port of the instrument.

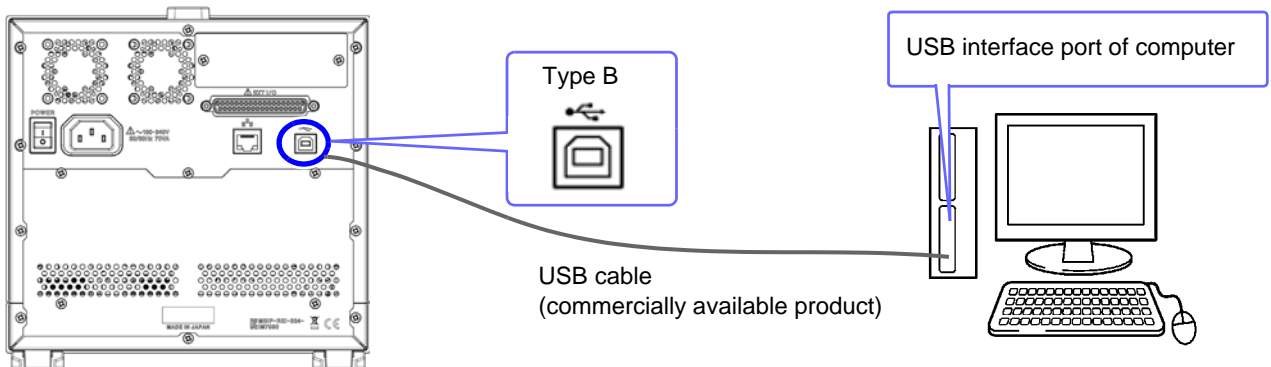

#### **CAUTION**

- To avoid faults, do not disconnect or reconnect the USB cable during instrument operation.
- Connect the instrument and the computer to a common earth ground. Using different grounds could result in potential difference between the instrument and the computer. Potential difference on the USB cable can result in malfunctions and faults.

## 5.3 LAN Settings and Connection

### LAN Settings

You can perform command control using the TCP/IP protocol.  
Set the instrument to match your network environment in advance.

- NOTE**
- Make these settings before connecting to a network. Changing settings while connected can duplicate IP addresses of other network devices, and incorrect address information may otherwise be presented to the network.
  - The instrument does not support DHCP (automatic IP address assignment) on a network.

### Setting Items

IP address	Identifies each device connected on a network. Each network device must be set to a unique address. The instrument supports IP version 4, with IP addresses indicated as four decimal octets, e.g., "192.168.0.1".
Subnet mask	This setting is for separating the IP address into the network address that indicates the network and the host address that indicates the instrument. On this instrument, the subnet mask is represented as four decimal numbers separated by "." such as "255.255.255.0."
Default Gateway	When the computer and instrument are on different but overlapping networks (subnets), this IP address specifies the device to serve as the gateway between the networks. If the computer and instrument are connected one-to-one, no gateway is used, and the instrument's default setting "0.0.0.0" can be kept as is.

### Network Environment Configuration

#### Example 1. Connecting the instrument to an existing network

When connecting the instrument to an existing network, the network settings need to be confirmed in advance.

An IP address which is not the same as that of another network device needs to be assigned.  
Confirm the following items with the network administrator, and write them down.

IP Address	_____ . _____ . _____ . _____
Subnet Mask	_____ . _____ . _____ . _____
Default Gateway	_____ . _____ . _____ . _____

#### Example 2. Connecting multiple instruments to a single computer using a hub

When building a local network with no outside connection, the following private IP addresses are recommended.

Example of private IP address:

IP Address ..... Computer: 192.168.0.100

Instrument: 192.168.0.1, 192.168.0.2, 192.168.0.3...

(Set an IP address that differs from that of other network devices.)

Subnet Mask ..... 255.255.255.0

Default Gateway ..... OFF(0.0.0.0)

#### Example 3. Connecting one instrument to a single computer using the 9642 LAN Cable

The 9642 LAN Cable can be used with its supplied connection adapter to connect one instrument to one computer, in which case the IP address is freely settable. Use the recommended private IP addresses.

IP Address ..... Computer: 192.168.0.100

Instrument: 192.168.0.1 (Set to a different IP address than the computer.)

Subnet Mask ..... 255.255.255.0

Default Gateway ..... OFF(0.0.0.0)

5.3 LAN Settings and Connection

Procedure

You can configure the setting from any of LCR mode, ANALYZER mode and TRANSFORMER mode.

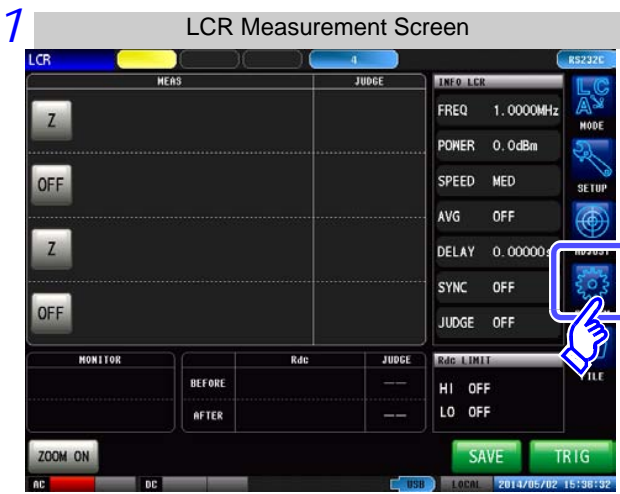

Press LAN .



Select the IP address.

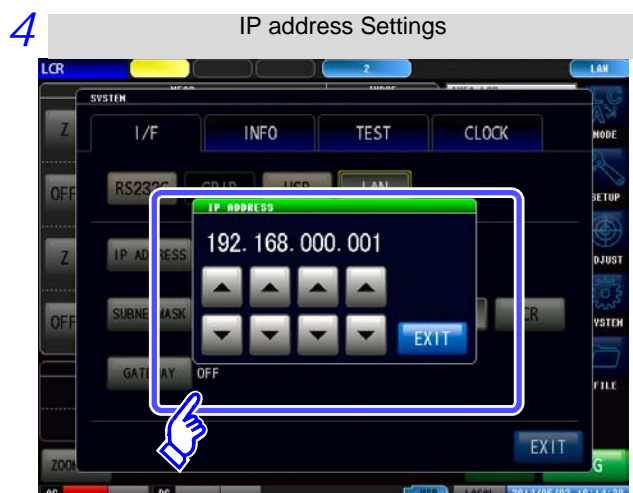

Use  or  to set the IP address.

Press  to confirm the setting.



Select the subnet mask.

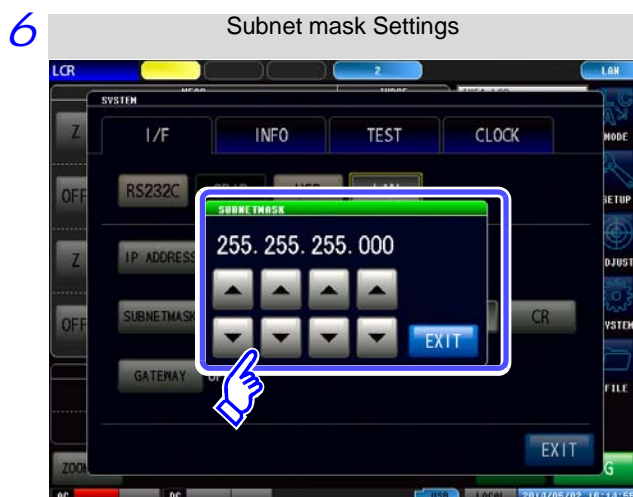

Use  or  to set the subnet mask, and press  to confirm the setting.

**NOTE** Any of the following 30 subnet masks can be set for the instrument.



128.000.000.000	255.128.000.000	255.255.128.000	255.255.255.128
192.000.000.000	255.192.000.000	255.255.192.000	255.255.255.192
224.000.000.000	255.224.000.000	255.255.224.000	255.255.255.224
240.000.000.000	255.240.000.000	255.255.240.000	255.255.255.240
248.000.000.000	255.248.000.000	255.255.248.000	255.255.255.248
252.000.000.000	255.252.000.000	255.255.252.000	255.255.255.252
254.000.000.000	255.254.000.000	255.255.254.000	
255.000.000.000	255.255.000.000	255.255.255.000 (Initial setting)	

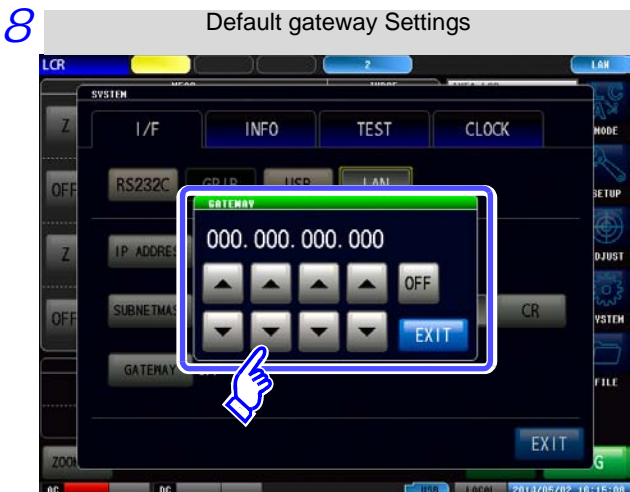

Select the default gateway.

If the default gateway does not need to be set, for example, when connecting the instrument and computer on a one-to-one basis using a cross cable, leave this set to OFF.



Use  or  to set the default gateway.

Press  to confirm the setting.



Select the port number.



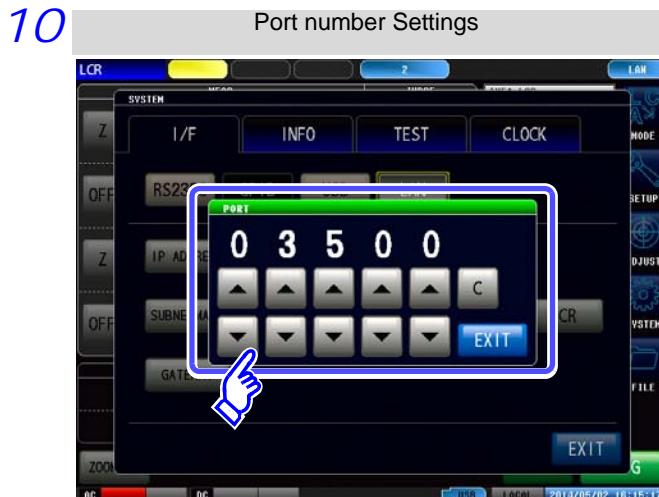

Use or to set the port number to use for communication commands.

Settable range : 1024 to 65535

Press to confirm the setting.



Select the terminator setting.

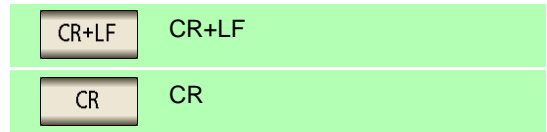

12 Press to confirm the setting.

## Connecting a LAN Cable

Use a LAN cable to connect the instrument and computer.

### Required items:

When connecting the instrument to an existing network (prepare any of the following):

- Straight-through Cat 5, 100BASE-T-compliant Ethernet cable (up to 100 m, commercially available).  
For 100BASE/10BASE communication, a 100BASE-TX/10BASE-T-compliant cable may also be used.
- Hioki 9642 LAN Cable (option)  
(A cross adapter cannot be used.)

When connecting one instrument to a single computer (prepare one of the following):

- 1000BASE-T-compliant cross-over cable (up to 100 m)
- 1000BASE-T-compliant straight-through cable with cross-over adapter (up to 100 m)
- Hioki 9642 LAN Cable (option)

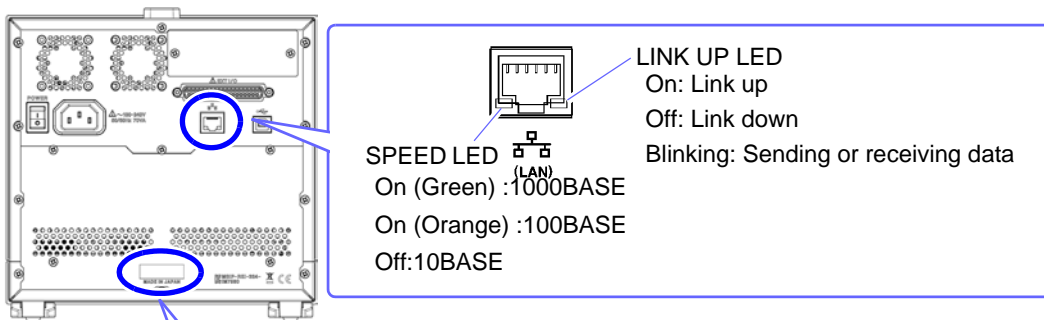

The MAC address of the LAN is displayed below the serial number. You can also check it on the instrument screen.

**See:** "Checking the Version of the Instrument" in the instruction manual.

### When connecting the instrument to a single computer (connect the instrument to the computer)

Connecting with the 9642 LAN Cable and crossover adapter (supplied with the 9642)

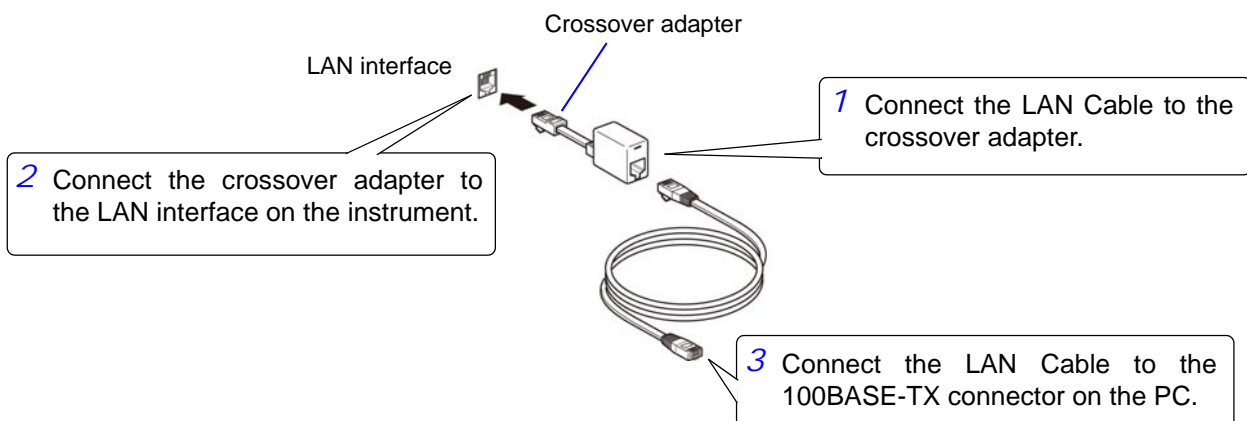



# 5.4 GP-IB Connection and Settings (when connected to the Z3000)

## Connecting the GP-IB Cable

Connect the GP-IB cable to the GP-IB connector.

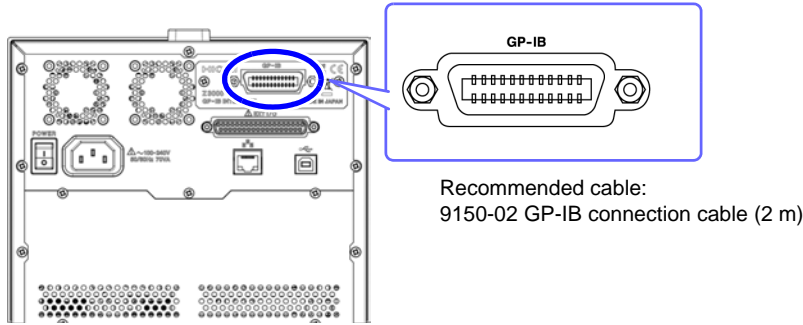

## Setting GP-IB

### Procedure

You can configure the setting from any of **LCR** mode, **ANALYZER** mode and **TRANSFORMER** mode.

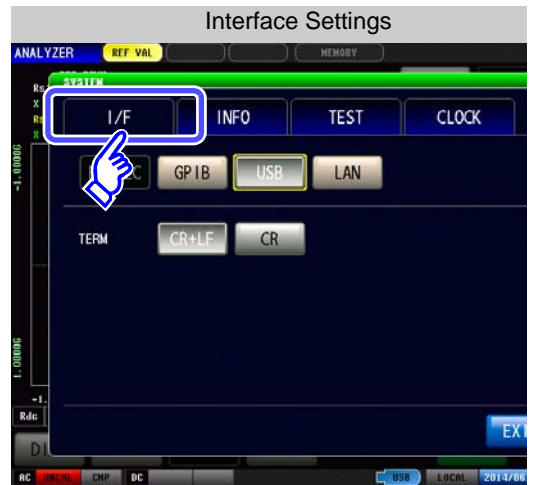
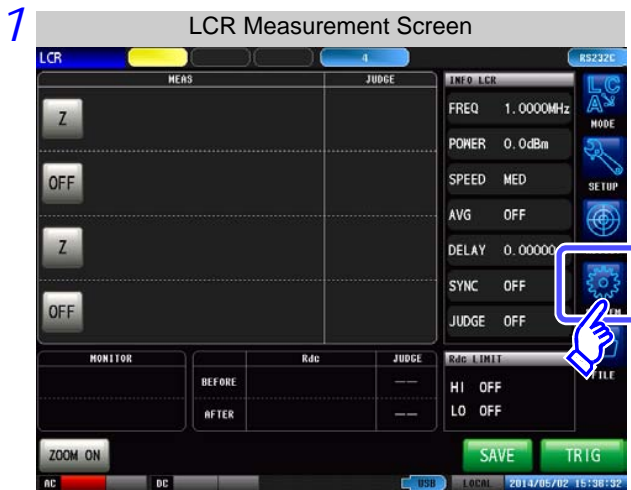

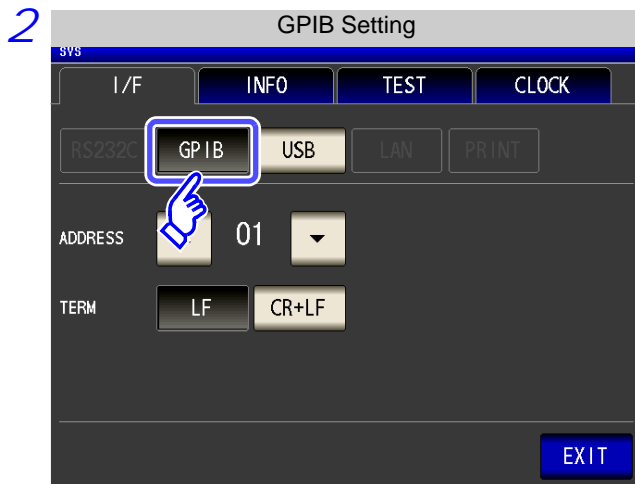

## 5.4 GP-IB Connection and Settings (when connected to the Z3000)



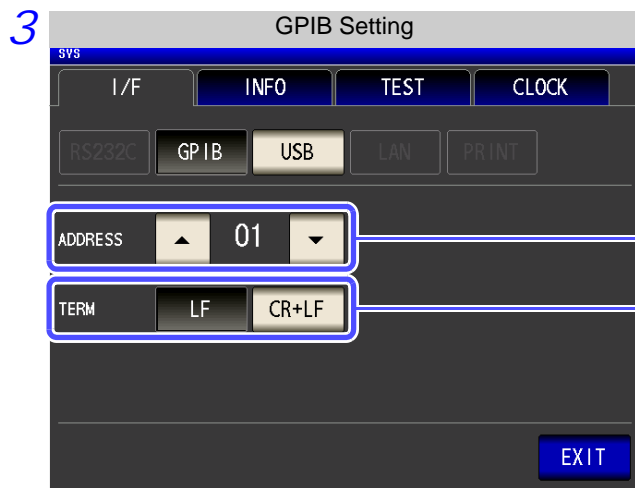

Press  .



Use  or  to set the GP-IB address.

Select the terminator setting.

-  LF with EOI
-  LF with CR+EOI

4 Press  to confirm the setting.

## 5.5 RS-232C Connection and Settings (when connected to the Z3001)

### Connecting the RS-232C Cable

Connect the RS-232C cable to the RS-232C connector.  
(Recommended cable: 9637 RS-232C cable)

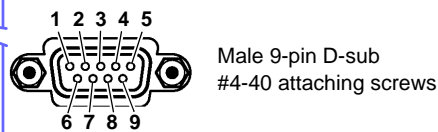
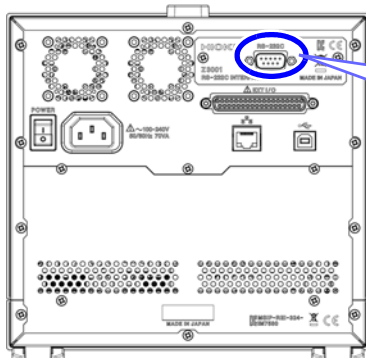

To connect the instrument to a controller (DTE), use a **crossover cable** compatible with the connectors on both the instrument and the controller. The I/O connector is a DTE (Data Terminal Equipment) configuration.

Connector (D-sub) Pin No.	Interchange Circuit Name	CCITT Circuit No.	EIA Abbreviation	JIS Abbreviation	Common Abbreviation
1	Unused				
2	Received Data	104	BB	RD	RxD
3	Transmitted Data	103	BA	SD	TxD
4	Data Terminal Ready	108/2	CD	ER	DTR
5	Signal Ground	102	AB	SG	GND
6	Unused				
7	Unused				
8	Unused				
9	Unused				

#### Example: Connecting to a DOS/V PC

Specification: D-sub 9-pin female and female connector, reverse connection

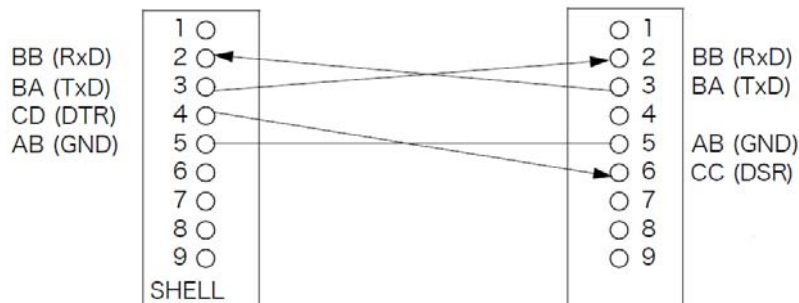

# Setting RS-232C

**Procedure** You can configure the setting from any of **LCR** mode, **ANALYZER** mode and **TRANSFORMER** mode.

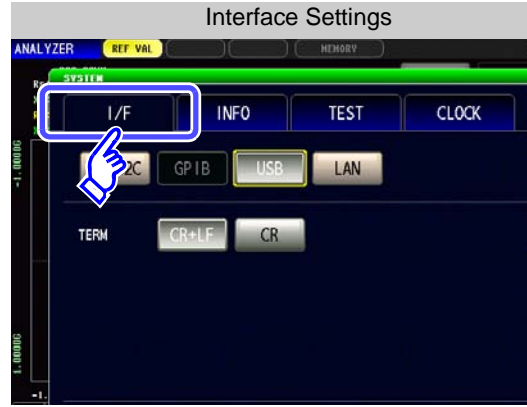
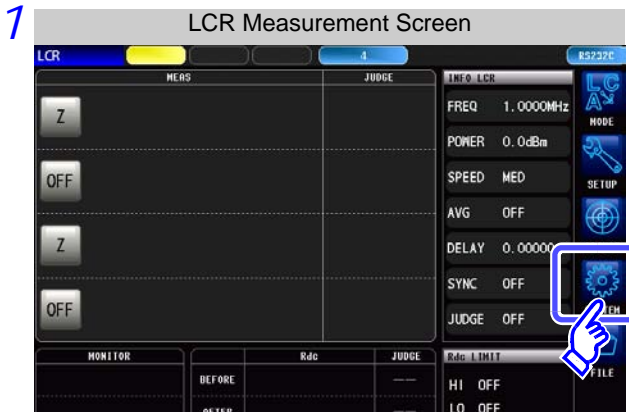

Press **RS232C**.



Select the baud rate setting.

Select the handshake setting.

- No flow control
- Software (XON/XOFF control)

Select the terminator setting.

- CR+LF
- CR

4 Press **EXIT** to confirm the setting.

## 5.6 Remote Mode

When you connect a device to an interface and start communication, the mode becomes remote mode (remote operation state) and the keys on the LCD are disabled.

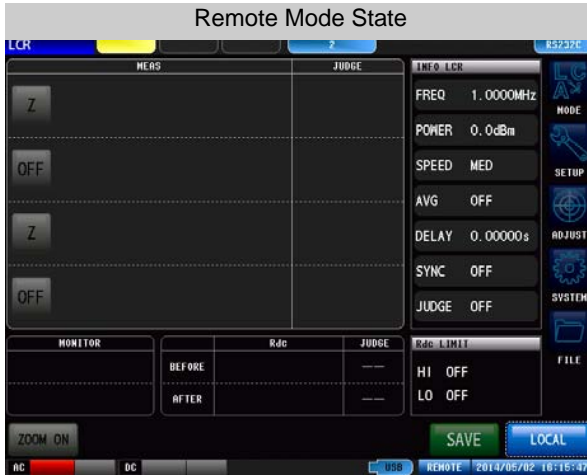

All of the keys except **LOCAL** are disabled.

### Canceling Remote Mode

#### Procedure



Press **LOCAL** to return to the normal state (local state).

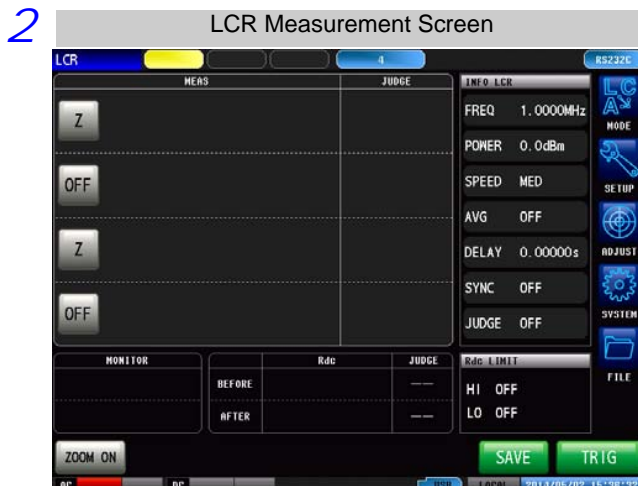

The measurement screen is redisplayed.



# Appendix

## Appendix 1 Checking the USB Virtual COM Port

The instrument's USB interface supports communications-class performance, allowing control operations on par with RS-232C to be performed from a computer. When you connect the instrument to a computer and set its interface to USB, it will be recognized as a virtual COM port on the computer.

Device Manager starts.

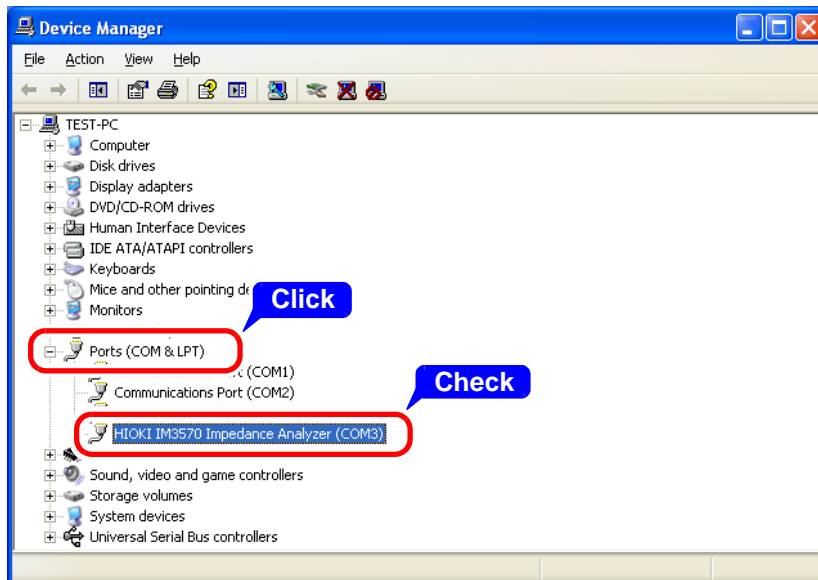

Check the COM number on the right of "HIOKI IM3570 Impedance Analyzer" port in the **[Ports (COM & LPT)]** list.

- When the IM3523, IM3533, IM3533-01, IM3590 and IM7580 : Check the COM number to the right of "HIOKI USB Device" in the **[Ports (COM & LPT)]** list.
- When the IM3570 : Check the COM number to the right of "HIOKI IM3570 Impedance Analyzer" in the **[Ports (COM & LPT)]** list.

### **NOTE**

The procedure to start Device Manager differs depending on the version of the Windows operating system.

For details, refer to Help of the operating system.

# A2

## *Appendix 1 Checking the USB Virtual COM Port*

---

---





- Please visit our website at <http://www.hioki.com> for the following:
  - Regional contact information
  - The latest revisions of instruction manuals and manuals in other languages.
  - Declarations of Conformity for instruments that comply with CE mark requirements.
- All reasonable care has been taken in the production of this manual, but if you find any points which are unclear or in error, please contact your supplier or the International Sales and Marketing Department at Hioki headquarters.
- In the interests of product development, the contents of this manual are subject to revision without prior notice.
- The content of this manual is protected by copyright.  
No reproduction, duplication or modification of the content is permitted without the authorization of Hioki E.E. Corporation.

# **HIOKI**

---

HIOKI E. E. CORPORATION

## **Headquarters**

81 Koizumi, Ueda, Nagano 386-1192, Japan  
TEL +81-268-28-0562 FAX +81-268-28-0568  
E-mail: [os-com@hioki.co.jp](mailto:os-com@hioki.co.jp)  
(International Sales and Marketing Department)

**<http://www.hioki.com/>**

## **HIOKI USA CORPORATION**

E-mail: [hioki@hiokiusa.com](mailto:hioki@hiokiusa.com) <http://www.hiokiusa.com>

## **HIOKI (Shanghai) Sales & Trading Co., Ltd.**

E-mail: [info@hioki.com.cn](mailto:info@hioki.com.cn) <http://www.hioki.cn>

## **HIOKI INDIA PRIVATE LIMITED**

E-mail: [hioki@hioki.in](mailto:hioki@hioki.in) <http://www.hioki.in>

## **HIOKI SINGAPORE PTE. LTD.**

E-mail: [info@hioki.com.sg](mailto:info@hioki.com.sg)

1407