



## Leak Current Measurement - Essential to Electrical Safety

- Uninterrupted polarity switching function dramatically reduces cycle time
- Support for rated currents up to 20 A gives the instrument more than adequate capability for testing products designed to comply with new standards

For medical-use electrical devices and essential to electrical safety

### Compliance with IEC 60601-1:2005 Ed 3.0, JIS T 0601-1:2012

(\*Starting on June 1, 2012, medical electrical equipment sold in the EU must comply). Model ST5540 comply with IEC 60601-1:2005 +A1:2012 (Ed 3.1), and IEC 62353 of 2017

### Compliance with Electrical Appliances and Materials Safety Act,

JIS, IEC, and UL standards for general-use electrical devices



# 2 For Medical Electrical Devices

## ST5540

### Complies with all standards (suitable for use with all networks)

Leak current parameters as defined for medical-use electrical devices include ground leak current, contact current, patient leak current, and patient measurement current. The ST5540 provides a single solution for measuring all of these leak current variants.

### Complies with IEC 60601-1:2005 +A1:2012 (Ed 3.1)

In order to prevent the danger of electric shock, electrical devices use power supplies that are isolated from parts of the device that may come into contact with the body. However, it is impossible to achieve infinite insulation resistance. Some leak current always exists, and its magnitude changes as the insulation degrades over time. The LEAK CURRENT HiTESTER ST5540/ST5541 provides an easy-to-operate solution for measuring leak current in electrical devices, making it eminently suitable for use in an extensive array of applications, ranging from production lines to equipment maintenance and inspections.

**ST5540 compliance**

\*Compliance with medical IEC standards became mandatory in June 2012.  
 \*Medical JIS standards were revised in June 2012.

**(Medical) JIS standards**  
 JIS T0601-1: 2012 supplement 1: 2014, 1999



**(Medical) IEC standards**  
 IEC 60601-1: 2005 +A1: 2012  
 IEC 60601-1: 1988 A2: 1995, etc.

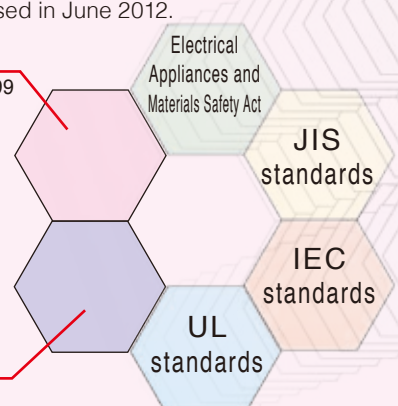

Electrical Appliances and Materials Safety Act

JIS standards

IEC standards

UL standards

### ■ Comparison of ST5540 Functionality

	Measurement mode	Category	Standard compliance
ST5540 Medical-use electrical devices	● Patient leak current (between parts of device that come into contact with patient and ground)	<ul style="list-style-type: none"> <li>• Medical industry (Japan Association for Clinical Engineering Technologists, etc.)</li> <li>• Medical device manufacturers and dealers</li> <li>• Medical device repair and maintenance businesses</li> <li>• Hospitals</li> </ul>	<ul style="list-style-type: none"> <li>• IEC60601-1 (Ed 3.1)</li> <li>• IEC60990</li> <li>• IEC62353</li> </ul>
	● Patient leak current (external SIP/SOP voltage)		
	● Patient leak current (external voltage at specific F-type applied part)		
	● Patient leak current (current resulting from external voltage at parts of device that come into contact with patients)		
	● Patient measurement current		
	● Total patient leak current (between parts of device that come into contact with patient and ground)		
	● Total patient leak current (external SIP/SOP voltage)		
	● Total patient leak current (external voltage at specific F-type applied part)		
	● Total patient leak current (current resulting from external voltage at parts of device that come into contact with patient)		
General-use electrical devices	● Contact current (between device enclosure and lines)	<ul style="list-style-type: none"> <li>• Public agencies</li> <li>• Electric vehicle manufacturers</li> <li>• Manufacturers of general electrical devices</li> <li>• Household appliance industry</li> <li>• Information device industry</li> </ul>	<ul style="list-style-type: none"> <li>• Electrical vehicle standards UL 2231-1 and UL 2231-2</li> <li>• Electrical Appliances and Materials Safety Act</li> <li>• IEC, JIS, and UL standards</li> </ul>
	● Contact current (between device enclosure and ground)		
	● Contact current (between device enclosure and device enclosure)		
	● Ground leak current		
	● Free current measurement		

\*The ST5540 also complies with old standards.

# For Standard- and Regulation-compliance

# ST5541

## Measurement of General-use Electrical Devices

ST5541 provides standard support for standard-compliant networks (excluding medical-use electrical devices).

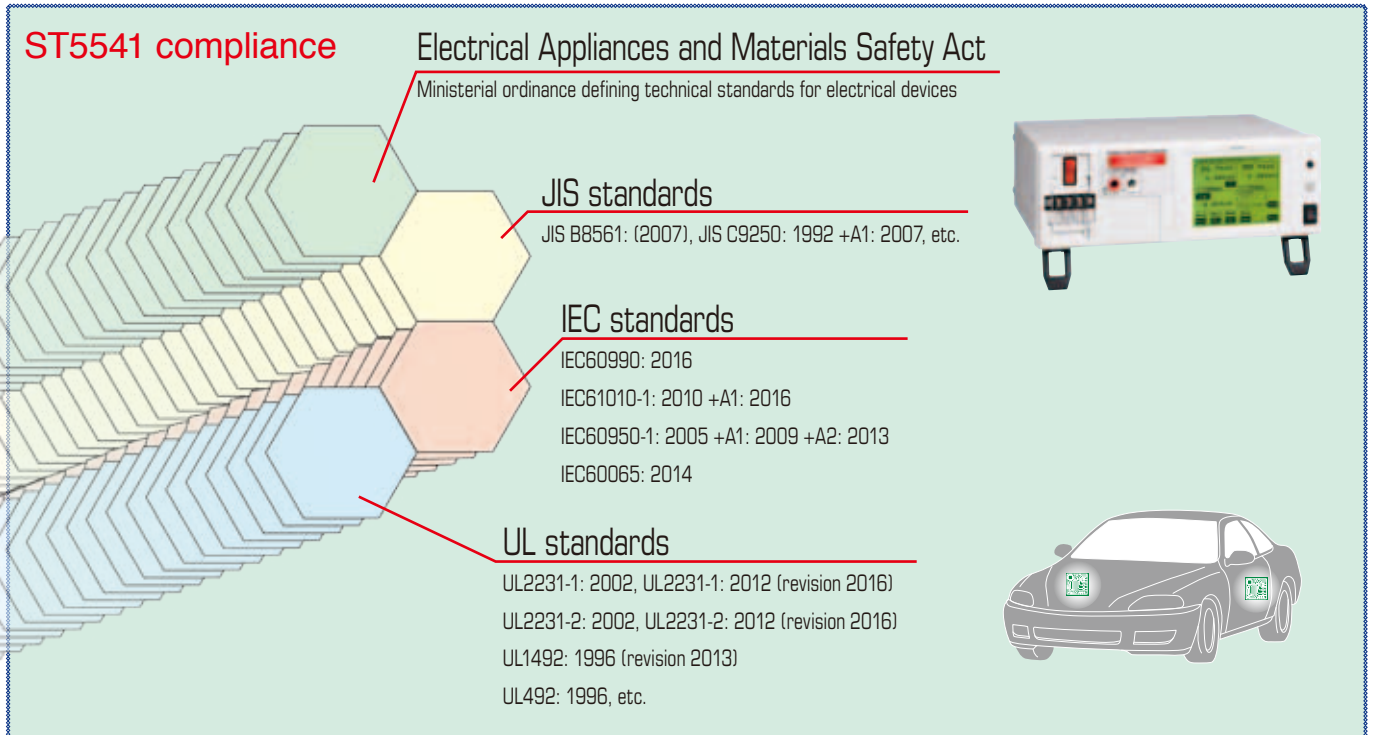

There are various standards in place concerning networks (body simulated resistance), and a standard-compliant network is required in order to make measurements.

### ■ Comparison of ST5541 Functionality

	Measurement mode	Category	Standard compliance
ST5541 General-use electrical devices	<ul style="list-style-type: none"> <li>● Contact current (between device enclosure and lines)</li> <li>● Contact current (between device enclosure and ground)</li> <li>● Contact current (between device enclosure and device enclosure)</li> <li>● Ground leak current</li> <li>● Free current measurement</li> </ul>	<ul style="list-style-type: none"> <li>• Public agencies</li> <li>• Electric vehicle manufacturers</li> <li>• Manufacturers of general electrical devices</li> <li>• Household appliance industry</li> <li>• Information device industry</li> </ul>	<ul style="list-style-type: none"> <li>• Electrical vehicle standards UL 2231-1 and UL 2231-2</li> <li>• Electrical Appliances and Materials Safety Act</li> <li>• IEC, JIS, and UL standards</li> </ul>

## A single, robust solution for leak current measurement



# ST5540/ST5541 Features

## ■ Uninterrupted polarity switching function

The ability to conduct tests without turning off the power when switching the power supply polarity dramatically reduces cycle times. The ST5540/ST5541 can switch polarity without stopping the supply of power to the device under measurement. Old models require that the device under measurement be turned off and then back on again when switching polarity, but the ST5540 and ST5541 let you progress smoothly to the next testing process.

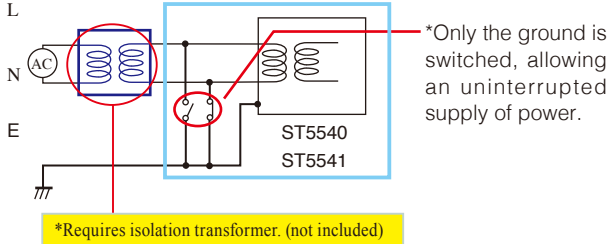

## ■ Improved test reliability

### Blown fuse check function

When measurement starts, the instrument checks for unintentional probe misalignment using of a preconfigured lower limit setting.

## ■ Safety conductor current measurement function

The ST5540/ST5541 can perform safety conductor current measurement as defined in standards such as IEC 60990 and IEC 60950-1.

## ■ Automatic measurement functionality

Simple operation allows you to switch power supply polarity and automatically make measurements with the target device in the normal and single-fault states, displaying the peak values. You can also set the measurement time and wait time. These capabilities help reduce operation time.

## ■ Circuit breaker for device under measurement

The instrument's workbench-type design features a terminal block and a circuit breaker on the front panel, making it ideal for embedding in test lines and simplifying connectivity with the device being measured, even while rack-mounted.

## ■ 110% voltage application jack

The instrument's 110% voltage application jack, which is used during testing of medical devices, outputs the target device line power supply voltage as-is. The polarity can be switched (ST5540 only).



## ■ Save measurement data for 100 devices

Measurement data (peak values) can be stored in the instrument's built-in memory. Saved data can be checked on the stored data reference screen after measurement is complete. Data can be stored for up to 100 test targets, with each target being identified by a registered device name and control number. Additionally, the instrument can store a maximum of 2,000 peak value data points. Together, these capabilities eliminate the need to jot down measured values at the measurement site.

## ■ Simple, interactive operation

The ST5540/ST5541 uses a touch panel that lets you configure settings by touching selections in response to information displayed on the panel, keeping operation simple.

## ■ Ability to store up to 30 sets of measurement conditions

The instrument can save and load up to 30 sets of measurement conditions, allowing you to immediately switch between conditions.

### Peak value display

Displays the type of power supply fault and the peak value for the leak current, which varies with target device operation.

Power supply polarity/device status/measurement current

### Allowable value

The maximum allowable value under the standard in question is automatically set. Settings can also be changed as desired by the user.

Current measured value

Judgment result based on set allowable value

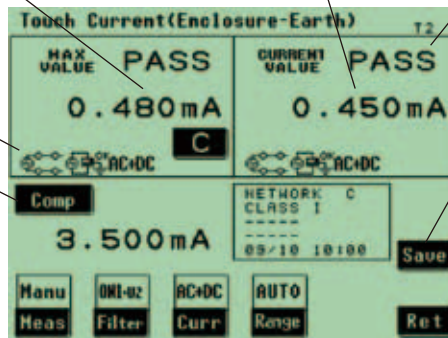

### Data storage

Measurement data:  
For up to 100 target devices  
Measurement conditions:  
Up to 30 sets

[Measurement screen]

# Expandability for the Future

## ■ All the switch terminals needed for standard-compliant measurement

The ST5540/ST5541 provides the terminals needed to perform leak current measurement in compliance with IEC 60601-1 and JIS T0601-1, eliminating the need for the user to provide external switches.

### Connection terminals

- S10 terminal** : Switch for connecting a function ground terminal to the measurement power supply system's ground point  
Allows connectivity to ground to be configured during leak current measurement.
- S12 terminal** : Switch for connecting the parts of device that come into contact with the patient to the measurement power supply circuit's ground point  
Allows connectivity to ground to be configured during leak current measurement.
- S13 terminal** : Switch for connecting contactable metallic parts that are not protectively grounded to the ground line  
Allows connectivity to ground to be configured during leak current measurement.
- E terminal** : Connected to the E (earth) LINE IN terminal.  
This terminal is always connected and cannot be configured.

\*S10, S12, S13, and E are available on the ST5540 only.

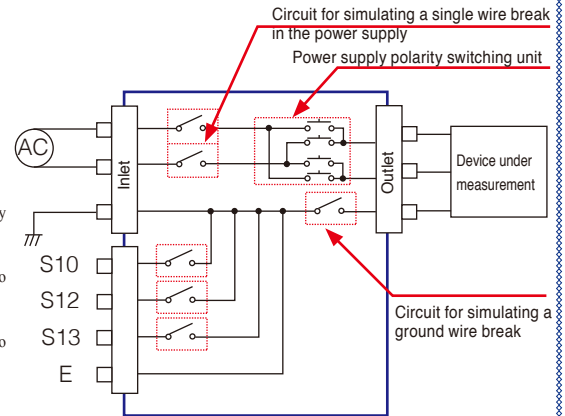

ST5540 internal circuitry

## ■ Standard USB interface

The ST5540/ST5541's standard USB interface simplifies automatic testing on manufacturing lines and in similar installations.

- 1: Connectivity not supported for USB memory. Data communications only.
- 2: Cannot be used while an RS-232C connection is active.

## ■ Standard RS-232C port

The ST5540/ST5541's standard RS-232C port can be used to control the instrument from a computer and to print data using the 9442 printer (option).

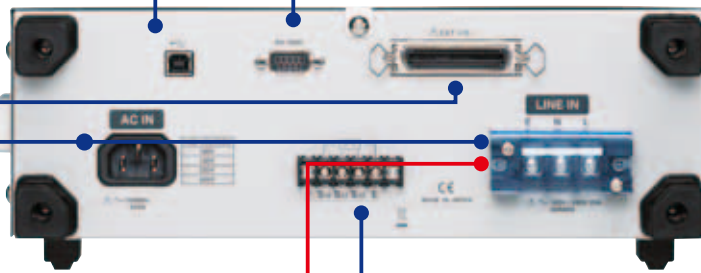

## ■ Separation of the instrument's power supply and target device lines

The instrument's power supply and target device line power supply are separated, helping prevent damage due to the inadvertent input of an incorrect supply voltage. There's no need to change the ST5540/ST5541's supply voltage, even if the target device's supply voltages changes.

## ■ Support for rated currents of up to 20 A

The ST5540/ST5541 supports currents of up to 20 A and voltages of up to 250 V. Its ability to accommodate large currents allows it to be used with a more extensive range of target products, including devices from new fields such as electric vehicles and household appliances.

( Line power supply terminal block for device under test )

## ■ External control via EXT I/O

Start of measurement and loading of measurement conditions can be controlled from an external source. Additionally, judgment results, test signals, and other data can be output, making it possible to use the instrument to develop an automated line.

Input signals	Active-low input
Max. applied voltage	EXT.DCV terminal input voltage
High level	EXT.DCV terminal input voltage or open
Low level	0.3 VDC or less
Output signal	Open collector output
Max. load voltage	24 VDC (when not using the EXT.DCV terminal)
Max. output current	60 mA DC per signal (low level)

In addition to outputting judgment results for each measurement item, the instrument also provides T-FAIL output, which is generated continuously once a FAIL result is encountered during automatic testing.

### EXT I/O description

- Output
  - TEST : Outputs low continuously during automatic measurement.
  - MEAS : Outputs the measurement count automatic measurement and measurement of multiple items.
  - PASS : Outputs the PASS judgment result for each measurement item.
  - FAIL : Outputs the FAIL judgment result for each measurement item.
  - LOW : Generates continuous output once a low signal is encountered during automatic testing.
  - T-FAIL : Generates continuous output once a FAIL result is encountered during automatic testing.
  - INT.DCV : Generates internal 5 VDC output (not isolated from internal circuitry).
  - INT.GND : Generates internal GND output (same as the case ground level).
- Input
  - START : Starts automatic measurement at low.
  - STOP : Forcibly terminates measurement at low.
  - LOAD (0 to 4) : Loads saved panels (30 panels).
  - EXT.DCV : Accepts external power supply input from 5 VDC to 24 VDC.
  - EXT.COM : Accepts external COM input.
  - KEYLOCK : Disables switches other than the start switch.

# ST5540/ST5541 Specifications (Accuracy guaranteed for 1 year, Post-adjustment accuracy guaranteed for 1 year)

## ■ General specifications

Display	320 × 240 dot matrix LCD (with backlight)
Control	6 × 6 matrix touch panel
Operating temperature and humidity range	0°C to 40°C, 80% RH or less (non-condensing)
Storage temperature and humidity range	-10°C to 50°C, 80% RH or less (non-condensing)
Temperature and humidity range within which accuracy is guaranteed	23°C ±5°C, 80% RH or less (non-condensing)
Guaranteed accuracy period	1 year
Operating location	Indoor use at an elevation not exceeding 2,000 m
Instrument power supply	100/120/220/240 VAC, as specified by customer Rated power supply frequency: 50/60 Hz Rated power: 30 VA
Line power supply for device being measured and outlet	Rated supply voltage: 100 to 250 VAC Rated power supply frequency: 50/60 Hz Rated current: Input, terminal block: 20 A Output, terminal block: 20 A

Outlet max. allowable leak current	50 mA
Dielectric strength	Between power supply terminals and protective ground: 1.39 kVAC (5 mA), 15 sec Between measurement terminals and power supply terminals: 2.30 kVAC (10 mA), 15 sec Between measurement terminals and control circuit: 2.30 kVAC (10 mA), 15 sec
Standard compliance	EMC: EN 61326 Safety: EN 61010
Conductive RF	3% f.s. or less at 3 V
Magnetic field effects	(Representative value when conducting measurements in the AC 500 $\mu$ A range)
Accessories	ST5540: One set of L2200 test leads (one red, one black) + one red L2200 test lead ST5541: One set of L2200 test leads (one red, one black) Enclosure Probe 9195 × 1, CD-ROM × 1 (USB Driver) power cord × 3 (1 for instrument and 2 for measuring instrument line supply use) spare fuse × 1 (250 V F 50 mA, measurement use)
Dimensions	Approx. 320 (W) × 110 (H) × 253 (D) mm
Mass	Approx. 4.5 kg

## ■ Leak current measurement unit

Measurement current	DC / AC / AC+DC / AC peak
Allowable measurement current	Max. 50 mA (DC / AC / AC+DC mode) Max. 75 mA (AC peak mode)
Measurement ranges	DC / AC / AC+DC mode: 50 $\mu$ A/500 $\mu$ A/5 mA/50 mA AC peak mode: 500 $\mu$ A/1 mA/10 mA/75 mA
Range switching	AUTO/HOLD
Trigger method	Manual: Generates trigger automatically internally, free-run measurement. Automatic: Starts measurement based on external start signal.
Measurement terminals	T1 terminal, T2 terminal (with built-in fuse holder), T3 terminal (110% voltage application terminal: ST5540 only) (*Step-up isolation transformer required for 110% application.)
Measurement methods	Measurement of voltage drop across body simulated resistance points Calculation and display of current values True rms measurement Measurement unit floats relative to instrument ground.
A/D conversion method	$\Delta\Sigma$ method (20-bit)
Instrument-to-ground capacitance	200 pF or less (between T1/T2 terminal and case ground)
Input resistance	1 M $\Omega$ ±1% (single-end input) Not including voltage measurement unit, body simulated resistance (current detection circuit)
Input capacitance	150 pF or less (between T1 and T2 terminals) (f = 100 kHz, isolated network circuit, including cables)

CMRR (between T1 and T2 terminals and case)	60 dB or greater at 60 Hz / 60 dB or greater at 10 kHz 40 dB or greater at 100 kHz / 40 dB or greater at 1 MHz (Isolated from network circuit with fuse shorted)
---	--

## ■ Network (body simulated resistance)

● Medical-use electrical devices: Network B (ST5540 only)	Basic measurement element: 1 k $\Omega$ Filter: 10 k $\Omega$ + 15 nF
● Electrical Appliances and Materials Safety Act: Network A	Basic measurement element: 1 k $\Omega$ Filter: 10 k $\Omega$ + 11.22 nF + 579 $\Omega$
● IEC 60990: Network C	Basic measurement element: 1.5 k $\Omega$ + 500 $\Omega$ Filter 1: 10 k $\Omega$ + 22 nF Filter 2: 10 k $\Omega$ + (20 k $\Omega$ + 6.2 nF) // 9.1 nF
● UL: Network D	Basic measurement element: 1.5 k $\Omega$ // 0.15 $\mu$ F
● General-purpose 1: Network E	Basic measurement element: 1 k $\Omega$
● General-purpose 2: Network F	Basic measurement element: 2 k $\Omega$
● IEC 61010-1: Network G	Basic measurement element: 375 $\Omega$ + 500 $\Omega$ Filter: 375 $\Omega$ // 0.22 $\mu$ F + 500 $\Omega$
● Safety conductor current	Basic measurement element (35 $\Omega$ )

## ■ Accuracy (current measurement unit)

- Temperature and humidity range within which accuracy is guaranteed: 23°C ±5°C, 80% RH or less, non-condensing
- Temperature coefficient: Add 0.1 × basic accuracy × (T-23) for operating temperature T (°C) ■ Warm-up time: 20 min
- The range within which accuracy is guaranteed when using Network D and Network F (full-scale value for each range) is approximately 1/1.5 and 1/2, respectively.
- Calculated value when the voltage is detected across both ends of a network consisting of non-inductive resistance with a theoretical value of 1 k $\Omega$
- The following accuracy values also apply when using voltmeter mode.

### ● Measurement mode: AC\*1 / AC+DC

Range	Guaranteed accuracy range	Resolution	Accuracy		
			0.1 Hz ≤ f < 15 Hz*2	DC ≤ f ≤ 100 kHz	100 kHz < f ≤ 1 MHz
50.00mA	From 4 mA	10 $\mu$ A			
5.000mA	From 400 $\mu$ A	1 $\mu$ A	±(4.0%rdg.+10dgt.)	±(2.0%rdg.+6dgt.)	±(2.0%rdg.+10dgt.)
500.0 $\mu$ A	From 40 $\mu$ A	0.1 $\mu$ A			
50.00 $\mu$ A	From 4 $\mu$ A	0.01 $\mu$ A	±4.0%f.s.	±2.0%f.s.	±2.0%f.s.

### ● Measurement: mode DC

Range	Guaranteed accuracy range	Resolution	Accuracy
50.00mA	From 4 mA	10 $\mu$ A	
5.000mA	From 400 $\mu$ A	1 $\mu$ A	±(2.0%rdg.+6dgt.)
500.0 $\mu$ A	From 40 $\mu$ A	0.1 $\mu$ A	
50.00 $\mu$ A	From 4 $\mu$ A	0.01 $\mu$ A	±2.0%f.s.

### ● Measurement mode: AC peak\*3

Range	Guaranteed accuracy range	Resolution	Accuracy		
			15 Hz ≤ f ≤ 10 kHz	10 kHz < f ≤ 100 kHz	100 kHz < f ≤ 1 MHz
75.0mA	From 8 mA	100 $\mu$ A			
10.00mA	From 0.8 mA	10 $\mu$ A	±(2.0%rdg.+6dgt.)	±5.0%f.s.	±15.0%f.s.
1.000mA	From 100 $\mu$ A	1 $\mu$ A	±2.5%f.s.		
500.0 $\mu$ A	From 40 $\mu$ A	0.1 $\mu$ A	±2.5%f.s.		±20.0%f.s.

### ● Voltage monitor accuracy

Range	Guaranteed accuracy range	Resolution	Accuracy
300.0 V	85 V*4 to 275V	0.1 V	±(5.0%rdg.+10dgt.)

### ● Current monitor accuracy (Measurement methods: Average value response, rms calculation)

Range	Guaranteed accuracy range	Resolution	Accuracy
300.0 V	From 85 V*5	0.1 V	±(2.0%rdg.+5dgt.)

## ■ Safety conductor current accuracy

### ● Measurement mode: DC / AC\*4 / AC+DC

Range	Guaranteed accuracy range	Resolution	Accuracy	
			DC, 15 Hz ≤ f ≤ 100 kHz	100 kHz < f ≤ 1 MHz
50.00 mA	12.00 mA to 50.00 mA	10 $\mu$ A	±(2.0%rdg.+6dgt.)	±(5.0%rdg.+20dgt.)
10.00mA	1.30 mA to 13.00 mA	10 $\mu$ A	±(2.0%rdg.+6dgt.)	±(5.0%rdg.+20dgt.)

### ● Measurement mode: AC peak

Range	Guaranteed accuracy range	Resolution	Accuracy		
			15 Hz ≤ f ≤ 10 kHz	1 kHz < f ≤ 100 kHz	100 kHz < f ≤ 1 MHz
75.0 mA	12.0 mA to 75.0 mA	100 $\mu$ A	±(2.0%rdg.+6dgt.)	±5.0%f.s.	±25.0%f.s.
10.00 mA	1.30 mA to 13.00 mA	10 $\mu$ A	±2.5%f.s.	±5.0%f.s.	±25.0%f.s.

\*1 When using AC measurement mode, the high-pass filter frequency characteristics (fc = 4 Hz) are added.

\*2 ST5540 only.

\*3 Setting not available with Network A, B, or C (when filter off).

\*4 Voltages of less than 80 V are displayed as "Less than 80 V."

\*5 Currents of less than 0.5 A are displayed as "Less than 0.5 A."

# 3157

## For JIS T 1022:2006 Measurement at Hospitals Electrical devices

Main ground line

Medical ground center

Ground branch line

Ground branch line

Medical outlet

Medical room

Medical ground terminal

Grounding electrode

**■ Measuring between the grounding center and grounding terminal**

Verify that the electrical resistance between the medical outlet's grounding electrode connector or medical ground terminal and medical ground center is less than or equal to  $0.1 \Omega$  by applying a current of approximately 25 A with an AC current with a no-load voltage of 6 V or less and measuring the resistance using the voltage drop method.

\* This measurement requires an extension cable (available separately). The extension cable is a special-order item; please contact your HIOKI distributor for more information.

## Combination of Instruments for Leak Current Testing and Safety Conductor Testing

The following are key parts of any safety inspection of electrical equipment:

- Leak current test: Measure with the ST5540 and ST5541.
- Safety conductor test (also known as a ground line resistance test or ground conductor test): Measure with the 3157.

The 3157 can also be used for conducting measurements under the JIS T 1022:2006 safety standard for hospital electrical equipment.

### AC GROUNDING HiTESTER 3157 Protective Ground Tester Indispensable for Standards Certification



GP-IB option

RS-232C option

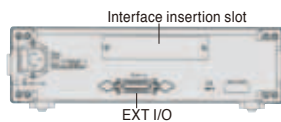

#### Standard compliance (examples)

- IEC 60065
- IEC 60335-1
- IEC 60601-1
- IEC 60950-1
- IEC 61010-1
- JIS-C1010-1
- Electrical Appliances and Materials Safety Act
- UL (various applicable standards)

#### Model : AC GROUNDING HiTESTER 3157

Model No. (Order Code) (Note)

3157-01 (100-120 / 200-240 VAC switching)

Note: This instrument is not capable of performing measurement by itself. Please purchase two Current probe 9296 units or one Current probe 9296 and one Current apply probe 9297, depending on your measurement application.

- Easily perform protective continuity testing in compliance with international safety standards and laws
  - 1) Protective continuity resistance measurement for medical devices and general electrical devices
  - 2) Ground connectivity testing when installing electrical machine tools and distribution panels
  - 3) Testing of protective grounding and isopotential grounding work for medical equipment
  - 4) Evaluation of contact status using large currents
- Feedback control system that is capable of applying a stable current even with a fluctuating load
- Soft-start function that checks the connection to the device under test before applying the current

\*When using the Printer 9442, also purchase the RS-232C Interface 9593-02

Printer options	<p><b>PRINTER 9442</b> For printing numerical values 112 mm (4.41 in) paper width</p>	<p><b>AC ADAPTER 9443-02</b> For the Printer 9442, EU type</p>	<p><b>CONNECTION CABLE 9446</b> For the Printer 9442, 25 pin -9 pin, 1.5 m (4.92 ft) length</p>	<p><b>RECORDING PAPER 1196</b> For the Printer 9442, 112 mm (4.41 in) x 25 m (82.03 ft), 10 rolls/set</p>
-----------------	---	--	---	---

\*The 3157-01's handshake function cannot be used with the RS-232C Cable 9638

Input/Output cards	<p><b>REMOTE CONTROL BOX (SINGLE) 9613</b> For Start/Stop control, 1.5m (4.92 ft) cord length</p>	<p><b>REMOTE CONTROL BOX (DUAL) 9614</b> For Start/Stop control, 1.5m (4.92 ft) cord length</p>	<p><b>CURRENT PROBE 9296</b> Alligator clip, 1.45m (4.76 ft) length</p>	<p><b>CURRENT APPLY PROBE 9297</b> With switch, 1.48m (4.86 ft) length</p>	<p><b>GP-IB CONNECTOR CABLE 9151-02</b> 2 m (6.56 ft) length</p>	<p><b>GP-IB INTERFACE 9518-02</b> For the 3157-01, built in type</p> <p><b>RS-232C INTERFACE 9593-02</b> For the 3157-01, built in type, not CE marked</p>
--------------------	---	---	---	--	--	--

Other

**SAFETY TEST DATA MANAGEMENT SOFTWARE 9267**  
For PC control application software

# PRINTER 9442

Convenience

The optional PRINTER 9442 can be used to print data via the instrument's RS-232C interface, providing a convenient way to attach a hard copy of test data.



Print method: Thermal serial dot  
 Paper width/print speed: 112 mm/52.5 cps  
 Power supply: AC ADAPTER 9443 or included nickel-metal-hydrate battery (good for approx. 3,000 lines of print when fully charged with the 9443 adapter)  
 Dimensions: Approx. 160 (W) × 66.5 (H) × 170 (D) mm  
 Mass: Approx. 580 g

## ■ Printing saved data

Saved measurement data is displayed (pressing the print key within the same data unit causes all data in the data unit to be printed).

## Printable data (printed data can be selected from the following)

- Measurement date
- Instrument name
- Control number
- Class (applied part)
- Network
- Measurement mode
- Filter settings
- Allowable values
- Maximum value
- Judgment results
- Measurement current (AC, DC, AC+DC, AC peak)
- Power supply polarity (normal, reversed)
- Instrument status (normal, ground line broken)

\*CONNECTION CABLE 9444 and AC ADAPTER 9443 are required in order to connect the 9442 printer.

## Example printout

```

Date → Date :2010/09/10
Instrument name → Name :ELECTRIC-123
Control number → No. :123456789123
Connection class and applied part → Stat :CLASS1-B
Network → Network :B2
Measurement mode → Mode :TOUCH1
Filter → Filter :ON
Allowable value (upper limit) → Allowable(Up):500.0uA
Allowable value (lower limit) → Allowable(Lo):25.0uA
Maximum value → Max Value:48.24uA
Judgment result → Judgement:PASS
Polarity → Polarity :REVERSE
Status → Condition:EARTH
Other Condition:NAPPLY
S10:ON
S12:ON
S13:OFF
    
```

Safety standards

## Isolation transformer

Standards require use of an isolation transformer when measuring medical-use electrical devices. Please purchase a transformer with the necessary rated capacity.

### ■ Leak current tester supplies

\*Some standards require use of an isolation transformer. Product inquiries should be directed to:  
 Isolation transformer model numbers  
 100 to 110 V (Japan): HSW-2KSP  
 240 to 264 V (overseas): HSW-5KSP  
 For more information: Tokyo Rikosha Co., Ltd.  
 Phone: +81-48-856-3851 (reception)  
<http://www.tokyorikosha.co.jp>

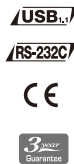

Model : LEAK CURRENT HITESTER ST5540

Model No. (Order Code) (Note)  
**ST5540** (For medical-use and electrical devices)



Model : LEAK CURRENT HITESTER ST5541

Model No. (Order Code) (Note)  
**ST5541** (For electrical devices)

## ST5540, ST5541 shared options

\*The L2200 and the 9195 are bundled

**Test probes**

**TEST LEAD L2200**  
 70 cm (2.30ft) length, detachable large alligator clips or needle tips are bundled, CAT IV 600V, CAT III 1000V

**ENCLOSURE PROBE 9195**  
 For the ST5540 series, 3156/3155

**Printer options**

**PRINTER 9442**  
 For printing numerical values 112 mm (4.41 in) paper width

**AC ADAPTER 9443-02**  
 For the Printer 9442, EU type

**CONNECTION CABLE 9444**  
 For the Printer 9442, 9 pin - 9 pin, 1.5 m (4.92 ft) length

**RECORDING PAPER 1196**  
 For the Printer 9442, 112 mm (4.41 in) × 25 m (82.03 ft), 10 rolls/set

**PC communication**

**RS-232C CABLE 9637**  
 For the PC, 9pin - 9pin, cross, 1.8m (5.91 ft) length

**RS-232C CABLE 9638**  
 For the PC, 9pin - 25pin, cross, 1.8m (5.91 ft) length

Note: Company names and Product names appearing in this catalog are trademarks or registered trademarks of various companies.

# HIOKI

HIOKI E. E. CORPORATION

HEADQUARTERS  
 81 Koizumi  
 Ueda, Nagano 386-1192 Japan  
[www.hioki.com](http://www.hioki.com)

HIOKI USA CORPORATION  
 TEL +1-609-409-9109 FAX +1-609-409-9108  
[hioki@hiokiusa.com](mailto:hioki@hiokiusa.com) / [www.hiokiusa.com](http://www.hiokiusa.com)

HIOKI (Shanghai) SALES & TRADING CO., LTD.  
 TEL +86-21-6391-0090/0092 FAX +86-21-6391-0360  
[info@hioki.com.cn](mailto:info@hioki.com.cn) / [www.hioki.cn](http://www.hioki.cn)

DISTRIBUTED BY

HIOKI SINGAPORE PTE. LTD.  
 TEL +65-6634-7677 FAX +65-6634-7477  
[info-sg@hioki.com.sg](mailto:info-sg@hioki.com.sg) / [www.hioki.com.sg](http://www.hioki.com.sg)

HIOKI KOREA CO., LTD.  
 TEL +82-2-2183-8847 FAX +82-2-2183-3360  
[info-kr@hioki.co.jp](mailto:info-kr@hioki.co.jp) / [www.hiokikorea.com](http://www.hiokikorea.com)

HIOKI EUROPE GmbH  
 TEL +49-6173-31856-0 FAX +49-6173-31856-25  
[hioki@hioki.eu](mailto:hioki@hioki.eu) / [www.hioki.com](http://www.hioki.com)