

MR8870-20

Instruction Manual

MEMORY HiCORDER



EN



Contents

Introduction	1
Confirming Package Contents	2
Safety Information	3
Operating Precautions	6

Chapter 1

Overview	11
-----------------------	-----------

1.1 Product Overview and Features	11
1.2 Measurement Flow	12
1.3 Names and Functions of Parts	15
1.4 Screen Configurations	17
1.5 Basic Operation	19

Chapter 2

Measurement Preparations	23
---------------------------------------	-----------

2.1 Using the Battery Pack (Option)	24
■ Install the Battery Pack	27
■ Charge the Battery Pack	27
2.2 Connecting the AC Adapter	28
2.3 Connecting Measurement Cables to the Memory HiCorder	29
■ Connecting Connection Cords (to record voltage waveforms)	31
■ Connecting a Clamp Sensor (to record current waveforms)	31
■ Connecting the Logic Probe (to record logic signals)	32
2.4 Attaching the Carrying Strap	33
2.5 Turning the Power On and Off	34
2.6 Zero Adjustment	35

Chapter 3	
Setting before Measurement	37
3.1 Pre-Operation Inspection	37
3.2 Operating Flow Overview	38
3.3 Automatic Configuration of Measurement Settings (Auto Range)	42
3.4 Measurement Configuration 1 (Horizontal Axis Settings)	44
■ Select a Timebase	44
■ Setting Recording Length (no. of divisions)	45
■ Setting Display Zoom (as needed)	45
3.5 Measurement Configuration 2 (Setting Recording Criteria)	46
■ Setting the Trigger Mode	46
3.6 Measurement Configuration 3 (Analog Channel Settings)	47
■ Setting the Voltage Axis (Vertical Axis) Range	47
■ Selecting Waveform Display Color (as needed)	47
■ Setting the Zero Position (as needed)	48
■ Selecting the Input Coupling Method (as needed)	48
■ Zooming the Vertical Axis (as needed)	49
■ Selecting a Low-Pass Filter (L.P.F.) (as needed)	49
■ Converting Units (Scaling function)	50
3.7 Measurement Configuration 4 (Logic Channel Settings)	51
■ Setting Logic Channel Display Colors (as needed)	51
■ Setting Logic Channel Display Positions	51
3.8 Entering Comments	52
Chapter 4	
Making Trigger Settings	55
4.1 Setting Recording Criteria	55
■ Setting Combining Logic (AND/OR) for Multiple Trigger Sources	56
■ Setting the Trigger Start Point (Pre-Trigger)	56
4.2 Triggering by Analog Signals	57
■ Selecting an Analog Trigger Type	58

■ Selecting a Trigger Filter	59
■ Selecting Rising or Falling (Slope) of the Input Signal	59
■ Setting the Signal Threshold Level (Trigger Level)	59
■ Setting Lower and Upper Trigger Thresholds	60
■ Selecting Measurement Frequency	60
4.3 Logic Channel Trigger Settings	61
■ Configuring Logical (AND/OR) Trigger Criteria	61
■ Setting a Trigger Pattern	62
■ Setting a Trigger Filter	62
4.4 Triggering Manually (Manual Trigger)	62

Chapter 5

Waveform Analysis _____ 63

5.1 Viewing Waveforms	63
■ Scrolling Waveforms	64
■ Verifying Waveform Display Position	64
■ Magnifying and Compressing Horizontally (Time Axis)	64
■ Viewing Any Waveform Location (Jump Function)	65
5.2 Viewing Measurement Values	66
■ Displaying Gauges	66
■ Displaying Cursor Values	66
■ Specifying a Waveform Time Span	68
■ Viewing Input Signals as Numerical Values (Numerical Value Display Function)	69

Chapter 6

Saving & Loading Data _____ 71

6.1 About Saving and Loading Data	71
6.2 Using a CF Card	74
■ CF Card Insertion & Removal	75
■ Formatting a CF Card	76
6.3 Saving Data	77
■ Automatic Saving	78
■ Enabling Delete-and-save Operation	79
■ Selecting the Manual Saving Method [Quick Save]/[Select & Save]	80
■ Saving Waveform Data (with the SAVE Key)	81
■ Capturing a Screen Image (With the SAVE Key)	82

- Saving Numerical Calculation Results
(With the SAVE Key) 83
- Saving Setting Configurations 84
- 6.4 Loading Data on the Memory HiCorder 85**
 - Loading a Setting Configuration 85
 - Load the setting configuration data automatically 86
 - Loading Waveform Data and Screen Images 87
- 6.5 Data Management 88**
 - Viewing Folder Contents and the Parent Folder 88
 - Deleting Data 89
 - Renaming Files and Folders 89
 - Sorting Files 90
- 6.6 Transferring Data to a Computer 91**

Chapter 7

Numerical Calculations _____ 93

- 7.1 Calculation Methods 93**
 - Auto Calculation 94
 - Manual Calculation 95
 - Apply Calculations to a Specific Time Span
(Manual Calculation Only) 96
- 7.2 Numerical Value Calculation Expressions 97**

Chapter 8

System Environment Settings _____ 99

- 8.1 Screen and Key Operation Settings 100**
 - Using the Auto-Resume Function
(Resume After Power Restoration) 100
 - Adjust backlight brightness 100
 - Enabling and Disabling the Backlight Saver 101
 - Selecting Black or White Screen Background 101
 - Enabling or Disabling the Beeper 101
- 8.2 Making System Settings 102**
 - Setting the Date and Time 102
 - Initializing the Memory HiCorder (System Reset) 103
 - Selecting the Display Language 103
 - Self-Test 104

Chapter 9	
External Control _____	105
9.1 Connecting to the External Control	
Terminals	105
9.2 External Trigger Input	107
9.3 External Signal Output (Trigger Output)	108
9.4 Synchronous Measurements with Multiple	
Instruments	109
Chapter 10	
Specifications _____	111
Chapter 11	
Maintenance and Service _____	127
11.1 Troubleshooting	127
11.2 Cleaning	130
11.3 Disposing of the Instrument	131
Appendix _____	A1
Appendix 1 Error Messages and Remedial Actions	A1
Appendix 2 File Naming	A5
Appendix 3 Wave Processor Application Program	A6
Appendix 4 List of Default Settings	A9
Appendix 5 Supplemental Technical Information.....	A11
Appendix 6 Options	A13
Appendix 7 Easy setting for RMS recorder mode	A15
Appendix 8 Executing zero adjustment	
for Model CT969x series and Model CT6590A18	
Appendix 9 To 8870-20 Users	
(Firmware Ver. 1.08 or Earlier).....	A19
Appendix 10 To MR8870-20 Users	
(Firmware Ver. 2.03 or Earlier).....	A21
Index _____	Index 1

Introduction

Thank you for purchasing the HIOKI "Model MR8870-20 Memory HiCorder." To obtain maximum performance from the instrument, please read this manual carefully, and keep it handy for future reference.

The MR8870-20 offers two modes: memory recorder mode and RMS recorder mode. This manual primarily describes operation of the instrument in memory recorder mode. For more information about RMS recorder mode, see the included Measurement Guide (RMS Recorder).

An optional clamp-on probe is required for current measurement with the Memory HiCorder. In this manual, all models of these probes are collectively referred to as "clamp sensors." For details, refer to the instruction manual of the particular clamp sensor to be used.

Registered trademarks

- Windows is a registered trademark of Microsoft Corporation in the United States and/or other countries.
 - CompactFlash is a registered trademark of Sandisk Corporation (USA).
-

Confirming Package Contents

When you receive the instrument, inspect it carefully to ensure that no damage occurred during shipping. In particular, check the accessories, panel switches, and connectors. If damage is evident, or if it fails to operate according to the specifications, contact your dealer or Hioki representative.

Confirm that these contents are provided.

**Model MR8870-20
Memory HiCorder**.....1

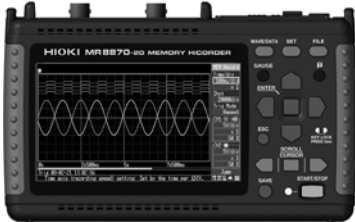

**Instruction Manual
(This document)**.....1



**Measurement Guide
(Memory Recorder)**.....1



Model Z1005 AC Adapter1
with supplied power cord

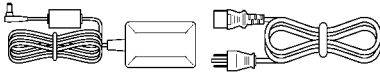

(p. 28)

**Measurement Guide
(RMS Recorder)**1



USB Cable1

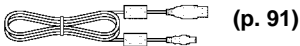

(p. 91)

Strap1

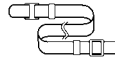

(p. 33)

Model 9809 Protection Sheet.....1

Please stick this over the screen to protect it from any damage.

**Dedicated Wave Processor
Application Program for the
8870 (CD)**.....1



The latest version can be downloaded from our web site.

For information about options:(p. A13)

Contact your dealer or Hioki representative for details.

Safety Information



This instrument is designed to comply with IEC 61010 Safety Standards, and has been thoroughly tested for safety prior to shipment. However, mishandling during use could result in injury or death, as well as damage to the instrument. However, using the instrument in a way not described in this manual may negate the provided safety features.



Be certain that you understand the instructions and precautions in the manual before use. We disclaim any responsibility for accidents or injuries not resulting directly from instrument defects.

This manual contains information and warnings essential for safe operation of the instrument and for maintaining it in safe operating condition. Before using it, be sure to carefully read the following safety precautions.

Safety Symbols



In the manual, the  symbol indicates particularly important information that the user should read before using the instrument.

The  symbol printed on the instrument indicates that the user should refer to a corresponding topic in the manual (marked with the ) before using the relevant function.



Indicates a double-insulated device.



Indicates DC (Direct Current).



Indicates a grounding terminal.



Indicates the ON side of the power switch.



Indicates the OFF side of the power switch.

The following symbols in this manual indicate the relative importance of cautions and warnings.



Indicates that incorrect operation presents an extreme hazard that could result in serious injury or death to the user.



Indicates that incorrect operation presents a significant hazard that could result in serious injury or death to the user.



Indicates that incorrect operation presents a possibility of injury to the user or damage to the instrument.



Indicates advisory items related to performance or correct operation of the instrument.

Symbols for Various Standards

Indicates that the product conforms to regulations set out by the EC Directive.



Ni-MH

This is a recycle mark established under the Resource Recycling Promotion Law (only for Japan).



Indicates the Waste Electrical and Electronic Equipment Directive (WEEE Directive) in EU member states.

Other Symbols

Indicates the prohibited action.

(p. #)

Indicates the location of reference information.

*

Indicates that descriptive information is provided below.

[]

The names of setting objects and buttons on the screen are indicated by square brackets [].

SET

(Bold characters)

Bold characters within the text indicate operating key labels.

Unless otherwise specified, "Windows" represents Windows XP, Windows Vista, Windows 7, Windows 8, or Windows 10

Click: Press and quickly release the left button of the mouse.

Double click: Quickly click the left button of the mouse twice.

Accuracy

We define measurement tolerances in terms of f.s. (full scale), rdg. (reading) and dgt. (digit) values, with the following meanings:

f.s. (maximum display value or scale length)

The maximum displayable value or scale length. In this instrument, the maximum displayable value is the range (V/div) times the number of divisions (10) on the vertical axis. Example: For the 1 V/div range, f.s. = 10 V

rdg. (reading or displayed value)

The value currently being measured and indicated on the measuring instrument.

dgt. (resolution)

The smallest displayable unit on a digital measuring instrument, i.e., the input value that causes the digital display to show a "1" as the least-significant digit.

Measurement categories

This instrument complies with CAT II safety requirements.

To ensure safe operation of measurement instruments, IEC 61010 establishes safety standards for various electrical environments, categorized as CAT II to CAT IV, and called measurement categories.

CAT II: Primary electrical circuits in equipment connected to an AC electrical outlet by a power cord (portable tools, household appliances, etc.) CAT II covers directly measuring electrical outlet receptacles.

CAT III: Primary electrical circuits of heavy equipment (fixed installations) connected directly to the distribution panel, and feeders from the distribution panel to outlets.

CAT IV: The circuit from the service drop to the service entrance, and to the power meter and primary overcurrent protection device (distribution panel).

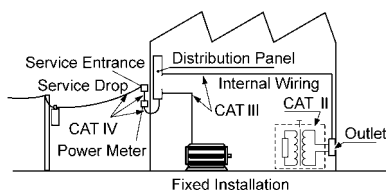

Using a measurement instrument in an environment designated with a higher-numbered category than that for which the instrument is rated could result in a severe accident, and must be carefully avoided.

Use of a measurement instrument that is not CAT-rated in CAT II to CAT IV measurement applications could result in a severe accident, and must be carefully avoided.

Operating Precautions



Follow these precautions to ensure safe operation and to obtain the full benefits of the various functions.







Before Use

- Before using the instrument the first time, verify that it operates normally to ensure that no damage occurred during storage or shipping. If you find any damage, contact your dealer or Hioki representative.
- Before using the instrument, make sure that the insulation on the probes, connection cords, and clamp sensor leads is undamaged and that no bare conductors are improperly exposed. Using the instrument in such conditions could cause an electric shock, so contact your dealer or Hioki representative for replacements.

Instrument Installation

Operating temperature and humidity: 0 to 40°C at 80% RH or less (non-condensating)
 Temperature and humidity range for guaranteed accuracy: 23±5°C, 80%RH or less

Avoid the following locations that could cause an accident or damage to the instrument.

	Exposed to direct sunlight Exposed to high temperature		In the presence of corrosive or explosive gases
	Exposed to liquids Exposed to high humidity or condensation		Exposed to strong electromagnetic fields Near electromagnetic radiators
	Exposed to high levels of particulate dust		Subject to vibration



The maximum operating (ambient) temperature for the MR8870-20 is 40°C. Do not attempt to use in higher temperature environments.

NOTE Correct measurement may be impossible in the presence of strong magnetic fields, such as near transformers and high-current conductors, or in the presence of strong electromagnetic fields such as near radio transmitters.

Installation Precautions

- Do not install the instrument with any side except the bottom facing down.
- Leave sufficient space around the ventilation holes and install the instrument with the holes unobstructed.

Handling the Instrument



- Do not allow the instrument to get wet, and do not take measurements with wet hands. This may cause an electric shock.
- Do not attempt to modify, disassemble or repair the instrument; as fire, electric shock and injury could result.



- To avoid damage to the instrument, protect it from physical shock when transporting and handling. Be especially careful to avoid physical shock from dropping.
- This instrument may cause interference if used in residential areas. Such use must be avoided unless the user takes special measures to reduce electromagnetic emissions to prevent interference to the reception of radio and television broadcasts.

Handling the Cords and Probes



- Avoid stepping on or pinching cables, which could damage the cable insulation.
- To avoid breaking the cables and probes, do not bend or pull them.
- To avoid damaging the power cord, grasp the plug, not the cord, when unplugging it from the power outlet.
- When disconnecting the BNC connector, be sure to release the lock before pulling off the connector. Forcibly pulling the connector without releasing the lock, or pulling on the cable, can damage the connector.

Operating Precautions

CAUTION

- To prevent an electric shock accident, confirm that the white or red portion (insulation layer) inside the cable is not exposed. If a color inside the cable is exposed, do not use the cable.

NOTE

- Use only the specified measurement cables. Using a non-specified cable may result in incorrect measurements due to poor connection or other reasons.
- Before using a clamp sensor or logic probe, read the instruction manual supplied with it.

Before Turning Power On

WARNING

Using the Battery Pack

- For battery operation, use only the HIOKI Model 9780 Battery Pack. We do not take any responsibility for accidents or damage related to the use of any other batteries.

[See: "2.1 Using the Battery Pack \(Option\)" \(p. 24\)](#)

Using the AC Adapter

- Use only the supplied Model Z1005 AC Adapter. AC adapter input voltage range is 100 to 240 VAC (with $\pm 10\%$ stability) at 50/60 Hz. To avoid electrical hazards and damage to the instrument, do not apply voltage outside of this range.
- Turn the instrument off before connecting the AC adapter to the instrument and to AC power.
- To avoid electrical accidents and to maintain the safety specifications of this instrument, connect the power cord provided only to a 3-contact (two-conductor + ground) outlet.
- Before turning the instrument on, make sure the supply voltage matches that indicated on its power connector. Connection to an improper supply voltage may damage the instrument and present an electrical hazard.

CAUTION

When the power is turned off, do not apply voltage or current to the BNC jacks, logic connector, or external control terminals. Doing so may damage the instrument.

NOTE

After use, always turn OFF the power.

About Inputs and Measurement



Note the following maximum rated voltage between terminals and maximum rated voltage to earth.

Maximum rated voltage between terminals: 400 VDC

Maximum rated voltage to earth: 300 VAC/DC (CAT II)

The following tables list the maximum rated voltage between terminals and the maximum rated voltage to earth for connection cords.

To avoid electric shock and instrument damage, do not input voltages in excess of these figures.

The lower of the instrument's and the connection cord's maximum rated voltage between terminals applies.

When these voltage levels are exceeded, the instrument will be damaged. Do not make measurements as doing so may result in bodily injury.

The maximum rated voltage to earth does not change, even if you make measurements with an attenuator or other component connected to the input.

Consider your connection method and do not exceed the maximum rated voltage to earth.

Measurement cables	Maximum rated voltage between terminals	maximum rated voltage to earth
Model L9197	600 VAC/DC	600 VAC/DC (CAT III)
Model 9197		300 VAC/DC (CAT IV)
Model L9198	300 VAC/DC	600 VAC/DC (CAT II)
Model L9217		300 VAC/DC (CAT III)
Model L9790	600 VAC/DC	When using the L9790-01 Alligator clip, the 9790-03 Contact pin 600 VAC/DC (CAT II) 300 VAC/DC (CAT III) When using the L9790-01 Grabber clip 300 VAC/DC (CAT II) 150 VAC/DC (CAT III)
Model 9322 Differential Probe	2000 VDC, 1000 VAC	When using the Grabber clip 1500 VAC/DC (CAT II) 600 VAC/DC (CAT III) When using the Alligator clip 1000 VAC/DC (CAT II) 600 VAC/DC (CAT III)

For example, if the instrument is used in combination with Model L9198, the maximum rated voltage between terminals is 300 VDC and the maximum rated voltage to earth is 300 VAC (CAT II).



Connect the clamp-on sensors or measurement cables to the instrument first, and then to the active lines to be measured. Observe the following to avoid electric shock and short circuits.

- To avoid short circuits and potentially life-threatening hazards, never attach the clamp to a circuit that operates at more than the maximum rated voltage to earth, or over bare conductors.
- Do not allow the connection cord clips to touch two wires at the same time. Never touch the edge of the metal clips.
- When the clamp sensor is opened, do not allow the metal part of the clamp to touch any exposed metal, or to short between two lines, and do not use over bare conductors.
- Do not leave the Memory HiCorder connected to test objects in environments where a voltage surge might exceed the dielectric withstand voltage. Doing so could result in damage to the Memory HiCorder, bodily injury or fatal accident.

CD Handling



- Always hold the disc by the edges, so as not to make fingerprints on the disc or scratch the printing.
- Never touch the recorded side of the disc. Do not place the disc directly on anything hard.
- Do not wet the disc with volatile alcohol or water, as there is a possibility of the label printing disappearing.
- To write on the disc label surface, use a spirit-based felt pen. Do not use a ball-point pen or hard-tipped pen, because there is a danger of scratching the surface and corrupting the data. Do not use adhesive labels.
- Do not expose the disc directly to the sun's rays, or keep it in conditions of high temperature or humidity, as there is a danger of warping, with consequent loss of data.
- To remove dirt, dust, or fingerprints from the disc, wipe with a dry cloth, or use a CD cleaner. Always wipe from the inside to the outside, and do no wipe with circular movements. Never use abrasives or solvent cleaners.
- Hioki shall not be held liable for any problems with a computer system that arises from the use of this CD, or for any problem related to the purchase of a Hioki product.

Overview

Chapter 1

1.1 Product Overview and Features

The Hioki MR8870-20 Memory HiCorder is a compact, lightweight, easy-to-operate waveform recorder. It can run on batteries, and can be quickly deployed when a power anomaly occurs.

Measurement data can be monitored, subjected to calculations and analyzed on a personal computer using the supplied application program.

Recording various analog signals

Measurements for a wide variety of applications are available using the appropriate measurement leads or clamp sensor options.

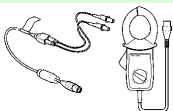

Recording logic signals

Measures using optional logic probes. Mixed analog and logic recording is possible.

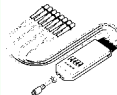

Recording waveforms of abnormal events

Abnormal events can be analyzed by recording with the trigger function (p. 55).

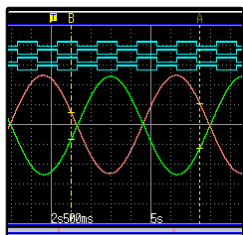
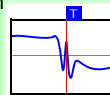

Measurement data and setting configurations are stored, read and managed as data files

Measurement data can be stored to and read from an optional CF card (p. 71).

Waveform analysis

Gauge display
(p. 66)



Zoom in/out
(p. 64)



Numerical display
(p. 69)

123.4V

Cursor Measurements (p. 66)



Using the A/B cursors, values at cursor locations on waveforms and the time and period at trigger positions can be displayed.

Numerical Calculations (p. 93)



Up to seven types of calculations such as RMS, maximum and average values can be applied to measurement data, and waveforms and calculation results can be displayed separately on screen.

Analysis on a PC

Data stored on the CF card can be transferred for analysis to a computer using the supplied USB cable (p. 91). Measurement data can be analyzed using the supplied application program (p. A6).

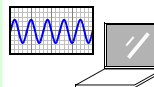

Display in converted units

Using the scaling function, input values can be displayed in units of the actual physical quantity being measured, such as speed or temperature (p. 50).

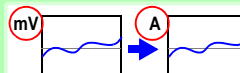

1.2 Measurement Flow

Installing, Connecting and Turning On

Install the battery pack (option) (p. 24)

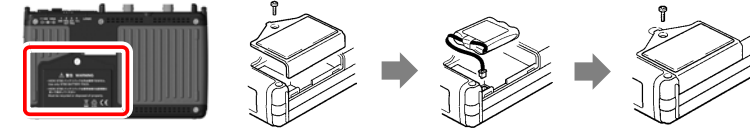

Connect to the Model MR8870-20 (p. 23), and set up (p. 6)

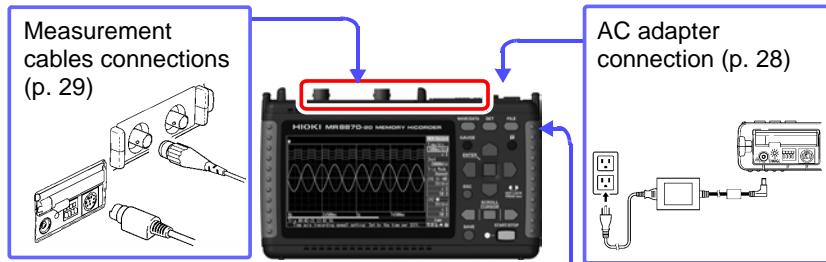

Turn the power on (p. 34)

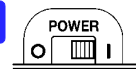

Configure measurement mode (p. 38)

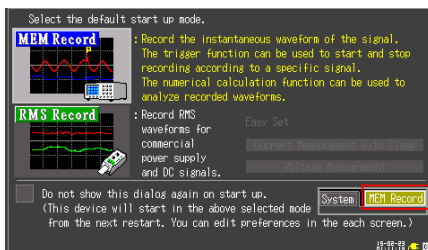

Memory recorder mode

The instrument records instantaneous signal waveforms. Trigger and numerical calculation functionality can be used.

RMS recorder mode

The instrument records RMS waveforms for commercial power supply (50Hz, 60Hz) and DC signals.

Thereafter, it will be explained on the screen of Memory recorder mode.

Settings

Configure measurement settings (p. 44)

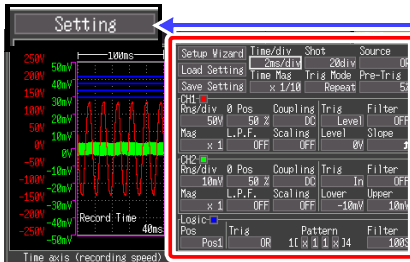

Move to a setting item
 Open the setting options
 Select
 Apply



Select the timebase (horizontal axis), voltage range (vertical axis) and input channels.

If the measurement ranges are unknown, they can be set automatically (p. 42).

Using a previously saved setting configuration

Reload a previously stored setting configuration from Model MR8870-20 memory or a CF card, and measure (p. 85).

Configure Automatic Data Storage to a CF card (as needed) (p. 77)

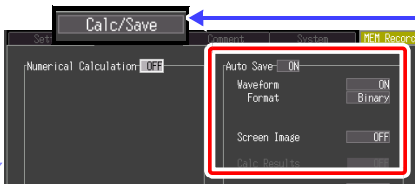

To save (store) measured data automatically, enable Auto-Save before starting to measure. Alternatively, you can save data manually after measuring.



Starting and Stopping Measurement

Press the START/STOP key (p. 20)

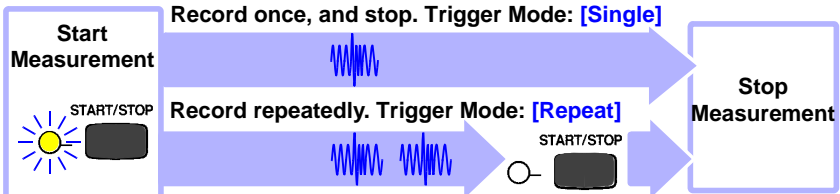

When recording using the trigger function, recording occurs only when the input waveform satisfies specified trigger criteria.

Data Analysis

View Measurement Data (p. 63)

Waveforms can be zoomed and numerical values confirmed.

Save Data (p. 71)

Measurement data, waveform data, screen images and numerical calculation results can be saved.

Calculate (p. 93)

Numerical measurement data can be applied to calculations.

View on a Computer (p. 91)

To download data from the CF card in the Memory HiCorder, connect a computer with the supplied USB cable. Recorded data can be analyzed on the computer with the bundled Wave Processor program (p. A6).

When Finished

Turn the Memory HiCorder Off (p. 34)

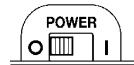

1.3 Names and Functions of Parts

Front Panel

Display Screen (p. 63)

4.3-inch TFT color LCD
Screen Configurations (p. 17)

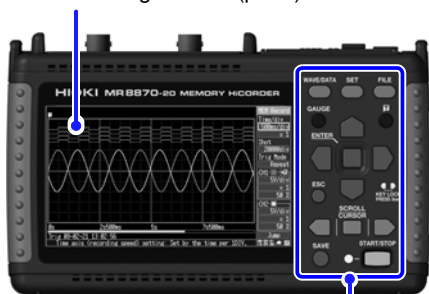

Operating Keys

Rear Panel

Manufacturer's Serial Number

Shows the serial number.
Do not remove this label, as it is required for product support.

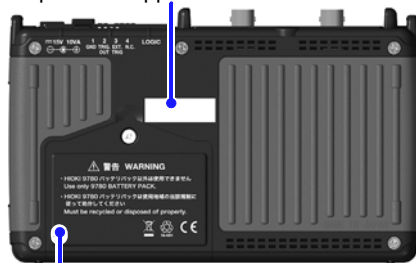

Battery Compartment (p. 24)

The optional Model 9780 Battery Pack is installed here.

Operating Keys

Choose a screen

■ WAVE/DATA

Switches between Waveform and Numerical Value screens (p. 17).

■ SET

Displays the Settings screens, and switches among the screen tabs with each press (p. 18).

■ FILE

Displays file information (p. 18).

Scroll waveforms and read cursor values

Use the left and right keys to scroll waveforms or move the A/B cursors. Press the middle key to select which of these actions the left and right keys perform (p. 19).

Saving operations

Press to save data manually (p. 77).

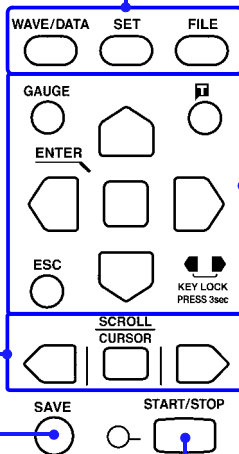

Start and stop measurement

Start and stop measurement. The LED at the left lights green while measuring (p. 20).

Setup and display

■ GAUGE

Alternately displays and hides the measurement scale on the Waveform screen.

■ (Manual trigger)

Press to trigger manually.

■ ESC

Cancels changes to settings.

■ Cursor Keys

Moves the position of the cursor (blinking selection) on the screen.



■ ENTER

Accepts displayed settings.



■ KEY LOCK

To lock the keys, press and hold the left and right cursor keys for three seconds. Repeat to unlock.



1.3 Names and Functions of Parts

Top Panel

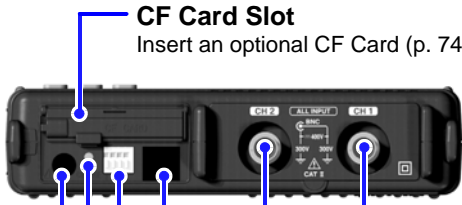

CF Card Slot

Insert an optional CF Card (p. 74).

AC Adapter Socket

Connect the supplied Model Z1005 AC Adapter (p. 28).

CHARGE LED

This LED lights when the battery is charging (p. 27).

BNC Jack

Connect optional measurement cables or clamp sensors (p. 29).

LOGIC Connector

Connect an optional logic probe (p. 32).

External Control Terminals

Control signals can be received from and output to external devices (p. 105).

Right Side

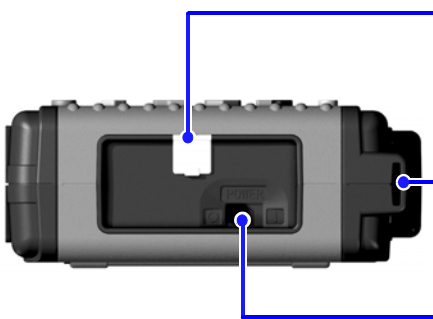

USB Port

(USB 2.0 mini-B receptacle)
Open the dust cap and connect the USB cable (p. 91).
Connect to a computer to transfer data.

Strap Hole (p. 33)

POWER Switch

Turns the instrument on and off (p. 34).

○ Power Off

| Power On

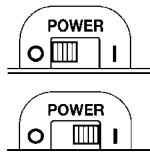

1.4 Screen Configurations

Waveform/Numerical Screens



Press this key to switch between the screens.

Operational information is displayed along the bottom of the screen.

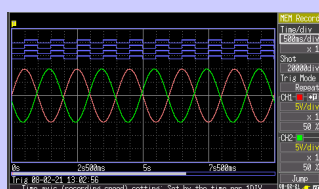

Waveform Screen

Data stored in the Memory Hi-Corder is displayed as waveforms (p. 63).



Numerical Screen

Displays the real-time numerical values of the measurement signals. Switch between instantaneous (peak-to-peak) and RMS values, or Display Hold. (p. 69)

About the Icons

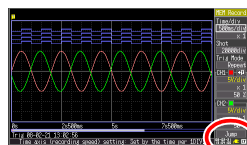

Clock

"Setting the Date and Time" (p. 102)

Power Source Indicator

Indicates the Memory HiCorder's power source.



AC adapter operation



Battery pack operation
Fully charged battery pack



Battery pack operation



Low battery indicator during battery pack operation

CF Card

Displayed when a CF card is inserted.

Settings Screens



Press this key to switch between the screens. Operational information is displayed along the bottom of the screen.

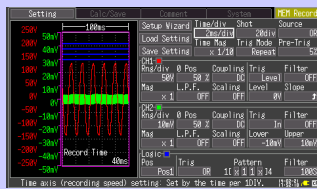

Setting Screen

Configure measurement settings (p. 44). Set trigger criteria as needed (p. 55).

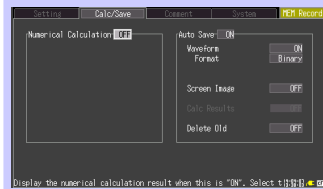

Calc/Save Screen

Configure numerical calculations (p. 93) and auto-saving (p. 78).

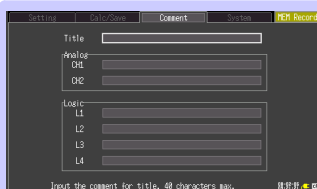

Comment Screen

Enter per-channel comments (p. 52).

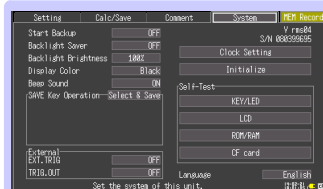

System Screen

Configure the system environment (p. 99).

File Screen



Operational information is displayed along the bottom of the screen.

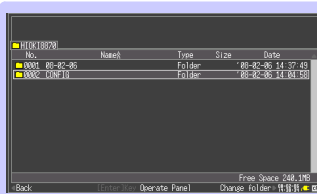

File Screen

View and manage files on the CF card (p. 71).

1.5 Basic Operation

Screen Operations

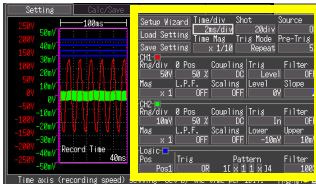

Setting Screen

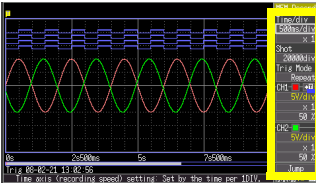

Waveform Screen

Changing screen contents

- Select the item to change.
- Show available setting options.
- Select the desired setting.
- Apply the new setting, or cancel it.

Scrolling a waveform

See: "Scrolling Waveforms" (p. 64)

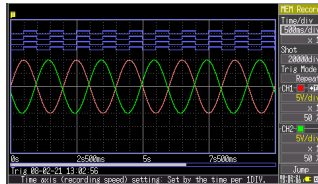

Reading values at cursors

1 Display the A/B cursors.

2 Move the A/B cursors. Values at cursor positions can be read numerically.

A/B cursor values

Cursor type

Select the cursor type, and which cursor(s) to move (p. 66).

Starting and Stopping Recording

Acquire measurement data on the Memory HiCorder, and start recording. Recording stops according to the trigger mode (recording criteria) setting (p. 46).

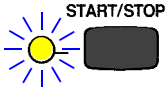

Start Measurement

Press the **START/STOP** key.
The green LED lights.

When using the trigger function, the times when measurement starts and when recording (data acquisition) starts are not the same.

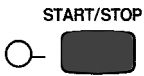

Finish Measurement

Trigger Mode: **[Repeat]** (default setting)
Pressing the START/STOP key stops recording.

Trigger Mode: **[Single]**
Recording stops when the specified recording time has elapsed.

Disabling Key Operations (Key-Lock Function)

Keys can be disabled to avoid inadvertent operations.



Press and hold the right and left cursor keys for three seconds to lock the other keys, and repeat to unlock.

Saving Display Images

Screen images of measurement data and setting configurations can be captured and saved (p. 82).

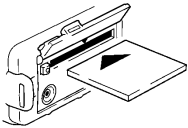

Insert a CF card.

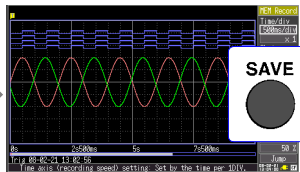

Display the screen to be saved, and press the SAVE key.

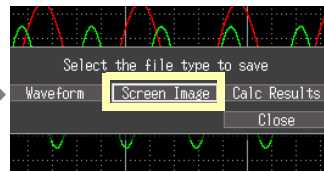

Select **[Screen Image]** in the dialog, and press the **ENTER** key to display the confirmation dialog. Select **[Yes]** and press **ENTER** again.

The image is saved as a bitmap image file (named *date_number*.BMP).

Verifying the Input Level (Level Monitor)

You can verify the input status and display range while making settings on the Setting screen. This is not available while measuring.

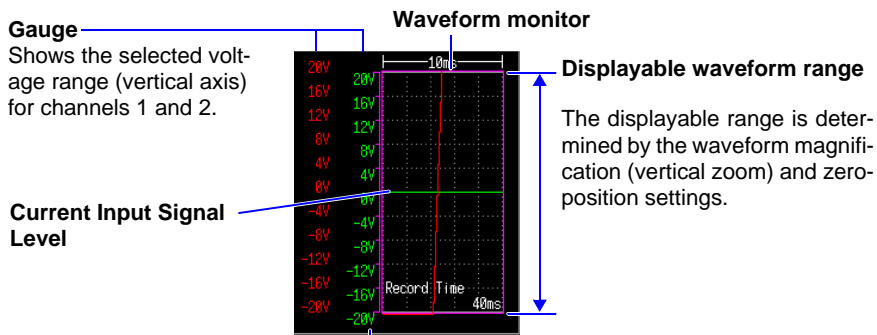

Measurement Units of Input Waveform

Using the Scaling function (p. 50), measurement units can be converted as desired for display.

Measurement Preparations

Chapter 2

2

Chapter 2 Measurement Preparations

1

Install the 9780 Battery Pack (option) (p. 24)



Rear View

2

Connect measurement cables (p. 29)

Voltage measurement:
connect connection cords

Current measurement:
connect clamp sensors

Logic signal measurement:
connect logic probe

3

Connect the AC adapter (p. 28)

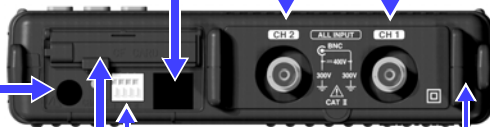

4

(To save data)
Insert a CF card (option) (p. 74)

Attach the strap (p. 33)

5

Turn the power on (p. 34)
Execute zero adjustment (p. 35)

External control
signal inputs
External control
signal outputs
(p. 105)

2.1 Using the Battery Pack (Option)



If commercial power is not available when the AC adapter is connected, the MR8870-20 Memory HiCorder can operate from the Model 9780 battery pack, so when using commercial power, the battery pack serves as a backup supply during power outages.

Charge the battery pack fully before using it the first time.



Be sure to observe the following precautions. Incorrect handling may result in liquid leaks, heat generation, ignition, bursting and other hazards.

- **Do not use a battery pack other than the 9780 Battery Pack. We cannot accept responsibility for accidents or damage related to the use of any other batteries.**
- **To avoid the possibility of explosion, do not short circuit, disassemble or incinerate battery pack.**
- **When storing the instrument, make sure no objects that could short-circuit the connectors are placed near them.**
- **The battery pack contains lye, which can cause blindness if comes into contact with the eyes. Should battery liquid get into your eyes, do not rub your eyes but rinse them in plenty of water and seek the immediate attention of a physician.**

Installing and replacing the battery pack

- **To avoid electric shock, turn off the power switch and disconnect the cables before replacing the battery pack.**
- **After installing or replacing the battery pack, replace the battery compartment cover and screw.**
- **Handle and dispose of batteries in accordance with local regulations.**

CAUTION

Observe the following to avoid damage to the instrument.

- Use the battery pack in an ambient temperature range of 0 to 40°C and charge it in an ambient temperature range of 5 - 30°C to be on the safe side.
- If the battery packs fails to complete charging within the stipulated time, disconnect the AC adapter from the pack to stop charging.
- Consult your dealer or nearest service station should liquid leaks, strange odor, heat, discoloration, deformation and other abnormal conditions occur during use, charging or storage. Should these conditions occur during use or charging, turn off and disconnect the instrument immediately.
- Do not expose the instrument to water and do not use it in excessively humid locations or locations exposed to rain.
- Do not expose the instrument to strong impacts and do not throw it around.

NOTE

- The battery pack is subject to self-discharge. Be sure to charge the battery pack before initial use.
- When recharging a discharged battery pack in the Model MR8870-20, allow it to charge for at least ten minutes with the Model MR8870-20 turned off to maximize battery longevity.
- The battery pack is a consumable. If the battery capacity remains very low after correct recharging, the useful battery life is at an end. It can be recharged up to about 500 times.
- To prevent battery pack deterioration when the battery will not be used for 1 month or longer, remove it and store it in a dry location with an ambient temperature range of between -10 to 30°C. Be sure to discharge and charge it every two months. Long-term storage when capacity has decreased will make charging impossible and reduce performance.
- Remove the battery pack from instrument once a month and check that appearance is normal.
- As long as battery charge remains, waveform data is retained in internal memory while the Memory HiCorder is turned off, so the battery continues to gradually discharge. When the battery charge is depleted, stored waveform data is lost.

2.1 Using the Battery Pack (Option)

When to charge

When powering the instrument from the battery pack without the Model Z1005 AC Adapter, the low battery indicator () is displayed when the battery charge is depleted, indicating that the battery pack requires charging.

Note that if the Memory HiCorder is turned off under this situation, waveform data may fail to be backed up, and could be lost.

Approximate charging time:

About 200 minutes at 23°C when recharged at the first appearance of the low battery indicator.

Approximate continuous battery-only operating time

(operating at 23°C)

- After a full charge, with the LCD backlight always on (default setting): approximately two hours
- After a full charge, with the LCD backlight off (five minutes after last key-press): approximately 2.5 hours

See: "Enabling and Disabling the Backlight Saver" (p. 101)

Install the Battery Pack

Required tool:

One Phillips screwdriver
(No.2)

Battery Compartment
Cover

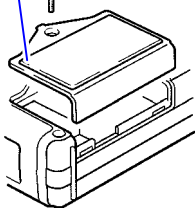

- 1 Place the Memory HiCorder face down, and remove the battery compartment cover screw and cover.

Important

Disconnect the AC adapter when installing the battery pack.

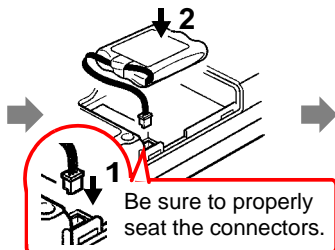

- 2 Connect the plugs of the battery pack to the connectors and insert the battery pack with the label side up.

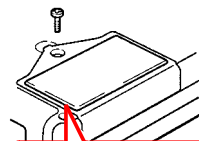

- 3 Replace the battery compartment cover and screw.

Pull the battery pack plug straight out to remove the battery pack.

Charge the Battery Pack

Regardless of whether the Memory HiCorder is on or off, the battery pack recharges whenever the Z1005 AC Adapter is plugged in to a power source. Therefore, charging is provided by merely keeping the battery installed in the Memory HiCorder.

- 1 Connect the power cord to the inlet socket on the AC adapter.

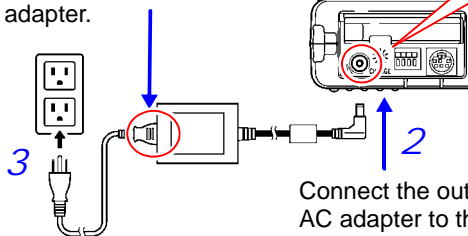

Connect the output plug of the AC adapter to the instrument.

Plug the power cord into the mains outlet.

Refer to "2.2 Connecting the AC Adapter" (p. 28) for details about the AC adapter.

2.2 Connecting the AC Adapter



Connect the power cord and the instrument to the supplied Model Z1005 AC Adapter, then plug the power cord into an outlet. When used with the battery pack installed, the battery serves as an operating backup supply in case of power failure, and the AC adapter otherwise has priority.

Before Connecting



- Use only the supplied Model Z1005 AC Adapter. AC adapter input voltage range is 100 to 240 VAC (with $\pm 10\%$ stability) at 50/60 Hz. To avoid electrical hazards and damage to the instrument, do not apply voltage outside of this range.
- Turn the instrument off before connecting the AC adapter to the instrument and to AC power.
- To avoid electrical accidents and to maintain the safety specifications of this instrument, connect the power cord only to a 3-contact (two-conductor + ground) outlet.



To avoid damaging the power cord, grasp the plug, not the cord, when unplugging it from the power outlet.

- 1 Connect the power cord to the inlet socket on the AC adapter.

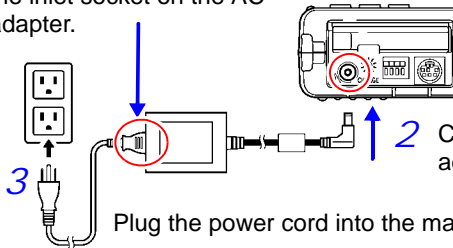

Rated supply voltage is 100 to 240 VAC, and rated supply frequency is 50 or 60 Hz.

- 2 Connect the output plug of the AC adapter to the instrument.

3 Plug the power cord into the mains outlet.

2.3 Connecting Measurement Cables to the Memory HiCorder



Connect the appropriate cables for the intended recording application.

- To record voltage waveforms (p. 31)
- To record current waveforms (p. 31)
- To record logic signals (p. 32)

Be sure to read the "Operating Precautions" (p. 6) before connecting the cables.

Connecting to the BNC terminals



Note the following maximum rated voltage between terminals and maximum rated voltage to earth.

Maximum rated voltage between terminals: 400 VDC

Maximum rated voltage to earth: 300 VAC/DC (CAT II)

The following tables list the maximum rated voltage between terminals and the maximum rated voltage to earth for connection cords. To avoid electric shock and instrument damage, do not input voltages in excess of these figures.

The lower of the instrument's and the connection cord's maximum rated voltage between terminals applies.

When these voltage levels are exceeded, the instrument will be damaged. Do not make measurements as doing so may result in bodily injury.

The maximum rated voltage to earth does not change, even if you make measurements with an attenuator or other component connected to the input.

Consider your connection method and do not exceed the maximum rated voltage to earth.

Measurement cables	maximum rated voltage between terminals	Maximum rated voltage to earth
Model L9197	600 VAC/DC	600 VAC/DC (CAT III) 300 VAC/DC (CAT IV)
Model 9197		
Model L9198	300 VAC/DC	600 VAC/DC (CAT II) 300 VAC/DC (CAT III)
Model L9217		
Model L9790	600 VAC/DC	When using the L9790-01 Alligator clip, the 9790-03 Contact pin 600 VAC/DC (CAT II) 300 VAC/DC (CAT III) When using the L9790-01 Grabber clip 300 VAC/DC (CAT II) 150 VAC/DC (CAT III)
Model 9322 Differential Probe	2000 VDC, 1000 VAC	When using the Grabber clip 1500 VAC/DC (CAT II), 600 VAC/DC (CAT III) When using the Alligator clip 1000 VAC/DC (CAT II) 600 VAC/DC (CAT III)

For example, if the instrument is used in combination with Model L9198, the maximum rated voltage between terminals is 300 VDC and the maximum rated voltage to earth is 300 VAC (CAT II).

2.3 Connecting Measurement Cables to the Memory HiCorder



WARNING

Do not connect a cable to the instrument while it is connected to the object to be measured. Otherwise, an electric shock accident may occur.



CAUTION

To prevent damage to the instrument and sensor, never connect or disconnect a sensor while the power is on, or while the sensor is clamped around a conductor.

Connecting to the logic terminals



DANGER

To avoid electric shock and short circuit accidents or damage to the instrument, pay attention to the following:

- The ground terminal for the optional logic probe is not isolated from the Memory HiCorder's ground (chassis ground). Therefore, if the measurement object connects to AC, it should have a grounded, polarized plug, and be connected to the same power outlet as the Memory HiCorder's AC adapter. If the Memory HiCorder and measurement object are connected to different mains circuits, or if an ungrounded power cord is used, the potential difference between the different grounding paths may result in current flow through a logic probe that could damage the measurement object or Memory HiCorder.

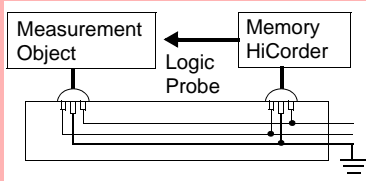

- Do not allow the metal tip of a logic probe to cause a short between conductors on the measurement object. Never touch the metal tip of a probe.
- Maximum rated voltage between terminals of logic probe follow the indications below.
Do not measure if the Maximum rated voltage between terminals would be exceeded, as damage the instrument or personal injury may result.
Model 9320-01 Logic Probe: +50 VDC
Model MR9321-01 Logic Probe: 250 Vrms (HIGH range), 150 Vrms (LOW range)

Connecting Connection Cords (to record voltage waveforms)

Connect an optional Hioki Connection Cord. Use the Hioki Differential Probe (P9000-01/02, 9322) if the voltage of the measurement object may exceed the Memory HiCorder's maximum rated voltage between terminals.

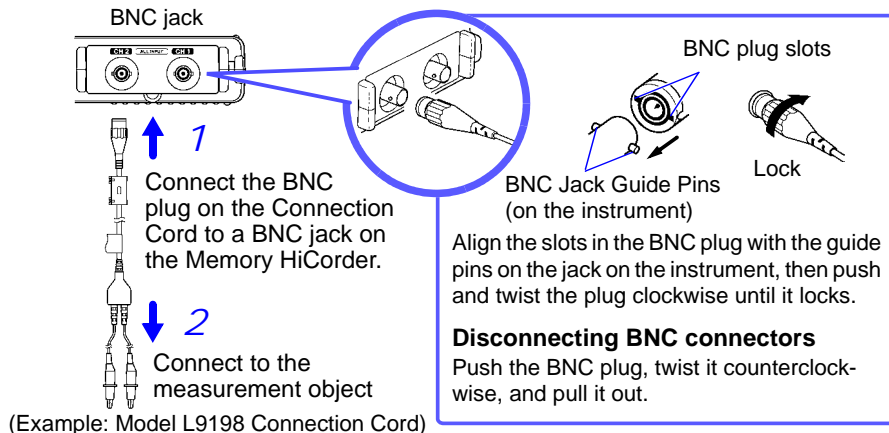
**Connecting a Clamp Sensor (to record current waveforms)**

Connect an optional Hioki clamp sensor. Refer to the instructions provided with the clamp sensor for usage instructions.

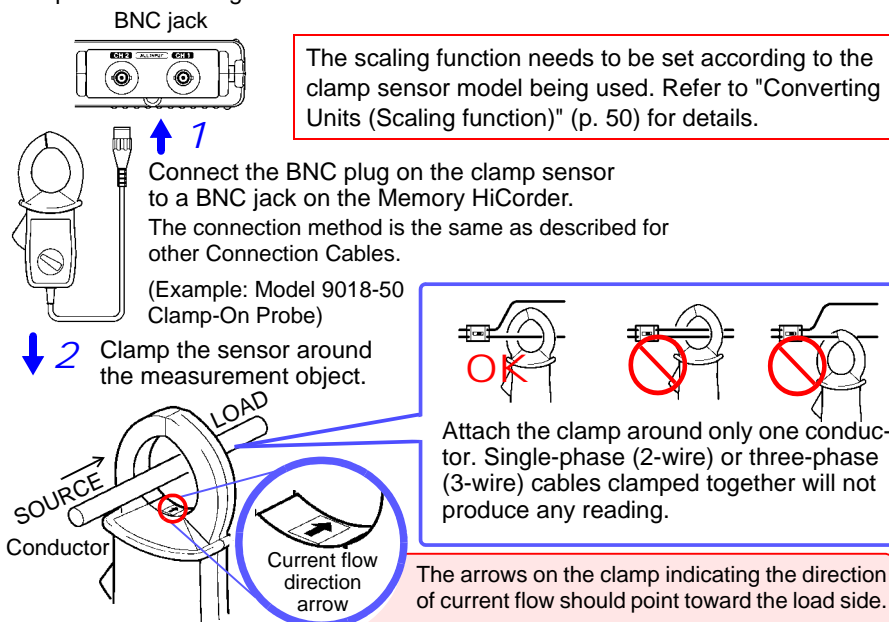

2.3 Connecting Measurement Cables to the Memory HiCorder

Connecting the Logic Probe (to record logic signals)

Connect the optional logic probe. Refer to the instruction provided with the probe.

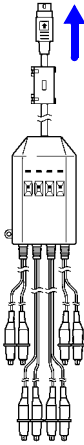
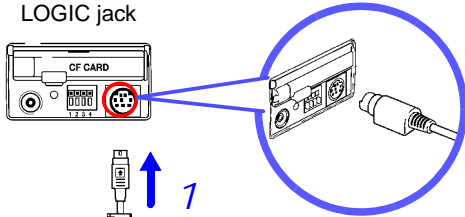

1
Connect the logic probe by aligning the grooves on the plug and a LOGIC jack.

(Example: Model MR9321-01 Logic Probe)

2
Connect to the measurement object.

When a logic probe is not connected, the corresponding logic waveform appears at HIGH level on the waveform screen.

2.4 Attaching the Carrying Strap

Use the strap to avoid dropping the instrument while carrying, or when you need to hang it on a hook.



Attach both ends of the Strap securely to the instrument. If insecurely attached, the instrument may fall and be damaged when carrying.

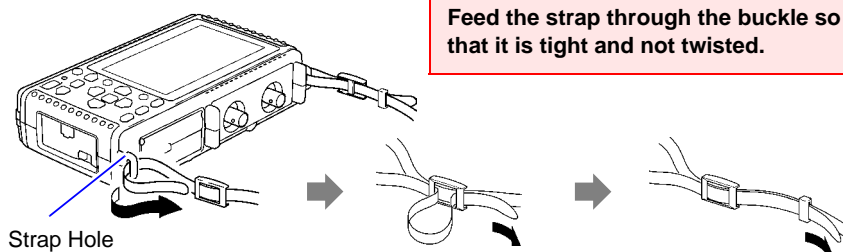

1 Push the strap through one of the strap holes on the instrument.

2 Feed the strap through the buckle.

3 Put the end of the strap under the retaining loop.

4 Repeat the same procedure with the other end of the strap and the other strap hole.

2.5 Turning the Power On and Off



Using the AC Adapter

Before turning the instrument on, make sure the supply voltage matches that indicated on its power connector. Connection to an improper supply voltage may damage the instrument and present an electrical hazard.

Rated supply voltage is 100 to 240 VAC

(Voltage fluctuations of $\pm 10\%$ from the rated supply voltage are taken into account.)

Rated supply frequency is 50 or 60 Hz.

Turning Power On

Verify that the instrument and peripheral devices are correctly connected.

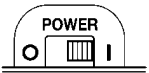

Turn the power switch on (|).



Right Side



Initial screen

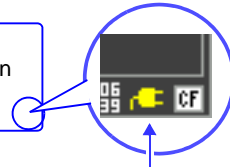

The power supply icon appears near the bottom right corner of the screen (p. 17).

If the "  " indicator is not displayed, the instrument is not being powered from the AC line. In this state, the battery charge will be depleted if measuring for a long time, and measurement may be interrupted. Verify that the AC adapter is securely connected to an AC power source and to the instrument.

See: "Approximate continuous battery-only operating time" (p. 26)

Execute zero-adjust 30 minutes after turning power on. (p. 35)

Turning Power Off

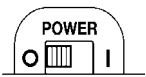

Turn the power switch off (○).

The installed battery pack is charged whenever the AC adapter is plugged into a power outlet, even when the Memory HiCorder is off. In addition, providing there is some remaining battery charge, waveform data and the setting configuration are memorized whenever the Memory HiCorder is turned off, so that when the Memory HiCorder is turned back on, the same operating state is displayed.

2.6 Zero Adjustment

Zero adjustment corrects for voltage offset at the input terminals, so that Memory HiCorder measurements are relative to zero volts.

Repeat zero adjustment if the ambient temperature changes suddenly.

Turn on the power and wait for 30 minutes to stabilize the internal temperature of the Memory HiCorder.

- 1  With the Waveform or Setting screen displayed, press and hold these keys simultaneously for one second.

(simultaneously)

The Zero Adjust dialog appears.

- 2  Select **[Zero Adjust]**.

 Apply

Zero adjustment is executed.

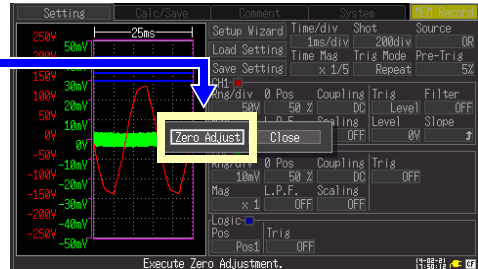

From the Setting screen

NOTE Any zero-adjust setting is cleared upon system reset (p. 103).

Setting before Measurement

Chapter 3

3.1 Pre-Operation Inspection

Before using the instrument the first time, verify that it operates normally to ensure that no damage occurred during storage or shipping. If you find any damage, contact your dealer or Hioki representative.

1 Peripheral Device Inspection

When using probes and connection cords

Is the insulation of the probe or connection cord to be used damaged, or is bare metal exposed?

Metal Exposed

No Metal Exposed

Do not use if damage is present as you could receive an electric shock. Replace the damaged items.

When using a clamp

Is the clamp cracked or damaged?

Yes To 2

No

To 2

2 Instrument Inspection

Is damage to the instrument evident?

Yes

If damage is evident, request repairs.

No

When turning power on

Does the HIOKI logo appear on the screen?

No

The power cord may be damaged, or the instrument may be damaged internally. Request repairs.

Yes

Is the Waveform or Setting screen displayed?
(When power is turned on the first time after purchase, the Setting screen should appear.)

Nothing appears, or the display is abnormal

The instrument may be damaged internally. Request repairs.

Yes

To 3

3 Input signals Inspection

Is "OVER" being displayed on the Numerical value screen?

Yes

A signal whose magnitude exceeds the maximum rated terminal-to-terminal voltage is being input. Halt measurement, as this condition is hazardous.

No

Inspection complete

3.2 Operating Flow Overview

Connect

Connect measurement cables or a clamp sensor (p. 29).

measurement mode

Selecting the mode from the screen that is displayed at power-on

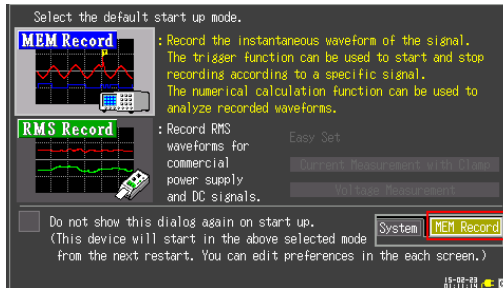

Memory recorder mode

The instrument records instantaneous signal waveforms. Trigger and numerical calculation functionality can be used.

RMS recorder mode

The instrument records RMS waveforms for commercial power supply(50Hz,60Hz) and DC signals.

Selecting the mode from other screens

The measurement mode can also be changed using the measurement mode area on the display, located at the top right of screens such as the Waveform screen (p. 17) and the Setting screen (p. 18).

When memory recorder mode has been selected



When RMS recorder mode has been selected



The rest of this manual uses the memory recorder screen to describe instrument operation. For more information about RMS recorder mode settings, see the Measurement Guide (RMS Recorder).

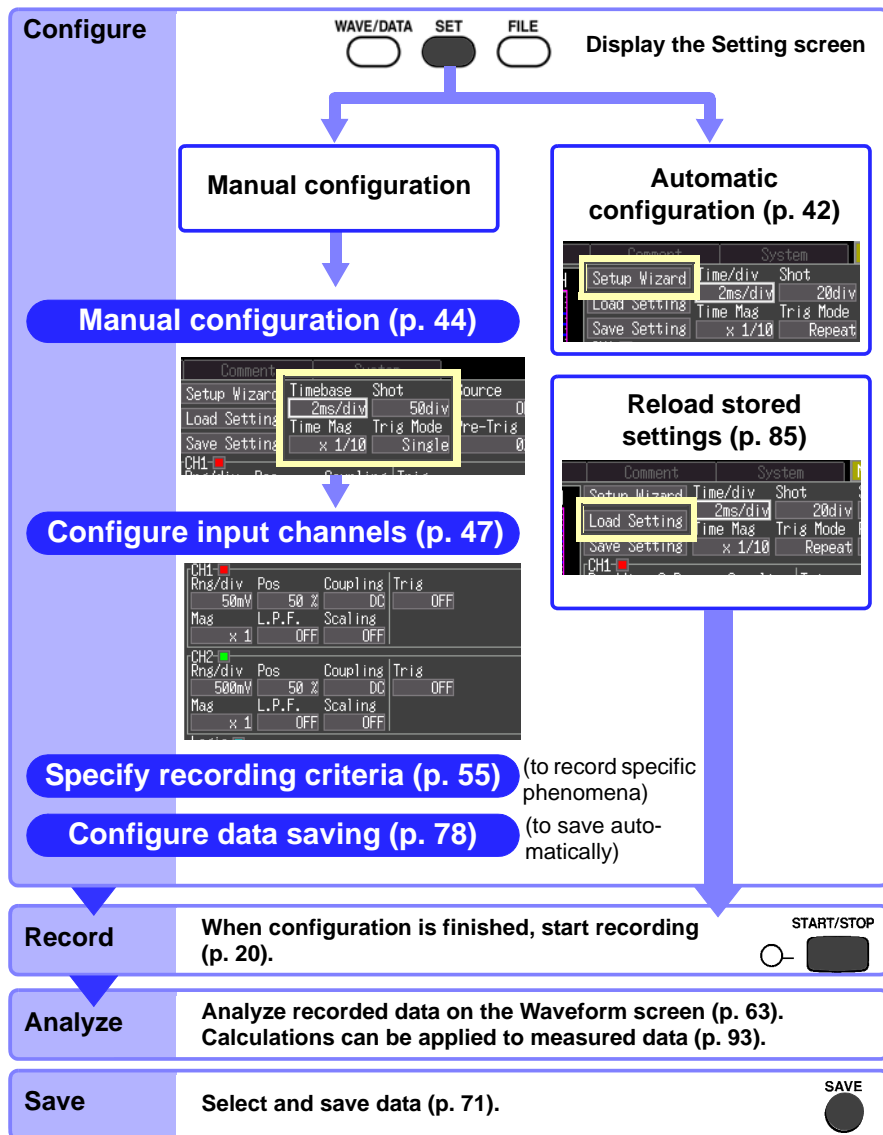

Measurement Configuration (Setting Screen)

Before starting measurement, configure settings on the [Setting] screen according to the desired measurement.

To observe their effects, settings can be made while viewing input waveforms in the waveform monitor window (p. 21).

Previously stored setting configurations can also be reloaded (p. 85).

Information about the currently highlighted item is displayed along the bottom of the [Setting] screen.

- ### Automatic Setting Configuration, Saving and Reloading
- Automatic Setting Configuration (p. 42)
 - Reloading Settings (p. 85)
 - Saving Settings (p. 84) *1

*1. Can be set only from the [Setting] screen.

- ### Time Axis (Horizontal Axis) Settings
- Selecting the Timebase (p. 44)
 - Setting the Recording Length (divisions) (p. 45)
 - Selecting Horizontal Display Magnification (p. 45)

- ### Setting Recording Criteria
- Selecting the Trigger Mode (p. 46)
 - Trigger Settings (p. 55)

- ### Input Channel Settings
- Selecting the Voltage Axis (Vertical Axis) Range (p. 47)
 - Selecting Waveform Display Colors (p. 47)
 - Setting the Zero Position (p. 48)
 - Selecting the Input Coupling Method (p. 48) *1
 - Selecting Vertical Axis Magnification (p. 49)
 - Selecting the Low-Pass Filter (p. 49) *1
 - Setting Unit Conversion (Scaling) (p. 50) *1

- ### Logic Channel Settings
- Selecting Logic Channel Waveform Colors (p. 51)
 - Setting Logic Channel Waveform Display Positions (p. 51)
 - Trigger Settings (p. 61)

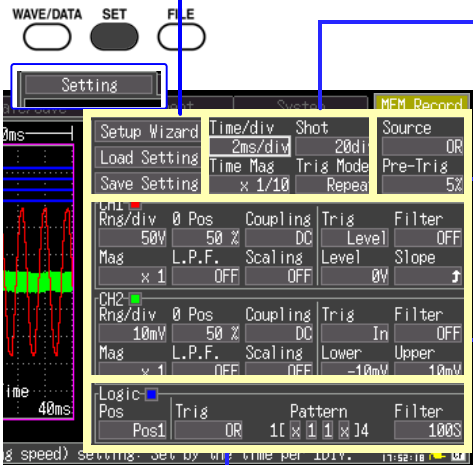

Measurement Configuration (Waveform Screen)

Certain setting items are available on the Waveform screen. Setting details are the same as for those on the Setting screen.

Changing the range, recording length or trigger setting while measuring causes any existing measurement data to be erased as measurement restarts with the new settings (Restart).

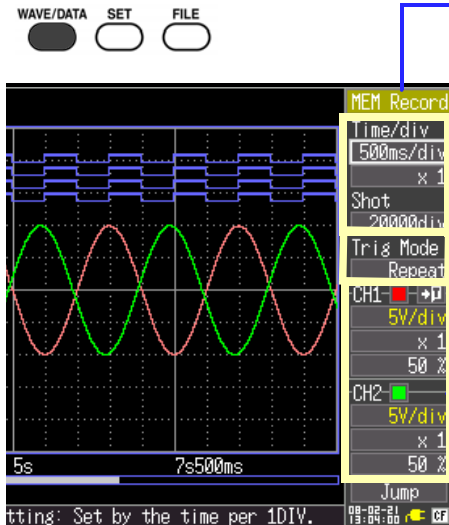

Waveform Screen

Time Axis (Horizontal Axis) Settings

- Selecting the Timebase (p. 44)
- Setting the Recording Length (divisions) (p. 45)
- Selecting Horizontal Display Magnification (p. 45)

Setting Recording Criteria

- Selecting the Trigger Mode (p. 46)
- Trigger Settings (p. 55)

Input Channel Settings

- Selecting the Voltage Axis (Vertical Axis) Range (p. 47)
- Selecting Waveform Display Colors (p. 47)
- Setting the Zero Position (p. 48)
- Selecting Vertical Axis Magnification (p. 49)

3.3 Automatic Configuration of Measurement Settings (Auto Range)

3.3 Automatic Configuration of Measurement Settings (Auto Range)

If the appropriate measurement range settings are unknown, Auto Range can be enabled from the Waveform or Setting screen. Setting configurations saved to Memory HiCorder memory or to an installed CF card can be reloaded for later reuse (p. 85).

Auto Range from the Waveform Screen

- 1 Select the Waveform Screen
Press and hold together for one second
A dialog appears.
- 2 Select [Auto Range]
Apply

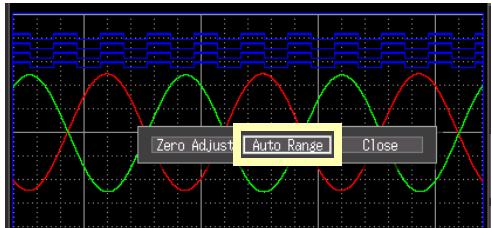

If the appropriate range cannot be automatically detected, "Auto Range failed" appears. In this case, configure the range settings manually from the Setting screen while watching the waveform monitor.

Selecting Auto Range on the Setting Screen

- 1 Select the [Setting] Screen
- 2 Select [Setup Wizard].
Apply
A dialog appears.
Follow the instructions in the dialog.
Apply
Set according to the input waveform amplitude.

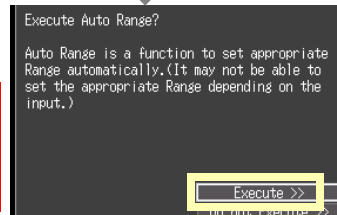
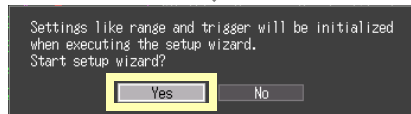
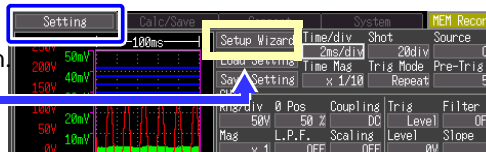

If appropriate settings for the input signal cannot be determined, select [Next] to display the manual range selection procedure, and follow the procedure to make the settings.

3.3 Automatic Configuration of Measurement Settings (Auto Range)

Auto Range Settings

Setting Item		Settings
Timebase	[Timebase]	Auto setting value Automatically displays 1 to 2.5 cycles on the Waveform screen. When both channels are enabled for waveform display, the waveform on CH1 determines the timebase setting.
Zoom (magnification)	[Time Mag]	x1
Settings for CH1 and CH2		
Voltage-axis range	[Rng/div]	Auto setup value
Zero position	[Pos]	Auto setup value
Zoom (magnification)	[Mag]	x1
Low-pass filter	[L.P.F]	Off
Input coupling	[Coupling]	DC
Trigger Criteria		
Trigger mode	[Trig Mode]	Repeat
Trigger source AND/OR	[Source]	OR
Pre-Trigger	[Pre-Trig]	20%
Trigger	[Trig]	Level trigger CH1 only. However, if CH1 display is disabled when executing Auto Range from the Waveform screen, this setting is applied to CH2 only. This setting is also applied to CH2 when the difference between maximum and minimum values of the input signal on CH1 is two divisions or less.
Slope	[Slope]	↑ (Rising)
Level (Trigger Level)	[Level]	Auto setup value
Filter	[Filter]	Off

When Using External Control Terminals

NOTE Executing Auto Range generates a trigger signal on the trigger output external control terminal. Bear this in mind when using the trigger output terminal and the Auto Range function.

3.4 Measurement Configuration 1 (Horizontal Axis Settings)

3.4 Measurement Configuration 1 (Horizontal Axis Settings)

Make settings while viewing the Waveform monitor at the left side of the [Setting] screen.

- 1 Select the [Setting] Screen.
- 2 Move to a setting item.
- Open the setting options for the item to be set.
- Select from the listed options.
- Apply

Waveform monitor

Select a Timebase

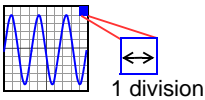

Set the amount of time to display per horizontal division. Sampling rate = timebase (seconds/div)/100 (data samples/division), so at x1 display magnification, each division contains 100 data samples.

Decreasing the timebase increases the resolution of data available for analysis. See "Selecting a Timebase (Horizontal Axis)" (p. 11).

When the duration of 1 div. as shown on the Waveform screen is 50 ms or more, the waveform will be scrolled automatically as it is displayed during measurement (the Roll Mode display function).

Select from the [Timebase] setting options.
 Setting options:
 100*, 200, 500 μ s, 1, 2, 5, 10, 20, 50, 100, 200, 500 ms,
 1, 2, 5, 10, 30 s, 1, 2, 5 min [div]
 (* default setting)

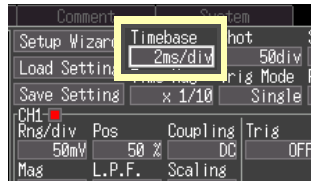

Setting Recording Length (no. of divisions)

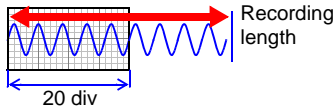

Set the recording length in units of display divisions.

Recording time = timebase (s/div) x recording length (div)

Select from the **[Shot]** setting options.

Setting options:

20*, 50, 100, 200, 500, 1000, 2000, 5000,
10000, 20000 [div], Cont (continuous)

(* default setting)

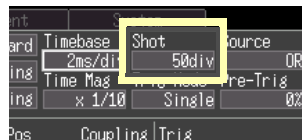

Recording length (Cont) (continuous)

- The [Cont] recording length can be used when the time axis is 50 ms/div or slower. For example, setting the recording length (Cont) when the time axis is set to 10 ms/div will automatically set the time axis to 50 ms/div.
- Time values are not indicated during measurements.
- The trigger function (p. 55) and external trigger function (p. 107) are not available.
- The trigger mode (p. 46) is fixed at [Single].

When recording exceeds the maximum recording length (20,000 div), the following will take place

- A total of 20000 divisions worth of data remains when recording is stopped.
- Data saved on a CF card during auto save and manual save extends a total of 20000 divisions back from the end of recording.
- The time values indicated in the waveform screen indicates the time at end of recording as 0 s, a negative value.

Setting Display Zoom (as needed)

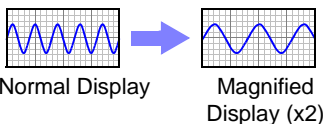

Select display magnification of the horizontal axis as needed.

Select from the **[Time Mag]** setting options.

Setting options:

x10, x5, x2, x1*, x1/2, x1/5, x1/10, x1/20, x1/50,
x1/100, x1/200, x1/500, x1/1000

(* default setting)

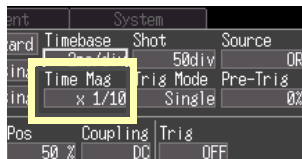

3.5 Measurement Configuration 2 (Setting Recording Criteria)

Setting the Trigger Mode

Select whether to record one recording length per trigger event, or to record continuously ([Repeat]). To specify other recording criteria, additional trigger settings are required.

See: "Chapter 4 Making Trigger Settings" (p. 55)

Select from the **[Trig Mode]** setting options.

Setting options:(* default setting)

Single Records one time and stops.

Repeat* Records continuously until you press the START/STOP key.

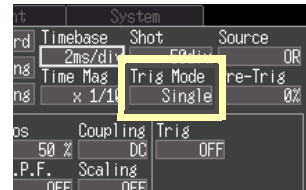

When the trigger mode is set to [Repeat], triggering is disabled during the end of recording processing (auto save, waveform display processing and calculation) before going to the next trigger standby status. Therefore, events that meet the trigger criteria during this processing period are not recognized as trigger events.

Recording length [Cont], the trigger mode is fixed at [Single].

3.6 Measurement Configuration 3 (Analog Channel Settings)

Setting the Zero Position (as needed)

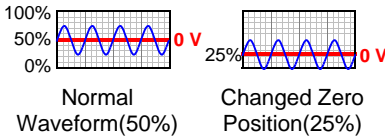

The vertical display position of each waveform can be changed. Set the waveform zero position (in this example, zero volts) for display on the vertical axis.

Select from the **[Pos]** setting options.
 Setting options: **- 50 to 150%**
 (in 1% steps, when the [Mag] setting is x1),
 (default setting: 50%),

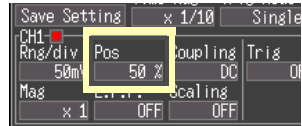

Magnification and compression (p. 49) in the voltage axis direction is based on the zero position. Although the range of voltage that can be displayed on the Waveform screen depends on the zero position and magnification/compression of the voltage axis, the measurement range is unaffected.

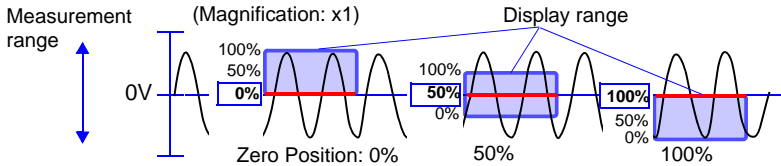

The valid setting range depends on display magnification.
 With x10 magnification (maximum setting range), -950 to 1050%

Selecting the Input Coupling Method (as needed)

Select the coupling method for input signals.

Select from the **[Coupling]** setting options.
 Setting options: (* default setting)

- DC*** DC Coupling
 Select this to acquire both DC and AC components of an input signal.
- GND** The input signal is disconnected.
 Zero position can be confirmed.

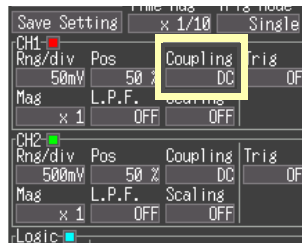

Zooming the Vertical Axis (as needed)

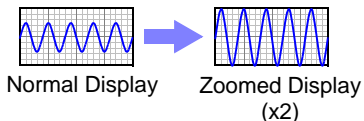

Display magnification of the vertical (voltage) axis can be selected for each input waveform. Magnification is applied relative to the waveform's zero position.

Select from the **[Mag]** setting options.

Setting options: **x10, x5, x2, x1***, x1/2, x1/5
(* default setting)

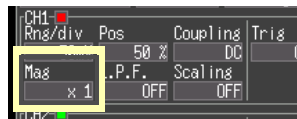

Selecting a Low-Pass Filter (L.P.F.) (as needed)

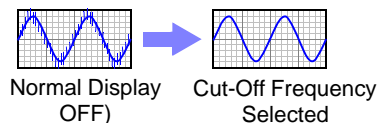

To suppress high-frequency components, select a low-pass filter.

Select from the **[L.P.F]** setting options.

Setting options: **OFF***, 5Hz, 50Hz, 500Hz, 5kHz
(* default setting)

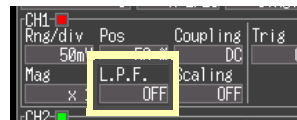

3.6 Measurement Configuration 3 (Analog Channel Settings)

Converting Units (Scaling function)

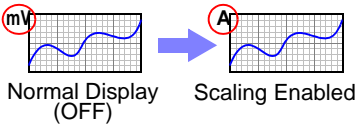

Input voltage values can be converted to physical units for display, such as by converting voltage to current. Preset scaling settings are provided for current measurement with the optional clamp sensor models.

Select from the **[Scaling]** setting options.
 Setting options: **OFF***, **Model**, **Ratio**, **2-Point**
 (* default setting)

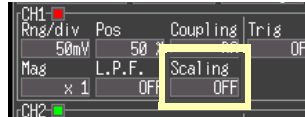

A dialog appears when selected.

Model

Select your clamp sensor and attenuating probe model from the Model list.

Setting options:

- 3283, 3284, 3285, 9010-50, 9018-50, 9132-50, 9657-10, 9675, CT9691, CT9692, CT9693, CT9667, 9322, P9000, 9660, 9661, 9669, 9694, 9695-02, 9695-03, CT6500, CT7044/CT7045/CT7046, CT7631/CT7731, CT7636/CT7736, CT7642/CT7742

*When using Model CT969x series in combination with Model CT6590, execute zero adjustment.(p. A18)

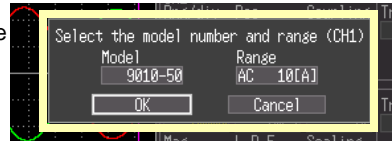

Ratio

Select the output ratio (conversion ratio) of the clamp sensor, or the attenuating ratio of the attenuating probe.

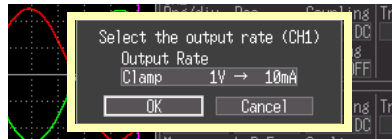

2-Point

Set the voltage values of two points of the input signal, the converted unit value of these two points and the name of the converted measurement units, so measurement values acquired as voltage are converted to the specified units.

Example:

Voltage value at 2 points	Voltage of units to convert
V _H : High value	A _H : Converted high value
V _L : Low value	A _L : Converted low value

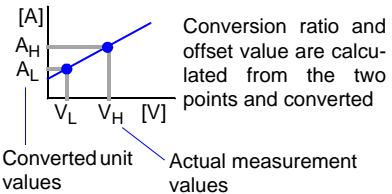
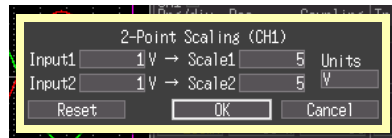

$$Y = \frac{A_H - A_L}{V_H - V_L} \times X + \frac{V_H \times A_L - V_L \times A_H}{V_H - V_L}$$

Conversion Ratio
Offset

X: Voltage value
 Y: Converted value

Valid setting ranges for conversion ratio and offset are as follows.

Note that the conversion ratio cannot be set to zero.
 $-9.9999E+9 \leq$ (conversion ratio, offset) $\leq -1.0000E-9$
 (offset) = 0

$+1.0000E-9 \leq$ (conversion ratio, offset) $\leq +9.9999E+9$

Values outside the above range cannot be set.

Scaled values (and cursor values when using the A/B cursors) can be verified in the waveform screen.

3.7 Measurement Configuration 4 (Logic Channel Settings)

Configure the input channels when measuring with a logic probe.

To use logic signals as a trigger source:

See: "4.3 Logic Channel Trigger Settings" (p. 61)

- 1 Select the [Setting] Screen.
- 2 Move to a setting item.
- 3 Open the setting options for the item to be set.
- 4 Select from the listed options.
- 5 Apply

Setting Logic Channel Display Colors (as needed)

You can select a display color for each logic channel waveform

Select from the waveform display color setting options.

Setting options:

OFF*, Red, Green, Blue, Yellow, Pink, Light Blue
(* default setting)

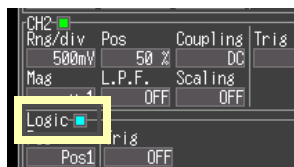

Setting Logic Channel Display Positions

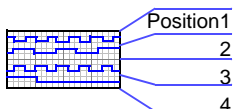

You can select the display position of each logic waveform. Waveform overlap on the display can be minimized when recording simultaneously with an analog waveform.



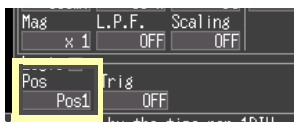

Select from the **[Pos]** setting options.

Setting options: **Pos1***, Pos2, Pos3, Pos4
(* default setting)



3.8 Entering Comments

Comments of up to 40 characters can be entered as a title for the measurement data, and as a label for each input waveform. The comments can be displayed when the data is viewed in an application program on a computer.

- 1  Select the [Comment] Screen.
- 2  Select the field in which to enter the comment
-  Apply
The character entry screen appears.
- 3  Select the characters to enter
To enter a space, select a blank character.
-  Apply
Characters appear in the entry field as you select them.

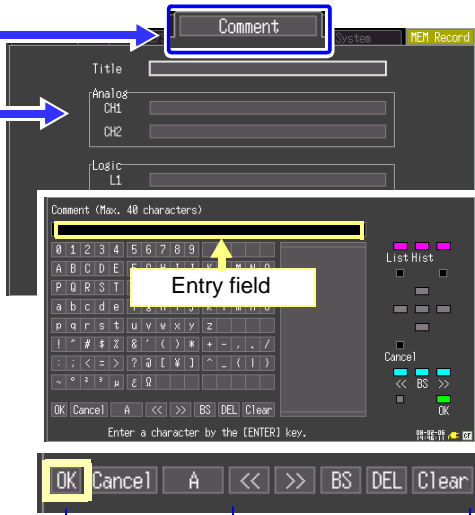

Select **[OK]**
Accepts your entry and returns to the [Comment] screen.

Finished with entry Navigate the entry field

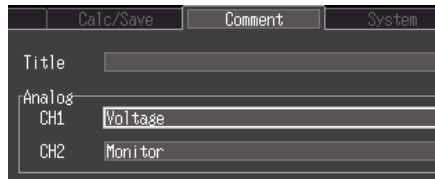

The following characters are converted as follows when saved to a text file.

Entered character						
Converted plain text equivalent	^2	^3	^u	~o	~c	~e

Operating Panel



The operating panel depicts the functions of Memory Hi-Corder's operating keys.

Only the keys displayed on the operating panel are enabled.

- **List (WAVE/DATA key)**
Measurement related terms are registered in the list beforehand.
- **Hist (History, SET key)**
You can select previously entered terms from the pick list.
- **Char Input (I key)**
Switches between the pick list and character selection frames.
- **↑/↓ (Cursor up/down key)**
Selects from the pick list frame.
- **Select (ENTER key)**
Accepts the item selected in the pick list.
- **Cancel (ESC key)**
Cancels entry.
- **<</ >> (SCROLL/CURSOR left/right key)**
Move input position.
- **BS (SCROLL/CURSOR middle key)**
Deletes one character.
- **OK (START/STOP key)**
Accepts entry.

Making Trigger Settings

Chapter 4

Triggering is the process of controlling the start and stop of recording by specific signals or conditions (criteria). When recording is started or stopped by a specific signal, we say the trigger is "applied" or "triggering occurs".

In this manual, **T** indicates a "trigger point", as the time at which a trigger is applied.

Trigger criteria met

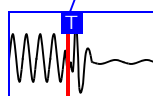

NOTE The trigger function cannot be used in RMS recorder mode.

Signals that can be used for triggering (trigger sources) are as follows.

Trigger Source	Description	Ref.
Analog Trigger	Applies a trigger according to a signal input on an analog channel. (Level, In-Window, Out-of-Window, or Voltage Sag trigger)	(p. 57)
Logic Trigger	Applies a trigger according to signals input on logic channels (Ch A to Ch D).	(p. 61)
External Trigger	Applies a trigger according to an input signal at the EXT.TRIG terminal (External Trigger Input)	(p. 105)
Manual Trigger	Applies a trigger by pressing T .	(p. 62)

A trigger can be applied by combining (AND/OR) criteria from multiple trigger sources (except manual triggering). When the recording length is [Cont], the trigger function is not available.

4.1 Setting Recording Criteria

Make these settings when selecting the type of triggering to be applied to input channel (CH1 or CH2) recording.

1 Select the [Setting] Screen.

2 Move to a setting item.

3 Open the setting options for the item to be set.

4 Select from the listed options.

5 Apply

The screenshot shows the oscilloscope's menu system. The 'Setting' menu is highlighted. The 'WAVE/DATA' menu is open, showing 'Setting' as the selected option. The 'CH1' and 'CH2' settings are visible, including 'Rng/div', 'Pos', 'Coupling', 'Trig', and 'Filter'. The 'Logic' menu is also visible, showing 'Pos', 'Trig', 'Pattern', and 'Filter'.

4.1 Setting Recording Criteria

Setting Combining Logic (AND/OR) for Multiple Trigger Sources

Analog, logic, and external trigger criteria can be combined by AND/OR logic to define complex trigger criteria.

Select from the **[Source]** setting options.

Setting options: (* default setting)

OR* Triggering occurs when any one of the specified trigger source criteria is met.

AND Triggering occurs only when all of the specified trigger source criteria are met.

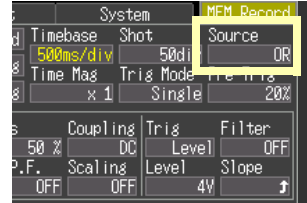

When the trigger combining logic is set to [AND]

If trigger criteria are already met when you press the START/STOP key, no triggering occurs. Triggering occurs only after all trigger sources have ceased to meet the criteria at once, and are subsequently met again.

To apply a trigger when the upslope (↑) of the waveform crosses zero volts

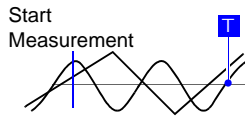
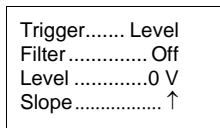

[AND]

One waveform has crossed above 0V as the other crosses on the upslope

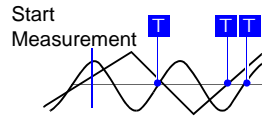

[OR]

Either waveform crosses 0V on the upslope

When the recording length is [Cont], the trigger source setting is disabled.

Setting the Trigger Start Point (Pre-Trigger)

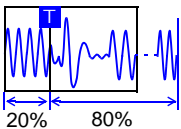

Make this setting to specify a portion of the waveform to be recorded prior to a trigger event, as a percentage of the overall specified recording length.

Select from the **[Pre-Trig]** setting options.

Setting options:

0*, 5, 10, 20, 30, 40, 50, 60, 70, 80, 90, 95, 100%

(* default setting)



Difference between [Waiting for pre-trigger] and [Waiting for trigger]

When measurement is started, the specified pre-trigger length is recorded. This period is indicated as the [Waiting for pre-trigger].

After the specified pre-trigger length has been recorded, the period indicated as [Waiting for trigger] continues until a trigger occurs.

During the [Waiting for pre-trigger] period, trigger events are not recognized even when the trigger criteria are met.

When the recording length is [Cont], the pre-trigger setting is disabled.

4.2 Triggering by Analog Signals

Selecting an Analog Trigger Type

Select the appropriate trigger type. Setting options differ by trigger type.

Select from the [Trig] setting options.
 Setting options: OFF*, Level, In, Out, Drop
 (* default setting)

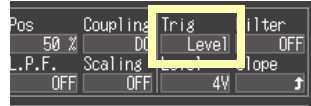

Type of Analog Trigger	Trigger Example	Description
Level Trigger [Level]		A trigger is applied when an input signal crosses the specified trigger level (threshold voltage).
In-Window Trigger [In]		A trigger is applied when the input signal enters a range defined by upper and lower thresholds.
Out-of-Window Trigger [Out]		A trigger is applied when the input signal exits a range defined by upper and lower thresholds.
Voltage dip Trigger [Drop]		A trigger is applied when the amplitude of the input signal (at commercial mains frequency) dips below the specified trigger level.

Setting Example

<p>Apply a trigger when the input signal exceeds 200 mV</p>	<p>Trigger Level (Level Trigger) Level 200 mV Slope ↑ (rising)</p>
<p>Apply a trigger when the input signal is outside of the range ±1 V</p>	<p>Trigger Out (Out-Window Trigger) Upper 1 V Lower -1 V</p>
<p>Apply a trigger if a 50-Hz mains frequency input signal, nominally about 220 Vrms (311.1 Vpeak), drops below 198 Vrms (280.1 Vpeak)</p>	<p>Trigger Drop Level 280 V Freq 50 Hz</p>

Selecting a Trigger Filter

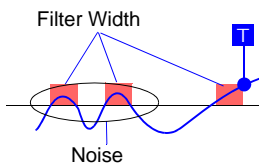

Sets the filter width (trigger filter) for triggering. Suppresses triggering from noise.

The filter width setting is defined according to the number of samples* of acquired data.

* Number of samples: 1 division = 100 samples (with x1 display magnification)

Select from the **[Filter]** setting options.

Setting options: **OFF***, 10, 20, 50, 100S

(* default setting)



Selecting Rising or Falling (Slope) of the Input Signal

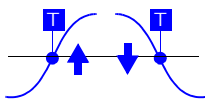

Set the slope (rising (↑) or falling (↓) edge) of the input signal on which to trigger.

Select from the **[Slope]** setting options.

Setting options: (* default setting)

↑* A trigger occurs when the signal crosses the threshold on the upslope (rising edge ↑).

↓ A trigger occurs when the signal crosses the threshold on the downslope (falling edge ↓).

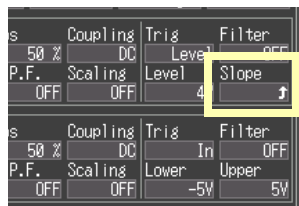

Setting the Signal Threshold Level (Trigger Level)

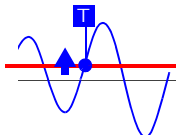

Set the signal threshold level (voltage value) at which the triggering is to occur. The trigger level setting value is an instantaneous value (*not* RMS). The setting value can be verified in the waveform monitor or on the Waveform screen. When scaling is enabled, the scaled trigger level value can be verified in the waveform monitor.

Select from the **[Level]** setting options.

Setting options: One twentieth of the voltage range [Rng/div] (Default setting: Zero volts for Level Trigger mode, and one division above the zero position for Voltage Sag trigger mode.)

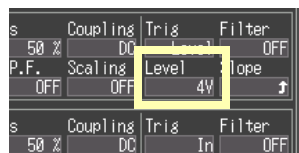

4.2 Triggering by Analog Signals

Setting Lower and Upper Trigger Thresholds

Set the upper and lower thresholds for a trigger window. Upper and lower thresholds can be verified in the waveform monitor or on the Waveform screen. When scaling is enabled, the scaled threshold values are displayed.

Select from the **[Lower]/[Upper]** setting options.
Setting options: One twentieth of the voltage range [Rng/div] (Default setting: One division below the lower limit zero position, and one division above the upper limit zero position.)

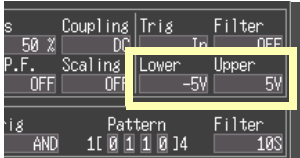

Selecting Measurement Frequency

Select the frequency of the commercial mains power to be measured.

Select from the **[Freq]** setting options.
Setting options: **50Hz***, **60Hz** (* default setting)

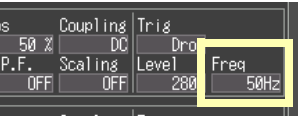

4.4 Triggering Manually (Manual Trigger)

Setting a Trigger Pattern

1 HIGH
0 LOW



Specify the state of each input signal required for triggering.

Select from the **[Pattern]** setting options.
Setting options: (* default setting)

- X* Ignore signal
- 0 Triggering occurs when the signal transitions from HIGH to LOW.
- 1 Triggering occurs when the signal transitions from LOW to HIGH.

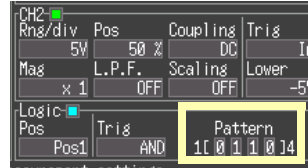

Setting a Trigger Filter

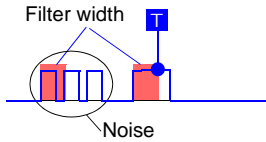

To enable trigger filtering, just specify a filter width (trigger filter). The filter can prevent false triggering due to noise. The filter width setting is defined according to the number of samples* of acquired data.
* Number of samples: 1 division = 100 samples (with x1 display magnification)

Select from the **[Filter]** setting options.
Setting options: **OFF***, 10, 20, 50, 100 S
(* default setting)

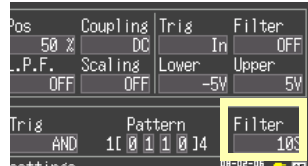

4.4 Triggering Manually (Manual Trigger)

Triggers can be applied manually. Manual triggering takes priority over all other trigger sources, regardless of settings.

At any time after starting measurement (by pressing the START/STOP key), you can press the **[T]** key to apply a manual trigger. However, manual triggering is disabled when the input channel trigger setting is OFF. After setting trigger criteria and starting measurement, the [Waiting for trigger] mode is active, during which a trigger can be generated by pressing the **[T]** key.

Waveform Analysis

Chapter 5

5.1 Viewing Waveforms

Waveform Screen

Displays a gauge (p. 66)

Trigger Mark (T)

The trigger mark appears at the point where a trigger is applied.

Logic waveforms

Analog waveforms
Displays acquired data as waveforms.

Time Values

Scroll Bar

Shows the range and position of the displayed waveform.
Viewing the Scroll bar (p. 64)

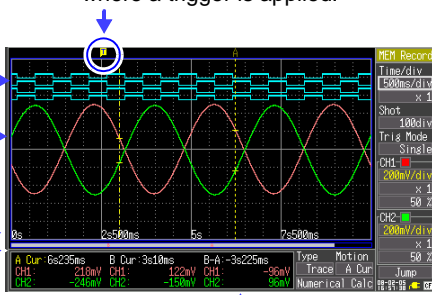

Measurement Configuration

You can change these settings (p. 41).
Analog Trigger Settings (p. 55)

Jump Function (p. 65)
Trace Display (p. 64)

A/B Cursor Values

(when A/B cursors are displayed)
Shows the values at cursor locations on the waveform (p. 66).
This can be switched to show numerical calculation results (p. 93).

The diagram shows a sequence of steps to navigate the waveform screen settings:

- 1** Select the Waveform Screen. (Buttons: WAVE/DATA, SET, FILE)
- 2** Move to a setting item. (Arrow pointing to the measurement configuration panel)
- Open the setting options for the item to be set. (Down arrow)
- Select from the listed options. (Left and right arrows)
- Apply. (Down arrow)

The measurement configuration panel on the right shows settings for Time/div (500ms/div, x1), Shot, Trig Mode (Repeat), CH1 (5V/div, x1, 50%), and CH2 (5V/div, x1, 50%). A 'Jump' function is also visible.

Scrolling Waveforms

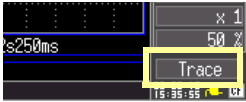
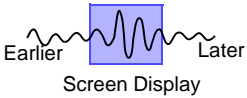

When measuring or displaying an existing waveform, use the SCROLL/CURSOR keys to scroll.

During Roll Mode display,* manually scrolling a waveform terminates the Roll Mode, so you can freely view any part of the measured waveform.

To return to Roll Mode, move the cursor to [Trace] near the bottom right corner of the display, and press the ENTER key. Alternatively, just scroll to the right end of the waveform to resume Roll Mode.

* About the Roll Mode display:

When each div shown on the Waveform screen is at least 50 ms, the screen scrolls automatically so that the newest part of the waveform is always displayed.

To jump to the start or end of a waveform (or between trigger events), hold the ESC key while pressing the right or left SCROLL/CURSOR key.

Verifying Waveform Display Position

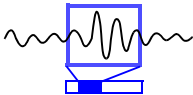

From the scroll bar you can verify the relative position and size of the displayed portion of a waveform within the overall recorded waveform. Trigger time, trigger position and A/B cursor positions (when using vertical or trace cursors) are also displayed.

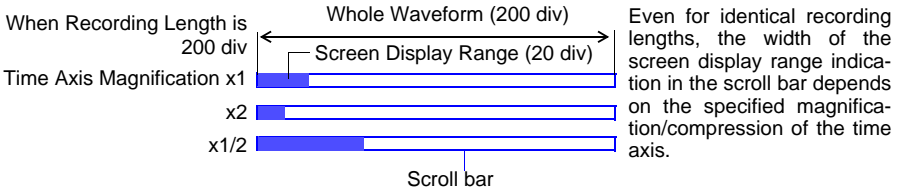

Magnifying and Compressing Horizontally (Time Axis)

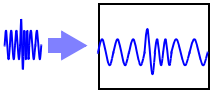

Data details can be observed by magnifying the waveform along the time axis. Also, by compressing the time axis, overall waveform fluctuations can be readily seen. Time axis magnification can be changed while measuring, and when the A/B cursors are displayed, magnification can be set according to cursor position (but only when finished measuring). Memory recorder mode from the magnification, RMS recorder mode Select from the settings of the time axis.

Select from the [x1](display magnification) setting options.

Setting options:





- x10, x5, x2, x1*, x1/2, x1/5, x1/10, x1/20, x1/50, x1/100, x1/200, x1/500, x1/1000 (* default setting)

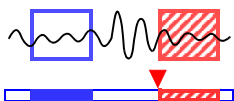

Viewing Any Waveform Location (Jump Function)



When the recording length of a waveform is long, you can specify the portion to be displayed immediately.

- 1 **WAVE/DATA** **SET** **FILE**

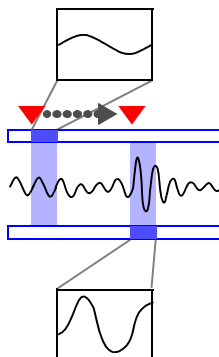
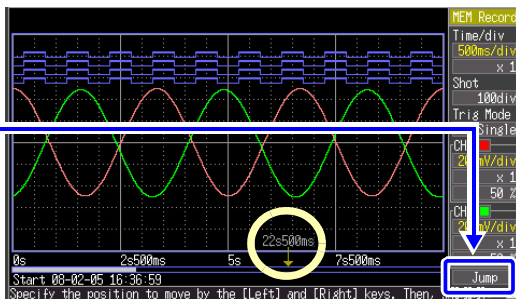
 Select the Waveform Screen.
- 2 
 Select **[Jump]**.
 Apply
 The location of the currently displayed portion of the overall waveform is indicated by the ▼ mark on the scroll bar.
- 3 
 Move the ▼ mark to display a different portion of the waveform.
- 4 
 Apply
 The portion of the waveform at the ▼ mark is displayed.

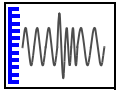

5.2 Viewing Measurement Values

Displaying Gauges



GAUGE



Press the GAUGE key to display gauges at the left side of the screen corresponding to the measurement range of each channel. Measurement values can be confirmed on the gauges. The color of each gauge matches the color of its waveform.

Press the GAUGE key again to hide the gauges.

Displaying Cursor Values

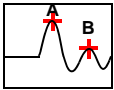

Time difference, frequency and potential difference (and when scaling is enabled, scaling values) can be read as numerical values using the A/B cursors.

See "About Cursor Values" (p. 67)

1



Displays the A/B cursors and the values at the cursor positions.
To hide the cursor items again, press the SCROLL/CURSOR key.

2

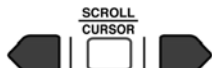

Move the cursors to display numerical values along the waveform.
Hold the ESC key to move by whole divisions.

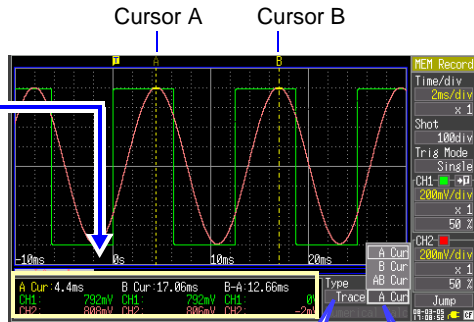

Cursor Values

[Type]
Trace*
Vert (Vertical)
Horz (Horizontal)
(* default setting)

[Motion]
A Cur*
B Cur
AB Cur
(* default setting)

Changing Cursor Type

To select which cursor(s) to move
Select from the [Motion] setting options.

To select the type of cursor values to display
Select from the [Type] setting options.

The current [Motion] selection can be changed directly, by holding the ESC key while pressing the central SCROLL/CURSOR key.

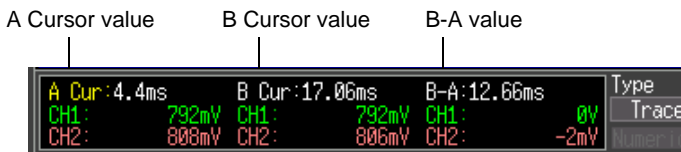

Trace Cursor case

About Cursor Values

Cursor Type	Example	Cursor Value
Trace Cursors		<p>Displays the time and measurement values at the A/B cursors, or the time and measurement differences between the A/B cursors.</p> <p>Displays the intersections (trace points) of cursors and waveforms. (the intersections of waveform traces of selected channels)</p> <p>(Time and Measurement Values)</p> <p>Time Values A Cursor value, B Cursor value: Time from trigger point or recording start B-A value: Time difference between A/B cursors</p> <p>Measurement Values A Cursor value, B Cursor value: Measurement value B-A value: Difference between measured values at A/B cursors</p>
Vertical Cursors		<p>Displays the time and frequency values at the A/B cursors, or the time and frequency differences between the A/B cursors.</p> <p>(Time Value and Frequency)</p> <p>Time Values (t): Time from trigger point or recording start Frequency (f): Frequency having period t B-A value: Time difference between A/B cursors</p>
Horizontal Cursors		<p>Displays the measurement values at the A and B cursors for the selected channel(s), or the difference between A/B cursor values.</p> <p>(Measurement Values)</p> <p>A Cursor value, B Cursor value: Measured value of channel B-A value: Difference between values at A/B cursors</p>

5.2 Viewing Measurement Values

Specifying a Waveform Time Span

Specify a waveform time span when saving a partial waveform or applying numerical calculations (Trace cursors or Vertical cursors).

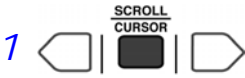

The A/B cursors and cursor values are displayed.

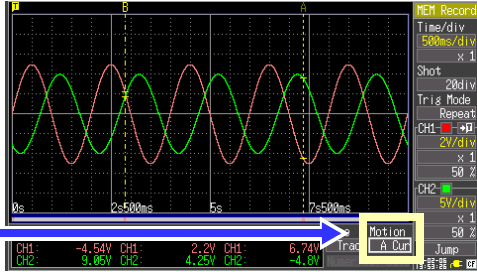

Select **[Motion]**.



Open the setting options for the item to be set.



Select which cursor(s) to move.



Apply

[Motion]
A Cur
B Cur
AB Cur

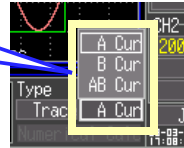

Move the A/B cursors to specify the time span.

Viewing Input Signals as Numerical Values (Numerical Value Display Function)

AC voltage measured at commercial mains frequencies (50/60 Hz) or DC voltage can be displayed as a numerical value. Either instantaneous or RMS numerical value can be displayed.

Instantaneous value: the input voltage

RMS value: the root-mean-square of the actual input voltage (p. 97)

Note that the RMS value is only displayed correctly for commercial mains frequencies (50/60 Hz) and DC signals.

If the input voltage peak value exceeds 450 V, "OVER" will be shown.

1  Select the Numerical Screen.

Normal Display

CH1 Numerical Value

CH2 Numerical Value

Gauge
Maximum count is 5500

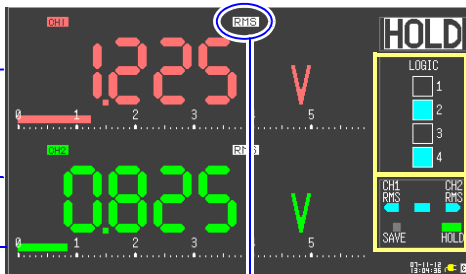

Display Hold
The displayed value is held constant.

Instantaneous logic values
(□: 0, ■: 1)

These depict operating key functions

RMS display mode indicator
(Indicates the current mode: RMS or instantaneous (P-P))

Scaling Indicators

Scaling Unit Indicators

Appears only when scaling is enabled for that channel (p. 50).

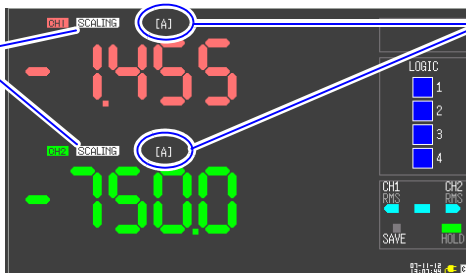

Units displayed after conversion by scaling settings

2 Switching between instantaneous and RMS values

Press these keys to toggle the selection

Toggles only CH1

Toggles only CH2

Toggles both CH1 and CH2

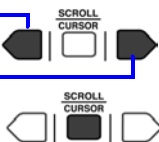

3 Holding and releasing display values

Press these keys to toggle the selection

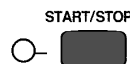

5.2 Viewing Measurement Values

Display when the input voltage peak value exceeds 450V

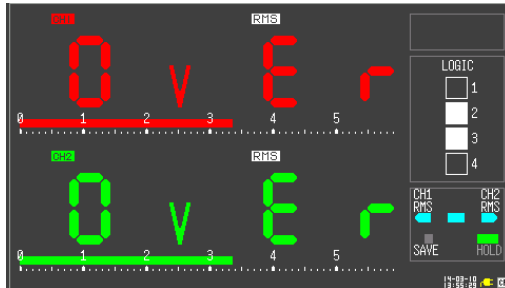

Saving & Loading Data

Chapter 6

Measurement data acquired by the Memory HiCorder can be saved to a CF card.

See: "6.2 Using a CF Card" (p. 74)

*To load data saved by the MR8870-20 in memory recorder mode with the 8870-20, upgrade the 8870-20 to firmware version 2.00 or later.

See: "Appendix 9 To 8870-20 Users (Firmware Ver. 1.08 or Earlier)" (p. A19)

Methods available for saving data consist of Auto Save, for saving data automatically while measuring; and Select & Save and Quick Save for saving data after measurement is finished. Refer to "6.3 Saving Data" (p. 77) for details.

6.1 About Saving and Loading Data

When saving data, a folder named **[HIOKI8870]** is created, and files are stored in the folder as follows. Up to 1,000 files can be saved in one folder.

O = Available, X = Not available

File Type	File Format	Folder Name	File Name (Auto-numbered from 1)	Save		Load	PC- Read- able
				Auto	Manu- al		
Settings Data	Binary	CONFIG	CONFIG0001.SET*7 CONFIG0001.SRM*8	X	O	O	X
Settings List	Binary	CONFIG	LIST0001.BDL	X	O	O	X
Waveform Data*1	Binary	Date of saving (e.g. 14-03-30) *3,*5,*6	WAVE0001.MEM*7 WAVE0001.RMS*8	O	O	O	O
	Text		WAVE0001.CSV	O	O	X	O
Numerical Cal- culation Results	Text		MEAS0001.CSV	O	O	X	O
			SCR0001.BMP*4	O	O	O	O
Captured Screen Image	BMP *2			O	O	O	O

- *1. To reload data into the instrument or load it into the Wave Processor program:
Save it in binary format. Waveforms and some of the measurement settings are saved.
To save a waveform partially, specify a period by using A/B cursors (p. 68).
- *2. BMP Format: This is a standard Windows graphics format. These files can be handled by many graphics programs.
- *3. When using auto-save functionality, a folder named AUTO*hhmmss* is created under a folder named with the date of saving (based on the trigger time), where *hhmmss* is the measurement start time.
(Example: The file AUTO131031 is created at the time 13:10:31)

6.1 About Saving and Loading Data

- *4. Also when auto-saving, screen images are saved in the file named [WAVE0001.BMP].
- *5. When the retrieved waveform is re-saved as waveform or display image data, it is saved under the date (year/month/date) folder (based on the trigger time) where the retrieved waveform file is saved.
- *6. When delete-and-save has been selected, a folder named [AUTO_D] will be created inside the HIOKI8870 folder, and all data for which auto-save has been enabled will be saved in that folder. All data saved in this folder is targeted by delete-and-save operation (i.e., potentially subject to deletion).
- *7. This filename is used when saving data in memory recorder mode.
- *8. This filename is used when saving data in RMS recorder mode.

See: "Appendix 2 File Naming" (p. A5)



Setting data (.SRM) and waveform data (.RMS) saved in RMS recorder mode cannot be loaded in memory recorder mode. To load these files, first switch the instrument to RMS recorder mode from any screen.(p. 38)

Directory Structure for Saved Data

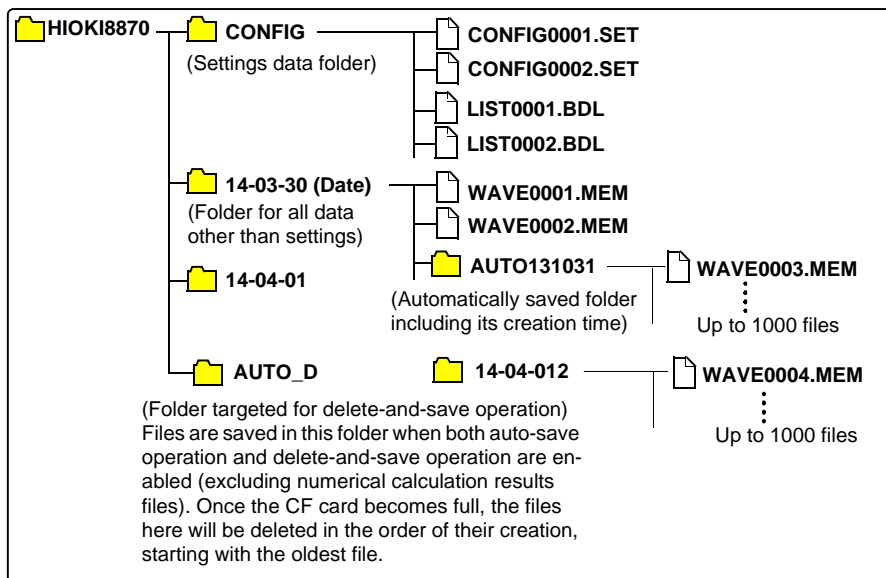

Model MR8870-20 waveform data size list (Memory recorder mode)

Recording length(div)	Binary	Text
20	12.8 KB	82.5 KB
50	27.4 KB	205.6 KB
100	51.8 KB	410.6 KB
200	100.7 KB	820.8 KB
500	247.1 KB	2.0 MB
1,000	491.3 KB	4.0 MB
2,000	979.6 KB	8.0 MB
5,000	2.4 MB	20.0 MB
10,000	4.8 MB	40.1 MB
20,000	9.5 MB	80.1 MB

In binary saving, all channels will be saved, regardless of whether the display is ON or OFF.

When saving as text, only the channel that is displayed will be saved.

The save column in the chart above is an example of the case of displaying and saving all channels.

For example, when using the 9729 PC Card (1GB), approximately 100 binary data of record length 20,000div files can be saved.

6.2 Using a CF Card

The following options are available for saving and loading measurement data with the Memory HiCorder.

Hioki options PC cards
(includes adapter)

- Model 9726 PC Card 128M
(*End of sale)
- Model 9727 PC Card 256M
(*End of sale)
- Model 9728 PC Card 512M
- Model 9729 PC Card 1G
- Model 9830 PC Card 2G

Important

Use only CF cards sold by Hioki. Compatibility and performance are not guaranteed for CF cards made by other manufacturers. You may be unable to read from or save data to such cards.

This Memory HiCorder does not require a CF (CompactFlash) adapter. See "6.5 Data Management" (p. 88) for details about managing data storage in the card.

CAUTION

- Format new CF cards before use.
To format with this instrument: (p. 76)
- Inserting a CF card upside down, backwards or in the wrong direction may damage the CF card or instrument.
- Never eject a CF card while it is being accessed by the instrument. Data on the CF card could be lost.
- During battery-only operation, data may fail to be stored properly if battery charge is exhausted while saving. In the worst case, the CF card could be damaged, so pay appropriate attention to the discharge state of the battery pack.
- If the Eject button is in the released position, press it in first before inserting the CF card all the way in. Inserting the CF card when the Eject button is released may damage the instrument. If the CF card does not go all the way in, do not force it in. Press the Eject button once to release it, then press it again and insert the CF card all the way in.
- As the CF card is sensitive to static electricity, damage to the CF card or wrong operations by the this instrument may occur due to static electricity. Please be careful when handling it.

NOTE

- The Flash memory in a CF card has a limited operating life. After long-term usage, data storage and retrieval become difficult. In this case, replace the CF card with a new one.
- We cannot provide compensation for data loss in a CF card, regardless of content or cause of the damage. Always maintain a backup of important data stored on a CF card.

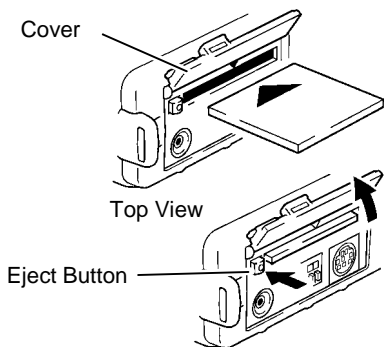
CF Card Insertion & Removal**Inserting a CF card**

- 1 Open the CF card slot cover.
- 2 Press the Eject button in if it is in the released position.
- 3 Face the CF card with the arrow mark (▲) on top, and insert it in the direction of the arrow all the way in the slot.

Removing a CF card

- 1 Open the CF card slot cover.
- 2 Press the Eject button (to release it).
- 3 Press the Eject button again and pull the card out.

6.3 Saving Data

Basically, three methods are available for saving.

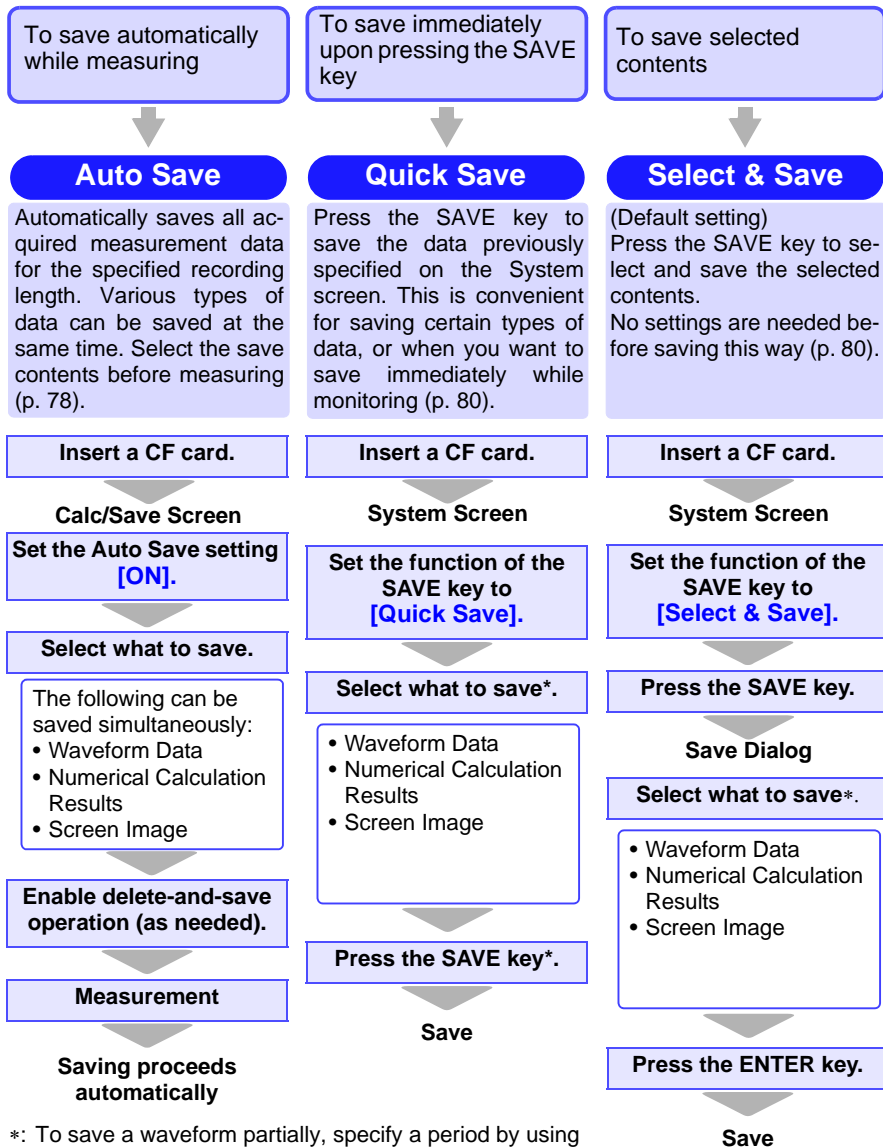

*: To save a waveform partially, specify a period by using A/B cursors. (Saving a waveform section is not available with Auto Save)
To save a screen image, display the desired screen before saving.

Automatic Saving

Before measuring, configure saving on the [Calc/Save] screen. Waveform data, screen images and numerical calculation results can be saved at the same time.

Before starting to measure, confirm that Auto Save is configured correctly, and that the CF card is properly installed.

1 **WAVE/DATA** **SET** **FILE** → **Calc/Save**

2 **Select the [Calc/Save] Screen.**

↓

3 **Move to a setting item.**

↓

4 **Open the setting options for the item to be set.**

↓

5 **Select from the listed options.**

↓

6 **Apply**

Display the numerical calculation result when this is "ON". Select 設定項目 (p. 93)

Set **[Auto Save]** to **[ON]**, and select the item(s) to save.

To Save Waveform Data

Set **[Waveform]** to **[ON]**.

From the **[Format]** options, select the data saving format.

Binary Select this format to be able to reload the saved data into the instrument, or so that it can be loaded into the Wave Processor program.

Text Select this format to save the data as a text file.

(When [Text] format is selected)

From the **[Thinning]** options, select the amount of data thinning desired.

1/2, 1/5, 1/10, 1/20, 1/50, 1/100, 1/200, 1/500, 1/1000, OFF* (* default setting)

1/2: Saves every other data point
(• X• X• X...)

1/5: 5Saves one of every five data points
(•XXXX•XXXX•XXXX...)

Saving Screen Images

Set **[Screen Image]** to **[ON]**.

[Format] BMP (fixed)

This is selected automatically when setting [Screen Image] to [ON].

To Save Numerical Calculation Results

Set **[Calc Results]** to **[ON]**.

Numerical calculation settings are necessary (p. 93).

3 After making any other necessary settings, press the START/STOP key.

Data is automatically saved to the CF card when measurement finishes. "Directory Structure for Saved Data" (p. 73)

⚠ CAUTION When the time axis setting is 50 ms/div. or slower, data will be saved while measurement is being performed. During automatic saving, a red progress bar will be shown on the Save in Progress dialog box. When the time axis setting is faster than 50 ms/div., data will be saved once measurement is complete.

Enabling Delete-and-save Operation

When delete-and-save operation is enabled, the oldest data will be deleted to make space for new files once available space on the CF card becomes limited during measurement that is performed with auto-save enabled.

[ON]

Once available space on the CF card becomes limited, the file with the oldest date of creation in the folder **[HIOKI8870]-[AUTO_D]** will be deleted to make space for a new file.

[OFF]

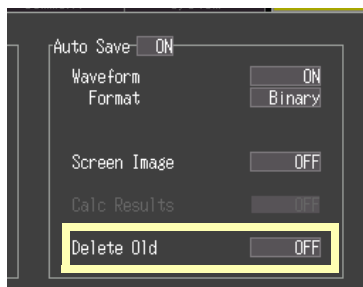

Data will be saved as long as there is space remaining on the CF Card. Once the card becomes full, data will no longer be saved.



NOTE When enabling Auto Save operation in RMS recorder mode, ensure that the CF card has at least 10 MB of available space when measurement is started. An error will result if there is not adequate space. On the other hand, when enabling delete-and-save operation, 10 MB of available space obtained by deleting files in the folder **[HIOKI8870]-[AUTO_D]** will avoid an error.

Selecting the Manual Saving Method [Quick Save]/[Select & Save]

Two manual saving methods are available: [Quick Save] and [Select & Save], both of which offer the same setting options. When saving waveforms, a folder (named with the date of saving) is created for data on the CF card, and saved files are automatically numbered (p. 71).

- 1  Select the [System] Screen.
- 2  Move to a setting item.
Open the setting options for the item to be set.
Select from the listed options.
Apply

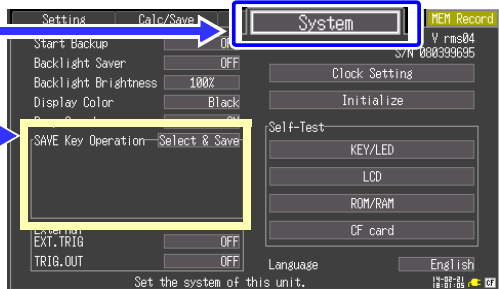

Selecting **[SAVE Key Operation]** setting options.

Setting options:(* default setting)

Select & Save* Pressing the SAVE key displays the setting options for saving.

Quick Save Select the setting options for saving on the [Calc/Save] screen before pressing the SAVE key.

[Select & Save]

SAVE



The Save dialog appears. Select from the saving options in this dialog.
Save Waveforms (p. 81)
Save Screen Image (p. 82)
Save Numerical Calculation Results (p. 83)

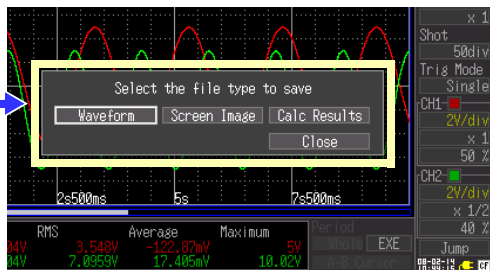

[Quick Save]

Setting items are displayed. Select your saving options.

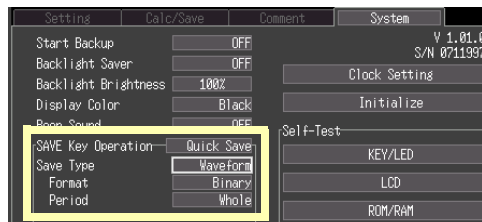

Saving Waveform Data (with the SAVE Key)

When saving waveform data, created files are automatically named WAVE $nnnn$.MEM, RMS (or .CSV) in a folder automatically named [HIOKI8870]-[save date], where $nnnn$ is an automatically generated serial number starting from 0001 and $date$ is the saving date (p. 71).

To save a partial waveform, specify the time span to save beforehand (p. 68).

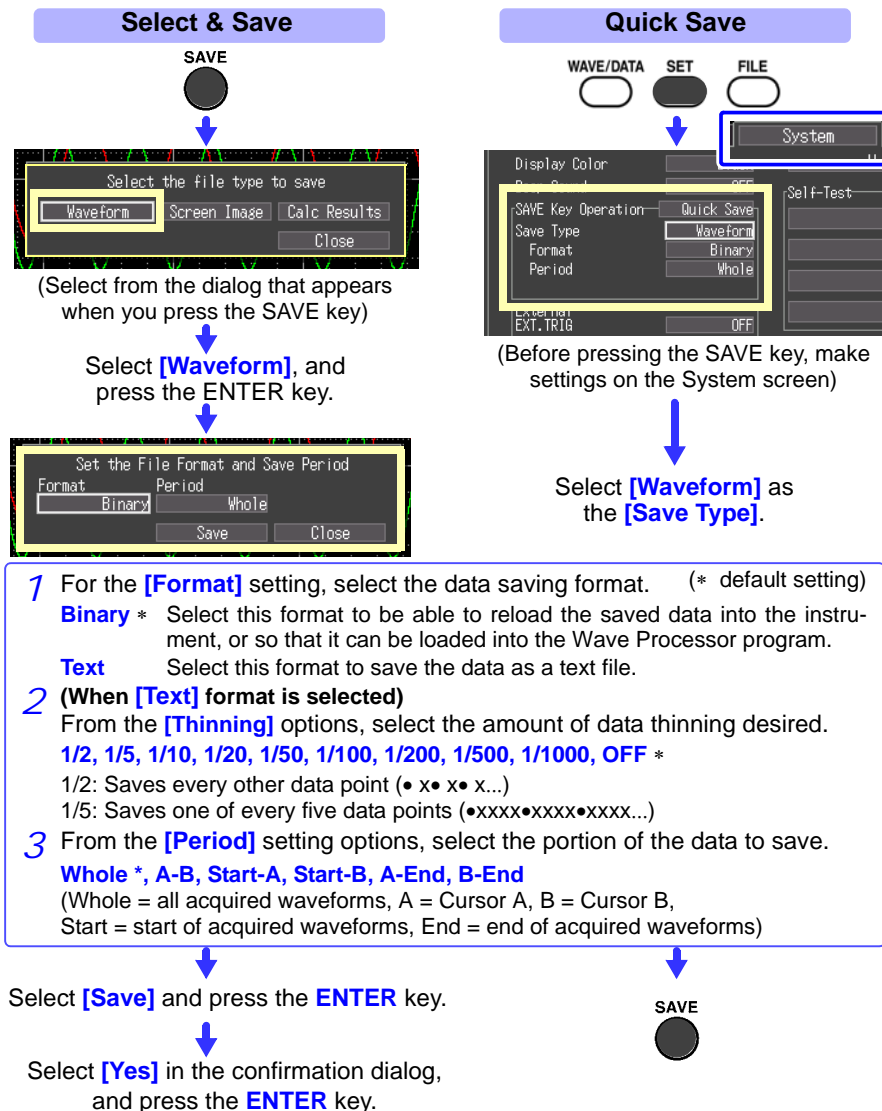

Capturing a Screen Image (With the SAVE Key)

Captured screen image files are automatically named SCRnnnn.BMP in a folder named [HIOKI8870]-[save date] (p. 71).

Select & Save

SAVE  Display the screen to capture, and press the SAVE key.



(Select from the dialog that appears when you press the SAVE key)



Select **[Screen Image]**, and press the ENTER key.



Select **[Yes]** in the confirmation dialog, and press the ENTER key.

Quick Save

WAVE/DATA  **SET**  **FILE** 

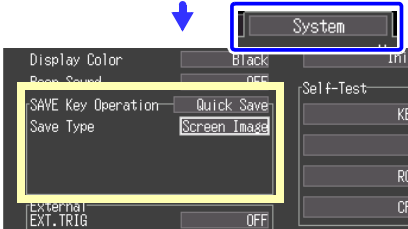

(Before pressing the SAVE key, make settings on the System screen)



Select **[Screen Image]** as the **[Save Type]**.



Display the screen to capture



Saving Numerical Calculation Results (With the SAVE Key)

Numerical calculation settings are necessary before saving results (p. 93). Numerical calculation result files are automatically named MEAS $nnnn$.CSV in a folder named [HIOKI8870]-[save date] (p. 71).

Select & Save

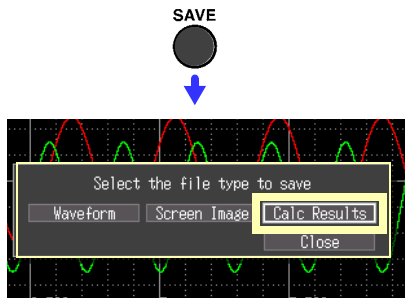

(Select from the dialog that appears when you press the SAVE key)

Select **[Calc Results]**, and press the ENTER key (p. 93).

Select **[Yes]** in the confirmation dialog, and press the ENTER key.

Quick Save

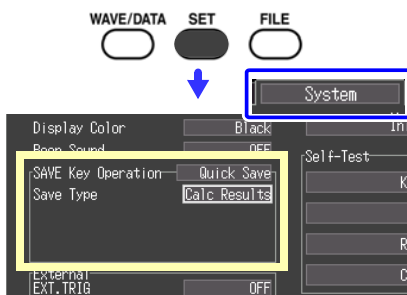

(Before pressing the SAVE key, make settings on the System screen)

Select **[Calc Results]** as the **[Save Type]**.

Display the numerical calculation results to be saved.



By specifying a particular time span for numerical calculation, only the results for that time span are saved.

Saving Setting Configurations

Setting configurations can be saved as data files and later reloaded into the Memory HiCorder when you need to make more measurements with the same settings. Up to ten setting configurations can be saved to internal memory, and more can be stored on a CF card.

1 Select the [Setting] Screen.

2 Select **[Save Setting]**.
 Apply
 The Save dialog appears.

3 Select whether to save to the MR8870-20's memory or to a CF card.
 Apply

4 (When **[Memory]** is selected)
 Select **[Save]** for the configuration instance (No.) to save.
 Enter a comment as needed.
 Apply

Comments entered on the [Comment] screen are displayed here.

No.	Setting Name	MODE	Save	Delete
1	SET1	MEM	Save	Delete
2	SET2	RMS	Save	Delete
3			Save	

When [Export] is selected, all the setting configurations saved in the internal memory can be saved as one file in the CF card. Saved under the file name [LIST + Automatic No. (0001).BDL] inside the [HIOKI8870]-[CONFIG] folder.
 When reading the setting list file (LISTxxxx.BDL) saved in the CF card on this instrument, all the 10 settings inside the internal memory will be overwritten.

(When [CF Card] is selected)
 Setting configuration files are automatically named CONFIGnnnn.SET (at memory recorder mode) in a folder named [HIOKI8870]-[CONFIG] (p. 71). To reload a setting configuration, see p. 85.
 In RMS recorder mode, files will be saved with the extension .SRM.

6.4 Loading Data on the Memory HiCorder

Previously stored binary waveform data, captured screen images, saved setting configurations and setting list can be reloaded into the Memory HiCorder (p. 71). Data stored on a CF card can also be transferred to a computer using the supplied USB cable (p. 91).





Waveform files (.RMS) and setting files (.SRM) saved in RMS recorder mode cannot be loaded in memory recorder mode. Additionally, waveform files (.MEM) and setting files (.SET) saved in memory recorder mode cannot be loaded in RMS recorder mode. Change the mode as appropriate before loading files.

Loading a Setting Configuration

Setting configurations saved in the Memory HiCorder's memory or on a CF card can be reloaded.

How to save a setting configuration: p. 84

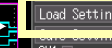

- 1  → 

Select the [Setting] Screen.
- 2  → 

Select [Load Setting].

 Apply

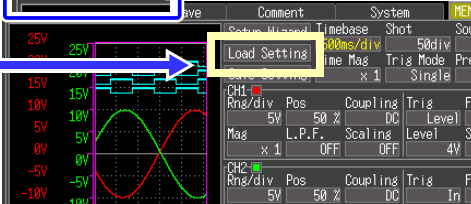

The loading dialog appears

- 3  → 

Select whether to load a setting configuration from MR8870-20's memory or CF card

 Apply

- 4 (If you selected [Memory])

 → 

Select [Load] for the configuration you want to load

 Apply



Setting List	MODE	
0. 1 SET1	MEM	Load
0. 2 SET2	RMS	Load
0. 3		Load

When Loading from Memory HiCorder Memory
The list of configurations stored in Memory HiCorder memory is displayed.

6.4 Loading Data on the Memory HiCorder

(If you selected **[CF Card]**)

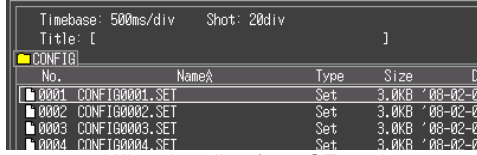
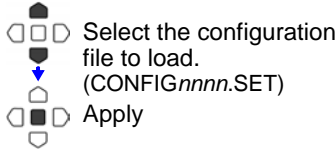

When Loading from CF card

Configuration files stored in the [HIOKI8870]-[CONFIG] folder on the CF card are displayed.

Memory HiCorder settings are reconfigured to those in the loaded configuration file.

Load the setting configuration data automatically

Method 1. Loading from instrument memory

- 1 Open the screen for loading the setting configuration. (Up to step 3 on the previous page)
- 2 Specify the number of the setting configuration you want to load automatically and input it into **[Auto Load]**.

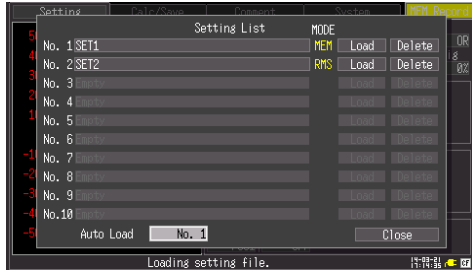

Setting options:(* default setting)

- Off*** Loading is not performed automatically.
- [No1] to [No10]** Select the file to load automatically.

Method 2. Loading from external storage media

- Setting configuration data saved as a file named STARTUP.SET or STARTUP.SRM in the [HIOKI8870] - [CONFIG] folder of the CF card is automatically loaded at power-on. STARTUP.SET will start up in memory recorder mode, STARTUP.SRM will start up in RMS recorder mode.
- In both cases, you can read in favor of the measurement mode during start-up.

Loading Waveform Data and Screen Images

Waveform data saved in binary format, or captured screen images, can be reloaded into the Memory HiCorder.



Select the File Screen.
The contents of the CF card
are displayed.

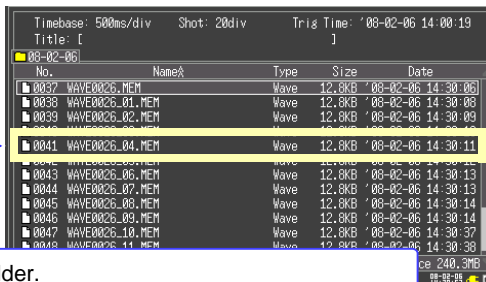

Select a file to load.

Displays the parent folder.
 Displays the child folder.
After selecting a folder by pressing the ENTER key,
select **[Change folder]** in the displayed control dialog box.



Apply

The control dialog box appears.

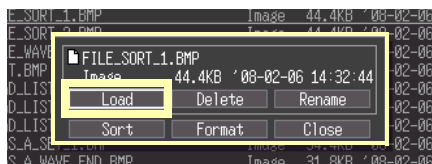

Select **[Load]**.



Apply

The selected file content is displayed on the waveform screen.

When binary format waveform data and screen images have been automatically saved together, you can switch the display between the two.

Load the screen image (WAVE $nnnn$.BMP)

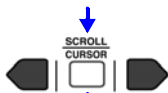

Switch to the screen image files
in the same folder.

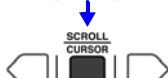

Loads the waveform data cor-
responding to the screen im-
age file with the same name.

The loading dialog appears
Select **[Yes]** and press the
ENTER key to display the
waveform data.

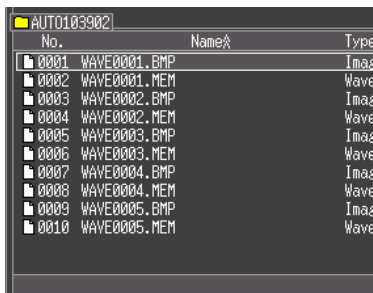

6.5 Data Management

You can manage data stored on a CF card in the Memory HiCorder.

- Load a file (when the file is selected) (p. 85)
- Move displayed folders (when the folder is selected) (p. 88)
- Delete data (p. 89)
- Rename files and folders (p. 89)
- Sort files (p. 90)
- Format a CF card (p. 76)

The following operations can be performed from the control dialog box displayed by pressing the ENTER key from the File screen.



Select the File Screen.



Opens the control dialog box.

Viewing Folder Contents and the Parent Folder



Select the File Screen.

The contents of the card are displayed.

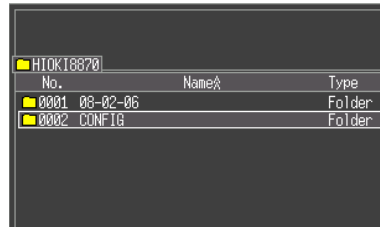

Select a folder to view.





View child folder (view contents of the currently highlighted folder)
(press the ENTER key and select **[Folder]** in the displayed control dialog box)

Displays the parent folder.

Deleting Data

Folder and files on the CF card can be deleted.

- 1  Select the File Screen.
The contents of the CF card are displayed.

- 2  Select a file to delete.

 Apply

- 3  Select **[Delete]**.

 Apply

A confirmation dialog appears.

Select **[Yes]** and press the ENTER key to delete.

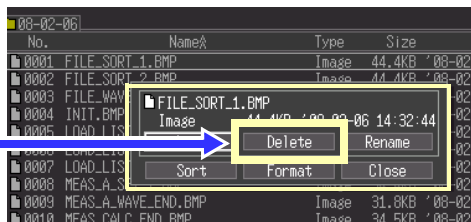

Renaming Files and Folders

Folders and files on a CF card can be renamed. File names may consist of up to 26 regular characters.

- 1  Select the File Screen.
The contents of the CF card are displayed.

- 2  Select the file or folder to rename.

 Apply

- 3  Select **[Rename]**.

 Apply

The character entry dialog appears.

Enter the new file name (the same way as when entering a comment) (p. 52)

A confirmation dialog appears.

Select **[Yes]** and press the ENTER key to apply the new name.

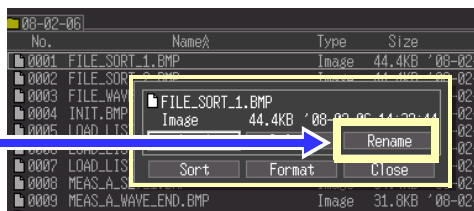

Sorting Files

Files can be sorted in ascending or descending order according to a selected sort key.

1  Select the File Screen.

2  Apply
The control dialog box appears.

3  Select **[Sort]**.

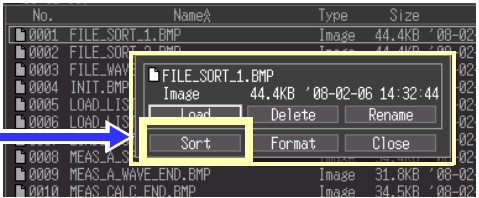

 Apply

4  Select the key on which to sort.

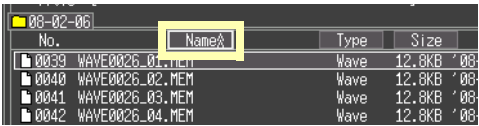

 Apply

5  Select the desired sort order.
(Ascending or Descending)
Files are displayed in the new sort order

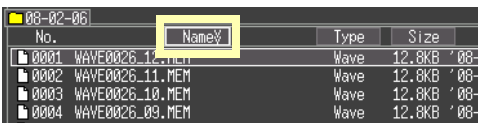

6  Finish

6.6 Transferring Data to a Computer

Using the supplied USB cable, data stored on a CF card in the Memory HiCorder can be transferred to a computer. To analyze the data using an application program, refer to the instructions for the program.

See: "Appendix 3 Wave Processor Application Program" (p. A6)

Computer Requirements

A personal computer running Windows XP, Vista, 7, or 8



- Do not eject the CF card or pull out the USB cable during data transfer. Doing so would prevent proper data transfer.
- The Memory HiCorder and computer should be connected to the same earth ground. If grounded separately, potential difference between the ground points can cause malfunctions or damage when connecting the USB cable.

Connecting the USB Cable

Connection Precautions

Connecting the cable while measuring or with the File screen displayed will prevent the computer from recognizing the Memory HiCorder. Also, the Memory HiCorder cannot be operated during the connection process.

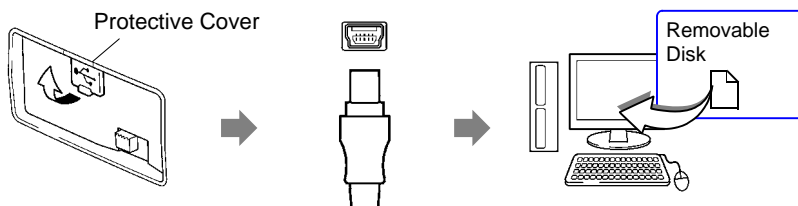

- 1 Open the protective cover over the USB connector.
- 2 Orient the USB cable plug properly, and insert it into the receptacle.
- 3 Connect the other end of the cable to a USB port on the computer.

The computer should recognize the Memory HiCorder as a removable disk when the cable is connected. Only data in the CF card inserted in this Memory HiCorder can be accessed from the computer. Data not saved in the CF card cannot be accessed.

USB Disconnection Procedure

Before unplugging the USB cable connected to the Memory HiCorder, select the "Safely Remove Hardware" icon in the Windows notification area, and click the mass storage device corresponding to the Memory HiCorder to remove.

Numerical Calculations

Chapter 7

7.1 Calculation Methods

Calculations can be applied to measured data. Seven types of numerical calculation are available, four of which can be applied at the same time. Refer to "7.2 Numerical Value Calculation Expressions" (p. 97) for details of the calculation methods. You can specify the measurement time span over which calculations are to be applied (p. 96).

Types of calculations

- Average value Average value of waveform data
- RMS value RMS value of waveform data
- Peak-to-Peak (P-P) value Peak-to-peak value of waveform data
- Maximum value Maximum value of waveform data
- Minimum value Minimum value of waveform data
- Period Period of signal waveform
- Frequency Frequency of signal waveform

Two methods are available for applying calculations, as follows.

Auto Calculation

Configure numerical calculations before starting measurement. Calculations are performed automatically after measurement (p. 94).



(Calc/Save Screen)

Set Numerical Calculation to **[ON]**, and select the calculation types

To save calculation results automatically
(Calc/Save Screen)
Enable Auto Save (p. 78)

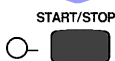

Start and finish measuring

Analyze (p. 63)

Calculating After Measuring

Configure numerical calculations after measurement (p. 95).

End of Measurement



(Calc/Save Screen)

Set Numerical Calculation to **[ON]**, and select the calculation types.







(Waveform Screen)
Execute Calculations



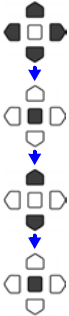

Analyze (p. 63)

Auto Calculation

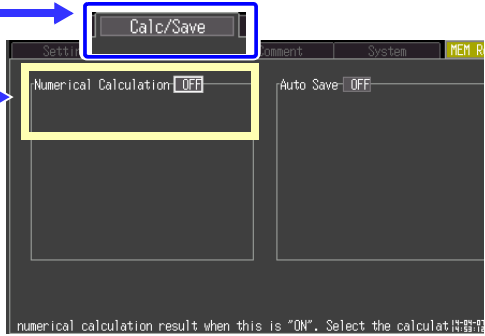
Numerical calculations are performed automatically after measurement.

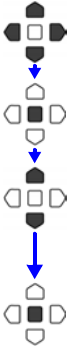
- 1  Select the [Calc/Save] Screen.
- 2  Select [Numerical Calculation].
 Open the setting options for the item to be set.
 Select [ON].
 Apply



- 3  Select any of No. 1 to No. 4.
 Open the setting options for the item to be set.
 Select the calculation type.
 Calculation types:
Average, RMS Value, P-P Value, Maximum, Minimum, Period, Frequency (or OFF, the default)
 Apply

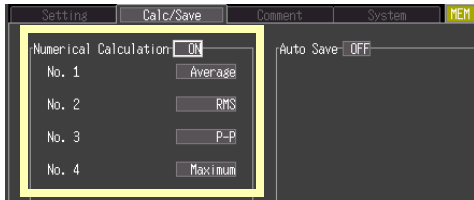

- 4 Enable Auto Save (if automatic saving is needed) "Automatic Saving" (p. 78)

- 5  Start and finish measuring

- 6 Analyze (p. 63)

The results of numerical calculations are displayed on the Waveform screen.

Manual Calculation

1 **START/STOP** Start and finish measuring

2 **WAVE/DATA** **SET** **FILE**
Select the [Calc/Save] Screen.

3 **NUMERICAL CALCULATION**
Select [Numerical Calculation].
Open the setting options for the item to be set.

Select [ON].

Apply

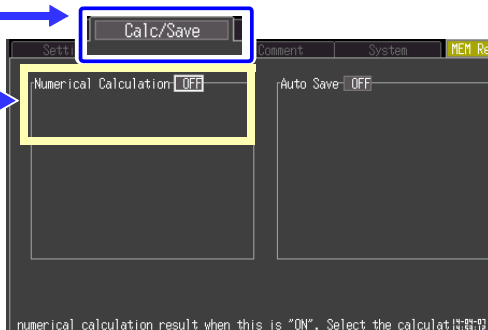

4 Select any of No. 1 to No. 4.

Open the setting options for the item to be set.

Select the calculation type.

Calculation types:

Average, RMS Value, P-P Value, Maximum, Minimum, Period, Frequency (or **OFF**, the default)

Apply

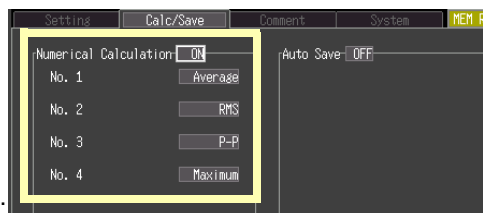

5 **WAVE/DATA** **SET** **FILE**
Select the Waveform Screen.

6 Select [EXE].

Apply

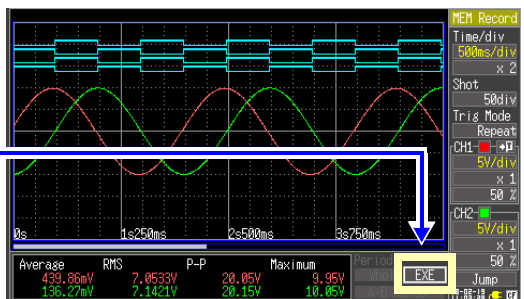

7 Analyze (p. 63)



The results of numerical calculations are displayed on the Waveform screen. If needed, you can change calculation types and recalculate.

Apply Calculations to a Specific Time Span (Manual Calculation Only)



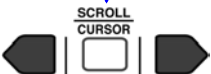

After measuring, calculation can be applied to a specified time span. Make any other calculation settings before specifying the calculation time span (p. 95).

1  Display A/B Cursors.

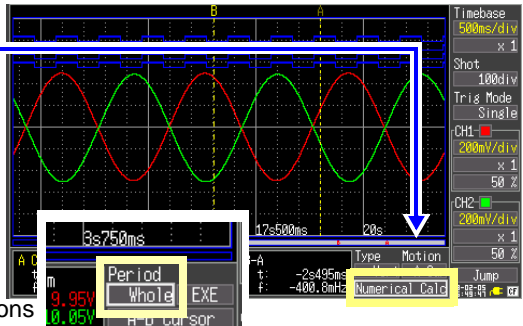

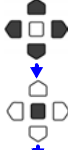
 Position the A/B cursors to define the calculation time span.
To select which cursor to move: p. 68

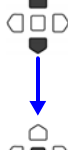
2  Select **[Numerical Calc.]**
 Apply

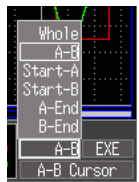

3  Select **[Period.]**
 Open the setting options for the item to be set.
 Select the calculation time span
Whole, A-B, Start-A, Start-B, A-End, B-End
 Apply



4  Select **[EXE.]**
 Apply

The results of calculations are displayed.

- **Whole:** the entire acquired waveform
- **A-B:** the time span between cursors A and B
- **Start-A:** From the start of the acquired waveform to cursor A
- **Start-B:** From the start of the acquired waveform to cursor B
- **A-End:** From cursor A to the end of the acquired waveform
- **B-End:** From cursor B to the end of the acquired waveform

7.2 Numerical Value Calculation Expressions

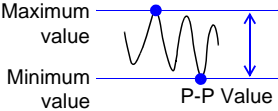
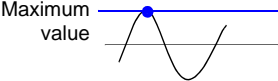
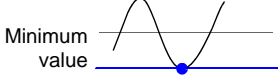
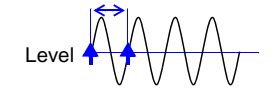
Average	$AVE = \frac{1}{n} \sum_{i=1}^n di$	<p>Obtains the average value of waveform data.</p> <p>AVE : Average value <i>n</i> : Data count <i>di</i> : Data on channel number <i>i</i></p>
RMS (Root-Mean-Square) Value	$RMS = \sqrt{\frac{1}{n} \sum_{i=1}^n di^2}$	<p>Obtains the RMS value of waveform data.</p> <p>If Scaling is enabled, calculations are applied to the waveform after scaling.</p> <p>RMS : RMS value <i>n</i> : Data count <i>di</i> : Data on channel number <i>i</i></p>
Peak-to-Peak (P-P) Value	 <p>Maximum value Minimum value P-P Value</p>	<p>Obtains the value of the difference (peak-to-peak value) between maximum and minimum values of waveform data.</p>
Maximum Value	 <p>Maximum value</p>	<p>Obtains the maximum value of waveform data.</p>
Minimum Value	 <p>Minimum value</p>	<p>Obtains the minimum value of waveform data.</p>
Period and Frequency	 <p>Level</p>	<p>Displays the period (in seconds) and frequency (Hz) of the signal waveform. Calculations are based on the interval between successive rising or falling transitions of the signal waveform through its amplitude mid-point in the same direction.</p>

NOTE Note that values falling outside the measurement range's valid input range are replaced in calculations with the valid input range's upper limit value and lower limit value.

System Environment Settings

Chapter 8

Settings affecting the clock, SAVE key operation and self testing are made from the System screen.

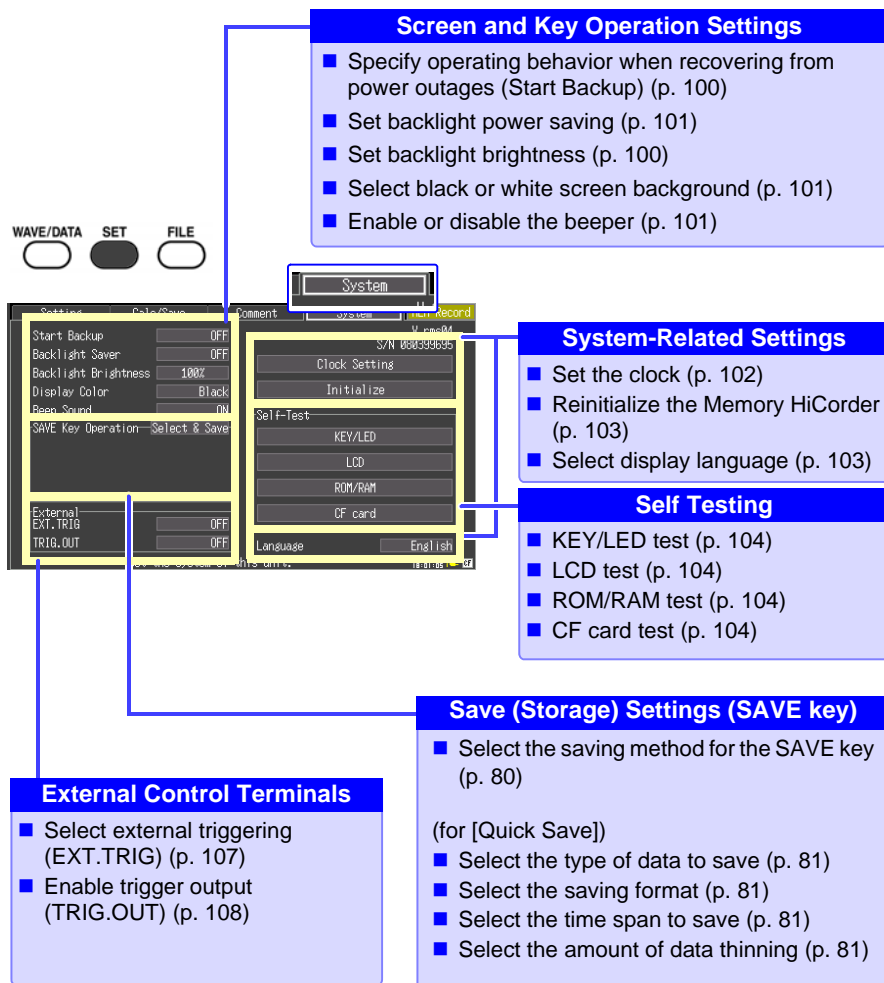

8.1 Screen and Key Operation Settings

1 **WAVE/DATA** **SET** **FILE**
Select the [System] Screen.

2
Move to a setting item.

Open the setting options for the item to be set.

Select from the listed options.

Apply

Using the Auto-Resume Function (Resume After Power Restoration)

If a power outage or other power loss causes an interruption in recording (while the LED on the left side of the START/STOP key is lit), you can automatically resume recording when the power is restored. If you are using triggers, the triggers are restored to the [Waiting for trigger] state.

Select from the **[Start Backup]** setting options.

Setting options:(* default setting)

ON Use the Auto-Resume Function.

OFF* Do not use the Auto-Resume Function.

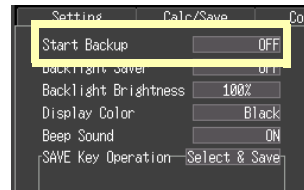

Adjust backlight brightness

Backlight brightness can be selected from four levels. Lower brightness settings provide longer battery operating time.

When the [Backlight Brightness] setting is selected, pressing the ENTER key repeated cycles through the four brightness levels.

Setting options: **100%***, **70%**, **40%**, **25%** (four-step brightness setting) (* default setting)

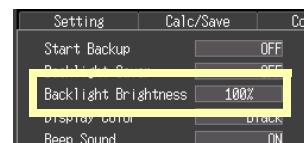

Enabling and Disabling the Backlight Saver

A backlight saver can be activated after a specified number of minutes during which no operation key is pressed. The backlight saver turns off the backlight of the LCD, prolonging the lifetime of the backlight by turning it off when not needed.

To deactivate the backlight saver, press any key. The operating screen appears again.

While the backlight saver is active, the Memory HiCorder's measuring state is still indicated by the LED (lights green when measuring, and blinks when not measuring).

Select from the **[Backlight Saver]** setting options.

Setting options:(* default setting)

OFF* Disables the backlight saver function. The operating screen is always displayed.

1min, 2min, 3min, 4min, 5min The backlight saver is activated if the specified time is exceeded.

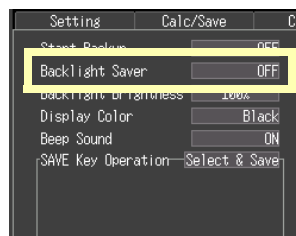

Be aware that power is still consumed even when the backlight is off, so be sure to turn the Memory HiCorder power switch off when not in use.

Selecting Black or White Screen Background

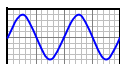
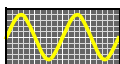

The screen background can be set to black or white.

Black Background White Background

Select from the **[Display Color]** setting options.

Setting options:(* default setting)

Black* Make background black

White Make background white.

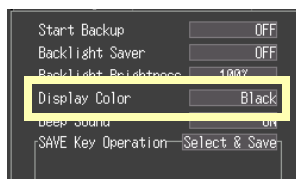

Enabling or Disabling the Beeper

The beeper can be set to sound when an error occurs.

Select from the **[Beep Sound]** setting options.

Setting options:(* default setting)

OFF Do not emit beep sound.

ON* Emit a beep sound on error messages (error and warning displays).

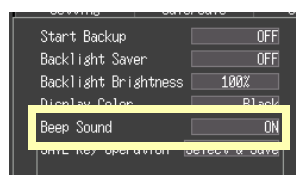

8.2 Making System Settings

Setting the Date and Time

The MR8870-20 is equipped with an auto-calendar, automatic leap year detection, and a 24-hour clock.

If the clock is not set to the correct time, measurement start time (trigger time) and file date information will be incorrect. If this occurs, reset the clock.

- 1 Select the [System] Screen.
- 2 Select [Clock Setting].
Apply
The setting dialog appears.

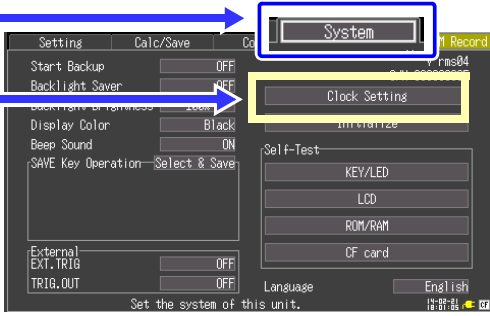

- 3 Select an item to change. (year, month, day, hour, minute or second)
Apply
Adjust the setting.
Apply
- 4 Select [Set].
Apply
The clock is reset.

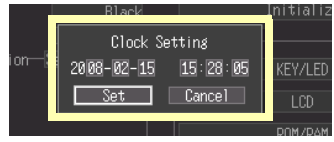

- Change 1's digit
- Change 10's digit

Initializing the Memory HiCorder (System Reset)

This procedure resets all settings to their factory defaults.

The system is reset by pressing and holding the START/STOP key while turning the Memory HiCorder POWER switch on.

For details about the factory default settings, see "Appendix 4 List of Default Settings" (p. A9).

1  Select the [System] Screen.

2  Select [Initialize].
Apply
A confirmation dialog appears.

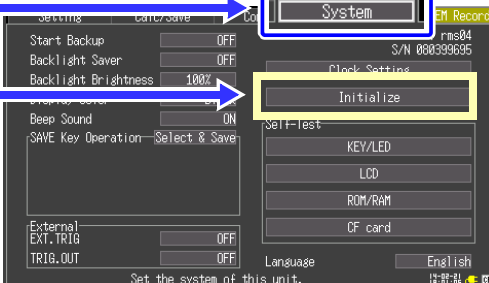

The screenshot shows the 'Settings' menu with 'System' highlighted in a blue box. Below it, the 'Initialize' option is highlighted in a yellow box. Other options include Start Backup, Backlight Saver, Backlight Brightness, Beep Sound, SAVE Key Operation, External EXT. TRIG, TRIG. OUT, Language, and Em Record.

3  Select [Yes].
Apply

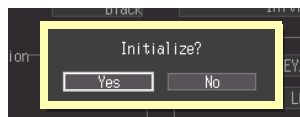

Initialization proceeds.

Setting configurations stored in Memory HiCorder memory are not affected.

To delete stored setting configurations, press and hold both the SAVE and START/STOP keys simultaneously.

When the power is switched on, the language selection screen will display for you to choose the language you wish to use.

Selecting the Display Language

Select the display language.

Select from the [Language] setting options.

Setting options: (* default setting)

English* Display in English.

Japanese Display in Japanese.

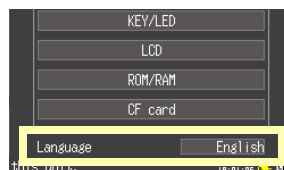

Self-Test

The following self tests are available. Results are displayed on the screen. If any faults are found, have the Memory HiCorder repaired. Contact your dealer or Hioki representative.

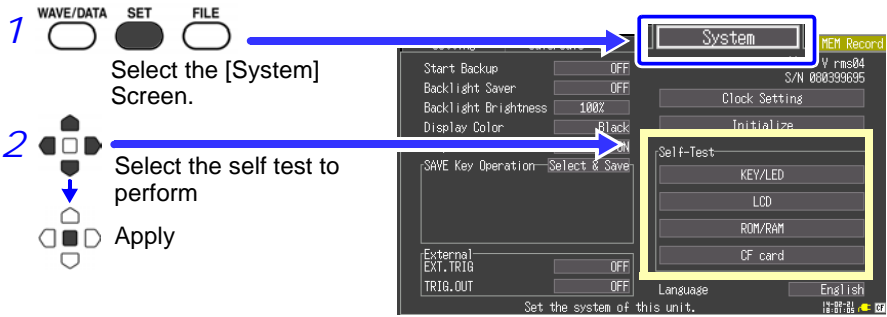

Self-Test	Details
KEY/LED	<p>Tests the keys and LEDs for correct operation. After every key has been pressed, the KEY/LED check finishes. Pressing the START/STOP key also tests whether the LED lights.</p> <p>If you notice a malfunction, press the SAVE and START/STOP keys simultaneously to abort the test.</p>
LCD	<p>Tests the screen display (color test, gradation test, character test) The screen changes each time you press an operation key.</p> <p>If the display screen seems abnormal, request repairs.</p>
ROM/RAM	<p>Tests the instrument's internal memory (ROM and RAM) If "NG" appears, request repairs.</p>
CF card	<p>Tests whether the Memory HiCorder recognizes the inserted CF card. The CF card is formatted (p. 76)</p>

External Control

Chapter 9

The external control terminals on the Memory HiCorder support trigger signal input and output.

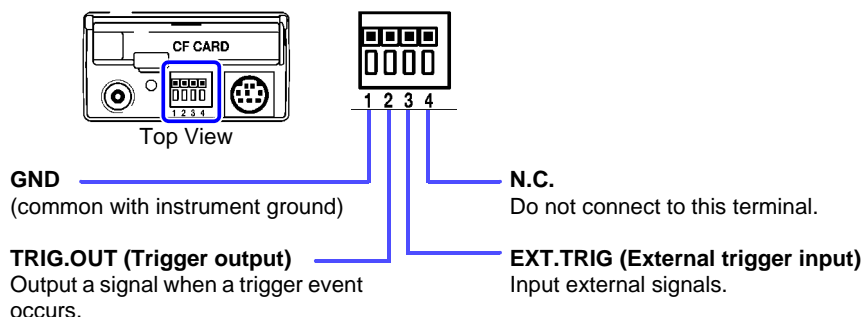

9.1 Connecting to the External Control Terminals



To avoid electrical hazards and damage to the instrument, do not apply voltage exceeding the rated maximum to the external control terminals.

	I/O terminals	maximum rated voltage between terminals
Input	EXT.TRIG	-2 to 7 V DC
Output	TRIG.OUT	-20 to 30 V DC 5 mA max, 200 mW max



To prevent electric shock accidents and damage to the equipment, always observe the following precautions when making connections to external terminal blocks and external connectors.

- Before making connections, turn off the power on the instrument and the equipment to connect.
- Do not exceed the specified signal levels for signals supplied to external terminal blocks.
- Ensure that devices and systems to be connected to the external control terminals are properly isolated.

9.1 Connecting to the External Control Terminals



- The external control ground terminal is not isolated from the Memory HiCorder's chassis ground. Make certain that there will be no potential difference between the external control ground terminal and the ground of any connected device. Otherwise, the Memory HiCorder or device could be damaged.
- To avoid electric shock, use the recommended wire type to connect to the external control terminals, or otherwise ensure that the wire used has adequate current-handling capacity and insulation.

Terminal Connections

- Recommended cables:
single strand diameter 0.65 mm (AWG22),
multi-strand 0.32 mm² (AWG22)
- Usable cables:
Single strand diameter 0.32 to 0.65 mm (AWG28 to 22),
Multi-strand 0.08 to 0.32 mm² (AWG28 to 22)
Strand diameter 0.12 mm or greater (per wire)
- Standard insulation stripping length: 9 to 10 mm
- Button operation specified tool: Flat-blade screwdriver
(tip width 2.6 mm)

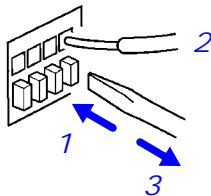
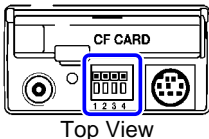
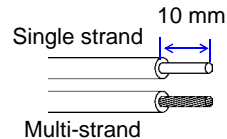

- 1 Push in the button on the connector with a flat-blade screwdriver or other tool.
- 2 With the button held in, insert the cable into the cable connection hole.
- 3 Release the button. The cable is locked.

9.2 External Trigger Input

Triggering can be controlled by applying a signal from an external trigger source. This allows synchronous operation of multiple Memory HiCorders by parallel triggering (p. 109).

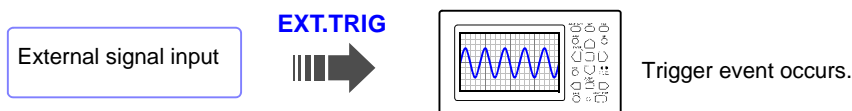

When the recording length is [Cont], the external trigger is disabled.

Trigger Input Signals

Voltage range	HIGH level: 3.0 to 5.0 V, LOW level: 0 to 0.8 V
Pulse width	HIGH level: 1 ms or greater, LOW level: 2 μ s or greater
maximum rated voltage between terminals	-2 to 7 V

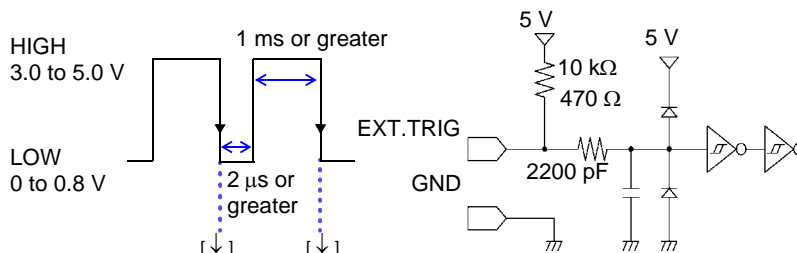

Signal Input Procedure

- 1 Connect the cables for the corresponding external input signals to the EXT.TRIG and GND terminals.
- 2 Press the SET key to open the [System] screen.
- 3 Set [EXT.TRIG] to [ON].
- 4 Short-circuit the EXT.TRIG terminal and GND, or leave the terminals open-circuited, and input a HIGH level (3.0 to 5.0 V) or LOW level (0 to 0.8 V) pulse wave or rectangular wave to the EXT.TRIG terminal. A trigger event occurs on the falling edge of the input waveform.

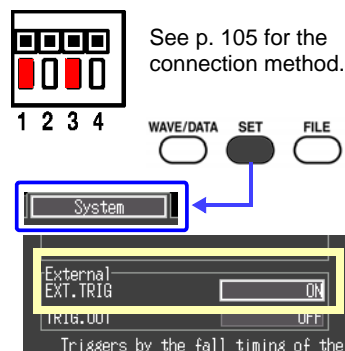

9.4 Synchronous Measurements with Multiple Instruments

Multiple instruments can be synchronized using the external control terminals. Two methods are available.

Daisy chain configuration

Set all instruments to master.

Set external trigger to [ON] for all instruments.

When a trigger event occurs on any of the connected instruments, it also occurs on the others. As more instruments are connected, the difference between trigger timing on different instruments becomes larger.

Connection example

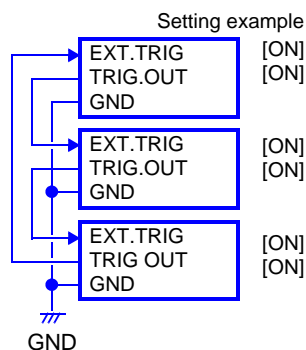

Parallel synchronization

Set one instrument to master, and set the others to slave.

Set external trigger to [ON] for the slave instruments only.

When using the master instrument as the trigger source, the other instruments start measuring simultaneously when a trigger event occurs. This gives the least difference in trigger timing between instruments.

Connection example

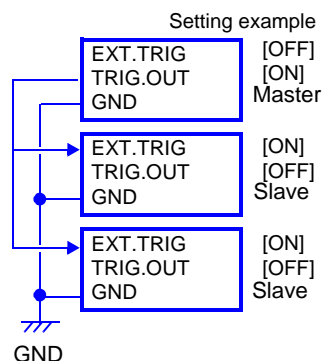

Specifications Chapter 10

(1) General Specifications

Basic Specifications

Measurement functions	Memory Recorder, RMS Recorder
No. of channels (max.)	2 analog channels + 4 logic channels (Logic ground is common with chassis ground)
Memory capacity	12-bit x 2M Words/Ch
Maximum sampling rate	1 MS/s (All channels simultaneously)
Timebase accuracy	±0.01% (Relative grid timing error)
External terminals	External Trigger Input, Trigger Output and GND
Clock functions	Auto calendar, auto leap year judgment, 24-hour timer Accuracy: ±50ppm (0°C to 40°C), Nominal value: ±10ppm (25°C)
Backup battery life	Approx. five years for clock and settings (@25°C, 77°F)
Conditions of guaranteed accuracy	After 30 minutes warm-up
Operating temperature and humidity	0 to 40°C (32 to 104°F), 80% RH (non-condensating)
Temperature and humidity range for guaranteed accuracy	23±5°C (73±9°F), 80% RH or less (non-condensating)
Storage temperature and humidity	-10 to 50°C (14 to 122°F), 80% RH or less (non-condensating)
Period of guaranteed accuracy	1 year
Operating environment	Indoors, Pollution degree 2, up to 2000 m (6562-ft.) ASL
Dielectric strength	3.0 kVAC for 1 minute (2 mA sense current) (between each input channel and chassis, and between input channels)

Basic Specifications

Power source	<ul style="list-style-type: none"> • Model Z1005 AC Adapter Rated supply voltage 100 to 240 VAC (Voltage fluctuations of $\pm 10\%$ from the rated supply voltage are taken into account) Rated supply frequency 50/60 Hz Anticipated transient overvoltage 2500 V • Model 9780 Battery Pack 3.6 V (Note) The AC Adapter has priority when connected • 12 V Battery (10 to 16 VDC, $\pm 10\%$ tolerance) (Note) Wiring from battery to instrument should be no more than 3m long
Maximum rated power	<p>30 VA (When using the AC Adapter to charge the 9780 Battery Pack in the Memory HiCorder) 10 VA (When using 12 VDC to charge the 9780 Battery Pack in the Memory HiCorder) 3VA (When using a 9780 Battery Pack)</p>
Continuous operating time	When using Model 9780 Battery Pack, approx. 2 hours ("Waiting for Trigger" state @25°C)
Charging function	<p>With the 9780 Battery Pack installed and the AC Adapter connected Charging time: Approx. 200 minutes (@25°C) Note 1. Actual charging time depends on battery condition Note 2. Charging temperature range: 5 to 30°C</p>
Dimensions	Approx. 176W x 101H x 41D mm (sans protrusions) (6.93"W x 3.98"H x 1.61"D)
Mass	Approx. 600 g (21.2 oz.) (With Model 9780 Battery Pack installed)
Effect of radiated radio-frequency electromagnetic field	$\pm 2.5\%$ f.s. at 3 V/m
Effect of conducted radio-frequency electromagnetic field	$\pm 5.0\%$ f.s. at 3 V
Applicable Standards	Safety EN61010 EMC EN61326 Class A

Display Section

Display character	English/ Japanese selectable
Display type	4.3-in TFT Color LCD (480 × 272 dots)
Display resolution	Waveform: 20 div (time axis) × 10 div (voltage axis) (1div = 20 dot (time axis) × 20 dot (voltage axis))
Dot pitch	0.198 × 0.198 mm
Backlight	On, Off
Backlight lifespan	Approx. 10,000 hours (continuously on)
Backlight saver function	Selectable from on, or auto-off after selectable interval
Backlight brightness	Selectable from four levels (100%, 70%, 40%, 25%)

External Interfaces

USB standard	USB2.0 compliant High Speed
Connector	Series-mini B receptacle
Connecting devices	PC
Function	Transfer files between an installed CF card and connected PC (Mass Storage device mode)

External Storage

Slot	One CompactFlash compliant slot CF card Type I accepted
Card type	Flash ATA card
Card capacities	9726 (128MB)(*End of sale), 9727 (256MB)(*End of sale), 9728 (512MB), 9729 (1GB) , 9830 (2GB)
Data formats	FAT and FAT32 supported
Storage contents	<ul style="list-style-type: none"> • Setting configurations • Measurement data (binary and text) (data between A-B cursors can be saved) • Screen images (compressed bitmap format) • Calculation results • Thinned storage (text: simple thinning)

Measurement Input Section

Measurement ranges	10, 20, 50, 100, 200, 500 mV/div 1, 2, 5, 10, 20, 50 V/div (*Values for RMS recorder mode are listed in a separate chapter.)
Measurement accuracy	±0.5%f.s. (filter 5 Hz On, after zero adjustment, guaranteed within measurement range) (f.s. = 10 div)

Measurement Input Section

Temperature characteristic	$\pm 0.05\% \text{ f.s. } / ^\circ\text{C}$ (after zero adjustment) (f.s. = 10 div)
Frequency characteristic	DC to 50 kHz -3dB
Common mode rejection ratio	80dB minimum (at 50/60 Hz and with signal source resistance 100 Ω maximum)
Low-pass filter	OFF, 5, 50, 500 Hz, 5 kHz $\pm 50\%$ -3dB
Noise	2 mVp-p typ. 4 mVp-p max. (sensitivity range, with input shorted)
Input type	Unbalanced (input isolated from output)
Input resistance	1 M $\Omega \pm 1\%$
Input capacitance	7 pF ± 3 pF (at 50 kHz)
A/D resolution	12 bits
Voltage axis resolution	1/100 of measurement range
Measurement range	± 10 times the V/div (range) setting (in 50 V/div range, maximum rated voltage between terminals is 400 VDC)
Maximum sampling rate	1 MS/s (*Values for RMS recorder mode are listed in a separate chapter.)
Input coupling	DC/GND
Input terminals	Insulated BNC terminal
maximum rated voltage between terminals	400 VDC (per input channel)
Maximum rated voltage to earth	300 VAC/DC (between each input channel and chassis, and between input channels) Measurement category II (anticipated transient overvoltage 2500 V)

(2) Measurement Functions

Basic Specifications

Timebase	100, 200, 500 $\mu\text{s}/\text{div}$ 1, 2, 5, 10, 20, 50, 100, 200, 500 ms/div 1, 2, 5, 10, 30 s/div 1, 2, 5 min/div (*Values for RMS recorder mode are listed in a separate chapter.)
Time axis resolution	100 points/div
Sampling period	1/100th of timebase

Basic Specifications

Recording length	20, 50, 100, 200, 500, 1000, 2000, 5000, 10000, 20000 div, Cont Note 1: There are restrictions on the time axis setting for recording length [Cont]. Note 2: When recording length exceeds 20,000 div, only the latest 20,000 div worth of data will be saved. (*Values for RMS recorder mode are listed in a separate chapter.)
Screen settings	On one screen
Recording line distinction	6 colors
Waveform compression and magnification	<ul style="list-style-type: none"> • Time axis x10, x5, x2, x1, x1/2, x1/5, x1/10, x1/20, x1/50, x1/100, x1/200, x1/500, x1/1000 (*Values for RMS recorder mode are listed in a separate chapter.) • Voltage axis x10, x5, x2, x1, x1/2, x1/5
Waveform scrolling	Horizontal scrolling (incl. while measuring)
Roll Mode display	Waveforms automatically scroll when one division on the waveform screen is 50 ms or more

Trigger Section (*Values for RMS recorder mode are listed in a separate chapter.)

Trigger method	Digital comparison
Trigger modes	Single or Repeat
Trigger source	Two analog input channels Four logic input channels External trigger <ul style="list-style-type: none"> • Each source can be enabled/disabled (ON/OFF) • Free-run operation occurs when all trigger types are off. Trigger criteria can be set for each channel External triggering occurs when terminal voltage is pulled below 2.5 V, or by shorting terminals.
Manual trigger	Yes
Trigger criteria	AND or OR of each trigger source

Trigger Section (*Values for RMS recorder mode are listed in a separate chapter.)

Trigger types (analog)	<ul style="list-style-type: none"> • Level Trigger Set digitally as a voltage value below full-scale Triggering occurs when the signal rises (or falls) through a specified value. • Voltage Drop Trigger Triggering occurs when peak voltage falls below the specified level (for commercial power). • Window Trigger Upper and lower trigger threshold levels are specified Triggering occurs when the signal enters or exits the defined threshold range.
Trigger types (logic)	Pattern (mask) trigger by 1, 0, or X (X: don't care)
Trigger filter	Set by number of samples (0, 10, 20, 50 or 100)
Trigger level resolution	0.5%f.s. (f.s. = 10 div)
Pre-trigger	0, 5, 10, 20, 30, 40, 50, 60, 70, 80, 90, 95, 100%
Trigger timing	Start
Trigger output	Open-collector output (with 5 V output, Active Low) Pulse Width: at least 1 ms
Trigger input and output terminals	Terminal Block

Miscellaneous

Numerical calculations	Four calculations are available at the same time (common to all channels) Calculation results can be saved to CF card. Calculations: Average value, P-P value, Maximum value, Minimum value, RMS value, Period, Frequency Calculation time span: Can be specified by A/B cursors, or whole waveform (*Values for RMS recorder mode are listed in a separate chapter.)
Cursor measurement functions	Trace, vertical or horizontal Potential at each cursor, time from trigger Time difference between A/B cursors, potential difference, frequency
Scaling functions	Available for each channel independently OFF, Model (Clamp sensor, Differential Probe), Output ratio (conversion ratio, attenuating ratio), or calculated from two data points (*Values for RMS recorder mode are listed in a separate chapter.)
Comment entry	Title comment, per-channel (incl. logic) comments (*Values for RMS recorder mode are listed in a separate chapter.)
Screen image capture function	Provided (compressed bitmap format)

Gauge	Gauges can be displayed (or not) for two channels on the Waveform screen
Retain start condition function	Provided
Auto setup function	Automatically loads setting conditions stored either in the instrument 's internal memory or on the CF card at power-on.
Auto save function	Provided (When saving waveforms as binary data with a time axis setting that is 50 ms/div. or slower, the data will be saved while measurement is being performed.)
delete-and-save operation	ON/OFF provided ON: When space on the media becomes limited, the file with the oldest date of creation in the folder "HIOKI8870\AUTO_D" will be deleted to make space for a new file. OFF: Data will be saved as long as there is space remaining on the media (once the card becomes full, measurement will continue, but data will no longer be saved).
Auto range function	Provided (automatically selects the appropriate timebase and voltage range for an input waveform)
Scroll bar	Indicates the relative position of the displayed waveform within the overall waveform (includes function to jump to a specified position)
Error and warning displays	Yes
Key-lock	Provided
SAVE key settings	Settings are provided to select save format and saving area by pressing the SAVE key. [Quick Save]/[Select & Save] selectable
Waveform monitor function	Settings can be changed on the Setting screen while viewing input waveforms. Changes to settings take effect immediately in the Waveform monitor.
Logic display	Each of four bits can be either on or off Four display locations are provided, one for each of the four bits A comment can be entered for each bit
Zero-position adjustment	The zero position of each channel can be set independently
Waveform backup time function	Memory is retained (backed up) while the Memory HiCorder is turned off when a charged 9780 Battery Pack is present or with the AC Adapter connected
Waveform backup time	100 hours with a 9780 Battery Pack after full charge

Numerical display function	Displays measured voltages as numerical values on the screen Pressing the WAVE/DATA key toggles between numerical and waveform display modes (not available while measuring)
-----------------------------------	---

Numerical Display Function

Refresh rate	0.5 s
Display contents	Instantaneous or RMS display only (DC or auto-selected 50/60 Hz AC only)
Sampling rate	10 kS/s
Resolution	Four digits (the last digit is 0 for values 0 to 4, and 5 for values 5 to 9)
Voltage ranges	10 m, 50 m, 100 m, 500 m, 1, 5, 10, 50 V/div (Autoranging)
Accuracy	$\pm 2.5\% \text{rdg.} \pm 5 \text{dgt.}$

RMS recorder

Specifications are the same as listed in other chapters except as described in the notes provided in this chapter.

Measurement mode	Any of the following four measurement modes can be selected for each channel: AC voltage, AC current, DC voltage, DC current
Range	The range can be selected for each channel as indicated in the tables below depending on the measurement mode. AC voltage: See Table 1 AC current: See Table 2 DC voltage: See Table 3 DC current: See Table 4
RMS accuracy	$\pm 3.0\% \text{ f.s.}$ (after zero-adjustment; guaranteed within the f.s. range indicated for the range) * See Table 1, Table 2 * Accuracy for the attenuating probes and clamp sensors being used must be added separately.
RMS recorder measurement target	Commercial power supplies (50 Hz ± 1 Hz or 60 Hz ± 1 Hz), DC * RMS recorder mode cannot be used to measure logic channels.
measurement range	See Table 1 to Table 4
Scaling function	Can be set for each channel. For AC voltage and DC voltage, select from "OFF" and "model name" attenuating probe settings. For AC current and DC current, select from "model name" clamp sensor settings.

Recording interval	1, 2, 5, 10, 20, 50, 100, 200, 500 ms 1, 2, 5, 10, 20, 30 s 1 min Note: Data is stored at the interval set here.
Sampling period	DC voltage, DC current: fixed to 200 μ s AC voltage, AC current: fixed to 200 μ s (1,000 RMS data points/sec.)
Envelope mode	Always on Sampling data used to acquire peak data is not kept The recording interval's maximum and minimum values are recorded
Recording length	10,000 div. * When measurement is stopped before capture of 10,000 div., the data up to that point can be displayed and saved.
Waveform compression and magnification	(time axis) 100, 200, 500 ms, 1, 2, 5, 10, 30 s, 1, 2, 5, 10, 30 min/div, 1, 2, 5, 10, 12, 1 day/div (voltage axis) $\times 10$, $\times 5$, $\times 2$, $\times 1$, $\times 1/2$, $\times 1/5$
Trigger function	Only "single" and "repeat" operation can be selected in trigger mode. No other functionality is provided. * The external control terminals cannot be used.
Numerical calculations	Disable
Comment entry	A title or a comment for each channel can be entered (Numerical values, alphabet letters, symbols) Comments cannot be entered for logic channels.
Logic display	Disable

(Table 1)

Attenuating probe	Range	(Measurement range) ^{*9}	f.s.	RMS accuracy ^{*10}	Measurable range	Crest factor
OFF	100 Vline	(20 V/div)	100 V rms	± 3 V rms	140 V rms	1.4
	200 Vline	(50 V/div)	200 V rms	± 6 V rms	280 V rms	1.7
P9000 (1/100) ^{*1}	100 Vline	(200 mV/div)	100 V rms	± 3 V rms	140 V rms	1.4
	200 Vline	(500 mV/div)	200 V rms	± 6 V rms	250 V rms	2
P9000 (1/1000) ^{*1}	400 Vline	(100 mV/div)	500 V rms	± 15 V rms	700 V rms	1.4
	600 Vline	(200 mV/div)	1000 V rms	± 30 V rms	1000 V rms	2
9322 ^{*1}	400 Vline	(100 mV/div)	500 V rms	± 15 V rms	700 V rms	1.4
	600 Vline	(200 mV/div)	1000 V rms	± 30 V rms	1000 V rms	2

(Table 2)

Clamp sensor ^{*8}	Range(f.s.)	(Measurement range) ^{*9}	f.s.	RMS accuracy ^{*10}	Measurable range	Crest factor
9010-50 /9018-50 /9132-50	10 Ar ^{*2}	(50 mV/div)	10 A rms	± 0.3 A rms	10 A rms	2.5
	20 Ar	(50 mV/div)	20 A rms	± 0.6 A rms	20 A rms	2.5
	50 Ar	(50 mV/div)	50 A rms	± 1.5 A rms	20 A rms	2.5
	100 Ar	(50 mV/div)	100 A rms	± 3.0 A rms	20 A rms	2.5
	200 Ar	(50 mV/div)	200 A rms	± 6.0 A rms	200 A rms	2.5
	500 Ar	(50 mV/div)	500 A rms	± 15 A rms	500 A rms	2.5
	1000 Ar ^{*3}	(50 mV/div)	1000 A rms	± 30 A rms	1000 A rms	2.5
3283	10 mAr	(200 mV/div)	10 mA rms	± 0.3 mA rms	10 mA rms	2
	100 mAr	(200 mV/div)	100 mA rms	± 3 mA rms	100 mA rms	2
	1 Ar	(200 mV/div)	1 A rms	± 30 mA rms	1 A rms	2
	10 Ar	(200 mV/div)	10 A rms	± 300 mA rms	10 A rms	2
3284/3285	200 Ar	(500 mV/div)	200 A rms	± 6 A rms	200 A rms	2.5
	20 Ar ^{*4}	(200 mV/div)	20 A rms	± 0.6 A rms	20 A rms	2
	2000 Ar ^{*5}	(200 mV/div)	2000 A rms	± 60 A rms	2000 A rms	2
CT9691	10 Ar	(20 mV/div)	10 A rms	± 0.3 A rms	10 A rms	2
	100 Ar	(20 mV/div)	100 A rms	± 3.0 A rms	100 A rms	2
CT9662 /CT9663	20 Ar ^{*6}	(50 mV/div)	20 A rms	± 0.6 A rms	20 A rms	2
	200 Ar	(50 mV/div)	200 A rms	± 6 A rms	200 A rms	2.5
	2000 Ar ^{*7}	(50 mV/div)	2000 A rms	± 60 A rms	2000 A rms	2.5
CT9667	500 Ar	(100 mV/div)	500 A rms	± 15 A rms	500 A rms	2
	5000 Ar	(100 mV/div)	5000 A rms	± 150 A rms	5000 A rms	2
9657-10 /9675	10 Ar	(200 mV/div)	10 A rms	± 0.3 A rms	10 A rms	2
9660	-	(20 mV/div)	100 A rms	± 3.0 A rms	100 A rms	2
9661	-	(100 mV/div)	500 A rms	± 15 A rms	500 A rms	2
9669	-	(100 mV/div)	1000 A rms	± 30 A rms	1000 A rms	2
9694	-	(10 mV/div)	5 A rms	± 0.15 A rms	5 A rms	2
9695-02	-	(100 mV/div)	50 A rms	± 1.5 A rms	50 A rms	2

Clamp sensor *8	Range(f.s.)	(Measure- ment range)*9	f.s.	RMS accuracy *10	Measur- able range	Crest factor
9695-03	-	(20 mV/div)	100 A rms	± 3.0 A rms	100 A rms	2
CT6500	-	(100 mV/div)	500 A rms	± 15 A rms	500 A rms	2
CT7044/ CT7045/ CT7046	10 mV/A	(200 mV/div)	100 A rms	± 3.0 A rms	60 A rms	3.3
	1 mV/A	(200 mV/div)	1000 A rms	± 30 A rms	600 A rms	3.3
	0.1 mV/A	(200 mV/div)	10000 A rms	± 300 A rms	6000 A rms	3.3
	×10 100 mV/A	(1 V/div)	50 A rms	± 1.5 A rms	30 A rms	2
	×10 10 mV/A	(1 V/div)	500 A rms	± 15 A rms	300 A rms	2
	×10 1 mV/A	(1 V/div)	5000 A rms	± 150 A rms	3000 A rms	2
CT7631/ CT7731	10 mV/A	(200 mV/div)	100 A rms	± 3.0 A rms	60 A rms	3.3
	1 mV/A	(20 mV/div)	100 A rms	± 3.0 A rms	100 A rms	2
	×10 100 mV/A	(1 V/div)	50 A rms	± 1.5 A rms	30 A rms	3.3
	×10 10 mV/A	(200 mV/div)	100 A rms	± 3.0 A rms	100 A rms	2
CT7636/ CT7736	10 mV/A	(200 mV/div)	100 A rms	± 3.0 A rms	60 A rms	3.3
	1 mV/A	(200 mV/div)	1000 A rms	± 30 A rms	600 A rms	3.3
	×10 100 mV/A	(1 V/div)	50 A rms	± 1.5 A rms	30 A rms	3.3
	×10 10 mV/A	(1 V/div)	500 A rms	± 15 A rms	300 A rms	3.3
CT7642/ CT7742	1 mV/A	(200 mV/div)	1000 A rms	± 30 A rms	600 A rms	3.3
	0.1 mV/A	(50 mV/div)	2000 A rms	± 60 A rms	2000 A rms	2.5
	×10 10 mV/A	(1 V/div)	500 A rms	± 15 A rms	300 A rms	3.3
	×10 1 mV/A	(500 mV/div)	2000 A rms	± 60 A rms	2000 A rms	2.5

(Table 3)

Clamp sensor	Range	(Measure- ment range) ^{*9}	f.s.	Measurement accuracy ^{*11}	Measurable range
OFF	100 mV f.s.	(10 mV/div)	100 mV	± 0.5 mV	DC100 mV
	200 mV f.s.	(20 mV/div)	200 mV	± 1 mV	DC200 mV
	500 mV f.s.	(50 mV/div)	500 mV	± 2.5 mV	DC500 mV
	1 V f.s.	(100 mV/div)	1 V	± 5 mV	DC1 V
	2 V f.s.	(200 mV/div)	2 V	± 10 mV	DC2 V
	5 V f.s.	(500 mV/div)	5 V	± 25 mV	DC5 V
	10 V f.s.	(1 V/div)	10 V	± 50 mV	DC10 V
	20 V f.s.	(2 V/div)	20 V	± 100 mV	DC20 V
	50 V f.s.	(5 V/div)	50 V	± 250 mV	DC50 V
	100 V f.s.	(10 V/div)	100 V	± 500 mV	DC100 V
	200 V f.s.	(20 V/div)	200 V	± 1 V	DC200 V
500 V f.s.	(50 V/div)	500 V	± 2.5 V	DC400 V	
P9000 (1/100) ^{*1}	10 V f.s.	(10 mV/div)	10 V	± 50 mV	DC10 V
	20 V f.s.	(20 mV/div)	20 V	± 100 mV	DC20 V
	50 V f.s.	(50 mV/div)	50 V	± 250 mV	DC50 V
	100 V f.s.	(100 mV/div)	100 V	± 500 mV	DC100 V
	200 V f.s.	(200 mV/div)	200 V	± 1 V	DC200 V
500 V f.s.	(500 mV/div)	500 V	± 2.5 V	DC350 V	
P9000 (1/1000) ^{*1}	100 V f.s.	(10 mV/div)	100 V	± 500 mV	DC100 V
	200 V f.s.	(20 mV/div)	200 V	± 1 V	DC200 V
	500 V f.s.	(50 mV/div)	500 V	± 2.5 V	DC500 V
	1000 V f.s.	(100 mV/div)	1000 V	± 5 V	DC1000 V
9322 ^{*1}	100 V f.s.	(10 mV/div)	100 V	± 500 mV	DC100 V
	200 V f.s.	(20 mV/div)	200 V	± 1 V	DC200 V
	500 V f.s.	(50 mV/div)	500 V	± 2.5 V	DC500 V
	1000 V f.s.	(100 mV/div)	1000 V	± 5 V	DC1000 V
	2000 V f.s.	(200 mV/div)	2000 V	± 10 V	DC2000 V / AC1000 V

(Table 4)

Clamp sensor ^{*8}	Range	(Measurement range) ^{*9}	f.s.	Measurement accuracy ^{*11}	Measurable range
3284/3285	20 A f.s. ^{*4}	(100 mV/div)	20 A	± 100 mA	20 A peak
	200 A f.s.	(100 mV/div)	200 A	± 1 A	200 A peak
	2000 A f.s. ^{*5}	(100 mV/div)	2000 A	± 10 A	2000 A peak
CT9691	10 A f.s.	(10 mV/div)	10 A	± 50 mA	10 A peak
	100 A f.s.	(10 mV/div)	100 A	± 500 mA	100 A peak
CT9662 /CT9663	20 A f.s. ^{*6}	(20 mV/div)	20 A	± 100 mA	20 A peak
	200 A f.s.	(20 mV/div)	200 A	± 1 A	200 A peak
	2000 A f.s. ^{*7}	(20 mV/div)	2000 A	± 10 A	2000 A peak
CT7631 /CT7731	10 mV/A	(100 mV/div)	100 A	± 500 mA	60 A peak
	1 mV/A	(10 mV/div)	100 A	± 500 mA	100 A peak
	×10 100 mV/A	(500 mV/div)	50 A	± 250 mA	30 A peak
	×10 10 mV/A	(100 mV/div)	100 A	± 500 mA	100 A peak
CT7636 /CT7736	10 mV/A	(100 mV/div)	100 A	± 500 mA	60 A peak
	1 mV/A	(100 mV/div)	1000 A	± 5 A	600 A peak
	×10 100 mV/A	(500 mV/div)	50 A	± 250 mA	30 A peak
	×10 10 mV/A	(500 mV/div)	500 A	± 2.5 A	300 A peak
CT7642 /CT7742	1 mV/A	(100 mV/div)	1000 A	± 5 A	600 A peak
	0.1 mV/A	(20 mV/div)	2000 A	± 10 A	2000 A peak
	×10 10 mV/A	(500 mV/div)	500 A	± 2.5 A	300 A peak
	×10 1 mV/A	(200 mV/div)	2000 A	± 10 A	2000 A peak

*1 When the Differential Probe is used, its accuracy is added.

*2 Except 9132-50

*3 9132-50 Only

*4 3284 Only

*5 3285 Only

*6 CT9662 Only

*7 CT9663 Only

*8 When the Clamp-On Probe is used, its accuracy is added.

*9 An appropriate measurement range is automatically selected internally according to a range setting (unselectable manually).

*10 The RMS accuracy listed in "RMS recorder" is applied. (p. 118)

*11 The Measurement accuracy listed in Measurement Input Section is applied.(p. 113)

(3) Accessories

• Instruction Manual (This document)	1
• Measurement Guide (Memory Recorder).....	1
• Measurement Guide (RMS Recorder).....	1
• Model Z1005 AC Adapter	1
(with supplied power cord)	
• Strap	1
• USB cable.....	1
• Wave Processor Application Program for the 8870 (CD)	1
• Model 9809 Protection Sheet	1

(4) Options (Sold separately)(p. A13)

AC adapter	• Model Z1005 AC Adapter (The same as supplied AC adapter)
Battery pack	• Model 9780 Battery Pack (Ni-MH, 3.6 V, 1500 mAh)
Carrying case	• Model 9782 Carrying Case • Model 9812 Soft Case
Protection sheet	• Model 9809 Protection Sheet
CF card	• Model 9728 PC Card (512MB) • Model 9729 PC Card (1GB) • Model 9830 PC Card (2GB)
For voltage measurement	• Model L9197 Connection Cord (maximum rated voltage between terminals 600 V AC/DC) • Model 9197 Connection Cord (maximum rated voltage between terminals 600 V AC/DC) • Model L9198 Connection Cord (maximum rated voltage between terminals 300 V AC/DC) • Model L9217 Connection Cord (maximum rated voltage between terminals 300 V AC/DC, Isolated BNC-BNC) • Model L9790 Connection Cord (maximum rated voltage between terminals 600 V AC/DC) • Model L9790-01 Alligator Clip (for Model L9790) • Model 9790-02 Grabber Clip (for Model L9790) • Model 9790-03 Contact Pin (for Model L9790) • Model P9000-01 Differential Probe • Model P9000-02 Differential Probe (with RMS recorder mode) • Model Z1008 AC Adapter (for Model P9000) • Model 9322 Differential Probe • Model 9418-15 AC Adapter (for Model 9322)
For logic signal input	• Model 9320-01 Logic Probe (Four channels, for detecting voltage and closed/open contact points) • Model MR9321-01 Logic Probe (Four isolated channels, for detecting AC/DC voltage on/off)

For current measurement

- Model 9010-50 Clamp-On Probe (10 to 500 A: 40 Hz to 1 kHz)
- Model 9018-50 Clamp-On Probe (10 to 500 A: 40 Hz to 3 kHz)
- Model 9132-10 Clamp-On Probe (20 to 1000 A: 40 Hz to 1 kHz)
- Model 9657-10 Clamp-On Leak Sensor (10 A AC: 40 Hz to 5 kHz)
- Model 9675 Clamp-On Leak Sensor (10 A AC: 40 Hz to 5 kHz)
- Model CT9691 Clamp-On AC/DC Sensor (10 A AC/DC, 100 A: DC to 10 kHz)
- Model CT9692 Clamp-On AC/DC Sensor (20 A AC/DC, 200 A: DC to 20 kHz)
- Model CT9693 Clamp-On AC/DC Sensor (200 A AC/DC, 2000 A: DC to 15 kHz)
- Model CT9667 Flexible Clamp-On Sensor (500 A AC, 5000 A: 10 Hz to 20 kHz)
- 9660 Clamp on Sensor (100 A AC:40 Hz to 5 kHz)
- 9661 Clamp on Sensor (500 A AC:40 Hz to 5 kHz)
- 9669 Clamp on Sensor (1000 A AC:40 Hz to 5 kHz)
- 9694 Clamp on Sensor (5 A AC:40 Hz to 5 kHz)
- 9695-02 Clamp on Sensor (50 A AC:40 Hz to 5 kHz)
- 9695-03 Clamp on Sensor (100 A AC:40 Hz to 5 kHz)
- CT6500 Clamp on Sensor (500 A AC:40 Hz to 1 kHz)
- CT7044 AC Flexible Current Sensor (600 A AC,6000 A: 10 Hz to 50 kHz, ϕ 100 mm)
- CT7045 AC Flexible Current Sensor (600 A AC,6000 A AC: 10 Hz to 50 kHz, ϕ 180 mm)
- CT7046 AC Flexible Current Sensor (600 A AC, 6000 A AC: 10 Hz to 50 kHz, ϕ 254 mm)
- CT7631 AC/DC Current Sensor (60 A AC/DC,100 A AC/DC, DC to 10 kHz)
- CT7636 AC/DC Current Sensor (60 A AC/DC,600 A AC/DC, DC to 10 kHz)
- AC/DC Current Sensor (600 A AC/DC,2000 A AC/DC, DC to 10 kHz)
- CT7731 AC/DC Auto-Zero Current Sensor (60 A AC/DC,100 A AC/DC, DC to 5 kHz)
- CT7736 AC/DC Auto-Zero Current Sensor (60 A AC/DC, 600 A AC/DC, DC to 5 kHz)
- CT7742 AC/DC Auto-Zero Current Sensor (600 A AC/DC, 2000 A AC/DC, DC to 5 kHz)

PC application program Model 9335 Wave Processor

Maintenance and Service

Chapter 11

11.1 Troubleshooting

Inspection and Repair



CAUTION Do not attempt to modify, disassemble or repair the instrument; as fire, electric shock and injury could result.



NOTE If damage is suspected, check the "Before Returning for Repair" (p. 128) section before contacting your dealer or Hioki representative.

Transporting

- Use the original packing materials when transporting the instrument, if possible.
- Pack the instrument so that it will not sustain damage during shipping, and include a description of existing damage. We cannot accept responsibility for damage incurred during shipping.

Replaceable Parts and Operating Lifetimes

Useful life depends on the operating environment and frequency of use. Operation cannot be guaranteed beyond the following periods.

For replacement parts, contact your dealer or Hioki representative.

Part	Life
LCD (to half brightness)	Approx. 10,000 hours
Battery pack	60% of initial battery capacity can be expected to remain after 500 complete charge/discharge cycles.
Battery pack connectors	Disconnection/connection times: 30 (the number of times that provides stable connection)
Electrolytic Capacitors	Approx. 10 years
Lithium Battery	Approx. 5 years The instrument contains a built-in backup lithium battery. If the date and time deviate substantially when the instrument is switched on, it is the time to replace that battery. Contact your dealer or Hioki representative.

The fuse is housed in the power unit of the instrument. If the power does not turn on, the fuse may be blown. If this occurs, a replacement or repair cannot be performed by customers. Please contact your dealer or Hioki representative.

Before Returning for Repair

If abnormal operation occurs, check the following items.

Symptom	Check Items	
The display does not appear when you turn the power on.	<ul style="list-style-type: none"> • Is the power cord disconnected? • Are connections made correctly? • Is the battery pack installed correctly? 	<p>Verify that the power cord is connected properly. (p. 28)</p> <p>Verify that the battery pack is correctly installed (p. 24).</p>
Keys do not work.	<ul style="list-style-type: none"> • Is any key being held down? • Is the key-lock state active? (A message appears when a key is pressed while key-lock is active.) 	<p>Verify key operation.</p> <p>Cancel key-lock: (Hold the ◁ ▷ cursor keys for three seconds)</p>
Power does not turn on.	<ul style="list-style-type: none"> • A power protection component may be damaged. 	<p>Customers should not attempt to perform parts replacement and repair. Contact your dealer or Hioki representative for service.</p>
A waveform does not appear when you press the START/STOP key.	<ul style="list-style-type: none"> • Is the "Waiting for pre-trigger" message displayed? • Is the "Waiting for trigger" message displayed? 	<p>When pre-triggering is enabled, triggering is ignored until the pre-trigger portion of the waveform has been acquired. Recording starts when a trigger occurs.</p>
No changes occur in the displayed waveform.	<ul style="list-style-type: none"> • Is the clamp sensor or connection cable connected correctly? • Is the measurement range set properly? • Is the low-pass filter enabled? 	<p>Verify that the clamp sensor or connection cable is connected correctly (p. 29).</p>
Data cannot be saved to the CF card.	<ul style="list-style-type: none"> • Is the storage media inserted properly? • Is the storage media formatted? • Is the remaining capacity of the storage media too low? 	<p>See "6.2 Using a CF Card" (p. 74)</p>
If the cause is unknown	<ul style="list-style-type: none"> • Try performing a system reset. (p. 103) • All settings are returned to their factory defaults. "Appendix 4 List of Default Settings" (p. A9) 	

Symptom	Check Items	
Battery pack cannot be charged (Charging LED is not lit).	<ul style="list-style-type: none"> • Verify that the ambient temperature is within the range from 5 to 30°C. 	The allowable ambient temperature range for charging the battery pack is from 5 to 30°C. (p. 25)
	<ul style="list-style-type: none"> • Is the this instrument stored for a long time in a plugged condition? 	The battery pack may have deteriorated and the battery life may be expiring soon. (p. 127) Please purchase a new battery pack. Please contact your dealer or the nearest HIOKI representative. If the this instrument is not used for more than a month, please remove the battery pack for storage. (p. 25)
Time that can be used with the battery pack has become shorter.	<ul style="list-style-type: none"> • Possibility of capacity decrease due to the deterioration of the battery pack. 	The battery pack may have deteriorated and the battery life may be expiring soon. (p. 127) Please purchase a new battery pack. Please contact your dealer or the nearest HIOKI representative.

11.2 Cleaning

NOTE**Cleaning the Instrument**

- To clean the instrument, wipe it gently with a soft cloth moistened with water or mild detergent. Never use solvents such as benzene, alcohol, acetone, ether, ketones, thinners or gasoline, as they can deform and discolor the case.
- Wipe the LCD gently with a soft, dry cloth.

Cleaning a Clamp Sensor (option)

- Measurements are degraded by dirt on the mating surfaces of the clamp-on sensor, so keep the surfaces clean by gently wiping with a soft cloth.
-

11.3 Disposing of the Instrument

The instrument contains a lithium battery for memory backup. When disposing of this instrument, remove the lithium battery and dispose of battery and instrument in accordance with local regulations.

Removing the Lithium Battery



To avoid electrocution, turn off the power switch and disconnect the power cord and cables before removing the lithium battery.

Required tools:

- One Phillips screwdriver (No.1)
- One wire cutter (to remove the lithium battery)

- 1 Verify that the power is off, and remove the connection cables and power cord.
- 2 Turn the Memory HiCorder over and remove the five screws affixing the lower case.
- 3 Remove the lower case. Then remove the two screws affixing the circuit board, and remove it.

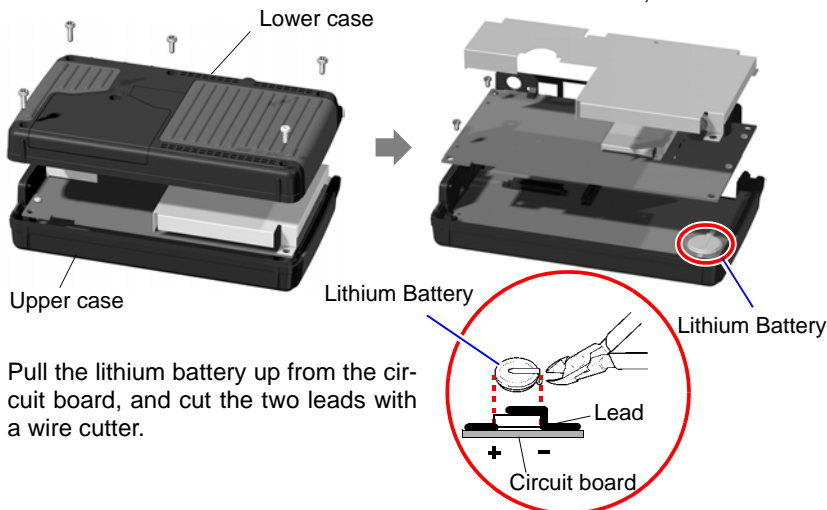

- 4 Pull the lithium battery up from the circuit board, and cut the two leads with a wire cutter.

CALIFORNIA, USA ONLY

Perchlorate Material - special handling may apply.
See www.dtsc.ca.gov/hazardouswaste/perchlorate

Appendix

Appendix 1 Error Messages and Remedial Actions

Error messages consist of either "Error" or "Warning" displays. A screen message appears whenever an error occurs. In either case, take the remedial action indicated.

Error Messages



Press ENTER to clear error messages.

Message	Remedial Action
001 Failed to back up the waveform (power off or not enough battery capacity).	(with no battery pack) Bear in mind that no power backup is provided when operating with only the AC adapter. (with battery pack) If the AC adapter is not providing power, no backup is available when the battery charge get low. Recharge the battery pack.
004 Battery low.	Low battery charge: recharge or replace with a fresh battery pack.
005 FPGA error	Incompatible FPGA firmware version. Try updating the firmware, and if the error persists, submit the Memory HiCorder for repair.

Warning Messages

Disappears within a few seconds. Also disappears when any key is pressed.

Message	Remedial Action
101 Invalid key. (measuring)	Keys are disabled while measuring. Try operating again when measurement is finished.
102 Cannot start measurement.	The START/STOP key is disabled when the current screen is displayed. Switch to the Waveform screen before starting measurement.
201 Exceeding the setting range.	The entered numerical value is out of the valid range. Enter a valid value.

Appendix 1 Error Messages and Remedial Actions

Message	Remedial Action
203 Voltage drop trigger will be disabled.	Voltage sag triggering is disabled when the timebase is outside of the range 100 μ s to 50 ms/div. Change the timebase so that it is with this range.
301 No waveform data	No waveform data is preset, so data saving and calculations cannot be performed. Press the START/STOP key to start acquiring measurement data.
302 Confirm the A-B cursor position.	The A/B cursor positions are invalid (out of waveform range). Check the cursor positions.
303 No numeric calculation data	Execute numerical calculation (p. 93).
401 File processing error	An unexpected fault occurred while processing a file on the CF card. Turn the Memory HiCorder off and back on.
402 Cannot load this file.	The format of the file is incompatible with the Memory HiCorder, or the file is corrupt. Refer to "6.1 About Saving and Loading Data" (p. 71) for loadable file formats.
403 Insert a CF card.	CF card not found. Insert a CF card.
404 Directory full	No more files can be created because the directory is full. Check or perform the following: 1. System reset (p. 103) 2. Verify that the CF card is specified by Hioki (p. 74) 3. Reformat the CF card (p. 76) If the message persists after performing the above, either the CF card or Memory HiCorder may be damaged. Contact your dealer or Hioki representative.
405 Not enough capacity	The CF card has insufficient space to save the file. Delete files to increase free space, or replace the CF card.
406 Process interrupted (not enough battery capacity).	The file cannot be processed because there is insufficient battery power. Charge the battery or connect the AC adapter.
407 CF card not found. Stop measurement and insert a CF card to save data.	No CF card is inserted. When the next measurement is performed, the waveform shown on the instrument's screen will be overwritten. Stop measurement, insert a CF card, and save the data.

Appendix 1 Error Messages and Remedial Actions

Message		Remedial Action
501	File system error (I/O error)	An I/O error occurred while accessing the CF card. Reformat the CF card. If the error persists, try a different CF Card. If this error occurs while using a good CF card, the Memory HiCorder may be damaged, in which case contact your dealer or Hioki representative.
502	File system error (Incorrect file handle)	Turn the Memory HiCorder off and back on. If the fault persists, perform system reset (p. 103).
503	File system error (system configuration)	
504	File system error (not enough memory)	
505	File system error (incomplete information)	The CF card could not be recognized. Reformat the CF Card on a computer. If the error persists, try a different CF Card. If this error occurs while using a good CF card, the Memory HiCorder may be damaged, in which case contact your dealer or Hioki representative.
506	File system error (incorrect device)	Turn the Memory HiCorder off and back on. If the fault persists, perform system reset (p. 103).
507	File system error (file protected)	The requested write process (including deletion) could not be performed because the file attribute is read-only. Use a computer to cancel the read-only setting.
508	File system error (failed to recognize the format)	The CF card could not be recognized. Reformat the CF Card on a computer. If the error persists, try a different CF Card. If this error occurs while using a good CF card, the Memory HiCorder may be damaged, in which case contact your dealer or Hioki representative.
509	File system error (limit of the number of files)	The number of files to be processed exceeds the limit, so processing cannot be performed. Delete files to increase free space, or try another CF card.
510	File system error (same name file)	An attempt was made to create a file with the same name as an existing file. Change the name of the file to be created (p. 89).
511	File system error (system busy)	Processing could not be performed because files are in use by another executing process. Wait for the current process to finish. If there is no other executing process, turn the Memory HiCorder off and back on.
512	File system error (too long path name)	The specified name of a file or folder is too long. Enter a shorter name.

A4

Appendix 1 Error Messages and Remedial Actions

Message	Remedial Action
513 File system error (no file)	Turn the Memory HiCorder off and back on. If the fault persists, perform system reset (p. 103).
514 File system error (mode error)	
515 File system error (invalid file handle)	
516 File system error (file offset error)	
517 File system error (not enough capacity)	Insufficient free space is available on the CF card for the process to execute. Delete files to increase free space, or try another CF card.
518 File system error (invalid file name)	The file name contains an invalid character. Rename the file (p. 89).
519 File system error (directory error)	Turn the Memory HiCorder off and back on. If the fault persists, perform system reset (p. 103).
520 File system error (invalid file type)	
521 File system error (file rename error)	
522 File system error (internal parameter error)	
523 File system error (block size error)	
524 File system error (semaphore error)	
525 File system error (not supported action)	

Appendix 2 File Naming

File names are constructed as follows.

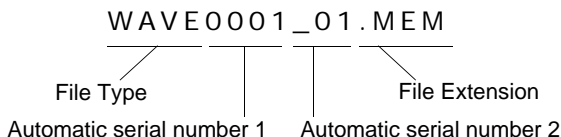

File Type		Automatic serial number 1	Automatic serial number 2	File Extension
Settings Data	CONFIG	0001, ...	None	.SET*5 .SRM*6
Settings List	LIST	0001, ...	None	.BDL
Waveform Data	WAVE *1	0001, ... *2	_01, ... *3	.MEM (Binary)*5
				.RMS (Binary)*6
				.CSV (Text)
Numerical Calculation Results	MEAS	0001, ...	None	.CSV
Captured Screen Image	SCR (Manual Save) *4	0001, ... *2	_01, ... *3	.BMP
	WAVE *1 (Auto Save)			

*1. During auto-saving of waveforms and screen images (WAVE), when the automatic serial number exceeds 9999, the file type prefix is truncated to avoid file names (prefix + serial number) exceeding eight characters.
(Example: WAVE9999.MEM, WAV10000.MEM, ...).

*2. Increments for each measurement until the date changes, at which time the serial number is reset to 0001.

*3. When auto-numbering would result in duplicate names of waveform data files, this number is appended and incremented from _01.
(Example: WAVE0001.MEM, WAVE0001_01.MEM, WAVE0001_02.MEM, ...)

*4. When turning power on the first time after the date has changed, and saving before starting measurement, the saved file is named SCR0000.BMP.

*5. This filename is used when saving data in memory recorder mode.

*6. This filename is used when saving data in RMS recorder mode.

Appendix 3 Wave Processor Application Program

This section describes the installation procedure for the Wave Processor program for the 8870, and preparations for launching. The program can be installed from the bundled CD, or the latest version can be downloaded from our web site. For help with program operation, see the Help screens in the program.

Wave Processor program for the 8870 operating environment:

Computer capable of running Windows XP (32-bit version), Windows Vista (32-bit version), Windows 7 (32-bit or 64-bit version), or Windows 8 (32-bit or 64-bit version)
Pentium III (500 MHz) CPU or better with at least 256 MB RAM
Display resolution of at least 1,024 × 768 with video functionality capable of displaying at least 256 colors
Hard disk space required for installation: At least 6 MB
CD-ROM drive required

To transfer measurement data from the Memory HiCorder to a computer:

See: "6.6 Transferring Data to a Computer" (p. 91)

Program Installation

This description uses a PC running Windows XP as an example.

- 1 Turn on the computer.
If the computer's operating system is Windows XP Professional, log on as an "administrator" user.
Before starting the installer, close all currently running applications.
- 2 Insert the bundled CD in the computer, or download and save the compressed file.
If using a downloaded file, uncompress it.
- 3 Double click the file **\\8870Application\English\setup.exe** to execute it.
When setup.exe executes, follow the screen instructions to complete the installation.
- 4 Click **[Next]**.

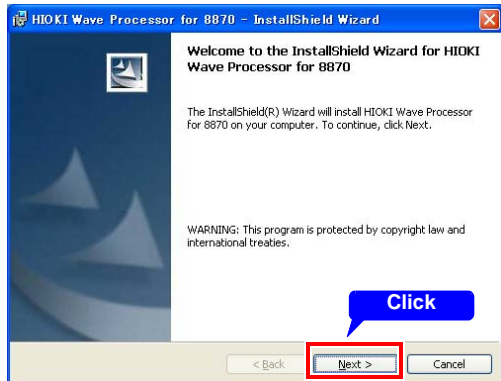

- 5 To change the installation destination, click **[Change]** and select the destination. Then click **[Next]**.

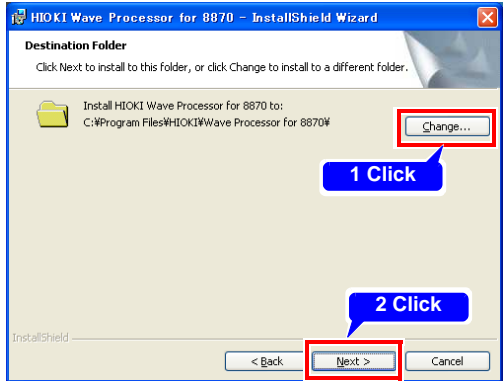

- 6 Click **[Install]**.

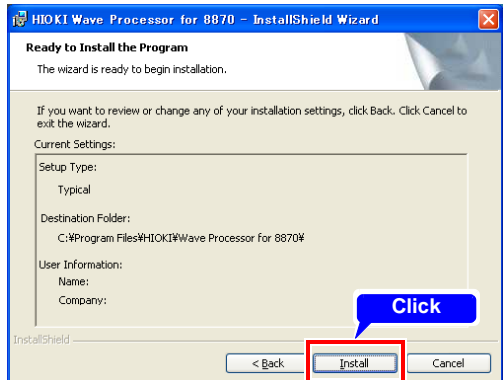

- 7 Click **[Finish]** to complete the installation.

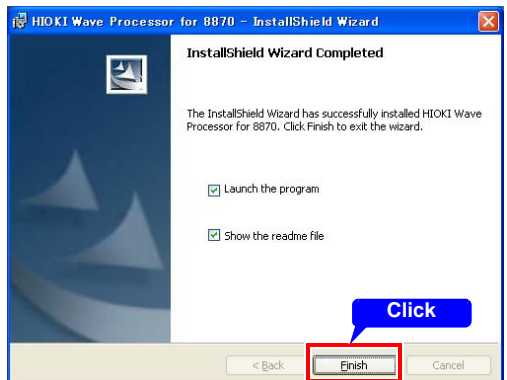

Running the Application Programs

From the Windows [Start] menu, select [Program] - [HIOKI] - [Wave Processor for 8870] - [Wave Processor for 8870] to start the program.

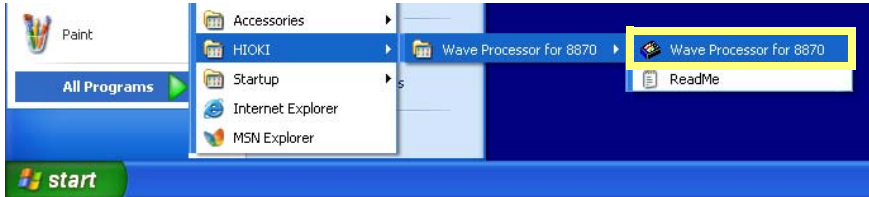

Uninstall Procedure

To uninstall, open [Add or Remove Programs] in the Windows [Control Panel], and select [HIOKI Wave Processor for 8870].

Appendix 4 List of Default Settings

When shipped from the factory or initialized to factory defaults, the settings are as follows.

Memory recorder mode

Screen	Setting Item	Default Setting	Screen	Setting Item	Default Setting
Setting	Timebase	100 μ s/div	Calc/ Save	Numerical Calculation	OFF
	Shot	20div		No.1	OFF
	Source	OR		No.2	OFF
	Time Mag	x1		No.3	OFF
	Trig Mode	Repeat		No.4	OFF
	Pre-Trig	0%		Auto Save	OFF
	CH1 / CH2	CH1: red CH2: green		Waveform	OFF
	Rng/div	10mV/div		Screen Image	OFF
	Pos	50%		Calc Results	OFF
	Coupling	DC		System	Start Backup
	Mag	x1	Backlight Brightness		100%
	L.P.F.	OFF	Backlight Saver		OFF
	Scaling	OFF	Display Color		Black
	Trig	OFF	SAVE Key Operation		Select & Save
	Filter	OFF	External Control Terminal		EXT.TRIG TRIG.OUT
	Level	Level trigger: 0 V Drop trigger: 10 mV	Beep Sound		ON
	Slope	\uparrow	Zero-Adjust		Not executed
	Lower	-10 mV			
	Upper	10 mV			
	Freq	50Hz			
	Logic	OFF			
	Pos	Pos1			
	Trig	OFF			
Pattern	X				
Filter	OFF				

RMS recorder mode

Screen	Setting Item	Default Setting
Setting	recording interval	10 ms
	Timebase	1 s/div
	Trig Mode	Repeat
	CH1 / CH2	CH1: red CH2: green
	Measurement settings	AC voltage 50 Hz
	Attenuating probe	OFF
	Range	100 Vline
	Filter	OFF
	Mag	x1
	Pos	-40%
	Auto Save (Waveform)	ON
	Delete-and-save	OFF
System	Start Backup	OFF
	Backlight Brightness	100%
	Backlight Saver	OFF
	Display Color	Black
	SAVE Key Operation	Select & Save
	Beep Sound	ON
Zero-Adjust	Not executed	

Setting Item		Default Setting
Shot		10000 div (which is fixed)
Source		OR (which is fixed)
Pre-Trig		0% (which is fixed)
Trig		OFF (which is fixed)
Logic		OFF (which is fixed)
Numerical Calculation		OFF (which is fixed)
Auto Save (Screen Image)		OFF (which is fixed)
Auto Save (Calc Results)		OFF (which is fixed)
External Control Terminal	EXT. TRIG	OFF
	TRIG. OUT	OFF

Appendix 5 Supplemental Technical Information

Selecting a Timebase (Horizontal Axis)

Timebase: with 1 div = 5 ms

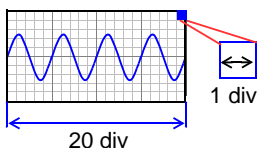

Timebase: with 1 div = 10 ms

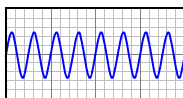

The input signal acquisition rate corresponds to time per division on the horizontal axis.

Determining the timebase: Calculate from the frequency and period.

$$f \text{ [Hz]} = 1/t \text{ [s]} \quad (f: \text{frequency}, t: \text{period})$$

Example: If the measurement frequency is 50 Hz:

$$50 \text{ [Hz]} = 1/t \text{ [s]}$$

$$t = 1/50 \text{ [s]} = 0.02 \text{ [s]} = 20 \text{ [ms]}$$

So to display five cycles on the screen (20 divisions horizontally), $20 \text{ [ms]} \times 5/20 \text{ [div]} = 5 \text{ ms/div}$

Select 5 ms/div for the timebase, which is the closest available setting to the calculated value.

To measure phenomena with relatively fast signals such as instantaneous waveforms, we suggest setting a small value (if the frequency is 50 Hz, the timebase should be set faster than 5 ms/div).

During and after measurement, waveforms can be expanded and compressed along the time axis.

Timebase and Sampling

Measurement Sampling Points

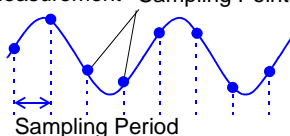

This instrument converts analog input signals into digital values which are then processed internally as digital (numerical) values. This A/D conversion process is called sampling. Sampling repeatedly measures the size of the input signal at a specific interval (the sampling period).

The rate of measurement is called the sampling rate.

Sampling units are [S/s] (read as samples-per-second)

This is the number of samples taken each second, and is the inverse of the sampling period. (1/T)

Aliasing

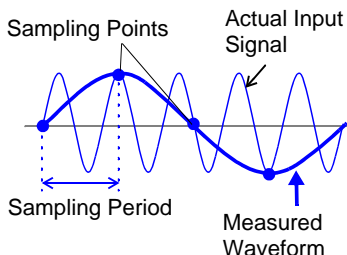

Aliasing occurs when the sampling period is longer than half of the input signal period.

If the signal to be measured changes too fast relative to the sampling period, beginning at a certain frequency, non-existent slow signal fluctuations are recorded. This phenomenon is aliasing.

With the Memory function, the sampling period can be significantly affected by the timebase setting, so care is necessary to avoid aliasing when selecting the timebase.

Because the timebase determines the measurement frequency limit, the fastest possible timebase setting should be used.

When the signal can be recorded repeatedly, the auto-ranging function (p. 42) may be used to select the optimum timebase.

Measurement Frequency Limit

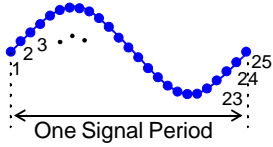

Displaying waveforms by their sampled values with adequate resolution of characteristics such as sine wave peaks requires a minimum of about 25 samples per waveform period. The measurement frequency limit is determined by the timebase.

Timebase	Sampling period	Measurement limit frequency	Timebase	Sampling period	Measurement limit frequency	Timebase	Sampling period	Measurement limit frequency
100 μs/div	1 μs	40 kHz	10 ms/div	100 μs	400 Hz	1 s/div	10 ms	4 Hz
200 μs/div	2 μs	20 kHz	20 ms/div	200 μs	200 Hz	2 s/div	20 ms	2 Hz
500 μs/div	5 μs	8 kHz	50 ms/div	500 μs	80 Hz	5 s/div	50 ms	0.8 Hz
1 ms/div	10 μs	4 kHz	100 ms/div	1 ms	40 Hz	10 s/div	100 ms	0.4 Hz
2 ms/div	20 μs	2 kHz	200 ms/div	2 ms	20 Hz	30 s/div	300 ms	0.13 Hz
5 ms/div	50 μs	800 Hz	500 ms/div	5 ms	8 Hz	1 min/div	600 ms	0.067 Hz
						2 min/div	1.2 s	0.033 Hz
						5 min/div	3 s	0.013 Hz

Numerical calculations in RMS recorder mode

The instrument performs 1,000 RMS calculations every second on the data acquired during a 200 μs sampling period (which is fixed). The instrument records 100 data points/div.

Calculate one RMS value

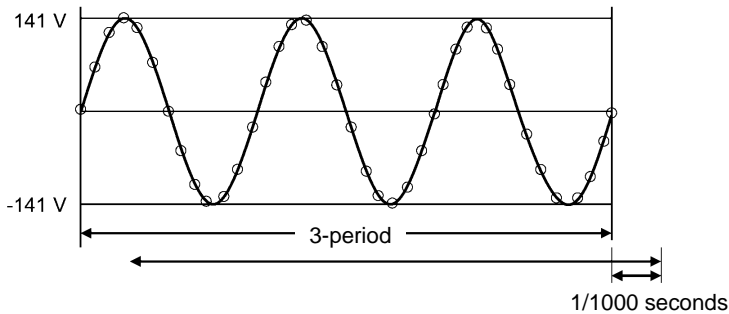

The 50 Hz or 60 Hz waveform is sampled for 200 μs, and 1 RMS data point is calculated using data for 3 periods. Thereafter, RMS data is calculated at a 1/1,000 sec. interval.

The maximum and minimum values from the RMS data for (1,000 RMS data points/sec. x recording interval [s]) are calculated to create 1 sample data point (envelope recording). For example, if the recording interval is set to 1 min., the maximum and minimum values from 6,000 RMS data points (1,000 x 60 s) are calculated to create 1 sample data point.

Appendix 6 Options

For the details, contact your supplier or Hioki representative for details.

Input cables for voltage measurement*

L9197 Connection Cord



Maximum rated voltage between terminals
600 V AC/DC

9197 Connection Cord

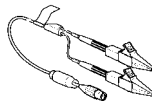

Maximum rated voltage between terminals
600 V AC/DC

L9198 Connection Cord

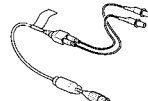

Maximum rated voltage between terminals
300 V AC/DC

L9217 Connection Cord

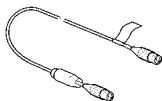

Maximum rated voltage between terminals
300 V AC/DC (for BNC output)

L9790 Connection Cord

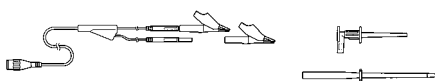

Maximum rated voltage between terminals 600 V AC/DC
(Select the end clip separately.)
Model L9790-01 Alligator Clip
Model 9790-02 Grabber Clip
Model 9790-03 Contact Pin

9322 Differential Probe

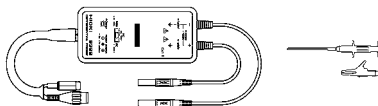

Requires the 9418-15 AC Adapter
For high voltage, maximum rated voltage between terminals: (CAT II): 2000 VDC, 1000 VAC, (CAT III): 600 VAC/DC

* When used in combination with the instrument, pay attention to the input voltage.
For details, refer to "2.3 Connecting Measurement Cables to the Memory HiCorder" (p. 29).

Logic Signal Measurement Logic Probes

9320-01 Logic Probe

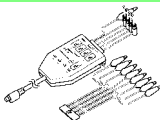

Measures digital signals and on/off switching of non-voltage contacts.

MR9321-01 Logic Probe

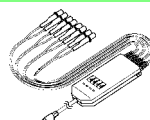

Detects the presence of AC and DC voltages. Measures activation timing of relay sequencing circuits.
Maximum rated voltage between terminals: 250 Vrms (HIGH range)

For users of the following legacy products:

Models 9306, 9307, 9320, 9321, MR9321 Logic Probes
Usable with this instrument by connecting the Model 9323 Conversion Cable.

Clamp-On Probes

9018-50



10 to 500 A,
40 Hz to 3 kHz
Outputs 0.2 V AC waveform of commercial power line current.

9132-10

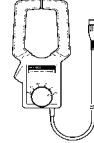

20 to 1000 A,
40 Hz to 1 kHz

For users of the following legacy products:

Model 9018 or 9132 Clamp-On Probe

Usable with this instrument by connecting the Model 9199 Conversion Adapter.

For leakage current measurement

9675

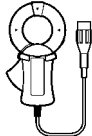

10 A AC, 40 Hz to 5 kHz

9657-10

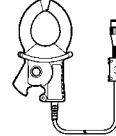

10 A AC, 40 Hz to 5 kHz

Software

Model 9335 Wave Processor (PC application programs)

Provides analysis of measurement data on a computer.

Power Sources

Model 9780 Battery Pack

Model Z1005 AC Adapter

PC Cards

Model 9728 PC Card (512MB)

Model 9729 PC Card (1GB)

Model 9830 PC Card (2GB)

Others

Model 9782 Carrying Case

Model 9812 Soft Case

Model 9809 Protection Sheet

Appendix 7 Easy setting for RMS recorder mode

Measuring voltage applied at and current flowing through breaker

(Example) 200 V AC, 30 A, 60 Hz

1 **WAVE/DATA** **SET** **FILE** → **Setting**

2 **Select [Setting]**

Select [Easy Set]

A dialog appears. Select [Measurement Guide]

Apply

Easy Set dialog options:

- Measurement Guide
- Setting Guide
- Current Measurement with Clamp
- Voltage Measurement
- Close

Configure the CH1 settings to measure AC voltage

1 **Move to [Measure AC Volt on RMS]**

2 **Move to [Meas_Frequency]**

Show available setting options.

Select [60 Hz]

Apply

3 Move a cursor [Vline].



Show available setting options.



Select [200Vline].



Apply



4 Move to [Measure AC Volt on RMS].



Apply



5 Selecting CH1 is completed

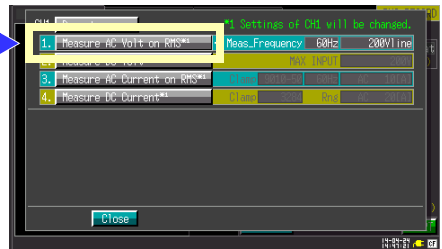
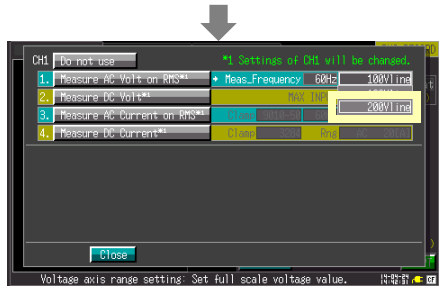

Configure the CH2 settings to measure AC current

1 Move to [Measure AC Current on RMS].



2 Move to [Clamp].



Show available setting options.



Select [9018-50].



Apply

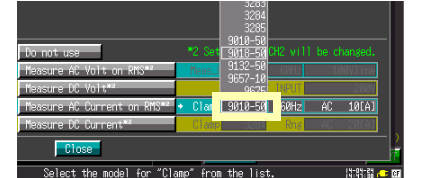
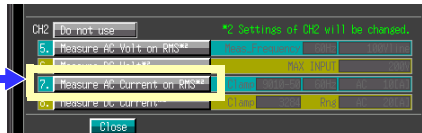

The measurement frequency, which is shared with that of CH1, has been set to 60 Hz.

Appendix 7 Easy setting for RMS recorder mode

3 Move a cursor [AC [A]].

Show available setting options.

Select [AC 50[A]].

Apply

4 Move to [Measure AC Current on RMS].

Apply

5 Selecting CH2 is completed. The set contents are reflected in the instrument and the screen switches.

Configure the following settings after completing the content selection of CH1 and CH2.

- 1** Set [Interval].
 - 2** Set [Auto-save].
 - 3** Select [START] to start measuring.
- Apply

axis (recording speed) setting: Set the time interval for capturing

Appendix 8 Executing zero adjustment for Model CT969x series and Model CT6590

Zero adjustment for measurement using Model CT969x series in combination with Model CT6590

Before starting measurement, correct any output deviations with the unit's zero-adjustment knob. If the instrument fails to display a value close to 0 A even after zero-adjustment is performed, have the sensor unit and clamp sensor repaired.

- 1 Ensure that the connected clamp sensor has not been placed around a conductor.
- 2 Holding the unit in one hand, rotate the zero-adjustment knob with your other hand until the measured value on the instrument's display indicates a value near 0 A.

The zero-adjustment knob is designed to be difficult to turn so that you do not inadvertently operate it after performing zero-adjustment.

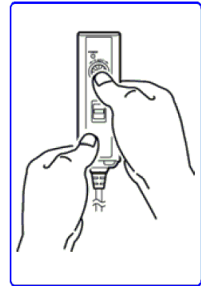

Appendix 9 To 8870-20 Users (Firmware Ver. 1.08 or Earlier)

To load data saved by the MR8870-20 with the 8870-20, you must first upgrade the 8870-20 firmware to version 2.00 or later. You can check the current firmware version on the top right of the System screen.

You can upgrade the 8870-20 firmware to the latest version from your myHioki page at the following address:

<http://www.hioki.com/mypage/login.php>

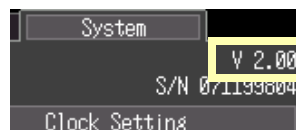

Please contact your Hioki distributor if you have any questions about the firmware upgrade process.

(You can find contact information on the reverse of this sheet.)

□ If you have loaded 8870-20 data (firmware ver. 1.08 or earlier)

The MR8870-20 and 8870-20 (firmware version 2.00) add scaling [Model] and [Rate] settings (see [1] in the following table). Loading data saved with one of the models listed in (1) selected with a 8870-20 with firmware version 1.08 or earlier will cause the indicated model number to change (see [2] in the table below). However, waveform, measured values, and gauge value scaling information will be retained.

	(1) MR8870-20 and 8870-20 (firmware ver. 2.00) added settings	(2) 8870-20 (firmware ver. 1.08 and earlier)
[Model]	3283, 3284, 3285, 9657-10, 9675, CT9691, CT9692, CT9693, CT9667	9322
[Rate]	1V → 10000A, 1V → 10V, 1V → 50V, 1V → 100V, 1V → 500V	1V → 1000V

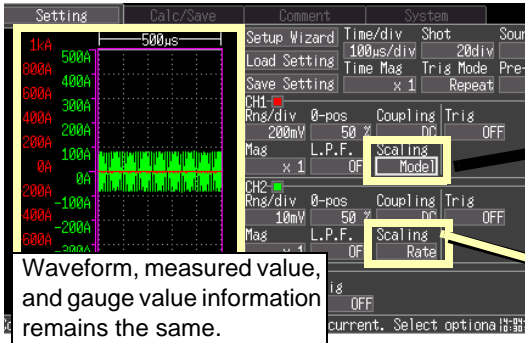

Waveform, measured value, and gauge value information remains the same.

MR8870-20, 8870-20 (V2.00)

Settings have changed.

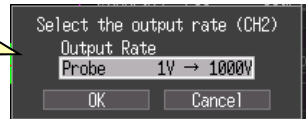
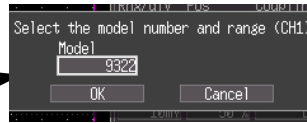

8870-20 (Version 1.08 or Earlier)

Appendix 10 To MR8870-20 Users (Firmware Ver. 2.03 or Earlier)

To load data saved by the MR8870-20, you must first upgrade the firmware to version 2.04 or later. You can check the current firmware version on the top right of the System screen.

You can upgrade the 8870-20 firmware to the latest version from your myHioki page at the following address:

<http://www.hioki.com/mypage/login.php>

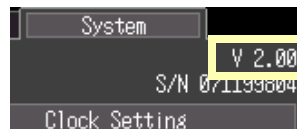

Please contact your Hioki distributor if you have any questions about the firmware upgrade process.

(You can find contact information on the reverse of this sheet.)

□ If you have loaded MR8870-20 data (firmware ver. 1.08 or earlier)

The MR8870-20 (firmware version 2.03) add scaling [Model] and [Rate] settings (see [1] in the following table). Loading data saved with one of the models listed in (1) selected with a 8870-20 with firmware version 2.03 or earlier will cause the indicated model number to change (see [2] in the table below). However, waveform, measured values, and gauge value scaling information will be retained.

	(1)(firmware ver. 2.00) added settings	(2) (firmware ver. 1.08 and earlier)
[Model]	3283, 328x, CT6500, CT704x, CT76xx, CT77xx, P9000/9322, 9010/9018-50, 9132-50, 9657-10/, 9675, 96xx, CT969x	9010, 9018, 9132, 9322, 3283, 3284, 3285, 9657, 9675, CT9691, CT9692, CT9693

Settings have changed.

Waveform, measured value, and gauge value information remains the same.

(V2.04)

(Version 2.03 or Earlier)

A22

Appendix 10 To MR8870-20 Users (Firmware Ver. 2.03 or Earlier)

Index

Number

2-Point 50

A

A/B cursors 66
 Aliasing A 11
 Analog channel 47
 Analog trigger 55
 AND 56
 Auto calculation 93, 94
 Auto Range 42
 Auto Save 77, 78
 Average value 93, 97

B

Backlight Saver 101
 Beep Sound 101
 Before Returning for Repair 128
 Binary 71, 73
 Binary format 87

C

CF 15, 17
 CF 104
 CF card 74
 Delete 89
 Folder 88
 Format 76
 Load Setting 85
 Rename 89
 Sort 90
 Clock Setting 102
 Comment 52
 Coupling 48
 Current flow direction arrow 31
 Cursor values 19

D

Daisy chain configuration 109
 DC 48
 Default settings A 9

Delete-and-save 79
 Display Color 101
 Drop 58

E

envelope recording A 12
 Error messages A 1
 EXT.TRIG 105, 107
 External control 105
 External trigger 55, 105

F

File Naming A 5
 File screen 76, 88
 Filter 59
 Filter width 59
 Filter width (Logic) 62
 Format (CF card) 76
 Freq 60, 93

G

Gauges 66
 GND 48, 105

H

Horizontal cursors 67

I

In (In-Window Trigger) 58
 Initialize 103
 Instrument Installation 6

J

Jump 65

K

KEY LOCK 15
 Key operation
 keys do not work. 128
 KEY/LED 104

Index 2

Index

Key-Lock Function20

L

L.P.F49
Language103
LCD 101, 104
Level (Level trigger)58
Level (Trigger level)59
Load87
Load Setting85
Logic channel51
Logic Trigger 55, 61
Lower (trigger threshold)60
Low-Pass Filter49

M

Mag (magnification of the vertical axis) .49
Manual trigger 55, 62
Maximum value 93, 97
Measurement configuration
 Setting screen40
 Waveform screen41
Measurement frequency limit A 12
Measurement mode 12, 38
Minimum value 93, 97
Model50

N

N.C.105
Numerical calculation results
 Save77
Numerical calculations93
 Manual calculation95
Numerical value display69

O

Offset50
offset50
Operation keys15
Options A 13, A 19, A 21
OR56
Out (Out-of-Window Trigger)58

P

Pattern (trigger pattern)62
Peak-to-peak value93
Period 93, 96, 97
Pos (position)51

Pre-Trigger 56

Q

Quick Save 77, 80, 86

R

Ratio (output rate) 50
Repair 127
Repeat 46
RMS value 93, 97
Rng/div (Range/division) 47
Roll Mode 64
ROM/RAM 104

S

Safety Information 3
Sampling A 11
Save
 Auto Save 77
 File type 71
 Numerical Calculation Results 83
 Quick Save 77
 Save Setting 84
 Screen Image 20, 82
 Select&Save 77
 Waveform data 81
Scaling 50
 2-Point 50
 Model 50
Scroll 64
Select&Save 77, 80, 86
Selecting a Timebase A 11
Self-Test 104
Setting Navi 42
Shot (div) 45
Single 46
Slope 59
Source (Trigger source) 56
Specifications 111
Start Backup 100
System screen 99

T

Thinning 78, 81
Time Mag (magnification of the horizontal axis) 45
Timebase 44
Title 52

Trace	64
Trace cursors	67
Trig Mode (Trigger Mode)	46
TRIG.OUT	105, 108
Trigger	55, 58, 61
Drop	58
In	58
Level	58
Out	58
Voltage sag trigger (Drop)	58
Trigger filter	59
Trigger input signals	107
Trigger output	105
Trigger output signals	108

U

Upper (trigger threshold)	60
USB cable	85, 91

V

Vertical cursors	67
Voltage Axis (vertical axis) Range	47
Voltage sag trigger (Drop)	58

W

Waveform	81
Waveform backup	117
Waveform display color	47
Waveform screen	63
Window trigger	58

Z

Zero position (Pos)	48
---------------------------	----

Index 4

Index

Warranty Certificate

HIOKI

Model	Serial No.	Warranty period One (1) year from date of purchase (__ / __)
-------	------------	---

This product passed a rigorous inspection process at Hioki before being shipped.

In the unlikely event that you experience an issue during use, please contact the distributor from which you purchased the product, which will be repaired free of charge subject to the provisions of this Warranty Certificate. This warranty is valid for a period of one (1) year from the date of purchase. If the date of purchase is unknown, the warranty is considered valid for a period of one (1) year from the product's date of manufacture. Please present this Warranty Certificate when contacting the distributor.

Accuracy is guaranteed for the duration of the separately indicated guaranteed accuracy period.

1. Malfunctions occurring during the warranty period under conditions of normal use in conformity with the Instruction Manual, product labeling (including stamped markings), and other precautionary information will be repaired free of charge, up to the original purchase price. Hioki reserves the right to decline to offer repair, calibration, and other services for reasons that include, but are not limited to, passage of time since the product's manufacture, discontinuation of production of parts, or unforeseen circumstances.
2. Malfunctions that are determined by Hioki to have occurred under one or more of the following conditions are considered to be outside the scope of warranty coverage, even if the event in question occurs during the warranty period:
 - a. Damage to objects under measurement or other secondary or tertiary damage caused by use of the product or its measurement results
 - b. Malfunctions caused by improper handling or use of the product in a manner that does not conform with the provisions of the Instruction Manual
 - c. Malfunctions or damage caused by repair, adjustment, or modification of the product by a company, organization, or individual not approved by Hioki
 - d. Consumption of product parts, including as described in the Instruction Manual
 - e. Malfunctions or damage caused by transport, dropping, or other handling of the product after purchase
 - f. Changes in the product's appearance (scratches on its enclosure, etc.)
 - g. Malfunctions or damage caused by fire, wind or flood damage, earthquakes, lightning, power supply anomalies (including voltage, frequency, etc.), war or civil disturbances, radioactive contamination, or other acts of God
 - h. Damage caused by connecting the product to a network
 - i. Failure to present this Warranty Certificate
 - j. Failure to notify Hioki in advance if used in special embedded applications (space equipment, aviation equipment, nuclear power equipment, life-critical medical equipment or vehicle control equipment, etc.)
 - k. Other malfunctions for which Hioki is not deemed to be responsible

***Requests**

- Hioki is not able to reissue this Warranty Certificate, so please store it carefully.
- Please fill in the model, serial number, and date of purchase on this form.

16-01 EN

HIOKI E.E. CORPORATION

81 Koizumi, Ueda, Nagano 386-1192, Japan
TEL: +81-268-28-0555
FAX: +81-268-28-0559

- Please visit our website at www.hioki.com for the following:
 - Regional contact information
 - The latest revisions of instruction manuals and manuals in other languages.
 - Declarations of Conformity for instruments that comply with CE mark requirements.
- All reasonable care has been taken in the production of this manual, but if you find any points which are unclear or in error, please contact your supplier or the International Sales and Marketing Department at Hioki headquarters.
- In the interests of product development, the contents of this manual are subject to revision without prior notice.
- The content of this manual is protected by copyright.
No reproduction, duplication or modification of the content is permitted without the authorization of Hioki E.E. Corporation.

HIOKI

HIOKI E. E. CORPORATION

HEADQUARTERS

81 Koizumi, Ueda, Nagano 386-1192, Japan
TEL +81-268-28-0562 FAX +81-268-28-0568
os-com@hioki.co.jp
(International Sales Department)

www.hioki.com

HIOKI USA CORPORATION

hioki@hiokiusa.com www.hiokiusa.com

HIOKI (Shanghai) SALES & TRADING CO., LTD.

info@hioki.com.cn www.hioki.cn

HIOKI INDIA PRIVATE LIMITED

hioki@hioki.in www.hioki.in

HIOKI SINGAPORE PTE. LTD.

info@hioki.com.sg

1601EN