

# HIOKI

CURRENT SENSOR Series  
CURRENT PROBE Series

NEW



## Application-optimized Current Sensors and Current Probes



## Application-optimized current sensors and current probes

Hioki offers lineup of current sensors and current probes to accommodate current measurement requirements in a variety of applications, from development and evaluation in advanced fields to quality control of commercial power supplies.



### Evaluating power conversion efficiency in EVs

Evaluate vehicles' overall power conversion efficiency in order to develop automobiles that run further with less energy.

**CT6904A, CT687x series + PW8001**



### Evaluating the fuel (energy) efficiency of finished vehicles

Measure fuel efficiency based on the international standard (WLTP) in order to evaluate the fuel efficiency of finished vehicles.

**CT684x-05 series + PW3390**

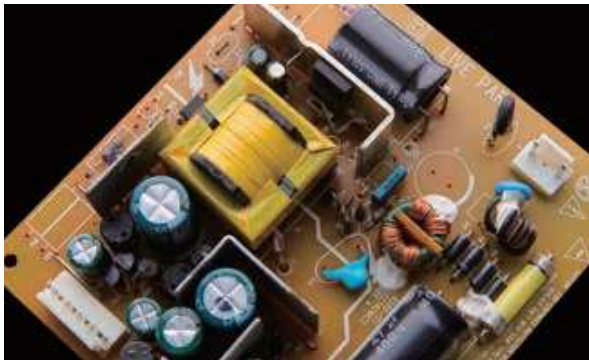

### Evaluating power devices in power supply circuits

Observe the inputs and outputs of the current waveform in order to evaluate whether power devices are providing the required level of performance.

**CT67xx series, 327x series + MR6000**



### Evaluating systems used to control accessory components in automobiles

Observe current waveforms of various magnitudes that fluctuate depending on the state of the device in question, including dark current, inrush current, and drive current, in order to evaluate accessory control.

**CT67xx series, 327x series + MR6000**



### Maintaining power quality

Continuously monitor power quality and analyze the causes of power supply issues in order to maintain stable power quality.

**CT7xxx series, CT9667-0x series + PQ3198, PQ3100**



### Assessing the power consumption of equipment and systems

Assess the power consumption of devices and systems in order to pursue energy-saving activities and achieve the goals of the UN's Sustainable Development Goals (SDGs).

**CT7xxx series, CT9667-0x series + PW3365**

## Applications by operating current and operating frequency

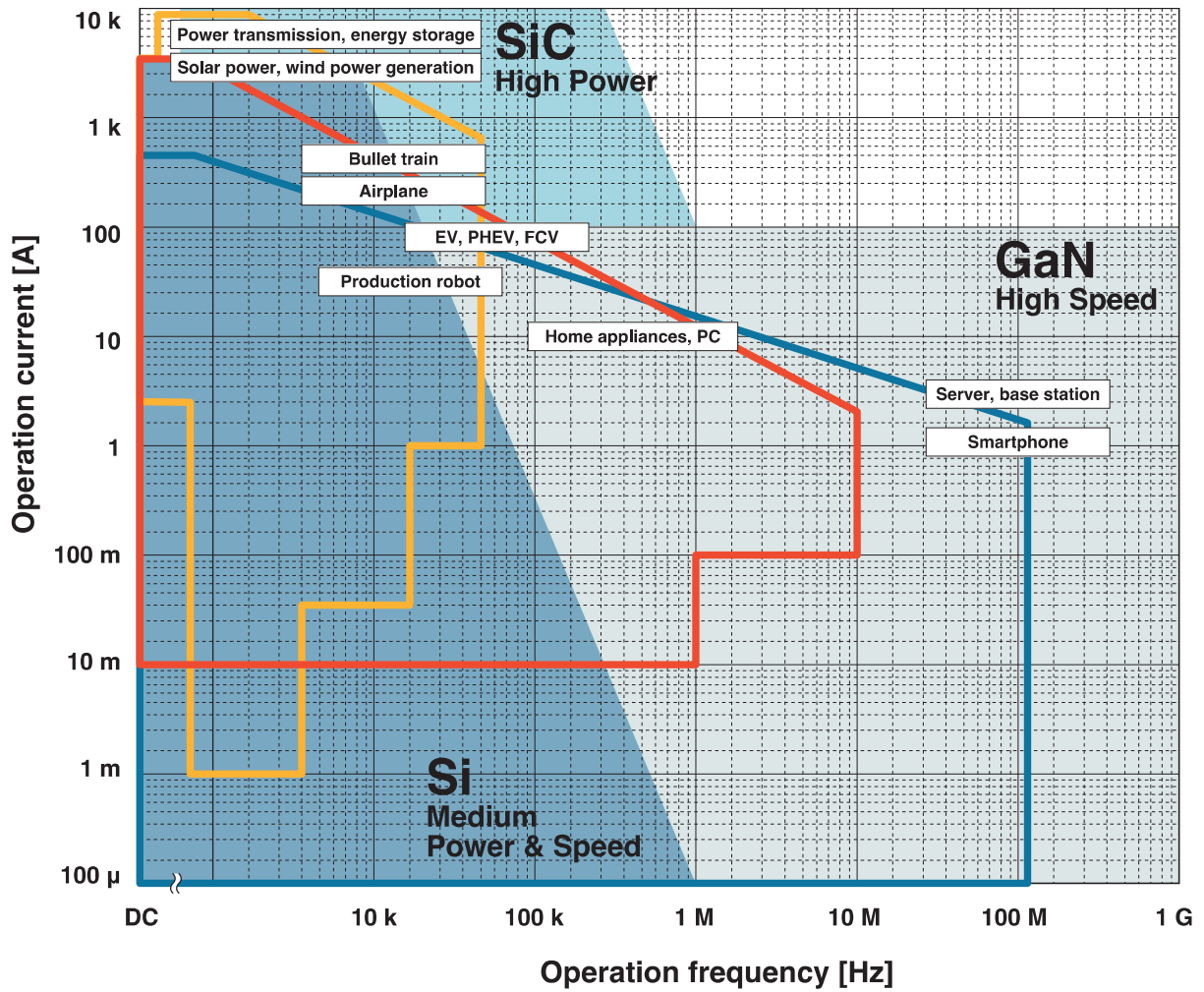

High-accuracy measurement		pass-through types	- EV inverter systems R&D - Assessment of reactor and transformer losses
		clamp types	- WLTP-compliant fuel economy (electricity cost) performance testing
Waveform observation		High-sensitivity observation	- Evaluation of automotive accessory control - Evaluation of power components in power supply circuits
		Observation of minuscule currents	- Evaluation of automotive accessory control - Development and evaluation of power-saving devices such as wearables
		Observation of large currents	- Fluctuations in fluctuation of load currents of large industrial equipment - Measurement of inrush currents flowing when starting an engine
Grid power quality control		Measurement of load currents	- Assessment of power consumption - Periodic inspection of power supply equipment and monitoring of power quality
		Measurement of large currents	
		Measurement of leakage currents	- Detection of intermittent electrical leaks - Search for the locations of electrical leaks



# Current Sensors Current Probes Lineup

Hioki's first current sensor was a magnetic current sensor developed in-house in 1971. We've pursued sensing technologies over the past 50 years, providing a variety of current sensors for the full range of measurement applications.

## High-accuracy measurement

These models, rated for 20 A to 2000 A, measure currents in a frequency band from DC to 10 MHz with a high degree of accuracy. They're used in applications that require high measurement accuracy, for example evaluation of inverter equipment and evaluation of loss in reactors and transformers.

## Pass-through types

Pass-through sensors deliver the ultimate level of accuracy and stability. With a broadband measurement at up to 10 MHz and measurement of large currents of up to 2000 A, they're used in state-of-the-art research and development.



**EV inverter system R&D**

**Evaluation of reactor and transformer losses**

## Clamp types

Clamp-type sensors are quick and easy to connect, and used for testing finished products, an application where it is difficult to cut wires. Capable of functioning at temperatures from -40°C to 85°C, they're used in high-temperature environments such as engine compartments.



**WLTP-compliant fuel economy  
(electricity cost) performance testing**

## Direct-wired types

Directly wired current sensors deliver world-class accuracy and frequency band characteristics (50 A model) by Hioki's proprietary DCCT (Direct Connection Current Transducer) method



**Evaluation of reactor and transformer losses**

**Evaluation of inverters in energy-saving household appliances**



## Waveform observation

These models, rated from 0.5 A to 500 A, measure current waveforms in a frequency band of DC to 120 MHz. They're used to analyze fluctuations during operation of various types of equipment operation, including standby current, inrush current, load current, and control current.

## High-sensitivity observation

These models can measure current waveforms that range in magnitude from minuscule to large. With the high-sensitivity ranges and an output rate of 10 V/A, minuscule currents that fluctuate at high speeds can be clearly observed.



Evaluation of automotive accessory control

Evaluation of power devices in power supply circuits

## Grid power quality control

These models are engineered primarily to measure current at commercial frequencies (50/60 Hz). They're used in applications such as power quality checks and power consumption assessments. We offer models with specifications suitable for a range of measurement locations, from leakage currents to large currents.

## Measurement of load current

These sensors are primarily designed to measure commercial power supplies. They're used to monitor and analyze power quality and to measure power consumption.



Assessment of power consumption

Periodic inspection of power supply equipment and monitoring of power quality

## Observation of minuscule currents

These models can measure minuscule current waveforms, including control currents flowing in control circuits and fluctuations in the current consumption of compact electronic devices that operate at small currents.



Evaluation of automotive accessory control

Development and evaluation of power-saving devices such as wearables

## Measurement of large currents

These sensors can measure large currents of up to 6000 A. Their slim, flexible form make them easy to insert into narrow gaps and between wires.

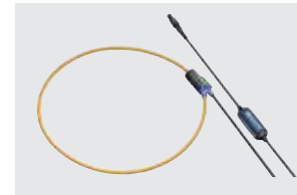

Assessment of power consumption

Periodic inspection of power supply equipment and monitoring of power quality

## Observation of large currents

These models can measure large current waveforms, including fluctuations in load current from the operation of industrial equipment and inrush currents when power supplies are activated.



Fluctuations of load currents of large industrial equipment

Measurement of inrush currents flowing at engine start

## Measurement of leakage currents

These sensors are used to measure minuscule currents such as leakage currents.



Detection of intermittent electrical leaks

Search for the locations of electrical leaks

**High-accuracy measurement** Output terminals: ME15W

**Pass-through types**

50 A	$\phi 24$ mm (0.94 in.)	$\phi 24$ mm (0.94 in.) <b>NEW</b>		
	50 A	50 A		
	DC to 1 MHz	DC to 10 MHz		
	CT6862-05	CT6872, CT6872-01		
200 A	$\phi 24$ mm (0.94 in.)	$\phi 24$ mm (0.94 in.) <b>NEW</b>		
	200 A	200 A		
	DC to 500 kHz	DC to 10 MHz		
	CT6863-05	CT6873, CT6873-01		
500 A	$\phi 36$ mm (1.42 in.)	$\phi 36$ mm (1.42 in.)	$\phi 32$ mm (1.26 in.)	$\phi 32$ mm (1.26 in.)
	500 A	500 A	500 A	500 A
	DC to 2 MHz	DC to 1.5 MHz	DC to 4 MHz	DC to 2 MHz
	CT6875A	CT6875A-1	CT6904A	CT6904A-1
800 A	$\phi 32$ mm (1.26 in.)	$\phi 32$ mm (1.26 in.)		
	800 A	800 A		
	DC to 4 MHz	DC to 2 MHz		
	CT6904A-2	CT6904A-3		
1000 A 2000 A	$\phi 36$ mm (1.42 in.)	$\phi 36$ mm (1.42 in.)	$\phi 80$ mm (3.15 in.)	
	1000 A	1000 A	2000 A	
	DC to 1.5 MHz	DC to 1.2 MHz	DC to 1 MHz	
	CT6876A	CT6876A-1	CT6877A, CT6877A-1	
20 A 200 A	$\phi 20$ mm (0.79 in.)	$\phi 20$ mm (0.79 in.)	$\phi 46$ mm (1.81 in.)	
	20 A	200 A	20 A/200 A	
	DC to 1 MHz	DC to 500 kHz	1 Hz to 100 kHz	
	CT6841-05	CT6843-05	9272-05	
500 A 1000 A	$\phi 20$ mm (0.79 in.)	$\phi 50$ mm (1.97 in.)	$\phi 50$ mm (1.97 in.)	
	500 A	500 A	1000 A	
	DC to 200 kHz	DC to 100 kHz	DC to 20 kHz	
	CT6844-05	CT6845-05	CT6846-05	

**Waveform observation** Output terminals: BNC

Minuscule current waveforms can be observed more clearly by generating output at 10 V/A

Output rate: 1 V/A

Output rate: 10 V/A

Model	Measurement range	Output rate
CT6710 CT6711	0.5 A	10 V/A
	5 A	1 V/A
CT6700 CT6701	5 A	1 V/A
	30 A	0.1 V/A
3273-50 3276	30 A	0.1 V/A
	150 A	0.01 V/A
3274	150 A	0.01 V/A
3275	500 A	0.01 V/A

**High-sensitivity observation**

0.5 A 5 A 30 A	$\phi 5$ mm (0.20 in.)	$\phi 5$ mm (0.20 in.)
	0.5 A, 5 A, 30 A	0.5 A, 5 A, 30 A
	DC to 50 MHz	DC to 120 MHz
	CT6710	CT6711

**Observation of minuscule currents**









5 A	$\phi 5$ mm (0.20 in.)	$\phi 5$ mm (0.20 in.)
	5 A	5 A
	DC to 50 MHz	DC to 120 MHz
	CT6700	CT6701

**Observation of large currents**



30 A	$\phi 5$ mm (0.20 in.)	$\phi 5$ mm (0.20 in.)
	30 A	30 A
	DC to 50 MHz	DC to 100 MHz
	3273-50	3276
150 A 500 A	$\phi 20$ mm (0.79 in.)	$\phi 20$ mm (0.79 in.)
	150 A	500 A
	DC to 10 MHz	DC to 2 MHz
	3274	3275

**Grid power quality control** Output terminals:  
PL14

**Measurement of load current**

60 A 100 A	$\phi 15$ mm (0.59 in.)	$\phi 15$ mm (0.59 in.)	
	 60 A 40 Hz to 20 kHz CT7126	 100 A 40 Hz to 20 kHz CT7131	
100 A	$\phi 33$ mm (1.30 in.)	$\phi 33$ mm (1.30 in.)	
	 100 A DC to 5 kHz CT7731	 100 A DC to 10 kHz CT7631	
600 A	$\phi 33$ mm (1.30 in.)	$\phi 33$ mm (1.30 in.)	$\phi 46$ mm (1.81 in.)
	 600 A DC to 5 kHz CT7736	 600 A DC to 10 kHz CT7636	 600 A 40 Hz to 20 kHz CT7136
	$\phi 55$ mm (2.17 in.)	$\phi 55$ mm (2.17 in.)	
2000 A	 2000 A DC to 5 kHz CT7742	 2000 A DC to 10 kHz CT7642	

**Measurement of large currents**









6000 A	$\phi 100$ mm (3.94 in.)	$\phi 180$ mm (7.09 in.)	$\phi 254$ mm (10.0 in.)
	 6000 A 10 Hz to 50 kHz CT7044	 6000 A 10 Hz to 50 kHz CT7045	 6000 A 10 Hz to 50 kHz CT7046

**Measurement of leakage current**

6 A	$\phi 40$ mm (1.57 in.)
	 6 A 40 Hz to 5 kHz CT7116



**Grid power quality control** Output terminals:  
BNC\*1

**Measurement of load current**



5 A 50 A	$\phi 15$ mm (0.59 in.)	$\phi 15$ mm (0.59 in.)	
	 5 A 40 Hz to 5 kHz 9694	 50 A 40 Hz to 5 kHz 9695-02*1	
100 A	$\phi 15$ mm (0.59 in.)	$\phi 15$ mm (0.59 in.)	
	 100 A 40 Hz to 5 kHz 9660	 100 A 40 Hz to 5 kHz 9695-03*1	
500 A	$\phi 46$ mm (1.81 in.)	$\phi 46$ mm (1.81 in.)	$\phi 46$ mm (1.81 in.)
	 10 A to 500 A*2 40 Hz to 1 kHz 9010-50	 10 A to 500 A*2 40 Hz to 3 kHz 9018-50	 500 A 40 Hz to 5 kHz 9661
	$\phi 46$ mm (1.81 in.)	$\phi 55$ mm (2.17 in.)	
1000 A	 20 A to 1000 A*3 40 Hz to 1 kHz 9132-50	 1000 A 40 Hz to 5 kHz 9669	

\*1: The 9695-02 and 9695-03 use an M3 terminal block for their output terminals. Optional Connection Cable 9219 is required.  
\*2: Range-switched (10, 20, 50, 100, 200, 500 A AC)  
\*3: Range-switched (20, 50, 100, 200, 500, 1000 A AC)

























**Measurement of large currents**

500 A 5000 A	$\phi 100$ mm (3.94 in.)	$\phi 180$ mm (7.09 in.)	$\phi 254$ mm (10.0 in.)
	 500 A, 5000 A 10 Hz to 20 kHz CT9667-01	 500 A, 5000 A 10 Hz to 20 kHz CT9667-02	 500 A, 5000 A 10 Hz to 20 kHz CT9667-03

**Measurement of leakage current**

10 A	$\phi 40$ mm (1.57 in.)	$\phi 30$ mm (1.18 in.)
	 10 A 40 Hz to 5 kHz 9657-10	 10 A 40 Hz to 5 kHz 9675

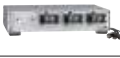

High-accuracy measurement									
Pass-through types									
Model	Appearance	Rated primary current	Maximum peak current	Withstand voltage <sup>*2</sup>	Output voltage	Frequency range	Linearity error	Offset error	Amplitude errors
CT6862-05		50 Arms	±141 A peak	7.4 kV AC	40 mV/A	DC to 1 MHz	-	-	-
CT6872		50 Arms	±200 A peak	7.4 kV AC	40 mV/A	DC to 10 MHz	±2 ppm	±5 ppm	DC: 7 ppm 10 Hz to 100 Hz: 0.005% 100 Hz to 1 kHz: 0.01% 1 kHz to 50 kHz: 0.1% 50 kHz to 100 kHz: 0.3% 100 kHz to 300 kHz: 1% 300 kHz to 1 MHz: 3%
CT6872-01		50 Arms	±200 A peak	7.4 kV AC	40 mV/A	DC to 10 MHz	±2 ppm	±5 ppm	DC: 7 ppm 10 Hz to 100 Hz: 0.005% 100 Hz to 1 kHz: 0.01% 1 kHz to 50 kHz: 0.1% 50 kHz to 100 kHz: 0.3% 100 kHz to 300 kHz: 1% 300 kHz to 1 MHz: 3%
CT6863-05		200 Arms	±565 A peak	7.4 kV AC	10 mV/A	DC to 500 kHz	-	-	-
CT6873		200 Arms	±350 A peak <sup>*1</sup>	7.4 kV AC	10 mV/A	DC to 10 MHz	±2 ppm	±5 ppm	DC: ±7 ppm 10 Hz to 500 Hz: ±0.005% 500 Hz to 3 kHz: ±0.01% 3 kHz to 30 kHz: ±0.1% 30 kHz to 100 kHz: ±0.4% 100 kHz to 400 kHz: ±1% 400 kHz to 1 MHz: ±3%
CT6873-01		200 Arms	±350 A peak <sup>*1</sup>	7.4 kV AC	10 mV/A	DC to 10 MHz	±2 ppm	±5 ppm	DC: ±7 ppm 10 Hz to 500 Hz: ±0.005% 500 Hz to 3 kHz: ±0.01% 3 kHz to 30 kHz: ±0.1% 30 kHz to 100 kHz: ±0.4% 100 kHz to 400 kHz: ±1% 400 kHz to 1 MHz: ±3%
CT6875A		500 Arms	±1500 A peak <sup>*1</sup>	7.4 kV AC	4 mV/A	DC to 2 MHz	±5 ppm	±5 ppm	DC: ±10 ppm 10 Hz to 100 Hz: ±0.005% 100 Hz to 1 kHz: ±0.02% 1 kHz to 20 kHz: ±0.08% 20 kHz to 100 kHz: ±0.5% 100 kHz to 300 kHz: ±1% 300 kHz to 1 MHz: ±5%
CT6875A-1		500 Arms	±1500 A peak <sup>*1</sup>	7.4 kV AC	4 mV/A	DC to 1.5 MHz	±5 ppm	±5 ppm	DC: ±10 ppm 10 Hz to 100 Hz: ±0.005% 100 Hz to 1 kHz: ±0.02% 1 kHz to 20 kHz: ±0.08% 20 kHz to 100 kHz: ±0.5% 100 kHz to 300 kHz: ±1% 300 kHz to 1 MHz: ±5%
CT6904A		500 Arms	±1000 A peak <sup>*1</sup>	7.4 kV AC	4 mV/A	DC to 4 MHz	±5 ppm	±10 ppm	-
CT6904A-1		500 Arms	±1000 A peak <sup>*1</sup>	7.4 kV AC	4 mV/A	DC to 2 MHz	±5 ppm	±10 ppm	-
CT6904A-2		800 Arms	±1200 A peak <sup>*1</sup>	7.4 kV AC	2 mV/A	DC to 4 MHz	±12.5 ppm	±10 ppm	-
CT6904A-3		800 Arms	±1200 A peak <sup>*1</sup>	7.4 kV AC	2 mV/A	DC to 2 MHz	±12.5 ppm	±10 ppm	-
CT6876A		1000 Arms	±1800 A peak <sup>*1</sup>	7.4 kV AC	2 mV/A	DC to 1.5 MHz	±5 ppm	±5 ppm	DC: ±10 ppm 10 Hz to 100 Hz: ±0.005% 100 Hz to 1 kHz: ±0.03% 1 kHz to 10 kHz: ±0.2% 10 kHz to 100 kHz: ±1% 100 kHz to 300 kHz: ±3% 300 kHz to 1 MHz: ±15%
CT6876A-1		1000 Arms	±1800 A peak <sup>*1</sup>	7.4 kV AC	2 mV/A	DC to 1.2 MHz	±5 ppm	±5 ppm	DC: ±10 ppm 10 Hz to 100 Hz: ±0.005% 100 Hz to 1 kHz: ±0.03% 1 kHz to 10 kHz: ±0.2% 10 kHz to 100 kHz: ±1% 100 kHz to 300 kHz: ±3% 300 kHz to 1 MHz: ±15%
CT6877A		2000 Arms	±3200 A peak <sup>*1</sup>	7.4 kV AC	1 mV/A	DC to 1 MHz	±10 ppm	±5 ppm	DC: ±15 ppm 10 Hz to 100 Hz: ±0.01% 100 Hz to 1 kHz: ±0.04% 1 kHz to 10 kHz: ±0.25% 10 kHz to 100 kHz: ±1% 100 kHz to 300 kHz: ±2% 300 kHz to 700 kHz: ±10%
CT6877A-1		2000 Arms	±3200 A peak <sup>*1</sup>	7.4 kV AC	1 mV/A	DC to 1 MHz	±10 ppm	±5 ppm	DC: ±15 ppm 10 Hz to 100 Hz: ±0.01% 100 Hz to 1 kHz: ±0.04% 1 kHz to 10 kHz: ±0.25% 10 kHz to 100 kHz: ±1% 100 kHz to 300 kHz: ±2% 300 kHz to 700 kHz: ±10%
Clamp types									
9272-05		20 Arms, 200 Arms	±71 A peak, ±430 A peak	5.4 kV AC	100 mV/A, 10 mV/A	1 Hz to 100 kHz	-	-	-
CT6841-05		20 Arms	±60 A peak <sup>*1</sup>	4.26 kV AC	100 mV/A	DC to 1 MHz	-	-	-
CT6843-05		200 Arms	±600 A peak <sup>*1</sup>	4.26 kV AC	10 mV/A	DC to 500 kHz	-	-	-
CT6844-05		500 Arms	±800 A peak <sup>*1</sup>	4.26 kV AC	4 mV/A	DC to 200 kHz	-	-	-
CT6845-05		500 Arms	±1500 A peak <sup>*1</sup>	4.26 kV AC	4 mV/A	DC to 100 kHz	-	-	-
CT6846-05		1000 Arms	±1900 A peak <sup>*1</sup>	4.26 kV AC	2 mV/A	DC to 20 kHz	-	-	-
Direct-wired types									
PW9100A-3		50 Arms	±200 A peak <sup>*1</sup>	5.4 kV AC	40 mV/A	DC to 3.5 MHz	-	-	-
PW9100A-4		50 Arms	±200 A peak <sup>*1</sup>	5.4 kV AC	40 mV/A	DC to 3.5 MHz	-	-	-

\*1: Within 20 ms \*2: Sensed current of 1 mA, 50/60 Hz, 1 min









## High-accuracy measurement

Output terminals: ME15W









## pass-through types

Model	Amplitude accuracy		Phase Shift Values	Delay times	Diameter of measurable conductors	Cable length	Operating temperature	Maximum rated voltage to earth	Automatic phase correction*3
	DC	50/60 Hz							
CT6862-05	±0.05% rdg. ±0.01% f.s.	±0.05% rdg. ±0.01% f.s.	300 kHz, -10.96°	101 ns	φ24 mm (0.94 in.)	3 m (9.84 ft.)	-30°C to 85°C -22°F to 185°F	1000 V CAT III	-
CT6872	±0.03% rdg. ±0.002% f.s.	±0.03% rdg. ±0.007% f.s.	100 kHz, -1.28°	46 ns	φ24 mm (0.94 in.)	3 m (9.84 ft.)	-40°C to 85°C -40°F to 185°F	1000 V CAT III	Yes
CT6872-01	±0.03% rdg. ±0.002% f.s.	±0.03% rdg. ±0.007% f.s.	100 kHz, -2.63°	82 ns	φ24 mm (0.94 in.)	10 m (32.81 ft.)	-40°C to 85°C -40°F to 185°F	1000 V CAT III	Yes
CT6863-05	±0.05% rdg. ±0.01% f.s.	±0.05% rdg. ±0.01% f.s.	100 kHz, -4.60°	128 ns	φ24 mm (0.94 in.)	3 m (9.84 ft.)	-30°C to 85°C -22°F to 185°F	1000 V CAT III	-
CT6873	±0.03% rdg. ±0.002% f.s.	±0.03% rdg. ±0.007% f.s.	100 kHz, -0.75°	36 ns	φ24 mm (0.94 in.)	3 m (9.84 ft.)	-40°C to 85°C -40°F to 185°F	1000 V CAT III	Yes
CT6873-01	±0.03% rdg. ±0.002% f.s.	±0.03% rdg. ±0.007% f.s.	100 kHz, -2.10°	69 ns	φ24 mm (0.94 in.)	10 m (32.81 ft.)	-40°C to 85°C -40°F to 185°F	1000 V CAT III	Yes
CT6875A	0.04% rdg. ±0.008% f.s.	0.04% rdg. ±0.008% f.s.	200 kHz, -10.45°	145 ns	φ36 mm (1.42 in.)	3 m (9.84 ft.)	-40°C to 85°C -40°F to 185°F	1000 V CAT III	Yes
CT6875A-1	0.04% rdg. ±0.008% f.s.	0.04% rdg. ±0.008% f.s.	200 kHz, 12.87°	179 ns	φ36 mm (1.42 in.)	10 m (32.81 ft.)	-40°C to 85°C -40°F to 185°F	1000 V CAT III	Yes
CT6904A	±0.025% rdg. ±0.007% f.s.	±0.02% rdg. ±0.007% f.s.	300 kHz, -9.82°	91 ns	φ32 mm (1.26 in.)	3 m (9.84 ft.)	-10°C to 50°C 14°F to 122°F	1000 V CAT III	Yes
CT6904A-1	±0.025% rdg. ±0.007% f.s.	±0.02% rdg. ±0.007% f.s.	300 kHz, -9.82°	91 ns	φ32 mm (1.26 in.)	10 m (32.81 ft.)	-10°C to 50°C 14°F to 122°F	1000 V CAT III	Yes
CT6904A-2	±0.030% rdg. ±0.009% f.s.	±0.025% rdg. ±0.009% f.s.	300 kHz, -9.82°	91 ns	φ32 mm (1.26 in.)	3 m (9.84 ft.)	-10°C to 50°C 14°F to 122°F	1000 V CAT III	Yes
CT6904A-3	±0.030% rdg. ±0.009% f.s.	±0.025% rdg. ±0.009% f.s.	300 kHz, -9.82°	91 ns	φ32 mm (1.26 in.)	10 m (32.81 ft.)	-10°C to 50°C 14°F to 122°F	1000 V CAT III	Yes
CT6876A	0.04% rdg. ±0.008% f.s.	0.04% rdg. ±0.008% f.s.	200 kHz, -12.96°	180 ns	φ36 mm (1.42 in.)	3 m (9.84 ft.)	-40°C to 85°C -40°F to 185°F	1000 V CAT III	Yes
CT6876A-1	0.04% rdg. ±0.008% f.s.	0.04% rdg. ±0.008% f.s.	200 kHz, -14.34°	199 ns	φ36 mm (1.42 in.)	10 m (32.81 ft.)	-40°C to 85°C -40°F to 185°F	1000 V CAT III	Yes
CT6877A	0.04% rdg. ±0.008% f.s.	0.04% rdg. ±0.008% f.s.	100 kHz, -2.63°	73 ns	φ80 mm (3.15 in.)	3 m (9.84 ft.)	-40°C to 85°C -40°F to 185°F	1000 V CAT III	Yes
CT6877A-1	0.04% rdg. ±0.008% f.s.	0.04% rdg. ±0.008% f.s.	100 kHz, -3.34°	93 ns	φ80 mm (3.15 in.)	10 m (32.81 ft.)	-40°C to 85°C -40°F to 185°F	1000 V CAT III	Yes
<b>clamp types</b>									
9272-05	-	±0.3% rdg. ±0.01% f.s.	50 kHz, -3.34° 50 kHz, -4.18°	186 ns, 232 ns	φ46 mm (1.81 in.)	3 m (9.84 ft.)	0°C to 50°C 32°F to 122°F	600 V CAT III	-
CT6841-05	±0.3% rdg. ±0.05% f.s.	±0.3% rdg. ±0.01% f.s.	100 kHz, -1.82°	51 ns	φ20 mm (0.79 in.)	3 m (9.84 ft.)	-40°C to 85°C -40°F to 185°F	-	-
CT6843-05	±0.3% rdg. ±0.02% f.s.	±0.3% rdg. ±0.01% f.s.	100 kHz, -1.68°	47 ns	φ20 mm (0.79 in.)	3 m (9.84 ft.)	-40°C to 85°C -40°F to 185°F	-	-
CT6844-05	±0.3% rdg. ±0.02% f.s.	±0.3% rdg. ±0.01% f.s.	50 kHz, -1.29°	72 ns	φ20 mm (0.79 in.)	3 m (9.84 ft.)	-40°C to 85°C -40°F to 185°F	-	-
CT6845-05	±0.3% rdg. ±0.02% f.s.	±0.3% rdg. ±0.01% f.s.	20 kHz, -0.62°	86 ns	φ50 mm (1.97 in.)	3 m (9.84 ft.)	-40°C to 85°C -40°F to 185°F	-	-
CT6846-05	±0.3% rdg. ±0.02% f.s.	±0.3% rdg. ±0.01% f.s.	20 kHz, -1.89°	263 ns	φ50 mm (1.97 in.)	3 m (9.84 ft.)	-40°C to 85°C -40°F to 185°F	-	-
<b>direct-wired types</b>									
PW9100A-3	±0.02% rdg. ±0.007% f.s.	±0.02% rdg. ±0.005% f.s.	300 kHz, -2.80°	26 ns	M6 screw terminals	3 ch	0°C to 40°C 32°F to 104°F	1000 V CAT II 600 V CAT III	Yes
PW9100A-4	±0.02% rdg. ±0.007% f.s.	±0.02% rdg. ±0.005% f.s.	300 kHz, -2.80°	26 ns	M6 screw terminals	4 ch	0°C to 40°C 32°F to 104°F	1000 V CAT II 600 V CAT III	Yes





\*3: When using PW8001

Waveform observation								Output terminals: BNC	
Model	Appearance	Rated current: output rate	Frequency range	Rise time (10% to 90%)	Delay time	Amplitude accuracy	Diameter of measurable conductors	Cable length*1	Operating temperature
<b>High-sensitivity observation of currents ranging in magnitude from minuscule to large</b>									
CT6710		0.5 Arms: 10 V/A 5 Arms: 1 V/A 30 Arms: 0.1 V/A	DC to 50 MHz	7.0 ns or less	12 ns*2	±3.0% rdg. ±1 mV	φ5 mm (0.20 in.)	1.5 m, 1 m (4.92 ft., 3.28 ft.)	0°C to 40°C 32°F to 104°F
CT6711		0.5 Arms: 10 V/A 5 Arms: 1 V/A 30 Arms: 0.1 V/A	DC to 120 MHz	2.9 ns or less	12 ns*2	±3.0% rdg. ±1 mV	φ5 mm (0.20 in.)	1.5 m, 1 m (4.92 ft., 3.28 ft.)	0°C to 40°C 32°F to 104°F
<b>Observation of minuscule currents</b>									
CT6700		5 Arms: 1 V/A	DC to 50 MHz	7.0 ns or less	13 ns	±3.0% rdg. ±1 mV	φ5 mm (0.20 in.)	1.5 m, 1 m (4.92 ft., 3.28 ft.)	0°C to 40°C 32°F to 104°F
CT6701		5 Arms: 1 V/A	DC to 120 MHz	2.9 ns or less	12 ns	±3.0% rdg. ±1 mV	φ5 mm (0.20 in.)	1.5 m, 1 m (4.92 ft., 3.28 ft.)	0°C to 40°C 32°F to 104°F
<b>Observation of large currents</b>									
3273-50		30 Arms: 0.1 V/A	DC to 50 MHz	7.0 ns or less	16 ns	±1.0% rdg. ±1 mV	φ5 mm (0.20 in.)	1.5 m, 1 m (4.92 ft., 3.28 ft.)	0°C to 40°C 32°F to 104°F
3276		30 Arms: 0.1 V/A	DC to 100 MHz	3.5 ns or less	14 ns	±1.0% rdg. ±1 mV	φ5 mm (0.20 in.)	1.5 m, 1 m (4.92 ft., 3.28 ft.)	0°C to 40°C 32°F to 104°F
3274		150 Arms: 0.01 V/A	DC to 10 MHz	35 ns or less	40 ns	±1.0% rdg. ±1 mV	φ20 mm (0.79 in.)	2.0 m, 1 m (6.56 ft., 3.28 ft.)	0°C to 40°C 32°F to 104°F
3275		500 Arms: 0.01 V/A	DC to 2 MHz	175 ns or less	66 ns	±1.0% rdg. ±5 mV	φ20 mm (0.79 in.)	2.0 m, 1 m (6.56 ft., 3.28 ft.)	0°C to 40°C 32°F to 104°F















\*1: Sensor cable: cable between relay box and sensor for models with relay boxes (i.e. CT6710, CT6711), power supply cable for other models \*2: When using 0.5 A range: 13 ns

Grid power quality control								Output terminals: PL14	
Model	Appearance	Rated current	Frequency range	Amplitude accuracy	Diameter of measurable conductors	Cable length	Operating temperature	CAT	
<b>Measurement of load current</b>									
CT7126		60 A AC	40 Hz to 20 kHz	±0.3% rdg. ±0.01% f.s.	φ15 mm (0.59 in.)	2.5 m (8.20 ft.)	-10°C to 50°C 14°F to 122°F	300 V CAT III	
CT7131		100 A AC	40 Hz to 20 kHz	±0.3% rdg. ±0.02% f.s.	φ15 mm (0.59 in.)	2.5 m (8.20 ft.)	-10°C to 50°C 14°F to 122°F	300 V CAT III	
CT7731		100 A AC/DC	DC to 5 kHz	±1.0% rdg. ±0.5% f.s.	φ33 mm (1.30 in.)	2.5 m (8.20 ft.)	-25°C to 65°C -13°F to 149°F	600 V CAT IV	
CT7631		100 A AC/DC	DC to 10 kHz	±1.0% rdg. ±0.5% f.s.	φ33 mm (1.30 in.)	2.5 m (8.20 ft.)	-25°C to 65°C -13°F to 149°F	600 V CAT IV	
CT7736		600 A AC/DC	DC to 5 kHz	±2.0% rdg. ±0.5% f.s.	φ33 mm (1.30 in.)	2.5 m (8.20 ft.)	-25°C to 65°C -13°F to 149°F	600 V CAT IV	
CT7636		600 A AC/DC	DC to 10 kHz	±2.0% rdg. ±0.5% f.s.	φ33 mm (1.30 in.)	2.5 m (8.20 ft.)	-25°C to 65°C -13°F to 149°F	600 V CAT IV 1000 V CAT III	
CT7136		600 A AC	40 Hz to 20 kHz	±0.3% rdg. ±0.01% f.s.	φ46 mm (1.81 in.)	2.5 m (8.20 ft.)	-10°C to 50°C 14°F to 122°F	600 V CAT IV 1000 V CAT III	
CT7742		2000 A AC/DC	DC to 5 kHz	±1.5% rdg. ±0.5% f.s.	φ55 mm (2.17 in.)	2.5 m (8.20 ft.)	-25°C to 65°C -13°F to 149°F	600 V CAT IV 1000 V CAT III	
CT7642		2000 A AC/DC	DC to 10 kHz	±1.5% rdg. ±0.5% f.s.	φ55 mm (2.17 in.)	2.5 m (8.20 ft.)	-25°C to 65°C -13°F to 149°F	600 V CAT IV 1000 V CAT III	



Model	Appearance	Rated current	Frequency range	Amplitude accuracy	Diameter of measurable conductors	Cable length	Operating temperature	CAT
<b>Measurement of large currents</b>								
CT7044		6000 A AC	10 Hz to 50 kHz	±1.5% rdg. ±0.25% f.s.	φ100 mm (3.94 in.)	2.3 m, 0.2 m* (7.55 ft., 0.66 ft.)	-25°C to 65°C -13°F to 149°F	600 V CAT IV 1000 V CAT III
CT7045		6000 A AC	10 Hz to 50 kHz	±1.5% rdg. ±0.25% f.s.	φ180 mm (7.09 in.)	2.3 m, 0.2 m* (7.55 ft., 0.66 ft.)	-25°C to 65°C -13°F to 149°F	600 V CAT IV 1000 V CAT III
CT7046		6000 A AC	10 Hz to 50 kHz	±1.5% rdg. ±0.25% f.s.	φ254 mm (10.00 in.)	2.3 m, 0.2 m* (7.55 ft., 0.66 ft.)	-25°C to 65°C -13°F to 149°F	600 V CAT IV 1000 V CAT III
<b>Measurement of leakage current</b>								
CT7116		6 A AC	40 Hz to 5 kHz	±1.0% rdg. ±0.05% f.s.	φ40 mm (1.57 in.)	2.5 m (8.20 ft.)	-25°C to 65°C -13°F to 149°F	-

\*Sensor cable: between flexible loop and circuit box for flexible sensors (e.g. CT7044), output cable for CT7116

<b>Grid power quality control</b>								Output terminals: BNC
Model	Appearance	Rated current	Frequency range	Amplitude accuracy	Diameter of measurable conductors	Cable length	Operating temperature	CAT
<b>Measurement of load current</b>								
9694		5 A AC	40 Hz to 5 kHz	±0.3% rdg. ±0.02% f.s.	φ15 mm (0.59 in.)	3 m (9.84 ft.)	0°C to 50°C 32°F to 122°F	300 V CAT III
9695-02*1		50 A AC	40 Hz to 5 kHz	±0.3% rdg. ±0.02% f.s.	φ15 mm (0.59 in.)	-	0°C to 50°C 32°F to 122°F	300 V CAT III
9660		100 A AC	40 Hz to 5 kHz	±0.3% rdg. ±0.02% f.s.	φ15 mm (0.59 in.)	3 m (9.84 ft.)	0°C to 50°C 32°F to 122°F	300 V CAT III
9695-03*1		100 A AC	40 Hz to 5 kHz	±0.3% rdg. ±0.02% f.s.	φ15 mm (0.59 in.)	-	0°C to 50°C 32°F to 122°F	300 V CAT III
9010-50		10 A to 500 A AC	40 Hz to 1 kHz	±2% rdg. ±1% f.s.	φ46 mm (1.81 in.)	3 m (9.84 ft.)	0°C to 50°C 32°F to 122°F	600 V CAT III
9018-50		10 A to 500 A AC	40 Hz to 3 kHz	±1.5% rdg. ±0.1% f.s.	φ46 mm (1.81 in.)	3 m (9.84 ft.)	0°C to 50°C 32°F to 122°F	600 V CAT III
9132-50		20 A to 1000 A AC	40 Hz to 1 kHz	±3% rdg. ±0.2% f.s.	φ55 mm (2.17 in.)	3 m (9.84 ft.)	-10°C to 50°C 14°F to 122°F	600 V CAT III
9661		500 A AC	40 Hz to 5 kHz	±0.3% rdg. ±0.01% f.s.	φ46 mm (1.81 in.)	3 m (9.84 ft.)	0°C to 50°C 32°F to 122°F	600 V CAT III
9669		1000 A AC	40 Hz to 5 kHz	±1.0% rdg. ±0.01% f.s.	φ55 mm (2.17 in.)	3 m (9.84 ft.)	0°C to 50°C 32°F to 122°F	600 V CAT III
<b>Measurement of large currents</b>								
CT9667-01		500 A, 5000 A AC	10 Hz to 20 kHz	±2% rdg. ±0.3% f.s.	φ100 mm (3.94 in.)	2 m, 1 m*2 (6.56 ft., 3.28 ft.)	-25°C to 65°C -13°F to 149°F	600 V CAT IV 1000 V CAT III
CT9667-02		500 A, 5000 A AC	10 Hz to 20 kHz	±2% rdg. ±0.3% f.s.	φ180 mm (7.09 in.)	2 m, 1 m*2 (6.56 ft., 3.28 ft.)	-25°C to 65°C -13°F to 149°F	600 V CAT IV 1000 V CAT III
CT9667-03		500 A, 5000 A AC	10 Hz to 20 kHz	±2% rdg. ±0.3% f.s.	φ254 mm (10.00 in.)	2 m, 1 m*2 (6.56 ft., 3.28 ft.)	-10°C to 50°C 14°F to 122°F	600 V CAT IV 1000 V CAT III
<b>Measurement of leakage current</b>								
9657-10		10 A AC	40 Hz to 5 kHz	±1.0% rdg. ±0.05% f.s.	φ40 mm (1.57 in.)	3 m (9.84 ft.)	0°C to 50°C 32°F to 122°F	-
9675		10 A AC	40 Hz to 5 kHz	±1.0% rdg. ±0.005% f.s.	φ30 mm (1.18 in.)	3 m (9.84 ft.)	0°C to 50°C 32°F to 122°F	-

\*1: The 9695-02 and 9695-03 use an M3 terminal block for their output terminals. The extra purchase of the connection cable 9219 is required.

\*2: Sensor cable: between flexible loop and circuit box for flexible sensors (e.g. CT9667-01), output cable for others.

# High-accuracy measurement

ME15W		Directly wired			External power supply + connection cord			Conversion cable
CT6862-05								
CT6872								
CT6872-01								
CT6863-05								
CT6873								
CT6873-01								
CT6875A								
CT6875A-1								
CT6904A								
CT6904A-1								
CT6904A-2								
CT6904A-3								
CT6876A								
CT6876A-1								
CT6877A								
CT6877A-1								
9272-05								
CT6841-05								
CT6843-05								
CT6844-05								
CT6845-05								
CT6846-05								
PW9100A-3								
PW9100A-4								

ME15W	BNC	BNC	BNC	PL23
 PW8001	 PW3335-03	 U8975	 MR8870	 8971+9318
 PW6001	 PW3335-04	 U8976	 MR8880	The 9318 comes with the 8971
 PW3390	 PW3336	 U8978	 MR8875 + MR8901	
 U8977	 PW3337	 8966		
		 8968		
		 8972		

**CT9902 (ME15W-ME15W)**

The CT9902 can be used to extend a current sensor's cable by 5 m. Up two of these cables can be used for a maximum extension of 10 m.

\*When using the CT9902, an addition must be made to accuracy. For details, see the sensor's user manual.

**CT9555, CT9556**  
Connects one sensor

**CT9557\***  
Connects four sensors.

**L9217**  
Isolated BNC

**9165**  
metallic BNC

Connects CT9555, CT9556 or CT6557 and instrument.

**CT9901**  
Converts ME15W terminal to PL23 terminal

\*The CT9557 can output four channels of input as an added waveform.

CT9557 Front

Sensor input

Rear

1 2 3

1	Total RMS output (BNC)	CONNECTION CABLE <b>L9217, 9165</b> BNC-BNC
2	Total waveform output (BNC)	CONNECTION CABLE <b>L9217, 9165</b> BNC-BNC
3	Total waveform output (ME15W)	CONNECTION CABLE <b>CT9904</b> ME15W-ME15W

We accept special orders for extending sensor cables. For inquiries, please contact Hioki for more information.

# Waveform observation

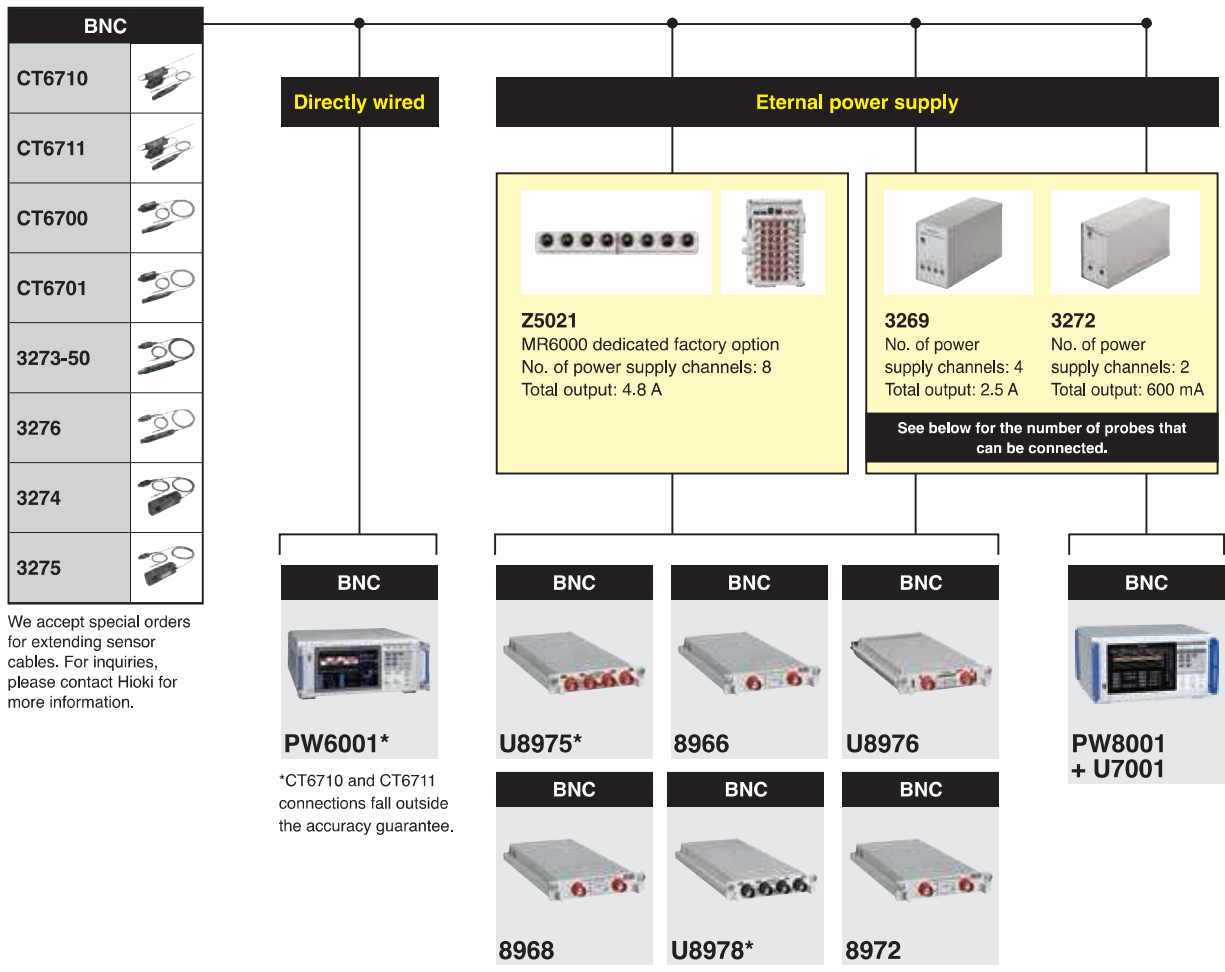

We accept special orders for extending sensor cables. For inquiries, please contact Hioki for more information.

**PW6001\***  
\*CT6710 and CT6711 connections fall outside the accuracy guarantee.

\*Special-order cables are required when using three or more probes simultaneously. Please contact Hioki for details.

The following products can be used with the U8975, U8976, U8978, 8966, 8968, and 8972

	U8975 ✓ U8976 ✓ U8977 ✓ U8978 ✓ 8966 ✓ 8968 ✓ 8971 ✓ 8972 ✓		U8975 ✓ U8976 - U8977 ✓ U8978 ✓ 8966 ✓ 8968 ✓ 8971 ✓ 8972 ✓		U8975 - U8976 - U8977 - U8978 - 8966 ✓ 8968 ✓ 8971 ✓ 8972 ✓
	U8975 ✓ U8976 - U8977 ✓ U8978 ✓ 8966 ✓ 8968 ✓ 8971 ✓ 8972 ✓		U8975 - U8976 - U8977 - U8978 - 8966 ✓ 8968 ✓ 8971 ✓ 8972 ✓		U8975 - U8976 - U8977 - U8978 - 8966 ✓ 8968 ✓ 8971 - 8972 ✓

## Current consumption per probe and number of probes per power supply

Current consumption varies by probe. The following table indicates how many probes can be utilized when using one type of probe per power supply.

Sensor	Consumption current*	Z5021	3269	3272
CT6710	approx. 650 mA	4	2	-
CT6711	approx. 650 mA	4	2	-
CT6700	approx. 250 mA	8	4	2
CT6701	approx. 250 mA	8	4	2
3273-50	approx. 450 mA	8	4	1
3274	approx. 450 mA	8	4	1
3275	approx. 600 mA	8	4	1
3276	approx. 450 mA	8	4	1

\*When measuring the rated current.



## Grid power quality control (PL14)

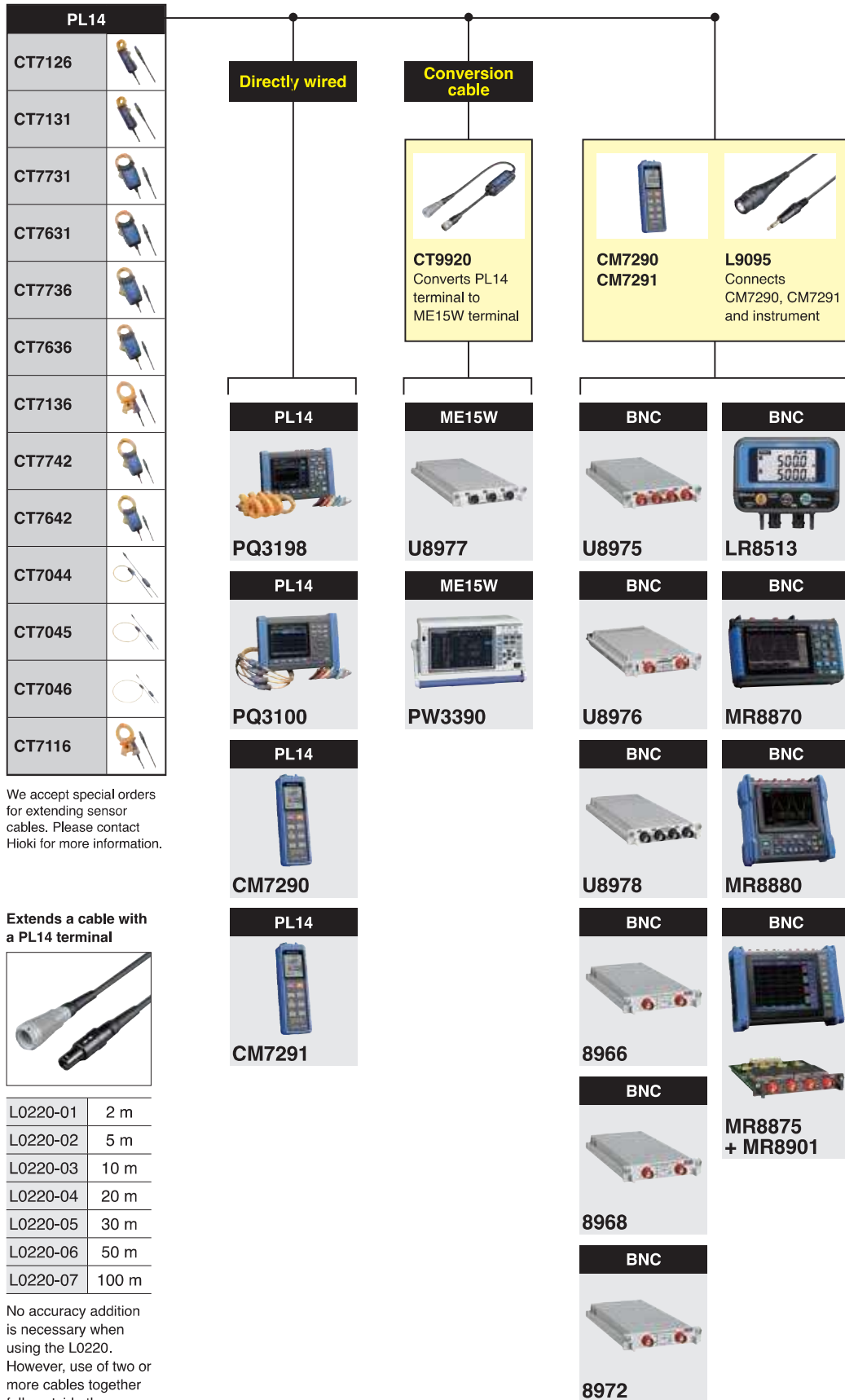

# Grid power quality control (BNC)

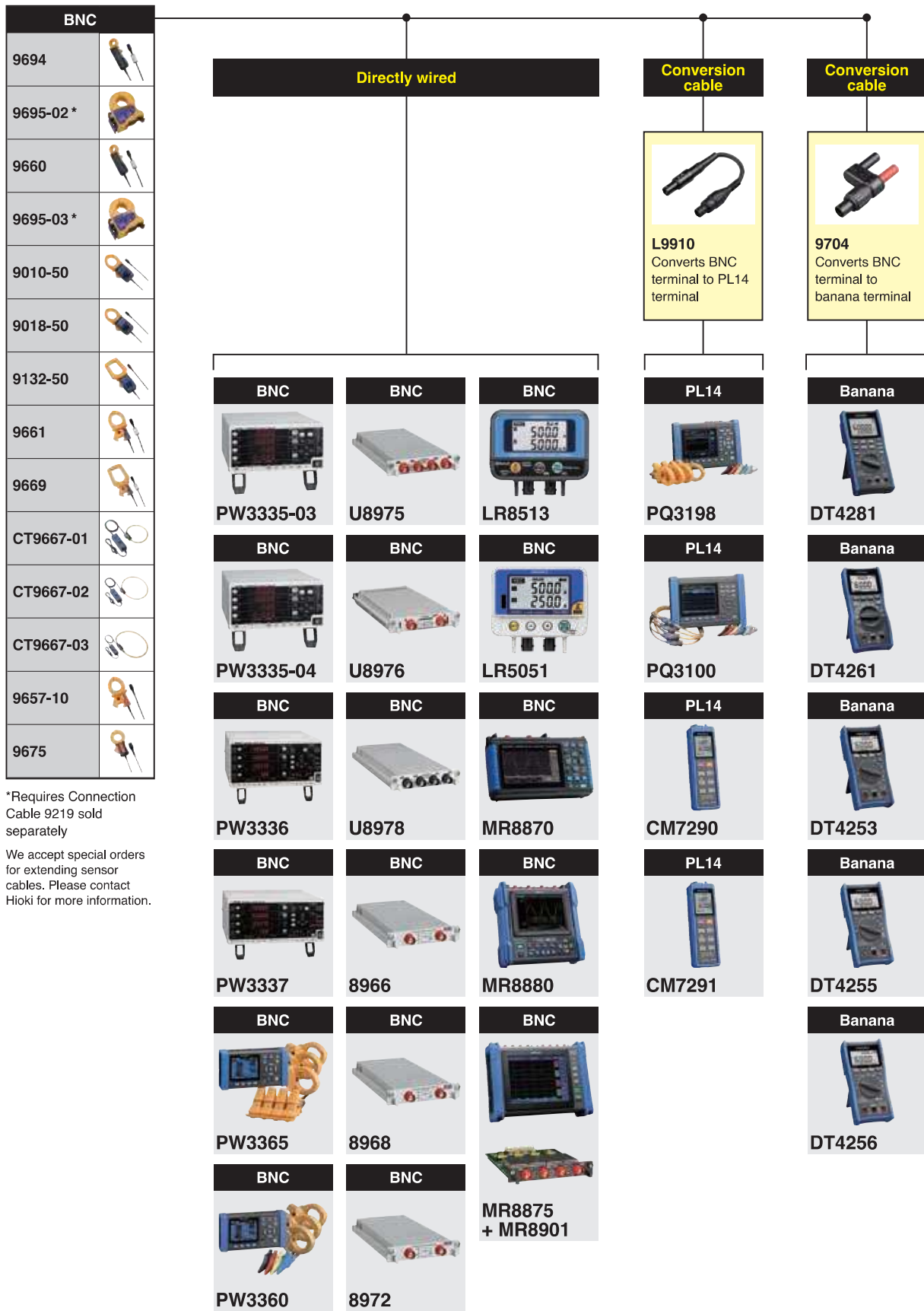

\*Requires Connection Cable 9219 sold separately

We accept special orders for extending sensor cables. Please contact Hioki for more information.

# Accurately evaluating power conversion efficiency

Improving power conversion efficiency is a key part of the effort to facilitate the effective use of energy. Devices that operate at high frequencies are increasingly being used to improve efficiency, and evaluation processes undertaken during the development of such devices requires accurate measurement of power at the low frequencies used by in previous devices as well as at high frequencies. Additionally, sensors that can resist noise are necessary since noise becomes stronger as the frequency increases. Hioki offers current sensors that can measure power accurately while providing robust noise resistance over a broad band of frequencies.

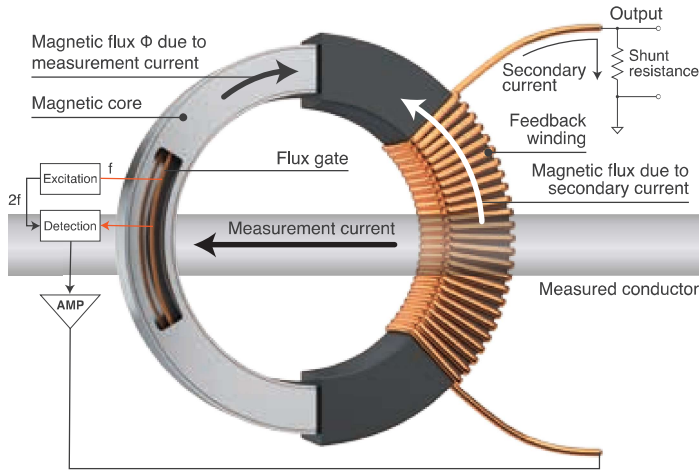

High-frequency currents are detected by a winding (CT), while DC to low-frequency currents are detected by a flux gate.

## Zero-flux method: achieving stable, wideband measurement from DC to high frequencies

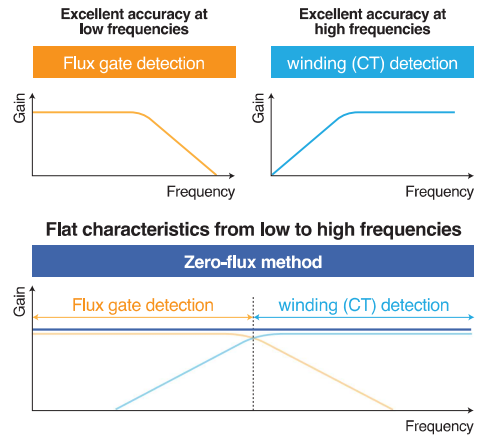

### Zero-flux method (flux gate) current sensors



### Application

## Evaluating the power conversion efficiency of an inverter

When evaluating the power conversion efficiency of an inverter, the inverter's input and output power are measured and its efficiency is checked. PWM (pulse width modulated) inverter output, which has been widely used in recently years, contains a modulated wave (fundamental wave) and a switching frequency along with their respective harmonic components. Since switching frequencies tend to be high, the process requires wide frequency band current sensors.

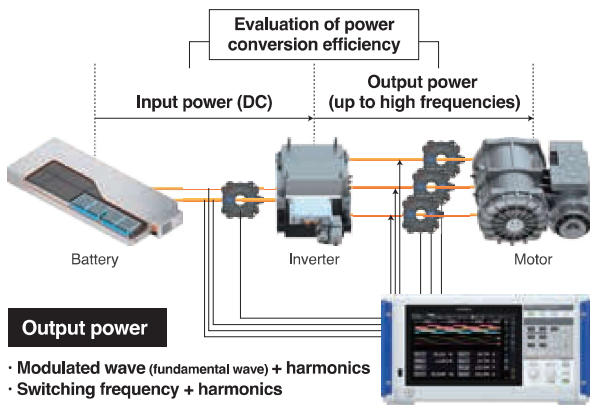

### Inverter output: principal active power components

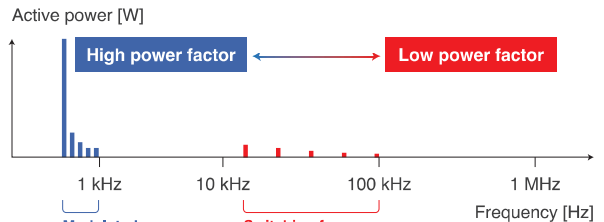

Since the power factor decreases with harmonics, current sensors' phase measurement accuracy becomes key (see right).



**Phase measurement accuracy and correction: accurately measuring power at low power factors**

For typical current sensors, phase measurement accuracy is not defined. However, phase measurement precision is important in applications where power must be measured with a high degree of accuracy. Power can be measured more accurately by selecting a current sensor for which phase measurement accuracy is defined in the measurement band.

At low power factors, phase error has a significant effect on power error.

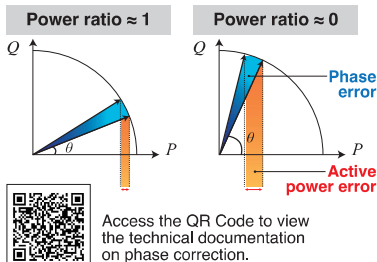

**PW8001: Automatic Phase Correction function**

Automatic acquisition of phase correction values

Power supplied from instrument

Information stored in the current sensors' internal memory	
Phase shift	Rated current
Sensor model	Serial number

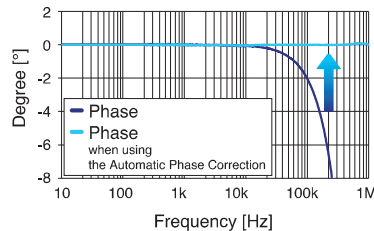

**Example of the Automatic Phase Correction for the CT6904A AC/DC current sensor**

The power factor decreases in the high-frequency range of the switching frequencies and other frequency components. At low power factors, phase error has a significant effect on power measured values.

For typical sensors, phase error increases with frequency. Since Hioki has developed both current sensors and the measuring instruments, current sensors' phase characteristics can be corrected by the instruments, allowing accurate power values to be calculated.

**Common-mode voltage rejection ratio: measuring current values accurately in noisy environments**

In high-frequency measurement, sensors' resistance to noise is critical. A sensor's ability to remove noise is expressed by its common-mode rejection ratio (CMRR). Sensors with a high CMRR reject more noise and therefore can make more accurate measurements.

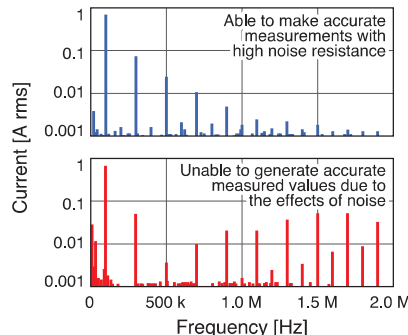
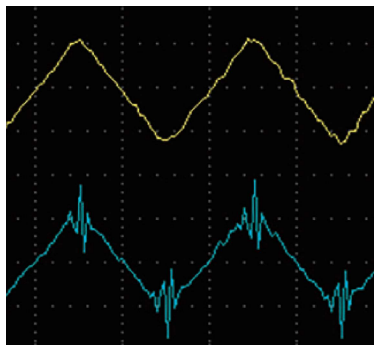
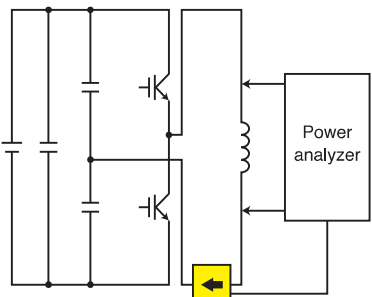

Top: CT6904A CMRR 120 dB or greater (100 Hz); bottom: sensor with a low CMRR

For reactors, higher frequencies mean lower current values. The image to the right shows a waveform obtained by measuring reactor current at high frequency along with variations in current values that accompany variations in the frequency.

**Effects of conductor position: stable, highly reproducible sensing**

In general, speaking, the effects of conductor position increase with frequency. Since the position of the conductor inside the clamp core affects the measurement accuracy, resulting the reproducibility of measurement reduces. Sensors are designed the effects of conductor position, highly reproducible measurements are possible since conductor position does not affect measured values.

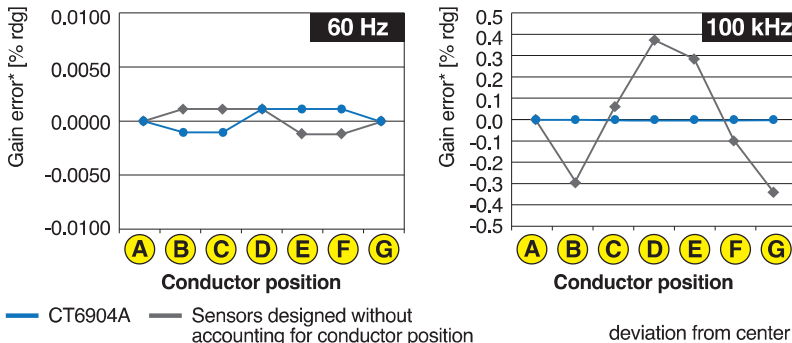

When using a sensor designed with the effects of conductor position, measured values are not affected when the conductor's position changes.

## Clearly observing current waveforms

The magnitude of the currents that flow in power-saving devices during operation and control currents that flow in automotive accessory components have reduced to 1 mA or less. At the same time, reliance on high-speed switching operation for device control is resulting in increased noise. Wideband current probes that are highly resistant to noise are essential in order to clearly observe low-current waveforms without losing them in noise. Hioki offers current probes that enable clear waveform observation while providing robust noise resistance over a broad band of frequencies.

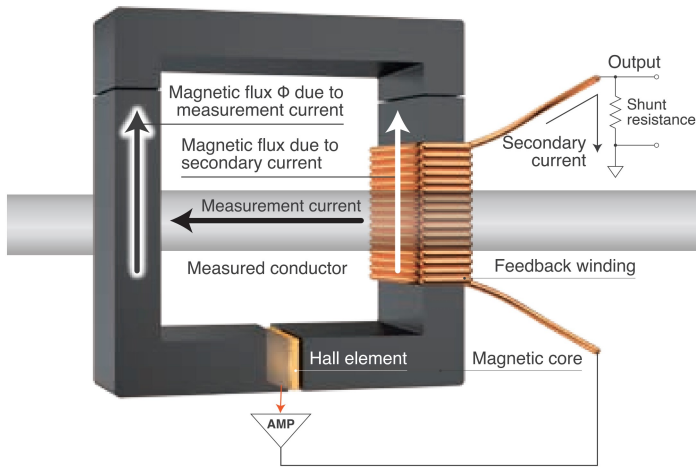

High-frequency currents are detected by the winding (CT), while DC to low-frequency currents are detected by the Hall element.

### Zero-flux method: realizing stable, wideband measurement from DC to high frequencies

Excellent S/N (signal to noise) ratio at low frequencies  
 Excellent S/N (signal to noise) ratio at high frequencies

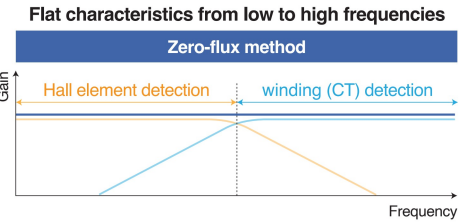
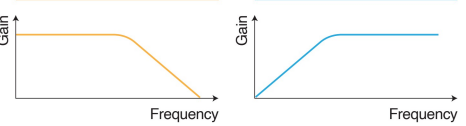

### Zero-flux method (hall element) current probes

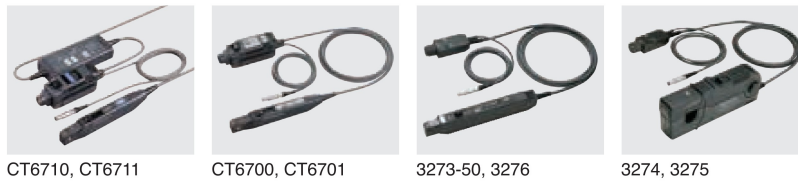

## Application

### Evaluating the response performance of switching devices

Switching devices control equipment by turning the power on and off. The response performance of switching devices is evaluated by observing fluctuations of current and voltage when the device cycles the power on and off. Capturing current fluctuations caused by high-speed switching operation requires current probes with a broad frequency band. Additionally, noise resistance is important since switching operation generates noise.

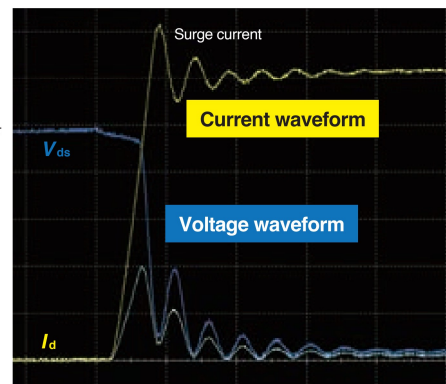
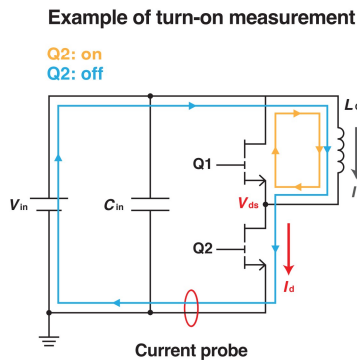
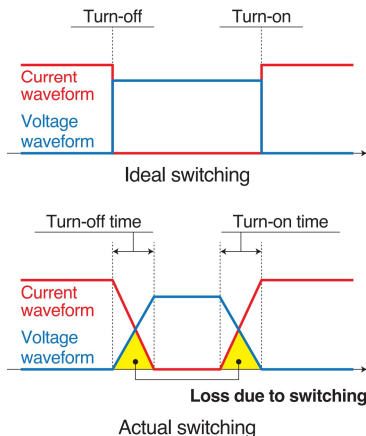

**Observing waveforms from minuscule currents to large currents: evaluating the control design of ECUs and accessory components**

The control systems used in ECUs and accessory components carry currents of a variety of magnitudes according to the vehicle's operation, from control currents to inrush currents. Using a current probe that can switch current ranges makes it possible to observe current waveforms associated with an array of operating conditions with a single probe.

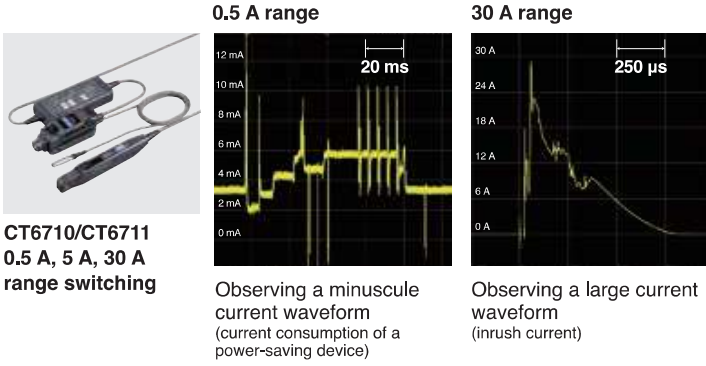

**CT6710/CT6711**  
0.5 A, 5 A, 30 A range switching

Observing a minuscule current waveform (current consumption of a power-saving device)

Observing a large current waveform (inrush current)

Observing currents of a variety of magnitudes, from minuscule currents to large currents, with a single probe

Model	Freq. band	measurement range	output rate
CT6710	DC to 50 MHz	0.5 A	10 V/A
		5 A	1 V/A
		30 A	0.1 V/A
CT6711	DC to 120 MHz	0.5 A	10 V/A
		30 A	0.1 V/A
CT6700	DC to 50 MHz	5 A	1 V/A
CT6701	DC to 120 MHz	5 A	1 V/A
3273-50	DC to 50 MHz	30 A	0.1 V/A
3276	DC to 100 MHz	30 A	0.1 V/A
3274	DC to 10 MHz	150 A	0.01 V/A
3275	DC to 2 MHz	500 A	0.01 V/A

**Clearly observing minuscule currents: operating currents of power-saving devices and control currents flowing to accessory components**

The magnitude of the currents that flow during operation of power-saving devices like wearables and control currents that flow in automotive accessory components tend to decrease in to 1 mA or less. Using a current probe with a high output rate make you possible for clearly observing minuscule current waveforms.

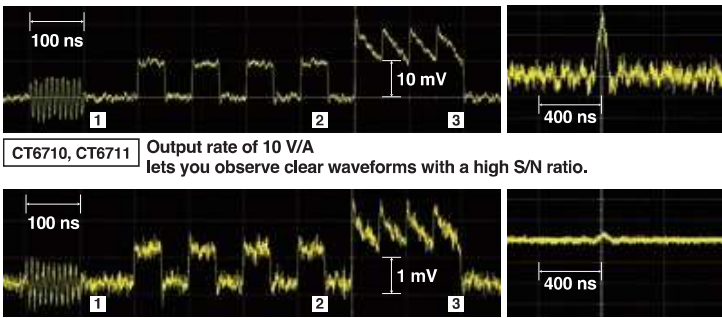

CT6710, CT6711 Output rate of 10 V/A lets you observe clear waveforms with a high S/N ratio.

Earlier model Output rate of 1 V/A precludes observation of accurate waveforms as they are obscured by noise.

- 1) Sine wave: f = 100 MHz, 1 mA peak-peak
- 2) Square wave: f = 10 MHz, 1 mA peak-peak
- 3) Sawtooth wave: f = 20 MHz, 1 mA peak-peak (offset +1 mA)

Noise resistance design: key to increasing output rate

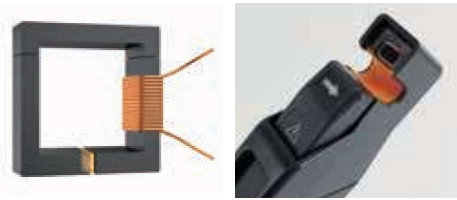

Hioki uses a proprietary thin-film Hall element to reduce the amount of noise generated inside the probe. Electromagnetic shielding in the sensor improves resistance to environmental noise.

**Observing waveforms across a broad band of frequencies: capturing waveforms and pulse waveforms that fluctuate at high speeds**

Currents from switching operation of devices such as SiC and GaN inverters and currents that flow momentarily when a power supply is activated fluctuate at high speeds. Using a current probe with a wide frequency band allows you observe current waveforms that fluctuate at high speed. Additionally, such devices allow you observe current waveforms such as pulse waveforms that contain a variety of frequency components.

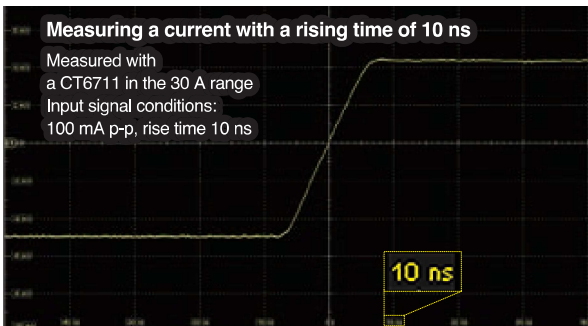

Current probes with a wide frequency band can capture high-speed current fluctuations with a rising time of 10 ns.

**Failure to capture accurate waveforms due to insufficient frequency band**

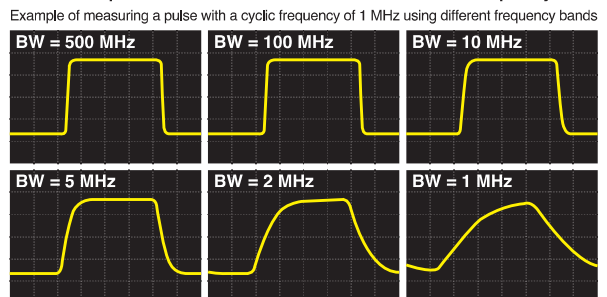

Current probes with a wide frequency band can accurately capture pulse waveforms.

### CT6862-05



Product warranty period: 3 years  
Guaranteed accuracy period: 1 year

<b>Rated current</b>	50 A AC/DC
<b>Frequency band</b>	DC to 1 MHz (-3 dB)
<b>Diameter of measurable conductors</b>	Max. $\phi$ 24 mm (0.94 in.)

#### Accuracy

Frequency	Amplitude $\pm$ (% of reading + % of full scale)	Phase
DC	$\pm 0.05\% \pm 0.01\%$	-
DC < f $\leq$ 16 Hz	$\pm 0.10\% \pm 0.02\%$	$\pm 0.3^\circ$
16 Hz < f $\leq$ 400 Hz	$\pm 0.05\% \pm 0.01\%$	$\pm 0.2^\circ$
400 Hz < f $\leq$ 1 kHz	$\pm 0.2\% \pm 0.02\%$	$\pm 0.5^\circ$
1 kHz < f $\leq$ 5 kHz	$\pm 0.7\% \pm 0.02\%$	$\pm 1.0^\circ$
5 kHz < f $\leq$ 10 kHz	$\pm 1\% \pm 0.02\%$	$\pm 1.0^\circ$
10 kHz < f $\leq$ 50 kHz	$\pm 1\% \pm 0.02\%$	$\pm (0.5 + 0.1 \times f \text{ kHz})^\circ$
50 kHz < f $\leq$ 100 kHz	$\pm 2\% \pm 0.05\%$	$\pm (0.5 + 0.1 \times f \text{ kHz})^\circ$
100 kHz < f $\leq$ 300 kHz	$\pm 5\% \pm 0.05\%$	$\pm (0.5 + 0.1 \times f \text{ kHz})^\circ$
300 kHz < f $\leq$ 700 kHz	$\pm 10\% \pm 0.05\%$	-
700 kHz < f < 1 MHz	$\pm 30\% \pm 0.05\%$	-

The values above are when the input is a sine wave, the measuring instrument has an input resistance of 1 M $\Omega$   $\pm$  10%, the voltage to ground is 0 V, there is no external magnetic field, and the conductor is in the center of the sensor opening, and the measurement instrument's input resistance is 1 M $\Omega$  or higher.  
Amplitude accuracy: defined at the rated value or less, or within the derating curve; DC < f < 5 Hz is the typical value by design.  
Phase accuracy: defined at the rated value or less, or within the derating curve; DC < f < 10 Hz is the typical value by design.

<b>Temperature and humidity range for guaranteed accuracy</b>	0°C to 40°C (32°F to 104°F), 80% RH or less
<b>Effect of temperature</b>	In ranges from -30°C to 0°C (-22°F to 32°F) and 40°C to 85°C (104°F to 185°F) Amplitude sensitivity: $\pm 0.005\%$ rdg./°C or less Offset voltage: $\pm 0.005\%$ f.s./°C or less
<b>Effect of common mode voltage</b>	0.05% f.s. or less (1000 Vrms, DC to 100 Hz)

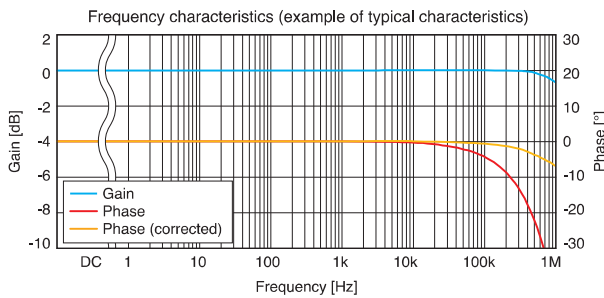
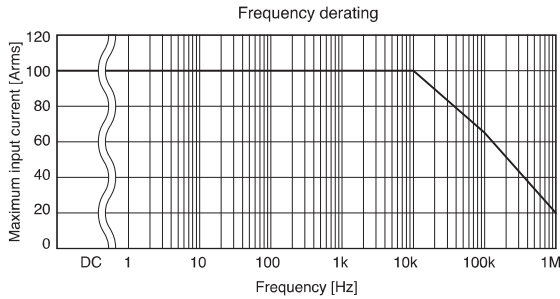

<b>Output voltage</b>	40 mV/A ( $= 2 \text{ V}/50 \text{ A}$ )
<b>Operating temperature and humidity range</b>	-30°C to 85°C (-22°F to 185°F), 80% RH or less (no condensation)
<b>Storage temperature and humidity range</b>	-30°C to 85°C (-22°F to 185°F), 80% RH or less (no condensation)
<b>Maximum rated voltage to ground</b>	1000 V AC/DC (50/60 Hz), measurement category III, anticipated transient overvoltage: 8000 V
<b>Standards</b>	Safety: EN61010, EMC: EN61326
<b>Cable length</b>	3 m (9.84 ft.)
<b>Dimensions</b>	70 mm (2.76 in.) W $\times$ 100 mm (3.94 in.) H $\times$ 53 mm (2.09 in.) D (Excluding protruding parts and cables)
<b>Weight</b>	Approx. 340 g (12.0 oz.)

### CT6872 CT6872-01

**NEW**



Product warranty period: 3 years  
Guaranteed accuracy period: 1 year

<b>Rated current</b>	50 A AC/DC
<b>Frequency band</b>	DC to 10 MHz (-3 dB)
<b>Diameter of measurable conductors</b>	Max. $\phi$ 24 mm (0.94 in.)

#### Accuracy

Frequency	Amplitude $\pm$ (% of reading + % of full scale)	Phase
DC	$\pm 0.03\% \pm 0.002\%$	-
DC < f $\leq$ 16 Hz	$\pm 0.1\% \pm 0.01\%$	$\pm 0.1^\circ$
16 Hz < f $\leq$ 45 Hz	$\pm 0.05\% \pm 0.01\%$	$\pm 0.08^\circ$
45 Hz < f $\leq$ 66 Hz	$\pm 0.03\% \pm 0.007\%$	$\pm 0.05^\circ$
66 Hz < f $\leq$ 100 Hz	$\pm 0.04\% \pm 0.01\%$	$\pm 0.1^\circ$
100 Hz < f $\leq$ 500 Hz	$\pm 0.06\% \pm 0.01\%$	$\pm 0.15^\circ$
500 Hz < f $\leq$ 1 kHz	$\pm 0.1\% \pm 0.01\%$	$\pm 0.4^\circ$
1 kHz < f $\leq$ 5 kHz	$\pm 0.15\% \pm 0.02\%$	$\pm 0.4^\circ$
5 kHz < f $\leq$ 10 kHz	$\pm 0.15\% \pm 0.02\%$	$\pm 0.5^\circ$
10 kHz < f $\leq$ 1 MHz	$(0.012 \times f \text{ kHz})\% + 0.05\%$	$\pm (0.04 \times f \text{ kHz})^\circ \pm 0.1^\circ$

The values above are when the input is a sine wave, the measuring instrument has an input resistance of 1 M $\Omega$   $\pm$  10%, the voltage to ground is 0 V, there is no external magnetic field, and the conductor is in the center of the sensor opening.  
Amplitude accuracy: defined 110% f.s. or less, or within the derating curve; DC < f < 10 Hz is the value by design.  
Phase accuracy: defined 110% f.s. or less, or within the derating curve; DC < f < 10 Hz is the value by design.  
Add  $\pm 0.01\%$  rdg. to the amplitude accuracy for input from 100% f.s. to 110% f.s.  
The CT6872-01 adds a phase accuracy of  $\pm (0.015 \times f)^\circ$  at a frequency of 1 kHz < f  $\leq$  1 MHz.

<b>Temperature and humidity range for guaranteed accuracy</b>	23°C $\pm$ 5°C (73.4°F $\pm$ 41°F), 80% RH or less
<b>Effect of temperature</b>	In ranges from -40°C to 18°C (-40°F to 64.4°F) and 28°C to 85°C (82.4°F to 185°F) Amplitude sensitivity: $\pm 20$ ppm of rdg./°C Offset voltage: $\pm 0.2$ ppm of f.s./°C
<b>Common-Mode Rejection Ratio (CMRR)</b>	(effect on output voltage and common mode voltage) 150 dB or greater (DC to 1 kHz) 140 dB or greater (1 kHz to 10 kHz) 120 dB or greater (10 kHz to 100 kHz) 100 dB or greater (100 kHz to 1 MHz)
<b>Linearity error</b>	$\pm 2$ ppm
<b>Offset error</b>	$\pm 5$ ppm
<b>Amplitude errors</b>	DC: 7 ppm 10 Hz to 100 Hz: 0.005% 100 Hz to 1 kHz: 0.01% 1 kHz to 50 kHz: 0.1% 50 kHz to 100 kHz: 0.3% 100 kHz to 300 kHz: 1% 300 kHz to 1 MHz: 3%

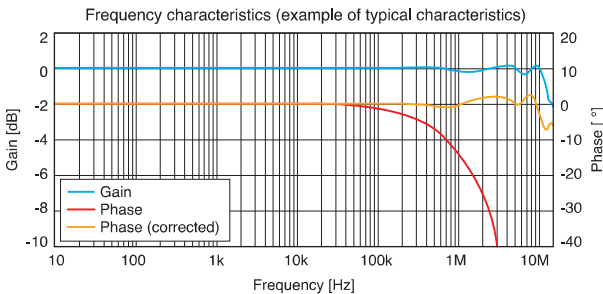
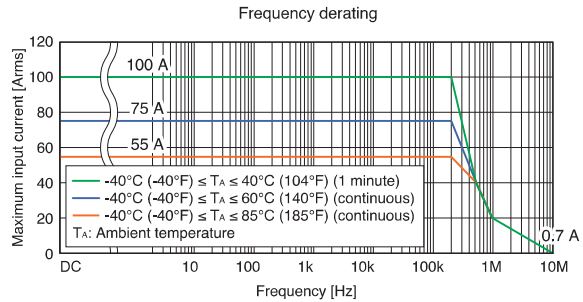

<b>Output voltage</b>	40 mV/A ( $= 2 \text{ V}/50 \text{ A}$ )
<b>Operating temperature and humidity range</b>	-40°C to 85°C (-40°F to 185°F), 80% RH or less (no condensation)
<b>Storage temperature and humidity range</b>	-40°C to 85°C (-40°F to 185°F), 80% RH or less (no condensation)
<b>Maximum rated voltage to ground</b>	1000 V CAT III Anticipated transient overvoltage: 8000 V
<b>Standards</b>	Safety: EN61010, EMC: EN61326
<b>Cable length</b>	CT6872: 3 m (9.84 ft.) CT6872-01: 10 m (32.81 ft.)
<b>Dimensions</b>	70 mm (2.76 in.) W $\times$ 110 mm (4.33 in.) H $\times$ 53 mm (2.09 in.) D (excluding protruding parts and cables)
<b>Weight</b>	CT6872: approx. 370 g (13.1 oz.) CT6872-01: approx. 690 g (24.3 oz.)



# CT6863-05



Product warranty period: 3 years  
Guaranteed accuracy period: 1 year

<b>Rated current</b>	200 A AC/DC
<b>Frequency band</b>	DC to 500 kHz (-3 dB)
<b>Diameter of measurable conductors</b>	Max. φ 24 mm (0.94 in.)

## Accuracy

Frequency	Amplitude ±(% of reading + % of full scale)	Phase
DC	±0.05% ±0.01%	-
DC < f ≤ 16 Hz	±0.10% ±0.02%	±0.3°
16 Hz < f ≤ 400 Hz	±0.05% ±0.01%	±0.2°
400 Hz < f ≤ 1 kHz	±0.2% ±0.02%	±0.5°
1 kHz < f ≤ 5 kHz	±0.7% ±0.02%	±1.0°
5 kHz < f ≤ 10 kHz	±1% ±0.02%	±1.0°
10 kHz < f ≤ 50 kHz	±2% ±0.02%	± (0.5 + 0.1 × f kHz)°
50 kHz < f ≤ 100 kHz	±5% ±0.05%	± (0.5 + 0.1 × f kHz)°
100 kHz < f ≤ 300 kHz	±10% ±0.05%	± (0.5 + 0.1 × f kHz)°
300 kHz < f ≤ 500 kHz	±30% ±0.05%	-

The values above are when the input is a sine wave, the conductor is in the center of the sensor opening, and the measurement instrument's input resistance is 1 MΩ or higher. Amplitude accuracy: defined at the rated value or less, or within the derating curve; DC < f < 5 Hz is the typical value by design. Phase accuracy: defined at the rated value or less, or within the derating curve; DC < f < 10 Hz is the typical value by design.

<b>Temperature and humidity range for guaranteed accuracy</b>	0°C to 40°C (32°F to 104°F), 80% RH or less
<b>Effect of temperature</b>	In ranges from -30°C to 0°C (-22°F to 32°F) and 40°C to 85°C (104°F to 185°F) Amplitude sensitivity: ±0.005% rdg./°C or less Offset voltage: ±0.005% f.s./°C or less
<b>Effect of common mode voltage</b>	0.05% f.s. or less (1000 Vrms, DC to 100 Hz)

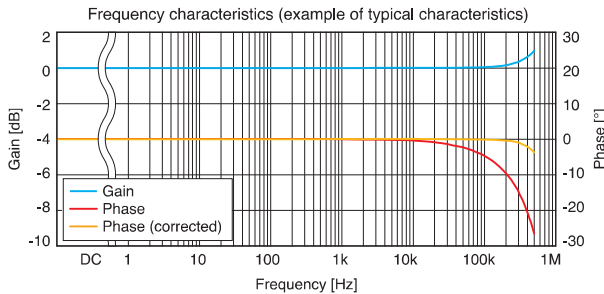
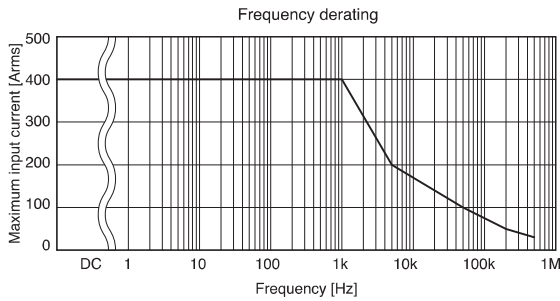

<b>Output voltage</b>	10 mV/A (= 2 V / 200 A)
<b>Operating temperature and humidity range</b>	-30°C to 85°C (-22°F to 185°F), 80% RH or less (no condensation)
<b>Storage temperature and humidity range</b>	-30°C to 85°C (-22°F to 185°F), 80% RH or less (no condensation)
<b>Maximum rated voltage to ground</b>	1000 V AC/DC (50/60 Hz), measurement category III, anticipated transient overvoltage: 8000 V
<b>Standards</b>	Safety: EN61010, EMC: EN61326
<b>Cable length</b>	3 m (9.84 ft.)
<b>Dimensions</b>	70 mm (2.76 in.) W × 100 mm (3.94 in.) H × 53 mm (2.09 in.) D (excluding protruding parts and cables)
<b>Weight</b>	Approx. 340 g (12.0 oz.)

# CT6873 CT6873-01

**NEW**



Product warranty period: 3 years  
Guaranteed accuracy period: 1 year

<b>Rated current</b>	200 A AC/DC
<b>Frequency band</b>	DC to 10 MHz (-3 dB)
<b>Diameter of measurable conductors</b>	Max. φ 24 mm (0.94 in.)

## Accuracy

Frequency	Amplitude ±(% of reading + % of full scale)	Phase
DC	±0.03% ±0.002%	-
DC < f ≤ 16 Hz	±0.1% ±0.01%	±0.1°
16 Hz < f ≤ 45 Hz	±0.05% ±0.01%	±0.08°
45 Hz < f ≤ 66 Hz	±0.03% ±0.007%	±0.05°
66 Hz < f ≤ 100 Hz	±0.04% ±0.01%	±0.1°
100 Hz < f ≤ 500 Hz	±0.05% ±0.01%	±0.15°
500 Hz < f ≤ 3 kHz	±0.1% ±0.01%	±0.4°
3 kHz < f ≤ 5 kHz	±0.2% ±0.02%	±0.4°
5 kHz < f ≤ 10 kHz	±0.2% ±0.02%	±0.5°
10 kHz < f ≤ 1 MHz	(0.018 × f kHz)% ± 0.05%	±(0.04 × f kHz)° ± 0.1°

The values above are when the input is a sine wave, the measuring instrument has an input resistance of 1 MΩ ±10%, the voltage to ground is 0 V, there is no external magnetic field, and the conductor is in the center of the sensor opening. Amplitude accuracy: defined 110% f.s. or less, or within the derating curve; DC < f < 10 Hz is the value by design. Phase accuracy: defined 110% f.s. or less, or within the derating curve; DC < f < 10 Hz is the value by design. Add ±0.01% rdg. to the amplitude accuracy for input from 100% f.s. to 110% f.s. The CT6873-01 adds a phase accuracy of ±(0.015 × f)° at a frequency of 1 kHz < f ≤ 1 MHz.

<b>Temperature and humidity range for guaranteed accuracy</b>	23°C ±5°C (73.4°F ±41°F), 80% RH or less
<b>Effect of temperature</b>	In ranges from -40°C to 18°C (-40°F to 64.4°F) and 28°C to 85°C (82.4°F to 185°F) Amplitude sensitivity: ±15 ppm of rdg./°C Offset voltage: ±0.1 ppm of f.s./°C
<b>Common-Mode Rejection Ratio (CMRR)</b>	(effect on output voltage and common mode voltage) 150 dB or greater (DC to 1 kHz) 140 dB or greater (1 kHz to 10 kHz) 120 dB or greater (10 kHz to 100 kHz) 100 dB or greater (100 kHz to 1 MHz)
<b>Linearity errors</b>	±2 ppm
<b>Offset error</b>	±5 ppm
<b>Amplitude error</b>	DC: ±7 ppm 10 Hz to 500 Hz: ±0.005% 500 Hz to 3 kHz: ±0.01% 3 kHz to 30 kHz: ±0.1% 30 kHz to 100 kHz: ±0.4% 100 kHz to 400 kHz: ±1% 400 kHz to 1 MHz: ±3%

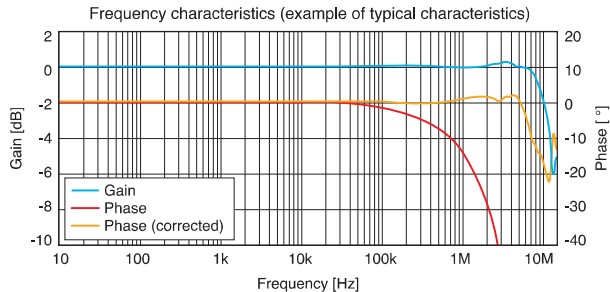
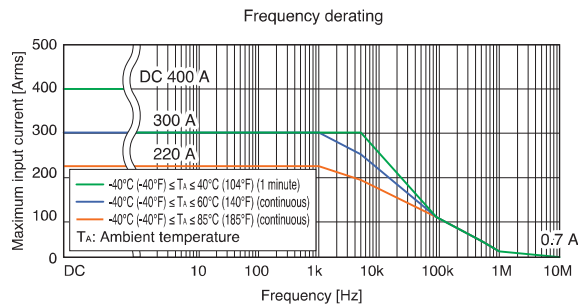

<b>Output voltage</b>	10 mV/A (= 2 V / 200 A)
<b>Operating temperature and humidity range</b>	-40°C to 85°C (-40°F to 185°F), 80% RH or less (no condensation)
<b>Storage temperature and humidity range</b>	-40°C to 85°C (-40°F to 185°F), 80% RH or less (no condensation)
<b>Maximum rated voltage to ground</b>	1000 V CAT III Anticipated transient overvoltage: 8000 V
<b>Standards</b>	Safety: EN61010, EMC: EN61326
<b>Cable length</b>	CT6873: 3 m (9.84 ft.) CT6873-01: 10 m (32.81 ft.)
<b>Dimensions</b>	70 mm (2.76 in.) W × 110 mm (4.33 in.) H × 53 mm (2.09 in.) D (excluding protruding parts and cables)
<b>Weight</b>	CT6873: approx. 370 g (13.1 oz.) CT6873-01: approx. 690 g (24.3 oz.)



# CT6875A CT6875A-1



Product warranty period: 3 years  
Guaranteed accuracy period: 1 year

<b>Rated current</b>	500 A AC/DC
<b>Frequency band</b>	CT6875A: DC to 2 MHz (±3 dB) CT6875A-1: DC to 1.5 MHz (±3 dB)
<b>Diameter of measurable conductors</b>	Max. φ 36 mm (1.41 in.)

### Accuracy

Frequency	Amplitude ±(% of reading + % of full scale)	Phase
DC	±0.04% ±0.008%	-
DC < f < 16 Hz	±0.1% ±0.02%	±0.1°
16 Hz ≤ f < 45 Hz	±0.05% ±0.01%	±0.1°
45 Hz ≤ f ≤ 66 Hz	±0.04% ±0.008%	±0.08°
66 Hz < f ≤ 100 Hz	±0.05% ±0.01%	±0.1°
100 Hz < f ≤ 500 Hz	±0.1% ±0.02%	±0.2°
500 Hz < f ≤ 1 kHz	±0.2% ±0.02%	±0.4°
1 kHz < f ≤ 5 kHz	±0.4% ±0.02%	±0.5°
5 kHz < f ≤ 10 kHz	±0.4% ±0.02%	±(0.1 × f kHz)°
10 kHz < f ≤ 50 kHz	±1.5% ±0.05%	±(0.1 × f kHz)°
50 kHz < f ≤ 100 kHz	±2.5% ±0.05%	±(0.1 × f kHz)°
100 kHz < f ≤ 1 MHz	±(0.025 × f kHz)% ±0.05%	±(0.1 × f kHz)°

Amplitude accuracy: defined 110% f.s. or less, or within the derating curve;  
DC < f < 10 Hz is the value by design.  
Add ±0.01% rdg. to the amplitude accuracy for input from 100% f.s. to 110% f.s.  
For the CT6875A-1, add the following for frequencies of  
1 kHz < f ≤ 1 MHz (the frequency band is 1.5 MHz ±3 dB):  
Amplitude accuracy: ±(0.005 × f kHz)% rdg., Phase accuracy: ±(0.015 × f kHz)°

<b>Temperature and humidity range for guaranteed accuracy</b>	0°C to 40°C (32°F to 104°F), 80% RH or less
<b>Effect of temperature</b>	In ranges from -40°C to 0°C (-40°F to 32°F) and 40°C to 85°C (104°F to 185°F) Amplitude sensitivity: ±20 ppm of reading / °C Offset voltage: ±1 ppm of full scale / °C
<b>Common-Mode Rejection Ratio (CMRR)</b>	(effect on output voltage and common mode voltage) 140 dB or greater (50/60 Hz) 120 dB or greater (100 kHz)
<b>Linearity error</b>	±5 ppm
<b>Offset error</b>	±5 ppm
<b>Amplitude error</b>	DC: ±10 ppm 10 Hz to 100 Hz: ±0.005% 100 Hz to 1 kHz: ±0.02% 1 kHz to 20 kHz: ±0.08% 20 kHz to 100 kHz: ±0.5% 100 kHz to 300 kHz: ±1% 300 kHz to 1 MHz: ±5%

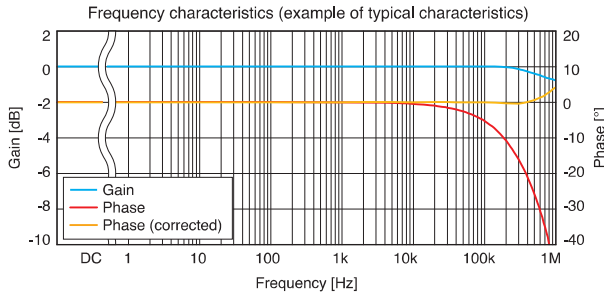
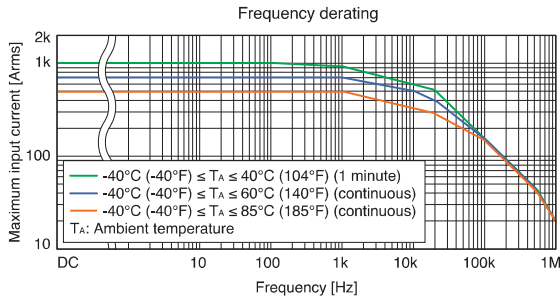

<b>Output voltage</b>	4 mV/A (= 2 V / 500 A)
<b>Operating temperature and humidity range</b>	-40°C to 85°C (-40°F to 185°F), 80% RH or less (no condensation)
<b>Storage temperature and humidity range</b>	-40°C to 85°C (-40°F to 185°F), 80% RH or less (no condensation)
<b>Maximum rated voltage to ground</b>	1000 V CAT III Anticipated transient overvoltage: 8000 V
<b>Standards</b>	Safety: EN61010, EMC: EN61326
<b>Cable length</b>	CT6875A: 3 m (9.84 ft.) CT6875A-1: 10 m (32.81 ft.)
<b>Dimensions</b>	160 mm (6.30 in.) W × 112 mm (4.41 in.) H × 50 mm (1.97 in.) D (excluding protruding parts and cables)
<b>Weight</b>	CT6875A: approx. 0.8 kg (28.2 oz.) CT6875A-1: approx. 1.1 kg (38.8 oz.)

# CT6904A CT6904A-1



(CT6904A-1: built-to-order product)  
Product warranty period: 3 years  
Guaranteed accuracy period: 1 year

<b>Rated current</b>	500 A AC/DC
<b>Frequency band</b>	CT6904A: DC to 4 MHz (±3 dB) CT6904A-1: DC to 2 MHz (±3 dB)
<b>Diameter of measurable conductors</b>	Max. φ 32 mm (1.25 in.)

### Accuracy

Frequency	Amplitude ±(% of reading + % of full scale)	Phase
DC	±0.025% ±0.007%	-
DC < f < 16 Hz	±0.2% ±0.02%	±0.1°
16 Hz ≤ f < 45 Hz	±0.1% ±0.02%	±0.1°
45 Hz ≤ f ≤ 65 Hz	±0.02% ±0.007%	±0.08°
65 Hz < f ≤ 850 Hz	±0.05% ±0.007%	±0.12°
850 Hz < f ≤ 1 kHz	±0.1% ±0.01%	±0.4°
1 kHz < f ≤ 5 kHz	±0.4% ±0.02%	±0.4°
5 kHz < f ≤ 10 kHz	±0.4% ±0.02%	±(0.08 × f kHz)°
10 kHz < f ≤ 50 kHz	±1% ±0.02%	±(0.08 × f kHz)°
50 kHz < f ≤ 100 kHz	±1% ±0.05%	±(0.08 × f kHz)°
100 kHz < f ≤ 300 kHz	±2% ±0.05%	±(0.08 × f kHz)°
300 kHz < f ≤ 1 MHz	±5% ±0.05%	±(0.08 × f kHz)°

Amplitude accuracy and phase accuracy: defined 110% f.s. or less, or within the derating curve (continuous input at an ambient temperature of 50°C); DC < f < 10 Hz is the value by design.  
Add ±0.01% rdg. to the amplitude accuracy for input from 100% f.s. to 110% f.s.  
For the CT6904A-1, add the following for frequencies of  
50 kHz < f ≤ 1 MHz (the frequency band is 2 MHz ±3 dB):  
Amplitude accuracy: ±(0.015 × f)° rdg.

<b>Temperature and humidity range for guaranteed accuracy</b>	23°C ±5°C (73°F ±9°F), 80% RH or less
<b>Effect of temperature</b>	In ranges from -10°C to 18°C (14°F to 64.4°F) or 28°C to 50°C (82.4°F to 122°F) Amplitude sensitivity: ±20 ppm of reading / °C Offset voltage: ±1 ppm of full scale / °C Phase: ±0.01°/°C
<b>Common-Mode Rejection Ratio (CMRR)</b>	(effect on output voltage and common mode voltage) 140 dB or greater (50/60 Hz) 120 dB or greater (100 kHz)
<b>Linearity error</b>	±5 ppm
<b>Offset error</b>	±10 ppm

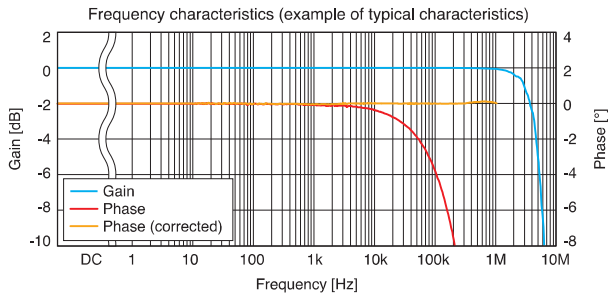
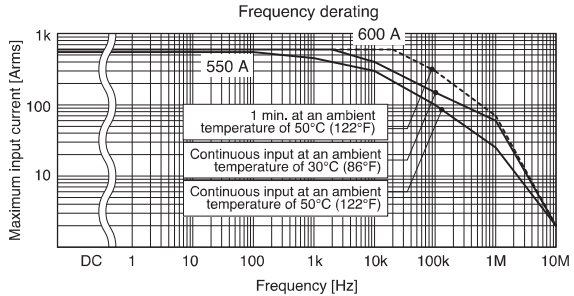

<b>Output voltage</b>	4 mV/A (= 2 V / 500 A)
<b>Operating temperature and humidity range</b>	-10°C to 50°C (-14°F to 122°F), 80% RH or less (no condensation)
<b>Storage temperature and humidity range</b>	-20°C to 60°C (-4°F to 140°F), 80% RH or less (no condensation)
<b>Maximum rated voltage to ground</b>	1000 V CAT III Anticipated transient overvoltage: 8000 V
<b>Standards</b>	Safety: EN61010, EMC: EN61326
<b>Cable length</b>	CT6904A: 3 m (9.84 ft.) (including relay box) CT6904A-1: 10 m (32.81 ft.) (including relay box)
<b>Dimensions</b>	139 mm (5.47 in.) W × 120 mm (4.72 in.) H × 52 mm (2.05 in.) D (excluding protrusions and cables)
<b>Weight</b>	CT6904A: approx. 1.05 kg (37.0 oz.) CT6904A-1: approx. 1.35 kg (47.6 oz.)

# CT6904A-2 CT6904A-3

(Build-to-order product)

Product warranty period: 3 years  
Guaranteed accuracy period: 1 year



<b>Rated current</b>	800 A AC/DC
<b>Frequency band</b>	CT6904A-2: DC to 4 MHz (±3 dB) CT6904A-3: DC to 2 MHz (±3 dB)
<b>Diameter of measurable conductors</b>	Max. φ 32 mm (1.25 in.)

## Accuracy

Frequency	Amplitude ±(% of reading + % of full scale)	Phase
DC	±0.030% ±0.009%	-
DC < f < 16 Hz	±0.2% ±0.025%	±0.1°
16 Hz ≤ f < 45 Hz	±0.1% ±0.025%	±0.1°
45 Hz ≤ f ≤ 65 Hz	±0.025% ±0.009%	±0.08°
65 Hz < f ≤ 850 Hz	±0.05% ±0.009%	±0.12°
850 Hz < f ≤ 1 kHz	±0.1% ±0.013%	±0.4°
1 kHz < f ≤ 5 kHz	±0.4% ±0.025%	±0.4°
5 kHz < f ≤ 10 kHz	±0.4% ±0.025%	±(0.08 × f kHz)°
10 kHz < f ≤ 50 kHz	±1% ±0.025%	±(0.08 × f kHz)°
50 kHz < f ≤ 100 kHz	±1% ±0.063%	±(0.08 × f kHz)°
100 kHz < f ≤ 300 kHz	±2% ±0.063%	±(0.08 × f kHz)°
300 kHz < f ≤ 1 MHz	±5% ±0.063%	±(0.08 × f kHz)°

Amplitude accuracy and phase accuracy are specified by the following conditions:  
 · Rated value or less  
 · At 100Hz or more and within the range of "Continuous input at an ambient temperature of 50°C (122°F)" described in the frequency derating graph below  
 · For the CT6904A-3, add the following for frequencies of 50 kHz < f ≤ 1 MHz (frequency band is 2 MHz ±3):  
 Amplitude accuracy: ±(0.015 × f) % rdg.

<b>Temperature and humidity range for guaranteed accuracy</b>	23°C ±5°C (73°F ±9°F), 80% RH or less
<b>Effect of temperature</b>	In ranges from -10°C to 18°C (14°F to 64.4°F) or 28°C to 50°C (82.4°F to 122°F) Amplitude sensitivity: ± 50 ppm of reading / °C Offset voltage: ±5 ppm of full scale / °C Phase: ±0.01° / °C
<b>Common-Mode Rejection Ratio (CMRR)</b>	(effect on output voltage and common mode voltage) 140 dB or greater (50/60 Hz) 120 dB or greater (100 kHz)
<b>Linearity error</b>	±12.5 ppm
<b>Offset error</b>	±10 ppm

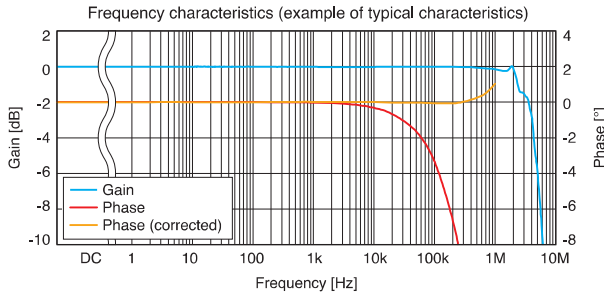
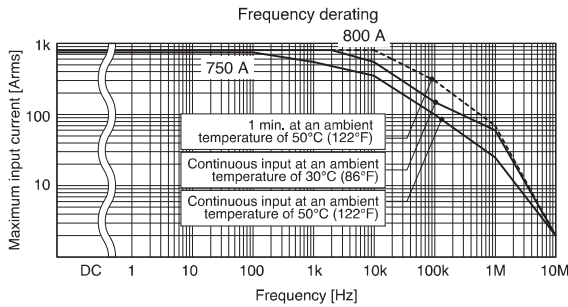

<b>Output voltage</b>	2 mV/A (= 2 V / 1000 A)
<b>Operating temperature and humidity range</b>	-10°C to 50°C (-14°F to 122°F), 80% RH or less (no condensation)
<b>Storage temperature and humidity range</b>	-20°C to 60°C (-4°F to 140°F), 80% RH or less (no condensation)
<b>Maximum rated voltage to ground</b>	1000 V CAT III Anticipated transient overvoltage: 8000 V
<b>Standards</b>	Safety: EN61010, EMC: EN61326
<b>Cable length</b>	CT6904A-2: 3 m (9.84 ft.) (including relay box) CT6904A-3: 10 m (32.81 ft.) (including relay box)
<b>Dimensions</b>	139 mm (5.47 in.) W × 120 mm (4.72 in.) H × 52 mm (2.05 in.) D (excluding protrusions and cables)
<b>Weight</b>	CT6904A-2: approx. 1.15 kg (40.6 oz.) CT6904A-3: approx. 1.45 kg (51.1 oz.)

# CT6876A CT6876A-1

Product warranty period: 3 years  
Guaranteed accuracy period: 1 year



<b>Rated current</b>	1000 A AC/DC
<b>Frequency band</b>	CT6876A: DC to 1.5 MHz (±3 dB) CT6876A-1: DC to 1.2 MHz (±3 dB)
<b>Diameter of measurable conductors</b>	Max. φ 36 mm (1.41 in.)

## Accuracy

Frequency	Amplitude ±(% of reading + % of full scale)	Phase
DC	±0.04% ±0.008%	-
DC < f < 16 Hz	±0.1% ±0.02%	±0.1°
16 Hz ≤ f < 45 Hz	±0.05% ±0.01%	±0.1°
45 Hz ≤ f ≤ 66 Hz	±0.04% ±0.008%	±0.08°
66 Hz < f ≤ 100 Hz	±0.05% ±0.01%	±0.1°
100 Hz < f ≤ 500 Hz	±0.1% ±0.02%	±0.2°
500 Hz < f ≤ 1 kHz	±0.2% ±0.02%	±0.4°
1 kHz < f ≤ 5 kHz	±0.5% ±0.02%	±0.5°
5 kHz < f ≤ 10 kHz	±0.5% ±0.02%	±(0.1 × f kHz)°
10 kHz < f ≤ 50 kHz	±2% ±0.05%	±(0.1 × f kHz)°
50 kHz < f ≤ 100 kHz	±3% ±0.05%	±(0.1 × f kHz)°
100 kHz < f ≤ 1 MHz	±(0.03 × f kHz)% ±0.05%	±(0.1 × f kHz)°

· Amplitude accuracy and phase accuracy: defined 110% f.s. or less or within the derating curve;  
 DC < f < 10 Hz is the value by design  
 · Add ±0.01% rdg. to the amplitude accuracy for input from 100% f.s. to 110% f.s.  
 · For the CT6876A-1, add the following for frequencies of 1 kHz < f ≤ 1 MHz (the frequency band is 1.2 MHz ±3 dB):  
 Amplitude accuracy: ±(0.005 × f kHz)% rdg., Phase accuracy: ±(0.015 × f kHz)°

<b>Temperature and humidity range for guaranteed accuracy</b>	0°C to 40°C (32°F to 104°F), 80% RH or less
<b>Effect of temperature</b>	In ranges from -40°C to 0°C (-40°F to 32°F) and 40°C to 85°C (104°F to 185°F) Amplitude sensitivity: ±20 ppm of reading / °C Offset voltage: ±1 ppm of full scale / °C
<b>Common-Mode Rejection Ratio (CMRR)</b>	(effect on output voltage and common mode voltage) 140 dB or greater (50/60 Hz) 120 dB or greater (100 kHz)
<b>Linearity error</b>	±5 ppm
<b>Offset error</b>	±5 ppm
<b>Amplitude error</b>	DC: ±10 ppm 10 kHz to 100 kHz: ±1% 10 Hz to 100 Hz: ±0.005% 100 kHz to 300 kHz: ±3% 100 Hz to 1 kHz: ±0.03% 300 kHz to 1 MHz: ±15% 1 kHz to 10 kHz: ±0.2%

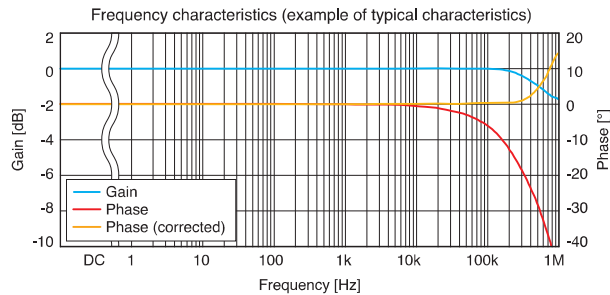
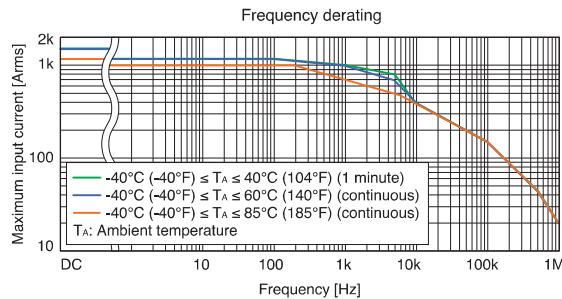

<b>Output voltage</b>	2 mV/A (= 2 V / 1000 A)
<b>Operating temperature and humidity range</b>	-40°C to 85°C (-40°F to 185°F), 80% RH or less (no condensation)
<b>Storage temperature and humidity range</b>	-40°C to 85°C (-40°F to 185°F), 80% RH or less (no condensation)
<b>Maximum rated voltage to ground</b>	1000 V CAT III Anticipated transient overvoltage: 8000 V
<b>Standards</b>	Safety: EN61010, EMC: EN61326
<b>Cable length</b>	CT6876A: 3 m (9.84 ft.) CT6876A-1: 10 m (32.81 ft.)
<b>Dimensions</b>	160 mm (6.30 in.) W × 112 mm (4.41 in.) H × 50 mm (1.97 in.) D (excluding protruding parts and cables)
<b>Weight</b>	CT6876A: approx. 0.95 kg (33.5 oz.) CT6876A-1: approx. 1.25 kg (44.1 oz.)

# CT6877A CT6877A-1



Product warranty period: 3 years  
Guaranteed accuracy period: 1 year

<b>Rated current</b>	2000 AAC/DC
<b>Frequency band</b>	DC to 1 MHz
<b>Diameter of measurable conductors</b>	Max. $\phi$ 80 mm (3.14 in.)

### Accuracy

Frequency	Amplitude $\pm$ (% of reading + % of full scale)	Phase
DC	$\pm 0.04\% \pm 0.008\%$	-
DC < f < 16 Hz	$\pm 0.1\% \pm 0.02\%$	$\pm 0.1^\circ$
16 Hz $\leq$ f < 45 Hz	$\pm 0.05\% \pm 0.01\%$	$\pm 0.1^\circ$
45 Hz $\leq$ f $\leq$ 66 Hz	$\pm 0.04\% \pm 0.008\%$	$\pm 0.08^\circ$
66 Hz < f $\leq$ 100 Hz	$\pm 0.05\% \pm 0.01\%$	$\pm 0.1^\circ$
100 Hz < f $\leq$ 500 Hz	$\pm 0.1\% \pm 0.02\%$	$\pm 0.2^\circ$
500 Hz < f $\leq$ 1 kHz	$\pm 0.2\% \pm 0.02\%$	$\pm 0.4^\circ$
1 kHz < f $\leq$ 5 kHz	$\pm 0.5\% \pm 0.02\%$	$\pm (0.3 + 0.1 \times f \text{ kHz})^\circ$
5 kHz < f $\leq$ 10 kHz	$\pm 0.5\% \pm 0.02\%$	$\pm (0.3 + 0.1 \times f \text{ kHz})^\circ$
10 kHz < f $\leq$ 50 kHz	$\pm 1.5\% \pm 0.05\%$	$\pm (0.3 + 0.1 \times f \text{ kHz})^\circ$
50 kHz < f $\leq$ 100 kHz	$\pm 2.5\% \pm 0.05\%$	$\pm (0.3 + 0.1 \times f \text{ kHz})^\circ$
100 kHz < f $\leq$ 700 kHz	$\pm (0.025 \times f)\% \pm 0.05\%$	$\pm (0.3 + 0.1 \times f \text{ kHz})^\circ$

· Amplitude accuracy and phase accuracy: defined 110% f.s. or less, or within the derating curve, DC < f < 10 Hz is the value by design  
· Add  $\pm 0.01\%$  rdg. to the amplitude accuracy for input from 100% f.s. to 110% f.s.  
· For the CT6877A-1, add the following for frequencies of 1 kHz < f  $\leq$  700 kHz:  
Amplitude accuracy:  $\pm(0.005 \times f)\%$  rdg., Phase accuracy:  $\pm(0.015 \times f)^\circ$

<b>Temperature and humidity range for guaranteed accuracy</b>	0°C to 40°C (32°F to 104°F), 80% RH or less	
<b>Effect of temperature</b>	In ranges from -40°C to 0°C (-40°F to 32°F) and 40°C to 85°C (104°F to 185°F) Amplitude sensitivity: $\pm 15$ ppm of reading / °C Offset voltage: $\pm 0.5$ ppm of full scale / °C	
<b>Common-Mode Rejection Ratio (CMRR)</b>	(effect on output voltage and common mode voltage) 140 dB or greater (50/60 Hz) 120 dB or greater (100 kHz)	
<b>Linearity error</b>	$\pm 10$ ppm	
<b>Offset error</b>	$\pm 5$ ppm	
<b>Amplitude error</b>	DC: $\pm 15$ ppm	10 kHz to 100 kHz: $\pm 1\%$ 10 Hz to 100 Hz: $\pm 0.01\%$ 100 kHz to 300 kHz: $\pm 2\%$ 100 Hz to 1 kHz: $\pm 0.04\%$ 300 kHz to 700 kHz: $\pm 10\%$ 1 kHz to 10 kHz: $\pm 0.25\%$

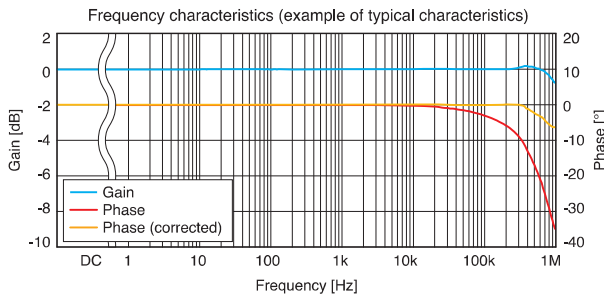
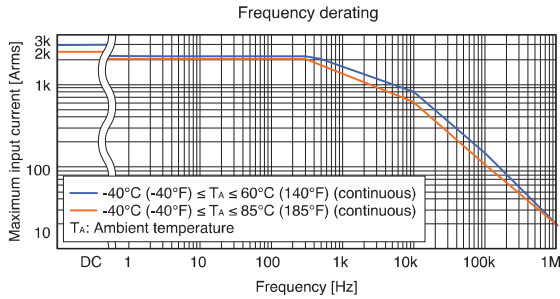

<b>Output voltage</b>	1 mV/A (= 2 V / 2000 A)
<b>Operating temperature and humidity range</b>	-40°C to 85°C (-40°F to 185°F), 80% RH or less (no condensation)
<b>Storage temperature and humidity range</b>	-40°C to 85°C (-40°F to 185°F), 80% RH or less (no condensation)
<b>Maximum rated voltage to ground</b>	1000 V CAT III, Anticipated transient overvoltage: 8000 V
<b>Standards</b>	Safety: EN61010, EMC: EN61326
<b>Cable length</b>	CT6877A: 3 m (9.84 ft.) CT6877A-1: 10 m (32.81 ft.)
<b>Dimensions</b>	229 mm (9.02 in.) W x 232 mm (9.13 in.) H x 112 mm (4.41 in.) D (excluding protruding parts and cables)
<b>Weight</b>	CT6877A: approx. 5 kg (176.4 oz.) CT6877A-1: approx. 5.3 kg (187.0 oz.)

# PW9100A-3 PW9100A-4



Product warranty period: 3 years  
Guaranteed accuracy period: 1 year

<b>Rated current</b>	50 A AC/DC
<b>Frequency band</b>	DC to 3.5 MHz
<b>Input and measurement method</b>	Isolated input, DCCT* input
<b>Measurement terminals</b>	Terminal block M6 screws

\*Direct Connection Current Transducer

### Accuracy

Frequency	Amplitude $\pm$ (% of reading + % of full scale)	Phase
DC	$\pm 0.02\% \pm 0.007\%$	-
DC < f < 30 Hz	$\pm 0.1\% \pm 0.02\%$	$\pm 0.3^\circ$
30 Hz $\leq$ f < 45 Hz	$\pm 0.1\% \pm 0.02\%$	$\pm 0.1^\circ$
45 Hz $\leq$ f $\leq$ 65 Hz	$\pm 0.02\% \pm 0.005\%$	$\pm 0.1^\circ$
65 Hz < f $\leq$ 500 Hz	$\pm 0.1\% \pm 0.01\%$	$\pm 0.12^\circ$
500 Hz < f $\leq$ 1 kHz	$\pm 0.1\% \pm 0.01\%$	$\pm 0.5^\circ$
1 kHz < f $\leq$ 5 kHz	$\pm 0.5\% \pm 0.02\%$	$\pm 0.5^\circ$
5 kHz < f $\leq$ 20 kHz	$\pm 1\% \pm 0.02\%$	$\pm 1^\circ$
20 kHz < f $\leq$ 50 kHz	$\pm 1\% \pm 0.02\%$	$\pm (0.05 \times f \text{ kHz})^\circ$
50 kHz < f $\leq$ 100 kHz	$\pm 2\% \pm 0.05\%$	$\pm (0.06 \times f \text{ kHz})^\circ$
100 kHz < f $\leq$ 300 kHz	$\pm 5\% \pm 0.05\%$	$\pm (0.06 \times f \text{ kHz})^\circ$
300 kHz < f $\leq$ 700 kHz	$\pm 5\% \pm 0.05\%$	$\pm (0.07 \times f \text{ kHz})^\circ$
700 kHz < f $\leq$ 1 MHz	$\pm 10\% \pm 0.05\%$	$\pm (0.07 \times f \text{ kHz})^\circ$

· Amplitude accuracy and phase accuracy: defined within the accuracy guarantee range shown in the derating figure below; DC < f < 10 Hz is the value by design.  
· Add  $\pm 0.01\%$  rdg. to the amplitude accuracy for input from 100% f.s. to 110% f.s.

<b>Temperature and humidity range for guaranteed accuracy</b>	23°C $\pm$ 5°C (73°F $\pm$ 9°F), 80% RH or less
<b>Effect of temperature</b>	In ranges from 0°C to 18°C (32°F to 64°F) and 28°C to 40°C (82°F to 104°F) Amplitude sensitivity: $\pm 20$ ppm of reading / °C Offset voltage: $\pm 1$ ppm of full scale / °C Phase: $\pm 0.01^\circ$ / °C
<b>Common-Mode Rejection Ratio (CMRR)</b>	(effect on output voltage and common mode voltage) 120 dB or greater (50/60 Hz, 100 kHz)

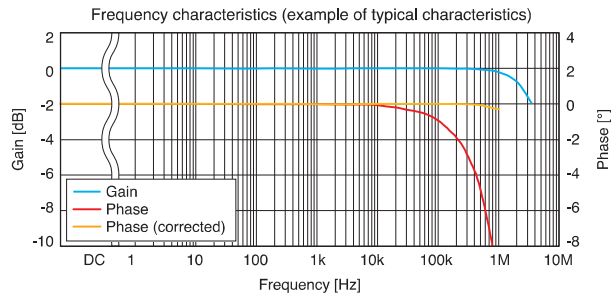
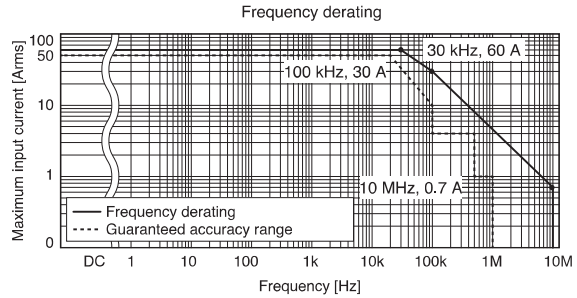

<b>Output voltage</b>	40 mV/A (= 2 V / 50 A)
<b>Operating temperature and humidity range</b>	0°C to 40°C (32°F to 104°F), 80% RH or less (no condensation)
<b>Storage temperature and humidity range</b>	-10°C to 50°C (14°F to 122°F), 80% RH or less (no condensation)
<b>Maximum rated voltage to ground</b>	600 V CAT III, 1000 V CAT II Anticipated transient overvoltage: 6000 V
<b>Standards</b>	Safety: EN 61010, EMC: EN 61326 Class A
<b>Cable length</b>	0.8 m (2.62 ft.)
<b>Dimensions</b>	430 mm (16.9 in.) W x 88 mm (3.46 in.) H x 260 mm (10.23 in.) D
<b>Weight</b>	PW9100A-3: approx. 3.7 kg (130.5 oz.) PW9100A-4: approx. 4.3 kg (151.7 oz.)

## CT6841-05



Product warranty period: 3 years  
Guaranteed accuracy period: 1 year

<b>Rated current</b>	20 A AC/DC
<b>Frequency band</b>	DC to 1 MHz
<b>Diameter of measurable conductors</b>	Max. $\phi$ 20 mm (0.79 in.)

### Accuracy

Frequency	Amplitude $\pm$ (% of reading + % of full scale)	Phase
DC	$\pm 0.3\% \pm 0.05\%^*$	-
DC < f $\leq$ 100 Hz	$\pm 0.3\% \pm 0.01\%$	$\pm 0.1^\circ$
100 Hz < f $\leq$ 500 Hz	$\pm 0.3\% \pm 0.02\%$	$\pm 0.2^\circ$
500 Hz < f $\leq$ 1 kHz	$\pm 0.5\% \pm 0.02\%$	$\pm 0.5^\circ$
1 kHz < f $\leq$ 5 kHz	$\pm 1.0\% \pm 0.02\%$	$\pm 1.0^\circ$
5 kHz < f $\leq$ 10 kHz	$\pm 1.5\% \pm 0.02\%$	$\pm 1.5^\circ$
10 kHz < f $\leq$ 50 kHz	$\pm 2.0\% \pm 0.02\%$	$\pm (0.5 + 0.1 \times f \text{ kHz})^\circ$
50 kHz < f $\leq$ 100 kHz	$\pm 5.0\% \pm 0.05\%$	$\pm (0.5 + 0.1 \times f \text{ kHz})^\circ$
100 kHz < f $\leq$ 300 kHz	$\pm 10\% \pm 0.05\%$	$\pm (0.5 + 0.1 \times f \text{ kHz})^\circ$
300 kHz < f $\leq$ 500 kHz	$\pm 15\% \pm 0.05\%$	-
500 kHz < f < 1 MHz	$\pm 30\% \pm 0.05\%$	-

\* $\pm 0.05\%$  f.s. after adjusting the offset voltage to  $\pm 0.5$  mV or less.

The values above are when the input is a sine wave, the conductor is in the center of the sensor opening, and the measurement instrument's input resistance is 1 M $\Omega$  or higher.  
Amplitude accuracy: defined at the rated value, or less or within the derating curve;  
DC < f < 5 Hz is the value by design.  
Phase accuracy: defined at the rated value or less or within the derating curve;  
DC < f < 10 Hz is the value by design.

<b>Temperature and humidity range for guaranteed accuracy</b>	0°C to 40°C (32°F to 104°F), 80% RH or less
<b>Effect of temperature</b>	In ranges from -40°C to 0°C (-40°F to 32°F) and 40°C to 85°C (104°F to 185°F) Amplitude sensitivity: $\pm 0.01\%$ of reading / °C Offset voltage: $\pm 0.005\%$ of full scale / °C
<b>Effect of common mode voltage</b>	0.05% f.s. or less (1000 Vrms, DC to 100 Hz)

Frequency derating

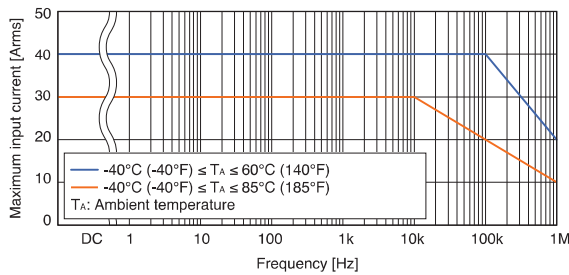

Frequency characteristics (example of typical characteristics)

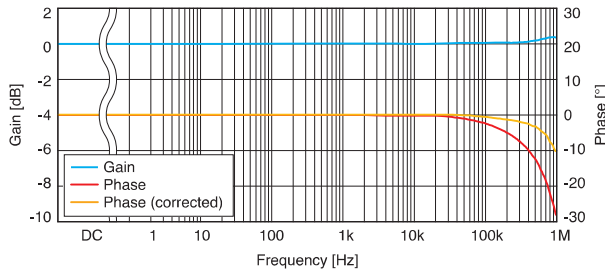

<b>Output voltage</b>	100 mV/A (= 2 V / 20 A)
<b>Measurable conductors</b>	Insulated conductor
<b>Operating temperature and humidity range</b>	-40°C to 85°C (-40°F to 185°F), 80% RH or less (no condensation)
<b>Storage temperature and humidity range</b>	-40°C to 85°C (-40°F to 185°F), 80% RH or less (no condensation)
<b>Withstand voltage</b>	4260 V AC Withstand test current of 1 mA, 50/60 Hz, 1 min., between jaws and cable output terminal
<b>Standards</b>	Safety: EN 61010, EMC: EN 61326
<b>Cable length</b>	3 m (9.84 ft.)
<b>Dimensions</b>	153 mm (6.02 in.) W x 67 mm (2.64 in.) H x 25 mm (0.98 in.) D (excluding protruding parts and cables)
<b>Weight</b>	Approx. 350 g (12.3 oz.)

## CT6843-05



Product warranty period: 3 years  
Guaranteed accuracy period: 1 year

<b>Rated current</b>	200 A AC/DC
<b>Frequency band</b>	DC to 500 kHz
<b>Diameter of measurable conductors</b>	Max. $\phi$ 20 mm (0.79 in.)

### Accuracy

Frequency	Amplitude $\pm$ (% of reading + % of full scale)	Phase
DC	$\pm 0.3\% \pm 0.02\%^*$	-
DC < f $\leq$ 100 Hz	$\pm 0.3\% \pm 0.01\%$	$\pm 0.1^\circ$
100 Hz < f $\leq$ 500 Hz	$\pm 0.3\% \pm 0.02\%$	$\pm 0.2^\circ$
500 Hz < f $\leq$ 1 kHz	$\pm 0.5\% \pm 0.02\%$	$\pm 0.5^\circ$
1 kHz < f $\leq$ 5 kHz	$\pm 1.0\% \pm 0.02\%$	$\pm 1.0^\circ$
5 kHz < f $\leq$ 10 kHz	$\pm 1.5\% \pm 0.02\%$	$\pm 1.5^\circ$
10 kHz < f $\leq$ 50 kHz	$\pm 5.0\% \pm 0.02\%$	$\pm (0.5 + 0.1 \times f \text{ kHz})^\circ$
50 kHz < f $\leq$ 100 kHz	$\pm 15\% \pm 0.05\%$	$\pm (0.5 + 0.1 \times f \text{ kHz})^\circ$
100 kHz < f $\leq$ 300 kHz	$\pm 15\% \pm 0.05\%$	$\pm (0.5 + 0.1 \times f \text{ kHz})^\circ$
300 kHz < f $\leq$ 500 kHz	$\pm 30\% \pm 0.05\%$	-

\* $\pm 0.02\%$  f.s. after adjusting the offset voltage to  $\pm 0.2$  mV or less

The values above are when the input is a sine wave, the conductor is in the center of the sensor opening, and the measurement instrument's input resistance is 1 M $\Omega$  or higher.  
Amplitude accuracy: defined at the rated value or less or within the derating curve;  
DC < f < 5 Hz is the value by design.  
Phase accuracy: defined at the rated value or less or within the derating curve;  
DC < f < 10 Hz is the value by design.

<b>Temperature and humidity range for guaranteed accuracy</b>	0°C to 40°C (32°F to 104°F), 80% RH or less
<b>Effect of temperature</b>	In ranges from -40°C to 0°C (-40°F to 32°F) and 40°C to 85°C (104°F to 185°F) Amplitude sensitivity: $\pm 0.01\%$ of reading / °C Offset voltage: $\pm 0.005\%$ of full scale / °C
<b>Effect of common mode voltage</b>	0.05% f.s. or less (1000 Vrms, DC to 100 Hz)

Frequency derating

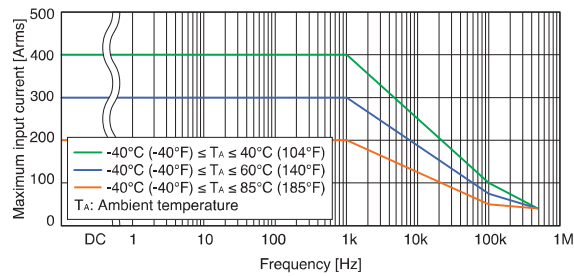

Frequency characteristics (example of typical characteristics)

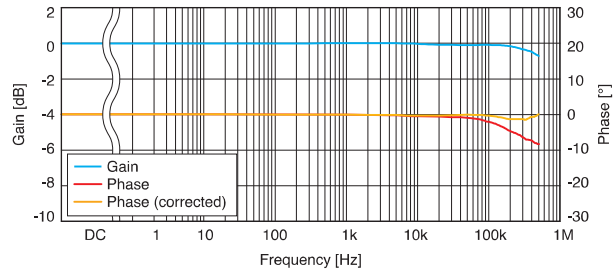

<b>Output voltage</b>	10 mV/A (= 2 V / 200 A)
<b>Measurable conductors</b>	Insulated conductor
<b>Operating temperature and humidity range</b>	-40°C to 85°C (-40°F to 185°F), 80% RH or less (no condensation)
<b>Storage temperature and humidity range</b>	-40°C to 85°C (-40°F to 185°F), 80% RH or less (no condensation)
<b>Withstand voltage</b>	4260 V AC Withstand test current of 1 mA, 50/60 Hz, 1 min., between jaws and cable output terminal
<b>Standards</b>	Safety: EN 61010, EMC: EN 61326
<b>Cable length</b>	3 m (9.84 ft.)
<b>Dimensions</b>	153 mm (6.02 in.) W x 67 mm (2.64 in.) H x 25 mm (0.98 in.) D (excluding protruding parts and cables)
<b>Weight</b>	Approx. 370 g (13.1 oz.)



### CT6844-05



Product warranty period: 3 years  
Guaranteed accuracy period: 1 year

<b>Rated current</b>	500 A AC/DC
<b>Frequency band</b>	DC to 200 kHz
<b>Diameter of measurable conductors</b>	Max. $\phi$ 20 mm (0.79 in.)

#### Accuracy

Frequency	Amplitude $\pm$ (% of reading + % of full scale)	Phase
DC	$\pm 0.3\% \pm 0.02\%^*$	-
DC < f $\leq$ 100 Hz	$\pm 0.3\% \pm 0.01\%$	$\pm 0.1^\circ$
100 Hz < f $\leq$ 500 Hz	$\pm 0.3\% \pm 0.02\%$	$\pm 0.2^\circ$
500 Hz < f $\leq$ 1 kHz	$\pm 0.5\% \pm 0.02\%$	$\pm 0.5^\circ$
1 kHz < f $\leq$ 5 kHz	$\pm 1.0\% \pm 0.02\%$	$\pm 1.0^\circ$
5 kHz < f $\leq$ 10 kHz	$\pm 1.5\% \pm 0.02\%$	$\pm 1.5^\circ$
10 kHz < f $\leq$ 50 kHz	$\pm 5.0\% \pm 0.02\%$	$\pm(0.5 + 0.1 \times f \text{ kHz})^\circ$
50 kHz < f $\leq$ 100 kHz	$\pm 15\% \pm 0.05\%$	$\pm(0.5 + 0.1 \times f \text{ kHz})^\circ$
100 kHz < f $\leq$ 200 kHz	$\pm 30\% \pm 0.05\%$	$\pm(0.5 + 0.1 \times f \text{ kHz})^\circ$

\* $\pm 0.02\%$  f.s. after adjusting the offset voltage to  $\pm 0.2$  mV or less

The values above are when the input is a sine wave, the conductor is in the center of the sensor opening, and the measurement instrument's input resistance is 1 M $\Omega$  or higher.  
Amplitude accuracy: defined at the rated value or less or within the derating curve;  
DC < f < 5 Hz is the value by design.  
Phase accuracy: defined at the rated value or less, or within the derating curve;  
DC < f < 10 Hz is the value by design.

<b>Temperature and humidity range for guaranteed accuracy</b>	0°C to 40°C (32°F to 104°F), 80% RH or less
<b>Effect of temperature</b>	In ranges from -40°C to 0°C (-40°F to 32°F) and 40°C to 85°C (104°F to 185°F) Amplitude sensitivity: $\pm 0.01\%$ of reading / °C Offset voltage: $\pm 0.005\%$ of full scale / °C
<b>Effect of common mode voltage</b>	0.05% f.s. or less (1000 Vrms, DC to 100 Hz)

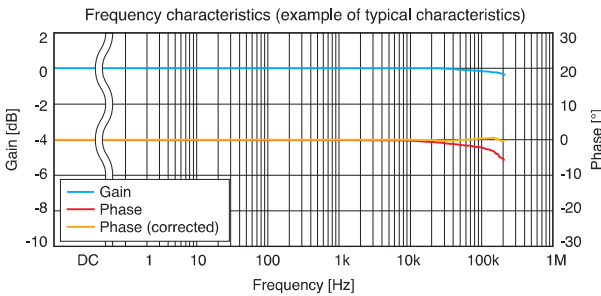
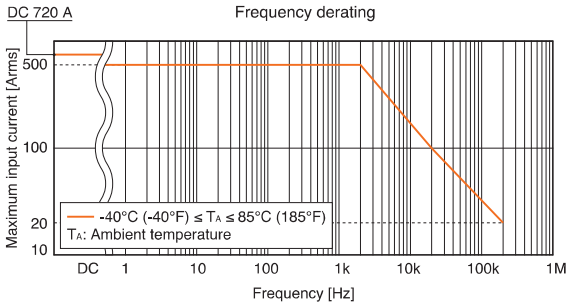

<b>Output voltage</b>	4 mV/A (= 2 V / 500 A)
<b>Measurable conductors</b>	Insulated conductor
<b>Operating temperature and humidity range</b>	-40°C to 85°C (-40°F to 185°F), 80% RH or less (no condensation)
<b>Storage temperature and humidity range</b>	-40°C to 85°C (-40°F to 185°F), 80% RH or less (no condensation)
<b>Withstand voltage</b>	4260 V AC Withstand test current of 1 mA, 50/60 Hz, 1 min., between jaws and cable output terminal
<b>Standards</b>	Safety: EN 61010, EMC: EN 61326
<b>Cable length</b>	3 m (9.84 ft.)
<b>Dimensions</b>	153 mm (6.02 in.) W x 67 mm (2.64 in.) H x 25 mm (0.98 in.) D (excluding protruding parts and cables)
<b>Weight</b>	Approx. 400 g (14.1 oz.)

### CT6845-05



Product warranty period: 3 years  
Guaranteed accuracy period: 1 year

<b>Rated current</b>	500 A AC/DC
<b>Frequency band</b>	DC to 100 kHz
<b>Diameter of measurable conductors</b>	Max. $\phi$ 50 mm (1.97 in.)

#### Accuracy

Frequency	Amplitude $\pm$ (% of reading + % of full scale)	Phase
DC	$\pm 0.3\% \pm 0.02\%^*$	-
DC < f $\leq$ 100 Hz	$\pm 0.3\% \pm 0.01\%$	$\pm 0.1^\circ$
100 Hz < f $\leq$ 500 Hz	$\pm 0.3\% \pm 0.02\%$	$\pm 0.2^\circ$
500 Hz < f $\leq$ 1 kHz	$\pm 0.5\% \pm 0.02\%$	$\pm 0.5^\circ$
1 kHz < f $\leq$ 5 kHz	$\pm 1.0\% \pm 0.02\%$	$\pm 1.5^\circ$
5 kHz < f $\leq$ 10 kHz	$\pm 1.5\% \pm 0.02\%$	$\pm 2.0^\circ$
10 kHz < f $\leq$ 20 kHz	$\pm 5.0\% \pm 0.02\%$	$\pm(0.2 \times f \text{ kHz})^\circ$
20 kHz < f $\leq$ 50 kHz	$\pm 10\% \pm 0.05\%$	$\pm(0.2 \times f \text{ kHz})^\circ$
50 kHz < f $\leq$ 100 kHz	$\pm 30\% \pm 0.05\%$	$\pm(0.2 \times f \text{ kHz})^\circ$

\* $\pm 0.02\%$  f.s. after adjusting the offset voltage to  $\pm 0.2$  mV or less

The values above are when the input is a sine wave, the conductor is in the center of the sensor opening, and the measurement instrument's input resistance is 1 M $\Omega$  or higher.  
Amplitude accuracy: defined at the rated value or less, or within the derating curve;  
DC < f < 5 Hz is the value by design.  
Phase accuracy: defined at the rated value or less, or within the derating curve;  
DC < f < 10 Hz is the value by design.

<b>Temperature and humidity range for guaranteed accuracy</b>	0°C to 40°C (32°F to 104°F), 80% RH or less
<b>Effect of temperature</b>	In ranges from -40°C to 0°C (-40°F to 32°F) and 40°C to 85°C (104°F to 185°F) Amplitude sensitivity: $\pm 0.01\%$ of reading / °C Offset voltage: $\pm 0.005\%$ of full scale / °C
<b>Effect of common mode voltage</b>	0.05% f.s. or less (1000 Vrms, DC to 100 Hz)

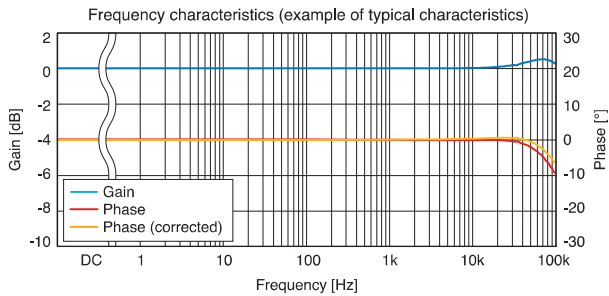
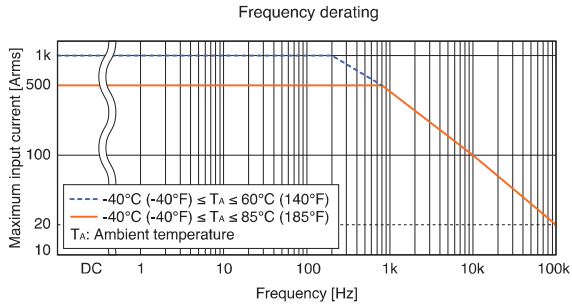

<b>Output voltage</b>	4 mV/A (= 2 V / 500 A)
<b>Measurable conductors</b>	Insulated conductor
<b>Operating temperature and humidity range</b>	-40°C to 85°C (-40°F to 185°F), 80% RH or less (no condensation)
<b>Storage temperature and humidity range</b>	-40°C to 85°C (-40°F to 185°F), 80% RH or less (no condensation)
<b>Withstand voltage</b>	4260 V AC Withstand test current of 1 mA, 50/60 Hz, 1 min., between jaws and cable output terminal
<b>Standards</b>	Safety: EN 61010, EMC: EN 61326
<b>Cable length</b>	3 m (9.84 ft.)
<b>Dimensions</b>	238 mm (9.37 in.) W x 116 mm (4.57 in.) H x 35 mm (1.38 in.) D (excluding protruding parts and cables)
<b>Weight</b>	Approx. 860 g (30.3 oz.)



# CT6846-05



Product warranty period: 3 years  
Guaranteed accuracy period: 1 year

<b>Rated current</b>	1000 AAC/DC
<b>Frequency band</b>	DC to 20 kHz
<b>Diameter of measurable conductors</b>	Max. $\phi$ 50 mm (1.97 in.)

## Accuracy

Frequency	Amplitude $\pm$ (% of reading + % of full scale)	Phase
DC	$\pm 0.3\% \pm 0.02\%^*$	-
DC < f $\leq$ 100 Hz	$\pm 0.3\% \pm 0.01\%$	$\pm 0.1^\circ$
100 Hz < f $\leq$ 500 Hz	$\pm 0.5\% \pm 0.02\%$	$\pm 0.2^\circ$
500 Hz < f $\leq$ 1 kHz	$\pm 1.0\% \pm 0.02\%$	$\pm 0.5^\circ$
1 kHz < f $\leq$ 5 kHz	$\pm 2.0\% \pm 0.02\%$	$\pm 1.5^\circ$
5 kHz < f $\leq$ 10 kHz	$\pm 5.0\% \pm 0.05\%$	$\pm 2.0^\circ$
10 kHz < f $\leq$ 20 kHz	$\pm 30\% \pm 0.10\%$	$\pm 10.0^\circ$

\* $\pm 0.02\%$  f.s. after adjusting the offset voltage to  $\pm 0.2$  mV or less

The values above are when the input is a sine wave, the conductor is in the center of the sensor opening, and the measurement instrument's input resistance is 1 M $\Omega$  or higher.  
Amplitude accuracy: defined at the rated value or less, or within the derating curve;  
DC < f < 5 Hz is the value by design.  
Phase accuracy: defined at the rated value or less, or within the derating curve;  
DC < f < 10 Hz is the value by design.

<b>Temperature and humidity range for guaranteed accuracy</b>	0°C to 40°C (32°F to 104°F), 80% RH or less
<b>Effect of temperature</b>	In ranges from -40°C to 0°C (-40°F to 32°F) and 40°C to 85°C (104°F to 185°F) Amplitude sensitivity: $\pm 0.01\%$ of reading /°C Offset voltage: $\pm 0.005\%$ of full scale / °C
<b>Effect of common mode voltage</b>	0.05% f.s. or less (1000 Vrms, DC to 100 Hz)

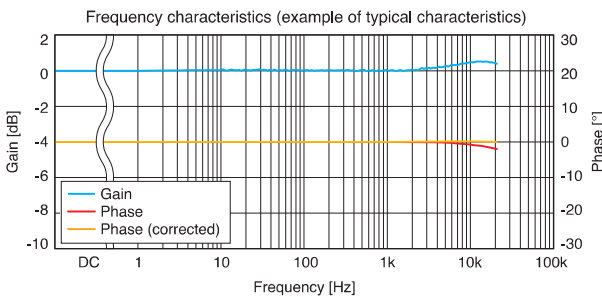
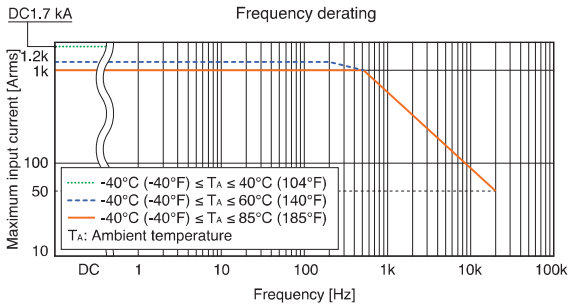

<b>Output voltage</b>	2 mV/A (= 2 V / 1000 A)
<b>Measurable conductors</b>	Insulated conductor
<b>Operating temperature and humidity range</b>	-40°C to 85°C (-40°F to 185°F), 80% RH or less (no condensation)
<b>Storage temperature and humidity range</b>	-40°C to 85°C (-40°F to 185°F), 80% RH or less (no condensation)
<b>Withstand voltage</b>	4260 V AC Withstand test current of 1 mA, 50/60 Hz, 1 min., between jaws and cable output terminal
<b>Standards</b>	Safety: EN 61010, EMC: EN 61326
<b>Cable length</b>	3 m (9.84 ft.)
<b>Dimensions</b>	238 mm (9.37 in.) W x 116 mm (4.57 in.) H x 35 mm (1.38 in.) D (excluding protruding parts and cables)
<b>Weight</b>	Approx. 990 g (34.9 oz.)

# 9272-05



Product warranty period: 3 years  
Guaranteed accuracy period: 1 year

<b>Rated current</b>	20 A AC, 200 A AC (2 ranges)
<b>Frequency band</b>	1 Hz to 100 kHz
<b>Diameter of measurable conductors</b>	$\phi$ 46 mm or less

## Accuracy

Frequency	Amplitude $\pm$ (% of reading + % of full scale)	Phase
1 Hz $\leq$ f < 5 Hz	$\pm 2.0\% \pm 0.10\%$	-
5 Hz $\leq$ f < 10 Hz	$\pm 1.0\% \pm 0.05\%$	$\pm 1.0^\circ$
10 Hz $\leq$ f < 45 Hz	$\pm 0.5\% \pm 0.02\%$	$\pm 0.5^\circ$
45 Hz $\leq$ f $\leq$ 66 Hz	$\pm 0.3\% \pm 0.01\%$	$\pm 0.2^\circ$
66 Hz < f $\leq$ 500 Hz	$\pm 0.5\% \pm 0.02\%$	$\pm 0.5^\circ$
500 Hz < f $\leq$ 1 kHz	$\pm 0.5\% \pm 0.02\%$	$\pm 1.0^\circ$
1 kHz < f $\leq$ 5 kHz	$\pm 1.0\% \pm 0.05\%$	$\pm 2.0^\circ$
5 kHz < f $\leq$ 10 kHz	$\pm 2.5\% \pm 0.10\%$	$\pm 3.0^\circ$
10 kHz < f $\leq$ 20 kHz	$\pm 5\% \pm 0.1\%$	$\pm 5.0^\circ$
20 kHz < f $\leq$ 50 kHz	$\pm 5\% \pm 0.1\%$	$\pm 15.0^\circ$
50 kHz < f $\leq$ 100 kHz	$\pm 30\% \pm 0.1\%$	-

Accuracy is specified by the following conditions:  
• Less than or equal to the rated current of each current range  
• Within derating range of each current range  
The accuracy values above are for within the rated current for each range and inside of derating range. (The values are the values by design: amplitude at under 5 Hz and phase at under 10 Hz)

<b>Temperature and humidity range for guaranteed accuracy</b>	23°C $\pm 5^\circ$ C (73°F $\pm 9^\circ$ F), 80% RH or less
<b>Effect of temperature</b>	Amplitude sensitivity: $\pm 0.03\%$ of reading /°C

Frequency derating

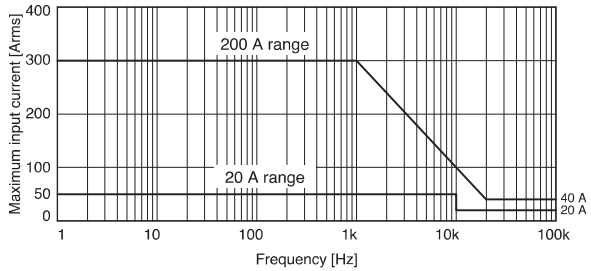

Frequency characteristics (example of typical characteristics)

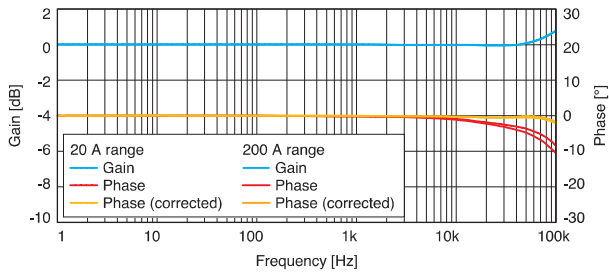

<b>Output voltage</b>	20 A range: 100 mV/A (= 2 V / 20 A) 200 A range: 10 mV/A (= 2 V / 200 A)
<b>Operating temperature and humidity range</b>	0°C to 50°C (32°F to 122°F), 80% RH or less (no condensation)
<b>Storage temperature and humidity range</b>	-10°C to 60°C (14°F to 140°F), 80% RH or less (no condensation)
<b>Maximum rated voltage to ground</b>	600 V AC CAT III (50/60 Hz) Anticipated transient overvoltage: 6000 V
<b>Standards</b>	Safety: EN 61010, EMC: EN 61326 Class A
<b>Cable length</b>	3 m (9.84 ft.)
<b>Dimensions</b>	78 mm (3.07 in.) W x 188 mm (7.40 in.) H x 35 mm (1.38 in.) D (excluding protruding parts and cables)
<b>Weight</b>	Approx. 450 g (15.9 oz.)

# CT6710

Product warranty period: 1 year  
 Guaranteed accuracy period: 1 year



<b>Rated current* (3 ranges)</b>	30 Arms, 5 Arms, 0.5 Arms AC/DC
<b>Frequency band</b>	DC to 50 MHz (-3dB)
<b>Diameter of measurable conductors</b>	Max. $\phi$ 5 mm (0.20 in.) (insulated conductors)

\*DC or sine wave signals of 45 to 66 Hz, within maximum peak current for each range

<b>Rise time</b>	7.0 ns or less (10% to 90%)
<b>Output voltage</b>	0.1 V/A (30 A range) 1 V/A (5 A range) 10 V/A (0.5 A range)
<b>Maximum peak current</b>	$\pm 50$ A peak* <sup>1</sup> (30 A range) $\pm 7.5$ A peak (5 A range) $\pm 0.75$ A peak (0.5 A range, $\geq 10$ MHz) $\pm 0.3$ A peak (0.5 A range, $< 10$ MHz)
<b>Noise</b>	75 $\mu$ Arms or less* <sup>2</sup> (typical: 60 $\mu$ Arms)

\*1: Maximum 2 sec input; requires cooling time of at least 10 times longer than the time current has been input  
 \*2: Does not apply to devices to which the probe is connected; applicable in the 0.5 A range and when used with 20 MHz bandwidth instrument devices

## Accuracy (amplitude)

Range	Accuracy	typical
30 A	$\pm 3.0\%$ rdg. $\pm 1$ mV	$\pm 1.0\%$ rdg $\pm 1$ mV ( $\leq 10$ A)
5 A	$\pm 3.0\%$ rdg. $\pm 1$ mV	$\pm 1.0\%$ rdg $\pm 1$ mV
0.5 A	$\pm 3.0\%$ rdg. $\pm 10$ mV	$\pm 1.0\%$ rdg $\pm 10$ mV

The accuracy above is valid within the following conditions:  
 Warm-up time: 30 minutes, operating environment of 23°C  $\pm$  5°C (73°F  $\pm$  9°F) at 80% RH or less, DC or sine wave signals of 45 to 66 Hz, within maximum peak current for each range

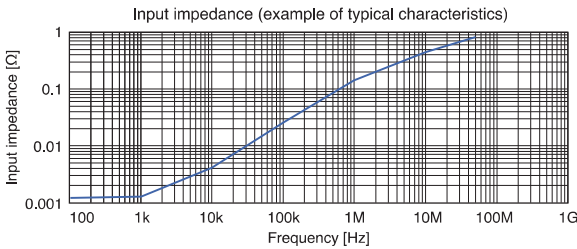
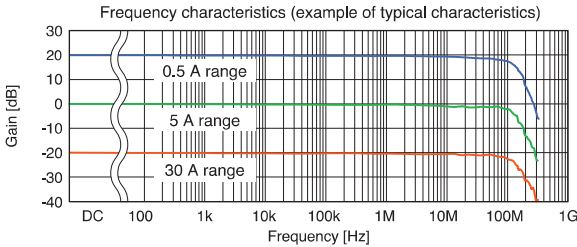
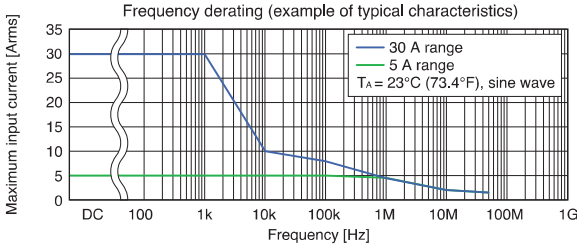

<b>Operating temperature and humidity range</b>	0°C to 40°C (32°F to 104°F), 80% RH or less (no condensation)
<b>Storage temperature and humidity range</b>	-10°C to 50°C (14°F to 122°F), 80% RH or less (no condensation)
<b>Standards</b>	Safety: EN 61010, EMC: EN 61326
<b>Maximum rated power</b>	7.8 VA (continuous maximum input)
<b>Cable length</b>	Sensor/junction box: 1500 mm (59.06 in.) Junction box/termination unit: 150 mm (5.91 in.) Power cord: 1000 mm (39.37 in.)
<b>Dimensions</b>	Sensor: 155 mm (6.10 in.) W x 18 mm (0.71 in.) H x 26 mm (1.02 in.) D Junction box: 45 mm (1.77 in.) W x 120 mm (4.72 in.) H x 25 mm (0.98 in.) D Termination unit: 29 mm (1.14 in.) W x 83 mm (3.27 in.) H x 40 mm (1.57 in.) D (excluding BNC connector or protrusions)
<b>Weight</b>	Approx. 370 g (13.1 oz.)

# CT6711

Product warranty period: 1 year  
 Guaranteed accuracy period: 1 year



<b>Rated current* (3 ranges)</b>	30 Arms, 5 Arms, 0.5 Arms AC/DC
<b>Frequency band</b>	DC to 120 MHz (-3dB)
<b>Diameter of measurable conductors</b>	Max. $\phi$ 5 mm (0.20 in.) (insulated conductors)

\*DC or sine wave signals of 45 to 66 Hz, within maximum peak current for each range

<b>Rise time</b>	2.9 ns or less (10% to 90%)
<b>Output voltage</b>	0.1 V/A (30 A range) 1 V/A (5 A range) 10 V/A (0.5 A range)
<b>Maximum peak current</b>	$\pm 50$ A peak* <sup>1</sup> (30 A range) $\pm 7.5$ A peak (5 A range) $\pm 0.75$ A peak (0.5 A range, $\geq 10$ MHz) $\pm 0.3$ A peak (0.5 A range, $< 10$ MHz)
<b>Noise</b>	75 $\mu$ Arms or less* <sup>2</sup> (typical: 60 $\mu$ Arms)

\*1: Maximum 2 sec. input; requires cooling time at least 10 times longer than the time current has been input  
 \*2: Does not apply to devices to which the probe is connected; applicable in the 0.5 A range and when used with 20 MHz bandwidth instrument devices

## Accuracy (amplitude)

Range	Accuracy	typical
30 A	$\pm 3.0\%$ rdg. $\pm 1$ mV	$\pm 1.0\%$ rdg $\pm 1$ mV ( $\leq 10$ A)
5 A	$\pm 3.0\%$ rdg. $\pm 1$ mV	$\pm 1.0\%$ rdg $\pm 1$ mV
0.5 A	$\pm 3.0\%$ rdg. $\pm 10$ mV	$\pm 1.0\%$ rdg $\pm 10$ mV

The accuracy above is valid within the following conditions:  
 Warm-up time: 30 minutes, operating environment of 23°C  $\pm$  5°C (73°F  $\pm$  9°F) at 80% RH or less, DC or sine wave signals of 45 to 66 Hz, within maximum peak current for each range

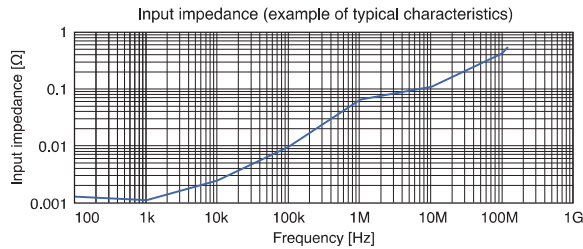
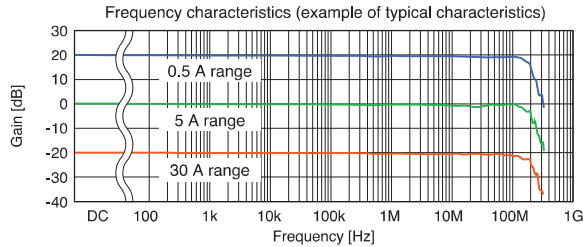
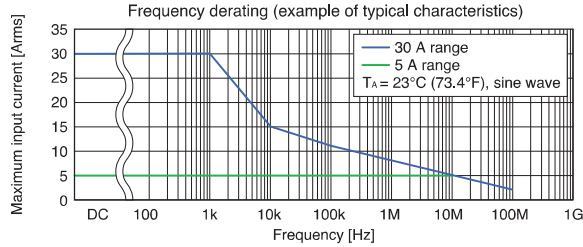

<b>Operating temperature and humidity range</b>	0°C to 40°C (32°F to 104°F), 80% RH or less (no condensation)
<b>Storage temperature and humidity range</b>	-10°C to 50°C (14°F to 122°F), 80% RH or less (no condensation)
<b>Standards</b>	Safety: EN 61010, EMC: EN 61326
<b>Maximum rated power</b>	7.8 VA (continuous maximum input)
<b>Cable length</b>	Sensor/junction box: 1500 mm (59.06 in.) Junction box/termination unit: 150 mm (5.91 in.) Power cord: 1000 mm (39.37 in.)
<b>Dimensions</b>	Sensor: 155 mm (6.10 in.) W x 18 mm (0.71 in.) H x 26 mm (1.02 in.) D Junction box: 45 mm (1.77 in.) W x 120 mm (4.72 in.) H x 25 mm (0.98 in.) D Termination unit: 29 mm (1.14 in.) W x 83 mm (3.27 in.) H x 40 mm (1.57 in.) D (excluding BNC connector or protrusions)
<b>Weight</b>	Approx. 370 g (13.1 oz.)

# CT6700



Product warranty period: 1 year  
Guaranteed accuracy period: 1 year

<b>Rated current*</b>	5 Arms
<b>Frequency band</b>	DC to 50 MHz (-3dB)
<b>Diameter of measurable conductors</b>	Max. $\phi$ 5 mm (0.20 in.) (insulated conductors)

\*DC or sine wave signals of 45 to 66 Hz, within maximum peak current for each range

<b>Rise time</b>	7.0 ns or less (10% to 90%)
<b>Output voltage</b>	1 V/A
<b>Maximum peak current</b>	$\pm 7.5$ A peak (non-continuous)
<b>Noise</b>	75 $\mu$ Arms or less* (typical: 60 $\mu$ A rms)

\*Does not apply to devices to which the probe is connected;  
applicable when used with 30 MHz bandwidth instrument devices

## Accuracy (amplitude)

Accuracy	typical
$\pm 3.0\%$ rdg. $\pm 1$ mV	$\pm 1.0\%$ rdg. $\pm 1$ mV

The accuracy above is valid within the following conditions:  
Warm-up time: 30 minutes, operating environment of 23°C  $\pm$  5°C (73°F  $\pm$  9°F) at 80% RH or less, DC or sine wave signals of 45 to 66 Hz, 0 Arms to 5 Arms

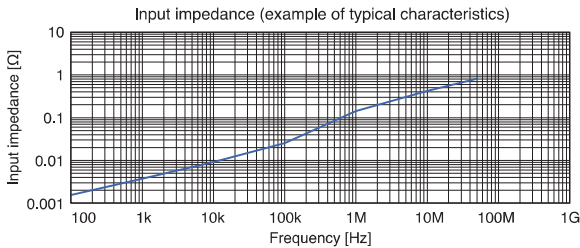
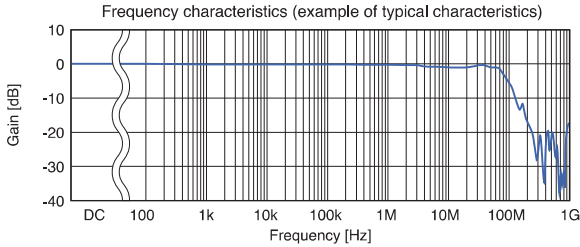
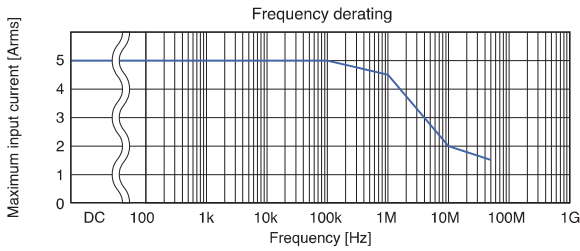

<b>Operating temperature and humidity range</b>	0°C to 40°C (32°F to 104°F), 80% RH or less (no condensation)
<b>Storage temperature and humidity range</b>	-10°C to 50°C (14°F to 122°F), 80% RH or less (no condensation)
<b>Standards</b>	Safety: EN 61010, EMC: EN 61326
<b>Maximum rated power</b>	3.2 VA (continuous maximum input)
<b>Cable length</b>	Sensor cable: 1500 mm (59.06 in.) Power cord: 1000 mm (39.37 in.)
<b>Dimensions</b>	Sensor: 155 mm (6.10 in.) W $\times$ 18 mm (0.71 in.) H $\times$ 26 mm (1.02 in.) D Termination unit: 29 mm (1.14 in.) W $\times$ 83 mm (3.27 in.) H $\times$ 40 mm (1.57 in.) D (excluding BNC connector or protrusions)
<b>Weight</b>	Approx. 250 g (8.8 oz.)

# CT6701



Product warranty period: 1 year  
Guaranteed accuracy period: 1 year

<b>Rated current*</b>	5 Arms
<b>Frequency band</b>	DC to 120 MHz (-3dB)
<b>Diameter of measurable conductors</b>	Max. $\phi$ 5 mm (0.20 in.) (insulated conductors)

\*DC or sine wave signals of 45 to 66 Hz, within maximum peak current for each range

<b>Rise time</b>	2.9 ns or less (10% to 90%)
<b>Output voltage</b>	1 V/A
<b>Maximum peak current</b>	$\pm 7.5$ A peak (non-continuous)
<b>Noise</b>	75 $\mu$ Arms or less* (typical: 60 $\mu$ A rms)

\*Does not apply to devices to which the probe is connected;  
applicable when used with 30 MHz bandwidth instrument devices

## Accuracy (amplitude)

Accuracy	typical
$\pm 3.0\%$ rdg. $\pm 1$ mV	$\pm 1.0\%$ rdg. $\pm 1$ mV

The accuracy above is valid within the following conditions:  
Warm-up time: 30 minutes, operating environment of 23°C  $\pm$  5°C (73°F  $\pm$  9°F) at 80% RH or less, DC or sine wave signals of 45 to 66 Hz, 0 Arms to 5 Arms

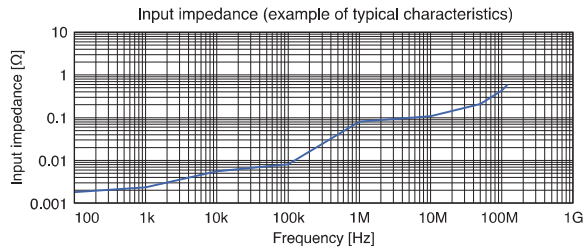
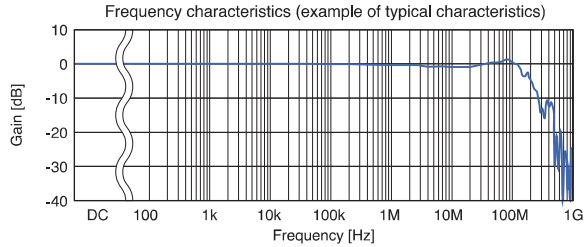
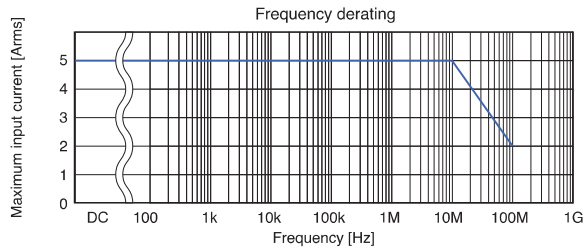

<b>Operating temperature and humidity range</b>	0°C to 40°C (32°F to 104°F), 80% RH or less (no condensation)
<b>Storage temperature and humidity range</b>	-10°C to 50°C (14°F to 122°F), 80% RH or less (no condensation)
<b>Standards</b>	Safety: EN 61010, EMC: EN 61326
<b>Maximum rated power</b>	3.2 VA (continuous maximum input)
<b>Cable length</b>	Sensor cable: 1500 mm (59.06 in.) Power cord: 1000 mm (39.37 in.)
<b>Dimensions</b>	Sensor: 155 mm (6.10 in.) W $\times$ 18 mm (0.71 in.) H $\times$ 26 mm (1.02 in.) D Termination unit: 29 mm (1.14 in.) W $\times$ 83 mm (3.27 in.) H $\times$ 40 mm (1.57 in.) D (excluding BNC connector or protrusions)
<b>Weight</b>	Approx. 250 g (8.8 oz.)

### 3273-50

Product warranty period: 1 year  
 Guaranteed accuracy period: 1 year



<b>Rated current*</b>	30 Arms
<b>Frequency band</b>	DC to 50 MHz (-3dB)
<b>Diameter of measurable conductors</b>	Max. $\phi$ 5 mm (0.20 in.) (insulated conductors)

\*Refer to the graph for frequency derating characteristics.

<b>Rise time</b>	7.0 ns or less
<b>Output voltage</b>	0.1 V/A
<b>Maximum peak current</b>	50 A peak (non-continuous)
<b>Noise</b>	2.5 mArms or less*

\*Does not apply to devices to which the probe is connected;  
 applicable when used with 20 MHz bandwidth instrument devices

#### Accuracy (amplitude)

to 30 Arms	to 50 A peak
$\pm 1.0\%$ rdg. $\pm 1$ mV	$\pm 2.0\%$ rdg.

The accuracy above is valid within the following conditions:  
 Warm-up time: 30 minutes, operating environment of 23°C  $\pm$  5°C (73°F  $\pm$  9°F) at 80% RH or less, DC or sine wave signals of 45 to 66 Hz, 0 Arms to 5 Arms

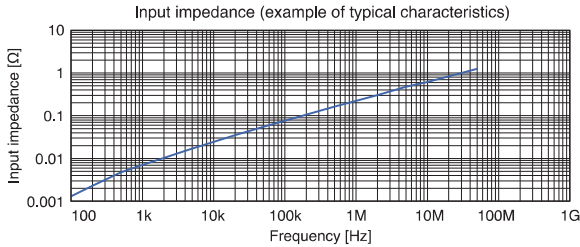
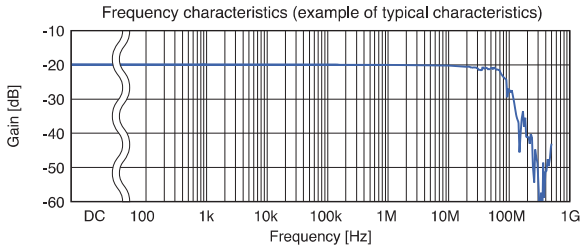
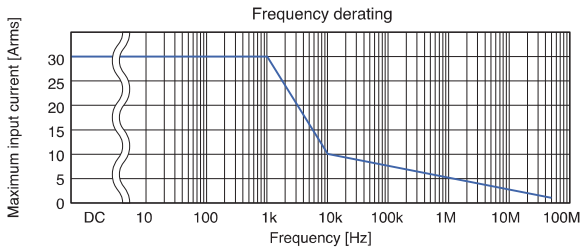

<b>Operating temperature and humidity range</b>	0°C to 40°C (32°F to 104°F), 80% RH or less (no condensation)
<b>Storage temperature and humidity range</b>	-10°C to 50°C (14°F to 122°F), 80% RH or less (no condensation)
<b>Standards</b>	Safety: EN 61010, EMC: EN 61326
<b>Maximum rated power</b>	5.6 VA
<b>Cable length</b>	Sensor cable: 1500 mm (59.06 in.) Power cord: 1000 mm (39.37 in.)
<b>Dimensions</b>	Sensor: 175 mm (6.89 in.) W $\times$ 18 mm (0.71 in.) H $\times$ 40 mm (1.57 in.) D Termination unit: 27 mm (1.06 in.) W $\times$ 55 mm (2.17 in.) H $\times$ 18 mm (0.71 in.) D (excluding BNC connector or protrusions)
<b>Weight</b>	Approx. 230 g (8.1 oz)

### 3276

Product warranty period: 1 year  
 Guaranteed accuracy period: 1 year



<b>Rated current*</b>	30 Arms
<b>Frequency band</b>	DC to 100 MHz (-3dB)
<b>Diameter of measurable conductors</b>	Max. $\phi$ 5 mm (0.20 in.) (insulated conductors)

\*Refer to the graph for frequency derating characteristics.

<b>Rise time</b>	3.5 ns or less
<b>Output voltage</b>	0.1 V/A
<b>Maximum peak current</b>	50 A peak (non-continuous)
<b>Noise</b>	2.5 mArms or less*

\*Does not apply to devices to which the probe is connected;  
 applicable when used with 20 MHz bandwidth instrument devices

#### Accuracy (amplitude)

to 30 Arms	to 50 A peak
$\pm 1.0\%$ rdg. $\pm 1$ mV	$\pm 2.0\%$ rdg.

The accuracy above is valid within the following conditions:  
 Warm-up time: 30 minutes, operating environment of 23°C  $\pm$  5°C (73°F  $\pm$  9°F) at 80% RH or less, DC or sine wave signals of 45 to 66 Hz, 0 Arms to 5 Arms

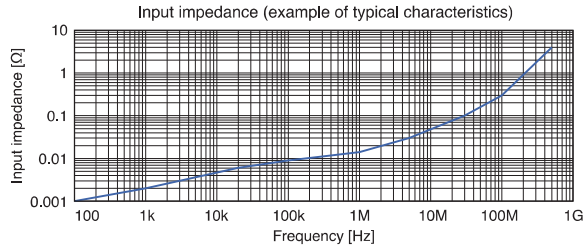
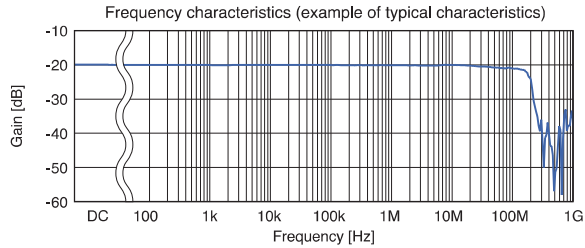
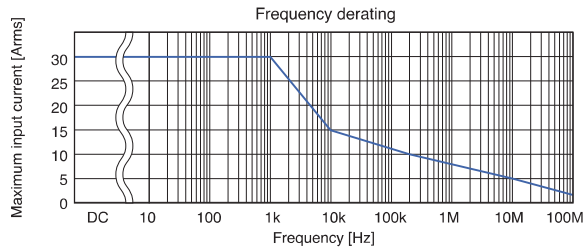

<b>Operating temperature and humidity range</b>	0°C to 40°C (32°F to 104°F), 80% RH or less (no condensation)
<b>Storage temperature and humidity range</b>	-10°C to 50°C (14°F to 122°F), 80% RH or less (no condensation)
<b>Standards</b>	Safety: EN 61010, EMC: EN 61326
<b>Maximum rated power</b>	5.3 VA
<b>Cable length</b>	Sensor cable: 1500 mm (59.06 in.) Power cord: 1000 mm (39.37 in.)
<b>Dimensions</b>	Sensor: 175 mm (6.89 in.) W $\times$ 18 mm (0.71 in.) H $\times$ 40 mm (1.57 in.) D Termination unit: 27 mm (1.06 in.) W $\times$ 55 mm (2.17 in.) H $\times$ 18 mm (0.71 in.) D (excluding BNC connector or protrusions)
<b>Weight</b>	Approx. 240 g (8.5 oz)

### 3274



Product warranty period: 1 year  
Guaranteed accuracy period: 1 year

<b>Rated current*</b>	150 Arms
<b>Frequency band</b>	DC to 10 MHz (-3dB)
<b>Diameter of measurable conductors</b>	Max. $\phi$ 20 mm (0.79 in)(insulated conductors)

\*The accuracy above is valid within the following conditions:  
DC or sine wave signals of 45 to 66 Hz, within maximum peak current for each range

<b>Rise time</b>	35 ns or less
<b>Output voltage</b>	0.01 V/A
<b>Maximum peak current</b>	300 A peak (non-continuous)*1
<b>Noise</b>	25 mArms or less*2

\*1: 500 A peak with pulse width  $\leq$  30  $\mu$ s  
\*2: Does not apply to devices to which the probe is connected;  
when used with a 20 MHz bandwidth instrument devices

#### Accuracy (amplitude)

to 150 A	to 300 A peak
$\pm 1.0\%$ rdg. $\pm 1$ mV	$\pm 2.0\%$ rdg.

The accuracy above is valid within the following conditions:  
Warm-up time: 30 minutes, operating environment of 23°C  $\pm$  5°C (73°F  $\pm$  9°F) at 80% RH or less, DC or sine wave signals of 45 to 66 Hz

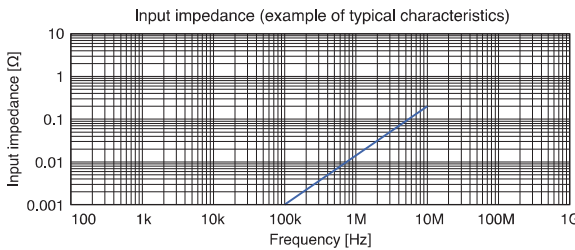
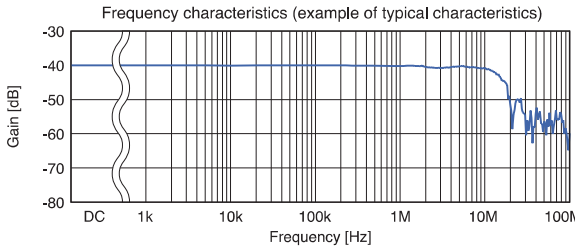
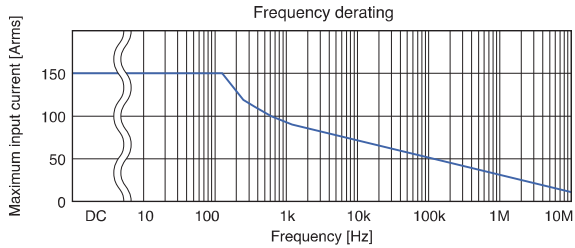

<b>Operating temperature and humidity range</b>	0°C to 40°C (32°F to 104°F), 80% RH or less (no condensation)
<b>Storage temperature and humidity range</b>	-10°C to 50°C (14°F to 122°F), 80% RH or less (no condensation)
<b>Standards</b>	Safety: EN 61010, EMC: EN 61326
<b>Maximum rated power</b>	5.5 VA (continuous maximum input)
<b>Cable length</b>	Sensor cable: 2000 mm (78.74 in.) Power cord: 1000 mm (39.37 in.)
<b>Dimensions</b>	Sensor: 176 mm (6.93 in.) W $\times$ 69 mm (2.72 in.) H $\times$ 27 mm (1.06 in.) D Termination unit: 27 mm (1.06 in.) W $\times$ 55 mm (2.17 in.) H $\times$ 18 mm (0.71 in.) D (excluding BNC connector or protrusions)
<b>Weight</b>	Approx. 500 g (17.6 oz)

### 3275



Product warranty period: 1 year  
Guaranteed accuracy period: 1 year

<b>Rated current*</b>	500 Arms
<b>Frequency band</b>	DC to 2 MHz (-3dB)
<b>Diameter of measurable conductors</b>	Max. $\phi$ 20 mm (0.79 in)(insulated conductors)

\*The accuracy above is valid within the following conditions:  
DC or sine wave signals of 45 to 66 Hz, within maximum peak current for each range

<b>Rise time</b>	175 ns or less
<b>Output voltage</b>	0.01 V/A
<b>Maximum peak current</b>	700 A peak (non-continuous)
<b>Noise</b>	25 mArms or less*

\*Does not apply to devices to which the probe is connected;  
when used with a 20 MHz bandwidth instrument devices

#### Accuracy (amplitude)

to 500 A	to 700 A peak
$\pm 1.0\%$ rdg. $\pm 5$ mV	$\pm 2.0\%$ rdg.

The accuracy above is valid within the following conditions:  
Warm-up time: 30 minutes, operating environment of 23°C  $\pm$  5°C (73°F  $\pm$  9°F) at 80% RH or less, DC or sine wave signals of 45 to 66 Hz

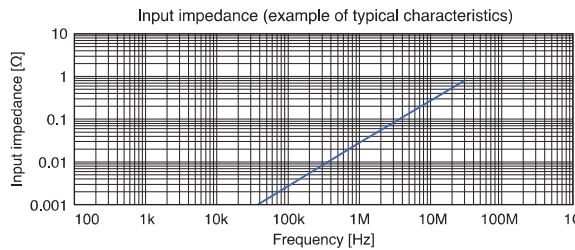
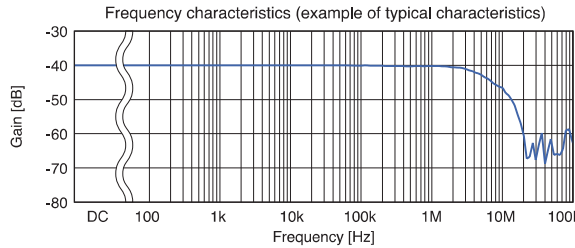
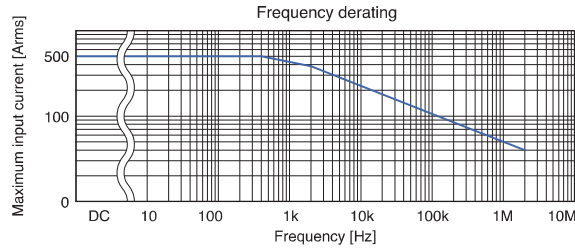

<b>Operating temperature and humidity range</b>	0°C to 40°C (32°F to 104°F), 80% RH or less (no condensation)
<b>Storage temperature and humidity range</b>	-10°C to 50°C (14°F to 122°F), 80% RH or less (no condensation)
<b>Standards</b>	Safety: EN 61010, EMC: EN 61326
<b>Maximum rated power</b>	7.2 VA (continuous maximum input)
<b>Cable length</b>	Sensor cable: 2000 mm (78.74 in.) Power cord: 1000 mm (39.37 in.)
<b>Dimensions</b>	Sensor: 176 mm (6.93 in.) W $\times$ 69 mm (2.72 in.) H $\times$ 27 mm (1.06 in.) D Termination unit: 27 mm (1.06 in.) W $\times$ 55 mm (2.17 in.) H $\times$ 18 mm (0.71 in.) D (excluding BNC connector or protrusions)
<b>Weight</b>	Approx. 520 g (18.3 oz)



High-accuracy measurement (ME15W)		
Pass-through types	Rated current	Frequency range
CT6862-05	50 A	DC to 1 MHz
CT6872	50 A	DC to 10 MHz
CT6872-01	50 A	DC to 10 MHz
CT6863-05	200 A	DC to 500 kHz
CT6873	200 A	DC to 10 MHz
CT6873-01	200 A	DC to 10 MHz
CT6875A	500 A	DC to 2 MHz
CT6875A-1	500 A	DC to 1.5 MHz
CT6904A	500 A	DC to 4 MHz
CT6904A-1	500 A	DC to 2 MHz
CT6904A-2	800 A	DC to 4 MHz
CT6904A-3	800 A	DC to 2 MHz
CT6876A	1000 A	DC to 1.5 MHz
CT6876A-1	1000 A	DC to 1.2 MHz
CT6877A	2000 A	DC to 1 MHz
CT6877A-1	2000 A	DC to 1 MHz
Clamp types	Rated current	Frequency range
9272-05	20 A, 200 A	1 Hz to 100 kHz
CT6841-05	20 A	DC to 1 MHz
CT6843-05	200 A	DC to 500 kHz
CT6844-05	500 A	DC to 200 kHz
CT6845-05	500 A	DC to 100 kHz
CT6846-05	1000 A	DC to 20 kHz
Direct-wired types	Rated current	Frequency range
PW9100A-3	50 A	DC to 3.5 MHz
PW9100A-4	50 A	DC to 3.5 MHz
Connection options		
CT9555	1 ch, external power supply, with waveform output function	
CT9556	1 ch, external power supply, with waveform/RMS output function	
CT9557	4 ch, external power supply, includes waveform/aggregated-waveform/aggregated-RMS output functions	
L9217	Isolated BNC terminals	
9165	Metallic BNC terminals	
CT9904	Used with CT9557 added waveform output	
CT9901	Converts ME15W terminal to PL23 terminal	
CT9902	Used to extend cable length	
Waveform observation (BNC)		
High-sensitivity observation	Rated current	Frequency range
CT6710	0.5 A, 5 A, 30 A	DC to 50 MHz
CT6711	0.5 A, 5 A, 30 A	DC to 120 MHz
Observation of minuscule currents	Rated current	Frequency range
CT6700	5 A	DC to 50 MHz
CT6701	5 A	DC to 120 MHz
Observation of large currents	Rated current	Frequency range
3273-50	30 A	DC to 50 MHz
3276	30 A	DC to 100 MHz
3274	150 A	DC to 10 MHz
3275	500 A	DC to 2 MHz
Connection options		
3269	4 ch, external power supply, total output 2.5 A	
3272	2 ch, external power supply, total output 600 mA	

Grid power quality control (PL14)		
Measurement of load current	Rated current	Frequency range
CT7126	60 A	40 Hz to 2 kHz
CT7131	100 A	40 Hz to 2 kHz
CT7731	100 A	DC to 5 kHz
CT7631	100 A	DC to 10 kHz
CT7736	600 A	DC to 5 kHz
CT7636	600 A	DC to 10 kHz
CT7136	600 A	40 Hz to 5 kHz
CT7742	2000 A	DC to 5 kHz
CT7642	2000 A	DC to 10 kHz
Measurement of large currents	Rated current	Frequency range
CT7044	6000 A	10 Hz to 50 kHz
CT7045	6000 A	10 Hz to 50 kHz
CT7046	6000 A	10 Hz to 50 kHz
Measurement of leakage current	Rated current	Frequency range
CT7116	6 A	40 Hz to 5 kHz
Connection options		
CT9920	Converts PL14 terminal to ME15W terminal	
L9095	Connects CM7290, CM7291 and instrument	
L0220-01	Extends a cable with a PL14 terminal, 2 m (6.56 ft.)	
L0220-02	Extends a cable with a PL14 terminal, 5 m (16.40 ft.)	
L0220-03	Extends a cable with a PL14 terminal, 10 m (32.81 ft.)	
L0220-04	Extends a cable with a PL14 terminal, 20 m (65.62 ft.)	
L0220-05	Extends a cable with a PL14 terminal, 30 m (98.43 ft.)	
L0220-06	Extends a cable with a PL14 terminal, 50 m (164.04 ft.)	
L0220-07	Extends a cable with a PL14 terminal, 100 m (328.08 ft.)	

Grid power quality control (BNC)		
Measurement of load current	Rated current	Frequency range
9694	5 A	40 Hz to 5 kHz
9695-02	50 A	40 Hz to 5 kHz
9660	100 A	40 Hz to 5 kHz
9695-03	100 A	40 Hz to 5 kHz
9010-50	10 A - 500 A*1	40 Hz to 1 kHz
9018-50	10 A - 500 A*1	40 Hz to 3 kHz
9132-50	20 A - 1000 A*2	40 Hz to 1 kHz
9661	500 A	40 Hz to 5 kHz
9669	500 A	40 Hz to 5 kHz
Measurement of large currents	Rated current	Frequency range
CT9667-01	500 A, 5000 A	10 Hz to 20 kHz
CT9667-02	500 A, 5000 A	10 Hz to 20 kHz
CT9667-03	500 A, 5000 A	10 Hz to 20 kHz
Measurement of leakage current	Rated current	Frequency range
9657-10	10 A	40 Hz to 5 kHz
9675	10 A	40 Hz to 5 kHz
Connection options		
9219	Converts crimped terminal to BNC terminal	
L9910	Converts BNC terminal to PL14 terminal	
9704	Converts BNC terminal to banana terminal	

\*1: Can switch between ranges (10, 20, 50, 100, 200, 500 A AC )

\*2: Can switch between ranges (20, 50, 100, 200, 500, 1000 A AC )

Note: Company names and product names appearing in this brochure are trademarks or registered trademarks of various companies.

**HIOKI**  
HIOKI E. E. CORPORATION

**HEADQUARTERS**

81 Koizumi,  
Ueda, Nagano 386-1192 Japan  
<https://www.hioki.com/>



Scan for all  
regional contact  
information

DISTRIBUTED BY