



INSULATION TESTER ST5520/ST5520-01

Safety Standards Measuring Instruments



Industry's Fastest Testing Speed

Unmatched Speeds

Industry-beating test time
Rapidly assess in as fast as 50 ms

High-speed auto discharge function
Quick discharge of residual voltage

Outstanding features

Contact check function
Prevents errors due to poor contact

Freely configurable test voltage
Set from 25 V to 1000 V (1 V resolution)

Short-circuit check function
Stops potential defects from reaching the market



ISO 9001
JMI-0216



ISO14001
JQA-E-90091



www.hioki.com

HIOKI company overview, new products, environmental considerations and other information are available on our website.



2 Unmatched Speeds

Industry's Fastest Testing Speed



The Insulation Tester ST5520 delivers the fastest insulation resistance testing in the industry, meeting all the requirements of production lines thanks to rapid takt times.

Industry-beating test time

Rapidly assess in as fast as 50 ms

Testing is complete in as little as 50 ms — the fastest time in the industry. This is 700 ms faster than legacy Hioki models.

- ★ Discharge time varies according to the sample's capacitance
- ★ The pictured waveform reflects use of a test time of 45 ms
- ★ The waveform shows the test result for a 9 M Ω , 10 pF sample

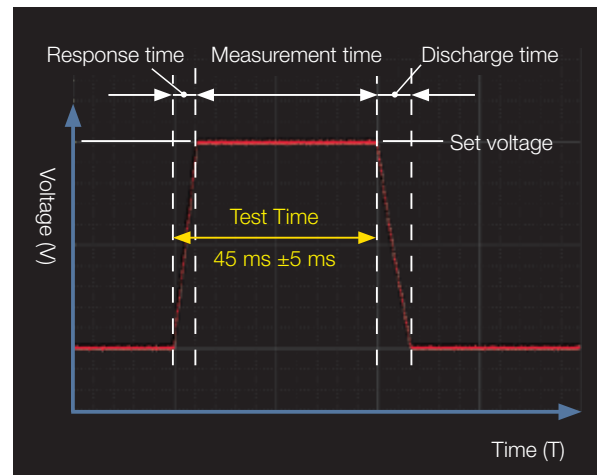

Applied Voltage Waveform at Fastest Test Time

High-speed auto discharge function

Quickly discharge residual voltage

The post-test residual voltage discharge time has been reduced significantly compared with legacy models. As a result, when comparing an identical sample under the following conditions, a takt time improvement of 990 ms is estimated.

- ★ Discharge time varies according to the sample's capacitance
- ★ The waveform shows the test result for a 9 M Ω , 10 pF sample

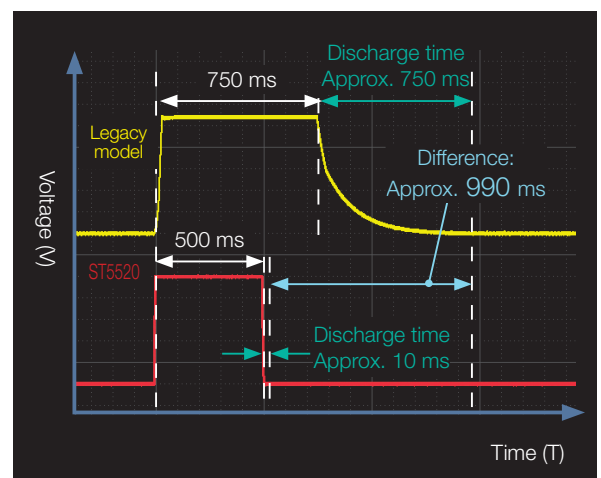

Comparison of Discharge Time with Previous Model

Outstanding features

Contact check function

Prevents errors due to poor contact

The contact check function allows you to check that proper contact has been made with the device under test prior to the testing. This ensures that resistance testing is not carried out without proper contact, as this can result in erroneous assessment.

There are two methods: 4-wire contact check and comparator contact check.



4 - Wire Contact Check

Continuity between the low contact check terminal and the low output terminal, and between the high contact check terminal and the high output terminal, is verified.

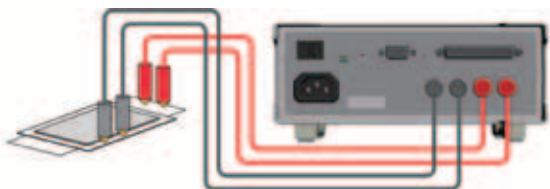

Comparator Contact Check

If the comparator result exceeds a previously set upper limit after a normal connection, the instrument reports an “upper fail,” indicating a contact failure.

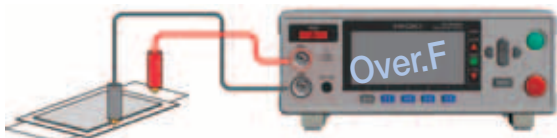

Freely configurable test voltage

Configure from 25 V to 1000 V (1 V resolution)

In insulation resistance testing of lithium-ion and other batteries, the specific test voltage used varies with the manufacturer. In addition, the test voltage for electronic components, such as relays and connectors, is likely to change in the future along with revisions to various standards. ST5520 allows the test voltage to be freely configured.

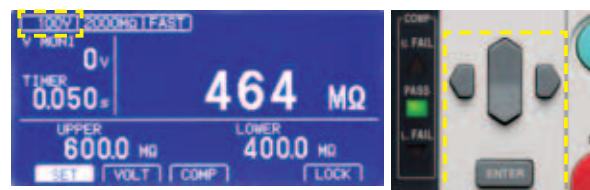

The test voltage can be changed simply by pressing the keys and verified on the screen.



With legacy models...

Legacy products provided a smaller number of choices, for example 25 V / 50 V / 100 V / 250 V / 500 V / 1000 V.

25 V/50 V/100 V/250 V/500 V/1000 V



Short-circuit check function

Stops potential defects from reaching the market

With this function, a low voltage (2 V to 4 V DC) is applied to the test patterns to check for micro-shorting prior to insulation testing.

If insulation testing is performed incorrectly, remaining protrusions could cause issues after the product ships.

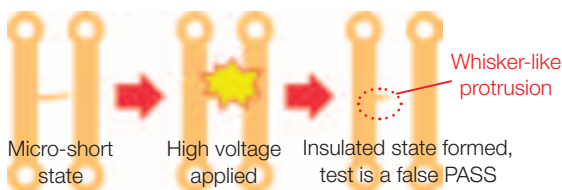

Switched Probe

Safe, easy operation at your fingertips

The use of optional Switched Probe 9299 lets you to operate the ST5520 while holding the probe.



Comparator Function

Freely set upper and lower limit values

You can select from three types: upper limit, lower limit and upper-lower limit value assessment. Comparator operation can also be delayed for a certain period of time by specifying the preferred response time.



Panel Save/Load Function

Saving and loading measurement conditions

Up to ten measurement conditions can be saved, and they are retained even if the power supply is off. The saved conditions can be loaded via key operation, RS-232C and EXT. I/O.

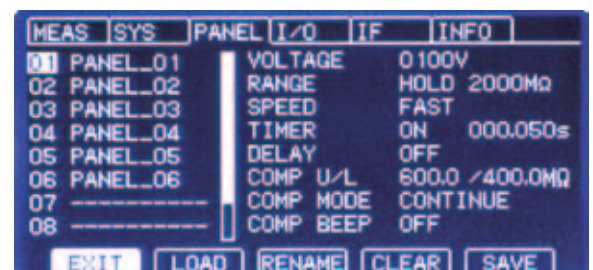

External interfaces

Compatible with 38400 bps transmission speed

Built-in RS-232C interface

Use the RS-232C interface to capture measurement and assessment results from a PC, PLC or other system. The ST5520 is also equipped with a "data output function" for automatically sending the measurement values and assessment results at the end of each test.

RS-232C Specifications

Transmission method	Communication method: Full duplex Synchronization method: Asynchronous
Transmission speed	9600 bps (default)/19200 bps/38400 bps
Data length	8-bit
Parity	N/A
Stop bit	1-bit
Message terminator (delimiter)	Receiving: CR+LF, CR/sending: CR+LF
Flow control	N/A
Electrical Specifications	Input voltage level 5 to 15 V: ON, -15 to -5 V: OFF Output voltage level 5 to 9 V: ON, -9 to -5 V: OFF
Connector	Interface connector pin arrangement (D-sub9 pin, male-type fixing screws #4-40) I/O connector specifications: terminal (DTE) Recommended cables: RS-232C Cable 9637 (for PC) RS-232C Cable 9638 (D-sub25 pin for connector)

Flexible support for control circuits

NPN/PNP switch

All signals are isolated using a photocoupler. (The input/output common terminal is shared). The input circuit can be switched to support current sinking output (NPN) or current sourcing output (PNP) by configuring the switch.

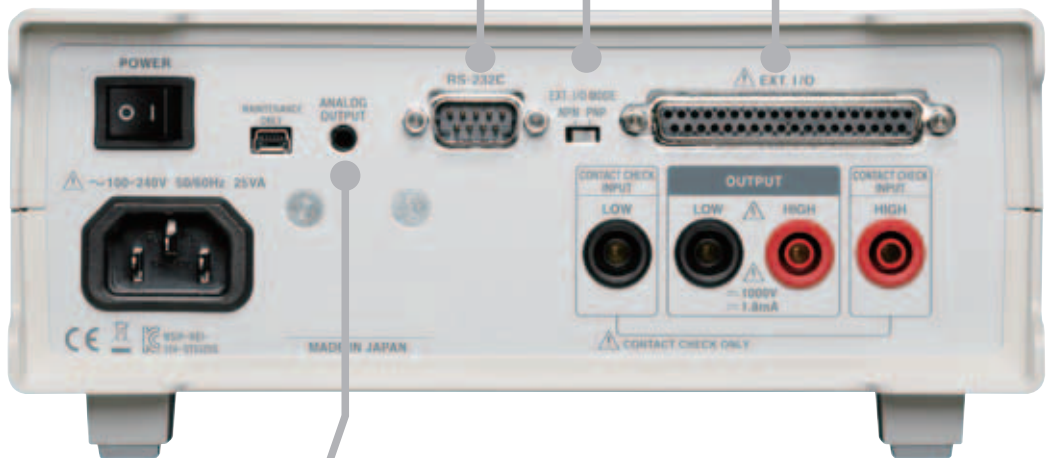

Recording time variation

Analog output of measurement values

During testing, analog output is generated at the same timing as the instrument's measured value display. Once the test is complete, the instrument will continue to output the last voltage through its analog output terminal.

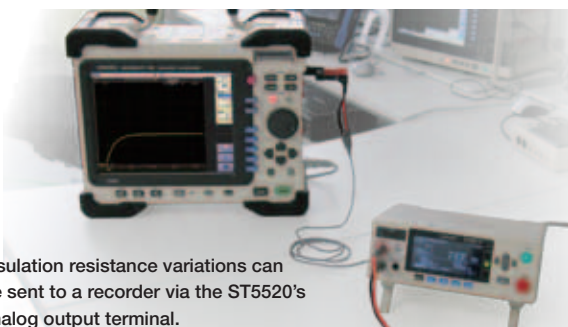

Insulation resistance variations can be sent to a recorder via the ST5520's analog output terminal.

Output 0 to 4 V within full range of measurements [FULL]

Test voltage	Displayed resistance value	Output voltage (DC)
$25\text{ V} \leq V < 100\text{ V}$	0.000 M Ω to 200.0 M Ω	0 to 4 V
$100\text{ V} \leq V < 500\text{ V}$	0.000 M Ω to 2000 M Ω	0 to 4 V
$500\text{ V} \leq V \leq 1000\text{ V}$	0.000 M Ω to 4000 M Ω	0 to 4 V
Full resistance range	Over.F	4 V
	Under.F	0 V

Output voltage according to each resistance range [EACH]

Resistance range	Displayed resistance value	Output voltage (DC)
2 M Ω	0.000 M Ω to 2.000 M Ω	0 to 4 V
20 M Ω	1.90 M Ω to 20.00 M Ω	0.38 to 4 V
200 M Ω	19.0 M Ω to 200.0 M Ω	0.38 to 4 V
2000 M Ω (100 to 499 V)	190 M Ω to 2000 M Ω	0.38 to 4 V
4000 M Ω (500 to 1000 V)	190 M Ω to 4000 M Ω	0.19 to 4 V
Full resistance range	Over.F	4 V
	Under.F	0 V

Also available with BCD output
I/O terminals for external control

Control I/O signal no. table

ST5520/ST5520-01

Pin	Signal name	I/O	Function	Logic
1	START	IN	Start measurement	Edge
2	(Not used)	-	-	-
3	INTERLOCK	IN	Interlock	Level
4	LOAD1	IN	Select panel number	Level
5	LOAD3	IN	Select panel number	Level
6	(Not used)	-	-	-
8	ISO_5V	-	Isolated mains +5V (-5V) output	-
9	ISO_COM	-	Isolated mains common	-
10	ERR	OUT	Contact check error Short circuit check error Output voltage error	Level
11	UPPER FAIL	OUT	Comparator Assessment	Level
12	LOWER FAIL	OUT	Comparator Assessment	Level
20	STOP	IN	End measurement	Edge
21	(Not used)	-	-	-
22	LOAD0	IN	Select panel number	Level
23	LOAD2	IN	Select panel number	Level
27	ISO_COM	-	Isolated mains common	-
28	TEST	OUT	Measuring	Level
30	PASS	OUT	Comparator Assessment	Level

ST5520-01 (BCD function)

Pin	Signal name	I/O	Function	Logic
7	BCD0	OUT	BCD	Level
13	BCD1	OUT	BCD	Level
14	BCD2	OUT	BCD	Level
15	BCD3	OUT	BCD	Level
16	BCD4	OUT	BCD	Level
17	BCD5	OUT	BCD	Level
18	BCD6	OUT	BCD	Level
19	BCD7	OUT	BCD	Level
24	DP0	OUT	Decimal output	Level
25	DP1	OUT	Decimal output	Level
26	DP2	OUT	Decimal output	Level
29	BCD8	OUT	BCD	Level
31	BCD9	OUT	BCD	Level
32	BCD10	OUT	BCD	Level
33	BCD11	OUT	BCD	Level
34	BCD12	OUT	BCD	Level
35	BCD13	OUT	BCD	Level
36	BCD14	OUT	BCD	Level
37	BCD15	OUT	BCD	Level

ST5520 pin arrangement

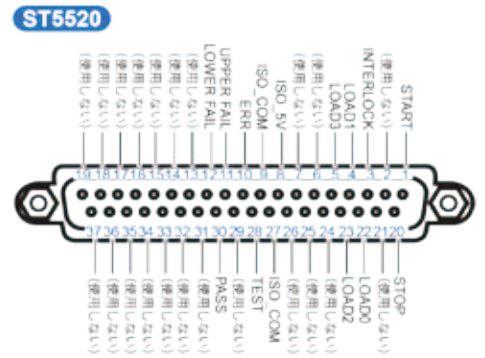

ST5520-01 pin arrangement

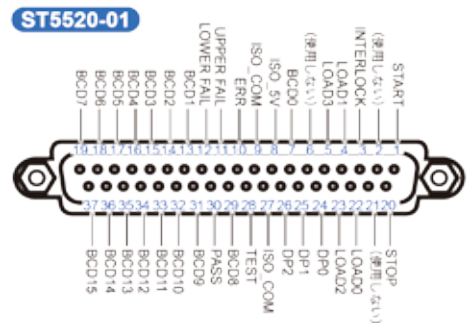

ST5520 timing chart

Content		Time
t1	START, STOP signal pulse width	5 ms MIN.
t2	START, STOP signal detection time	5 ms MAX.*
t3	Response time (DELAY)	AUTO, 5 ms to 999.9 s
t4	Measurement time	Contact check: OFF 30 ms (FAST), 480 ms (SLOW) Contact check: ON 80 ms (FAST), 480 ms (SLOW)
	Measurement interval	Contact check: OFF 50 ms (FAST), 500 ms (SLOW) Contact check: ON 100 ms (FAST), 500 ms (SLOW)
t5	Discharge time (time until output voltage is 10 V or lower)	20 ms MAX. (When measuring pure resistance)*

*If the START signal is input after the test voltage is changed, the START signal detection time will increase by a maximum of 500 ms.

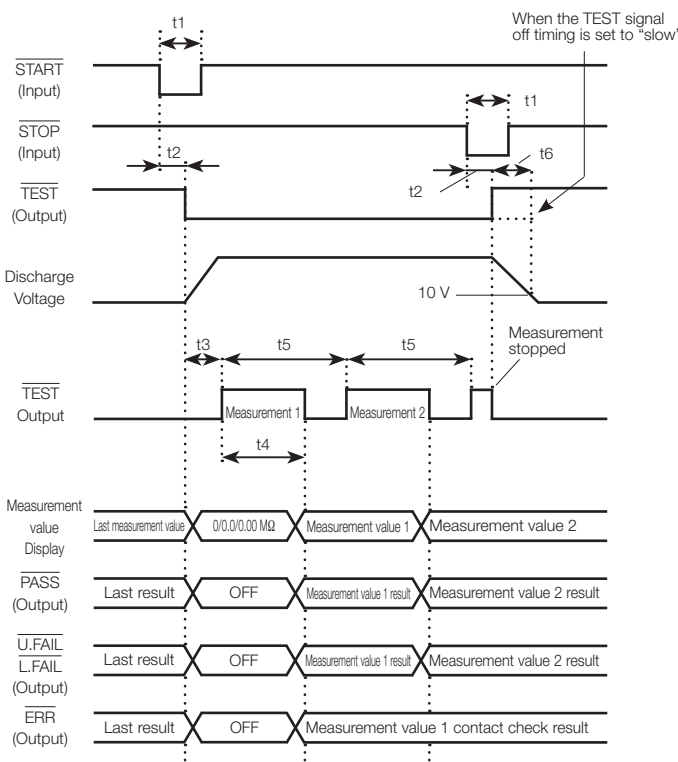

Checking the Control I/O Signal No.

EXT. I/O Test & Monitoring Function

The output signal can be switched ON or OFF manually, and the output signal state can be viewed on-screen.

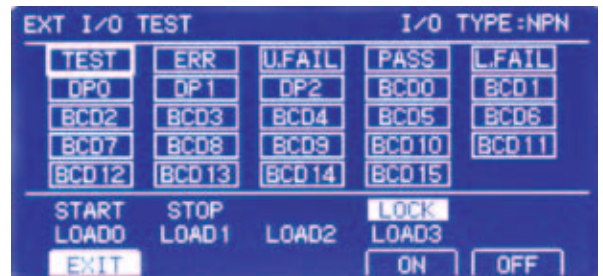

Checking and controlling voltage during discharge

Setting the TEST signal OFF timing

You can choose between the following two settings to determine the timing at which the EXT I/O TEST signal output returns from low to high at the completion of testing:

[SLOW]: The low signal (the same as during testing) is maintained until the voltage of the device under test falls to about 10 V as a result of the operation of the discharge function.

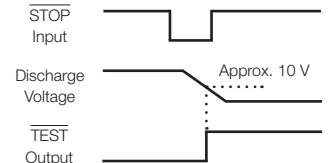

[FAST]: The signal returns to high at about the same time as the test is completed.

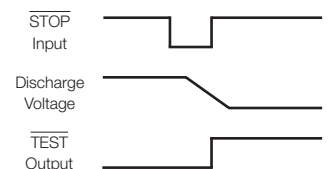

ST5520 Specifications

Accuracy warranty period: 1 year

Specifications	
Measurement items	Insulation resistance (DC voltage application method)
Output voltage	25 V to 1000 V (user-configurable), 1 V resolution
Sampling	FAST: 30 ms/time, SLOW: 500 ms/time (switch)
Memory function	Saved items: rated measurement voltage, comparator upper limit/lower limit values, test mode, beep sound to distinguish the result, test time, response time, resistance range, measurement speed Memory capacity: up to 10 items (can be saved/loaded)
Test modes	Continuous mode, PASS STOP mode, FAIL STOP mode, force quit assessment mode (switchable)
Check function	Contact check function (ON/OFF) Short-circuit check function (ON/OFF)
Operating temperature / humidity range	0°C to 40°C, 80% rh or lower (non-condensing)
Storage temperature/ humidity range	-10°C to 50°C, 80% rh or lower (non-condensing)
Guaranteed accuracy temperature/humidity range	23°C ±5°C, 80% rh or lower (non-condensing)
Usage location	Indoor use, pollution degree 2, up to a height of 2000 m
Rated power supply voltage	100 V AC to 240 V ±10%
Rated power supply frequency	50/60 Hz
Max. rated power	25 VA
Withstand voltage	1.62 kV AC (sensed current 10 mA) 1 min Between power supply LN (together) and protective grounding terminal
Excessive input protection	1100 V DC (positive polarity only)

Dimensions	215 (8.46 in) W x 80 (3.15 in) H x 166 (6.54 in) D mm (excluding protruding parts)
Mass	1.1 kg ± 0.1 kg (38.8 oz ± 3.5 oz)
Compliant Standards	Safety EN61010 EMC EN61326 Class A EN61000-3-2, EN61000-3-3
Accessories	Instruction manual, power cord, EXT. I/O connector (male), connector cover (one of each)

Comparator Function	
Assessment	UPPER_FAIL, PASS, LOWER_FAIL, UL_FAIL UPPER_FAIL: Measured value ≥ upper limit value PASS: Upper limit value > measured value > lower limit value LOWER_FAIL: Measured value ≤ lower limit value UL_FAIL: Unable to assess
Assessment Process	Beep sound, PASS/U.FAIL/L.FAIL light up on LED display When UL_FAIL, U.FAIL/L.FAIL light up simultaneously EXT. I/O output, assessment result can be obtained via RS-232C

Test duration	
Definition of test duration	Test duration = Response time + Measurement time
Function	Set the time from voltage application until pass/fail assessment
Configuration range	0.045 s to 999.999 s (0.001 s resolution)







Response time timer function	
Function	The response time is the time during which comparator assessment operation is prohibited from the start of the test until the set response time has elapsed. No measurement values are displayed during the response time. The response time is included in the test time.
Configuration range	0.005 s to 999.999 s (0.001 s resolution)

Measurement voltage/resistance range (can be switched between Auto Range/Manual Range)					
Rated measurement voltage	Resistance range	Max. display	Resolution	Guaranteed accuracy range	Accuracy
					FAST/SLOW
25 V ≤ V ≤ 100 V	2 MΩ	4.000 MΩ	0.001 MΩ	0.000 MΩ to 2.000 MΩ	±2%rdg.±5dgt.
	20 MΩ	40.00 MΩ	0.01 MΩ	1.90 MΩ to 20.00 MΩ	
	200 MΩ	400.0 MΩ	0.1 MΩ	19.0 MΩ to 200.0 MΩ	
100 V ≤ V ≤ 500 V	2 MΩ	4.000 MΩ	0.001 MΩ	0.000 MΩ to 2.000 MΩ	±2%rdg.±5dgt.
	20 MΩ	40.00 MΩ	0.01 MΩ	1.90 MΩ to 20.00 MΩ	
	200 MΩ	400.0 MΩ	0.1 MΩ	19.0 MΩ to 200.0 MΩ	±5%rdg.
	2000 MΩ	4000 MΩ	1 MΩ*	19.0 MΩ to 2000 MΩ	
500 V ≤ V ≤ 1000 V	2 MΩ	4.000 MΩ	0.001 MΩ	0.000 MΩ to 2.000 MΩ	±2%rdg.±5dgt.
	20 MΩ	40.00 MΩ	0.01 MΩ	1.90 MΩ to 20.00 MΩ	
	200 MΩ	400.0 MΩ	0.1 MΩ	19.0 MΩ to 200.0 MΩ	
	4000 MΩ	9990 MΩ	1 MΩ*	19.0 MΩ to 4000 MΩ	±5%rdg.
				4010 MΩ to 9990 MΩ	±25%rdg.

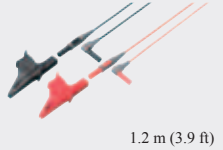
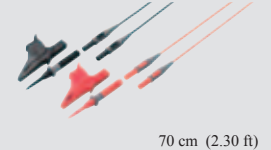
*When displaying 1000 MΩ and above, resolution of 10 MΩ with rightmost digit set to 0

Models INSULATION TESTER ST5520 INSULATION TESTER ST5520-01 (with BCD output)

Options

Product image							
	1.2 m (3.9 ft)	70 cm (2.30 ft)	80 cm (2.62 ft)	1.5 m (4.92 ft)		1.8 m (5.91 ft)	1.8 m (5.91 ft)
Model name	Connection Cord	Test Lead	Switched Probe	Output Cord (analog output)	Conversion Adaptor (BNC-banana plug female)	RS-232C Cable	
						9pin-9pin/cross	9pin-25pin/cross
Model No.	L9257	L2200	9299	9094	9199	9637	9638

*Test Lead L2200 can be extended. Please contact your nearest HIOKI distributors.

Note: Company names and Product names appearing in this catalog are trademarks or registered trademarks of various companies.

HIOKI

HIOKI E. E. CORPORATION

HEADQUARTERS:

81 Koizumi, Ueda, Nagano, 386-1192, Japan
TEL +81-268-28-0562 FAX +81-268-28-0568
http://www.hioki.com / E-mail: os-com@hioki.co.jp

HIOKI USA CORPORATION:

TEL +1-609-409-9109 FAX +1-609-409-9108
http://www.hiokiusa.com / E-mail: hioki@hiokiusa.com

HIOKI (Shanghai) SALES & TRADING CO., LTD.:

TEL +86-21-63910090 FAX +86-21-63910360
http://www.hioki.cn / E-mail: info@hioki.com.cn

HIOKI INDIA PRIVATE LIMITED:

TEL +91-124-6590210 FAX +91-124-6460113
E-mail: hioki@hioki.in

HIOKI SINGAPORE PTE. LTD.:

TEL +65-6634-7677 FAX +65-6634-7477
E-mail: info-sg@hioki.com.sg

HIOKI KOREA CO., LTD.:

TEL +82-42-936-1281 FAX +82-42-936-1284
E-mail: info-kr@hioki.co.jp

DISTRIBUTED BY