

PWM-011 Window Mount Kit for 10" and 15" Signboards

Quick Start Guide

This quick guide provides a quick walkthrough of the set up process to IAdea window mount kit.

Technical Spec

Parts	Description
Net Weight (g)	533
Dimension (mm)	
L-shape mount	258.5 x 133.8 x 10
VESA plate	115 x 128 x 7.5
Screw types	M3 x 6L M4 x 8L 9Ø 8#-18*1/2" (12.75L)
Material	Metal
Compatible IAdea signboards	XDS-1078 XDS-1088 series XDS-1588 series

Product Photos



Front view with 10-inch



Back view with 15-inch

Box Content

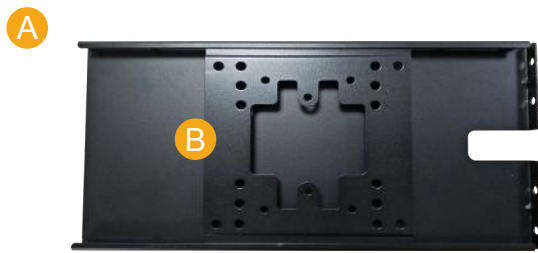

Item	Parts	Q'ty
A	L-shape mount	1
B	VESA plate	1
C	Screw (M3 x 6L)	4
D	Screw (M4 x 8L)	4
E	Screw (9Ø 8#-18*1/2" (12.75L))	4



Preparation

Make sure to leave enough window frame above where the bracket will be mounted so, the power cable and/or Ethernet cable can be fed from the top of the window frame. Tools required for installation:

- Isopropyl wipe
- Fine tip permanent marker
- Utility knife
- Battery powered drill / driver
- Philips drill bit
- Philips hand held screw driver
- Hole saw able to drill through aluminum and big enough to pull a Ethernet cable

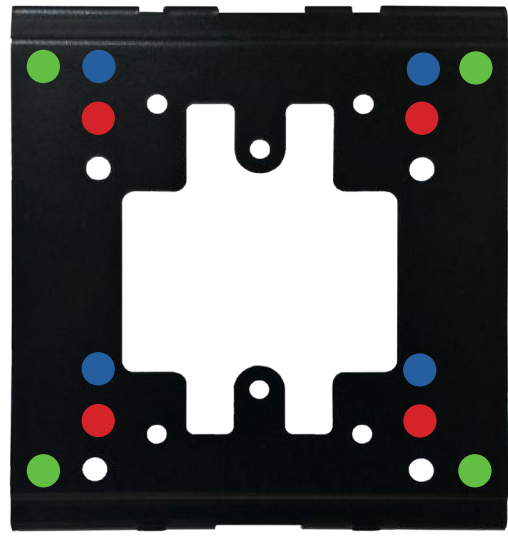
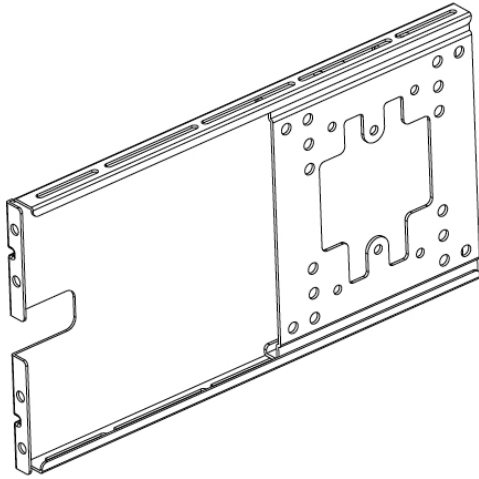
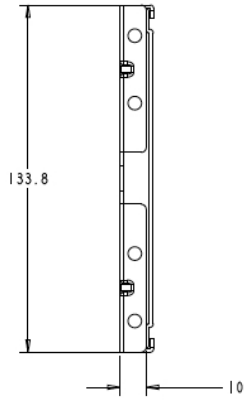

Model	Color	VESA
XDS-1078	Red ●	75 mm x 75 mm
XDS-1088 series	Blue ●	75 mm x 75 mm
XDS-1588 series	Green ●	100 mm x 100 mm

** XDS-1078 and XDS-1088 series uses separate 75 mm x 75 mm alignments to accommodate for the difference in the built-in VESA position. Please follow the specified plate alignment illustrated above to ensure cables are properly hidden when mounted.

1 Place the bracket (Parts A) against the desired spot on the frame and mark the spaces which the top and bottom edge of the bracket sits on the silicon stripe with a marker. Use a utility knife to remove the silicon sealant in the area you marked.

2 Place the bracket (Parts A) back in space where the silicon sealant has been removed. Fit the bracket as firmly to the window frame as possible to minimize the extra space between the bracket and glass. Use a marker to trace a circle for boring a hole big enough to pull a Ethernet cable through onto the window frame.

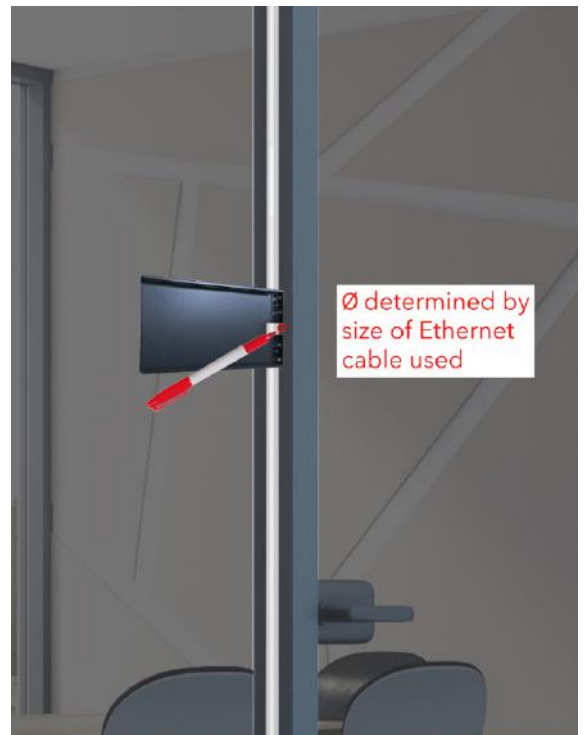
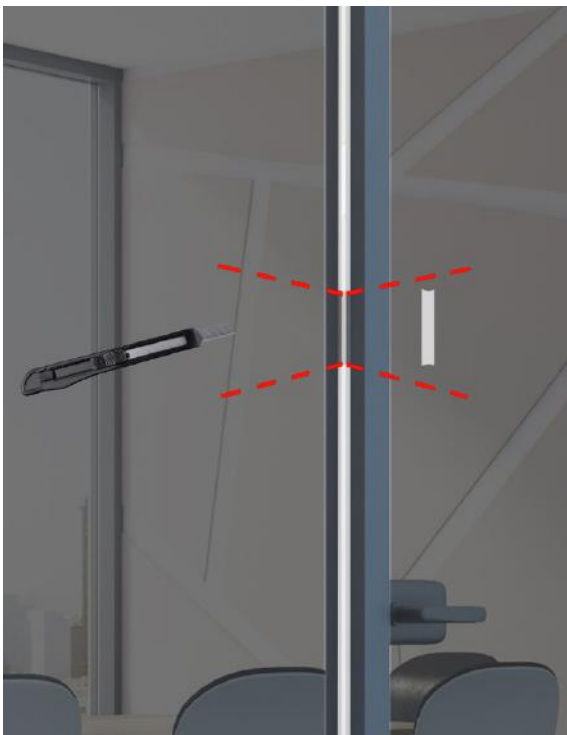

- 3 Bore out the circle traced on the window frame with an appropriate drill bit attached to a power drill. Move up to the window frame corner directly above the intended mounting space and bore out a hole big enough to insert a Ethernet cable.

This corner hole is for feeding the Ethernet cable to the window mounted signboard when running and hiding the cable along the top of the window frame.

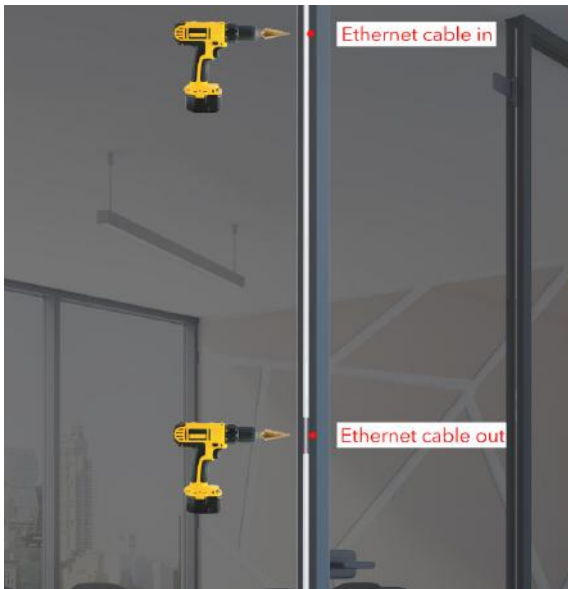

- 4 On the window, clean the area where the bracket will be mounted with a isopropyl wipe and keep the area clean when installing.

Peel off the protective film of the adhesive taping at the window-contacting side of the bracket. Carefully align the bracket to the intended-mounting spot and the bored hole for pulling a Ethernet cable. Pressed the bracket firmly on to the window.

The bracket should be holding itself up.



- 5 With a power drill and a Phillips drill bit, drill in the window frame screw (9Ø 8#-18*1/2" (12.75L)) (Parts E) through the 4 x 4 mm holes to secure the bracket on to the window frame. A minimum of 2 window frame screws are needed to hold up the bracket.

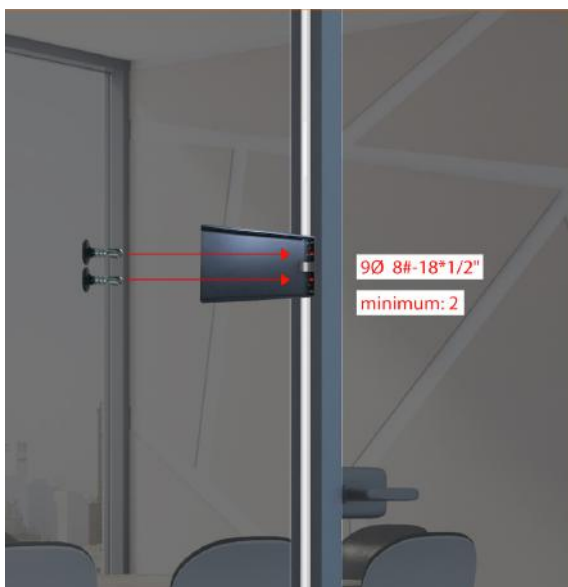

- 6 Feed the Ethernet cable from the feeding hole at the top of the window frame to the window mounted bracket. Pull the hanging cable end out of the hole bored for connecting the display.

Make sure to leave sufficient amount of cable length for installing the signboard onto the bracket. Secure the cable running along the top of the window frame.



- 7 Attached the signboard onto the VESA plate (Parts B) using M4 x 8L screws (Parts D) the model specific alignment illustrated in the earlier pages.

Connect the fed Ethernet cable to the signboard.

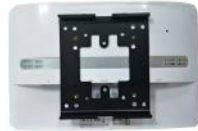

XDS-1078



XDS-1088



XDS-1588

- 8 Carefully slide the VESA plate into the bracket from the end of the on-window portion of the bracket until reaching the desired distance from the window frame. Stuff the excess cable back into the hole.

Screw in the M3 x 6L (Parts C) with a Phillips screw driver, at the top and bottom of the VESA plate to properly secure the plate onto the bracket rails.



Top view



Bottom view

**This window mount kit quick start guide assumes the installer is using the 10" and 15" signboard's built-in PoE feature and a Ethernet cable as the source of power for powering the mounted signboard.

In the case where the mounted signboard requires a power cord to connect to power, please arrange for an additional power cord in the steps involving cabling while following the instructions in the previous pages.