



FM PLUS P SERIES IR CAMERA QUICK START GUIDE

**THIS SYSTEM IS INTENDED TO BE USED ADJUNCTIVELY
NOT AS A STANDALONE DEVICE**

ICI cameras fall under US Federal Law and Export Control.

2105 W. Cardinal Dr. Beaumont, TX 77705
Phone: (409) 861-0788
Toll Free: (866) 861-0788
infraredcameras.com
support@infraredcameras.com
We Are IR™

©Copyright 2021, Infrared Cameras, Inc. - All rights reserved. The contents of this document may not be reproduced in whole or in parts without the written consent of the copyright owner.

Printed in the United States of America.

2105 W. Cardinal Dr.
Beaumont, TX 77705
(866) 861-0788
www.infraredcameras.com

Revision: 2.2021-001

THE MANUFACTURER RESERVES THE RIGHT TO ALTER THE SPECIFICATIONS OF THE PRODUCT WITHOUT PRIOR NOTIFICATION. THE MANUFACTURER ALLOWS HIMSELF THE RIGHT TO MODIFY WITHOUT ANY PRELIMINARY OPINION THE TECHNICAL SPECIFICATIONS OF THE PRODUCT. THIS MANUAL MAY CONTAIN TECHNICAL INACCURACIES OR TYPOGRAPHICAL ERRORS.

NOTICE ALL STATEMENTS, INFORMATION, AND RECOMMENDATIONS IN THIS MANUAL ARE BELIEVED TO BE ACCURATE BUT ARE PRESENTED WITHOUT WARRANTY OF ANY KIND. NOTWITHSTANDING ANY OTHER WARRANTY HEREIN, ALL DOCUMENT FILES AND SOFTWARE ARE PROVIDED "AS IS" WITH ALL FAULTS. ICI DISCLAIMS ALL WARRANTIES, EXPRESSED OR IMPLIED, INCLUDING, WITHOUT LIMITATION, THOSE OF MERCHANTABILITY, FITNESS FOR A PARTICULAR PURPOSE AND NONINFRINGEMENT OR ARISING FROM A COURSE OF DEALING, USAGE, OR TRADE PRACTICE.

THE SOFTWARE LICENSE AND LIMITED WARRANTY FOR THE ACCOMPANYING PRODUCT ARE SET FORTH IN THE INFORMATION PACKET THAT SHIPPED WITH THE PRODUCT AND ARE INCORPORATED HEREIN BY THIS REFERENCE. IF YOU ARE UNABLE TO LOCATE THE SOFTWARE LICENSE OR LIMITED WARRANTY, CONTACT YOUR ICI REPRESENTATIVE FOR A COPY.

IN NO EVENT SHALL ICI BE LIABLE FOR ANY INDIRECT, SPECIAL, CONSEQUENTIAL, OR INCIDENTAL DAMAGES, INCLUDING, WITHOUT LIMITATION, LOST PROFITS OR LOSS OR DAMAGE TO DATA ARISING OUT OF THE USE OR INABILITY TO USE THIS MANUAL, EVEN IF ICI HAS BEEN ADVISED OF THE POSSIBILITY OF SUCH DAMAGES.

Package Includes

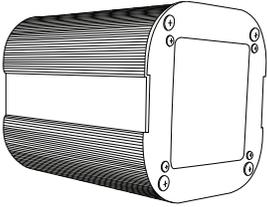

Temperature Reference

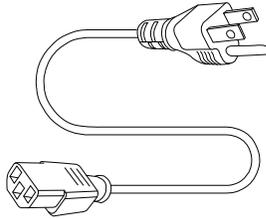

Power Cord x2



Power Adapter

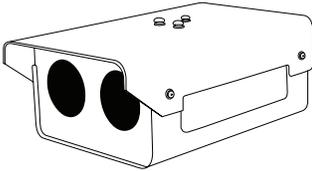

FM Series IR Camera

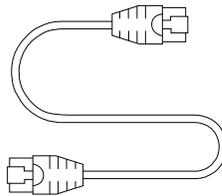

Ethernet Cable

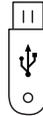

Software USB Drive

ENSURE ALL SYSTEM EQUIPMENT AND COMPONENT ITEMS ARE PRESENT BEFORE BEGINNING INSTALLATION

Set Up

SELECT AN APPROPRIATE AREA FREE OF IMMEDIATE AIRFLOW FROM DOORWAYS AND AIR CONDITIONING/VENTILATION SYSTEMS. THE SELECTED AREA SHOULD HAVE A STABLE AMBIENT TEMPERATURE BETWEEN 20 °C AND 24 °C AND RELATIVE HUMIDITY RANGE FROM 10% TO 50%.

A.

Mount the Temperature Reference to a tripod using the 1/4-20 mount.

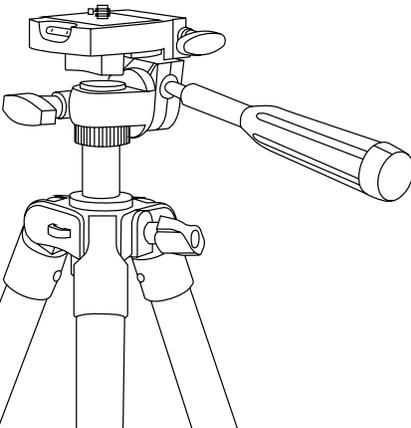
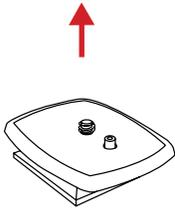
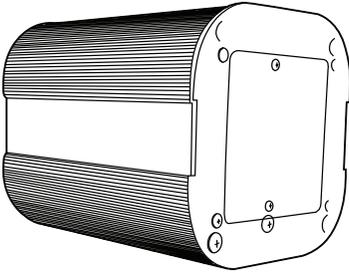

B.

Plug power cord into Temperature Reference.

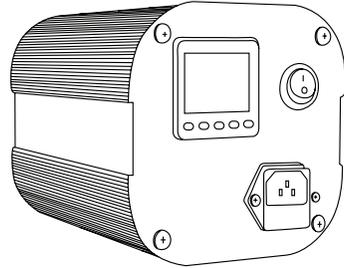

C.

Plug power cord into a 110/120V electrical outlet.

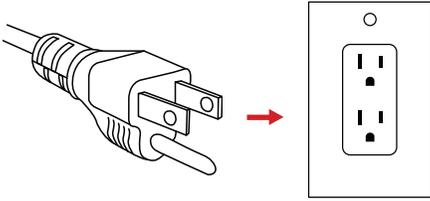

D.

Mount the FM+ Series IR Camera to a tripod using the 1/4-20 mount.

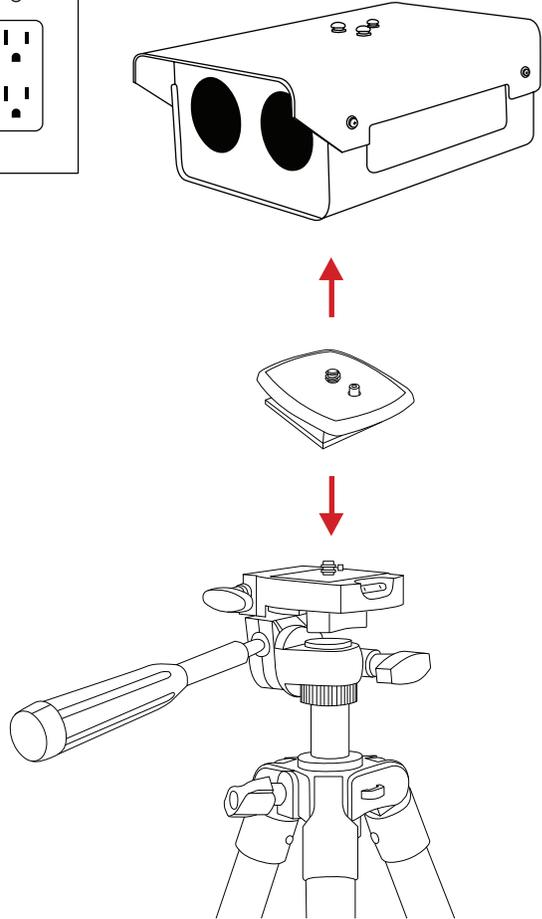

MAKE SURE TRIPODS DO NOT BLOCK THE DIRECT PATH OF PERSON(S) TO BE IMAGED TO ENSURE THE EQUIPMENT WILL NOT BE MOVED OR KNOCKED DOWN. USING A DIVIDING BARRIER WILL HELP KEEP TRIPODS SEPARATE FROM THE PATH.

E.

Plug one end of the Ethernet cable into the FM+ Series IR Camera Ethernet port cable.

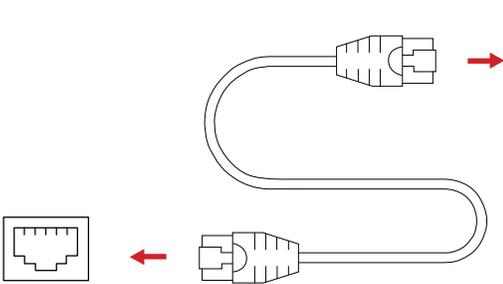

F.

Plug the other end of the Ethernet cable into a computer Ethernet port.

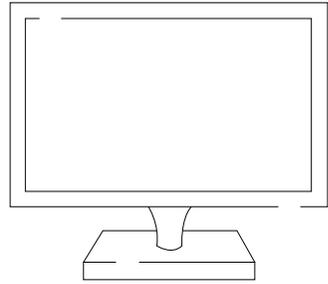

G.

Plug power cord into the power adapter.

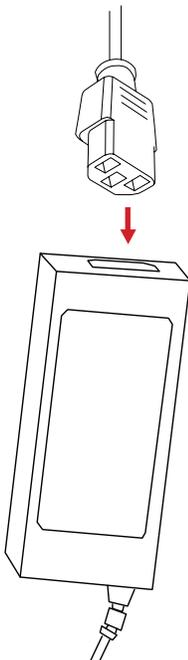

H.

Plug the power adapter into FM+ Series IR Camera barrel connector.

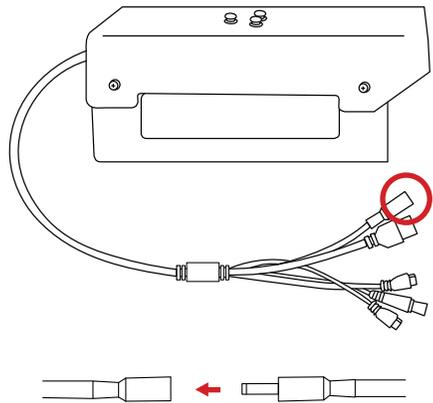

ENSURE THE CAMERA LENS AND TEMPERATURE REFERENCE SOURCE ARE FACING EACH OTHER ON PARALLEL PLANES. MAKE SURE CAMERA TARGET AREA IS FACING A NON-REFLECTIVE BACKGROUND.

I.

Plug power cord into a 110/120V electrical outlet.

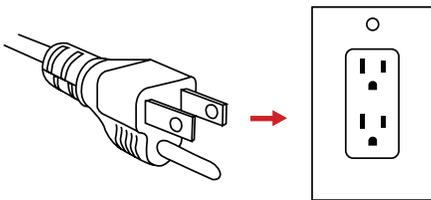

J.

Power on devices.

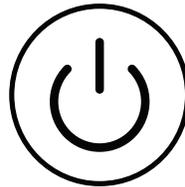

ALLOW AT LEAST 45 MINUTES FOR THE TEMPERATURE REFERENCE SOURCE TO WARM UP. THIS WILL PROVIDE THE MOST ACCURATE SKIN TEMPERATURE MEASUREMENTS.

SOFTWARE ARRIVES INSTALLED ON COMPUTERS AND TABLETS PURCHASED FROM ICI AS COMPLETE SYSTEMS AND IT WILL LAUNCH AUTOMATICALLY ON STARTUP. AFTER THE SOFTWARE LAUNCHES THE USER SHOULD ENSURE THE TARGET ZONE IS IN VIEW OF THE CAMERA AND THE TEMPERATURE REFERENCE SOURCE IS POSITIONED OFF CENTER TO KEEP THE PERSON BEING IMAGED AS CENTERED AS POSSIBLE.

Software

Software arrives installed on computers and tablets purchased from ICI as complete systems and it will launch automatically on startup. A copy of the software is provided on the Software USB Drive. Documentation can be found online on the IR Flash STM web page under the Downloads section or at this address:

<https://infraredcameras.com/ir-flash-stm-manual/>

Recommended System Requirements

- **Processor:** i5 or above (Quad Core or better)
- **RAM:** 4 GB or above
- **OS:** Windows 8/8.1/10
- **Hard Drive:** 256 GB or above
- **Resolution:** 1920 x 1080

CRITICAL INFORMATION

- The technology should be used to measure only one subject's temperature at a time.
- Measurements should not be solely, or primarily, relied upon to diagnose or exclude a diagnosis of any disease.
- Elevated body temperature should be confirmed with secondary evaluation methods (e.g., an NCIT or clinical grade contact thermometer).
- Signage should instruct for the removal of glasses, headwear, and masks.
- Read the current government guidance regarding the use of telethermographic systems for skin temperature measurements. Additional information can be found by reading IEC 80601-2-59:2017 Medical electrical equipment — Part 2-59: Particular requirements for the basic safety and essential performance of screening thermographs for human febrile temperature screening and ISO/TR 13154:2017 Medical electrical equipment - Deployment, implementation and operational guidelines for identifying febrile humans using a screening thermograph.

CRITICAL INFORMATION

ABOUT ICI / CONTACT

Infrared Cameras, Inc.
2105 W. Cardinal Dr.
Beaumont, TX 77705

Phone: (409) 861-0788 | Toll Free: (866) 861-0788 | International: (409) 861-0788

General Inquiry: support@infraredcameras.com

Website: www.infraredcameras.com

You may reach a representative by phone or email Mon – Fri 8:00AM - 5:00PM CST.

ICI manufactures complete systems and software. We can provide complete engineering, software, and OEM solutions. Our Fortune 500 clients rely on us for infrared equipment and thermography training (which we offer through the Infrared Training Institute).

In addition to providing custom germanium, silica, and sapphire optics, we also build windows for enclosures, as well as custom pan and tilt units. We can even provide customizable explosion-proof systems.

Our knowledge and experience stems from years of using infrared imaging and temperature measurement instruments to provide solutions to: managers, engineers, scientists, inspectors and operators in space, power companies, medical, pulp and paper, food industry, research and development, and various process industries. You can see our products and services used in industrial, commercial, and government applications worldwide. Originally named Texas Infrared (still DBA), Infrared Cameras, Inc. has been in business since March, 1995.

Thank you for your dedicated and continued support.