

Touchboards

205 Westwood Ave, Long Branch, NJ 07740
Phone: 866-94 BOARDS (26273) / (732)-222-1511
Fax: (732)-222-7088 | E-mail: sales@touchboards.com

Spectrum III

owner's manual



Infrared Wireless Microphone System

TeachLogic
FOR SOUND LEARNING

Spectrum III

owner's manual



notes

Date of Purchase: _____

Model Number: _____

Serial Number: _____

Notes:



thank you

Congratulations on the purchase of your new Spectrum III Infrared Wireless Microphone Sound System. You can be assured that the Spectrum III fulfills all specifications and was produced to very high quality control standards. TeachLogic incorporates the latest state of the art technology, employs the most advanced manufacturing methodology and uses only premium quality components to assure many years of reliable performance. We appreciate your confidence by your selection of our product. It is TeachLogic's intent to uphold that confidence by providing factory assistance and dealer support.

We hope you will take the time to view this manual to familiarize yourself with the product operation and features. This manual will help you learn to use and gain the maximum benefit of the Spectrum III system. The manual provides a basic explanation on the principles and advantages of infrared transmission. Followed by the system description, operation and installation instructions, the manual will conclude with maintenance and troubleshooting procedures.

Brian Van Waay

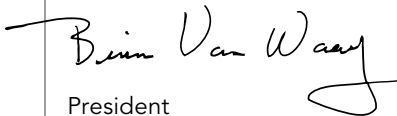

President

contact

If you should encounter some unresolved issue, please contact TeachLogic customer service department for further assistance.

☎ 1-800-588-0018

✉ sales@teachlogic.com

☎ 1-760-631-1283

🌐 www.teachlogic.com



CAUTION

**RISK OF ELECTRIC SHOCK:
DO NOT OPEN**

Caution: To Reduce The Risk Of Electric Shock Do Not Remove Cover (Or Back)
No User-serviceable Parts Inside
Refer Servicing To Qualified Personnel

certifications



US



CA

Listed



TeachLogic systems are manufactured using lead-free processes and are free of materials harmful to the environment. They conform to the most stringent new European guidelines for consumer products (RoHS).

caution

Recycle—Do not dispose rechargeable batteries in trash. Actually it is unlawful to do so in CA, NY & ME.

Contact: Earth911.com

1-800-CLEANUP

Save our resources and don't contaminate.

Go Green

safety instructions

Read Instructions

All safety and operation instructions should be read before operating this TeachLogic product.

Retain Instructions

Safety and operating instructions should be kept for future reference.

Water & Moisture

This product should not be operated near water.

Heat Environment

Do not subject this product to excessive heat conditions.

Power Source

This product must be connected to an AC power source per the voltage input specified and marked on the power supply.

Power Cord Caution

Power cable should be routed clear of foot traffic and supported clear of kinking or abrasion.

Object Protection

Locate the operating unit so it will not be subjected to falling objects or water entry.

Internal Service

User should not attempt to service this product. All internal service must be accomplished by a qualified technician.

Electric Shock

Do not adapt or modify the AC power plug thus lifting the earth ground connection.

table of contents

About Infrared	1
Product Description	2
Spectrum III System Description IMA-820.....	3
Sapphire Microphone/Trasmitter IRT-60	4
Handheld Microphone/Trasmitter IRH-35	5
Drop-in Charger BRC-55/Ceiling Sensor ICS-55	6
Installation of Ceiling Sensor	7
Installation of Ceiling Speakers	8
Installation of Wall Mount Speakers	9
System Wiring	10-11
Page Pass Through	12
Fire Alarm	13
RS-232 Features	14
Security Alert Features	15
Operation of Wireless Microphone	16
Trouble Shooting	17
System Specifications	18-19
Five Year Limited Warranty	20



IR transmission

The IR transmitter transmits directly to the sensor. However; due to the strength of the IR transmitter, the infrared signal will bounce off the walls, ceiling and floor for reception thus providing continuous connectivity throughout the room. Benefit: total freedom of movement within the room with no restriction of orientation.

“What’s said in the room, stays in the room”.

Infrared will not penetrate a solid surface thus preventing any transmission from going out of the room.

a brief word about infrared

Infrared is a light ray that is below the visible spectrum, just like the sound extends beyond your hearing ability. An example of infrared transmission is the remote control for your TV set. When a button is pressed, a beam of infrared light is emitted by a Light Emitting Diode (LED) from the remote control. It is detected by a receiving diode in your TV set. When you press a certain command on your control, the internal electronics cause the infrared light to flicker in a programmed sequential pattern (called modulating the light beam). The modulated infrared beam is detected by the receiving diode and is electronically decoded. The decoded signal activates the circuitry to perform the command function on your TV set.

So how does this apply to the infrared communication system you are about to start using? The microphone/transmitter has several Light Emitting Diodes (LED) that emit infrared light beams to the sensor located in the corner of the room. Now when you talk into the microphone, the microphone element modulates the light beam, causing it to flicker in sync with your speech. The sensor detects the sequential signal and the electronic circuitry in the Spectrum III converts that sequential signal into a line level analog audio signal. Now that audio signal can be fed into an amplifier. The amplifier magnifies the electronic signal and sends it to the speakers. This causes the speaker cone to move in sync with your voice. The speaker replicates your voice and disperses your voice evenly throughout the room.

product description

The Spectrum III is an infrared wireless microphone system that can be added to any sound system. It can be a supplement to an existing multi-media system to expand its utilization to provide voice reinforcement.

The addition of a Spectrum III system to your multi-media system will transform your classroom sound system into a totally hands free voice re-enforcement system, resulting in reduced voice fatigue, enhanced student listening and improved student learning. The wireless function permits 360° connectivity throughout the classroom regardless of body position or orientation.

The system is comprised of an infrared detecting sensor(s) installed in the ceiling. The sensor collects the IR wireless signal from the microphone/transmitter and sends a composite signal to the receiver. The receiver transforms the composite signal into an analog audio signal which is fed to the multi-media amplifier. The amplifier powers the speakers for even voice reinforcement throughout the room.

The microphone / transmitter can be the Sapphire or Handheld. The rechargeable batteries will provide 6–8 hours of service per charge. The drop-in charger will recharge the batteries overnight, ready for another day's use.

Reliable
performance.
Use with
confidence.

Spectrum III system

The Spectrum III system is comprised of a microphone / transmitter, either the Sapphire (IRT-60), or Handheld (IRH-35) for voice transmission to a ceiling sensor (ICS-55) that sends the signal to the receiver / amplifier (IMA-820). The receiver/amplifier processes the signal and produces an analog signal of your voice for output to the sound field speaker system.

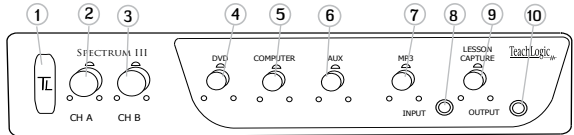

front of IMA-820 receiver/amplifier

- | | |
|----------------------------------|----------------------------------|
| 1 Power on/off | 6 Aux Volume Control |
| 2 CH A Microphone Volume Control | 7 MP3 Volume Control |
| 3 CH B Microphone Volume Control | 8 MP3 Input (3.5mm) |
| 4 DVD Volume Control | 9 Lesson Capture Volume Control |
| 5 Computer Volume Control | 10 Lesson Capture Output (3.5mm) |

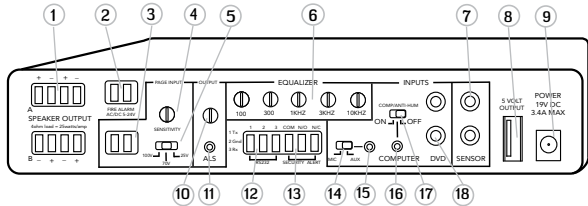

back of IMA-820 receiver/amplifier

- | | |
|--|---|
| 1 Speaker Output - Two Channel
Four pin Phoenix connector | 10 ALS gain control |
| 2 Fire Alarm - AC/DC 5-24 volt | 11 ALS Input 3-5mm |
| 3 Page Pass Through 2 pin Phoenix | 12 RS-232 Tx, Gnd, Rx -3 pin |
| 4 Sensitivity control | 13 Security Alert - Com, N/O, N/C -3pin |
| 5 Impedance selector | 14 Aux-Mic Input Selector |
| 6 Five band digital equalizer ± 12 dB | 15 Aux-Mic Input 3.5mm |
| 7 Two Sensor Inputs (RCA) | 16 Computer Input 3.5mm |
| 8 5 Volt USB for BRC-55 charger | 17 Computer Anti hum ON/OFF |
| 9 Power Input: 19 VDC 3.4A | 18 DVD dual Mono Inputs (RCA) |

infrared microphone/transmitters

The infrared microphone/transmitter is comprised of a microphone input, signal processing circuits and several emitting diodes that transmit the vocal signal to the sensor.

The microphone/transmitter can be the Sapphire or Handheld. The rechargeable batteries will provide 6–8 hours of service per charge. Place the microphone/transmitter in the charger for overnight charge and it will be ready for another day's use.

The drop-in battery chargers are specifically designed to recharge lithium & NiMH batteries at an optimum rate for maximum operating capacity and extended service life. Charger will automatically start charging the batteries upon insertion and will shift to a maintenance charge when batteries are fully charged.

features

- Elegant design
- Only 1.4 oz. including battery
- Long life “Lithium ion” battery
- Rechargeable via USB cable to computer
- Battery level indicator – Back light under power switch
- Momentary mute button, backlight blinks in mute mode
- Push “on/off” power
- Channel “A” or “B” selectable
- Three level microphone volume switch
- (HI, MID -3dB, LOW -6dB)

HI is normal

- Auxiliary input (3.5mm)
- Wear with a lanyard or slide directly on neckline collar



(IRT-60) sapphire transmitter

The Sapphire's vocal clarity is unsurpassed. Its high level output is achieved by the unidirectional (Cardioid) microphone and a unique free air suspension system. With a built-in breath filter, the Sapphire can function as a pass around hand mic.

The strategic alignment of the emitting diodes assures reliable connectivity throughout the room without static or drop out.

With a tap on the power button, the microphone is muted for private conversation—tap again to restore to normal operation. The auxiliary input allows wireless playback of your iPod™ through the Sapphire. A three position slide switch provides selection of low, medium, or high microphone sensitivity.





IRT-60 remote control features

1. Moving the **priority** switch Up/Down will control the volume of the line inputs.
2. A momentary tap of the **priority** switch will duck down the line inputs 15dB. The receiver front panel power switch changes to a blinking PURPLE. A second tap will restore line input back to normal.
3. Hold in **priority** switch for 5 seconds closes the contact closure on the Security Alert output. The receivers front panel power switch changes to blinking GREEN. Holding the button down for another 5 sec. returns the contact to normal.

features

- Condenser microphone element
- Power “on/off” switch
- Battery level indicator—LED
- Channel “A” or “B” selectable
- 10 high-power emitting diodes
- Diodes at top and bottom of handle for increased Coverage (2 Top aimed out, 6 Bottom 360°, 2 Bottom aimed down)
- 360° IR radiation for assured connectivity
- Two “AA”, Duracell, rechargeable NiMH batteries



IRH-35 handheld transmitter

The Handheld Microphone Transmitter (IRH-35) is most applicable for student use or direct presentation. It has an “on/off” switch and a battery level indicator LED; Green=useable charge, Red=low battery. The transmitter has 10 emitting diodes: 8 around the bottom of the handle, and 2 toward the top of the handle. The metal housing provides low handling noise and insures durable longevity.

BRC-55 drop-in battery charger

This stylish desktop drop-in charging station makes it convenient and easy to recharge both Sapphire Pendant and Handheld Microphones. Charge one IRH-35 handheld transmitter and up to two IRT-60 Sapphire transmitters simultaneously. Charging indicator lights illuminate Red when charging, and Green when fully charged. The "TL" logo illuminates Blue when plugged in.



power "on" LED

Green light indicates that the sensor is receiving power from the receiver.

ICS-55 ceiling sensor

The ceiling sensor is the preferred infrared sensor for optimum performance. This is the unit that needs to be installed on the ceiling. It comes with a mounting/support bracket and 50 feet of plenum rated cable with RCA connector on each end. The ideal location for the dome sensor would be in the center of the ceiling. This will provide a clear signal path for the IR transmission from the transmitter to the dome sensor without obstruction. In addition, you will have 360° coverage and will minimize the transmission distance for more reliable performance. It collects the infrared transmission signal via 6 large detecting diodes.

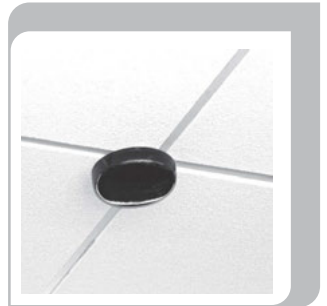

sensor cable

A Cable connects the sensor to the receiver. The cable is dual-shielded with a male RCA connector on each end and is plenum rated.



installation of ICS-55 ceiling sensor

The ideal location for the ceiling sensor is in the center of the ceiling. This will provide a clear signal path for the IR transmission from the transmitter to the dome sensor without obstruction. In addition, you will have 360° coverage and will minimize the transmission distance for more reliable performance.

Attaching the infrared ceiling sensor

Installation 1 ----- Attach to T-bar Rail

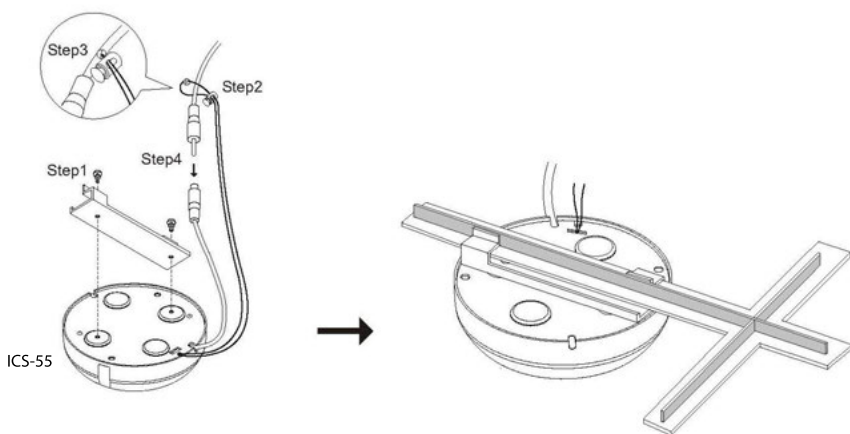

Installation 2 ----- Attach to wood surface

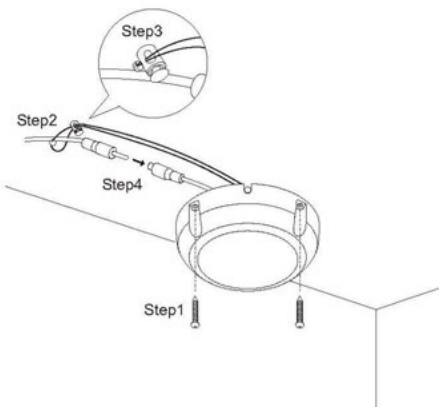

Installation 3 ----- Attach to concrete surface

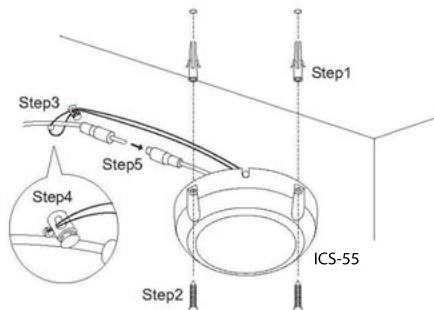

installation of speakers

Two wall mount or ceiling speakers can be powered by the receiver/amplifier. It has two amplifiers (25 watts ea.). One speaker will be connected to each amplifier.

Optional: Two additional speakers can be powered by the amplifier. Connect two speakers in parallel. Then bring a cable from each pair to the amplifier. Connect one pair to each amplifier.

installing two SP-628 ceiling speakers

- Determine the listening area.
- Divide listening area into two quadrants
- Locate and identify the center most tile in each quadrant
- Lay ceiling tile face down on clean flat surface
- Lay tile bridge on ceiling tile and center it
- Trace and cut the large hole using a keyhole or drywall saw
- Strip the speaker cable ends, approx. 1/2"
- Route speaker wire from speaker opening to amplifier
- Reinstall ceiling tile with tile bridge in place above the hole
- Pull speaker cable back down through speaker hole
- With a pointed tool or paper clip, lift up and remove speaker grille
- Set speaker on top of ladder and connect speaker cable connect
- Observe speaker polarity, connect Red wire to (+) terminal and black wire to the (C) terminal
- With the mounting clamps folded back, position speaker into speaker hole
- With a #2 Phillips screwdriver, tighten the quick clamps
- Reinstall speaker grille and remove any soil or fingerprints
- Repeat same for other speaker

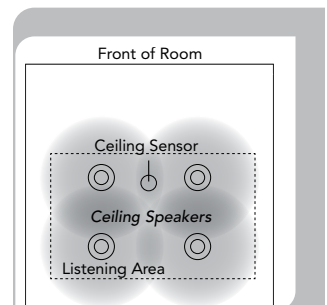
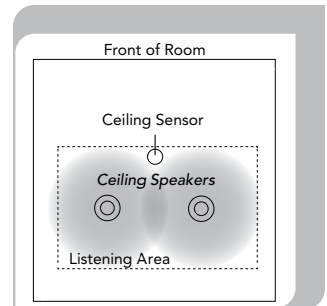

Optional:
Two Additional Speakers

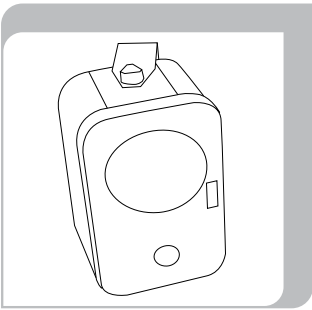

installing SP-2000 wall mount speakers

- First observe the shape of the room: ceiling height, door locations, windows, mounting surface, and seating area
- Ordinary installation would be to locate the speakers on each side wall approximately even with the front row of listeners
- Mount the speakers 6–7 feet above the floor
- Install the mounting brackets in the vertical (up/down) orientation
- Mount brackets using the appropriate hardware
- Insert speaker with the tweeter in upper position
- Secure speaker in bracket with the hand fasteners
- Orient each speaker toward the center of that half of the listening area
- Strip speaker cable ends $\frac{1}{2}$ " and connect to speaker
- Observe speaker polarity: Connect (+) wire (with printed writing) to (+) terminal and (-) wire (unprinted & textured) to the (-) terminal
- Route speaker cable to the receiver/amplifier in a safe, least visible, tidy manner

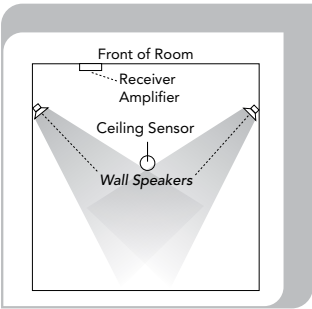

final connection of the system

With receiver/amplifier located, speaker and sensor cables neatly routed, we are ready to complete the installation.

- Cut the speaker wire to the appropriate length
- Strip about $\frac{3}{8}$ " off the end of each speaker wire.
- Twist the wire and if you have a soldering iron, tin the wire ends
- Unplug the phoenix connector, insert (+) wire (with printed writing) into either outside (+) terminal. Plug the other (-) wire into center (-).
- Tighten set screws.
- Repeat for other pair and insert plug firmly into speaker receptacle
- Plug power supply into AC outlet

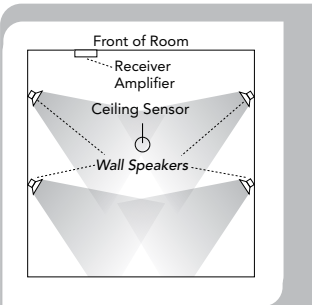

Optional:
Two Additional Speakers

Spectrum III

owner's manual

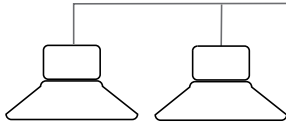

Ceiling Speakers

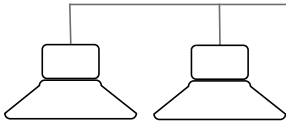

Ceiling Speakers

From
Page System

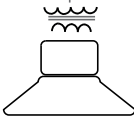

Classroom
Paging Speaker

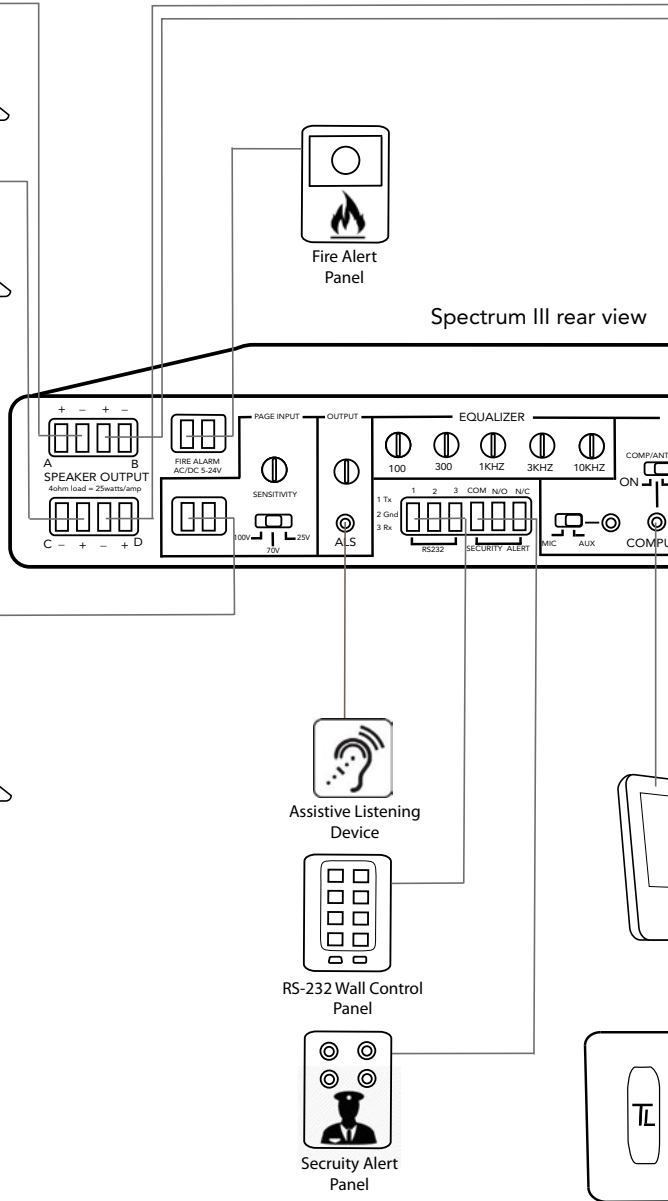

system wiring

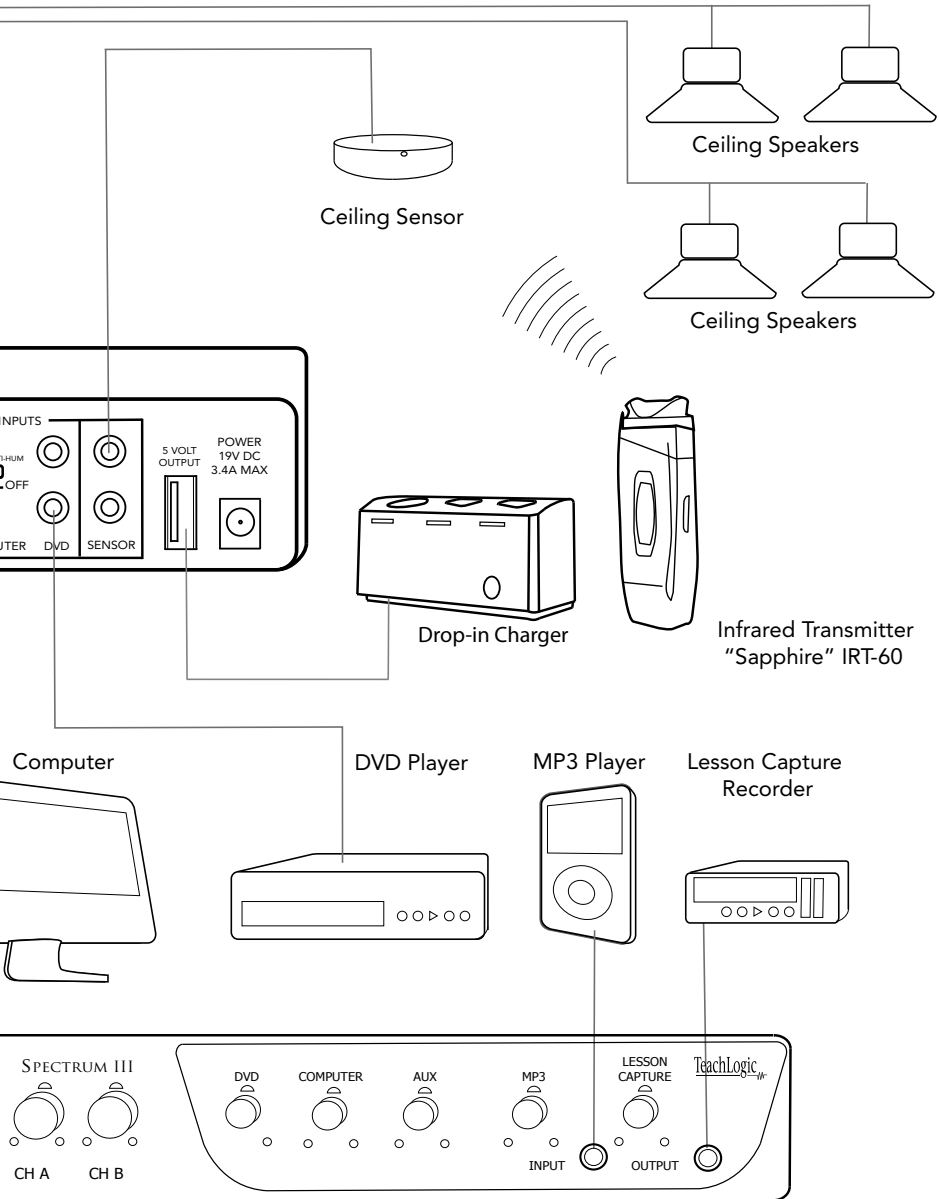

Spectrum III front view

page over-ride/page pass through

The page over-ride feature allows you to connect the TeachLogic amplifier to the school paging/intercom system for muting purposes. A simple connection between the in-classroom paging speaker (typically 25v or 70v) and the TeachLogic page input will mute all the inputs and pass the page to the speakers connected to the TeachLogic amplifier

Unplug the 2 pin green Phoenix connector

Connect the speaker cable from the paging system to the 2 pin Phoenix connector of the Page input

Reconnect the 2 pin green Phoenix connector

Determine the signal level of the paging system (25v, 70v, or 100v)

Set the slide switch to the appropriate speaker level setting

With the TeachLogic amplifier turned ON, send a page signal through the page input

Adjust the page input SENSITIVITY control so that an incoming page/intercom signal will override any audio (mics, dvd etc) plugged into the TeachLogic amplifier.

In the event of a loss of AC power, the TeachLogic amplifier will continue to pass the page on to **only one** of the speaker connections as outlined on the following diagram. Only the **upper left** speaker outputs will pass page without power.

fire alarm input

The 2 pin orange Phoenix connector labelled Fire Alarm, was designed to provide an emergency mute of the TeachLogic amplifier. When interfaced to the fire alarm relay contact output, all audio devices (microphones, dvd, etc.) will turn SILENT. In the event of a fire, this will help to lower the overall decibel levels and help students and staff hear the audible fire alarm tones/instruction within the classroom. This feature only requires a 5-24 volt AC or DC source.

page pass through - fire alarm contacts

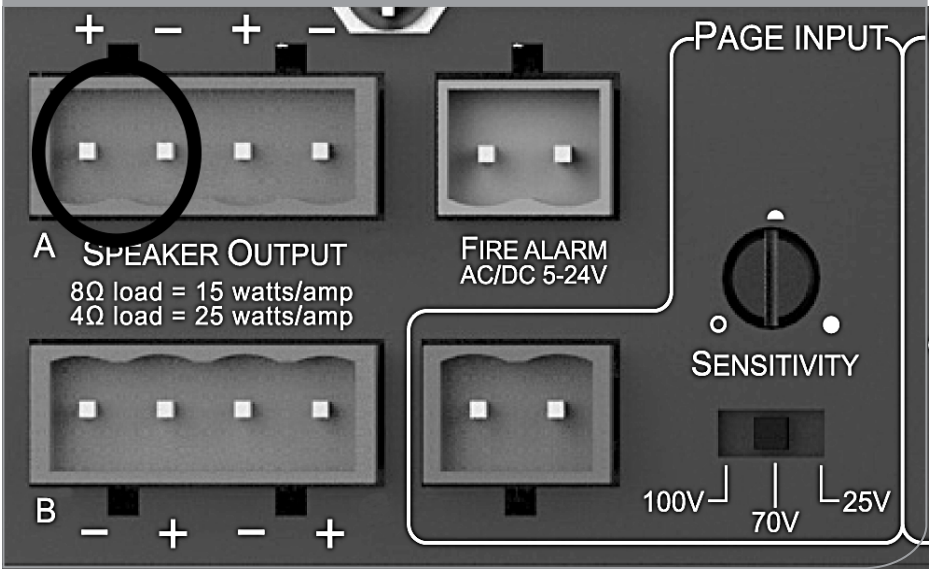

RS-232 features

The RS-232 feature allows the user to remotely operate the line level media inputs via a convenient wall panel controller.

Audio levels very often need to be adjusted when switching from computer audio to DVD players and other audio sources. Such operations as level UP, DOWN and MUTE are easily accomplished via a typical eight button controller, as shown here. This allows the receiver/amplifier to be placed in an area or compartment that is not easily accessed by the user. Codes that are required for this setup are also available below or from TeachLogic's website.



RS-232 codes

Baud Rate : 9600

Parity Bit : NONE

Data Bit : 8

Stop Bit : 1

TL COMMAND	Functionstring	HEX
POWER ON	Power:ON	4c 69 6e 6b 78 3a 50 6f 77 65 72 3a 4f 4e
POWER OFF	Power:OFF	4c 69 6e 6b 78 3a 50 6f 77 65 72 3a 4f 46 46
Gain DVD UP	Gain:DVD:UP	4c 69 6e 6b 78 3a 47 61 69 6e 3a 41 55 58 3a 55 50
Gain DVD DOWN	Gain:DVD:DOWN	4c 69 6e 6b 78 3a 47 61 69 6e 3a 41 55 58 3a 44 4f 57 4e
Gain DVD MUTE	Gain:DVD:MUTE	4c 69 6e 6b 78 3a 47 61 69 6e 3a 41 55 58 3a 4d 55 54 45
Gain Computer UP	Gain:Computer:UP	4c 69 6e 6b 78 3a 47 61 69 6e 3a 44 56 44 3a 55 50
Gain Computer DOWN	Gain:Computer:DOWN	4c 69 6e 6b 78 3a 47 61 69 6e 3a 44 56 44 3a 44 4f 57 4e
Gain Computer MUTE	Gain:Computer:MUTE	4c 69 6e 6b 78 3a 47 61 69 6e 3a 44 56 44 3a 4d 55 54 45



security alert features

The security Alert features allows the teacher/presenter to send a silent wireless electronic signal with a simple press of a button, in the event of an in-classroom security incident. The signal is easily generated by the teacher who is wearing Sapphire wireless pendant microphone. This same microphone transmitter which is used for in-room amplification, has a special button (labelled PRIORITY) on the side for initiating the Security Alert. Simply holding down the button for 4 seconds, "closes" a contact closure on the rear panel of the TeachLogic amplifier and sends the Security Alert signal to the appropriate location possibly the principal's or security monitoring station. The front panel power switch on the front of the amplifier will "blink" with a soft green background.

To disengage from the Security Alert mode, simply hold the side button for 4 seconds, and the amplifier will return to its normal state with the front panel power button illuminated with a solid blue background.

The output is a three pin NO/NC contact closure labeled Security Alert.

RE-232 and Security Alert contacts

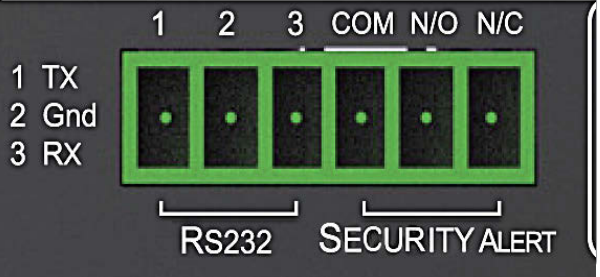

operation of wireless microphone

Now that the system is installed and connected, we are ready to turn the system "ON" and test its performance. The testing will be done using an IR transmitter (Sapphire or Handheld) to confirm good connectivity and quality audio.

system operation

- Turn the Spectrum III "ON", Blue LED will light
- Confirm power to sensor, Green LED on edge of sensor
- Set volume of Ch A volume control to mid scale (12 o'clock)
- Using a Sapphire Transmitter microphone select channel "A" (Mics are shipped in channel A)
 - Sapphire: "A-B" switch, remove battery cover on back, under battery.
 - Handheld: Unscrew barrel and remove.
Note "A-B" switch on side of battery holder.
- Turn volume control on Sapphire transmitter to **"Hi" level**. This is the normal setting.
- Switch transmitter "on"
- Observe power LED (Blue) - use fully charged battery only
- Observe signal presence LED (Orange) on receiver adjacent to "Mic" volume control
- Stand under or in front of a speaker
- Slowly adjust "Ch A" volume on Spectrum III while talking into microphone
- Adjust to desired listening level.
CAUTION: Beware of feedback
- Walk around the room while talking into microphone to confirm good connectivity

*Upon completion of performance test,
the installation is complete.*

troubleshooting

Problem	Solution
System is turned "on" but there is no sound	<ul style="list-style-type: none">• Verify AC power; the Red LED lights when turned "on"<ul style="list-style-type: none">• Check if system has been unplugged• Check circuit breaker• Call maintenance for assistance
System has power but no sound	<ul style="list-style-type: none">• Turn "on" microphone/transmitter• Check for IR transmission, Signal presence (Orange LED)• Check the Yellow LED in the sensor• If sensor LED is not lit<ul style="list-style-type: none">• Sensor has been disconnected• Power output to sensor has failed (Receiver/amplifier needs to be replaced)
Voice is distorted and/or signal drop-out occurs	<ul style="list-style-type: none">• Check the charge on your batteries• Verify power switch in battery compartment is in "Hi" position (Body-Pack transmitter)• Verify that the diodes on transmitter or sensor are not being covered• Obstruction between transmitter and sensor

contact

If your problem persists and this guide has not resolved the issue, call our customer service department for additional assistance. (800) 588-0018

Spectrum III (IMA-820) specs.

Receiver Input Modulation	Infrared FM FM Wide-band
Reception Frequencies	Ch. A: 2.08 MHz, Ch. B: 2.54 MHz
Infrared Wavelength	850 nm
Tone Signal	Ch. A: 32.768 KHz
De-emphasis	50 μ s
Frequency Response	50 Hz, -13KHz, C 3dB
S/N Ratio	>65 dB
THD	<1% @1KHz
Nominal Deviation	\pm 10 KHz
Maximum Deviation	\pm 25 KHz
External Sensor Input	Two, RCA
Aux Inputs	Four line level inputs for DVD, Computer, Aux and MP3 Switchable computer anti-hum circuit Aux input (Microphone or Line level)
Line Output	One Lesson Capture Output, 3.5mm with Gain Controls, Front Panel One ALS Output, 3.5mm with gain control, Rear Panel
Equalization	Five Band Digital \pm 12dB
Security Alert Output	N/O, N/C contact closures
RS-232	Wall panel control of line input levels
Fire Alarm Input	AC or DC 5-24 volt
Power Output	Four Amplifiers, 100 watts total (RMS) 25 watts ea. (RMS)
Output Impedance	4ohm min, per channel
Output Connection	One Phoenix Connector, ch A,B,C&D
Power Supply	19VDC /6.3A / 120W CE,CSA & UL Listed
Dimensions	8 1/2" W x 1 3/4" H x 7 1/2" D
Weight	2 lb. 7oz.
Enclosure	Aluminum

power supply (AC-80) specs.

Type	Regulated Switching Power Supply
Input Voltage	100-240 volts AC, 47-63Hz
Output Voltage	19 volts DC, 6.3A
Power Output	119.7 watts Max.

Sapphire transmitter (IRT-60) specs.

Transmitting Diodes	Six
Operating Range	1,600 Ft ² . 60 Ft. Line of Sight
Battery Discharge Indicator	
Blue	Full
Purple	Medium
Red	Low
Flashing Red	Very Low Battery
Battery Used	Lithium-ion (3.7V / 620mAh)
Battery Life	Approx. 8-9 Hrs/Charge
External Power Charger	DC +5V, Micro USB Connector
Transmission Angle	Conical
User Controls	
Power Switch (push)	On/Off
Mute Switch (push)	On/Off momentary push
Mic Switch (3 position)	HI, MID -3dB, LOW -6dB
Aux. Vol./Gain	Increase, Decrease
Security Alert	5 second hold of priority button
External Aux. Input	3.5mm Line Level
Dimensions	3 5/8" H x 1 1/4" W x 3/4" D
Weight	1.4 oz. Including battery

Handheld transmitter (IRH-35) specs.

2 Channel Switchable	Field Switchable
Transmitting Diodes	Ten
Modulation	FM Wide-Band
Pilotone Frequency	32.768 KHz
Peak Deviation	± 25KHz
Operating Range	1600 Ft ² . 60 Ft.
Power Switch (Slide)	On/Off
Battery Charge Level (LED)	Green (Useable Charge) Red (Needs Charging)
Battery Life	Approx. 7 Hr./Charge
Dimensions	21/8" Dia. Head, 17/16" Dia. Body, 95/8" H
Weight	10.3 oz. w/ Battery

drop-in battery charger (BRC-55) spec

Charging Port	2 Sapphire, i Handheld
Red LED	Battery being charged
Green LED	Battery fully charged
Power Supply	5 VDC, 1 Amp
Dimensions	7 3/4" L x 2 3/4" W x 3 3/4" H
Weight	1 lb. 12 oz.

five year limited warranty

TeachLogic IR products are guaranteed to be free of defects in workmanship or material for a period of five (5) years from date of original purchase, subject to the following conditions:

1. Warranty excludes defects caused by normal use and wear, any abuse, or failure to use the product in accordance per instructions.
2. Warranty is void if damage occurred because of misuse, or attempted repair or modification by unauthorized personnel.
3. Warranty on batteries is for two (2) years.
4. Warranty does not extend to finish.
5. All warranty service will be provided by TeachLogic or authorized service center
6. Warranty is made to the original purchaser and may not be transferred to another user.
7. Warranty service rendered will be on a repair or replacement basis, whichever TeachLogic deems to be most prudent for customer satisfaction and economic feasibility.

TeachLogic will only accept warranty shipments accompanied by Return Authorization Number previously assigned by TeachLogic personnel. Advance warranty replacements will be made per the discretion of TeachLogic personnel.

TeachLogic will pay return shipping cost on all warranty repairs or replacements.

contact

TeachLogic, Inc.
Customer Service Dept.
1688 Ord Way
Oceanside, CA 92056

☎ 1-800-588-0018

✉ sales@teachlogic.com

☎ 1-760-631-1283

🌐 www.teachlogic.com







Touchboards

205 Westwood Ave, Long Branch, NJ 07740
Phone: 866-94 BOARDS (26273) / (732)-222-1511
Fax: (732)-222-7088 | E-mail: sales@touchboards.com

TeachLogic

FOR SOUND LEARNING 

1688 Ord Way
Oceanside, CA 92056

 1-800-588-0018
 sales@teachlogic.com
 1-760-631-1283
 www.teachlogic.com

5/28/14