

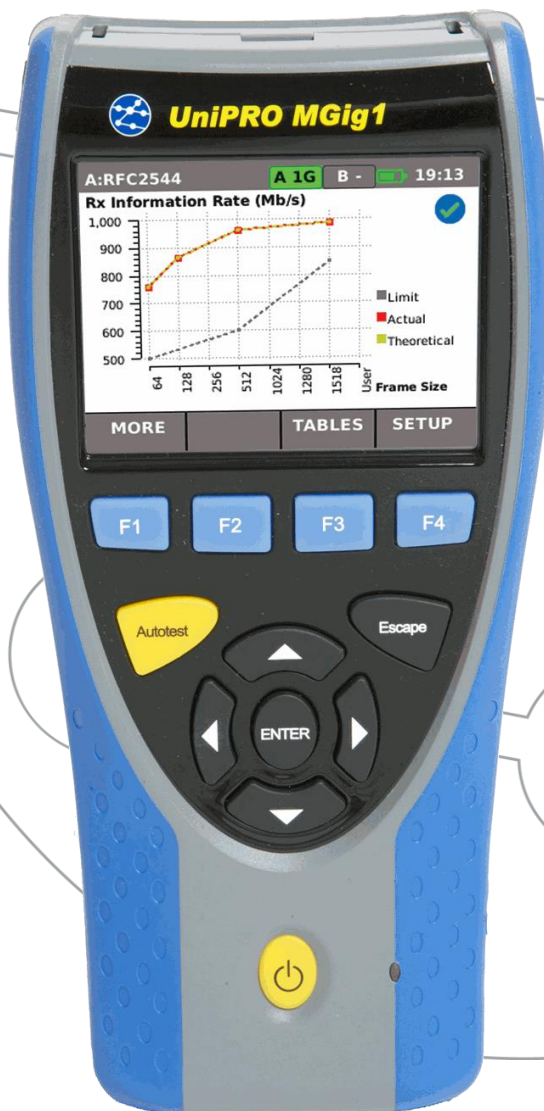

IDEAL NETWORKS

UniPRO MGig1

UniPRO SEL1





IDEAL NETWORKS

COPYRIGHT NOTICE

The information contained in this document is the property of IDEAL INDUSTRIES Ltd. and is supplied without liability for errors and omissions. No part of this document may be reproduced or used except as authorized by contract or other written permission from IDEAL INDUSTRIES Ltd. The copyright and all restrictions on reproduction and use apply to all media in which this information may be placed.

IDEAL INDUSTRIES Ltd. pursues a policy of continual product improvement and reserves the right to alter without notice the specification, design, price or conditions of supply of any product or service.

© IDEAL INDUSTRIES LTD. 2015

All rights reserved
Publication ref: 152810
Issue 3 - 02/15
(Applies to software revision 1.0.12 onwards)

IDEAL INDUSTRIES LTD.
Stokenchurch House
Oxford Road
Stokenchurch
High Wycombe
Buckinghamshire
HP14 3SX UK

www.idealnwd.com



CONTENTS

- Introduction 5
- Product care..... 6
- Final Disposal..... 6
- Safety Information..... 6
 - Connector Safety..... 6
- Power 7
 - Power Management, battery pack and power module..... 7
 - Battery Pack and Power Module Recharging..... 7
 - Switching ON and OFF 8
 - Power Saving..... 8
 - Master Reset 8
- Replaceable insert – RJ-45 socket 9
- Functional overview..... 9
- Handset Controls, Indicators and Ports – MGig1..... 10
- Handset Controls, Indicators and Ports – SEL1 11
- Menu Navigation..... 12
 - MGig1..... 12
 - SEL1..... 13
- Transmission testing concepts..... 14
 - General 14
 - Ethernet frame structure and Layers..... 15
 - Loopback and Layers 16
 - Connection Establishment..... 18
 - Targets and Services..... 18
 - Traffic Impairments..... 19
- Ethernet transmission testing methods 19
 - BERT..... 19
 - SLA-Tick 19
 - RFC2544..... 19
 - Y.1564 (NetSAM)..... 20
- Modes of Operation 21
 - Endpoint 21
 - Through..... 21
- Ports..... 22
- Setup 23
 - Targets 24
 - Services..... 26
 - Test data/Error inject 27
- Remote control 28
 - MGig1 to MGig1..... 28
 - MGig1 to SEL1 29
 - SEL1 Loop layer 29
- Tools 30
 - Ping4 and Ping6..... 30
 - TRoute4 and TRoute6 31
 - PoE..... 31
 - Blink..... 32
 - Traffic generation..... 33
- Transmission tests – set up and run..... 36
 - BERT..... 36
 - SLA Tick..... 38
 - RFC2544..... 40
 - NetSAM 48

continued



CONTENTS (continued)

Auto test.....	53
Statistics.....	54
Stats menu description.....	54
Jobs.....	56
Using the Jobs menu.....	57
Change the active Job.....	57
Managing Jobs.....	58
Generating Reports.....	59
MGig1 software updates and configuration.....	59
SEL1 software updates and configuration.....	60
General.....	60
Update software.....	60
Upload configuration (for transfer to other SEL1 handsets, for use with the utility UPSEL1Config.xls, or to view the software version).....	60
Download configuration.....	60
Reset SEL1 to factory default.....	60
Specifications - UniPRO MGig1.....	61
Glossary, abbreviations and acronyms.....	63



Introduction

This guide provides operating information and principles of operation for the UniPRO handsets MGig1 and SEL1. The transmission tester, MGig1, is the handset from where all tests are run and stored. The SEL1 is a loopback terminal that enables testing over four layers.

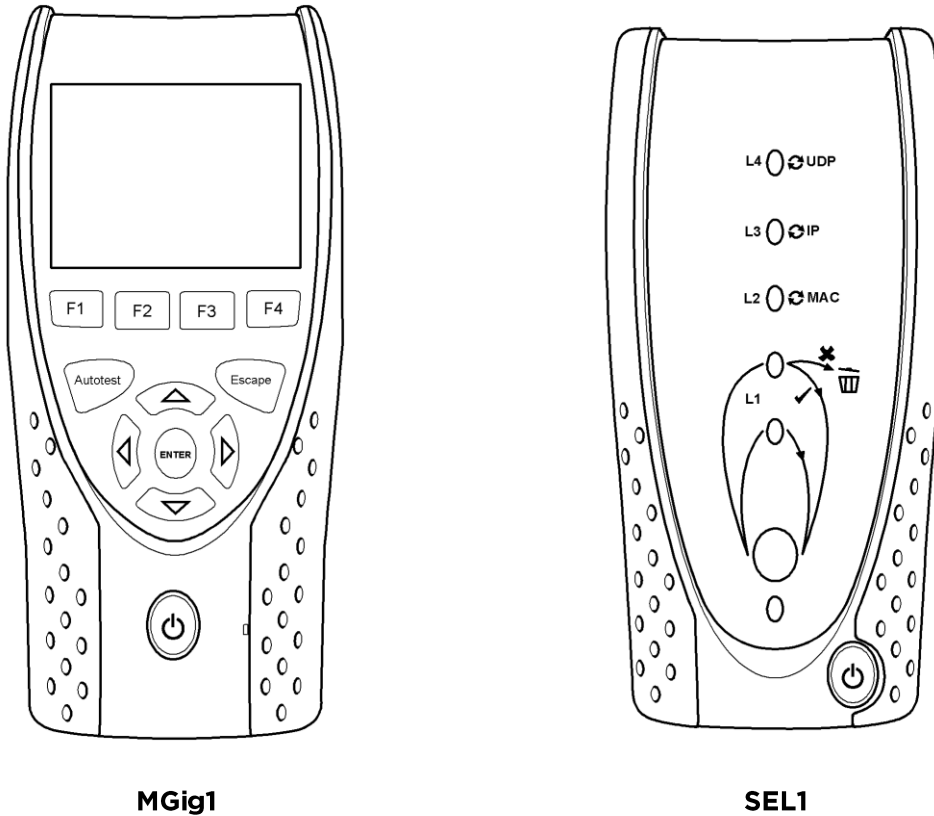

Fig 1 UniPRO handsets

The MGig1 is available in the variants that follow and with the features indicated:

	MGig1	MGig1 PLUS	MGig1 PRO
Copper port	✓	✓	✓
Optical port	x	✓	✓
Multi-service	x	✓	✓
Bidirectional	x	✓	✓
Y.1564	x	x	✓
MPLS	x	x	✓
VLAN Levels	3	3	8

The range listed above is also available in ‘Duo’ format which adds a second copper and optical port making a total of six MGig1 variants. The additional ports extend functionality to include:

- Dual-port through-mode capability
- Loopback capability on the second port
- Traffic generation on the second port



Product care

Although light and portable, UniPRO handsets are robust and have been designed to operate in a protected outdoor working environment.

To ensure reliable operation:

- Avoid very high or low temperatures - UniPRO handsets are designed to operate between 0°C and +45°C, although you should only charge the batteries between +10°C and +30°C. They may be safely stored between -20°C and +70°C.
- To avoid damage, when they are not in use we recommend that you keep both UniPRO MGig1 and UniPRO SEL1 in their carrying case.
- Do not use solvents, strong detergents or abrasive materials to clean any part of the handsets. Use only cleaning agents approved for use on ABS and polycarbonate plastics.

Final Disposal

When your UniPRO MGig1 or UniPRO SEL1 has reached the end of its life you must dispose of the complete unit in accordance with local environmental regulations.

Safety Information

When using UniPRO handset, always take basic safety precautions to reduce the risk of fire, electric shock and injury to persons. These precautions include:

- When connecting to the line, special care must be taken as high voltages may be present on the line and there may be a danger of electrocution.
- Avoid using UniPRO MGig1 and UniPRO SEL1 during an electrical storm - there is a remote risk of electric shock by lightning.
- Use only the mains electricity adaptor supplied with your handset.

CLASS 1 LASER PRODUCT. Light output from the fiber optic port can damage eyesight even though it is invisible. Never stare into open optical ports or the end of a fiber to see if light is coming out.

Connector Safety

The connectors listed below conform to EN60950 SELV safety status:

- RJ-45 Ethernet port.
- USB port.
- DC inlet port.



DO NOT CONNECT ANY TELECOMMUNICATIONS NETWORK TO ANY OF THE TESTER'S PORTS



Power

UniPRO MGig1 can be powered from:

- A rechargeable battery pack,
- AA alkaline batteries (not supplied) in an optional holder,
- Directly from power connected to the DC inlet.

UniPRO SEL1 can be powered from:

- A rechargeable power module,
- AA alkaline batteries (not supplied) in an optional holder,
- Directly from power connected to the DC inlet built in to the power module.

Power Management, battery pack and power module

A fully charged battery pack or power module will support up to five hours of heavy, continuous use of a single port, or 3.5 hours continuous use of two ports. For maximum life of the unit, it is recommended to discharge it fully and then recharge it fully at least once a month.

The rechargeable battery pack and the power module are not user-serviceable. When they have reached the end of their life, contact your local IDEAL representative for service.

Battery Pack and Power Module Recharging

The battery pack or power module can be fully recharged in three hours with the handset switched ON or OFF. To recharge, connect the supplied power adaptor to the DC inlet. For convenience the power module may be removed from, or left attached to, the UniPRO SEL1 for charging. The Power LED next to the DC inlet glows green to show that the battery is being charged, and flashes green to show that it is not being charged.

The UniPRO MGig1's battery pack charge state is indicated at FULL, 2/3, 1/3 and EMPTY by the graphical power meter shown in the display's information bar at the top of its LCD display.

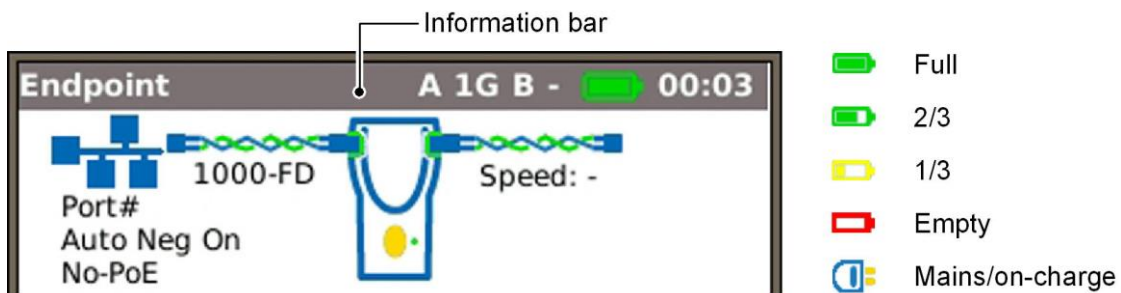

Fig 2 Power indications



The SEL1's power module charge state is indicated by an LED directly below the Layer button. LED indications are:

Power LED	Status
Green	Power ON. Battery level sufficient for use
Red	Power ON. Battery charge level low but still operational
Off	Power OFF

Switching ON and OFF

To switch ON the units, press the ON/OFF button:

- UniPRO MGig1 displays a splash screen with the IDEAL logo and model identity followed by the home screen.
- UniPRO SEL 1 performs a brief lamp test and is ready for you to choose the Layer you wish to test over.

To switch OFF either unit, press and hold the Power button for approximately 1/2 second. The SEL1 shuts down immediately, the MGig1 displays a shutdown message on the screen and the currently stored setup is saved. If either unit does not switch OFF within five seconds, see *Master Reset*. Always switch OFF either unit before removing the battery pack or power module.

CAUTION

EQUIPMENT DAMAGE. Do NOT remove the battery pack or power module when the unit is switched on.

Power Saving

UniPRO MGig1 has power saving preferences that are selected from SETUP>SYSTEM>PREF. Auto Off can be Disabled (unit remains ON indefinitely), or set to switch the unit OFF after three, 10 or 30 minutes of inactivity. The backlight can be set to Always On, or to dim to 50% brightness after three minutes of inactivity. Note that when mains power is connected the display is always on full brightness and the unit remains ON indefinitely.

UniPRO SEL 1 remains ON indefinitely whether on battery or mains power.

Master Reset

In the unlikely event of a system lock-up which prevents MGig1 from being switched OFF, it may be necessary to perform a master reset. This will not delete any stored data.

- Remove the battery pack (Fig 3) to access a small aperture in the case molding.
- Insert a paper clip into the reset hole and press the internal reset switch.
- Replace the battery pack.



Fig 3 MGig1 master reset

Replaceable insert - RJ-45 socket

To replace a damaged or worn RJ-45 socket insert proceed as follows:

Equipment required: Kit, IDEAL part number 150058 – includes Tool x1 and Replacement Insert x10.

- Switch the UniPRO handset OFF and remove all attached cables.
- Carefully push the tool STRAIGHT into the socket. Fig 4A. BE CAREFUL - DO NOT MOVE THE TOOL VERTICALLY!
- Keep the tool STRAIGHT and give a firm pull on the insert until it is out of the socket. Fig 4B.
- Hold the replacement insert between your fingers and carefully align it with the socket. Push it STRAIGHT into the socket with your finger until it is secure. Fig 4C.

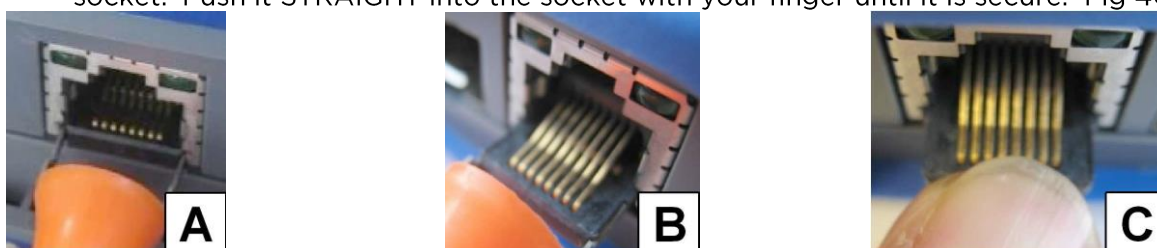

Fig 4

Functional overview

The MGig1 range offers six models. The available functions are listed below. The information throughout this publication details the functions available to MGig1 Duo PRO. Please check this table to confirm the functions available on your tester.

Function	MGig1 Solo	MGig1 Solo PLUS	MGig1 Solo PRO	MGig1 Duo	MGig1 Duo PLUS	MGig1 Duo PRO
Transmission testing over copper	✓	✓	✓	✓	✓	✓
IPv4 & IPv6	✓	✓	✓	✓	✓	✓
Cable test	✓	✓	✓	✓	✓	✓
PoE detection and load test	✓	✓	✓	✓	✓	✓
Ping test	✓	✓	✓	✓	✓	✓
Traceroute test	✓	✓	✓	✓	✓	✓
Hub blink	✓	✓	✓	✓	✓	✓
No. of VLANs supported	3	3	8	3	3	8
Traffic generation *	✓	✓	✓	✓	✓	✓
Results storage & export	✓	✓	✓	✓	✓	✓
Transmission testing over fiber	x	✓	✓	x	✓	✓
Loopback mode *	✓	✓	✓	✓	✓	✓
Multistream	x	✓	✓	x	✓	✓
Bi-directional	x	✓	✓	x	✓	✓
MPLS	x	x	✓	x	x	✓
BERT	✓	✓	✓	✓	✓	✓
RFC2544	✓	✓	✓	✓	✓	✓
NetSAM (Y.1564)	x	x	✓	x	x	✓
SLA-Tick	✓	✓	✓	✓	✓	✓

* Duo models can generate traffic or loop on the A and the B ports



Handset Controls, Indicators and Ports – MGig1

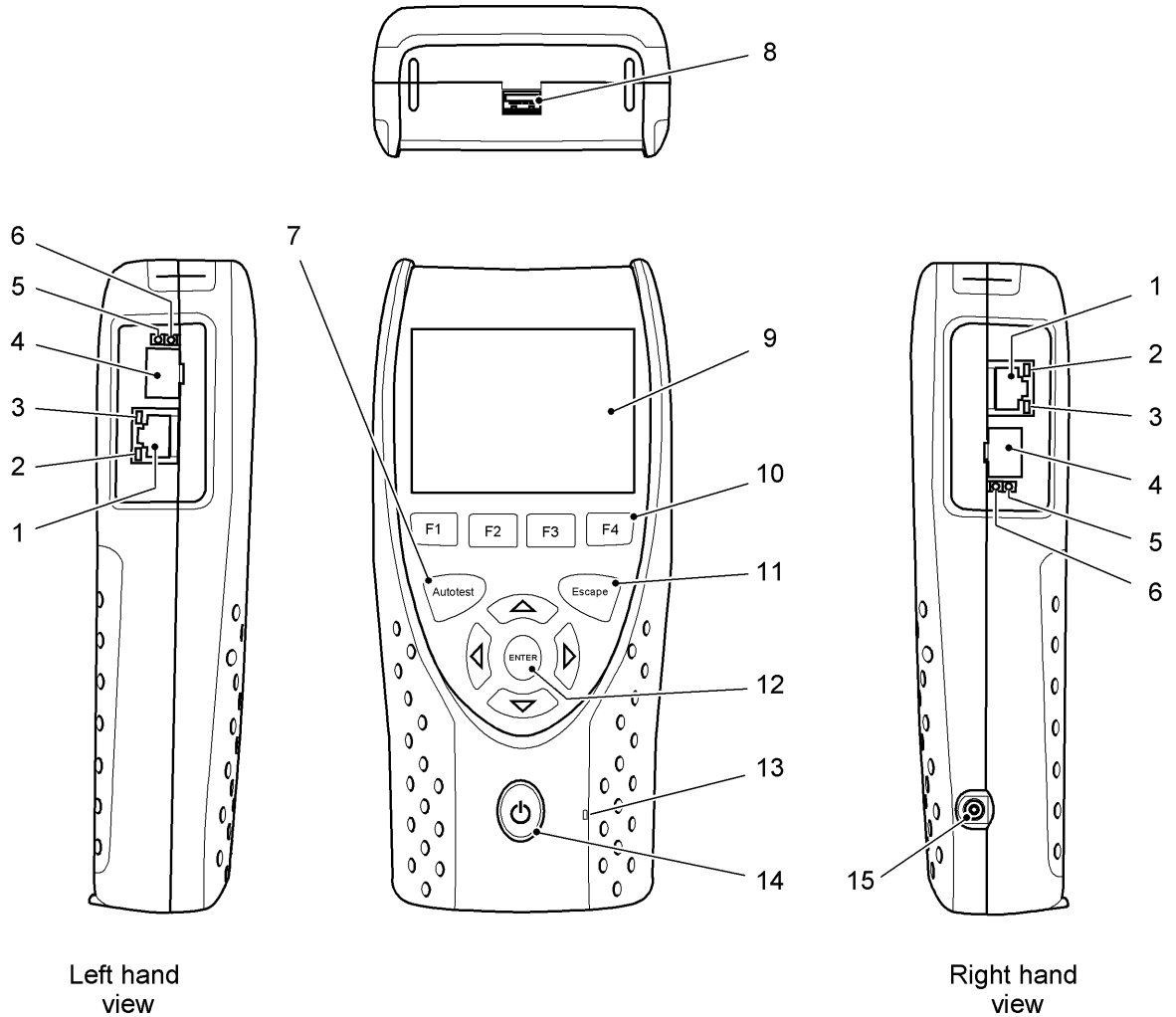

Primary ports ('A')

- 1² RJ 45 port
- 2² RJ 45 activity LED
- 3² RJ 45 link LED
- 4^{1,2} Optical port (SFP)
- 5^{1,2} Optical activity LED

- 6^{1,2} Optical link LED
- 7 Autotest button
- 8 USB port
- 9 LCD color display
- 10 Function keys F1 to F4

Secondary ports ('B')

- 11 Escape key
- 12 Cursor and ENTER keys
- 13 Charger LED
- 14 ON/OFF button
- 15 DC in connector

Fig 5

¹ Fig 5 items 4, 5 & 6 - MGig1 PLUS & PRO models only.

² Fig 5 items 1 to 6 on right hand view - MGig1 Duo models only.



Handset Controls, Indicators and Ports - SEL1

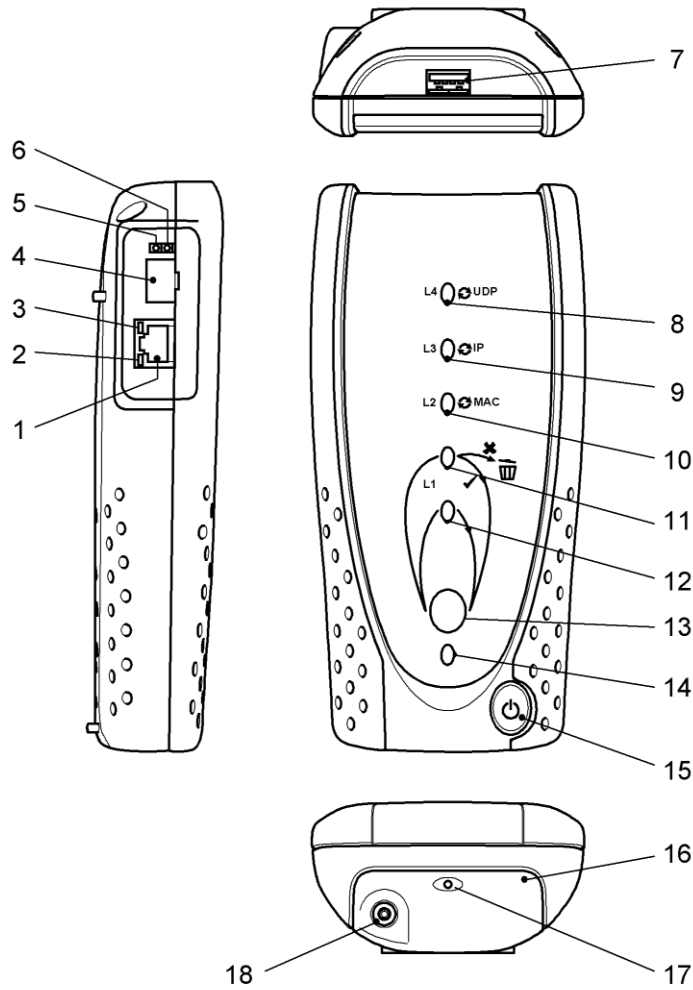

- | | | | |
|---|----------------------|----|----------------------------|
| 1 | RJ 45 port | 10 | Layer 2 LED |
| 2 | RJ 45 activity LED | 11 | Layer 1 Regenerate LED |
| 3 | RJ 45 link LED | 12 | Layer 1 Physical LED |
| 4 | Optical port (SFP) | 13 | Layer button |
| 5 | Optical activity LED | 14 | Power status indicator LED |
| 6 | Optical link LED | 15 | ON/OFF button |
| 7 | USB port | 16 | Power module |
| 8 | Layer 4 LED | 17 | Charger LED |
| 9 | Layer 3 LED | 18 | DC in indicator |

Fig 6



Menu Navigation

MGig1

Touch screen. The soft keys, menu icons and items on drop-down lists can be selected by pressing the touch screen. Although the touch screen can be activated with your finger, we recommend using the nylon stylus provided.



Fig 7 Touch screen navigation

Alternatively, MGig1 may be operated with the key pad alone:

Cursor and ENTER keys. The arrowed cursor keys are intuitively marked to move the highlighted field between all menu icons, settings fields and drop-down menus that appear on the display. ENTER selects the currently highlighted option.

Escape key. Returns to previous screen or hides the options of a drop-down menu. Note that when a value in a settings field is changed, if the Escape key is pressed *before* the soft key 'APPLY', the value will not be stored.

Autotest key. Immediately runs pre-stored tests. A new tester will have factory stored tests in memory. These are easily changed using the SETUP menu.

Function keys. F1 to F4 are to select the corresponding soft keys at the lower edge of the display.

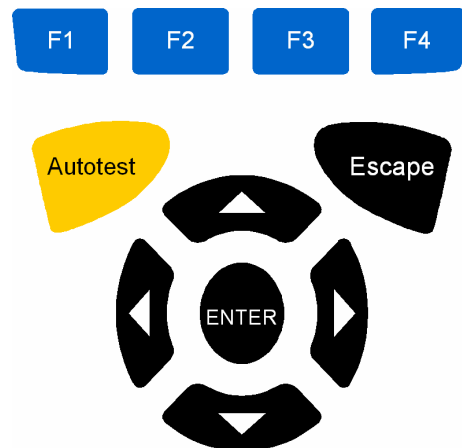

Fig 8 Keypad navigation

Soft keys. The soft keys appear along the bottom edge of the display. Their function changes and is dependent on the screen currently shown on the display.



Fig 9

Data entry. When you navigate to and select a field that requires a value or text to be entered, such as a customer's name or a URL, a QWERTY keyboard will be shown on the display (Fig 9). All data is entered using the QWERTY keyboard. The touch screen makes the keyboard particularly easy to use. Alternatively, move the key that is highlighted on the keyboard using the tester's cursor keys. ENTER selects the currently highlighted key which will now appear in the text window directly above the keyboard. Key stroke errors are corrected using the backspace key (<-). Press the UP cursor key to move the cursor into the text window for editing.

Press the QWERTY keyboard's SHIFT key to change the display from lower to upper case. Press SHIFT a second time to display symbols and punctuation characters.

SEL1

Press the blue Layer button on the front of the handset to cycle through all loop options available. Each time the button is pressed a green LED lights next to the Layer selected. The LED directly below the blue button indicates that SEL1 is dormant but still powered on. The loop options available are:

- Layer 4 UDP
- Layer 3 IP
- Layer 2 MAC
- Layer 1 Regenerative
- Layer 1 Physical
- No loop



Fig 10 SEL1 indications



Transmission testing concepts

General

The principle of Ethernet transmission testing is that traffic is sent through a network and checked at the other end. For single-ended testing, traffic is sent through the network to a device that loops it back to the sending device. Therefore, traffic is generated and checked at the same location.

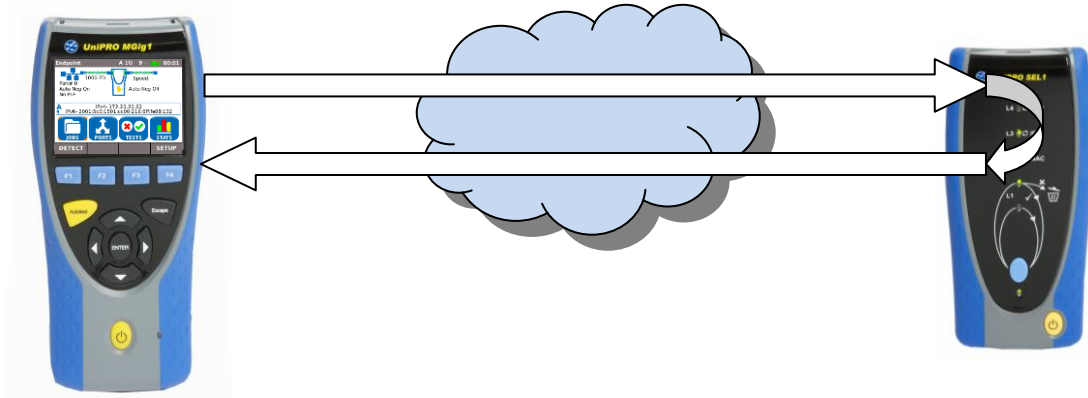

Fig 11 Single-Ended test method with loopback

This method is very easy to set up. A loopback device, such as SEL1, can be installed at the remote end of the transmission loop with minimum skill requirements, and can be controlled by the tester at the local end.

Alternatively, the sending device and the checking device may be in different locations.

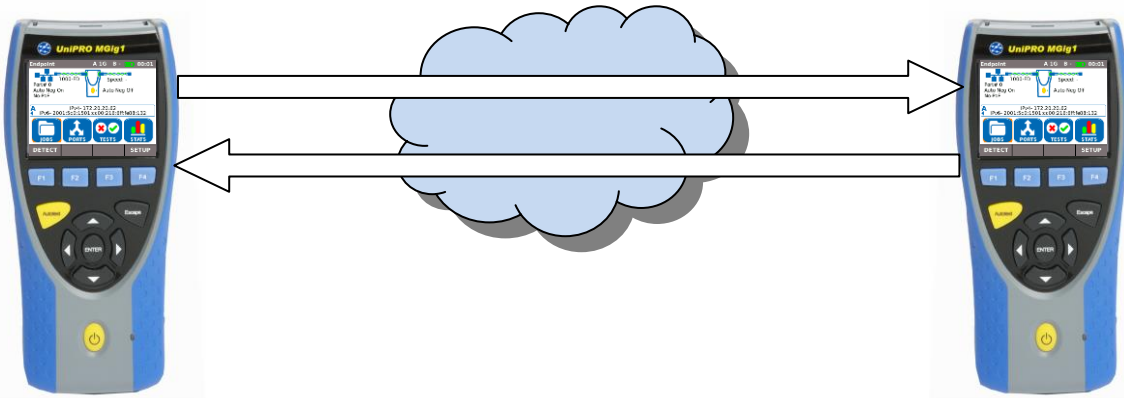

Fig 12 Bi-Directional test method

Unlike the loopback method, bi-directional tests confirm the direction as well as the nature of errors. As two full test devices are required to run a bi-directional test, set up is more complicated. However, when they are set in Master-Slave mode, one device can control the other and so only one operator is needed.



Ethernet frame structure and Layers

Ethernet frames comprise a payload (the user data) inside a number of layers of control elements. The higher the layer, the greater the frame's inherent ability to enable the network to deliver frames to the correct destination. Each layer adds to the complexity of the frames and to the amount of overhead. This reduces the space available for the payload.

When the payload is tested with procedures such as BERT, it is recommended to use the lowest layer frame type that will propagate through the transmission path under test. This makes sure the maximum payload is available for the test data.

Layer 1 frames begin after a Preamble (PRE) and a Start of Frame Delimiter (SFD) which are used for frame alignment. These frames are separated from one another by an Inter Frame Gap (IFG). Layer 1 Ethernet frames contain the maximum amount of BERT / Quality of Service (QoS) test data (the Payload equals the Frame size) but they can only pass through a physical connection, and not through switches or routers. Layer 1 frames do not have the ability to check frame errors.



Fig 13 Layer 1 Frame

Layer 2 frames have a Destination and Source MAC address added that follows the SFD. The MAC addresses enable the frames to be sent to a specific destination through Layer 2 switches. Layer 2 frames may also have VLAN and/or MPLS tags added after the source MAC (sometimes this is called "Layer 2.5"). They end with a Frame Check Sequence (FCS) used to check the frame for errors. The Layer 2 Payload is everything between the end of the source MAC (or VLAN / MPLS tags if present) and the start of the FCS.



Fig 14 Layer 2 Frame

Layer 3 frames add a Source and Destination IP address after the source MAC; this enables them to be sent through Layer 3 switches and routers. The Layer 3 Payload is everything between the end of the IP header and the start of the FCS.



Fig 15 Layer 3 Frame

Layer 4 frames add a Protocol header (PROT) after the IP header. This defines the transport layer protocol (TCP / UDP) followed by Destination and Source Port numbers. This allows traffic to be routed to a particular Port. The Layer 4 Payload is everything between the end of the Layer 4 header and the start of the FCS.



Fig 16 Layer 4 Frame



Loopback and Layers

When traffic is looped, the type of loop may need to be determined by the type of traffic and the structure of the transmission path to be tested. Usually, the Loop type is the same as the Layer type of the traffic – e.g. Layer 3 traffic is looped at Layer 3.

When (a) the loopback device is connected to a dedicated port, or, (b) when the network segment to which the loopback unit is connected carries only test traffic, the device can be set to loop all traffic received. When the network segment carries both test traffic, and non-test traffic that should not be looped, the loopback unit can be set to only loop traffic that is specifically addressed to it.

Loop types are as follows:

Layer 1 (Physical) Loop. Every bit received is immediately re-transmitted to its source with minimal delay and exactly as received even when it contains errors. This loop type can only be used over a physical medium with no active network elements.

Layer 1 (Regenerate) Loop. Errored frames are dropped. Good frames are retransmitted exactly as received. To determine if a frame contains an error it is necessary to receive and check the complete frame before it is retransmitted. This introduces at least one frame of delay in the retransmission. Therefore the loopback operation introduces some latency that must be allowed for in latency measurements. Furthermore, if the frame size varies (e.g. if the traffic contains multiple streams with different frame lengths) the latency will vary and this will appear as jitter, which must be allowed for in jitter measurements. (This also applies to all the higher layer loops.)

Layer 2 (MAC). Good frames are retransmitted, as in L1 (Regenerate), but are altered so that the Source and Destination MAC addresses are swapped. This makes sure that frames sent to the loopback device's MAC address (Destination MAC in the received frame) are returned to the sender's MAC address (Source MAC in the received frame). This loop type can be used over a physical connection or over a switched network using Layer 2 switching.

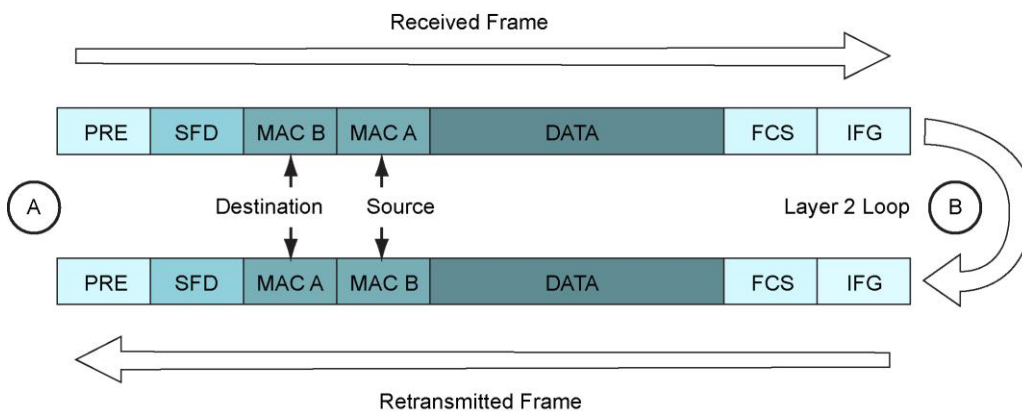

Fig 17 Layer 2 Loop



Layer 3 (IP). Good frames are retransmitted and altered so that the Source and Destination MAC addresses, and, the Source and Destination IP addresses are swapped. This is so that frames sent to the loopback device's IP address (Destination IP in the received frame) are returned to the sender's IP address (Source IP in the received frame). This loop type can be used over (a) a physical connection or (b) over a switched network using Layer 2 or Layer 3 switching or (c) over a routed network.

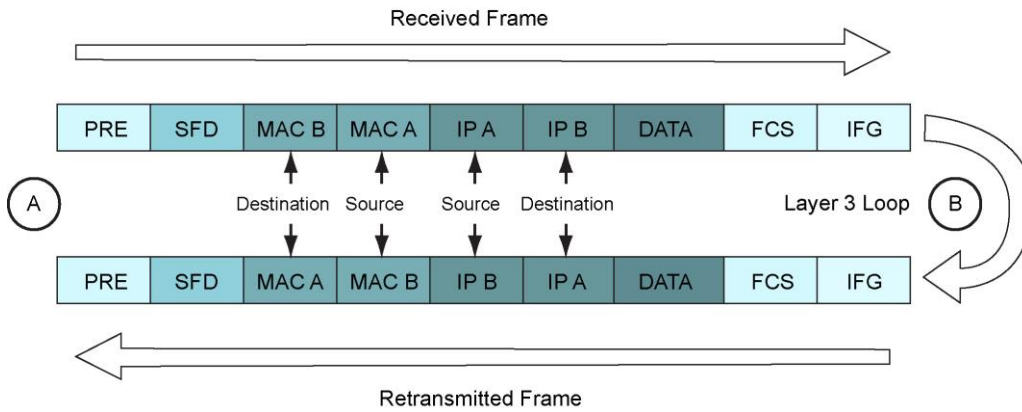

Fig 18 Layer 3 Loop

Layer 4 (UDP). Good frames are retransmitted and altered so that the Source and Destination MAC addresses and the Source and Destination IP addresses are swapped as at Layer 3. In addition this loop type swaps the UDP Source and Destination Port numbers, so that traffic sent to a particular port is returned from that same port back to the originating port. This loop type can be used over any type of connection or network.

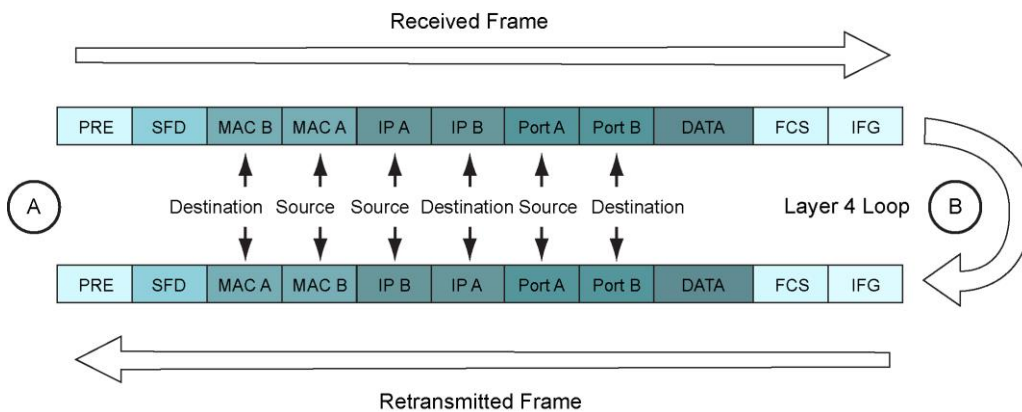

Fig 19 Layer 4 Loop

Connection Establishment

To make a connection between a tester and a loopback device, or between two testers becomes progressively more complicated the higher the Layer used.

Layer 1 is sufficient to test a physical medium, such as a copper or fiber cable, or a radio link. Higher layers can be used, and their settings, such as addresses and VLAN/MPLS tags, have no effect apart from reducing the amount of frame space available for the payload. The only requirement is that the tester is set to use the attached loopback device (or slave tester) as its target.

Layer 2 is required in a LAN environment to connect via Layer 2 switches. The tester can be commanded to DETECT all compatible IDEAL devices (loopback units or testers) on the network. The detected devices can be added to the tester's Target list and one of them selected as the target for tests. The test frames will have the target's MAC address in their destination field. Higher layer information that may be present in the frames will have no effect on the communication between the tester and the target.

Layer 3 must be used when tests are run over a routed environment in the WAN outside of the local LAN. The tester needs to identify its target by a public IP address. When the target is located in the WAN, it will need to be assigned a known address so that the tester can be set up to communicate with it. It is not possible to automatically DETECT compatible IDEAL devices/targets that are outside of the LAN. The test frames will have the target's IP address in the destination field. Frames retransmitted by the loopback device will have the tester's IP address in their destination field. The destination MAC will be replaced by the MAC of the gateway.

Layer 4 is used when the target is located in another LAN that is connected to the tester's LAN by a WAN connection, on the far side of an edge router. The target will not have a public IP address, but instead a private one assigned, either automatically or manually, by its local network. The test frames will have the public IP address of the edge router in their Destination fields, and in addition the port number of the port to which the target is connected. The router will need to be set up with port forwarding to forward the frames to the target using the correct port number. The frames retransmitted by the loopback device will have the LAN address of the router in their destination field. This will be translated by the router using its Network Address Translation (NAT) table so that the frames eventually arrive back at the originating tester.

In addition to the increased complexity of the setup at the higher layers, the issues that follow can arise and must be overcome before testing can proceed.

Firewalls in LAN edges are designed specifically to block the type of traffic that testers generate. Test traffic can only pass through a firewall that has an open port, or a Demilitarized Zone (DMZ), to which the target is connected.

Ethernet transmission tests can generate large amounts of traffic and are designed to stress networks to the point of failure. This must be taken into account when setting up the tests in order to avoid disrupting other network traffic or causing network elements to block the overload situation.

Loopback devices that are configured to Layer 1 (Physical) loop cannot be automatically detected or remote controlled because they do not receive or respond to Ethernet frames. They only retransmit them.

Targets and Services

Targets are destinations for test traffic. They can be (a) loopback units that retransmit the traffic back to the source or, (b) other testers that receive and check the traffic and also generate and send traffic back the other way.

A service is a stream of traffic with specific characteristics. Up to eight services, each with different characteristics, can be used simultaneously for testing a network's ability to carry multiple types of traffic, to different destinations and, for example, over different VLANs. Each service is sent to a defined target. This may be a common target for all services, selected from the Targets list, or the destination addresses (MAC & IP) may be set individually for each service. By default a service will use the destination MAC and IP of the target and source MAC and IP of the tester.

Traffic Impairments

Transmission tests check for impairment to Ethernet traffic in the form of Errors, Latency and Jitter.

Frame errors are either Lost Frames (frames that were transmitted but were lost in the network) or Corrupted frames (frames that were received but were found to contain errors).

Payload errors are errors in the data part of the Ethernet frames.

Latency is network propagation delay.

Jitter is short term variations in network propagation delay.

To detect the above listed impairments, tests are run under specific, user defined conditions, e.g. with different frame sizes and frame rates, and in the presence of varying levels of traffic loading. Some tests determine the maximum performance that a network connection can achieve without exceeding pre-defined limits on impairment levels.

Ethernet transmission testing methods

Various methods of Ethernet transmission testing have been developed over the years. Each development brought additional sophistication and value to the knowledge about the performance of the network being tested. More sophistication increased the test times. Some tests can run for days or weeks. The most recent developments have sought to reduce test times without losing valuable information about the network performance.

BERT

Bit Error Ratio Test (sometimes incorrectly referred to as “Bit Error Rate Test”) is a traditional test method used for many types of telecommunications transmission system. In Ethernet environments, it focuses on testing the frame payload, putting pre-defined patterns of test data into the frames and checking them bit-by-bit at the receiver. Individual bit errors are counted and expressed as a ratio to the total data received, and periods of time during which the error ratio exceeds pre-defined limits are recorded. Errors of different types can be forced into the frames or the payload data in order to confirm that the error checking mechanism is working correctly and to determine how the network responds to errored data.

SLA-Tick

Service Level Agreements (SLAs) are commonly used to define a contractual commitment to provide specified minimum performance of network connections. They normally define minimum Information Rate and maximum Latency and Jitter. For the SLA-Tick test, multiple services can be selected to occupy the available bandwidth, each with its own fixed frame size and each having its own performance limits. This test always uses Layer 4 framing, because it can propagate through all types of network and because the reduced payload is not relevant.

RFC2544

The Internet Engineering Task Force defined this testing methodology which comprises the following sub-tests, each of which can be included or omitted from the overall test sequence. (Note, however, that some of the sub-tests rely on the results of others before they can be run.) A full RFC2544 test with all sub-tests at all frame sizes can take a long time to complete, so the tester provides a choice of test profiles relating to the time needed to complete the tests. Layer 4 framing is used.

Throughput This is a test of achievable Information Rate at different frame sizes. The maximum theoretical Information Rate decreases with decreasing frame size, because the overhead becomes more significant compared to the payload. This sub-test compares the actual performance against theoretical and target limits.

Latency Latency increases with increasing frame size because frames have to be buffered in network equipment prior to onward transmission and the bigger the frame the longer it takes before it can be forwarded. The Latency sub-test measures latency against theoretical and target limit for different frame sizes.

Jitter This should be independent of frame size, and the jitter sub-test is designed to confirm this and to reveal any network impairments which might be introducing jitter dependent on frame size.

Frame Loss As frame rate increases, networks will start to drop frames. For each frame size, this sub-test varies the frame rate until the point is found at which frames just start to be dropped.

Back-to-Back Each Ethernet frame must be separated from the next by a minimum Inter Frame Gap (IFG). For each frame size, the Back-to Back sub-test assesses the ability of the network to handle frames separated by the minimum IFG, measuring the longest burst of these frames that can be successfully propagated without errors.

System Recovery When network elements are overloaded by excessive traffic, they can take some time to recover to a condition in which they are ready to transmit traffic again. For each frame size, the System recovery sub-test generates traffic at the rate found by the Throughput sub-test and measures the recovery time of the network.

Y.1564 (NetSAM)

In an attempt to overcome some of the limitations of RFC2544, notably the long test times, the sequential nature of the tests and the unrealistic single-service traffic method, the International Telecommunications Union defined a new Ethernet service activation test methodology - Y.1564. The first phase in this method is a Service Configuration Test, which evaluates the ability of the network to achieve the Committed Information Rate (CIR) and Excess Information Rate (EIR) without error for each of a multitude of services, one at a time. The Service Performance Test then measures the Frame Transfer Delay (Latency), the Frame Delay Variation (Jitter), the Frame Loss Ratio and the Service Availability simultaneously for each service at the CIR. By doing this, the NetSAM test evaluates all of the Key Performance Indicators of the network at once over multiple services simultaneously, much more accurately simulating real-world traffic than RFC2544. It also polices the ability of the network to control and handle traffic which is marked in color to indicate its priority in relation to the CIR and EIR defined in the SLA. Layer 4 framing is used.

Modes of Operation

MGig1 has two modes of operation, Endpoint and Through Mode. To change between Endpoint and Through Mode, from the home screen select PORTS (F2), choose the mode from the dropdown menu and select APPLY (F3). Each time you change modes the detected services are PoE (802.3af/at. Not Cisco pre-standard), ISDN S, PBX and Unknown. The IPv4 and IPv6 addresses assigned to the tester (when available) are shown on the 'Endpoint' screen.

Endpoint mode

Endpoint is the mode from where all transmission tests and tools are run (Fig 20A).

Before a transmission test is run, a far end loopback must be set. Configuration of a SEL1 handset that has been discovered as a target can be set remotely from the MGig1, see [page 29](#).

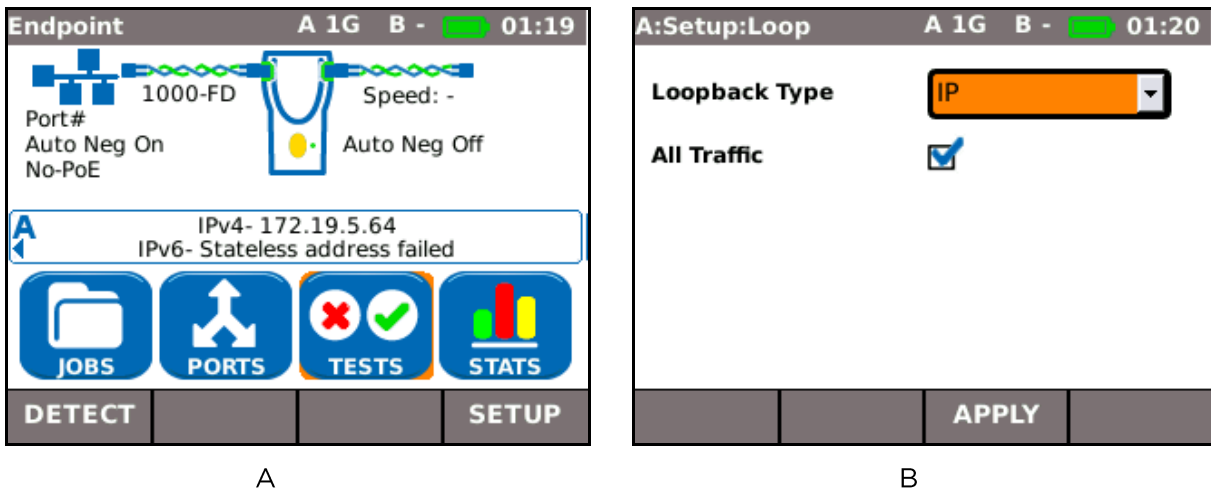

Fig 20

Through mode

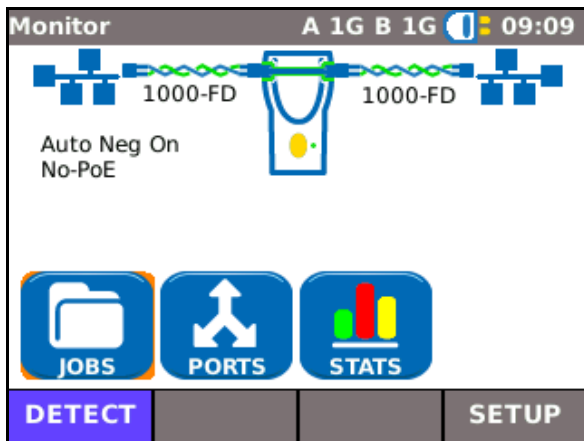

Fig 21

Through mode is for viewing statistics. Select PORTS and choose Through Mode from the dropdown menu and select APPLY (F3). MGig1 will detect the connected services and show them on the display (Fig 21). It will attempt to negotiate the highest connection rate between the two networks.

Select STATS to view current traffic as graphs and tables. Traffic is categorized as Top Users, Top VLANs, MAC and LINK data. For further information on STATS see [Statistics on page 54](#). For further information on Jobs see [Jobs on page 56](#).



Ports

From the home screen select the PORTS icon. The Ports screen is shown on the display (Fig 22). Choose the required ports, copper or optical, from the dropdown lists and press APPLY (F3). Modes are explained on *page 21*.

When you select APPLY (F3) MGig1 detects connected services and shows them on the display.

Tick the check box to always see this screen at startup.

NOTE

Fig 22 shows the Ports screen from the MGig1 Duo PRO. Port and mode options are dependent on the model.

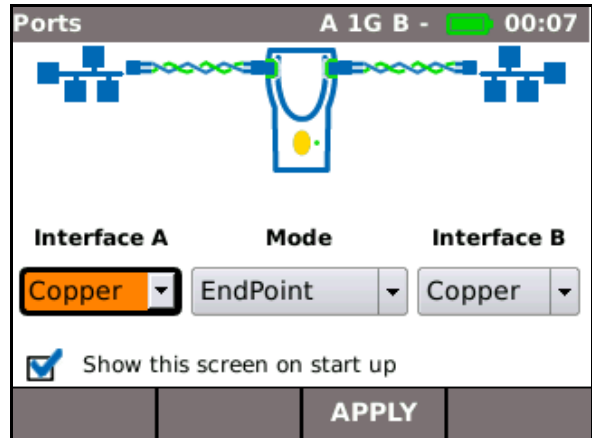

Fig 22



Setup

User-defined settings and preferences for MGig1 can be set from the SETUP menu illustrated at Fig 23. Net B and Tools B refer to Duo models. Check your model's range of functions against the table on page 9.

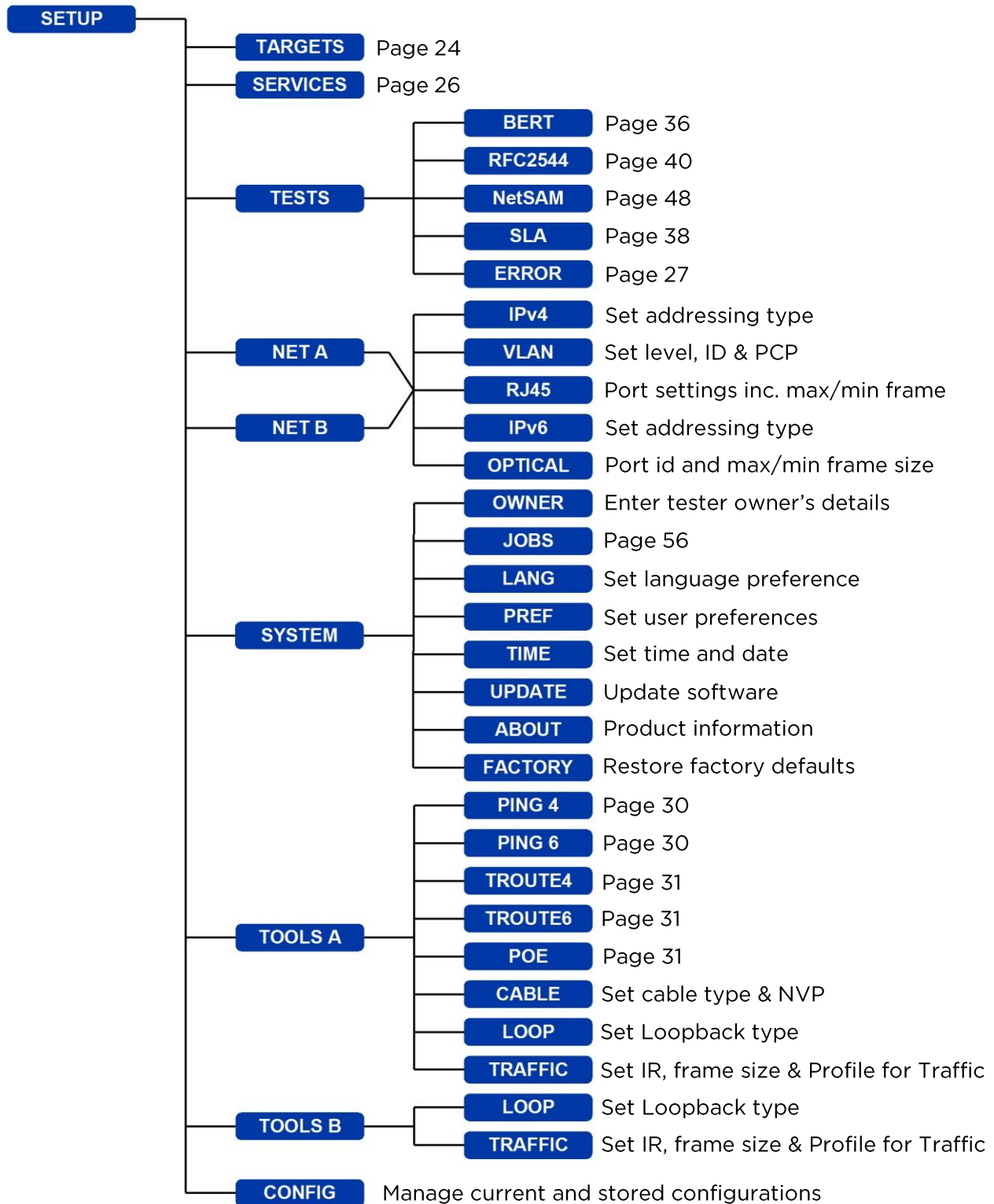

Fig 23



Targets

Select this option to access a table from where you may enter, edit, delete and remotely configure up to 10 targets. The targets you save here can be quickly selected when running tests.

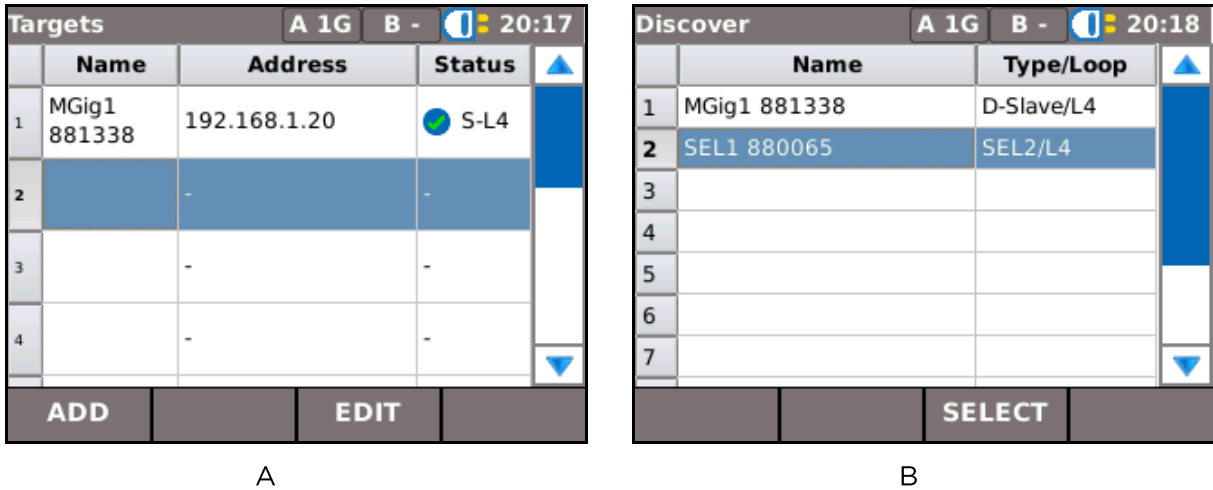

Fig 24

To add targets proceed as follows: From the home screen select SETUP>TARGETS – the ‘Targets’ screen is shown on the display (Fig 24A). Select ADD (F1) and a pop up dialog gives you the choice of searching for IDEAL targets or to configure the search manually. Select SEARCH from the pop up dialog and after a scan the Discover screen is shown on the display, Fig 24B.

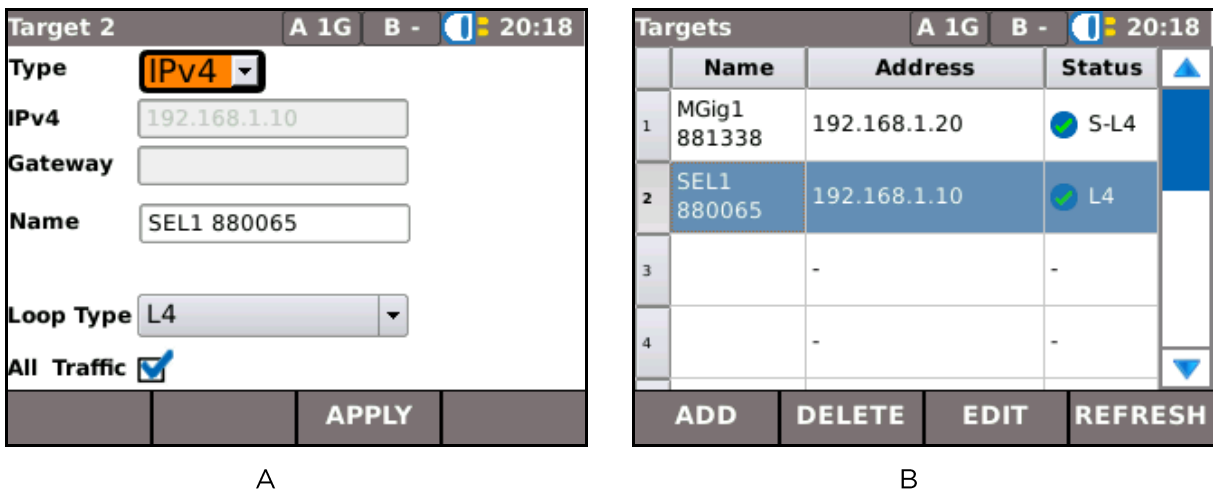

Fig 25

On the Discover screen, highlight the target you wish to add and select SELECT (F3). The new target screen appears, Fig 25A, where you can reconfigure some of the new targets details before you add it to the target list. Select APPLY (F3) and the ‘Targets’ screen is shown on the display again but with the new target added, Fig 25B.



To make a visual confirmation of a SEL1 target, from the 'Targets' screen (Fig 25B):- Highlight the SEL1 and select EDIT (F3) and the display shows the 'Target #' screen for the SEL1's details (Fig 26). Select FLASH LEDS (F4) and the five Layer LEDs on the SEL1 handset will flash together. This quickly enables you to physically identify the unit.



Fig 26

To delete a target from the Targets list use the tester's arrow keys to highlight the device to be removed and then select DELETE (F2), a pop up dialog asks for confirmation, select 'Yes' and the target is removed from the list.

To reconfigure a SEL1 target see *Remote Control, MGig1 to SEL1* on page 29.



Services

Select SETUP>SERVICES; the 'Services' screen is shown on the display. From here you may define the characteristics of up to eight services. Select a service from the list, the screen changes from 'Services' to 'Service' (Fig 27) and shows the factory default settings. Once you have entered your own settings they will remain unchanged until edited. Settings can be exported to, or imported from another MGig1 handset via the CONFIG facility, see page 59.

The choices made and values entered here will define the composition of each Ethernet frame generated by MGig1 – see *Ethernet frame structure and Layers* on page 15.

Name Allocate a name to each service when required. E.g. CCTV, Email, Video etc.

Protocol Choose from TCP, UDP, ICMP.

IP Set source/destination as local/from target or define your own. When you define your own destination (Custom) it overrides the target selected in a test. When required, each service may be set with a different address, i.e. eight separate targets. You must manually enter the address for each.

MPLS Enable or disable.

LLC/SNAP Enable or disable.

VLAN Set VLAN to Local or Custom.

MAC Set source/destination as local/from target or define your own.

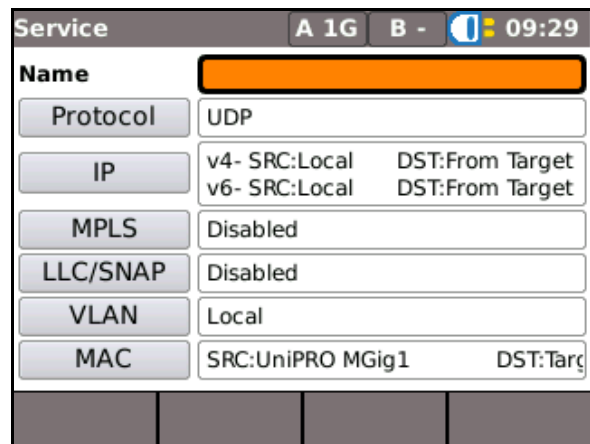

Fig 27

By default the source IP/MAC will be taken from the Target and the destination IP/MAC will be taken from the tester itself. These can be overridden to simulate traffic coming from multiple sources (editing the source IP/MAC) or to force traffic to multiple destinations (editing the destination IP/MAC).



Test data/Error inject

Each of the four transmission tests allow for errors to be injected while the tests run.

To set up Error Inject, from the home screen select SETUP>TESTS>ERROR and the 'Setup:Inject' screen is shown on the display (Fig 28). From the three dropdown lists set:

Error type:

FCS (Frame Check Sequence) helps determine the way the network responds to errors - expect frames with FCS errors to be discarded.

Pattern is a bit error. Frames that contain these errors should return. A reason to inject pattern errors is to confirm that the tester is counting bit errors correctly - e.g. if two errors are injected, two should be recorded.

Oversize or Undersize will inject frames of a size that is one byte greater than the maximum or, one byte less than the minimum set in SETUP>NET>RJ45.

Errors: Single or Ratio.

Select 'Single' and while a test runs, each time you press INJECT (F3) (Fig 29) one error is injected.

Select 'Ratio' and while a test runs, when INJECT (F3) is pressed errors are injected until you press F3 again to stop them (Fig 30).

Ratio: Can be set from 1 in 10 to 1 in 10¹³ (steps in powers of 10). Sets the limit for ratio of errors to be injected - e.g. if set to 1 in 10, then one error is injected for every 9 good frames or bits.

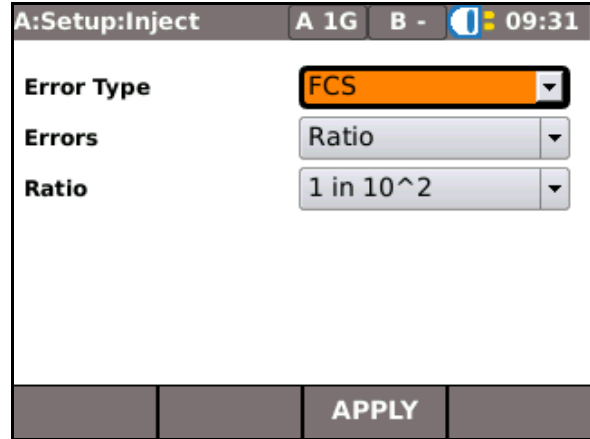

Fig 28

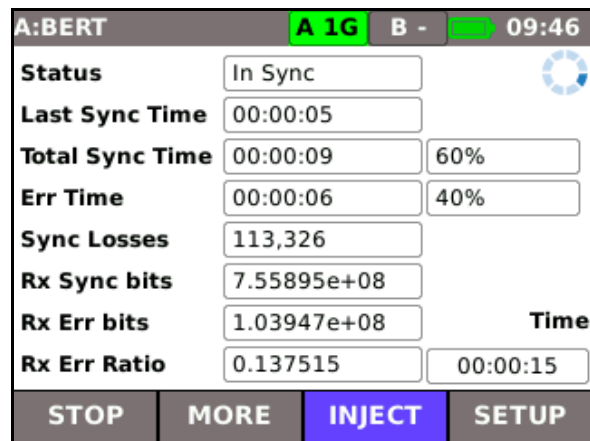

Fig 29



Fig 30



Remote control

MGig1 to MGig1

A second MGig1 can be set in slave mode. In slave mode, MGig1 can replicate a SEL1 and be used as a loopback unit, or it can be remotely configured and used as a second tester in bi-directional tests – see *Transmission testing concepts, General*, on page 14.

To put the second MGig1 in Slave Mode:

From the home screen select TESTS and then select the SLAVE icon. Select RUN (F1) to enter Slave Mode (Fig 31). This MGig1 is now the slave.

From the master MGig1:

Select SETUP>TARGETS and the ‘Targets’ screen is shown on the display. Select ADD (F1) and a pop up dialog gives you the choice of searching for IDEAL targets or to configure the search manually. Select SEARCH from the pop up dialog and after a scan the ‘Discover’ screen is shown on the display. Highlight the MGig1-Slave and select SELECT (F3). The ‘Target #’ screen is shown on the display. Select APPLY (F3) and the tester returns to the ‘Targets’ list which now includes the recently discovered MGig1 (Fig 32).

For **Bi-directional** tests you must set the slave MGig1 to ‘No Loop’ as follows:

Select SETUP>TARGETS, the ‘Targets’ screen is shown on the display.

Use the arrow keys to navigate to the slave MGig1 and select EDIT (F3), the ‘Target #’ screen is shown on the display (Fig 33). Select No Loop from the dropdown list and then select APPLY (F3).

NOTES

1. When MGig1 is in slave mode and used as a loopback device, it can be remotely configured in the same way as a SEL1. See *MGig1 to SEL1* on page 29.
2. To exit slave mode select the MASTER icon.
3. Remote control and target discovery use UDP port numbers 1467 and 3653

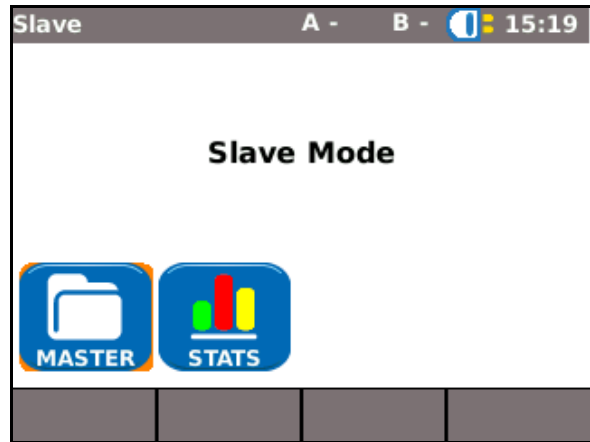

Fig 31

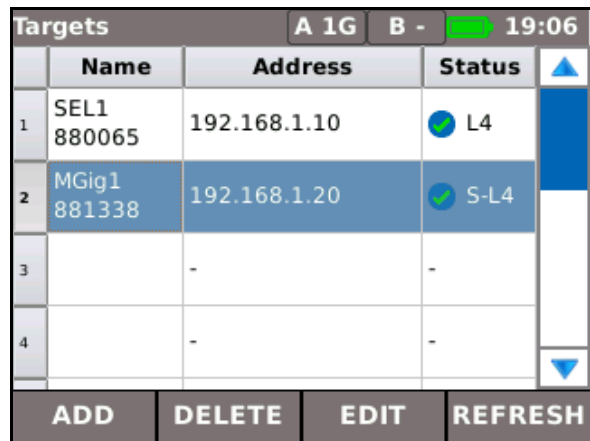

Fig 32

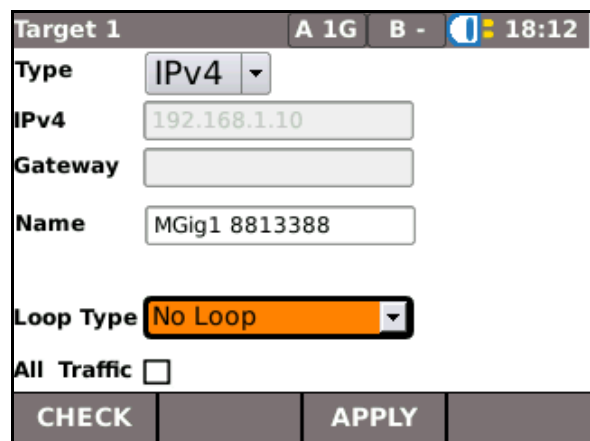
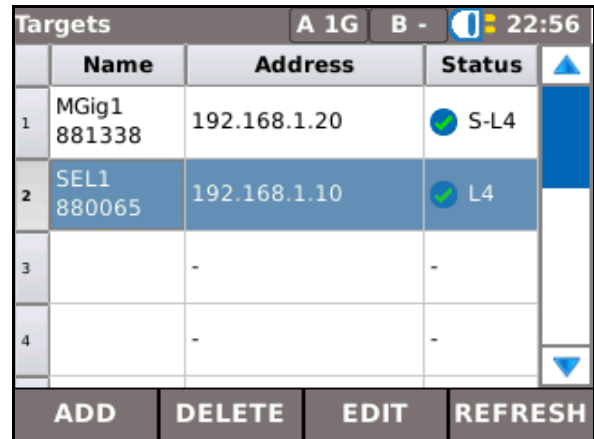

Fig 33

MGig1 to SEL1

From the home screen select SETUP (F4) and then select the TARGETS icon. All SEL1 handsets (and any other devices) previously discovered will appear on the Targets list as illustrated in Fig 34. Highlight the SEL1 you wish to control and select EDIT (F3), the screen changes from 'Targets' to 'Target #', Fig 35, and the SEL1's main details are listed. Select CONFIG SEL1 (F2) and all of the SEL1's configurable details appear, Fig 36. Configure SEL1 as required and select APPLY (F3). The SEL1's configuration will be updated and the SEL1 handset will reboot.



Targets			
	Name	Address	Status
1	MGig1 881338	192.168.1.20	S-L4
2	SEL1 880065	192.168.1.10	L4
3	-	-	-
4	-	-	-

ADD DELETE EDIT REFRESH

Fig 34



Target 2 A 1G B - 21:47

Type: IPv4

IPv4: 192.168.1.10

Gateway: [Empty]

Name: SEL1 880065

Loop Type: L4

All Traffic:

CHECK CONFIG SEL1 APPLY FLASH LEDES

Fig 35

When an additional SEL1(s) has been connected to the network and it does not appear on the Targets list:- Select ADD (F1) and a pop up dialog gives you the choice of searching for IDEAL targets or configure the search manually. Select SEARCH from the pop up dialog and after a scan the 'Discover' screen is shown on the display, highlight the additional SEL1 and select SELECT (F3). A new target screen appears where you can reconfigure some of the new target's details before you add it to the target list. Select APPLY (F3) and the 'Targets' screen is shown on the display again but with the new target added.

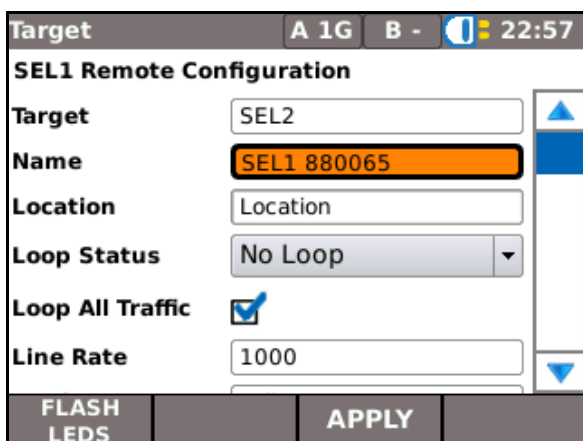

Target A 1G B - 22:57

SEL1 Remote Configuration

Target: SEL2

Name: SEL1 880065

Location: Location

Loop Status: No Loop

Loop All Traffic:

Line Rate: 1000

FLASH LEDES APPLY

Fig 36

SEL1 Loop layer

The SEL1's loop layer can be changed without the need to reconfigure as follows: Highlight the SEL1 on the Targets list (Fig 34), select EDIT (F3) and the 'Target #' screen is shown on the display, Fig 35. Loop Type can be set from a drop down menu. Choose the Loop type you require and whether to loop all traffic, select APPLY (F3) and the loop layer on the SEL1 changes immediately.



Tools



Ping4 and Ping6

Ping will test the availability and measure the response times of URLs and detected devices.

Both IPv4 and IPv6 addresses can be pinged. The figures below show a Ping4 set up and test screen. Set up and test results for Ping6 are similar.

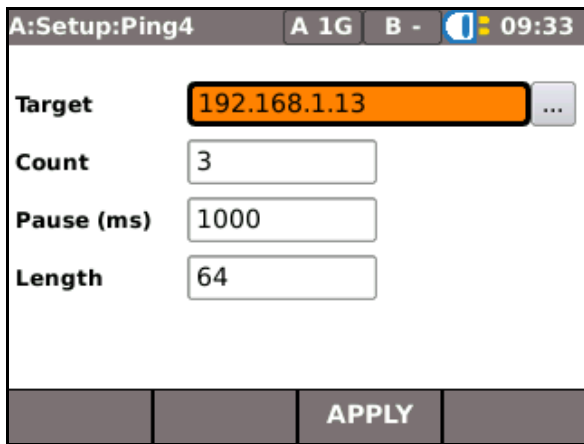

Fig 37

To set up Ping select SETUP>TOOLS A>PING4 (or PING6). From here you can:

- Set the target URL/Numerical address (select from up to 10 targets stored in the IPv4 or v6 TARGET look up table or edit the URL currently shown on the display),
- Count (Number of times to repeat the Ping - 1 to 999999),
- Pause (Interval between successive Pings - 1 to 5 seconds),
- Length (Number of bytes in Ping frame payload - 8 to 1000 bytes).

The results of a ping test are shown in Fig 38. The range of possible results are:

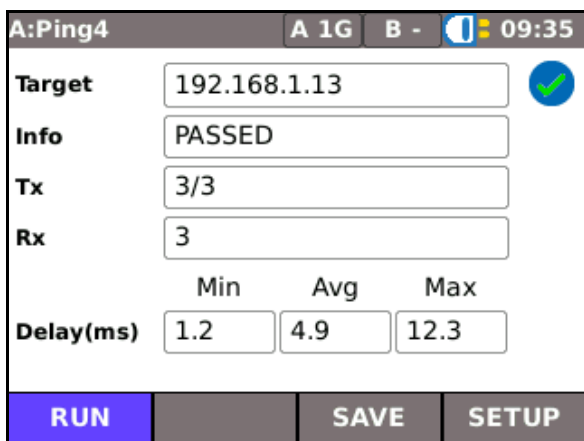

Fig 38

- Info: READY, IN PROGRESS, PASSED, NETWORK UNREACHABLE, UNKNOWN HOST.
- Tx: Count of transmitted ping frames: 1 to 999999.
- Rx: Count of successfully received Ping responses: 1 to 999999.
- Delay: Round trip delay in ms between transmitting Ping and receiving response. Shown on the display as Minimum, Average and Maximum.



TRoute4 and TRoute6

Trace Route will display the route and measure transit delays of frames across an IP network.

Press the soft key SETUP (F4) to enter the target or select one from the IPv4 or v6 Target list, and to view or amend the test settings.

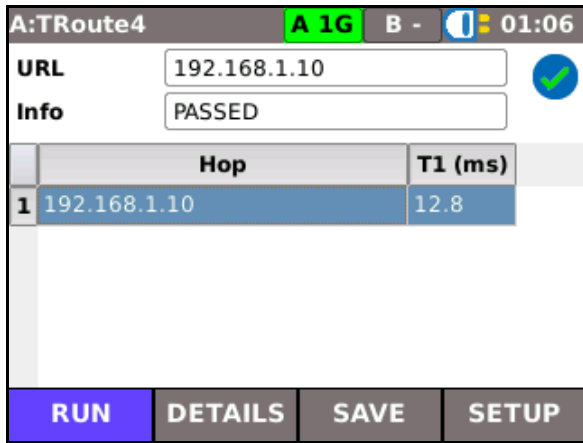

Select an individual hop to view its statistics.

The soft keys PREV (F1) and NEXT (F3) are used to navigate between individual hops.

Each hop is traced three times. The time recorded during each trace is shown on the display in ms as T1, T2 and T3.

Fig 39



PoE

When MGig1 is connected to a port it automatically detects PoE voltage (when present). In addition, running a PoE test will apply a resistive load and measure the power available at the connected port. MGig1 identifies which pairs are carrying power, and displays the voltage(V), current(mA) and power(W). The PoE test result screen at Fig 40 shows that pair one and two, and pair three and six are carrying 11 Watts. The port tested is capable of powering devices that require upto 11 Watts.

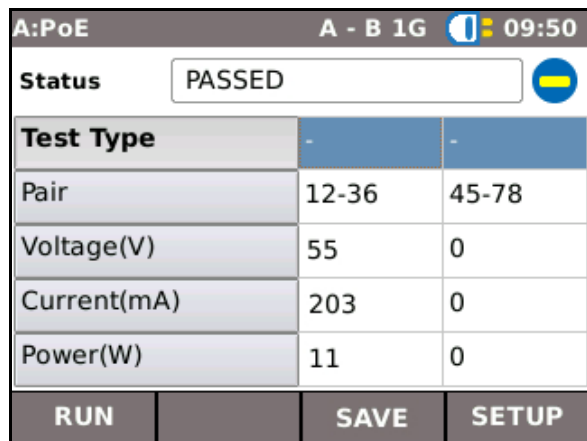

Fig 40

The test is PASSED because the power available is \geq the minimum power value entered at set up.



Blink

A Hub Blink test forces the connected port of a network device to blink. MGig1 also changes the speed and therefore LED color (on supporting devices) making it easier to identify the correct port. Select the BLINK icon from the Tests screen, the test is started and stopped with the soft key F1 which displays as RUN or STOP accordingly.



Cable

The Cable test reports the following information about the each of the pairs in the cable that is connected to the relevant RJ45 Port:

- Status (Blank = no fault found / Short = short circuit pair / Open = open circuit pair)
- Skew (The propagation delay time difference between each pair amongst four pairs when a signal is travelling through the active link. For 1Gb/s, 100m cable link, the skew on each pair should be less than 50ns.)
- Polarity (Positive = normal connection / Negative = crossed pair)
- MDI (MDI indicates that the connected port can only accept a normal directly wired cable / MDIX indicates that the connected port can tolerate a crossover cable.)
- Length (The distance of each pair from a short or open circuit end.)

In Cable SETUP the following parameters may be set:

- Cable Type (Select the Category of cable. This setting has no effect on the test. It is only recorded in the Reports.)
- NVP (The propagation velocity of signals through the cable, which is used for the Length measurement. Either use the default value or set the Custom NVP (%) according to the cable specification.)



Traffic generation

To set up traffic generation proceed as follows:

From the home screen select: SETUP (F4). Select the TOOLS A icon to set up traffic on the primary ports, or the TOOLS B icon to set up traffic on the secondary ports. Select the TRAFFIC icon and the 'Setup:Traffic' screen (Fig 41) is shown on the display.

For models with secondary ports traffic can be generated on the B port while tests are run from the A port.

Select a target from the dropdown list and set the duration you wish to generate traffic for. Targets are added, edited or deleted from SETUP>TARGETS; *page 24* refers.

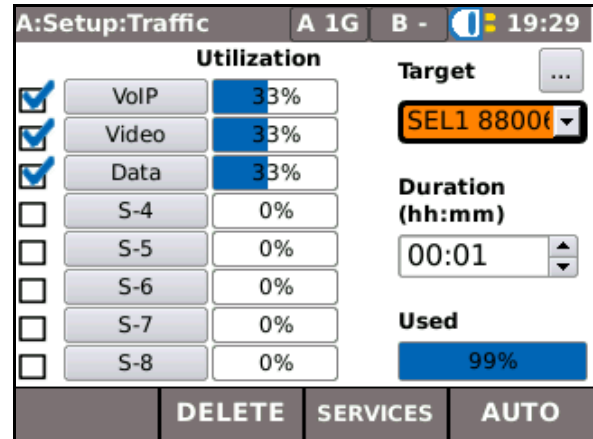

Fig 41

The addressing and protocol for each service is set at SETUP>SERVICES. The service settings available from the Setup:Traffic screen (Fig 41) are related to how much bandwidth each service takes and the information rate, frame size and fill. To adjust the settings for each of the eight services, select the Service, 1 to 8, and the Limits screen for that service is shown on the display, Fig 42.

Info Rate: Enter a value in Mb/s. MGig1 will calculate the maximum info rate per service based on the info rate of other services, and the frame size. You may enter less than the maximum. When Services set up is complete, the percentage bandwidth used is displayed at the bottom of the 'Setup:Traffic' screen under 'Used'.

Free Info Rate and Bandwidth Rate are calculated and displayed for information only (Free Info Rate is the maximum rate that you can allocate to the particular service).

Bandwidth Utilization: The bandwidth used by the particular service, displayed as a percentage.

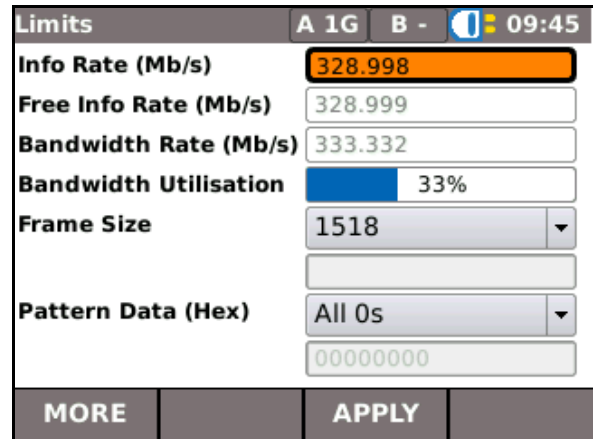

Fig 42

Frame Size: Choose from the dropdown list. A larger frame size means less frames and therefore less overhead and more space for payload.

Pattern Data (Hex): Choose the pattern of data to fill the payload from the dropdown list.



For Service 1 only, select MORE (F1) and choose from three Traffic profiles:

Continuous: This profile will generate traffic evenly and continuously for the entire duration set at the 'Setup:Traffic' screen.

Ramp: Sets MGig1 to generate traffic at an information rate that increases or decreases at stepped intervals. The ramp can be set with the controls that follow.

- Start Info Rate – set from 0.1 to 1,000 Mb/s
- Stop Info Rate – set from 0.1 to 1,000 Mb/s
- Gap – set from 1 to 1,000,000 μ s (interval between steps)
- Steps – set from 1 to 10,000 (No of steps)
- Step Size – set from 1 to 1,000,000 frames

Because the Step Size is set as a number of frames rather than a time period, the ramp profile is non-linear.

If the Stop Info Rate is higher than the Start Info rate, the ramp increases the Info rate over time.

If the Stop Info Rate is lower than the Start Info rate, the ramp decreases the Info rate over time.

Burst: This profile propagates traffic of a set size and interval:

- Size – set from 2 to 1,000,000,000 frames (duration of burst)
- Gap – set from 1 to 1,000,000 μ s (interval between bursts)

The selected Traffic profile remains until it is reset by you.



To generate Traffic, from the home screen select the TESTS>TOOLS (A or B)>TRAFFIC - the 'Traffic' screen Fig 43A is shown on the display.

NOTE

MGig1 Duo models have TOOLS A or TOOLS B, choose whether to generate traffic on the primary (A) or secondary (B) ports.

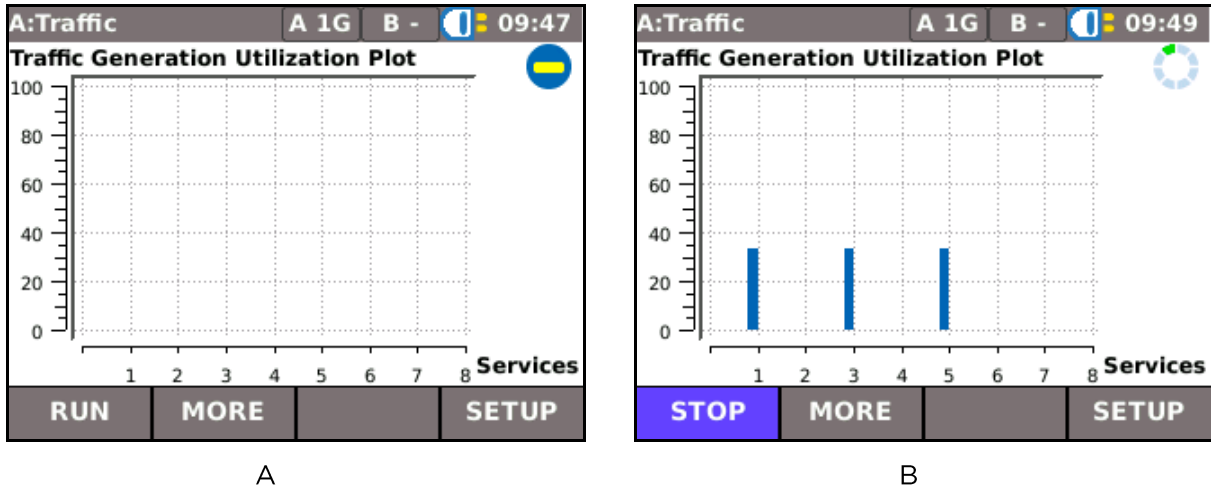

Fig 43

From the 'Traffic' screen, Fig 43A, select RUN (F1) to start generating traffic. The Traffic Generation Utilization Plot will indicate the bandwidth utilization for each service (Fig 43B). Select MORE (F2) to display the same data as a table.



Transmission tests – set up and run

There are four transmission tests available on MGig1 - BERT, SLA-Tick, RFC2544 and NetSAM. MGig1 offers numerous options for the set-up of each test and the descriptions that follow are not exhaustive but a general guide to the user.



BERT

Bit Error Ratio Test (BERT) checks the frame's payload for bit errors and reports them as a ratio of the total data received. For additional information see *BERT* on page 19.

To set up BERT on MGig1 proceed as follows: From the home screen select SETUP (F4). Select the TESTS and then the BERT icon – the 'Setup:BERT' screens (Fig 44) are shown on the display. Select MORE (F1) to toggle between screens.

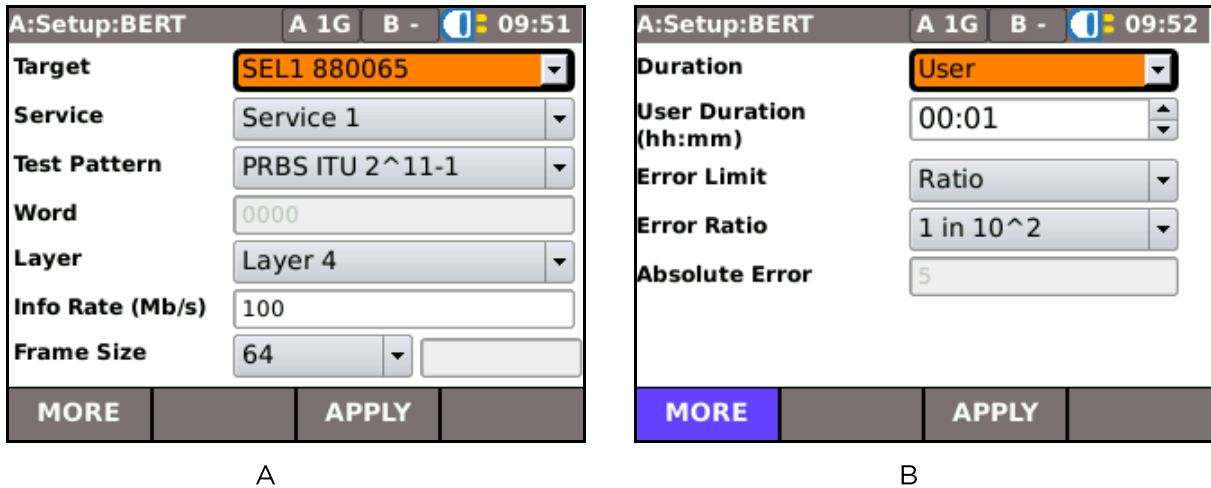

Fig 44

Target Select a target from the dropdown list. When testing over Layer 1 a target is not required.

Service BERT runs on one service only. Choose a service from the dropdown list. Note that when the service selected has been setup with a Custom target (via SETUP>SERVICES) different to that chosen from the Target list (above), then the target associated to the service will be used.

Test pattern Choose one of the test patterns from the dropdown list to fill the payload. When the 'Word' pattern is selected, enter a 4-digit hexadecimal number in **Word**.

Layer Select Layer 1 for physical, non-addressable loop. Select Layers 2 to 4 according to the size of payload required. See *Ethernet frame structure and Layers, paragraphs 1 & 2, page 15*.

Info Rate Enter the Information Rate in Mb/s to set how much of the bandwidth you want to use for BERT.

Frame Size Select frame size from the dropdown list. The larger the frame size, the more bandwidth remains for payload.

Duration Choose 'continuous' when you want the test to run until you select STOP (F1). Choose 'User' and then specify a period of up to 24 hours in **User Duration**.



Error Limit, Error Ratio and Absolute Error

- Set the Error Limit to 'Ratio' and then choose a ratio from the range 1 in 10 to 1 in 10¹³ (steps in powers of 10). The chosen ratio becomes the limit beyond which the test is failed.
- Set the Error Limit to 'Absolute' and then enter the error limit as a value from 1 to 999.

To **RUN BERT**: from the home screen select the TESTS icon and then the BERT icon - the BERT test screen 'BERT' is shown on the display.

Select RUN (F1) to start the test.

Status should read 'In Sync'. If it reads 'Out of sync' make sure that the Layer chosen at BERT setup matches the Layer set on the SEL1 (or other loopback device).

Last Sync Time is a counter that runs from the last time that sync was regained after a Sync Loss. When sync is not lost by the time the test is complete (or stopped), Last Sync Time will equal Total Sync Time.

Total Sync Time is the total time that the test was in sync - expressed as a percentage of the test duration, and also in hours, minutes and seconds. When no errors/sync losses occur during the test, Total Sync Time will be equal to Time (test duration). Each error/sync loss will cause the counter to stop until sync is regained.

Err Time is the time that the BERT pattern was out of sync since the start of the test - expressed as both a percentage of the test duration, and in hours, minutes and seconds.

Sync Losses Number of times the pattern has gone out of sync.



Fig 45



Fig 46

Rx Sync bits Number of received bits that have remained in sync, expressed in powers of 10, e.g. 6.46168e+08 = 6.46168 x10⁸.

Rx Err bits and Rx Err Ratio Received errored bits as an absolute value or as a ratio. When these values exceed the limit you entered at setup the test is failed.

Target, Service, Test Pattern and Layer are confirmation of the choices made at setup.

Severely Err Seconds Number of severely errored seconds counted during the test.

Fig 45 and Fig 46 show the BERT test screens after a test has been run. The results show that the test ran for 60 seconds and that for four seconds the BERT pattern was out of sync. Although errors were recorded, the error ratio of 0.0076576 does not exceed the error ratio limit of 1 in 100 specified at set up - see Fig 44B. Therefore, the test is passed.

The summary LED in the information bar at the top of the screen lights green when sync is achieved. It will change to red on error or sync loss, then orange to indicate historic error.



SLA Tick

The Service Level Agreement (SLA) Tick test can use up to eight services, the utilization of each service is chosen at set up.

To set up SLA-Tick on MGig1 proceed as follows:

From the home screen select SETUP (F4). Select the TESTS and then the SLA-TICK icon – the ‘Setup:SLA-TICK’ screen is shown on the display (Fig 47).

Select a **Target** from the dropdown list and set the **Duration** that you require. Note that the addressing and protocol for each service is set at SETUP>SERVICES.

Select MORE (F1) and set the Wait Time – i.e. the time that the tester waits at the end of each sub-test for the last frames to arrive before it starts the next sub-test.

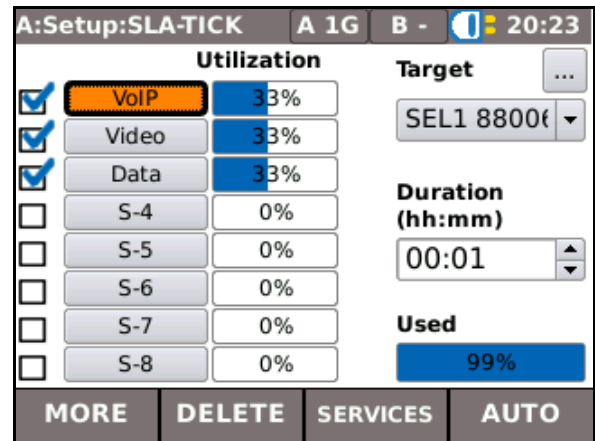
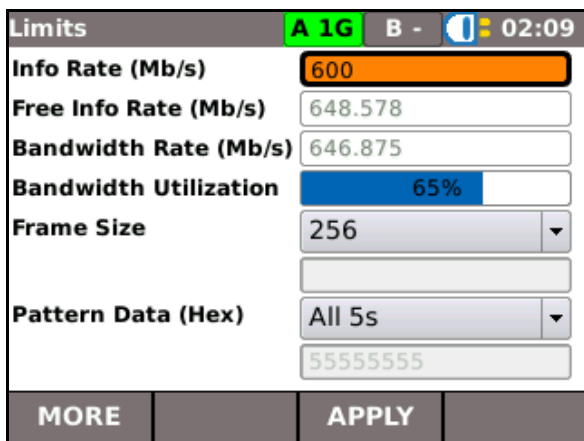

Fig 47

For each Service that you wish to use, proceed as follows:

Select the service, e.g. Service 1, the ‘Limits’ screen is shown on the display (Fig 48 A & B). Enter the **Info Rate**, **Frame Size** and **Pattern Data**. As you set the Info Rate, both the percentage used by that service (**Bandwidth Utilization**) and the percentage that remains available for other services are shown. Bandwidth Utilization is affected by Frame Size as well as Info Rate – a larger frame size means fewer frames and therefore less overhead.

The second Limits screen, Fig 48B, allows you to set the values that may be stated in the Service Level Agreement. E.g. if you have set the characteristics of Service 1 to mimic Video Transmission applications, the values you set for **Info Rate**, **Latency** and **Jitter** etc. against that service, could represent the SLA.



A

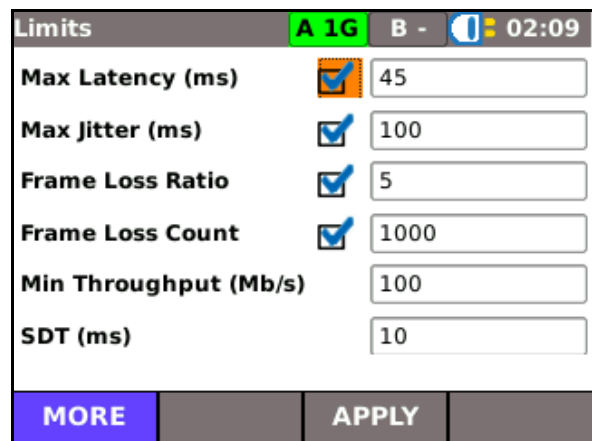

B

Fig 48

The values permitted for the Limits shown on Fig 48B are:

- Max Latency – 0 to 10,000,000 μ s.
- Max Jitter – 0 to 2,000,000 μ s.
- Frame Loss Ratio 0 to 1.
- Frame Loss Count – 0 to 1,000,000,000.

Results

Fig 49 shows SLA Tick test result screens. The screen, 'A', confirms the target and that the test is Passed, i.e. is below all limits and meets all criteria specified at set up. Select the buttons shown on screen 'B', and test results are shown on the display as a series of graphs and tables. MORE (F2) toggles between the two screens.

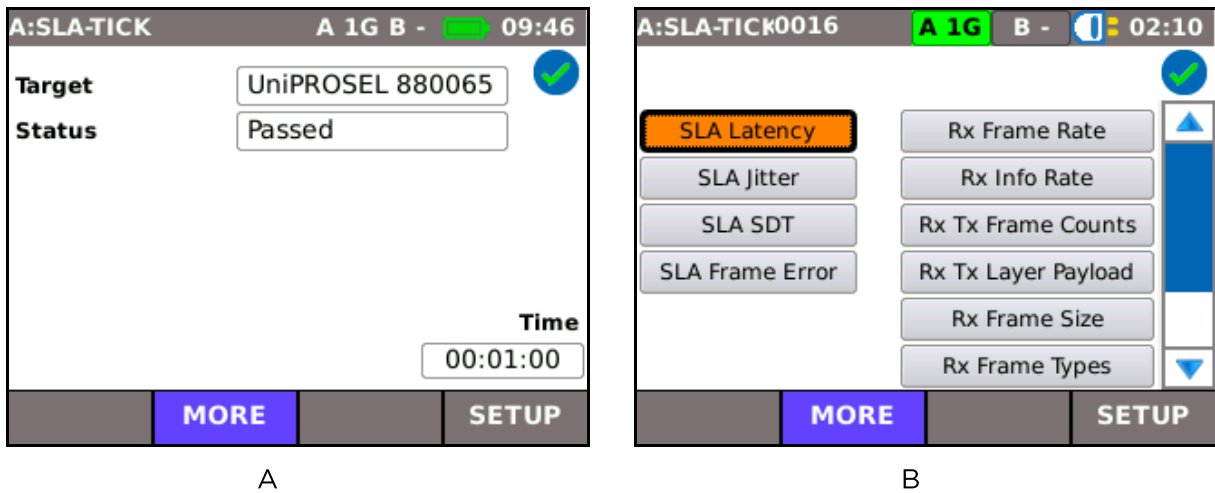

Fig 49

SLA Frame Error, Rx Tx Frame Counts, Rx Tx Layer Payload, Rx Frame Size, Rx Frame Types, Rx Errors and Rx Errored Time are shown as tables only, all other results are shown as tables and graphs.

For each of the graphs (Latency results are shown at Fig 50), the x-axis represents each of the eight services, the y-axis records the quality being measured. TABLES (F3) present the same information but values are shown in numerals.

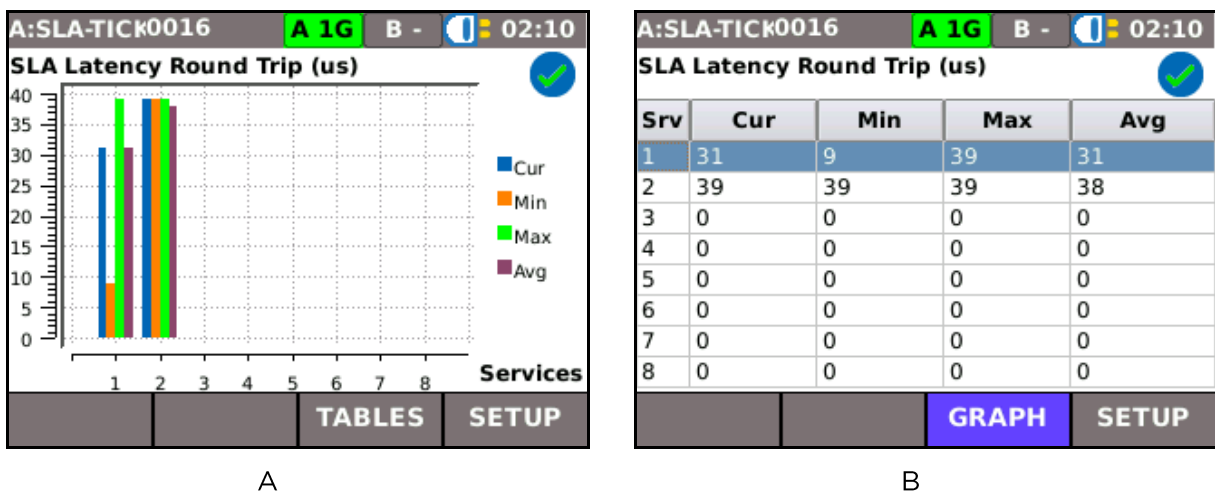

Fig 50



RFC2544

RFC2544 is a testing methodology that comprises six subtests. RFC2544 uses Layer 4 frame headers. Background information for the subtests can be found under the RFC2544 section of Ethernet transmission testing methods on page 19. Set the test's main parameters as follows: From the home screen select SETUP>TESTS>RFC2544 and the 'Setup:RFC2544' screen is shown on the display (Fig 51).



Fig 51

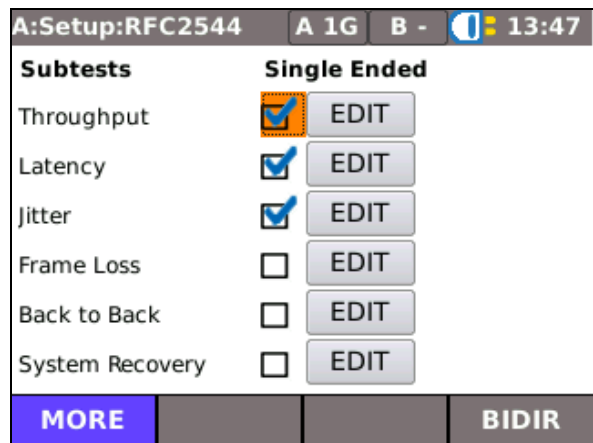

Fig 52

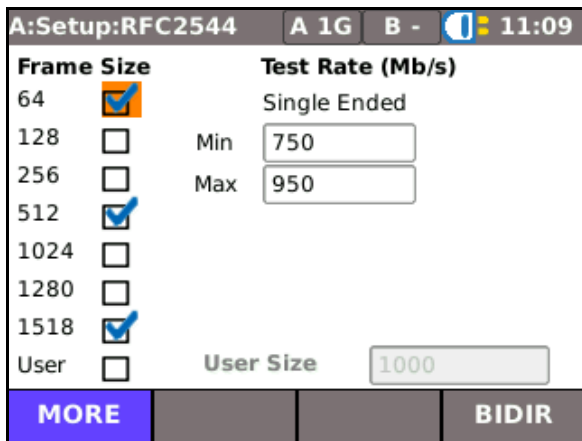

Fig 53

Select a Target and Service from the drop down lists and enter Pattern Data for the frame's payload - up to eight hexadecimal characters.

Direction is reported as Single Ended or Bidirectional dependent on whether a second MGig1 is selected as the target.

Select PROFILE (F2) to set the test to Super-Fast, Fast or Full.

Select MORE (F1), Fig 52, and tick the check boxes against the subtests you require; throughput must be selected.

Select F4 to choose between:

- SINGLE - Single Ended (loopback), or
- BIDIR - Master to Slave and Slave to Master.

Select MORE (F1), Fig 53, and below Frame Size tick the checkboxes next to the frame size(s) that you want the test traffic to comprise of. The standard frames sizes are shown in Fig 53, for systems that support larger frame sizes check the 'User' Frame Size and enter the size in the adjacent field. All subtests are run separately for each selected frame size.



Below **Test Rate** enter a value in the range, 0.1 to 1000 Mb/s. When the test is run, MGig1 will find the maximum rate that the network can support in the chosen range by using a binary search pattern.

Set the parameters for the individual subtests from the **EDIT** button next to the subtest's name as illustrated in Fig 52.

When all general and subtest parameters are set, the RFC2544 test can be run. From the home screen select TESTS>RFC2544 - The 'RFC2544' screen is shown on the display (Fig 54).



Fig 54

The Service, Target and Direction that you have entered at set up are listed. The Direction is determined by the target. If target is MGig1 Slave then Bidirectional will be selected otherwise single ended will be selected. The estimated duration is shown as a range in hours, minutes and seconds. In addition to the test PROFILE, the duration is proportional to the parameters you have entered. Changing the test PROFILE and the values entered for each subtest will affect the duration of the test.

Throughput

Throughput uses a binary search to discover the maximum frame rate at which the network under test will operate without excessive lost frames. The test starts by sending frames at the maximum value in the range 'Test Rate' as described above. If too many frames are lost, the test is repeated at a lower frame rate. This process continues until the maximum throughput is determined. The binary search reduces the throughput value by decreasing steps: 50%, 25%, 12.5%, 6.25% etc. The throughput is increased or decreased depending on the results of the previous test. MGig1 continues the binary search until throughput is calculated to within the specified **Resolution** - 0 to 50% (Fig 55A). The **Duration** can be set from 1 to 300 seconds; it is the period that each batch of frames is sent for. Set the percentage of lost frames that is acceptable for the test in '**Max Frames Lost**'. Set from 0 to 10%.

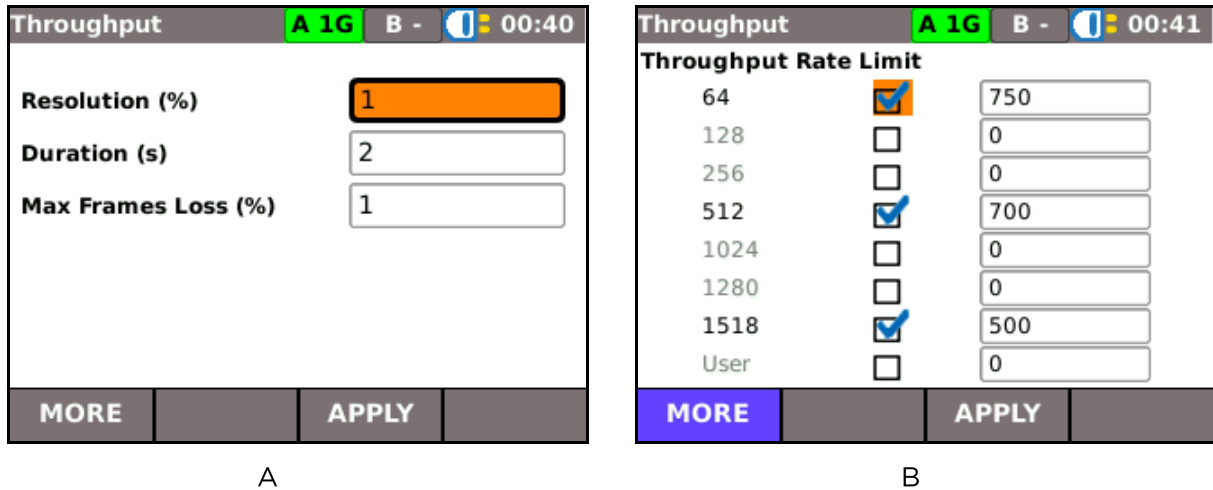

Fig 55

Choose the frame size(s) and throughput rate limit; see (Fig 55B). Tick the checkbox adjacent to the frame sizes you require for the throughput test and enter a rate limit in the field. When a value from a previous test remains in the field, it will be ignored if the checkbox is not ticked.

Throughput is calculated for each of the selected frame sizes and the test results are displayed as graphs and tables. The Rx Throughput Rate graph (Fig 56A) and table (Fig 56B) are shown below. Rx Frame Rate, Utilization and Frame Loss are also available as graphs and tables.

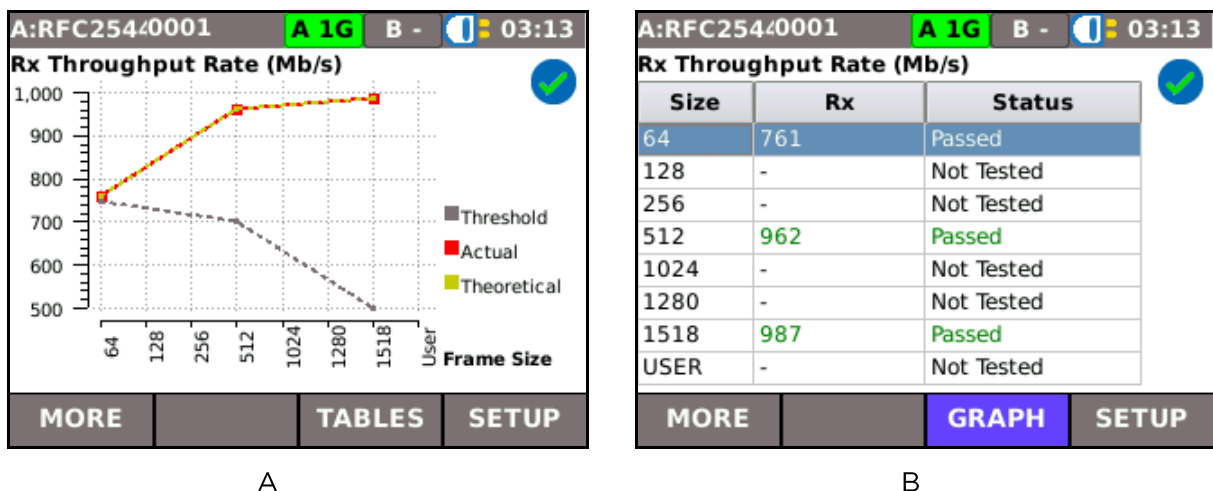

Fig 56

Latency

The Latency subtest measures the round-trip time taken by a test frame to travel across a network, through the loopback device and back to the tester. For protocols such as Voice over Internet Protocol (VoIP), a variable or long latency can cause degradation in voice quality.

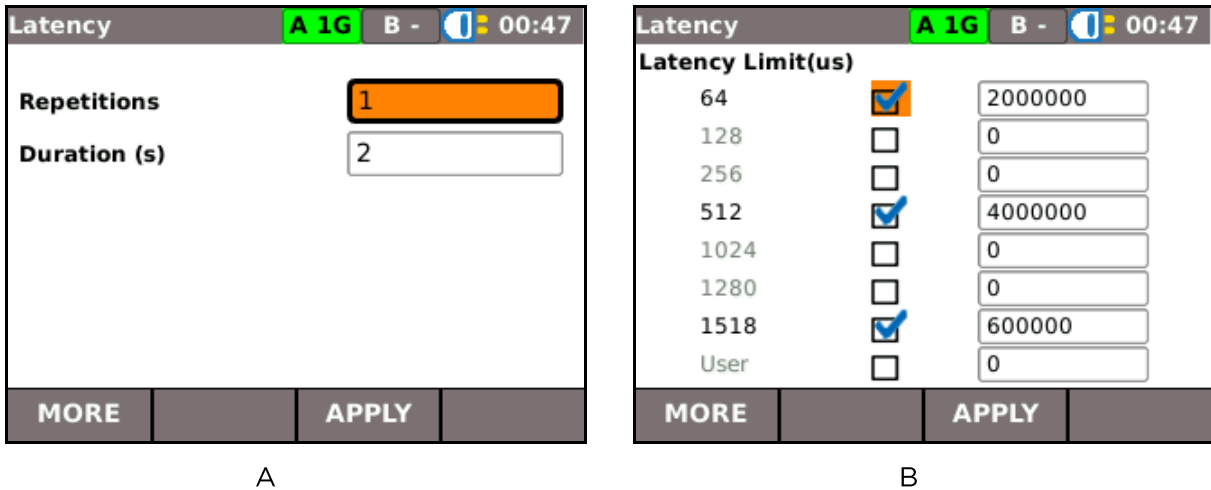

Fig 57

The throughput test will determine the throughput rate for the latency test. Set the **Repetitions**, 1 to 100, and the **Duration**, 1 to 300 seconds. Select MORE (F1) and tick the check boxes next to the frame sizes required for the test. Against each frame size, set the Latency Limit in μs , 0 to 10,000,000.

MGig1 presents Latency results as a graph that plots time (μs) against Frame size, and a table that shows the values for throughput against each frame size and the round trip time (min, average & max) in μs .

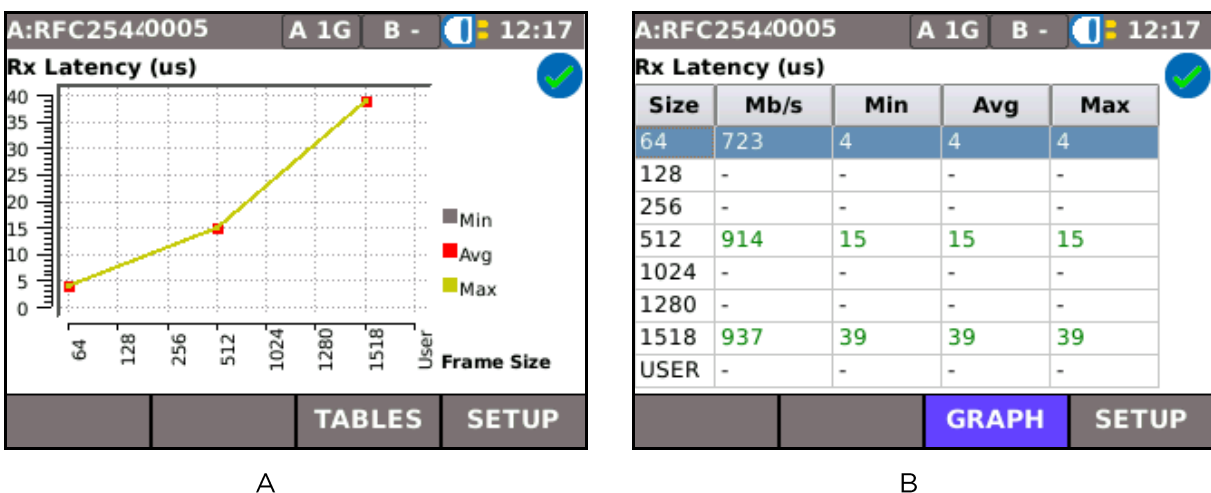

Fig 58

Jitter

Jitter is defined as variation in latency which can cause pixilation during video conferencing and degradation of sound quality to VoIP communications.

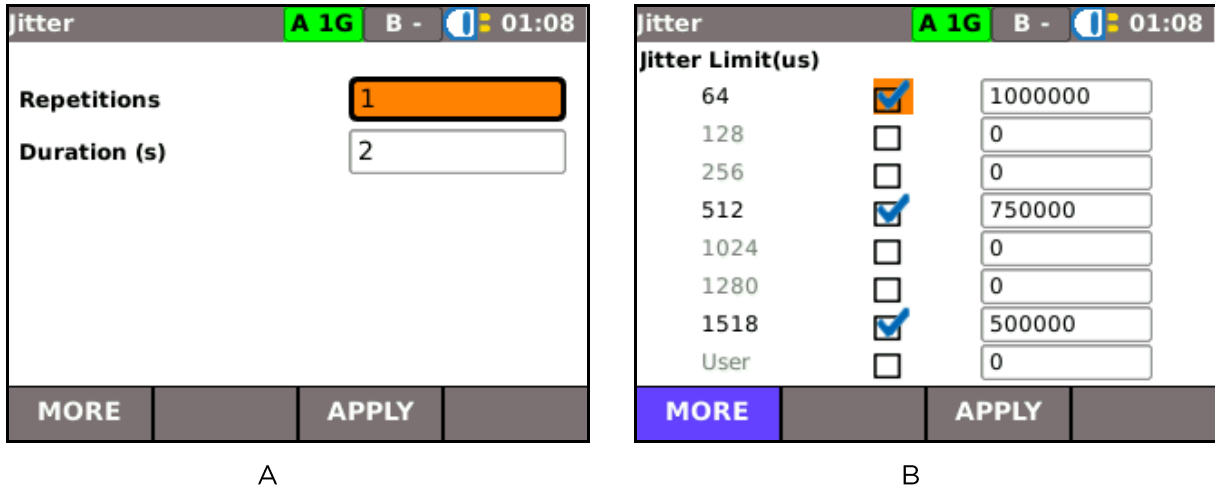

Fig 59

The test measures the minimum, maximum and average variation in latency for the frame sizes selected at set up.

Set the number of **Repetitions** (1 to 10) to test the network for Jitter and the **Duration** (1 to 300 seconds) for each repetition (Fig 59A). Select MORE (F1) and tick the check boxes next to the frame sizes required for the test (Fig 59B). Against each frame size, set the Jitter Limit in μ s, 0 to 2,000,000.

Results are provided as a graph that plots jitter in μ s against frame sizes, and as a table that lists the Min, Avg and Max time for each selected frame size (Fig 60).

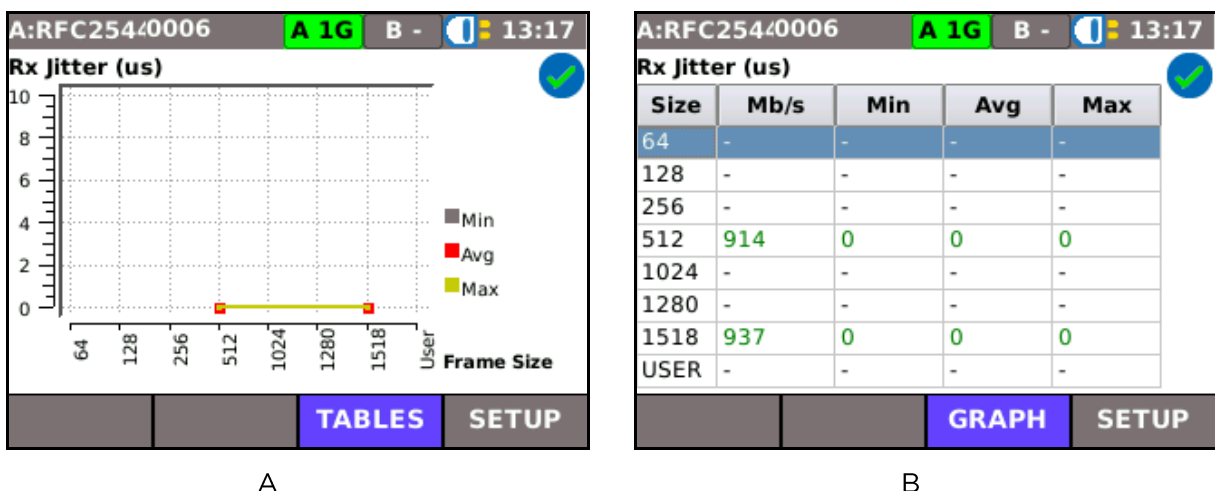

Fig 60

Frame Loss

Frame Loss is the percentage of frames that were not forwarded by the network due to lack of resources. This measurement can be used to report the performance of a network in an overloaded state and is a useful indication of how a network would perform in extreme conditions.

The frame loss test has the settings that follow:

- Granularity - 0 to 50%. The space between steps in utilization.
- Duration - 1 to 300 seconds. The period for which frames are transmitted.

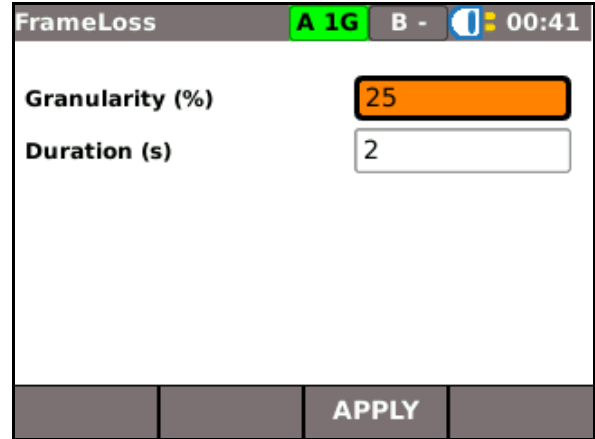

Fig 61

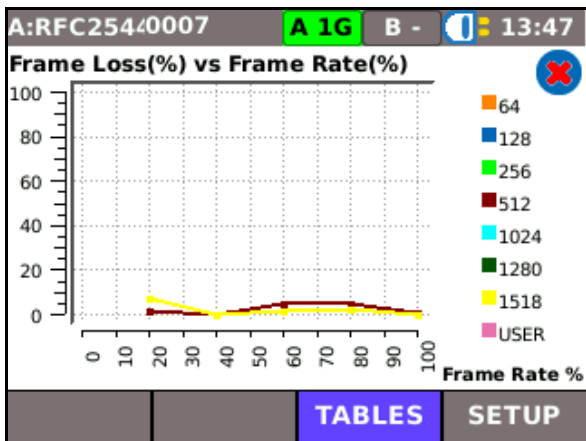
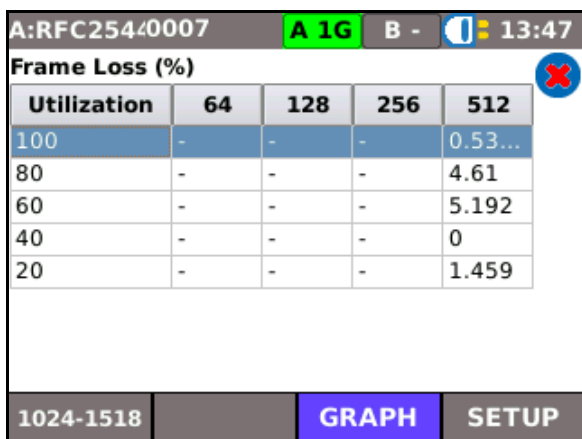

Fig 62

The frame loss test presents results as a graph that plots percentage Frame Loss against percentage Frame Rate (Fig 62). The function key F3 toggles between the graph and a table that lists percentage frame loss for each frame size at different network utilizations. The table is displayed over two screens, Fig 63A & B. The function key F1 toggles between the two screens.

The test finds the rate at which there is no frame loss. If this cannot be achieved the test fails.



Utilization	64	128	256	512
100	-	-	-	0.53...
80	-	-	-	4.61
60	-	-	-	5.192
40	-	-	-	0
20	-	-	-	1.459

A

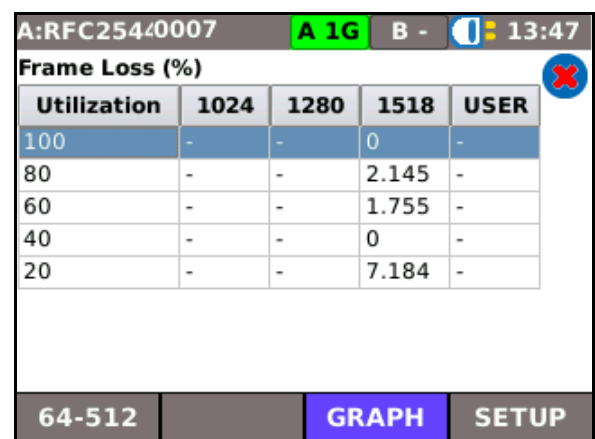

Utilization	1024	1280	1518	USER
100	-	-	0	-
80	-	-	2.145	-
60	-	-	1.755	-
40	-	-	0	-
20	-	-	7.184	-

B

Fig 63



Back to Back

This test determines the maximum number of back-to-back frames, with a minimal Inter-Frame Gap (IFG), that the network can support without losing frames.

For each frame size chosen at set up (Fig 53), the test sends a series of 'bursts'. The first burst contains a specified number of frames, subsequent bursts are then sent with more, or fewer, frames until MGig1 calculates the maximum number returned without error. The minimum and maximum number of frames in each burst is specified at the 'Back to Back' set up screen, Fig 64.

Min Burst and **Max Burst** are the minimum and maximum number of frames in each burst. **Repetitions** is the number of times that a series of bursts are sent. **Resolution** is a percentage of the specified number of frames.

The range for each variable is as follows:

- Min Burst - 1 to 1,000,000,000 frames
- Max Burst - 1 to 1,000, 000,000 frames
- Repetitions - 1 to 100
- Resolution - 0 to 50%

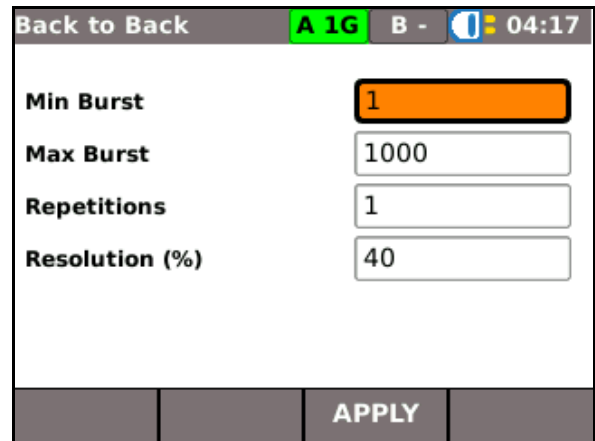

Fig 64

Size	Avg Frames	Max Frames
64	-	-
128	-	-
256	-	-
512	999	999
1024	-	-
1280	-	-
1518	1,000	1,000
USER	-	-

Fig 65

MGig1 presents the Back to Back test results as a table (Fig 65) that lists the average and maximum number of back to back frames, for each frame size tested, that the network can support.



System Recovery

The system recovery time is the time the network takes to stop losing frames when the frame rate is reduced from a stressed to a normal state. For a period specified at set up, MGig1 will generate traffic at a rate that is higher than the network can support, i.e. greater than the rate calculated at the throughput test. This causes the network to lose frames. Then, the traffic is reduced to less than the pre-determined throughput. The time between the drop in frame rate to the last lost frame is averaged over a user specified number of test runs for each frame size.

The range for each variable is as follows:

- Repetitions - 1 to 100. The number of test runs.
- Duration - 1 to 300. Period, in seconds, that excess traffic is generated.

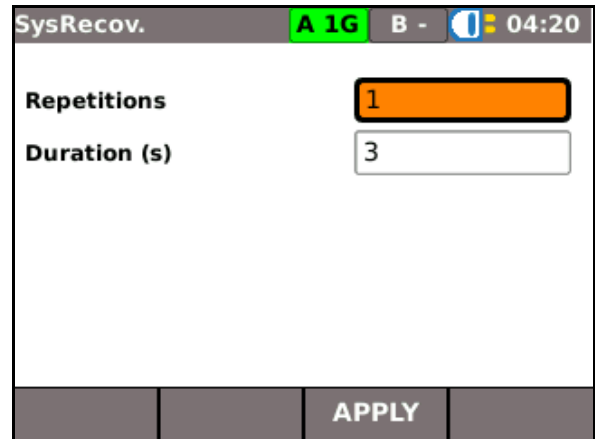

Fig 66

Size	Info Rate (Mb/s)	Time (us)
64	-	-
128	-	-
256	-	-
512	722.145	0
1024	-	-
1280	-	-
1518	740.48	0
USER	-	-

Fig 67

MGig1 presents the System Recovery test results as a table (Fig 67) that lists system recovery time in μ s for each frame size tested. The information rate shown is the rate MGig1 transmits in excess of maximum throughput.



NetSAM

NetSAM is IDEAL INDUSTRIES' implementation of the International Telecommunication Union's specification - 'Ethernet service activation test methodology' – Y.1564.

NetSAM comprises seven subtests, six designed to test service configuration, and one to test service performance. Services are selected and their characteristics configured at setup. Configuration is tested one service at a time, performance is tested with all services generated simultaneously. Refer to the Network under test's Service Level Agreement (SLA) as a guide to set up the tests and to help you decide the values you choose as limits to determine when the test is passed or failed.

Configuration test results are presented as tables that list the criteria that follow:

- IR - Information Rate (Mb/s)
- Frame Loss (as a count of lost frames - FL, and as a ratio - FLR)
- FTD - Frame Transfer Delay (Min, Mean and Max)
- FDV - Frame Delay Variation (Min, Mean and Max)

When a configuration test is complete, the results are shown on the display as four tables, one for each of the criteria above. MORE (F1) scrolls through the criteria. As up to eight services can be used within each sub-test, the soft keys NEXT and PREV are used to navigate between results for all services tested.

When errors in network configuration are identified they must be corrected and verified before performance tests are run.

In addition to the four configuration test criteria, the performance test measures Network Availability which a result table presents as percentage 'Available' time and percentage 'Unavailable' time. When the performance test is run, all services selected at setup are tested at the same time and the results for each service are shown as rows in the same table.

Unavailable time is defined as a period that begins at the start of not less than 10 consecutive Severely Errored Seconds (SES). A new period of available time begins at the start of 10 consecutive non-SES. Fig 68 illustrates the definition of criteria for a network's transition to/from an unavailable state.

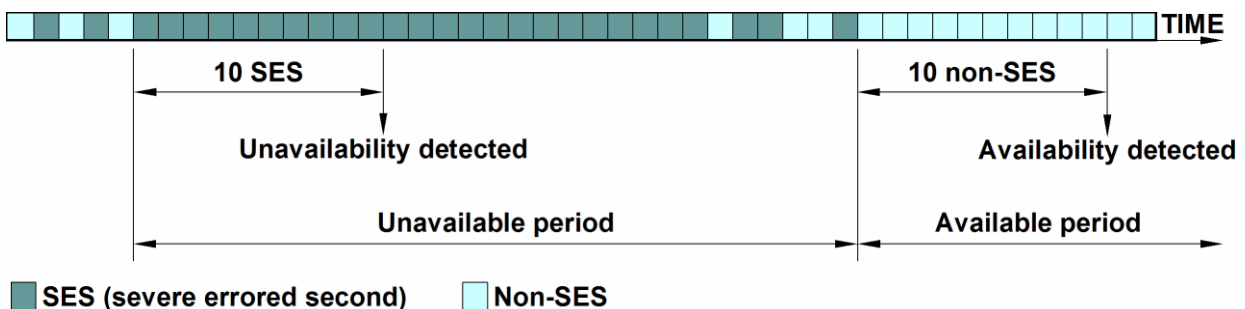

Fig 68

A Severely Errored Second is defined as one second of transmission time in which the number of lost frames (expressed as a ratio - FLR) is greater than a user defined value. For tests, this value is entered at set up. In its specification Y.1563, the ITU propose a value of 0.5.

The NetSAM subtests are as follows. The prefixes A1, A2 etc., refer to the sub-clauses of paragraph 8.1.2 in Y.1564 where the definitions for each subtest are defined.



A1 CIR

This is a simple Committed Information Rate (CIR) validation test. It verifies that the proper data rate has been configured in the network. MGig1 generates and transmits frames, at constant intervals, at the CIR. If the IR, FLR, FTD and FDV are within Service Acceptance Criteria (SAC) limits the test is passed.

A2 Step Load CIR

This test is similar to A1 but generates and transmits frames in steps of 10, 20, 25 or 50% of the CIR, up to the CIR. The duration of each step is user defined up to 60 seconds. If the FLR, FTD and FDV are within SAC limits and 100% of the CIR is reached, the test is passed.

B1 EIR Color

MGig1 transmits frames marked green at a rate equal to the CIR, and yellow at a rate equal to the Excess Information Rate (EIR). All frames are transmitted at constant intervals. The tester allows you to choose how priority is specified - IP, VLAN or MPLS. If the FLR, FTD and FDV for the green marked frames are all within the SAC limits, the test is passed.

B2 EIR Non Color

Frames are transmitted at constant intervals at a rate equal to CIR + EIR. If the FLR, FTD and FDV are within SAC limits and the measured IR is greater than the CIR, the test is passed.

C1 Police Color

The C1 Police Color test checks that the network drops frames transmitted at a rate greater than the EIR. The method is to transmit frames marked green at a rate equal to the CIR, and frames marked yellow at a rate of 125% EIR. All frames are transmitted at constant intervals. If the FLR, FTD and FDV for the green marked frames are all within the SAC limits, and if the total information rate (IR for both green and yellow marked frames) is less than or equal to the CIR + EIR + M factor the test is passed. For a definition of M factor see *page 50*. The IR results are shown on a table that presents values for Green, Yellow and Total IR on separate rows.

C2 Police Non Color

This test is similar to C1 but frames are not color marked. It checks that the network drops frames transmitted at a rate greater than the EIR. The test is passed when the measured IR is less than or equal to CIR + EIR + M factor.

The network is configured correctly when the configuration tests have been run satisfactorily. A service performance test can now be run.

Service Performance

This test validates the quality of services over time. All services are generated to their configured CIR simultaneously. IR, FLR, FTD, FDV and Available Time (network availability) are monitored for each service simultaneously. All results are shown on tables that present each service as a separate row. For bidirectional tests, the test is considered passed only when the criteria are satisfied for both directions.

Setup and run NetSAM as follows:

From the home screen select SETUP>TESTS>NetSAM. Alternatively, select TESTS>NetSAM>SETUP. At this menu level, MORE (F1) will cycle through four setup screens: the Target screen, Subtests screen, Services screen and SES Frame Loss Ratio screen.

Target screen Select a Target from the dropdown list of 10 targets. To add, amend, edit or delete targets from the list, see *Targets on page 24*. Test direction is confirmed as Single Ended or Bi-directional (see 'Services screen' below). Select MORE (F1) to access Subtest selection and setup.

Subtests screen - Fig 69. Choose from the seven subtests - note that service configuration tests should be run before the performance test. This is to prevent the time wasted when a performance test is run over an incorrectly configured service.

Tick the check box next to the test you require. All four can be ticked but only one radio button, e.g. either A1 or A2, can be selected. The EDIT buttons reveal further settings for each test as follows:

- A1 - Select duration from 5, 15, 30 secs or user defined up to 24 hours.
- A2 - Set step sizes to 10, 20, 25 or 50% of the CIR, and set the duration to transmit at each step from 1 to 60secs.
- B1 & B2 - Select duration from 5, 15, 30 secs or user defined up to 24 hours.
- C1 & C2 - Select duration from 5, 15, 30 secs or user defined up to 24 hours, and -

Set M-Factor in Mb/s. The M-Factor is a value in Mb/s that is added to the IR to allow for the effect of the traffic policer's CBS and EBS. Select MORE (F1) to access Services selection and setup.

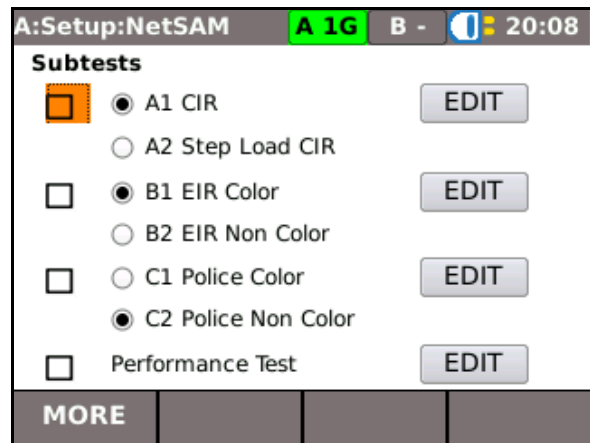

Fig 69

Services selection screen - Fig 70. Tick the check box against the services required. The left column is for Single Ended Tests, the right for Bi-directional tests. For Bi-directional tests another MGig1 set to Slave Mode is required - see *page 28*.

Select the EDIT button next to a service to reveal three further screens where you can:

- Set the characteristics of the service such as CIR, EIR, frame size and pattern data. See Fig 71.
- Set the color mode (when required). See Fig 72.
- Set the pass/fail limits for the test based on FLR, FTD, FDV and Availability. See Fig 73.

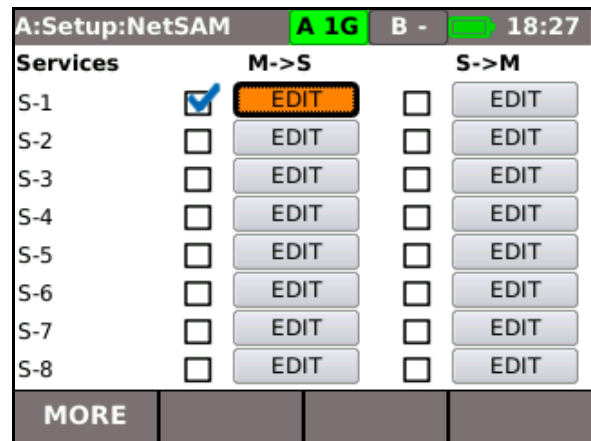

Fig 70

Severely Errored Second screen For any second, when the FLR is greater than the value entered here MGig1 defines it as a Severely Errored Second. Enter a value from 0 to 1 (4 decimal places).



Service setup screen

Frame size can be set in the ways that follow: Select Frame Size and choose from the dropdown list. When a specific size, such as 64, is selected, that size will be used for all frames transmitted on that service. Select User or MTU and specify your own size between 60 and 10,000 bytes. EMIX will generate and transmit a variety of frame sizes throughout the test duration. The default EMIX Pattern is 'abceg' and is shown in Fig 71. The characters are designators for the frame sizes listed in the table shown on the screen. Select 'EMIX Pattern' and you may add or subtract from the pattern using the appropriate designators.

CIR Set CIR for the service.

EIR Set EIR for the service. Values entered here are ignored for subtests A1 & A2.

Pattern Data Enter up to eight hexadecimal characters.

Color Mode screen

Select the Color Mode from the drop down list – IP, VLAN or MPLS dependent on where network priority for EIR should be. Now set a value for both the Green and Yellow indicators by selecting the data entry box next to the color – For IP select the COS Type and Precedence, or DSCP Mode and Class in accordance with the SLA and select APPLY (F3).

For VLAN and MPLS set a value from 1 to 7.

Limits screen Fig 73.

The values entered here should be those found in the SLA.

- Set the Frame Loss Ratio from 0 to 1(3 decimal places).
- Set the Frame Transfer Delay from 0 to 10,000,000.
- Set the Frame Delay Variation from 0 to 2,000,000.
- Set Availability from 0 to 100%.

A	64
B	128
C	256
D	512
E	1024
F	1280
G	1518
H	MTU
U	User

Fig 71

Fig 72

Fig 73

To view graphs and tables of a live test, select MORE (F2) from the subtest screen as the test is in progress. A list of available statistics is shown on the display, select from the list and the live result is shown. Fig 74 shows the Rx Info Rate of a performance test over three services set at 30, 20 and 10 Mb/s. Select TABLES (F3) to view numerical results presented in a table.

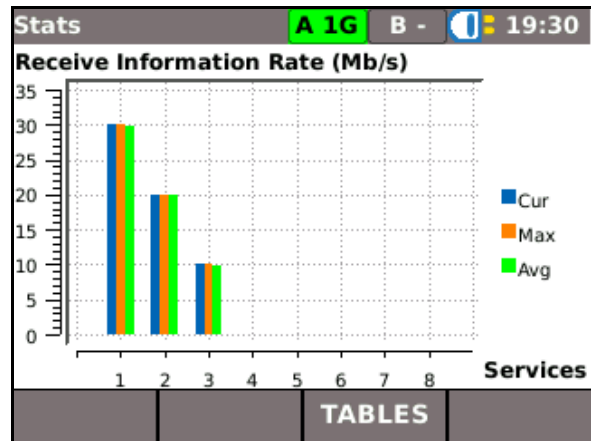
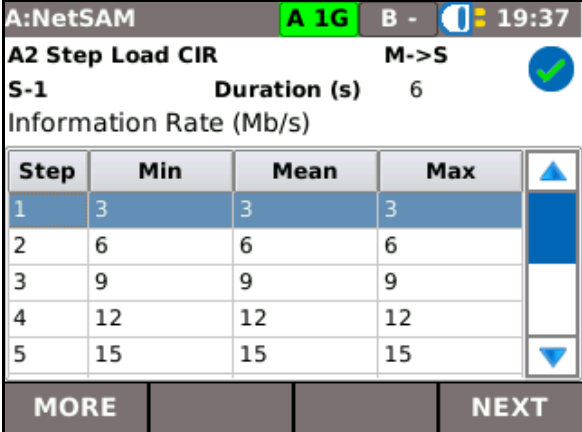

Fig 74

When a test is complete select VIEW and all results are presented as tables and shown on the display. Select MORE (F1) to navigate between all result criteria. Fig 75 shows the IR results for an A2 Step Load CIR test - note that the result for each step is shown on a separate row. This test was setup with steps set at 10% CIR, therefore there are 10 steps; scroll down to see the last five.



Step	Min	Mean	Max
1	3	3	3
2	6	6	6
3	9	9	9
4	12	12	12
5	15	15	15

Fig 75

The results shown are for Service 1, indicated by S-1 on the screen. Select NEXT (F4) to view the other services tested.

Select MORE (F1) to view the Frame Loss, Frame Transfer Delay and Frame Delay Variation.

Performance is checked on all services simultaneously and the results for each service shown on a separate row. Fig 76 shows that FTD on all three services tested is 2µs which is within limits for the setup of this test. An example of the Availability criterion from a Performance test over three services is illustrated in Fig 77.

Note that when one criterion is not met the whole test is failed. E.g. if IR, FTD, FDV and Availability test successfully but Frame Loss exceeds the limit chosen at setup, the test is failed.

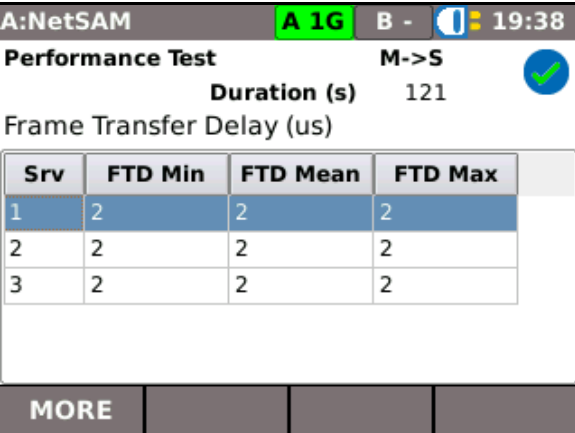

Srv	FTD Min	FTD Mean	FTD Max
1	2	2	2
2	2	2	2
3	2	2	2

Fig 76

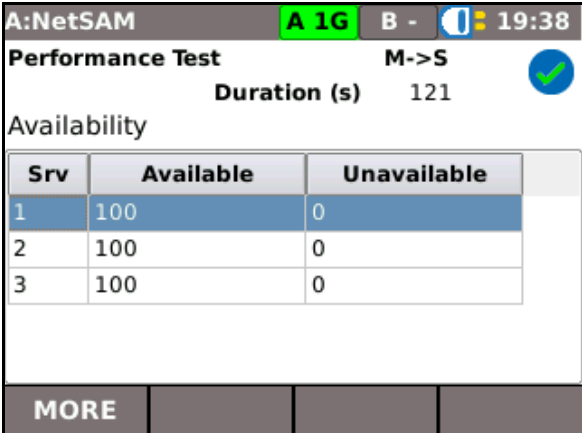

Srv	Available	Unavailable
1	100	0
2	100	0
3	100	0

Fig 77



Auto test

MGig1 can be set up to run a predefined range of tests when the yellow Autotest button, found on the front of the handset, is pressed. The range of tests is set from TESTS>AUTOTEST>SETUP by ticking the check boxes next to your choice. Fig 78 refers. Select APPLY (F3) to save your choices and a screen showing the selected tests is shown on the display with a ready symbol adjacent to each test, Fig 79.

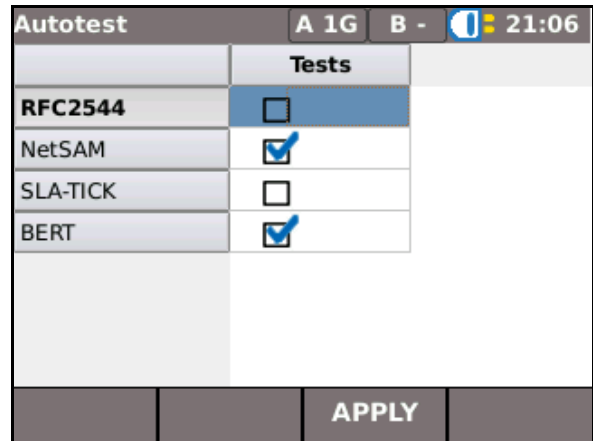

Fig 78



Fig 79

Select RUN (F1) and the tests will start. MGig1 will decide in which order to run the tests.

When all tests are complete, select any of the tests from the screen to view the results. To save the results, press the Escape key to exit to the Tests screen and then select SAVE ALL (F3).



Statistics

From the home screen in Endpoint mode select the STATS icon, the Stats screen is shown on the display,

Fig 80.

NOTE

When a test result is saved, all Stats data available at the time of the test is also saved to the same Result.

•Only a single set of Transmission stats will be maintained. These are started at the beginning of a test and stopped at the end of a test. In the case of an AUTOTEST the stats span all the tests executed as part of the AUTOTEST and not stopped and started for each of the individual tests. Transmission statistics are available from within RFC2544, NetSAM and SLA-Tick tests

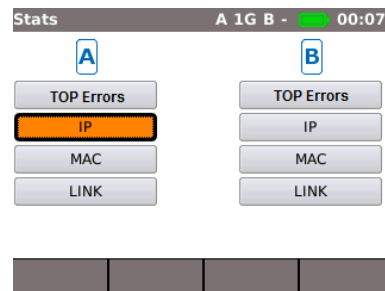

Fig 80

Stats menu description

For each port (only Duo models have a 'B' port), select from the four buttons on the Stats screen to provide the information that follows:

Top Errors The hosts that are generating or receiving the most errors are listed in order of error rate (Mb/s). The F4 soft key is used to select hosts by MAC or IP address and to select Talkers (hosts that are generating errors) or Listeners (hosts that are receiving errors). The F2 soft key is used to control the refresh rate. In Through mode, errors in the traffic passing through the tester are analysed.

IP The F1 soft key is used to toggle between IPv4 and IPv6 data.

The IPv4 data listed is:

Info: IP Assigned successfully or, Listening or, DHCP failed.
Also listed are: IP Address, Gateway, Subnet Mask, Primary & Secondary DNS, DHCP Server.

The IPv6 data listed is:

Info: IP Assigned successfully or, Listening or, DHCP failed.
Also listed are: IP Address, Prefix-64 or 128 bit, Link Address, Gateway, Primary & Secondary DNS DHCP Server.



MAC

Tx and Rx data listed is:

Frames, Total Bytes, Unicast frames, Broadcast frames, Multicast frames, Max Frames/sec, Current, Average and Maximum rate in b/s, Current, Average and Max Utilization as %, frame Size Distribution.

Discovery data listed is:

LLDP/CDP/EDP, Protocol, MAC Address, Hostname/address, Port Name.

LINK

Port data listed is:

PoE Voltage: 0 to 60V, PoE Pairs: 12/36 or 45/78, Speed, Duplex, MDI or MDIX, Polarity.

Error data listed is:

Collisions, FCS Errors, Undersize and Oversize (set in RJ45 SETUP – applies to both RJ45 and Optical ports), Jabbers, Bad Length.

Partner data listed is:

10M-HD, 10M-FD, 100M-HD, 100M-FD, 1000M-HD, 1000M-FD.

From the home screen in **Through** mode select the STATS icon, the Stats screen is shown on the display, Fig 81.

A graph shows Traffic Utilization and %utilization against time. Select SCALE (F2) to change the time axis between 60secs, 10mins and 60mins.

For Duo models select the F3 key to toggle between Port A (blue plot), Port B (red plot) and Both.

Top Users – Select Top Users to show a table listing the top ten talkers, their IP address and usage.

Top VLANs – Select Top VLANs to show a table listing the top VLANs, their ID and their usage.

MAC and LINK data lists the same criteria as Endpoint mode above.

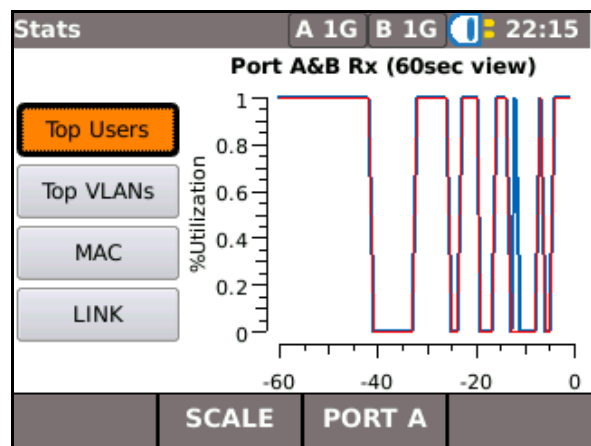

Fig 81



Jobs

MGig1 provides a system that enables the storage and organization of test results and statistics. Test results can be exported via a USB key and used to produce reports.

The two elements of this storage and organization system are Jobs and Results. A Job is a named repository for a collection of Results. A Result is a group of test results. It may contain the saved results of one or several tests. Therefore, a Job may be understood as a folder, a Result as the file(s) held within that folder. MGig1 can store up to five Jobs each containing 50 Results.

At any time, one Job is always 'active'. Test results are saved to the active Job. Any existing Job can be activated, at any time, via the menu on the Jobs Options screen. The currently active Job is indicated in the information bar shown at the top of the display.

Every time test results are saved, they are saved to a Result which is assigned a sequential number. In turn, each Result is allocated to the currently active Job.

The structure in which Jobs, Results and test results are stored is shown in Fig 82.

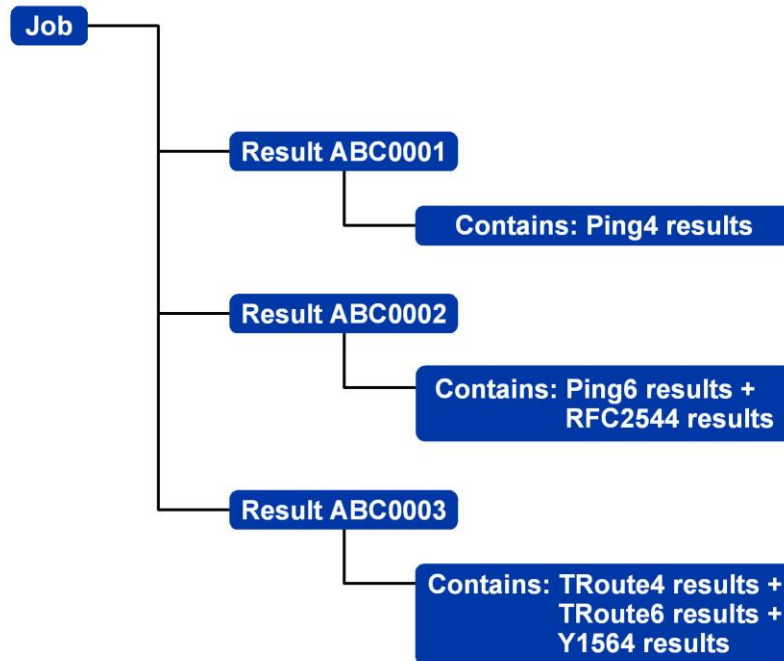

Fig 82 Example of Job storage structure

When creating a new Job, you can store:

- The customer's contact, address and telephone details. This information will appear on reports that are compiled from exported test results.
- A prefix (relates to all associate Results). It will appear at the front of every Result number, e.g. ABC0001, where ABC is the user-defined prefix and 0001 is the system-allocated Result number. The prefix must be an alphanumeric string (no spaces or punctuation). Adding a prefix for Result numbers is optional.
- A Job title (user defined). Enables Jobs to be named. The Job title must be an alphanumeric string (no spaces or punctuation).

Using the Jobs menu

From the home screen select the JOBS icon. The display will show the Job List screen, Fig 83. The Job List screen lists all currently stored Jobs. The column 'Tests' indicates the number of Results saved to each Job. The column 'Pass %' indicates the percentage of the total number of tests in all Results allocated to a Job that have passed.

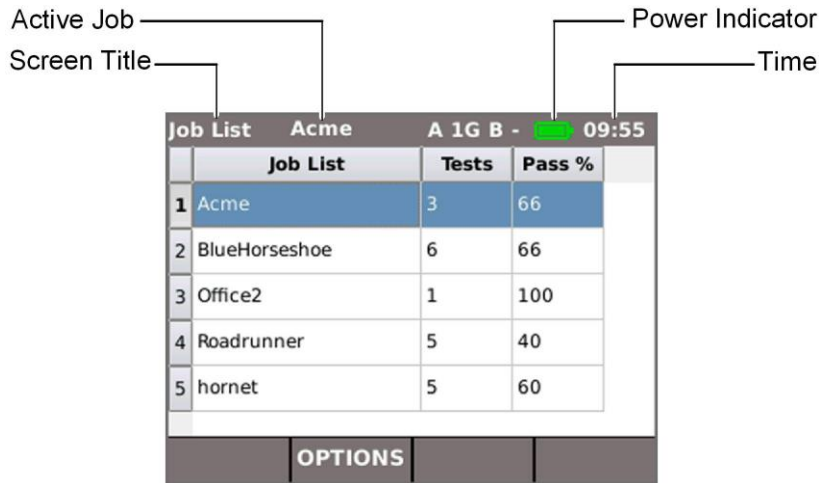

Job List			
Acme			
A 1G B - [Power Indicator] 09:55			
	Job List	Tests	Pass %
1	Acme	3	66
2	BlueHorseshoe	6	66
3	Office2	1	100
4	Roadrunner	5	40
5	hornet	5	60

OPTIONS

Fig 83 Job List screen

Change the active Job

In the example of a Job List screen shown at Fig 83, the active Job is 'Acme' as indicated on the display's information bar. To change the active Job, scroll to the Job required (e.g. My Job) and select OPTIONS (F2); the display will show the Options screen, Fig 84. Select the ACTIVATE icon.

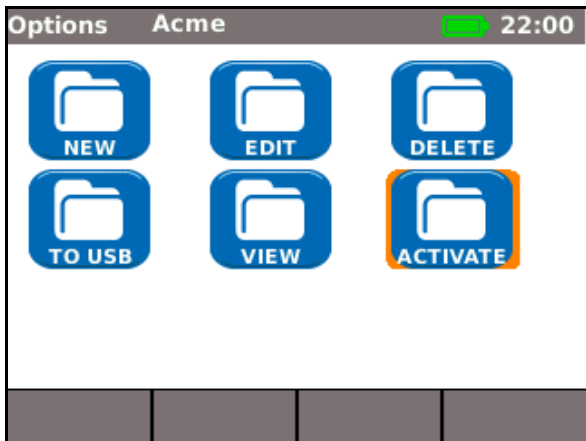

Fig 84 Options screen

The display will show a dialogue stating:

'MyJob is set as current job'

To change the active Job List from Acme to MyJob Press ENTER to confirm.

The display returns to the Job List screen, and the new active Job is now shown in the information bar.



Managing Jobs

Select one of the icons from the Job List screen to manage Jobs as follows:



Create a new Job. Up to five Jobs can be stored. Data entry fields are:

- Prefix. Enter an alphanumeric string which will be prefixed to all Results stored under the new Job.
- Job. Enter an alphanumeric string which will be the title of the new Job. For example, your customer's name.
- Customer details. Fields are provided for - Company, Address, City, State, ZIP, Phone No.

NOTES:

(1) When a new Job is created it automatically becomes the Active Job.

(2) When five Jobs have been created the NEW icon is not shown on the Options screen. An existing Job must be deleted for the NEW icon to reappear.



Amend any details of an existing Job. Select APPLY (F3) to save the changes.



Delete a Job and all its associated Results. When DELETE is selected, the dialogue 'Are you sure you want to delete 'Job' will appear.



once deleted, a job cannot be restored



Selects the Job to be currently active. All test results are saved to the active Job. Full details of this function are described on *page 57*.



When selected, the display will show the Results screen. The Results are shown as a list and can be viewed, deleted or exported to a USB key. The soft key SHOW (F3) toggles between Status (pass/fail), and the Date and Time that the test was saved.



Exports the selected Job List to USB. Information on how to generate reports is detailed below.

Generating Reports

Reports can be generated using test results exported via a USB key.

To generate a report:

- Insert a USB key into the MGig1 USB port.
- From the home screen select the JOBS icon. The display will show the Job List screen.
- Highlight the Job to be exported and select OPTIONS (F2). The display will show the Options screen.
- Highlight the TO USB icon and press Enter. The dialogue 'Job saved to USB' appears.

Alternatively, an individual Result from a Job may be exported:

- Insert a USB key into the MGig1 USB port.
- From the home screen select the JOBS icon. The display will show the Job List screen.
- Highlight the Job required and press ENTER. The display shows all Results contained within the Job.
- Highlight the Result you require and press the soft key TO USB (F4). The dialogue 'Result saved to USB' appears.

Test results and statistics are now saved on the USB key and can be viewed as a report on any PC installed with Microsoft Internet Explorer™, Mozilla Firefox™ or other suitable browser.

Files are saved to the USB key, the test results are stored as an XML document and a report template is stored as an XSLT file. Open the XML document to view the report.

MGig1 software updates and configuration

Update software

To update the software, download the latest version from idealnwd.com and copy it to the root directory on a USB flash drive. From the tester's home screen, go to SETUP>SYSTEM>UPDATE; the 'Update' screen is shown on the display. Follow the instructions listed on the Update screen.

MGig1 can save up to 30 different configurations. A previously saved configuration can be loaded at any time.

Configurations

Configurations can be:

- Named and saved to MGig1's local memory,
- loaded from MGig1's local memory,
- exported to USB flash drive,
- imported from a USB flash drive.

CAUTION

When a configuration is exported, previously saved Configurations on the USB flash drive will be over-written.



SEL1 software updates and configuration

General

SEL1 can have its loop layer changed, or be completely reconfigured, via a remote connection to MGig1. See *page 29* for details.

SEL1 can be reconfigured using the software – UPSEL1Config.xls. This can be downloaded from idealnwd.com. Instructions are included on the file.

Update software

To load a software update to SEL1, download the software update from idealnwd.com and proceed as follows, Fig 6 refers.

- Copy the software update to the root directory of a USB flash drive. Make sure that there are no SEL1 configurations saved on the USB flash drive.
- With SEL1 switched OFF, insert the flash drive into the USB socket (item 7) at the top of the SEL1 handset.
- Press and hold down the blue Layer button (item 13). With the blue Layer button held down, press the ON/OFF button (15) until the LEDs glow. Release both buttons.
- The LEDs will flash for about 30 seconds. When they stop, remove the flash drive from the USB port. SEL1 is ready for use, a restart is not required.

Upload configuration (for transfer to other SEL1 handsets, for use with the utility

UPSEL1Config.xls, or to view the software version)

To upload SEL1's current configuration to a USB flash drive, proceed as follows, Fig 6 refers:

- With SEL1 switched OFF, insert an empty (no files) flash drive into the USB socket (item 7) at the top of the SEL1 handset.
- Press and hold down the blue Layer button (item 13). With the blue Layer button held down, press the ON/OFF button (15) until the LEDs glow. Release both buttons.
- The LEDs will flash for a brief period. When they stop, remove the flash drive from the USB port. The configuration is saved to the root directory of the flash drive and ready for download to another SEL1.
- Open the file UPSEL1.XML with a browser to view the software version of the UniPRO SEL1.

Download configuration

To download a SEL1's configuration that is saved in the root directory of a USB flash drive, proceed as follows, Fig 6 refers:

- With SEL1 switched OFF, insert the flash drive into the USB socket (item 7) at the top of the SEL1 handset.
- Press and hold down the blue Layer button (item 13). With the blue Layer button held down, press the ON/OFF button (15) until the LEDs glow. Release both buttons.
- The LEDs will flash for a brief period. When they stop, remove the flash drive from the USB port. SEL1 is ready for use, a restart is not required.

Reset SEL1 to factory default

To reset SEL1 to factory default, proceed as follows, Fig 6 refers:

- Make sure SEL1 is switched OFF. A flash drive must NOT be inserted into the USB socket.
- Press and hold down the blue Layer button (item 13). With the blue Layer button held down, press the ON/OFF button (15) until the LEDs glow. Release both buttons.
- The LEDs will flash for a brief period. When they stop, SEL1 is restored to factory defaults and is ready for use, a restart is not required.

Specifications – UniPRO MGig1 and UniPRO SEL1

The specifications listed below are for the MGig1 Duo PRO. To confirm the functionality of other models refer to the *Functional overview table on page 9*.

Term	Description
Test interface	RJ45: 10, 100, and 1000 Mb/s. Optical: 1000Mb/s with auto-negotiation and optional SFP. UniPRO MGig1 Solo and UniPRO SEL1: x1 port. UniPRO MGig1 Duo: x2 ports.
Operation mode	End point (terminated), pass through (monitor) for UniPRO MGig1 Duo only.
SLA-Tick	Items: frame loss, jitter (delay variation), delay (latency, loop test only), service disruption time, information rate, error performance (SES, unavailability). Mode: single-ended with remote loop or double-ended two way test. Tests up to eight configurable services (streams) simultaneously with parameters on each service, pass/fail limits, error injection: single, rate with frame.
RFC2544	Items: throughput, latency, frame loss, jitter, back to back, system recovery. Table and graph results, frame size. Mode: single end loopback test or double end Bi-Directional test. Pass/fail limits.
Y.1564 (NetSAM)	Configuration test on CIR (Committed Information Rate), EIR (Excess Information Rate), color mode, traffic policing. Performance test up to 8 services simultaneously on utilization, FTD (delay), FDV (jitter), FLR (frame loss), SES, availability measurement with fixed or mixed frame size, loop or Bi-Directional test, pass/fail limits.
BERT	BER at L1 to L4 frame payload, test pattern on PRBS ITU or Non ITU @ 2n-1 n=11,15,20,23,31. SCRTPAT, CRPAT,CJTPAT, CSPAT, LFPAT, HFPAT, MFPAT, fixed: all 1s, 0s, 1100,1000, 1010. Word: 4 digit Hex, Control: manual or user defined duration. Error injection: single, rate on frame or bit.
Multi services (streams)	Up to eight services simultaneously generated and measured on FLR, FTD, FDV, IR with independent IP, MAC, VLAN, MPLS, TCP or UDP ports setup on each service for SLA-Tick, NetSAM (Y.1564) test.
Target finding & remote loop control	Auto detection of target devices (IDEAL NETWORKS' products only) with remote control of loopback (L1 to L4) via in band Ethernet test link. Targets can also be manually controlled locally.
Traffic generation	Profile: continuous, ramp (service one only), burst (service one only). Information rate, frame size, test pattern.
Frame size (byte)	64,128, 256, 512, 1024, 1280, 1518, user defined up to 10000.
VLAN	Level: up to eight including QinQ. VLAN ID, TPID, CFI, on each service.
MPLS	Level: up to three. Label, Class, TTL for each service.
MAC, IP & payload	Setup: MAC address, IP address: static, DHCP. DNS, netmask, gateway. Version: IPv4, IPv6. CoS: ToS, DSCP. Payload: UDP & TCP ports, ICMP type & code.
Service Disruption Time (SDT)	Service protection switch time measurement (SDT) on each service with resolution 1ms.
Error insertion	Items: FCS, oversize, undersize, pattern. Type: single, ratio.
MAC frame statistics	Per service based - Rx frame rate, Rx information rate, Rx frame size, Tx/Rx frame counts, Tx/Rx layer payload accumulated byte count. VLAN ID, per port based - frame type: unicast, multi cast, broadcast. Pause frames. Protocol discovery: LLDP / CDP / EDP. Frame errors: collision (10/100Mb/s only), FCS, undersize, oversize, jabbers, errored, % errored.



Specifications – UniPRO MGig1 and UniPRO SEL1 (continued)

Term	Description
Link status	Port: speed, duplex, auto negotiation. Optical power, PoE detection.
Tools	Ping & Traceroute (IPv4, IPv6). Cable test, port blink, PoE & PoE+ (current, voltage, power and pair).
Loopback (UniPRO MGig1 & UniPRO SEL1)	Level: L1 (Physical), L1 (Regenerate), L2 (MAC), L3 (IP), L4 (UDP) unfiltered. Control: local or remote by another master unit via Ethernet test path.
Auto sequence test	Multi test items running sequentially. Test items can be defined by user.
Top ten bandwidth users	Through mode only, VLAN users, source and destination MAC or IP address users.
Storage	Internal configuration profile: MGig1: 30, SEL1: 1. Internal reports: 250 (MGig1 only). Format: xml. External storage: USB.
Display	3.5" TFT color touch screen (UniPRO MGig1), 5 LEDs (UniPRO SEL1).
Battery	NiMH Rechargeable; auto power off 3,10, 30 min (MGig1), continuous use >4hrs (MGig1), > 3.5hrs (SEL1), power adaptor: 100-240VAC IN /12VDC OUT.
System interface	USB 1.1 for external storage on software upgrade, test report and configuration upload.
Physical	Dimension: 205x98x45 mm (MGig1), 175x80x40 mm (SEL1). Weight including batteries: 650g (MGig1), 400g (SEL1).
Environmental	Temperature: 0°C to 45°C (operation), -20°C to 70°C (storage). Humidity: 5% - 90% no condensation.
Accessories included (UniPRO MGig1 & UniPRO SEL1)	1 x NiMH battery, 2 x Patch cables - 30cm, Cat 5e STP, 1 x PSU with EU/UK/US adaptors, 1 x User manual CD, 1 x English quick reference guide, 1 x Carry case.



Glossary, abbreviations and acronyms

Term	Description
10M-HD	10 Mb/s Half Duplex
10M-FD	10 Mb/s Full Duplex
100M-HD	100 Mb/s Half Duplex
100M-FD	100 Mb/s Full Duplex
1000M-HD	1000 Mb/s Half Duplex
1000M-FD	1000 Mb/s Full Duplex
BERT	Bit Error Ratio Test (often incorrectly called “Bit Error Rate Test”)
Bi-Directional	Tests which use two testers, each transmitting to the other
Broadcast	Communication from single sender to all connected receivers
CBS	Committed Burst Size
CFI	Canonical Format Indicator. A flag in the Ethernet frame indicating the MAC format
CIR	Committed Information Rate
CJTPAT	Long Compliant Jitter Test Pattern. A special-purpose test data pattern
CoS	Class of Service
CRC	Cyclic Redundancy Check
CRPAT	Compliant Supply Noise Data Pattern. A special-purpose test data pattern
DHCP	Dynamic Host Configuration Protocol
Discovery data	
LLDP	Link Layer Discovery Protocol
CDP	Cisco Discovery Protocol
EDP	Extreme Discovery Protocol
DNS	Domain Name System
EBS	Excess Burst Size
EIR	Excess Information Rate
Errored Second	Any second containing one or more lost or errored frames
Errored Time	Number of Errored Seconds expressed as hours, minutes and seconds
EMIX	Ethernet mix - Set of frame sizes used for Y.1564 configuration tests
FCS	Frame Check Sequence. The last section of the Ethernet frame structure before the IFG. Used to check the frame for errors
FDV	Frame Delay Variation
FLR	Frame Loss Ratio
Frame rate	The number of frames per second. High frame rates have a short IFG
Frame size	The length of the Layer 1 payload
FTD	Frame Transfer Delay
HFPAT	High Frequency Test Pattern. Special-purpose test data pattern
ICMP	Internet Control Message Protocol
IETF	Internet Engineering Task Force



Glossary, abbreviations and acronyms (continued)

Term	Description
IFG	Inter-Frame Gap. The gap between Ethernet frames. Traffic with a low frame rate has long gaps between frames
Information rate	The Layer 1 payload rate. The number of Layer 1 payload bits per second
IP	Internet Protocol
IPv4	Internet Protocol version 4
Static	IP address assigned manually by the operator
Dynamic	IP address assigned automatically using DHCP
Ipv6	Internet Protocol version 6
Stateful	IP address assigned automatically using DHCPv6
Stateless	IP address assigned automatically using ICMPv6
Static	IP address assigned manually by the operator
ITU	International Telecommunications Union
Jitter	Measurement of short term variations in network propagation delay
Key Mgmt	802.1x Key Management
LAN	Local Area Network
Latency	Measurement of network propagation delay
Layer1 (L1)	The Physical layer of the ISO 7-layer model. Includes the SFD, the Preamble and the IFG parts of the Ethernet structure
Layer 1 Payload	Everything in the Ethernet frame between, but not including, the SFD and the IFG. Includes the MAC and the FCS
Layer 2 (L2)	The Data link layer of the ISO 7-layer model. Includes the MAC and FCS parts of the Ethernet frame
Layer 2 Payload	Everything in the Ethernet frame between, but not including, the MAC and the FCS
Layer 2 Payload rate	Number of L2 Payload bits per second
Layer 3 (L3)	The Network layer of the ISO 7-layer model. Includes the IP part of the Ethernet frame and, optionally, the VLAN, MPLS and LLC/SNAP parts
Layer 3 Payload	Everything in the Ethernet frame between, but not including, the IP (and VLAN, MPLS or LLC/SNAP if present) and the FCS
Layer 3 Payload rate	The number of L3 Payload bits per second
Layer 4	The Transport layer of the ISO 7-layer model. Includes the Transport Protocol header (TCP/UDP/ICMP) and user data parts of the Ethernet frame
Layer 4 Payload	Everything in the Ethernet frame between but not including the Protocol header and the FCS. The user test data
Layer 4 Payload rate	The number of L4 Payload bits per second



Glossary, abbreviations and acronyms (continued)

Term	Description
LFPAT	Low Frequency Test PATtern. Special-purpose test data pattern
Line rate	The nominal speed of the media link – 10/100/1000Mb/s
LINK error data	
Collisions	Collisions on the Ethernet frame transmission
FCS errors	Frame Check Sequence errors
Undersize	Frames smaller than the minimum set in SETUP>RJ45 or SETUP>OPTICAL
Oversize	Frames longer than 1522 bytes
Jabbers	Frames longer than 1518 bytes with bad CRC
Bad length	Frames with actual length different from the length specified in their ethertype field
LLC/SNAP	Logical Link Control / Sub-Network Access Protocol
MAC	Media Access Control
Mb/s	Megabits per second
MDI	Medium Dependent Interface
MDIX	Medium Dependent Interface Crossover
MFPAT	Mixed Frequency Test PATtern. Special-purpose test data pattern
MPLS	Multi-Protocol Label Switching protocol
MTU	Maximum Transmission Unit
Multicast	Communication between single sender and multiple receivers
NetSAM	IDEAL INDUSTRIES special name for Y.1564
NVP	Nominal Velocity of Propagation of signals in a cable, expressed as a percentage of the speed of light in a vacuum. Can be determined using cable manufacturers' data or experimentally using a known cable length.
PCP	Priority Code Point (used to control VLAN priority)
PoE	Power over Ethernet
PRBS	Pseudo-Random Binary Sequence. Standard patterns of test data contained in the Layer 4 payload
PRE	Preamble. The first part of the Ethernet frame before the SFD
QinQ	Ethernet frame format that allows multiple VLAN headers to be inserted into a single frame
QoS	Quality of Service
RFC2544	An IETF standard (Request For Comments) that specifies a benchmarking methodology for network interconnect devices
RJ45	Registered Jack standard for a modular connector using 8 conductors
Rx	Receive
SAC	Service Acceptance Criteria
SCRTPAT	Short Continuous Random Test Pattern. Special-purpose test data pattern
SDT	Service Disruption Time



Glossary, abbreviations and acronyms (continued)

Term	Description
Service	A specific traffic flow or stream that can be simultaneously carried over the same Ethernet link as other services
SES	Severely Errored Second - Any one-second period during which 30% or more of frames are lost or errored
SFD	Start of Frame Delimiter
SFP	Small Form-factor Pluggable
SLA	Service Level Agreement
SLA-Tick	A special Throughput/Latency/Jitter test with constant frame size
STP	Shielded Twisted Pair
TPID	Tag Protocol Identifier (Used in VLAN control)
TTL	Time To Live. Limits the lifetime of stray Ethernet frames to avoid build-up in networks
Tx	Transmit
UDP	User Datagram Protocol
Unavailable Time	Any period of ten seconds or more during which every second is a Severely Errored Second
Unicast	Communication between single sender and single receiver
URL	Uniform Resource Locator
USB	Universal Serial Bus
Utilization	The ratio of Information Rate to Line Rate
UTP	Unshielded Twisted Pair
VLAN	Virtual Local Area Network
WAN	Wide Area Network
XML	Extensible Markup Language
XSLT	Extensible Stylesheet Language Transformations
Y.1564	An ITU standard which specifies an Ethernet service activation test methodology that allows for complete validation of Ethernet service-level agreements (SLA) in a single test





IDEAL NETWORKS

IDEAL INDUSTRIES LIMITED
Stokenchurch House, Oxford Road,
Stokenchurch,
High Wycombe, Bucks, HP14 3SX, UK.
www.idealnwd.com

A subsidiary of IDEAL INDUSTRIES INC.

