

Touchboards

205 Westwood Ave, Long Branch, NJ 07740
Phone: 866-94 BOARDS (26273) / (732)-222-1511
Fax: (732)-222-7088 | E-mail: sales@touchboards.com

IN1142

User's Guide
Guide de l'utilisateur
Benutzeranleitung
Guía del usuario
Guida per l'utente

Gebruikershandleiding
Guia do Usuário
Användarhandbok
Przewodnik Użytkownika

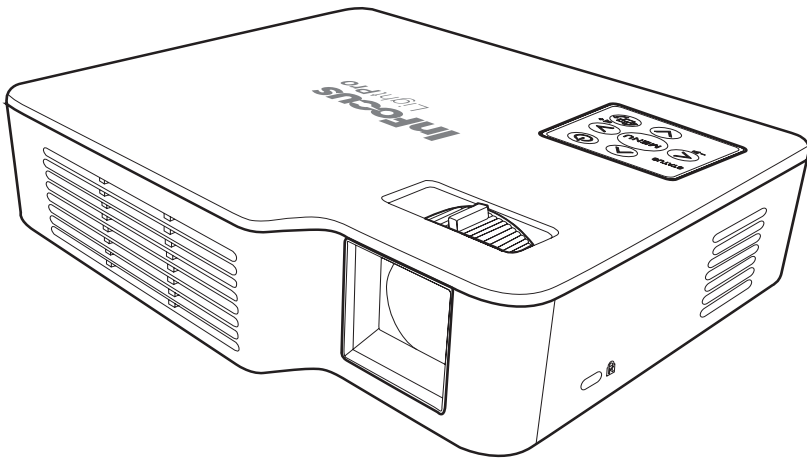

InFocus
LightPro



EYE SAFETY WARNINGS

- ⚠ Avoid staring/facing directly into the projector beam at all times. Keep your back to the beam as much as possible.

 - ⚠ A stick or laser pointer is recommended to avoid the need for the user to enter the beam.

 - ⚠ When projector is used in a classroom, adequately supervise students when they are asked to point out something on the screen.

 - ⚠ In order to minimize power, use room blinds to reduce ambient light levels.
-

IMPORTANT SAFETY INSTRUCTION

1. Do not block any ventilation openings. To ensure reliable operation of the projector and to protect from overheating, it is recommended that you install the projector in a location that does not block ventilation. For example, do not place the projector on a crowded coffee table, sofa, bed, etc. Do not put the projector in an enclosure such as a book case or cabinet that restricts air flow.
2. Do not use the projector near water or moisture. To reduce the risk of fire and/or electric shock, do not expose the projector to rain or moisture.
3. Do not install near heat sources such as radiators, heaters, stoves or any other apparatus such as amplifiers that emit heat.
4. Do not use the projector in direct sunlight.
5. Do not use near any appliance generating a strong magnetic field.
6. Do not use the projector in areas susceptible to excessive dust and dirt.
7. Turn off the product before cleaning.
8. Disconnect the power cord if the product is not being used for a long period of time.
9. Ensure that the ambient room temperature is within 0- 40°C (32-104°F).
10. Ensure that relative humidity is 5 - 35°C (41- 95°F), 80% (Max.), non-condensing.
11. Do not drop, throw or try to bend your product.
12. Dispose of your projector in an environmentally appropriate manner and according to local disposal laws. Disposing the projector in a fire may cause an explosion.
13. Clean only with dry cloth.
14. Only use attachments/accessories specified by the manufacturer.
15. Do not use the unit if it has been physically damaged or abused. Physical damage/abuse would be (but not limited to):
 - ⇒ Unit has been dropped.
 - ⇒ Charger or plug has been damaged.
 - ⇒ Liquid has been spilled on the projector.
 - ⇒ Projector has been exposed to rain or moisture.
 - ⇒ Something has fallen into the projector or something is loose inside.Do not attempt to service the unit yourself. Opening or removing covers may expose you to dangerous voltages or other hazards. Please contact your local reseller or service center before you send the unit for repair.
16. Do not let objects or liquids enter the projector. They may touch dangerous voltage points and short out parts that could result in fire or electric shock.
17. Follow all warnings and cautions in this manual and on the projector.
18. The unit should only be repaired by appropriate service personnel.
19. The projector surface gets hot when run for long periods of time. Avoid touching the projector until it has been turned off and has cooled down.

CAUTION
RISK OF EXPLOSION IF BATTERY IS REPLACED
BY AN INCORRECT TYPE.
WHEN DISPOSING BATTERIES, BE SURE TO
DO SO IN AN ENVIRONMENTALLY PROPER
MANNER.

COPYRIGHT / TRADEMARK

© Copyright 2014. All rights reserved.

The manufacturer reserves the right to make technical changes. The manufacturer assumes no liability for damages incurred directly or indirectly from errors, omissions, or discrepancies between the device and this documentation.

Other brands or logos are trademarks or registered trademarks of their respective companies.

This device is not intended for use in the direct field of view at visual display workplaces.

DECLARATION OF CONFORMITY

Manufacturer: InFocus Corporation, 13190 SW 68th Parkway, Portland, Oregon 97223-8368 USA

We declare under our sole responsibility that this projector conforms to the following directives and norms:

EMC Directive 2004/108/EC

ErP Directive 2009/125/EC

EMC: EN 55022: 2010

EN 55024: 2010

EN 61000-3-2: 2006+A2:2009

EN 61000-3-3:2008

Low Voltage Directive 2006/95/EC

Safety: IEC 60950-1:2005; EN 60950-1:2006+A12:2011

TRADEMARKS

Apple, Macintosh, iPod, iPod nano, and iPhone are trademarks or registered trademarks of Apple Computer, Inc. IBM is a trademark or registered trademark of International Business Machines, Inc.

Microsoft, PowerPoint, and Windows are trademarks or registered trademarks of Microsoft Corporation. Adobe and Acrobat are trademarks or registered trademarks of Adobe Systems Incorporated. InFocus, In Focus, INFOCUS (stylized), MondoCenter, Mondopad, BigTouch, JTouch, and LitePro are either registered trademarks or trademarks of InFocus Corporation in the United States and other countries.



NOTE: This product is covered electrical and electronic equipment under the European Union's Waste from Electrical and Electronic Equipment ("WEEE") Directive (2002/96/EC). The WEEE Directive requires that covered equipment be collected and managed separately from typical household waste in all EU member states. Please follow the guidance of your local environmental authority or ask the shop where you purchased the product for collection or recycling options.

FCC WARNING

This device complies with part 15 of the FCC Rules. Operation is subject to the following two conditions: (1) This device may not cause harmful interference, and (2) this device must accept any interference received, including interference that may cause undesired operation.

Note: This equipment has been tested and found to comply with the limits for a Class B digital device, pursuant to part 15 of the FCC Rules. These limits are designed to provide reasonable protection against harmful interference in a residential installation. This equipment generates, uses and can radiate radio frequency energy and, if not installed and used in accordance with the instructions, may cause harmful interference to radio communications. However, there is no guarantee that interference will not occur in a particular installation. If this equipment does cause harmful interference to radio or television reception, which can be determined by turning the equipment off and on, the user is encouraged to try to correct the interference by one or more of the following measures:

--Reorient or relocate the receiving antenna.

--Increase the separation between the equipment and receiver.

--Connect the equipment into an outlet on a circuit different from that to which the receiver is connected.

--Consult the dealer or an experienced radio/TV technician for help.

Changes or modifications not expressly approved by InFocus Corporation may void authority to operate the equipment.

CANADA

This Class B digital apparatus complies with Canadian ICES-003. Cet appareil numérique de la classe B est conforme à la norme NMB-003 du Canada.

AGENCY APPROVALS

FCC, CE, and CB

Other specific Country Approvals may apply. Please see product certification label.

This document applies to regulatory model IN1142.

Input ratings: AC 110-240V, 9-4A, 50-60Hz

InFocus reserves the right to alter product offerings and specifications at any time without notice.

PRODUCT OVERVIEW

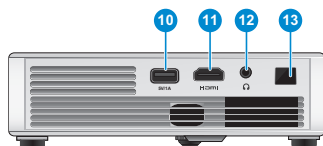
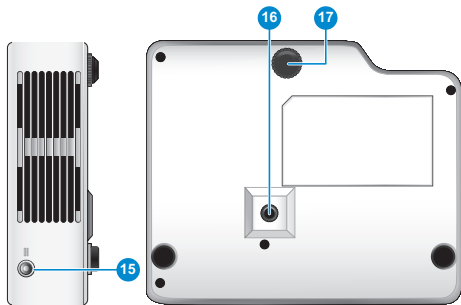
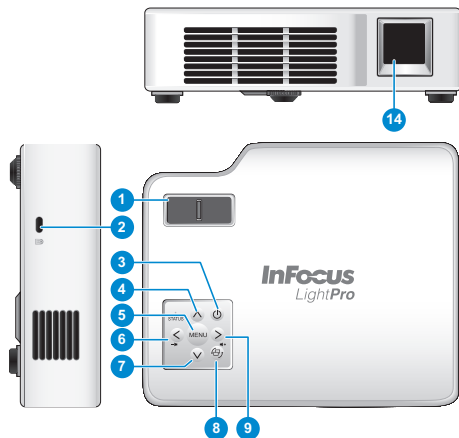

- | | |
|---------------------------|----------------------------------|
| 1. Focus Dial | 10. USB Connector (Service Only) |
| 2. Kensington Lock | 11. HDMI Connector |
| 3. Power Button (⏻) | 12. Audio Output Connector |
| 4. Up Button (▲) | 13. IR Receiver |
| 5. Menu Button (MENU) | 14. Lens |
| 6. Left Button (◀) | 15. DC Input |
| 7. Down Button (▼) | 16. Screw Hole for Tripod |
| 8. Auto Source Button (⌂) | 17. Elevator Foot |
| 9. Right Button (▶) | |

Remote Control

1. Power Button
2. Up Button
3. Auto Source Button
4. Menu Button
5. Enter Button
6. Left Button
7. Right Button
8. Zoom Button
9. Aspect Ratio Button
10. Down Button

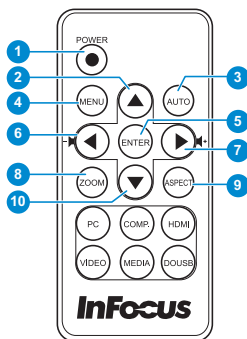

Note

- IN1142 does not have EZ Suite.
- PC, COMP, HDMI, VIDEO, MEDIA, and DOUSB are not supported in IN1142.

Note
Items 4-10 are also function buttons. Functions vary depending on the current mode.

ACCESSORY OVERVIEW

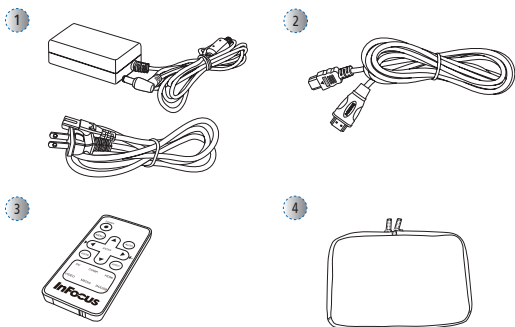

Standard Accessory

1. Power cord / AC adaptor
2. HDMI cable
3. Remote control (batteries not included)
4. Carrying case

Note
The standard accessories may vary in each region due to different applications.
The inclusive power cord varies per region.
CR2025 battery required for remote control.

POWER ON / OFF

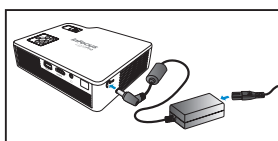

1. Connect the power cord to the DC input jack on the rear of the projector.

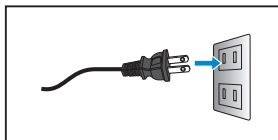

2. Insert the plug at the other end of the power cord into a power outlet.
The status LED lights red in standby mode.

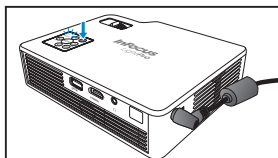

3. Press the Power button (⏻) to turn the projector on or off.
The status LED turns green when the projector is turned on.

ADJUST PROJECTED IMAGE HEIGHT

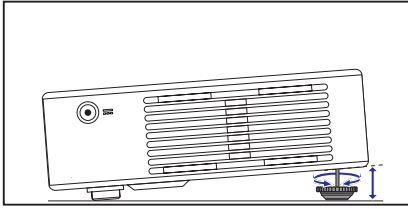

The projector is equipped with an elevator foot for adjusting the projected image height.

To adjust the height:
Turn the elevator foot to adjust the projected image position to the desired height.

Note
If Auto Keystone is enabled and there are no changes within 2-3 seconds, the projector will automatically adjust the image display via the Auto Keystone function.

Touchboards

205 Westwood Ave, Long Branch, NJ 07740
Phone: 866-94 BOARDS (26273) / (732)-222-1511
Fax: (732)-222-7088 | E-mail: sales@touchboards.com

ADJUST THE PROJECTED IMAGE

Screen Size - Diagonal		Projection Distance		Screen Size - Width		Screen Size - Height	
(D)		(A)		(B)		(C)	
(inch)	(mm)	(inch)	(meter)	(inch)	(mm)	(inch)	(mm)
20	508	23.62	0.60	16.97	431	10.59	269
40	1016	47.64	1.21	33.94	862	21.18	538
60	1524	71.26	1.81	50.87	1292	31.81	808
80	2032	94.88	2.41	67.83	1723	42.40	1077
100	2540	118.90	3.02	84.80	2154	52.99	1346
120	3048	142.52	3.62	101.77	2585	63.58	1615
140	3556	166.14	4.22	118.70	3015	74.21	1885
160	4064	189.76	4.82	135.67	3446	84.80	2154
180	4572	213.78	5.43	152.64	3877	95.39	2423

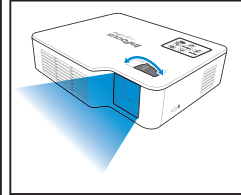
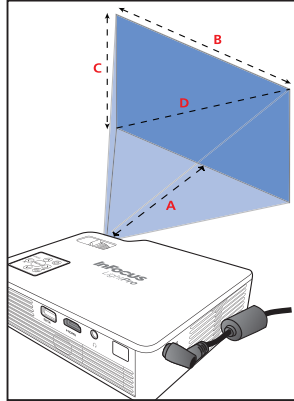

Adjust the focus until the image is clear.

CONNECT INPUT SOURCE - HDMI

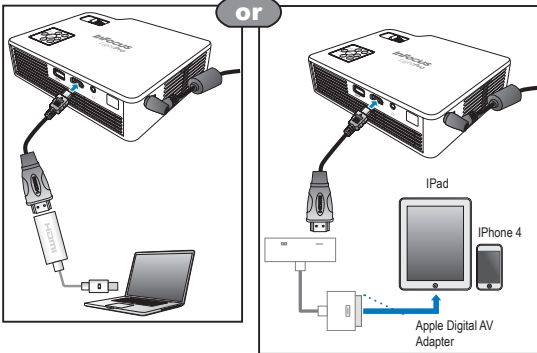

1. Connect the HDMI device using an appropriate cable.
2. After powering on, the projector will automatically detect the HDMI input.

Note
1. All other brand and product names are trademarks or registered trademarks of their respective companies.
2. iPod nano/iPod touch/iPhone/iPod classic (version 5 and above)
3. Designed for iPod/iPhone/Mobile phone/PMP with TV out functions. Using with devices with audio signal voltage > 0.3Vrms is not recommended.

MOUNT THE PROJECTOR

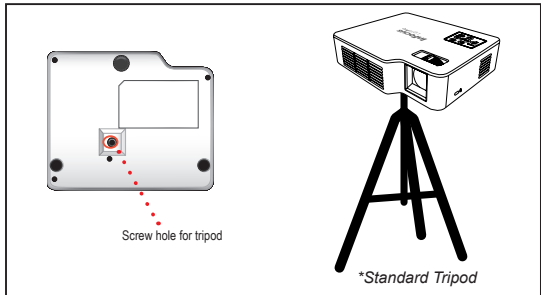

Screw a standard tripod into the screw hole on the projector.

Note
The tripod is an optional accessory.

HOW TO USE THE MENU

Entering Menu Mode

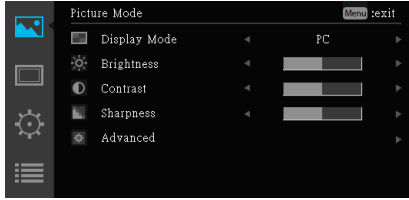
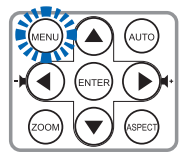

Menu Operation	
▲ Select main menu	▶ Enter current submenu
▼	○ MENU Hide OSD menu
Submenu Operation	
▲ Move up	◀ Adjust setting
▼ Move down	▶

Press **MENU** on the remote control or **MENU** on the control panel to enter the menu mode.

Menu Items

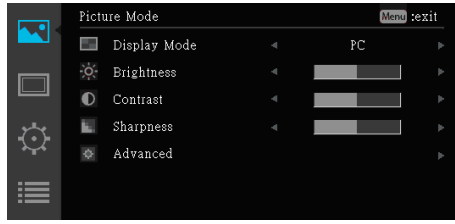

PICTURE menu

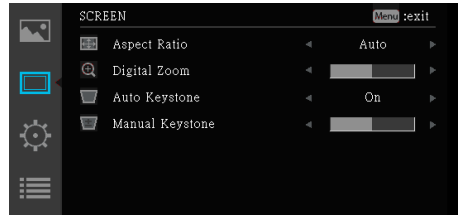

SCREEN menu

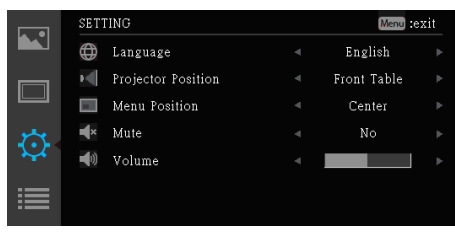

SETTING menu

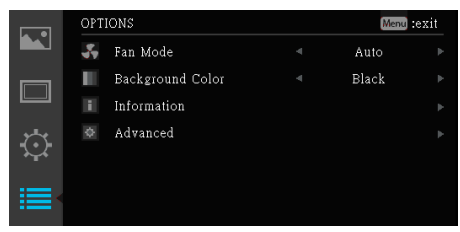

OPTIONS menu

Refer to the below table for menu item details.

Menu	Menu item	Description	
PICTURE	Display Mode	Set the brightness of the display.	
	Brightness	Adjust the brightness of the image.	
	Contrast	Adjust the contrast of the image.	
	Sharpness	Adjust the sharpness or softness of the image.	
	Advanced		Set advanced settings for projected image.
		Gamma	Adjust the color gamma differences between the dark and bright portions of the input signal.
		BrilliantColor	Increase the brightness by changing the colors.
		Color Temperature	Select the color temperature in the display.
		Color Space	Adjust the color for projected image from a video input signal.
	Exit	Return to the PICTURE submenu.	
SCREEN	Aspect Ratio	Select the aspect ratio of the display.	
	Digital Zoom	Digitally enlarge the projected image.	
	Auto Keystone	Automatically adjust the trapezoidal (keystone) distortion of the projected image.	
	Manual Keystone	Manually adjust the trapezoidal (keystone) distortion of the projected image.	
SETTING	Language	Set the on-screen display language.	
	Projector Position	Select the projector position.	
	Menu Position	Set the display position of the OSD menu.	
	Mute	Temporarily turn off the sound.	
	Volume	Adjust the volume of the built-in speaker.	
OPTIONS	Fan Mode	Set the fan speed according to altitude.	
	Background Color	Set the background screen color when there is no input signal.	
	Information	Display the projector information.	
	Advanced		Configure other general settings.
		Direct Power On	Turn on the projector power automatically when the power supply is switched on.
		Auto Power Off	Set the projector to automatically turn off if it is left idle at the preset time.
		Reset All Settings	Reset all settings to the factory default settings.
	Exit	Return to the OPTIONS submenu.	

SPECIFICATIONS

Item	Description
Model	IN1142
Imager	DMD WXGA 0.45"
Native Resolution	1280x800 WXGA
Projection Distance	0.9-2.4 m (3'0" to 7'11")
Projection Screen Size	20"-150" (0.5m to 3.81m)
Focus	Manual
Throw Ratio	1.4
Vertical Keystone	±40°
Projection Modes	Table Top, Front Projection, Rear Projection
Standard Input Resolutions	up to SXGA+ (60Hz)
SDTV/EDTV/HDTV	480i, 480p, 576i, 576p, 720p, 1080i
Horizontal Frequency	30.5 - 91.1kHz
Vertical Frequency	50 - 85Hz
Safety Certifications	CE, CB, FCC
Operating Temperature	0 - 40°C (32°F-104°F)
Dimensions (WxHxD)	170 x 42.5 x 138mm (6.7" x 1.7" x 5.4")
Power Input	AC adapter 100~240 V, 50Hz/60Hz
Power Consumption	Typical 60W@110Vac
Standby	<0.5W
Lamp	LED
Lamp Life	20,000 Hours
Speakers	1Wx1
Input Ports	HDMI
Security	Kensington Slot

TROUBLESHOOTING

If you experience a problem with your projector, please refer to the following information. If a problem persists, please contact your local retailer or service center.

Image Problems

☆ No image appears on-screen

- Ensure the power cord is correctly and securely connected.
- Ensure the pins of connectors are not crooked or broken.
- Make sure the projector is switched on.

☆ Image is out of focus

- Adjust the Focus Dial.
- Make sure the projection screen is between the required distance 0.9 to 2.4 meters (2ft 11in to 7ft 10in) from the projector. See page 5.

☆ Image is too small or too large

- Move the projector closer to or further from the screen.

Audio Problems

☆ No sound

- During music playback, press ◀▶ on the remote control or </> on the control panel.

Note

When the projector temperature reaches 85°C, the projector automatically shuts down due to the built-in temperature protection. This is not a malfunction. Let the projector cool down before switching it on again.

Touchboards

205 Westwood Ave, Long Branch, NJ 07740

Phone: 866-94 BOARDS (26273) / (732)-222-1511

Fax: (732)-222-7088 | E-mail: sales@touchboards.com