



HARDWARE GUIDE

55"/65"/75"/86"

MONDOPAD™ ULTRA
MONDOPAD LAUNCH™
MONDOPAD CORE™ /PC
MONDOPAD CORE
JTOUCH™



ABOUT THIS GUIDE

This guide contains assembly and connection instructions for your touch display, and also basic instructions on its operation. It applies to the Mondopad Ultra, Mondopad Launch, Mondopad Core/PC, Mondopad Core and to the JTouch; where appropriate, specific models are noted.

After the display is installed and connected, refer to the appropriate software guide at www.infocus.com/support for more information.

CONTENTS

ABOUT THIS GUIDE.....	1
SAFETY PRACTICES.....	5
Safety definitions.....	5
General.....	5
Moving the display.....	5
Installation and location.....	5
Ventilation.....	6
Power source, power cord, plugs.....	6
Medical concerns.....	7
The display and the remote control.....	7
Cleaning the display.....	7
INCLUDED ACCESSORIES.....	8
SET UP.....	9
Mounting technique.....	9
Install the OPS PC module (Mondopad Ultra, Launch and Core/PC).....	9
Attach the camera (Mondopad Launch and Ultra).....	10
Attach the keyboard extender (Mondopad Ultra, Launch and Core/PC).....	10
Connect the display to power.....	11
BASIC FUNCTIONS.....	11
Turn the display on and off.....	11
Adjust the volume.....	12
Using the remote control.....	12
The remote buttons.....	13
PORT LOCATIONS.....	14
55" display port locations – front, under and side panels.....	14
65", 75" and 86" display port locations – front, under and side panels.....	15
CONNECTING TO OTHER DEVICES.....	16
The side panel ports – 55" displays.....	16
The side panel ports – 65", 75" and 86" displays.....	17
The front panel ports.....	18
The under panel ports.....	18
The PC ports (Ultra, Launch and Core/PC).....	19
The front panel buttons.....	19
CONNECT THE DISPLAY TO AN EXTERNAL PC.....	20
CONNECT THE INTERNAL ANDROID TO WI-FI.....	21
TOTAL TOUCH CONTROL™.....	22
Accessing Total Touch Control.....	22
The primary menu icons.....	22
The Source submenu.....	23
Selecting a source with the remote control.....	24
The Advanced Functions submenu.....	25
THE ON-SCREEN DISPLAY SETTINGS.....	26
Accessing the On-Screen Display settings.....	26
Adjusting the picture.....	26

Picture Mode functions.....	27
Adjusting the sound	28
Sound Mode functions.....	28
Adjusting the settings.....	29
Settings Mode functions.....	30
ANDROID SETTINGS.....	31
Accessing the Android settings.....	31
Device settings.....	31
Preference settings	32
Personal settings.....	33
TROUBLESHOOTING.....	34
LIMITED WARRANTY.....	37
DECLARATION OF CONFORMITY.....	41

SAFETY PRACTICES



Read and follow all safety instructions in this guide, and on the display and packaging, before connecting the display to power. Failure to comply with safety instructions may result in property damage, personal injury or even death.

Save these instructions for future reference.

Safety definitions

This guide contains information that is very important to know and understand. This information is provided for safety and to prevent equipment problems. To help recognize this information, observe the following:

WARNING

WARNING indicates a potentially hazardous situation which, if not avoided, could result in serious personal injury or death.

CAUTION

CAUTION indicates a potentially hazardous situation which, if not avoided, may result in minor or moderate personal injury.

NOTE: Refers to important information. It is recommended that you take special notice of these items.

General

Refer to this guide for proper startup and shutdown procedures.

NOTE: To avoid damage, turn off the display and unplug the power cord if there is a power outage, unstable voltage, a thunderstorm, an abnormal sound or smell, or power cord damage. To avoid further damage, turn off the display if it is damaged by an impact, fall or strike.

Moving the display

CAUTION

Move and install this display with two individuals, as it is very heavy. Do not attempt to move or install the display by yourself or it may fall, causing personal injury.

NOTE:

- Do not tilt or invert the carton when you move it. Always keep the carton upright, or the display and/or accessories may be damaged.
- Hold the display firmly, using the handles and side or bottom bezels, when you move it. Do not hold the top bezel or it may break.
- Hold the display by the corners and bottom. Do not exert pressure on the front of the display or it may break.
- Disconnect all accessories and cables before moving or repositioning the display, or they may be damaged.

Installation and location

WARNING

- Do not tip, shake or rock the display or it may fall. Severe personal injury or death may occur.
- The mounting means should be strong enough to bear the weight of the display. For 55" displays, use only metric 6 (3.505 mm) screws; for 65", 75" and 86" displays, use only metric 8 (12 mm) screws when you mount the display to a wall. Use spring

washers to prevent the screws from coming loose. In North America, the mounting interface should comply with the UL1678 standard. If these conditions are not met the display may fall, which may cause severe personal injury or death.

- To avoid the potential for electrocution, do not use any components of the display, including the speakers, near water.
- Do not install the display in places subject to mechanical vibration, or place the display on an unstable surface, or it may fall. Severe personal injury or death may occur.

NOTE:

- Do not install or use the display or speakers near any heat source such as radiators, heat registers or stoves, or they may be damaged.
- To avoid damage to the display, do not place it in direct sunlight, in humid, greasy or dusty places, or in places where the display may come into contact with rain, smoke, steam, flammable or explosive substances, or combustible or corrosive gases. Similarly, make sure no exposed flame source, such as lighted candles, is placed on the display.

Ventilation

NOTE: To ensure reliable operation and to protect the display from overheating, ensure that the following conditions are met:

- If the display is mounted to a wall, maintain a clearance of at least 2 inches (5 cm) between the display and the wall to provide adequate ventilation. Do not block ventilation openings. Locate the display in a well-ventilated area without obstructions to intake or exhaust vents.
- Position the display at least 4 feet (1.2 m) away from heating and cooling vents.
- Maintain a minimum clearance of 1-1/2 inches (30 cm) above, 1/2 inch (10 cm) on each side, and 1/2 inch (10 cm) below the display to provide adequate ventilation.

Power source, power cord, plugs

WARNING

Make sure the power outlet used to power the display is readily accessible for fast disconnection, in case of an emergency.

- Do not use an outlet that has been damaged or has a non-standard power supply. Electrical shock or damage to the display may occur.
- This display is a ground class 1 device. To prevent electrical shock to the user or damage to the display:
 - Use the provided 3-conductor power cord and 3-prong AC plug.
 - Connect the plug into a corresponding AC outlet. The outlet must have a protective safety (earth) ground terminal.
- Use a surge-protected power strip. Do not overload wall outlets, or an electrical fire may occur.
- To avoid the potential for electrocution, do not position the display so that the power cord is near water – for instance, near a bathtub, washbowl, kitchen sink or swimming pool.
- Protect the power cord from any damage which would create an electrical hazard:
 - Do not place heavy objects on the power cord.
 - Prevent the power cord from being walked on or pinched, particularly at plugs, convenience receptacles and the point where the plugs exit from the display.
 - Hold the plug, not the cord, when you disconnect the system.
 - Keep the plug free of dust and debris.
- Do not touch the power cord with wet hands, or electrocution may occur.

Medical concerns

CAUTION

Prolonged use or use in dim light may contribute to Computer Vision Syndrome (CVS), a group of vision-related problems that result from prolonged computer and smart phone use.

NOTE: Liquid crystal (LC) fluid may be a skin irritant. In the unlikely event that the LCD screen breaks and LC fluid contacts your skin, rinse the affected area for 15 minutes.

The display and the remote control

WARNING

To avoid the potential for electrocution, as well as product damage:

- Do not expose this equipment, or any component of this equipment, to rain or moisture.
- Do not insert any sharp objects or metal, or introduce any liquid, into or onto the display. Do not allow such objects or liquid to contact ventilation holes or signal connectors.
- Do not remove the cover or back of the display, or service the display yourself. Doing so will void the warranty. Refer all service to qualified service personnel.
- Use only replacement parts specified by InFocus. In addition to personal injury and/or product damage, doing so may void the warranty.

WARNING

Do not allow children to climb on the display. Severe personal injury including death, as well as damage to the display, may occur.

NOTE:

- Unplug the display during a thunderstorm. Electrical damage from a power surge may occur.
- Do not drop or twist the display or you may damage it.
- Do not use hard objects as styluses, or press forcibly on the display screen. The screen is fragile and can be damaged if you press too hard.
- Do not allow any image to display indefinitely on the screen. A “ghost image” (a permanent discoloration in a certain area) may occur. Ghost image damage is not covered by warranty.
- If the display is moved, do not use it immediately. Allow it to adjust to the new temperature slowly.
- Dispose of used remote control batteries (not included) in accordance with local disposal laws.

Cleaning the display

Use an alcohol-free, ammonia-free cleaner, applied with a microfiber cleaning cloth.

Never use any type of wax, chemicals, window cleaner, soap, scouring powder, or any cleanser with solvents such as alcohol, benzene, ammonia, or paint thinner. Never use abrasive pads or paper towels, as they can scratch the screen and cause permanent damage.

Do not spray the cleaner directly onto the screen. Instead, apply a small amount of cleaner on a corner of the microfiber cloth.

Follow these steps:

- Turn the display off, let it cool for a few minutes, and then unplug it. Spray cleaner onto the cloth, and then gently clean the screen. Continue to spray cleaner onto the cloth, and then gently wipe, until the screen is clean.
- Wipe the screen as gently as possible. The screen is fragile and can be damaged if you press too hard.
- Let the screen dry completely before you plug the display back in.

INCLUDED ACCESSORIES

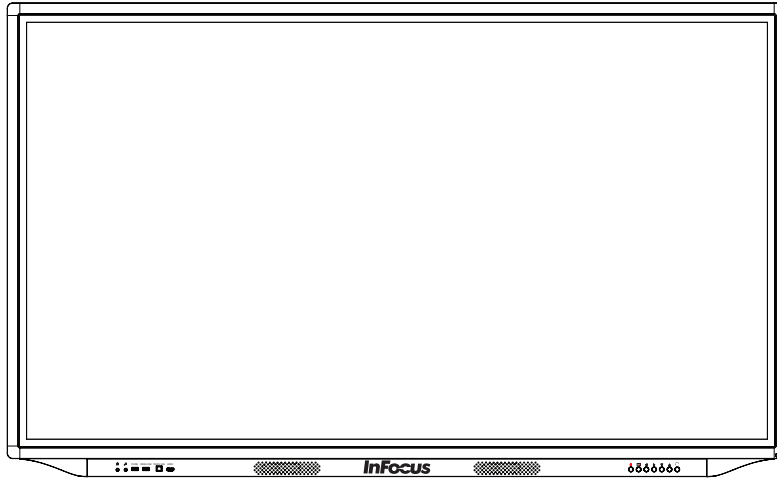

JTouch
MP Core
MP Core/PC
MP Launch
MP Ultra

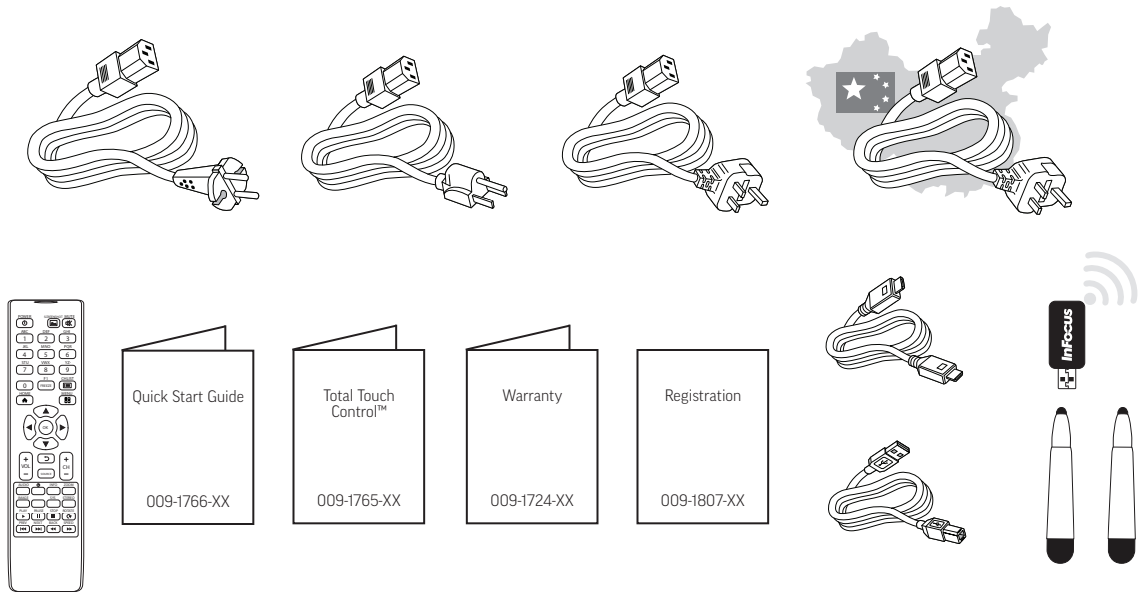

MP Core/PC
MP Launch
MP Ultra

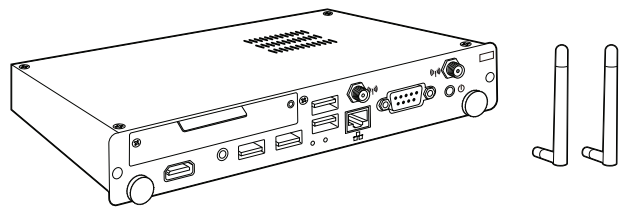
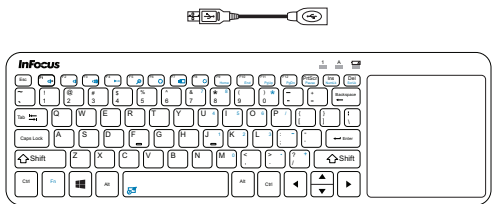

MP Launch
MP Ultra

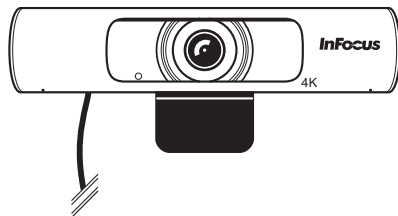

NOTE: Accessories such as the PC, keyboard, WiFi dongle, and/or the USB dongle may be stored inside the protective styro-foam at the top or bottom of the display.

NOTE: For setup purposes, a keyboard and mouse are recommended. For additional accessory options such as stands, feet, carts and wall mounts, see the InFocus website (www.infocus.com/store) or your local dealer.

SET UP

Mounting technique

This product does not ship with mounting accessories. Only use commercially manufactured mounting accessories which meet the product specifications.

- Use a professional technician to install the display.
- Mount the display to a solid wall or a stable horizontal surface.
- Chose a mounting point which will protect the display from environmental hazards such as heavy dust, insects, condensation and other moisture, as well as strong electromagnetic fields.
- Install the display near an easily accessible AC power outlet.
- Use only properly-rated wall and stand mounting hardware that meets the product specifications. The warranty does not cover damage caused by use of improperly-rated mounting hardware or from improper installation.
 - After you remove the display from its carton and before you install it, always place the display front screen side down on a clean, cushioned surface, to prevent damage to the screen surface.
 - The mounting means should be strong enough to bear the weight of the display:
 - For 55" displays, use only metric 6 (3.505 mm) screws; for 65", 75" and 86" displays, use only metric 8 (12 mm) screws when you mount the display to a wall. Use spring washers to prevent the screws from coming loose.
 - The mounting interface should comply with the UL1678 standard in North America.
 - Maintain a distance of at least 2" (5 cm) between the display and the wall, if the display is installed against the wall; this distance provides adequate ventilation.

Install the OPS PC module (Mondopad Ultra, Launch and Core/PC)

- 1) Remove the PC cover plate on the side panel by removing the two screws (1).
- 2) Insert the PC into the slot with an orientation as shown in (2).
- 3) Attach the PC using the two screws you removed in step 1.
- 4) Install the two antennas (screw on) per (3).

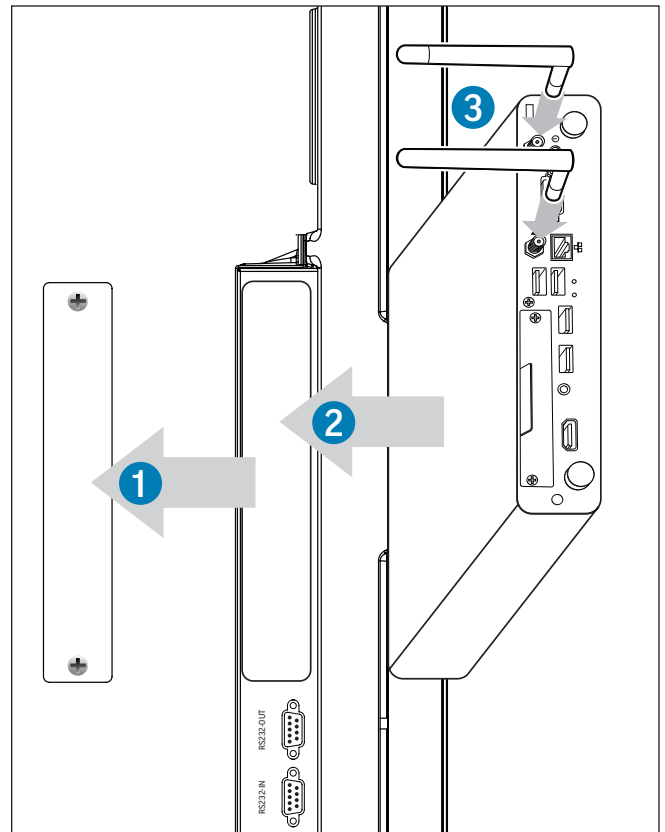

Attach the camera (Mondopad Launch and Ultra)

- 1) Attach the camera to the bracket with the four included Phillips screws.
- 2) Remove the plastic film from the camera lens, if any is present.
- 3) Position the camera and bracket on top of the display. Fold the hinge on the bracket in or out until the camera is stable.
- 4) Plug the USB cable into an appropriate USB port on the touch display.

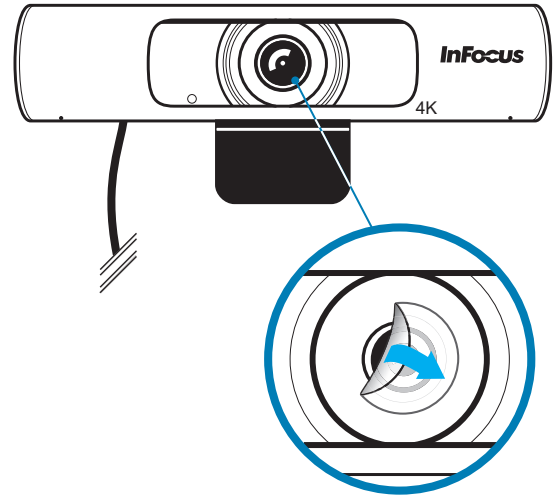

Fold the hinge in or out until the camera is stable.

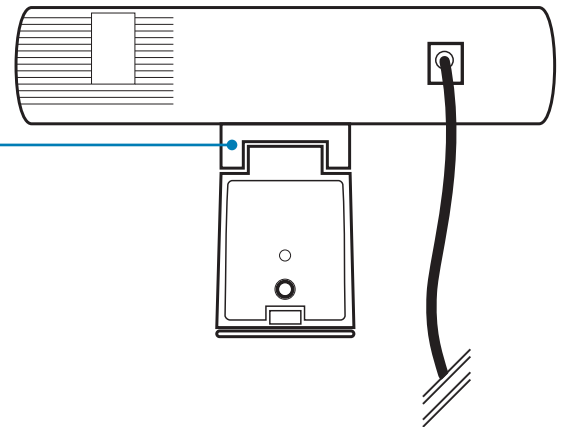

Attach the keyboard extender (Mondopad Ultra, Launch and Core/PC)

- 1) Remove the dongle from the battery compartment in the back of the keyboard.
- 2) Attach the dongle to the keyboard extender, then to the OPS PC-USB port (page 16 and page 17).

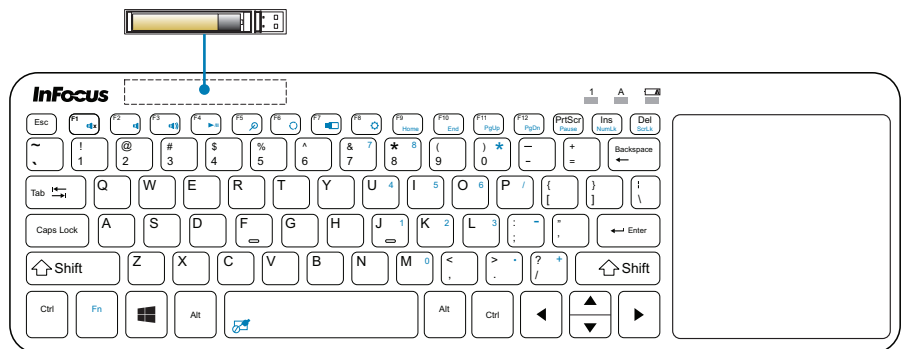

To the OPS PC-USB port



Connect the display to power

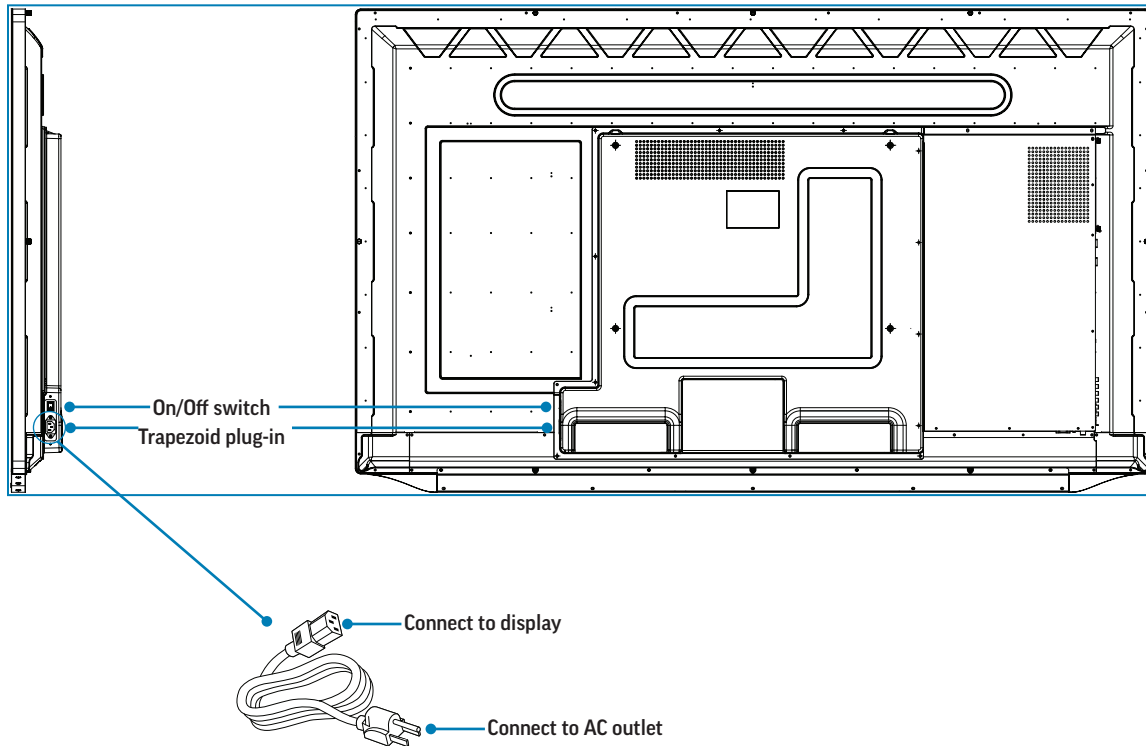

- 1) Connect the plug end of the AC power cord to the **Trapezoid plug-in** (above) on the back of the display.
- 2) Connect the 3-prong end of the AC power cord to an AC outlet.

NOTE: Depending on your region, it may be necessary to check for compatibility.

BASIC FUNCTIONS

Turn the display on and off

- 1) Make sure that the power cord is connected to a power outlet and that the power switch is on (above).
- 2) Press the **Power** button on the remote (page 12) or on the front panel of the touch display. The LED on the front of the display turns from green to red (off) or from red to green (on).

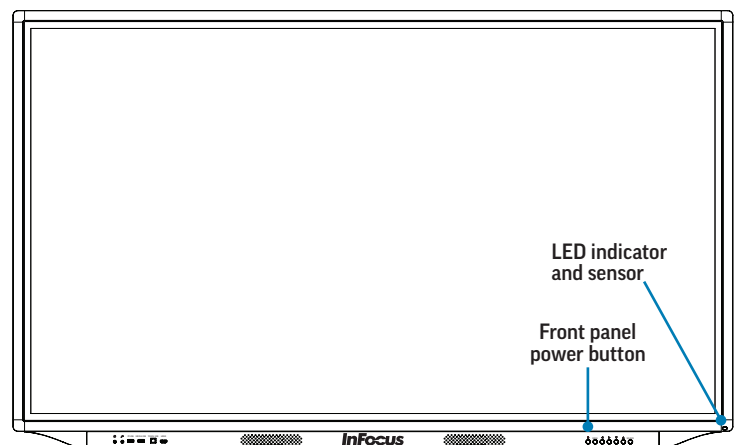

Adjust the volume

- 1) Press the volume up or down button on the remote (page 13); or
- 2) Press the left or right arrow buttons on the front of the touch display (page 19); or
- 3) Touch the volume icon on the Total Touch Control menu (page 25). A volume scale appears near the bottom of the touch display. Slide the button to the left or right.

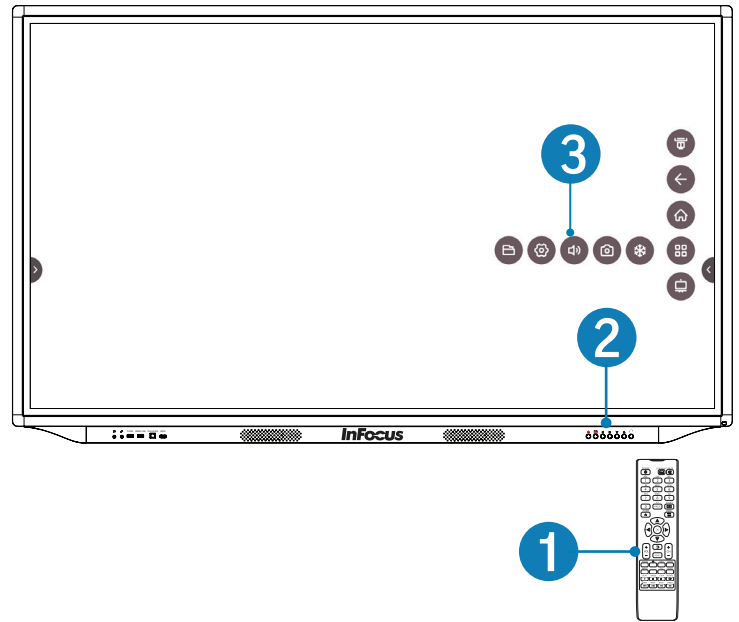

Using the remote control

The remote uses two AAA batteries (not included). Install the batteries by removing the cover from the back of the remote, orienting the positive and negative ends of the batteries, sliding them in place and replacing the cover.

To operate, point the remote at the LED indicator at the bottom right-hand corner of the touch display. The range of optimum operation is about 26' (8m) and within a horizontal and vertical angle of 30 degrees.

NOTE:

- Dispose of the batteries in an environmentally proper manner.
- If the remote gets wet, wipe it dry immediately.
- Avoid excessive heat and humidity.
- Do not mix new and old batteries or different types of batteries.
- Replace the batteries as soon as they run out.
- Remove the batteries if the remote will not be used for a prolonged period.

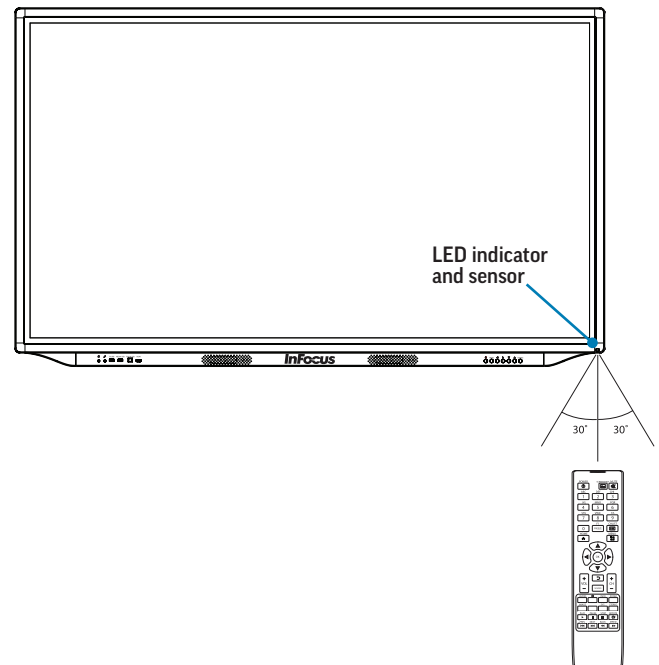

The remote buttons

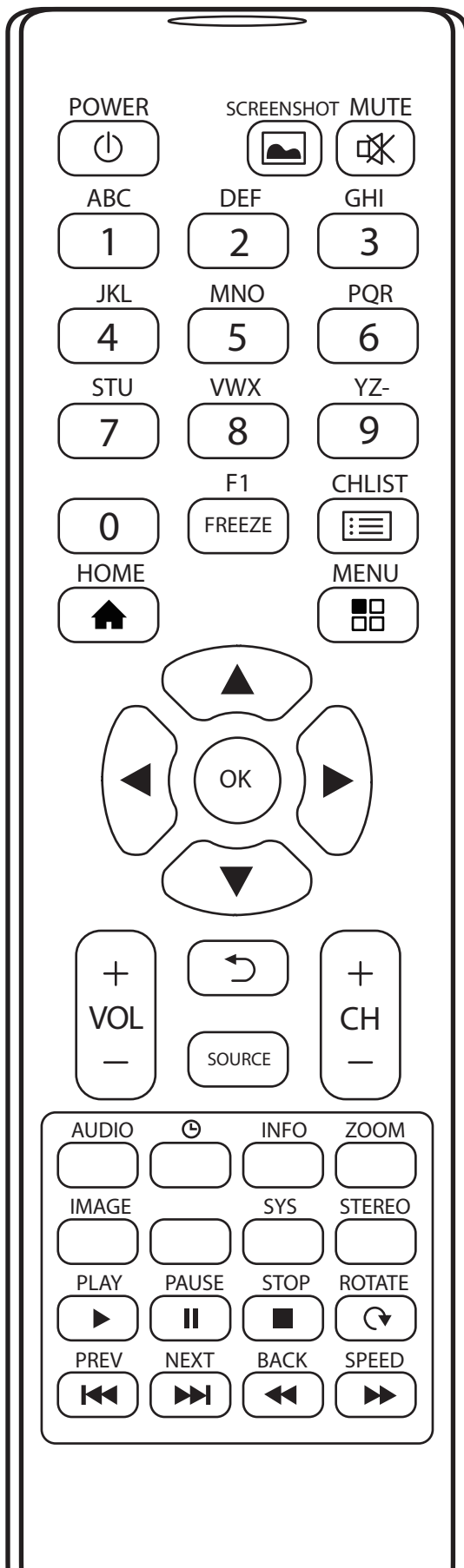

Button	Function
Power	Switches the power on or off
Screen-shot	Takes a screen shot
Mute	Switches the audio on or off
Numbered keys	Inputs any letter or number
Freeze	When enabled, freezes the image which is currently displayed
CH List	Reserved for future use
Home	Displays the home screen
Menu	Displays module menu choices. NOTE: The menu button has no function in the home screen.
Direction arrows	Use these buttons to navigate through and make choices in the on-screen menus.
OK	Confirms the operation (Enter).
Volume up or down	Turns the speaker volume up or down
Back	Returns to the previous screen
Channel up or down	Reserved for future use
Audio	Accesses the on-screen sound display sound mode menu: movie sports; user; standard; music settings
Sleep mode	Sets a "sleep time" for the display.
Info	Reserved for future use
Zoom	Accesses the ODS menu mode for panorama, PC mode, just scan, auto, and default settings
Image	Accesses the on-screen display picture mode menu: user; standard; lightness; soft; PC settings
Blank	Reserved for future use
Sys	Reserved for future use
Stereo	Reserved for future use
Play	For online video – plays media
Pause	For online video – pauses media play
Stop	For online video – stops media play
Rotate	For online video – rotates the picture
Prev	For online video – skips to the previous scene
Next	For online video – skips to the next scene
Back	For online video – reverses quickly
Speed	For online video – fast forwards

PORT LOCATIONS

55" display port locations – front, under and side panels

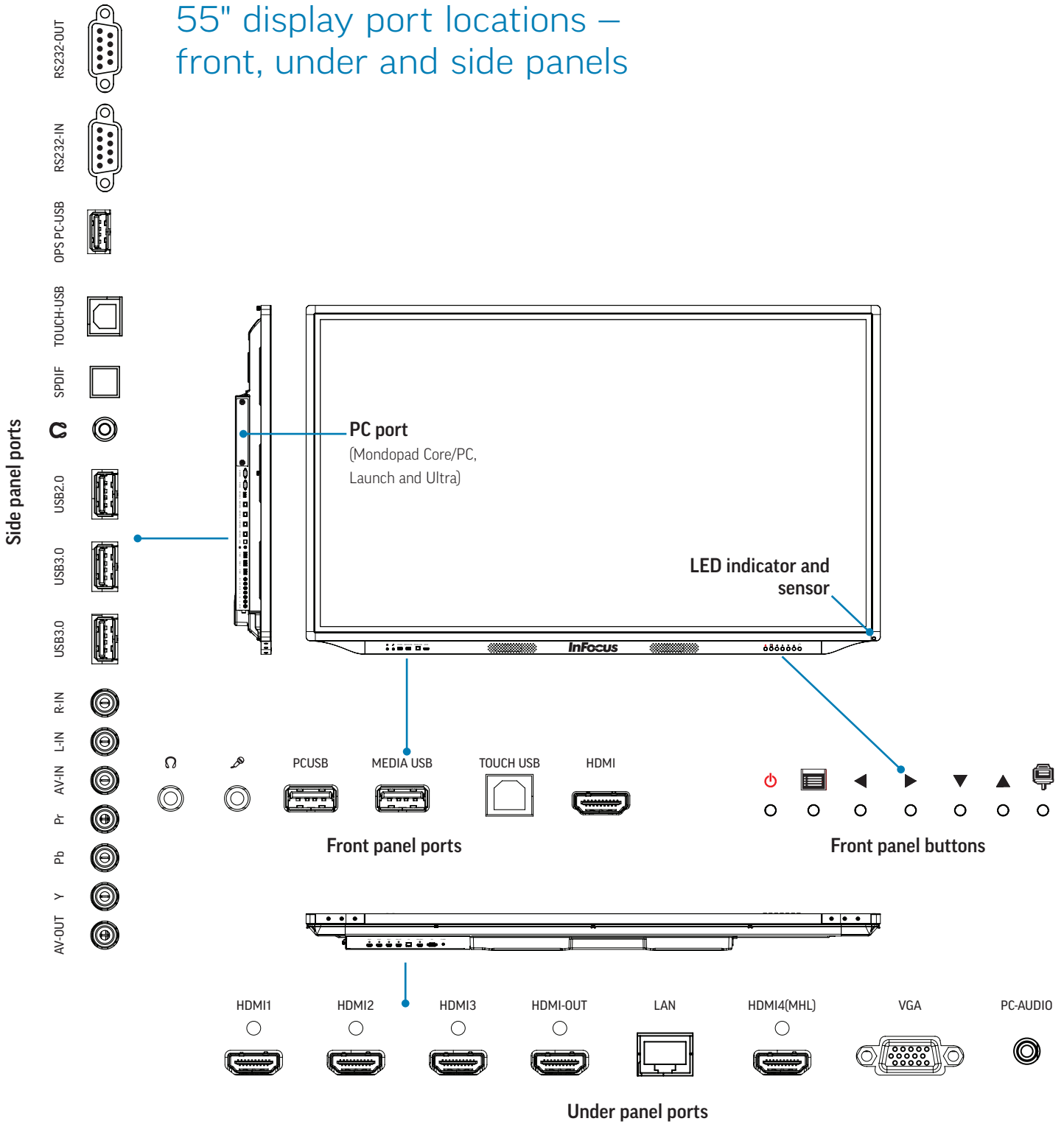

65", 75" and 86" display port locations – front, under and side panels

Side panel ports

- RS232-OUT
- RS232-IN
- OPS PC-USB
- TOUCH-USB4
- TOUCH-USB3
- TOUCH-USB2
- TOUCH-USB1
- SPDIF
- USB2.0
- USB3.0
- USB3.0
- USB3.0
- R-IN
- L-IN
- AV-IN
- Pr
- Pb
- Y
- AV-OUT

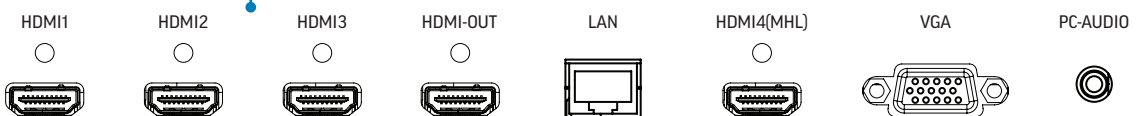
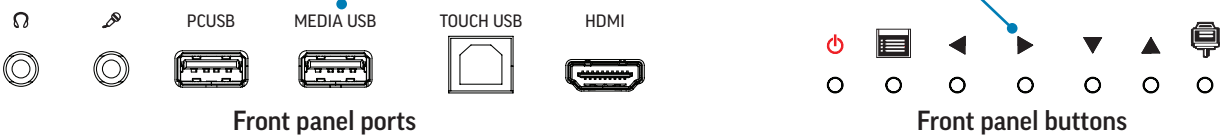
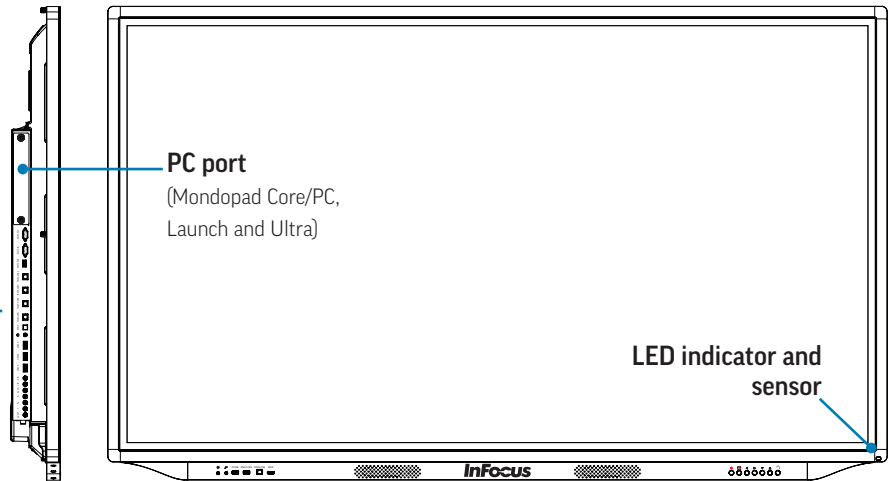

Under panel ports

CONNECTING TO OTHER DEVICES

Connection ports are located on the left side panel, the front, and also under the display. They can be used to connect the display to a full range of digital input and output devices, including: accessories; source (input) devices; PCs; tablets; and daisy-chain displays.

The side panel ports – 55" displays

The side panel ports are located on the left side panel (page 14). This table shows how to connect them.

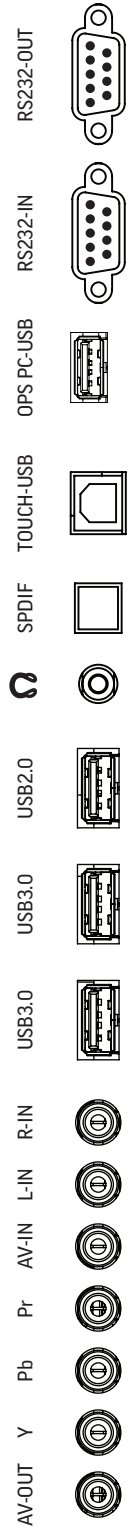

Port	Connection Instructions
AV-OUT	Connect a composite video cable to display the output from AV-IN.
Y	Connect a red component RCA video cable from the display to an external device (a DVD player, HD device or laser disc player) Y signal.
Pb	Connect a blue component RCA video cable from the display to an external device (a DVD player, HD device or laser disc player) Pb signal.
Pr	Connect a red component RCA video cable from the display to an external device (a DVD player, HD device or laser disc player) Pr signal.
AV-IN	Connect a composite video cable from the display to an external device (a VCR or a DVD player).
L-IN	Connect an RCA L/R audio cable to an external device; provides audio in for the AV-IN source.
R-IN	Connect an RCA L/R audio cable to an external device; provides audio in for the AV-IN source.
USB3.0	Connect a USB 2.0/3.0 device to the internal Android device.
USB3.0	Connect a USB 2.0/3.0 device to the internal Android device.
USB2.0	Connect a USB 2.0 device to the internal Android device.
Headset	Connect a 3.5 mm headset to output audio. NOTE: This will mute the internal speakers.
SPDIF	Connect an SPDIF cable to output audio.
TOUCH-USB	Connect an A-B cable between this type B port and your computer. Used with HDMI ports 1, 2, 3 and 4, and VGA.
OPS PC-USB	Connect a USB 2.0 device to the OPS PC module (not included with Mondopad Core and JTouch).
RS232-IN	Connect to an RS232 control device for remote control applications.
RS232-OUT	Connect to an RS232 control device for remote control applications.

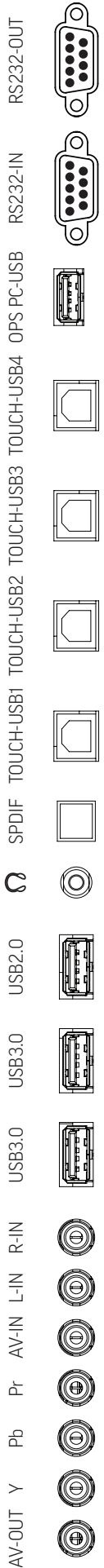

The side panel ports – 65", 75" and 86" displays

The side panel ports are located on the left side panel (page 15). This table shows how to connect them.

Port	Connection Instructions
AV-OUT	Connect a composite video cable to display the output from AV-IN.
Y	Connect a red component RCA video cable from the display to an external device (a DVD player, HD device or laser disc player) Y signal.
Pb	Connect a blue component RCA video cable from the display to an external device (a DVD player, HD device or laser disc player) Pb signal.
Pr	Connect a red component RCA video cable from the display to an external device (a DVD player, HD device or laser disc player) Pr signal.
AV-IN	Connect a composite video cable from the display to an external device (a VCR or a DVD player).
L-IN	Connect an RCA L/R audio cable to an external device; provides audio in for the AV-IN source.
R-IN	Connect an RCA L/R audio cable to an external device; provides audio in for the AV-IN source.
USB3.0	Connect a USB 2.0/3.0 device to the internal Android device.
USB3.0	Connect a USB 2.0/3.0 device to the internal Android device.
USB2.0	Connect a USB 2.0 device to the internal Android device.
Headset	Connect a 3.5 mm headset to output audio. NOTE: This will mute the internal speakers.
SPDIF	Connect an SPDIF cable to output audio.
TOUCH-USB1	Connect an A-B cable between this type B port and your computer to get touch control. Touch USB port 1 should be used with HDMI port 1.
TOUCH-USB2	Connect an A-B cable between this type B port and your computer to get touch control. Touch USB port 2 should be used with HDMI port 2.
TOUCH-USB3	Connect an A-B cable between this type B port and your computer to get touch control. Touch USB port 3 should be used with HDMI port 3.
TOUCH-USB4	Connect an A-B cable between this type B port and your computer to get touch control. Touch USB port 4 should be used with HDMI port 4 or VGA.
OPS PC-USB	Connect a USB 2.0 device to the OPS PC module (not included with Mondopad Core and JTouch).
RS232-IN	Connect to an RS232 control device for remote control applications.
RS232-OUT	Connect to an RS232 control device for remote control applications.

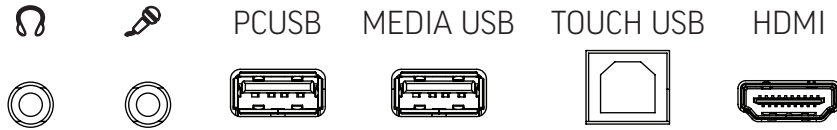

The front panel ports

The front panel ports are located on the left side of the bottom front of the touch display (page 15). This table shows how to connect them.

Port	Connection Instructions
Headset	Connect a 35 mm headset to output audio. NOTE: This will mute the internal speakers.
Microphone	Connect a 35 mm microphone or cable for audio input. Overrides audio from all other sources when connected.
PC USB	Connect a USB 2.0 device to the OPS PC module.
MEDIA USB	Connect a USB 2.0 device to the internal Android device.
TOUCH USB	Connect a USB A-B cable between this type B port and an external PC to get touch control. This works with the front HDMI port
HDMI	Connect an HDMI cable from the display to an HDMI external device, such as a computer.

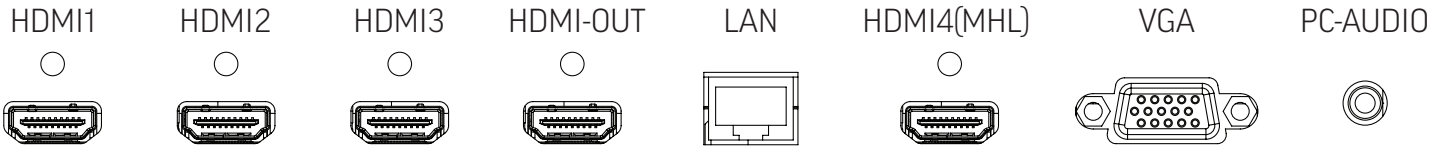

The under panel ports

The under panel ports are located on the left side of the bottom of the display (page 15). This table shows how to connect them.

Port	Connection Instructions
HDMI1	Connect an HDMI cable from the display to an HDMI external device.
HDMI2	Connect an HDMI cable from the display to an HDMI external device.
HDMI3	Connect an HDMI cable from the display to an HDMI external device.
HDMI-OUT	Connect an HDMI cable from this port to an HDMI input port on another display. This will mirror the contents of HDMI 1-3 and the front HDMI port source to a second display when either of these ports are the current selected input. NOTE: HDMI-OUT will only replicate the contents of these four ports.
LAN	Connect an RJ45 cable to provide network connections for the internal Android device.
HDMI4 (MHL)	Connect an HDMI cable from the display to an HDMI external device such as your computer. Supports HDMI 2.0/ HDCP 2.2 and MHL standards.
VGA	Connect a VGA computer cable from the monitor to an external computer.
PC-AUDIO	Connect a 3.5 mm audio cable to your computer for audio when displaying VGA input.

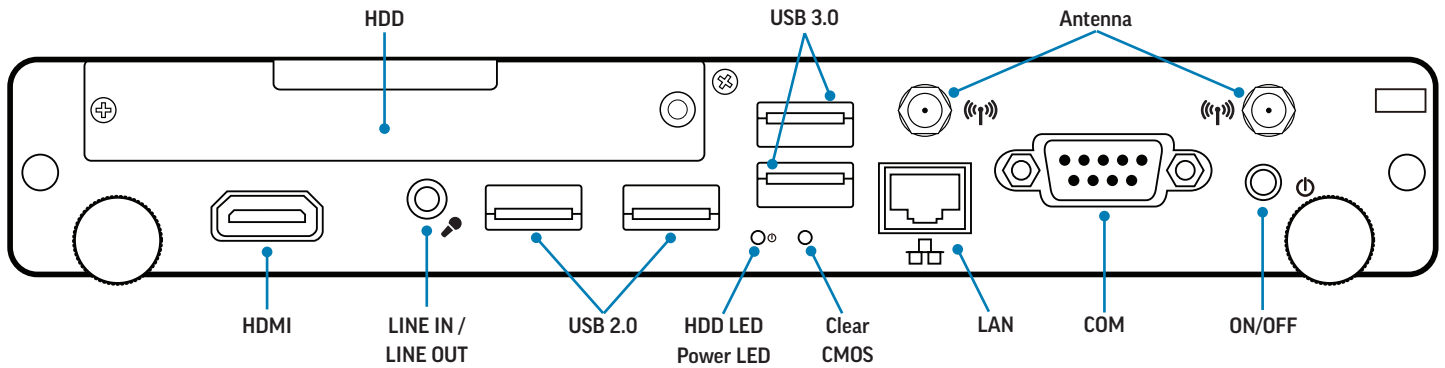

The PC ports (Ultra, Launch and Core/PC)

The PC and its ports are located on the left side panel (page 15). This table shows how to use them.

Port	Connection Instructions
HDMI Out	A secondary video output for the OPS – connect an HDMI cable from this port to an HDMI input port on another display.
LINE IN / LINE OUT	Connect a 3.5 mm audio cable to display either the in-line or line-out device.
USB (x4)	Connect a USB 2.0/3.0 device to the OPS PC module (not included with Mondopad Core and JTouch).
LAN	Connect an RJ45 cable to provide network connections for the OPS PC module (not included with Mondopad Core and JTouch).
COM	Serial connection to the OPS



The front panel buttons

The front panel buttons are located just below the display screen, on the right side (page 15). This table shows their functions.

Button	Name	Function
	Power	Switches the power to the screen on or off.
	Settings	Displays the Settings menus. NOTE: This button is not functional from the Home screen unless the display is connected to a PC, and the selected source is the PC. NOTE: To access menu options for picture mode and sound mode menu choices, each menu title bar must be set to "User."
	Volume +/- Navigation	Volume: Increases or decreases the speaker volume. Navigation: These buttons can also serve as navigation tools for selecting options on the left and right of the current selection. Touch the screen or press OK on the remote to select the highlighted choice.
	Navigation	These buttons are navigation tools for selecting options above or below the current selection. Touch the screen or press OK on the remote to select the highlighted choice.
	Total Touch Control™	Enables or disables touch screen gesture functionality for the display screen.

CONNECT THE DISPLAY TO AN EXTERNAL PC

NOTE: All available alternatives are shown below; make your connection based on your installation parameters.

- 1) Make one of the following two connections:
 - a) Connect a VGA cable from the “VGA” port on the under panel of the touch display to the VGA port on the external PC. (This connection is **color-coded blue** in the illustration below.) Or...
 - b) Connect an HDMI cable from the “HDMI” port on the front panel of the touch display to the HDMI port on the external PC. (This connection is **color-coded red** in the illustration below.)

NOTE: The audio connection (step 3, below) is unnecessary with an HDMI-to-HDMI connection.
- 2) Connect the provided A-to-B USB cable to the USB type B port labeled “TOUCH USB” on the front panel of the touch display and to the USB type A port on the external PC.
- NOTE:** This connection allows you to use touch control on the external PC to control the touch display.
- 3) Connect an audio cable from the “PC-AUDIO” port on the under panel of the touch display to the “Audio-Out” port on the external computer.
- 4) Depending on your choice in step 1 (above), set the VGA or the HDMI as your source (see “Accessing Total Touch Control” on page 22 and “The Source submenu” on page 23).

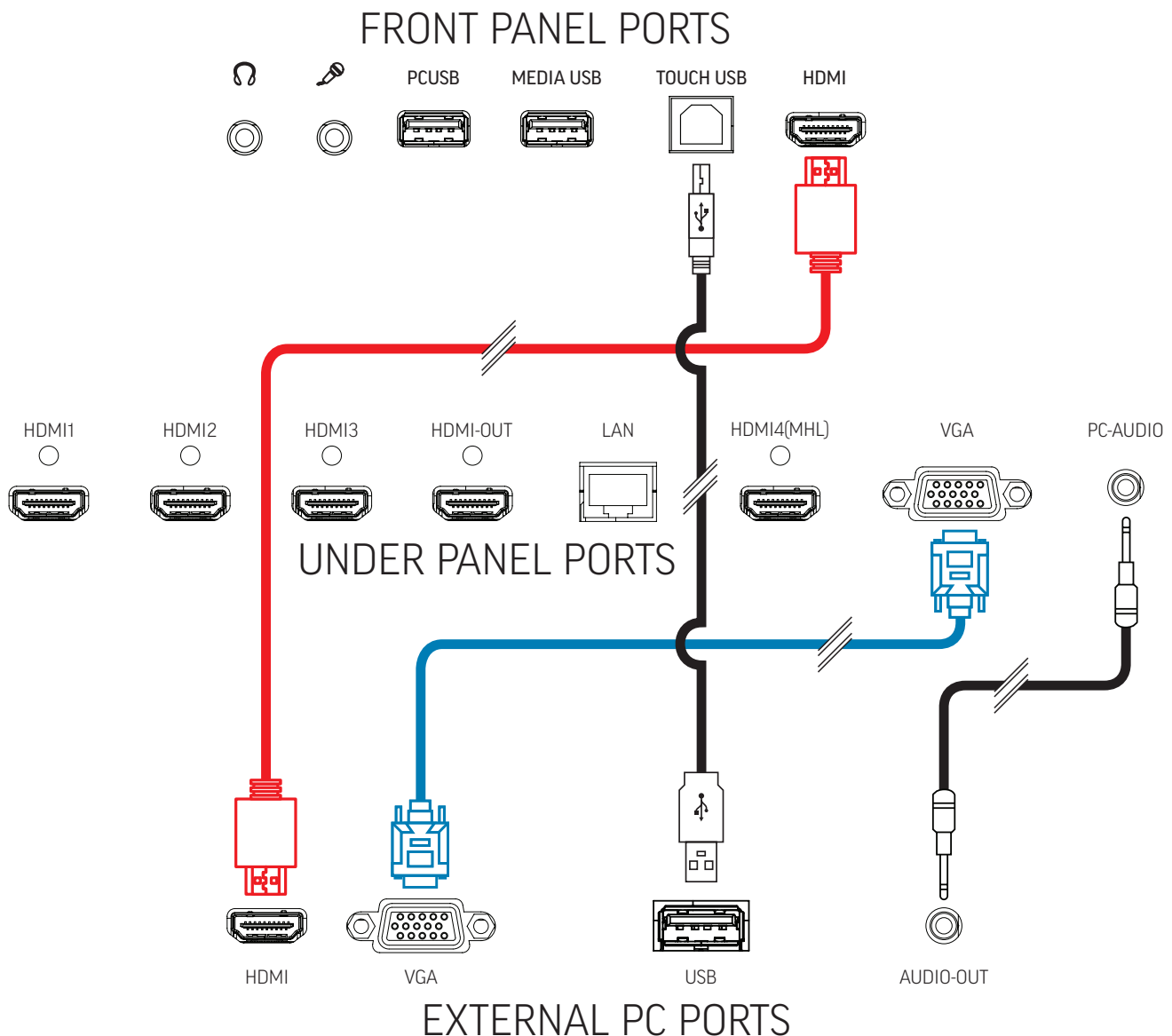

CONNECT THE INTERNAL ANDROID TO WI-FI

- 1) Connect the provided USB dongle to the **USB2.0** side panel port.
- 2) Tap the Total Touch Control menu tab on either side of the display (see “Accessing Total Touch Control” on page 22) and select **Advanced functions**. (See “The primary menu icons” on page 22). Select **Settings** from the submenu.
- 3) Choose **Network** and then **Wi-Fi**.
- 4) Tap **On/Off**, then select **On**.
- 5) Tap the Total Touch Control **Back** arrow (See “The primary menu icons” on page 22) to return to **Network**. Choose a network from the list and enter the password.

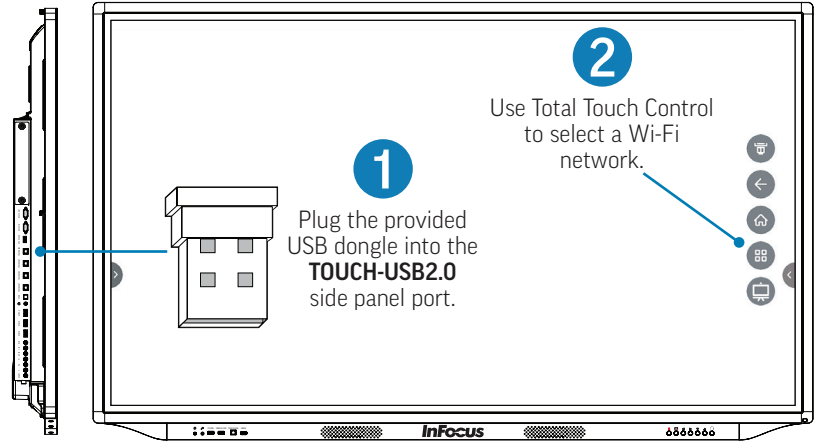

TOTAL TOUCH CONTROL™

With Total Touch Control (TTC), anything you want to do within an Android application can be accomplished by touching the screen. Use the touch-controlled menus to move through desired tasks, choose tools and manipulate the display.

NOTE: The remote control and the buttons on the lower right of the display are still active in TTC, and can also be used in navigation and selection.

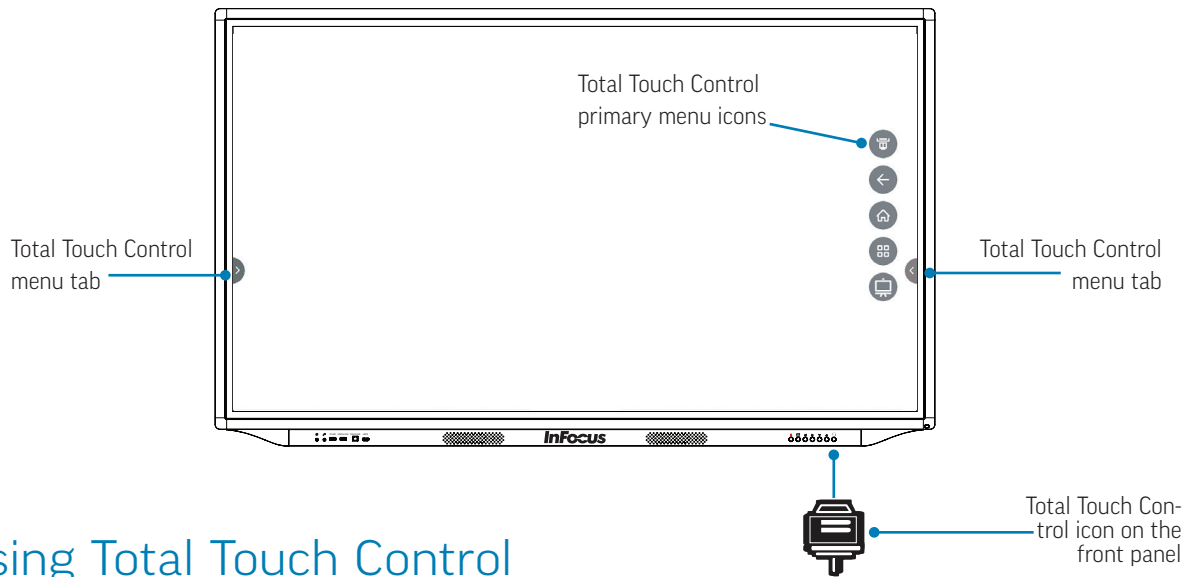

Accessing Total Touch Control

- 1) The Total Touch Control button on the front panel is an on-off toggle switch that enables or disables Total Touch Control.
- 2) Tap the Total Touch Control menu tab on either side of the touch display. The primary menu icons appear.
- 3) Tap the **Source** or **Advanced Functions** icons to display their submenus.







The primary menu icons

Icon	Name	Function
	Source	Displays a submenu of source (input) choices
	Back	Returns to the previous screen – back one level in an application or back one page in a browser
	Home	Displays the home screen
	Advanced functions	Access File, Settings, Volume, Screen Shot and Annotation tools
	Annotation	Allows you to draw (annotate) on any video input source screen. You can then take a screen shot of the annotation and current video image. Also allows you to annotate on any background, without affecting the original image

The Source submenu

A wide array of input devices can be accessed through the Source submenu, and their contents displayed on the touch display. The devices and their accompanying icons and source port locations are listed below.

To select any input device you have connected to the touch display, tap the Source icon and then tap any of the icons listed below (see "Accessing Total Touch Control" on page 22).

Icon	Name	Port Location	Description
	VGA (Video Graphics Array)	Under panel (page 15)	Connect a video media device
	AV composite video	Side panel (page 15)	Connect to a DVD
	Component video	Side panel (page 15)	Connect to component devices
	OPS (Open Pluggable Standard)	The optional PC module (page 19)	Connect to the optional PC module (Mondopad Ultra, Launch and Core/PC) on the back of the display
	HDMI (front) NOTE: This source selection has no number	Front panel (page 15)	Connect to an external PC NOTE: This HDMI port has no number.
	HDMI 1 through 4	Under panel (page 15)	Connect to an external PC

Selecting a source with the remote control

To select a source with the remote control...



- 1) Press **Source** on the remote. The Source icons appear at the bottom of the display
NOTE: The currently-selected source is highlighted in blue.
- 2) Navigate through the source options using the left and right directional arrows (< and >) on the remote and press **OK** to choose the appropriate source.

See the table below for a list of the Source icons with their names, port locations and descriptions.

NOTE: To choose the OPS PC module installed on the back of the display (not included with Mondopad Core or JTouch), select **OPS**.

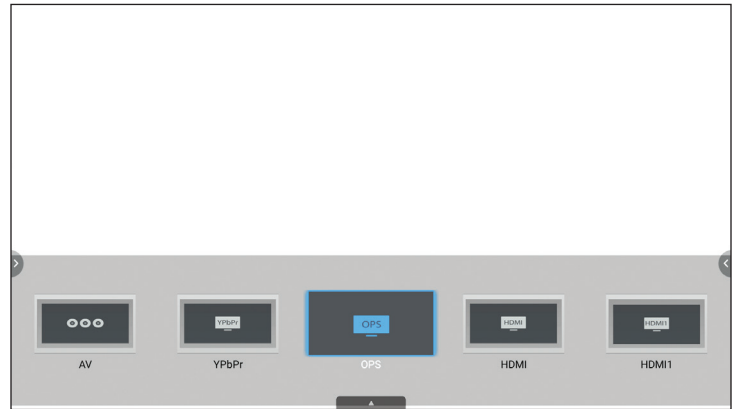

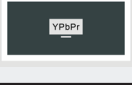
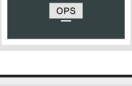

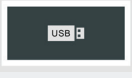
NOTE: To choose an external computer as your source, select the port to which the computer is connected.



Icon	Name	Port Location	Description
	AV Composite video	Side panel (page 15)	Connect to a DVD
	YPbPr (Component)	Side panel (page 15)	Connect to component devices
	OPS (Open Pluggable Standard)	The OPS PC module (page 19)	Connect to the OPS PC module (not included with Mondopad Core or JTouch) installed on the back of the touch display
	HDMI (front) NOTE: This source selection has no number	Front panel (page 15)	Connect to an external PC NOTE: This HDMI port has no number.
	HDMI 1 through 4	Under panel (page 15)	Connect to an external PC
	Media Browser	Front panel (page 15)	Media content

The Advanced Functions submenu

To select an advanced function, tap the Advanced Functions icon and then tap any of the icons listed below (see “Accessing Total Touch Control” on page 22).

Icon	Name	Function
	File (Image Upload)	Allows you to browse to select a file or image to view or upload to the touch display
	Settings	<p>Allows you to access these Android menus and submenus:</p> <ul style="list-style-type: none"> • Device <ul style="list-style-type: none"> • Network: WiFi, Ethernet, PPPoE NOTE: WiFi only works with a dongle. • System Sounds: Toggle on and off • App: Downloaded, System and Running Applications • Storage & Reset: Storage and Factory Reset • About: System information – model, Android version, software version • Preferences <ul style="list-style-type: none"> • Language: English (US) and Chinese • Keyboard: Configure-Auto Caps, Sound on Key Press, Voice Input Key, Text Correction, Show Correction • Personal <ul style="list-style-type: none"> • Security & Restrictions: Unknown Sources, Verify Apps, Restricted Profile, Device Administration • Date & Time: Auto, Manual Date and Time Adjustment
	Volume	Allows you to adjust the display speaker volume
	Screen Shot	Takes a screen shot of the display screen and saves it to internal memory (default), or to an attached USB thumb drive (formatted FAT32 USB drive), if one is inserted into the MEDIA USB port on the front panel (page 18).
	Freeze	Temporarily freezes the display image

THE ON-SCREEN DISPLAY SETTINGS

These settings allow you to adjust the picture, sound, and other settings to your personal preferences.

Accessing the On-Screen Display settings

NOTE: The display cannot be connected to an Android source to access the display settings.

- 1) Press the **Menu** button on the remote (page 13) or press the **Settings** button on the front panel (page 19). The first on-screen display menu appears.

NOTE: The remote control Menu button doesn't work from the Home screen or when the device is displaying an Android application.

- 2) There are three ways to select a menu:
 - Use the navigation buttons on the remote control, then press **OK** (page 13); or
 - Use the navigation buttons on the front panel (page 19); or
 - Swipe the scroll bar at the top of the Settings screen to scroll through the selections, then tap your choice.

Adjusting the picture

- 1) Navigate to the Picture Mode bar (See above). Tap the Picture Mode bar until the setting reads "User."

NOTE: It is necessary for "User" to be selected for adjustments to be made.

- 2) Choose a setting to adjust:
 - Contrast
 - Brightness
 - Sharpness
 - Saturation
 - PC Image Mode
 - Color Temperature
 - Zoom Mode
- 3) Use the navigation buttons on the remote control (page 13) to select a setting to adjust, then press **OK**. Or use the navigation buttons on the front panel (page 19) to select a setting, then tap it.
- 4) For Contrast, Brightness, Sharpness and Saturation, move the button on the sliding scale to increase or decrease the value. For PC Image Mode, Color Temperature and Zoom Mode, tap the bar to toggle through the choices. When the menu disappears, your choice is immediately effective.

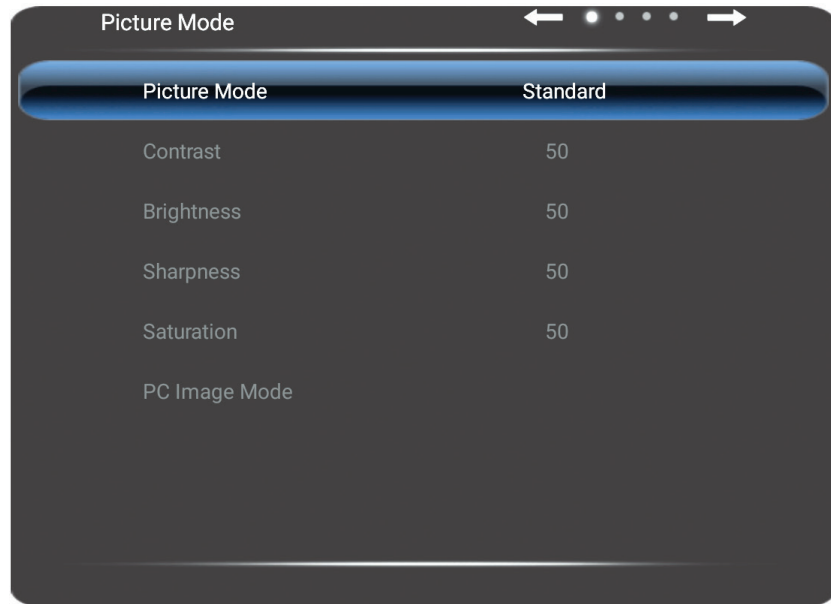

Picture Mode functions

Option	Function
Picture Mode	Controls which settings are accessible and the overall look of the display screen
User	Must be in this mode to adjust other settings; allows you to customize your display
PC	Predefined setting
Brightness	Predefined setting
Standard	Recommended general-purpose color scheme
Soft	Predefined setting
Contrast	Increases or decreases the contrast between light and dark values of the images on the display
Brightness	Increases or decreases the brightness of the images on the display
Sharpness	Increases or decreases the image clarity
Saturation	Increases or decreases the intensity of the colors of an image on the display
PC Image Mode	Adjusts the timing of an analog PC signal
Color Temperature	Adjusts the color temperature
Warm	7500K
Cold	13,000K
Nature	10,000K
Zoom Mode	Changes the size of the image projected onto the display: Default; 16:9; 4:3; Auto; Panorama Mode; Just Scan; 14:9; PC Mode

Adjusting the sound

1) Navigate to the Sound Mode bar (See “Accessing the On-Screen Display Settings” on page 26). Tap the Sound Mode bar until the setting reads “User.”

NOTE: It is necessary for “User” to be selected for adjustments to be made.

2) Choose a setting to adjust:

- Low Pitch
- High Pitch
- Balance
- SPDIF Output

3) Use the navigation buttons on the remote control (page 13) to select a setting to adjust, then press **OK**. Or use the navigation buttons on the front panel (page 19) to select a setting, then tap it.

4) For Low Pitch, High Pitch and Balance, move the button on the sliding scale to increase or decrease the value. For SPDIF Output, tap the bar to toggle to Raw or PCM. When the menu disappears, your choice is immediately effective.

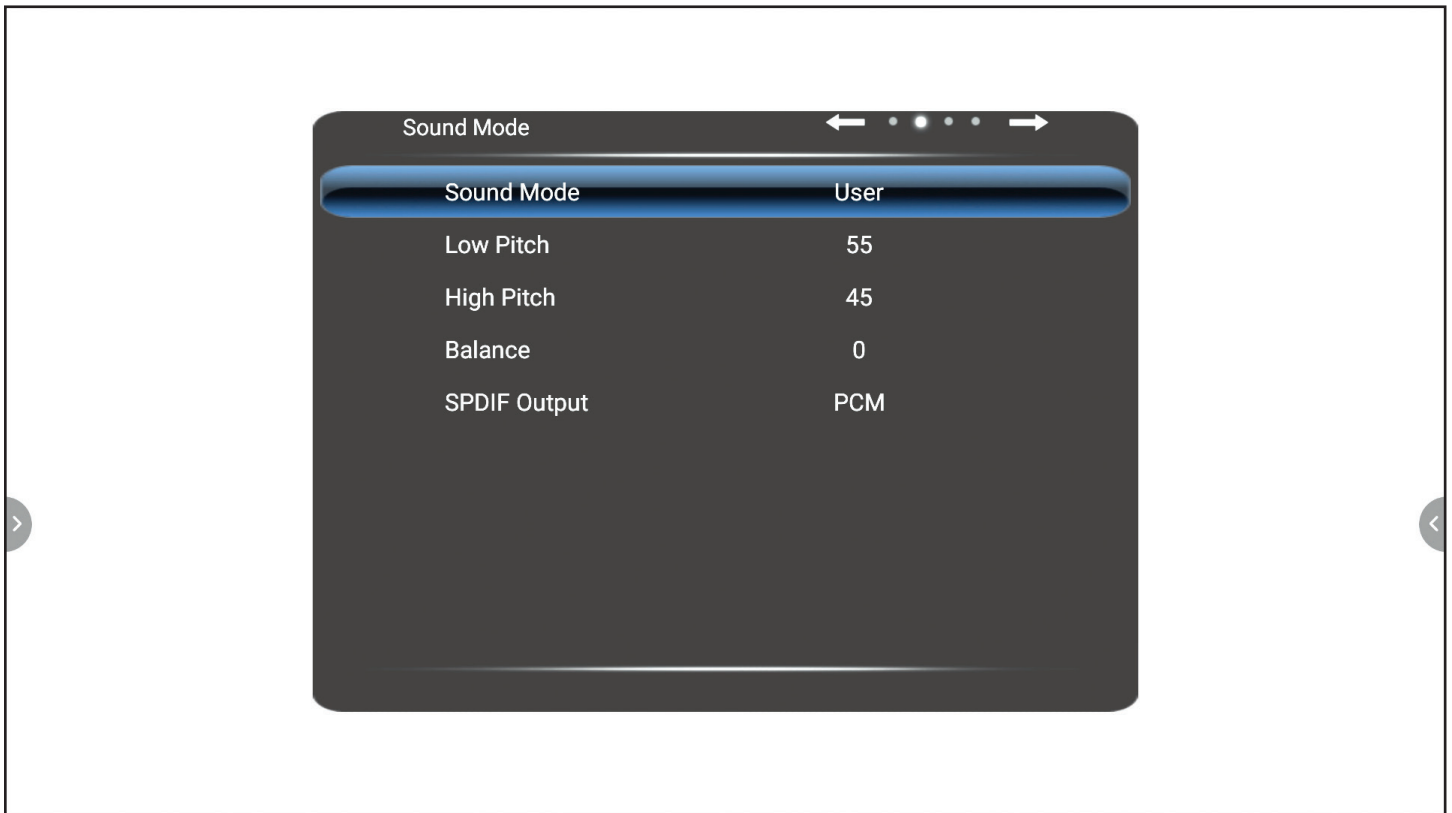

Sound Mode functions

Option	Function
Sound Mode	Controls which settings are accessible and optimizes sound settings for preset uses
Standard	Balances the sound range
Music	Optimizes sound for music listening
Movie	Optimizes sound for watching a movie
Sports	Optimizes sound for watching sports
User	Must be in this mode to access other settings

Option	Function
Low Pitch	Adjusts the bass level
High Pitch	Adjusts the treble level
Balance	Balances the sound between the right and left speakers
SPDIF Output	Compatibility mode for audio output to other connected devices. Allows you to choose the appropriate type of audio data for your device.
Raw	<p>Outputs raw audio data</p> <p>NOTE: Raw data is of a higher quality. Some sound systems cannot accept a raw data signal. If your system cannot decode the signal, you will hear nothing. In that instance, switch to PCM (below).</p>
PCM (Pulse Code Modulation)	<p>Outputs encoded audio data</p> <p>NOTE: The PCM audio signal is compatible with older or less expensive sound systems.</p>

Adjusting the settings

- 1) Navigate to the Settings Mode bar (See “Accessing the On-Screen Display Settings” on page 26).
- 2) Choose a setting to adjust:
 - Menu Time
 - MHL Auto Switch
 - Light Sensor
 - OPS Power Manager
 - HDMI CEC
 - HDMI EDID
 - Boot Source
 - Restore to Default
- 3) Use the navigation buttons on the remote control (page 13) to select a setting to adjust, then press **OK**. Or use the navigation buttons on the front panel (page 19) to select a setting, then tap it.
- 4) Repeatedly tap your selection to navigate through the choices. When the menu disappears, your choice is immediately effective.

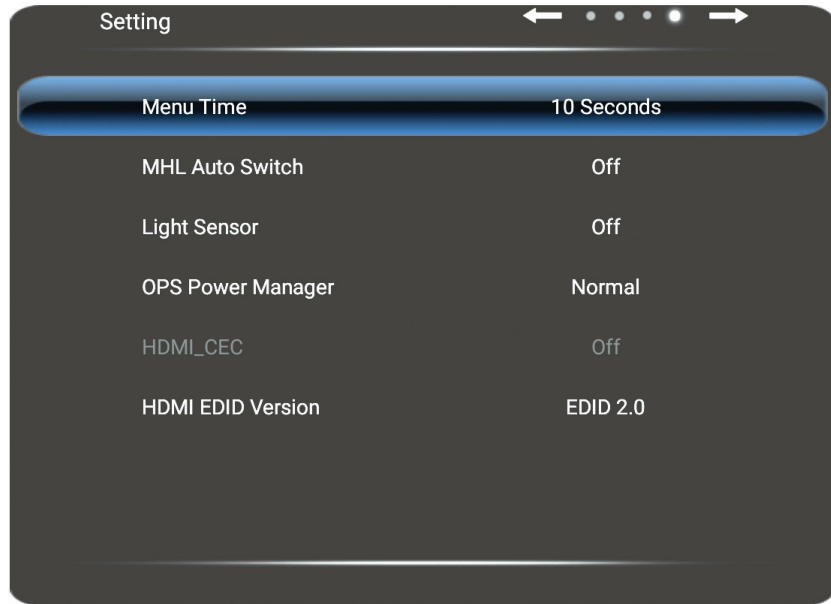

Settings Mode functions

Option	Function
Menu Time	Sets the length of time a menu displays before disappearing (five to 30 seconds)
MHL (Mobile High Definition Link)	Allows you to plug in your phone via its charging port and watch the phone screen in 1080 pixel definition NOTE: You must have the correct adapter and your phone must support MHL
Light Sensor	Toggles the light sensor on and off
OPS Power Manager	Toggles between Normal and OPS Always On
HDMI CEC (Consumer Electronics Control)	Allows the display remote to control other devices that are plugged into the HDMI port NOTE: The device must support CEC
HDMI EDID (Extended Display Identification Data)	Allows you to chose the version of HDMI that is compatible with your device. Supported HDMI versions are 1.4 and 2.0. NOTE: Only change this setting if a device has a compatibility issue.
Boot Source (default source)	Sets the default source when the display powers on. Choices include: Last Input; VGA; Android; AV; YPb; Pr; OPS (the optional PC module – Mondopad Ultra, Launch and Core/PC); HDMI; HDMI 1-4. NOTE: Choose Android to view the Home screen by default. NOTE: See page 23 for a description of source choices.
Restore to Default	Returns the settings mode to the factory preset



ANDROID SETTINGS



There are a wide variety of Android settings you can use to adjust the touch display to your personal preferences; they are accessible whenever the touch display is connected to an Android source.

Accessing the Android settings

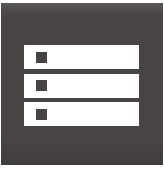

- 1) Tap the Total Touch Control menu tab (page 22) on either side of the display. The primary menu icons appear.
- 2) Tap the **Advanced Functions** icon.
- 3) Tap the **Settings** icon.

Device settings



Icon	Name	Function
	Network NOTE: The network connection can be wired or wireless, but not both.	<p>Wi-Fi (wireless)</p> <ul style="list-style-type: none"> Toggles Wi-Fi on and off Connects to available networks Gives status and information on networks: IP address; signal strength; etc. Offers you a chance to cancel networks from the touch display memory Offers other Wi-Fi options such as portable hotspots and adding networks <p>Ethernet (wired)</p> <ul style="list-style-type: none"> Connect and disconnect <p>PPPoE (wired)</p> <ul style="list-style-type: none"> Point-to-Point Protocol over Ethernet Offers ability to save a new account
	System Sounds	Toggles the sound system on and off
	Apps	<p>Downloaded Apps</p> <ul style="list-style-type: none"> Displays the applications which are currently loaded onto the system and can be used <p>System Apps</p> <ul style="list-style-type: none"> Displays the applications which are factory-installed <p>Running Apps</p> <ul style="list-style-type: none"> Displays the applications which are currently being used by the system

Icon	Name	Function
	Storage and Reset	<p>Storage</p> <p>Provides information on how much storage space is taken by applications, photos, etc. Also displays how much storage space is available</p> <p>Factory Data Request</p> <p>Resets the system default settings to the factory specifications</p>
	About	Displays system information: System update; device name; model; Android version; software version.

Preference settings

Icon	Name	Function
	Date & Time	<p>Auto Date & Time</p> <p>Automatically updates date and time through the internet</p> <p>Date</p> <p>Allows manual setting of the date in different formats</p> <p>Time</p> <p>Allows manual setting of the time in different time zones</p>
	Language	English or Chinese
	Keyboard	<p>Current Keyboard</p> <p>Displays the current Android keyboard layout</p> <p>Allows users to download a different Android on-screen keyboard layout</p> <p>Configure Keyboard</p> <p>Allows changes to an on-screen keyboard</p> <p>Settings: Auto caps; Sound on key press; Pop-up on key press; Voice input key; Text auto-correction; Show correction suggestions; Next word suggestions; Advanced settings</p> <p>Personal Dictionary</p> <p>Add words to the dictionary</p> <p>Checks spelling</p>

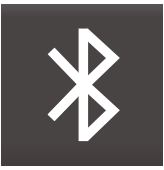
Personal settings

Icon	Name	Function
	Add Accessory	Allows you to connect to Bluetooth devices, if Bluetooth is accessible
	Security & Restrictions	<p>Unknown Sources</p> <p>An on-and-off toggle switch; allows/disallows applications to be installed from places other than trusted sources</p> <p>Verify Applications</p> <p>An on-and-off toggle switch</p> <p>Restricted Profile</p> <p>An on-and-off toggle switch; restricts/allows sources access to the touch display</p> <p>Device Administrators</p> <p>Administrative-level settings</p>

TROUBLESHOOTING

Symptom: The screen is black.

This is probably because the touch display has no power. Check the LED indicator on the lower right of the display. It should be green.

Solution:

Verify that...

- ...both ends of the power cord are connected.
- ...the system power switch is on.
- ...the outlet is supplying proper voltage – check the current with a volt meter.

Refer to: “Power source, power cord, plugs” (page 6); and “Connect the display to power” (page 11).

Symptom: There is no image on the display, but power is on to the system and to the display.

Solution:

Verify that...

- ...all associated cables, cords and connections are in good condition.
- ...a correct input source is selected and the input signal is compatible with the display.

Refer to: “The Source submenu” (page 23).

Symptom: “No Signal” is displayed.

Solution:

Verify that...

- ...the display is connected to a video source (input), and
- ...the correct video source is selected.

Refer to: “The Source submenu” on page 23.

Symptom: The display shuts down suddenly.

Solution:

Verify that...

- ...all associated cables, cords and connections are good;
- ...there are no objects blocking the vents.

Refer to: “The Source submenu” (page 23); and “Ventilation” (page 6).

Symptom: The display does not respond to touch gestures.

Solution:

Make sure that Total Touch Control is enabled: press the Total Touch Control button on the bottom front of the display.

If the display still does not respond to touch gestures, turn off the display. Wait a few seconds, then turn it back on.

Refer to: “The front panel buttons” (page 19); and “Turn the display on and off” (page 11).

Symptom: There is no touch control from a connected external PC.

Solution:

Check the connections.

Refer to: “Connect the display to an external PC” (page 20).

Symptoms: The colors aren't correct on the display.

Solution:

Adjust the color settings.

Reset the picture settings.

Refer to: “Accessing the On-Screen Display settings” (page 26) and “Picture Mode functions” (page 27).

If the colors still are not correct, verify that...

- ...all connections between the source and the display have been made correctly;
- ...all associated cables, cords and connections are in good condition;
- ...the correct input source is selected and the input signal is compatible with the display.

Refer to: “The Source submenu” on page 23.

Symptom: The remote control is not working properly.

Solution:

Verify that...

- ...the display is turned on. Check the LED indicator/sensor at the bottom right of the display. It should be green. If it is not, check to see that the power switch at the back of the display is on. If it is, aim the remote at the LED indicator/sensor and press the **Power** button.
- ...there are no obstructions in front of the LED indicator/sensor.
- ...the batteries in the remote are oriented correctly. If the remote is still not working, change the batteries.

Refer to: “Connect the display to power” (page 11); “Turn the display on and off” (page 11); and “Using the remote control” (page 12).

Symptom: Feedback noise is coming through the speakers.

Solution: Feedback through the display speakers can occur when infrared equipment (cordless headphones, etc.) is used near the display. Move any infrared communication equipment away from the display.

Symptom: There is no sound from externally-connected speakers.

Solution:

Verify that...

...the speakers are connected properly and the speaker power switch is turned on;

...the audio cable to external speakers is connected correctly;

...**Mute** is not selected on the remote, and **Volume** on the remote is turned up.

Refer to: “Connecting to other devices” (page 16); “The remote buttons” (page 13).

NOTE: An HDMI 1.3 or higher audio source and device is required for audio reproduction through the HDMI cable.

Symptom: There is no sound from the display internal speakers.

Solution:

Verify that...

- ...volume is turned up on the front of the display; and
- ...**Mute** is not selected on the remote, and **Volume** on the remote is turned up.

Refer to: “Adjust the volume” (page 12); “The remote buttons” (page 13).

Symptom: The on-screen display menus do not display.

Solution: The on-screen display menus cannot be selected from the Home screen. If that is not the case, verify that...

- ...a PC is connected correctly; and
- ...the correct source for the PC has been selected.

NOTE: It is necessary for “User” to be selected to adjust Picture Mode and Sound Mode.

Refer to: “Accessing the On-Screen Display settings” (page 26); “Adjusting the picture” (page 26); “Adjusting the sound” (page 28).

Symptom: The PC and the display do not recognize each other, i.e., a selected device does not communicate with the display.

Solution: Change the EDID setting.

Refer to: “Accessing the On-Screen Display settings” (page 26) and “Adjusting the settings” (page 29).

For additional troubleshooting support, please contact: InFocus technical support at 877-388-8385 (between 6:00 a.m. and 5:00 p.m. PST), or at infocus.com/support.

LIMITED WARRANTY

InFocus Limited Warranty For InFocus Branded Hardware Products Only

LIMITED WARRANTY. InFocus' warranty obligations for the hardware products are limited to the terms set forth herein. InFocus warrants the InFocus-branded hardware products against defects in materials and workmanship under normal use for a period outlined in the Limited Warranty Periods section below from the date of retail purchase by the original end-user purchaser ("Warranty Period"). The Warranty Period starts on the date of purchase. Your dated sales or delivery receipt, showing the date of purchase of the product, is your proof of the purchase date. You may be required to provide proof of purchase and proof that the product was purchased new as a condition of receiving warranty service. If a hardware defect arises and a valid claim is received within the Warranty Period, at its option and to the extent permitted by law, InFocus will either (1) repair the hardware defect at no charge, using new parts or refurbished parts that are equivalent to new in performance and reliability, (2) exchange the product with a product that is new or refurbished that is equivalent to new in performance and reliability and is at least functionally equivalent to the original product, or (3) refund the purchase price of the product. InFocus may request that you replace defective parts with customer-installable new or refurbished parts that InFocus provides in fulfillment of its warranty obligation ("Customer Self Repair"). A replacement product or part, including a Customer Self Repair part that has been installed in accordance with instructions provided by InFocus, assumes the remaining warranty of the original product or ninety (90) days from the date of replacement or repair, whichever provides longer coverage. When a product or part is exchanged, any replacement item becomes your property and the replaced item becomes InFocus's property. Parts provided by InFocus in fulfillment of its warranty obligation must be used in products for which warranty service is claimed. When a refund is given, the product for which the refund is provided must be returned to InFocus and becomes InFocus's property. This is your exclusive remedy for defective products. Limited Warranty Periods vary depending on your product model and the country of purchase. To review the warranty period associated with your product model, please refer to the product specifications information on www.infocus.com. By inputting your product model in the Quick Search box on the website, you will find warranty terms in the Specifications matrix.

EXCLUSIONS AND LIMITATIONS. This Limited Warranty applies only to the hardware products manufactured by or for InFocus, and sold by InFocus, its worldwide subsidiaries, authorized re-sellers or country distributors, that can be identified by the "InFocus" trademark, trade name, or logo affixed to it, and to required firmware. The Limited Warranty does not apply to any non-InFocus hardware products or peripherals external to the InFocus-branded hardware products (including but not limited to external storage subsystems, displays, printers, speakers or other peripherals), or to any software applications or programs, even if packaged or sold with the InFocus hardware. Manufacturers, suppliers, or publishers of products, software or peripherals, other than InFocus, may provide their own warranties to the end user purchaser, but InFocus, in so far as permitted by law, provides their products "AS IS" without the InFocus Limited Warranty. Software distributed by InFocus with or without the InFocus brand name (including, but not limited to system software) is not covered under this Limited Warranty. Refer to the licensing agreement accompanying the software for details of your rights with respect to its use. InFocus does not warrant that the operation of the products will be uninterrupted or error-free. InFocus is not responsible for damage arising from failure to follow instructions relating to the products' use.

INFOCUS IS NOT RESPONSIBLE FOR DAMAGE TO OR LOSS OF ANY PROGRAMS, DATA, OR REMOVABLE STORAGE MEDIA. INFOCUS IS NOT RESPONSIBLE FOR THE RESTORATION OR REINSTALLATION OF ANY PROGRAMS OR DATA OTHER THAN SOFTWARE INSTALLED BY INFOCUS WHEN THE PRODUCT IS MANUFACTURED.

To enable InFocus to provide the best possible support and service during the Limited Warranty Period, you will be required to:

- Maintain a proper and adequate environment, and use the InFocus hardware products in accordance with the instructions furnished.
- Verify configurations, load most recent firmware, install software patches, run InFocus diagnostics and utilities, and implement temporary procedures or work-arounds provided by InFocus while InFocus works on permanent solutions.
- Allow InFocus to keep resident on your systems or sites certain system and network diagnosis and maintenance tools to facilitate the performance of warranty support (collectively referred to as "Proprietary Service Tools"); Proprietary Service Tools are and remain the sole and exclusive property of InFocus.

Additional Limitations:

- Products external to the system processor (CPU) box, such as external storage subsystems, printers and other peripherals, are covered by the applicable warranty for those products or options.
- An effective repair does not necessarily require the replacement of a defective part. For example, cleaning the heads of a floppy drive or updating revision levels of ROM BIOS on a PCA board are activities that in many instances deliver an effective repair.
- BIOS/Firmware upgrades are not covered under the Limited Warranty. Firmware that is an integral part of the option hardware board is not automatically upgraded when new versions of firmware are released.
- It is the responsibility of the customer to ensure that their software is compatible with the latest BIOS/firmware revision.

This Limited Warranty does not apply: (a) to consumable or expendable parts, such as batteries, or protective coatings designed to diminish over time unless failure has occurred due to a defect in materials or workmanship; (b) to cartons, carrying cases, shipping cases, external cabinets, accessories used in connection with the product; (c) to cosmetic damage, including but not limited to scratches, dents, and broken plastic on ports; (d) to damage caused by use with non-InFocus products; (e) to damage caused by accident, abuse, misuse, improper ventilation, smoke exposure, contamination, improper or inadequate maintenance, cleaning or calibration, liquid contact, unusual physical or electrical stress and/or power surges, virus infection, fire, earthquake, disaster, lightning or other external causes; (f) to damage caused by operating the product outside the permitted or intended uses or usage parameters described by InFocus (including burned display screens and incorrect input voltage); (g) to damage caused by service (including upgrades and expansions) performed by anyone other than a representative of InFocus or an InFocus Authorized Service Provider ("ASP") or your own installation of customer-installable parts as instructed by InFocus; (h) to a product or part that has been modified to alter functionality or capability without the written permission of InFocus (including use of an unauthorized mount); (i) to defects caused by normal wear and tear or otherwise due to the normal aging of the product; (j) to failure to follow maintenance procedures as outlined in the product user documentation including where a schedule is specified for regular cleaning of certain parts (based on usage and environment); (k) to loss or damage in transit; or (l) if the product is not used under normal operating conditions which are defined as use not in excess of 16 hours continuously per day with a minimum 8 hour period of continuous rest in the powered off state; or (m) if any InFocus serial number has been removed or defaced. In addition, LCD burn-in as a result of excessive display of static images on the product is not covered under the terms of this Limited Warranty.

Important: Do not open the hardware products unless otherwise directed by InFocus for the purposes of a Customer Self Repair (CSR). Opening the hardware products may cause damage that is not covered by this Limited Warranty. Only InFocus or an ASP should perform service on the hardware products.

TO THE EXTENT PERMITTED BY LAW, THIS WARRANTY AND THE REMEDIES SET FORTH ABOVE ARE EXCLUSIVE AND IN LIEU OF ALL OTHER WARRANTIES, REMEDIES AND CONDITIONS, WHETHER ORAL, WRITTEN, STATUTORY, EXPRESS OR IMPLIED. AS PERMITTED BY APPLICABLE LAW, INFOCUS SPECIFICALLY DISCLAIMS ANY AND ALL STATUTORY OR IMPLIED WARRANTIES, INCLUDING, WITHOUT LIMITATION, WARRANTIES OF MERCHANTABILITY AND FITNESS FOR A PARTICULAR PURPOSE AND WARRANTIES AGAINST HIDDEN OR LATENT DEFECTS. IF INFOCUS CANNOT LAWFULLY DISCLAIM STATUTORY OR IMPLIED WARRANTIES THEN TO THE EXTENT PERMITTED BY LAW, ALL SUCH WARRANTIES SHALL BE LIMITED IN DURATION TO THE DURATION OF THE EXPRESS WARRANTY AND TO THE REPAIR OR REPLACEMENT SERVICE AS DETERMINED BY INFOCUS IN ITS SOLE DISCRETION. No InFocus reseller, agent, or employee is authorized to make any modification, extension, or addition to this warranty. If any term is held to be illegal or unenforceable, the legality or enforceability of the remaining terms shall not be affected or impaired.

EXCEPT AS PROVIDED IN THIS WARRANTY AND TO THE MAXIMUM EXTENT PERMITTED BY LAW, INFOCUS IS NOT RESPONSIBLE FOR DIRECT, SPECIAL, INCIDENTAL OR CONSEQUENTIAL DAMAGES RESULTING FROM ANY BREACH OF WARRANTY OR CONDITION, OR UNDER ANY OTHER LEGAL THEORY, INCLUDING BUT NOT LIMITED TO LOSS OF USE; LOSS OF REVENUE; LOSS OF ACTUAL OR ANTICIPATED PROFITS (INCLUDING LOSS OF PROFITS ON CONTRACTS); LOSS OF THE USE OF MONEY; LOSS OF ANTICIPATED SAVINGS; LOSS OF BUSINESS; LOSS OF OPPORTUNITY; LOSS OF GOODWILL; LOSS OF REPUTATION; LOSS OF, DAMAGE TO, COMPROMISE OR CORRUPTION OF DATA; OR ANY INDIRECT OR CONSEQUENTIAL LOSS OR DAMAGE HOWSOEVER CAUSED INCLUDING THE REPLACEMENT OF EQUIPMENT AND PROPERTY, ANY COSTS OF RECOVERING, PROGRAMMING OR REPRODUCING ANY PROGRAM OR DATA STORED IN OR USED WITH THE INFOCUS PRODUCT AND ANY FAILURE TO MAINTAIN THE CONFIDENTIALITY OF DATA STORED ON THE PRODUCT. THE FOREGOING LIMITATION SHALL NOT APPLY TO DEATH OR PERSONAL INJURY CLAIMS, OR ANY STATUTORY LIABILITY FOR INTENTIONAL AND GROSS NEGLIGENT ACTS AND/OR OMISSIONS. INFOCUS DISCLAIMS ANY REPRESENTATION THAT IT WILL BE ABLE TO REPAIR ANY PRODUCT UNDER THIS WARRANTY OR MAKE A PRODUCT EXCHANGE WITHOUT RISK TO OR LOSS OF PROGRAMS OR DATA.

Limitation on Bringing Action: No action, regardless of form, arising out of the agreement to purchase the Product may be brought by purchaser more than one year after the cause of action has accrued. Governing Law: Any action, regardless of form, arising out of the agreement to purchase the Product is governed by the laws of the State of Oregon, U.S.A. Mandatory Arbitration – Any action, regardless of form, arising out of the agreement to purchase the Product is subject to mandatory arbitration.

ADDITIONAL RIGHTS. FOR CUSTOMERS, WHO ARE COVERED BY CONSUMER PROTECTION LAWS OR REGULATIONS IN THEIR COUNTRY OF PURCHASE OR, IF DIFFERENT, THEIR COUNTRY OF RESIDENCE, THE BENEFITS CONFERRED BY THIS WARRANTY ARE IN ADDITION TO ALL RIGHTS AND REMEDIES PROVIDED BY SUCH CONSUMER PROTECTION LAWS AND REGULATIONS. THIS WARRANTY DOES NOT EXCLUDE, LIMIT OR SUSPEND ANY RIGHTS OF CONSUMERS ARISING OUT OF NONCONFORMITY WITH A SALES CONTRACT. SOME COUNTRIES, STATES AND PROVINCES DO NOT ALLOW THE EXCLUSION OR LIMITATION OF INCIDENTAL OR CONSEQUENTIAL DAMAGES OR ALLOW LIMITATIONS ON HOW LONG AN IMPLIED WARRANTY OR CONDITION MAY LAST, SO THE LIMITATIONS OR EXCLUSIONS DESCRIBED BELOW MAY NOT APPLY TO YOU. THIS WARRANTY GIVES YOU SPECIFIC LEGAL RIGHTS, AND YOU MAY ALSO HAVE OTHER RIGHTS THAT VARY BY COUNTRY, STATE OR PROVINCE. INFOCUS, THE WARRANTOR UNDER THIS LIMITED WARRANTY, IS IDENTIFIED AT THE END OF THIS DOCUMENT.

EXTENDED WARRANTIES. InFocus extended product warranties are available for an additional charge. For further information on InFocus extended product warranties, please contact InFocus or your product reseller.

OBTAINING WARRANTY SERVICE. Please access and review the online help resources located at www.infocus.com/support before seeking warranty service. If the product is still not functioning properly after making use of these resources, please contact InFocus Technical Support or, if applicable, an ASP using the information provided below. When contacting InFocus via telephone, other charges may apply depending on your location. When calling, InFocus Technical Support or an ASP will help determine whether your product requires service and, if it does, will inform you how InFocus will provide it. You must assist in diagnosing issues with your product and follow InFocus's warranty processes. InFocus may restrict service to the country where InFocus or its Authorized Distributors originally sold the hardware product. InFocus will provide warranty service either (i) at an ASP location, where service is performed at the location, or the ASP may send the product to an InFocus repair service location for service, (ii) by sending you prepaid way bills (and if you no longer have the original packaging, InFocus may send you packaging material at your cost) to enable you to ship the product to an InFocus repair service location, or (iii) by sending you customer-installable new or refurbished replacement parts to enable you to conduct Customer Self Repair, or (iv) by exchanging the product for a new or refurbished replacement.

Customer Self Repair InFocus products are designed with many Customer Self Repair (CSR) parts to minimize repair time and allow for greater flexibility in performing defective parts replacement. If during the diagnosis period, InFocus identifies that the repair can be accomplished by the use of a CSR part, InFocus will ship that part directly to you for replacement. There are two categories of CSR parts:

- Parts for which customer self repair is mandatory. If you request InFocus to replace these parts, you will be charged for the travel and labor costs of this service.
- Parts for which customer self repair is optional. These parts are also designed for customer self repair. If, however, you require that InFocus replace them for you, this may be done at no additional charge under the type of warranty service designated for your product. Based on availability and where geography permits, InFocus will attempt to ship CSR parts out the next business day. Customer receipt will vary based upon the actual part, customer location and shipping method. Next Day service may be offered at an additional charge where geography permits. If assistance is required, you can call the InFocus Technical Support Center and a technician will help you over the phone. InFocus specifies in the materials shipped with a replacement CSR part whether a defective part must be returned to InFocus. In cases where it is required to return the defective part to InFocus, you must ship the defective part back to InFocus within a defined period of time, normally five (5) business days, and clearly display the Return Material Authorization (RMA#) on the outside of the shipping carton or a similar package affording an equal degree of protection. The defective part must be returned with the associated documentation in the provided shipping material. Failure to return the defective part may result in InFocus charging you for the replacement. With a Customer Self Repair, InFocus will pay all shipping and part return costs and determine the courier/carrier to be used.

Upon receipt of the replacement product or part, the original product or part becomes the property of InFocus and you agree to follow instructions, including arranging the return of original product or part to InFocus in a timely manner. When providing a product exchange or Customer Self Repair (CSR) part requiring the return of the original product or part, InFocus may require a credit card authorization as security for the retail price of the replacement product or part and applicable shipping costs. When returning product to InFocus, a Return Material Authorization Number (RMA #) is required and must be clearly displayed on the outside of the shipping carton or a similar package affording an equal degree of protection. Service options, parts availability and response times may vary according to the country in which service is requested. Service options are subject to change at any time. You may be responsible for shipping and handling charges if the product cannot be serviced in the country in which service is requested. If you seek service in a country that is not the country of original purchase, you will comply with all applicable import and export laws and regulations and be responsible for all custom duties, V.A.T. and other associated taxes and charges. Where international service is available, InFocus may repair or exchange defective products and parts with comparable products and parts that comply with local standards. In accordance with applicable law, InFocus may require that you furnish proof of purchase details and/or comply with registration requirements before receiving warranty service. Resources with more details on this and other matters on obtaining warranty service are described below.

PRIVACY. InFocus will maintain and use customer information in accordance with the InFocus Privacy Policy available at www.infocus.com/privacy and InFocus's applicable legal obligations.

BACKUP. If your product is capable of storing software programs, data and other information, you should protect its contents against possible operational failures. Before you deliver your product for warranty service it is your responsibility to keep a separate backup copy of the contents, remove all personal information and data that you want to protect and disable any security passwords. **THE CONTENTS OF YOUR PRODUCT WILL BE DELETED AND THE STORAGE MEDIA REFORMATTED IN THE COURSE OF WARRANTY SERVICE.** Your product or a replacement product will be returned to you as your product was configured when originally purchased, subject to applicable updates. InFocus may install system software updates as part of warranty service that will prevent the hardware from reverting to an earlier version of the system software. Third party applications installed on the hardware may not be compatible or work with the hardware as a result of the system software update. You will be responsible for reinstalling all other software programs, data and passwords. Recovery and reinstallation of software programs and user data are not covered under this Limited Warranty.

RESOURCES. Support and service information including Authorized Distributor and Authorized Service Provider locations is available at: www.infocus.com/support.

InFocus Corporation, 13190 SW 68th Parkway, Suite 200, Portland, OR 97223-8368 USA

© 2016 InFocus Corp. All rights reserved. InFocus and the InFocus logo are trademarks of InFocus Corp., registered in the U.S. and other countries.

DECLARATION OF CONFORMITY

Manufacturer: InFocus Corporation, 13190 SW 68th Parkway, Suite 200, Portland, Oregon 97223-8368 USA

Trademarks

Apple, Mac and Facetime are trademarks or registered trademarks of Apple, Inc. Microsoft, Windows, PowerPoint, Excel and Word are trademarks or registered trademarks of Microsoft Corporation. Adobe and Acrobat are trademarks or registered trademarks of Adobe Systems Incorporated. HDMI logo and "High Definition Multimedia Interface" are registered trademarks of HDMI Licensing LLC. Manufactured under license from Dolby Laboratories. Dolby and the double-D symbol are trademarks of Dolby Laboratories. SRS TruSurround HD and SRS TruVolume are trademarks of SRS Labs, Inc. TruSurround HD and TruVolume technologies are incorporated under license from SRS Labs, Inc. InFocus, In Focus, INFOCUS (stylized), MondoCenter, Mondopad, BigTouch, JTouch, and ShareView are either registered trademarks or trademarks of InFocus Corporation in the United States and other countries. All other trademarks are the property of their respective owners. Any other trademarks, service marks, personal names or product names are assumed to be the property of their respective owners and are used only for reference. There is no implied sponsorship, affiliation, certification, approval or endorsement if we use one of these terms.

FCC Warning

This equipment has been tested and found to comply with the limits for a Class A digital device, pursuant to part 15 of the FCC Rules. These limits are designed to provide reasonable protection against harmful interference when the equipment is operated in a commercial environment. This equipment generates, uses and can radiate radio frequency energy and, if not installed and used in accordance with the instruction manual, may cause harmful interference to radio communications.

Operation of the equipment in a residential area is likely to cause harmful interference in which case the user will be required to correct the interference at his own expense. Changes or modifications not expressly approved by InFocus Corporation may void authority to operate the equipment.

This device complies with part 15 of the FCC Rules. Operation is subject to the following two conditions: (1) This device may not cause harmful interference and (2) this device must accept any interference received, including interference that may cause undesired operation.

The manufacturer is not responsible for any radio or TV interference caused by unauthorized modifications to this equipment. Such modifications could void the user's authority to operate the equipment.

Canada

This Class A digital apparatus complies with Canadian ICES-003.

Cet appareil numérique de la classe A est conforme à la norme NMB-003 du Canada.

Industry Canada Statement

"This device complies with Industry Canada license-exempt RSS standard(s). Operation is subject to the following two conditions: (1) this device may not cause interference, and (2) this device must accept any interference, including interference that may cause undesired operation of the device."

"Le présent appareil est conforme aux CNR d'Industrie Canada applicables aux appareils radio exempts de licence. L'exploitation est autorisée aux deux conditions suivantes : (1) l'appareil ne doit pas produire de brouillage, et (2) l'utilisateur de l'appareil doit accepter tout brouillage radioélectrique subi, même si le brouillage est susceptible d'en compromettre le fonctionnement."

Industry Canada, Products with Detachable Antennas

Under Industry Canada regulations, this radio transmitter may only operate using an antenna of a type and maximum (or lesser) gain approved for the transmitter by Industry Canada. To reduce potential radio interference to other users, the antenna type and its gain should be so chosen that the equivalent isotropically radiated power (e.i.r.p.) is not more than that necessary for successful communication.

Conformément à la réglementation d'Industrie Canada, le présent émetteur radio peut fonctionner avec une antenne d'un type et d'un gain maximal (ou inférieur) approuvé pour l'émetteur par Industrie Canada. Dans le but de réduire les risques de brouillage radioélectrique à l'intention des autres utilisateurs, il faut choisir le type d'antenne et son gain de sorte que la puissance isotrope rayonnée équivalente (p.i.r.e.) ne dépasse pas l'intensité nécessaire à l'établissement d'une communication satisfaisante.

This radio transmitter (identify the device by certification number, or model number if Category II) has been approved by Industry Canada to operate with the antenna types listed below with the maximum permissible gain and required antenna impedance for each antenna type indicated. Antenna types not included in this list, having a gain greater than the maximum gain indicated for that type, are strictly prohibited for use with this device.

Le présent émetteur radio (identifier le dispositif par son numéro de certification ou son numéro de modèle s'il fait partie du matériel de catégorie I) a été approuvé par Industrie Canada pour fonctionner avec les types d'antenne énumérés ci-dessous et ayant un gain admissible maximal et l'impédance requise pour chaque type d'antenne. Les types d'antenne non inclus dans cette liste, ou dont le gain est supérieur au gain maximal indiqué, sont strictement interdits pour l'exploitation de l'émetteur.

EU/EEC

Warning: This is a class A product. In a domestic environment this product may cause radio interference in which case the user may be required to take adequate measures.

Europe Wireless (WiFi)

This product operates at fundamental frequencies of 2.4 and 5 GHz. Each frequency outputs a maximum of 100 mW of power."

"Dieses Produkt arbeitet mit Basis Frequenzen von 2.4 und 5GHz. Jeder dieser Frequenzbereiche sendet mit einer maximal Leistung von 100 mW."

Agency Approvals

See product certification label. This document applies to regulatory model: D103, D104, D105, D106 Input ratings: AC 100-240V AC, 50-60Hz, D103 (5.0A), D104 (5.5A), D105 (3.0A), D106 (2.5A) InFocus reserves the right to alter product offerings and specifications at any time without notice