

InFocus

InFocus Corporation

Introduction Guide - DLP Multimedia Projector



Marketing Name:	Genesis		
Regulatory Models:	P130	P131	P132
Part-Numbers	IN112AA, IN113AA	IN112BB, IN113BB	
	IN114AA, IN115AA	IN114BB, IN115BB	IN114BBST, IN115BBST
	IN116AA, IN117AA	IN116BB, IN117BB	IN116BBST, IN117BBST
	IN118AA, IN118AA	IN118BB, IN118BB	IN118BBST, IN118BBST
	IN119AA, IN119AA	IN119BB, IN119BB	



Contents

Disclaimer	4
Trademarks	5
Safety information	7
Notes cautions and warnings.....	7
Information symbols and descriptions.....	8
Safety precautions.....	8
Safety symbols and descriptions	10
Using this document	13
Set up your InFocus	14
Turning the projector on / turning the projector off.....	16
Installing batteries in remote control.....	17
Placement and distance from the screen	19
Mounting modes.....	22
Using the projector on screen display (OSD)	23
Views of your InFocus	31
Front.....	31
Back	32
Left side.....	33
Right side	33
Bottom	34
Remote control	35
Projector parts and functions	37
Front P130, P131, P132 – 6 & 9 inputs/outputs.....	37
Back P130 – 6 inputs/outputs.....	38
Back P131, P132 –9 inputs/outputs	39
Bottom P130, P131, P132 – 6 & 9 inputs/outputs	40
Features comparison chart	41
Specifications overview	47
P130 – 6 inputs/outputs.....	47
P131 – 9 inputs/outputs	48
P132 – 9 inputs/outputs	49

Environmental conditions	50
Glossary of terms.....	51
Getting help and contacting InFocus.....	67
Self help resources.....	67
Contacting InFocus	70
Notices	72
Regional & country specific notices	72
RF interference (for USA only)	73
Manufacturer and EU importer in accordance with EU directives.....	74
Compliance statements for acoustic noise	74
FCC compliance statement	75
Restriction of use.....	76
Copyright notice	76
Copyright attribution.....	76
Mounting & Other Technical Information.....	77
RS232 Commands.....	76

Disclaimer

InFocus Corporation makes no representations or warranties with respect to this manual and, to the maximum extent permitted by law, expressly limits its liability for breach of any warranty that may be implied to the replacement of this manual with another. Furthermore, InFocus Corporation reserves the right to revise this publication at any time without incurring an obligation to notify any person of the revision.

The information provided in this documentation contains general descriptions and/or technical characteristics of the performance of the products contained herein. This documentation is not intended as a substitute for and is not to be used for determining suitability or reliability of these products for specific user applications. It is the duty of any such user or integrator to perform the appropriate and complete risk analysis, evaluation and testing of the products with respect to the relevant specific application or use thereof. Neither InFocus Corporation nor any of its affiliates or subsidiaries shall be responsible or liable for misuse of the information that is contained herein. If you have any suggestions for improvements or amendments or have found errors in this publication, please notify us.

All pertinent state, regional, and local safety regulations must be observed when installing and using this product. For reasons of safety and to help ensure compliance with documented system data, only the manufacturer shall perform repairs to components.

Failure to observe this information can result in injury or equipment damage.

Copyright © 2020 by InFocus Corporation

All rights reserved. No part of this publication may be reproduced, distributed, or transmitted in any form or by any means, including photocopying, recording, or other electronic or mechanical methods, without the prior written permission of the publisher. For permission requests, write to the publisher, addressed "Attention: Permissions Coordinator," at the address below.

InFocus Corporation
13190 Southwest, 68th Parkway, Suite 120,
Portland, OR 97223
United States
infocus.com

Trademarks

- ⑤ Apple, Mac, Mac OS, OS X, MacBook, and iMac are trademarks of Apple Inc. registered in the U.S. and other countries.
- ⑤ iOS is a trademark or registered trademark of Cisco in the U.S. and other countries and is used under license.
- ⑤ APP Store is a service mark of Apple Inc.
- ⑤ Microsoft, Windows, Windows Vista, Internet Explorer, .NET Framework and PowerPoint are either a registered trademark or trademark of Microsoft Corporation in the United States and/or other countries.
- ⑤ MicroSaver is a registered trademark of Kensington Computer Products Group, a division of ACCO Brands in the U.S. and other countries.
- ⑤ The terms HDMI® and HDMI High-Definition Multimedia Interface®, and the HDMI® Logo are trademarks or registered trademarks of HDMI Licensing Administrator, Inc. in the United States and other countries.



- ⑤ HDBaseT® is a trademark of HDBaseT® Alliance.



- ⑤ InFocus, InFocus LightCast, IN, LightPro are registered trademarks of InFocus Corporation.
- ⑤ Trademark PJLink® is a trademark applied for trademark rights in Japan, the United States of America and other countries and areas.
- ⑤ Wi-Fi®, Wi-Fi Alliance®, and Wi-Fi Protected Access (WPA, WPA2)® are registered trademarks of the Wi-Fi Alliance.
- ⑤ Blu-ray is a trademark of Blu-ray Disc Association.
- ⑤ CRESTRON and ROOMVIEW are registered trademarks of Crestron Electronics, Inc. in the United States and other countries.
- ⑤ Extron and XTP are registered trademarks of RGB Systems, Inc. in the United States.
- ⑤ Ethernet is either a registered trademark or trademark of Fuji Xerox Co., Ltd.
- ⑤ Android and Google Play are trademarks of Google Inc.
- ⑤ Other product names and logos mentioned in this guide may be the trademarks or registered trademarks of their respective holders.

Trademarks

GPL/LGPL Software Licenses

The product may include software licensed under GNU General Public License (GPL), GNU Lesser General Public License (LGPL), and others.



NOTES

1. The contents of this guide may not be reprinted in part or whole without permission.
2. The contents of this guide are subject to change without notice.
3. Great care has been taken in the preparation of this guide; however, should you notice any questionable points, errors or omissions, please contact us.
4. Notwithstanding article (3), InFocus will not be responsible for any claims on loss of profit or other matters deemed to result from using the Projector.

Various symbols are used throughout this guide and on the product to prevent physical harm to you or other people and damage to property. The symbols and their meanings are explained below.

Read and carefully follow the instructions that are marked with these symbols and labels to avoid injury to persons or damage to property.

Notes, cautions and warnings

-  **NOTE** | A NOTE indicates important information that provides assistance, guidance or information for better use of the product
-  **CAUTION** | A CAUTION indicates potential damage to hardware and informs you how to avoid the problem
-  **WARNING** | A WARNING indicates potential for property damage, personal injury or death

Information symbols and descriptions

These safety and operating instructions should be read before using the projector. After you have read all instructions, save this information for later reference. To prevent personal injury or damage to property, the following symbols are used to show dangerous operation or handling.

Make sure you understand them before setting up and using the projector

These symbols alert you to actions that must be performed.



Instructions



Disconnect the plug from the outlet

These symbols alert you to prohibited actions.



Do not do



Do not disassemble



Do not touch



Do not wet



Do not use in wet areas



Do not place on an unstable surface

Safety precautions



WARNING

Unplug the projector from the outlet and refer all repairs to qualified service personnel under the following conditions:

- ❶ If smoke, strange odors or strange noises come from the projector.
- ❷ If liquid such as water, or foreign objects such as metal, insects, paper etc get inside the projector.
- ❸ If the projector has been dropped or the housing has been damaged.

Continuing to use under these conditions may result in fire or electric shock.

Do not try to repair this projector yourself. Refer all repairs to qualified service personnel.

Place the projector near an outlet where the plug can be easily unplugged.



Never open any covers on the projector except as specifically explained in the Users Guide. Never attempt to disassemble or modify the projector (including consumables). Refer all repairs to qualified service personnel.

Electrical voltages inside the projector can cause severe injury.















If you are installing the projector on the ceiling, this projector should be installed by qualified technicians using only approved mounting equipment.

If installation work is not carried out correctly, the projector could fall down. This may result in injury or accidents. Contact your InFocus authorized dealer to carry out the installation work.





















If you use a ceiling mount do not apply adhesives to the mount to prevent the screws from loosening, or if you use lubricants or oils on the projector, the projector housing may crack and the projector may fall from its ceiling mount. This could cause serious injury to anyone under the mount and could damage the projector. When installing or adjusting a ceiling mount, do not use adhesives to prevent the screws from loosening and do not use oils or lubricants.



<p>Do not use the projector where it may be exposed to rain, water, or excessive humidity.</p>	
<p>Use the type of power source indicated on the projector. Use of a different power source may result in fire or electric shock. If you are not sure of the power available, consult your dealer or power company.</p>	
 WARNING	
<p>Check the specifications of the power cable. Using an inappropriate power cable could result in fire or electric shock. The power cable supplied with the projector is intended to comply with power supply requirements for the country of purchase. If you use the projector in the country where it was purchased, only use the power cable that came with the projector. If you use the projector in a country other than where it was purchased, use the correct power cable for that country.</p>	
<p>Take the following precautions when handling the plug. Failure to comply with these precautions could result in fire or electric shock.</p> <ul style="list-style-type: none"> Ⓜ Do not overload wall outlets, extension cables, or power strips. Ⓜ Do not insert the plug into a dusty outlet. Ⓜ Insert the plug firmly into the outlet. Ⓜ Do not hold the plug with wet hands. Ⓜ Do not pull the power cable when disconnecting the plug; always be sure to hold the plug when disconnecting it. 	
<p>Cables should be wired so that they cannot trip people up. Fire or electric shock may result.</p> <ul style="list-style-type: none"> Ⓜ Do not modify the power cable. Ⓜ Do not place heavy objects on top of the power cable. Ⓜ Do not bend, twist or pull the power cable excessively. Ⓜ Keep the power cable away from hot electrical appliances. Ⓜ Do not tie the power cable to other cables. <p>Contact your InFocus authorized dealer if the cable becomes damaged.</p>	
<p>Cables should be wired so that they cannot trip people up and so on. This could cause people to fall and be injured.</p>	
<p>Do not touch the plug during an electrical storm. Otherwise, you may receive an electric shock.</p>	
<p>Do not place any containers of liquid on top of the unit. Spilling liquid of any kind into the projector may result in fire or electric shock.</p>	
<p>Do not look into the lens when the projector is on. The bright light can damage your eyes. Also, do not look into the lens using optical devices such as telescopes or other magnifying equipment.</p>	
<p>Do not insert or drop metal, flammable, or foreign objects into the projector's vents or openings nor leave them nearby. Doing so may result in fire, electric shock, or burns.</p>	
<p>Do not leave the projector or the remote control with batteries inside a vehicle with the windows closed, in places where they will be exposed to direct sunlight, or in other places that may become extremely hot. Thermal deformation or technical malfunction may occur, which could result in fire.</p>	









Safety information

<p>Do not use sprays containing a flammable gas to remove dirt or dust which is adhering to parts such as the lens or filter of the projector. Because the inside of the projector becomes very hot during use, the gases may ignite and result in a fire.</p>	
<p>Do not use the projector in places where flammable gases or explosive gases may be present in the atmosphere. Because the inside of the projector becomes very hot during use, the gases may ignite and result in a fire.</p>	
<p>Do not place any objects that are easily flammable in front of the projector's lens, otherwise a fire may occur.</p>	
<p>During projection, do not block the light from the projector with the lens cover (where applicable) or a book. If the light from the projector is blocked, the area on which the light shines becomes hot which could cause it to melt, burn, or start a fire. Also, the lens may get hot due to the reflected light which could cause the projector to malfunction. To stop projection, use the A/V Mute function, or turn off the projector.</p>	
<p>Do not install the projector in a location that is not strong enough to bear its weight, or on an unstable surface such as a table that shakes or is tilted. The projector may fall down or tip over causing damage, deformation, or injury.</p>	
 CAUTION	
<p>Do not use the projector in places where there is a lot of humidity or dust, near cooking or heating appliances, or in places where it may come into contact with smoke or steam. Do not use or store this projector outdoors for an extended length of time. Fire or electric shock may result.</p>	
<p>Do not block the slots and opening in the projector case. They provide ventilation and prevent the projector from overheating. When installing the projector close to a wall, make sure there is a gap as specified in the Users Guide between the wall and the air exhaust vent. Do not place the projector in the following locations.</p> <ul style="list-style-type: none"> ❗ Badly ventilated or narrow places, such as inside a closet or in a book case. ❗ On soft surfaces such as a rug, bedding, blanket, and so on. ❗ Do not cover the projector with a blanket, curtain, or tablecloth. ❗ Badly ventilated locations such as inside an AV rack or cabinet. ❗ Locations subject to high temperatures, such as near heating equipment. ❗ Do not install the projector in an airtight location. ❗ If the projector needs to be installed in an airtight location, it is vital to ensure that air conditioning and ventilation equipment are also installed. <p>If the location is not sufficiently ventilated, heat exhausted from the projector will accumulate and could trigger the projector's built-in protection sensors causing the projector to shut down.</p>	
<p>Do not stand on the projector or place heavy objects on it. You may fall over resulting in injury or the projector may become damaged.</p>	

<p>Do not place anything that can become warped or damaged by heat near the exhaust vents. Do not bring your hands or face close to the vents while projection is in progress. Because of hot air coming out from the air exhaust vents, you could get burnt or it could be a cause of warping or other damage to property.</p>	
<p>Do not place the source of an open flame, such as a lit candle, on or near the projector</p>	
<p>Unplug the projector when it will not be used for extended periods. The insulation may deteriorate, which may result in fire.</p>	
<p>Be sure to check that the power is turned off, the plug is disconnected from the outlet and all cables are disconnected before moving the projector. Fire or electric shock may result.</p>	
<p>Unplug the projector from the outlet before cleaning. This avoids electric shock during cleaning.</p>	
<p>Use a dry cloth (or, for stubborn dirt or stains, a moist cloth that has been rung dry) for cleaning. Do not use liquid, aerosol cleaners, or solvents such as alcohol, thinner or benzine. Water infiltration or deterioration and breakage of the projector housing could result in electric shock.</p>	
<p>Incorrect battery usage may cause leakage of battery fluid and battery rupture, which could result in fire, injury or corrosion of the projector. When replacing batteries, take the following precautions.</p> <ul style="list-style-type: none"> ⑤ Insert batteries so that the polarities (+ and -) are correct. ⑤ Do not use batteries of different types or mix old and new batteries. ⑤ Do not use any batteries other than those specified in the Users Guide. ⑤ If the batteries leak, wipe away battery fluid with a soft cloth. If fluid gets on your hands or in your eyes, wash and rinse immediately. ⑤ Replace the batteries as soon as they run out. ⑤ Remove the batteries if you will not be using the projector for a long period of time. ⑤ Do not expose batteries to heat or flame and do not put them in water. ⑤ Dispose of used batteries according to local regulations. ⑤ Keep these batteries out of the reach of children. ⑤ Batteries are a choking hazard and are very dangerous if swallowed. 	
<p>Do not start the projector while the volume is too high. (only models with built-in speaker) Loud sounds may cause loss of hearing. Always lower the volume before turning off the projector. Gradually increase the volume after turning on the projector.</p>	
<p>Avoid standing in front of the projector so you do not block the projected images and the bright light does not shine in your eyes. Looking into the projector's light can damage your eyesight.</p>	

Safety symbols and descriptions

The following table lists the meaning of the safety symbols labeled on the projector, remote control, power cord and cables.

No.	Symbol Mark	Standard / Description
1		IEC 60417 - Symbol No: 5009 Stand-by - to identify the button to place the device in to Stand-by condition
2		IEC 60417 - Symbol No: 5002 Positioning of Cell and identification of battery holder
3		IEC 62471-5:2005 As with any bright source, do not stare into the direct beam, RG2 IEC 62471-5:2015
4		IEC 60417 - Symbol No. 5017 Earth To identify an earth (ground) terminal in cases where neither the symbol 5019 is explicitly required.
5		IEC 60417 - Symbol No. 5019 Protected Earth To identify any terminal which is intended for connection to an external conductor for protection against electric shock in case of a fault, or the terminal of a protective earth (ground) electrode.
6		ISO 7000 - Symbol 0434B IEC 3864-B3.1 Caution To identify general caution when using the product
7		IEC 60417 Caution Hot Surface To indicate that the marked item can be hot and should not be touched without taking care.
8		IEC 60417 Symbol No. 6042 ISO 3864-B3.1 Caution Risk of Electric Shock To identify equipment that has risk of electric shock.

Using the set up & specification document to search for information

This users guide allows you to search for information by keyword or to jump to specific sections using the bookmarks. You can also print specific pages as needed.

This section explains how to use a PDF document that has been opened in Adobe Acrobat Reader DC on your computer running Windows or Mac OS operating system.

Searching by keyword

Click Edit > Advanced Search. Enter the keyword text for the information you want to find in the search window, then click search. Hits are displayed as a list, select and click one of the displayed hits to jump to that page.

Jumping directly from bookmarks

Click a title to jump to that page. Click + or > to view the lower level titles in the section. To return to the previous page or section:

Windows: Hold down Alt and then press

Mac OS: Hold down the command key and then press

Printing only the page or pages you need

You can extract and print only the pages you need. Click Print in the File menu and then specify the page or pages you wish to print.

Windows & Mac OS: Specify the page or pages you wish to print in Pages in Pages to Print.

To specify a series of pages, enter a hyphen between the start page and the end page.

To specify pages that are not in a series, enter a comma after each page number.

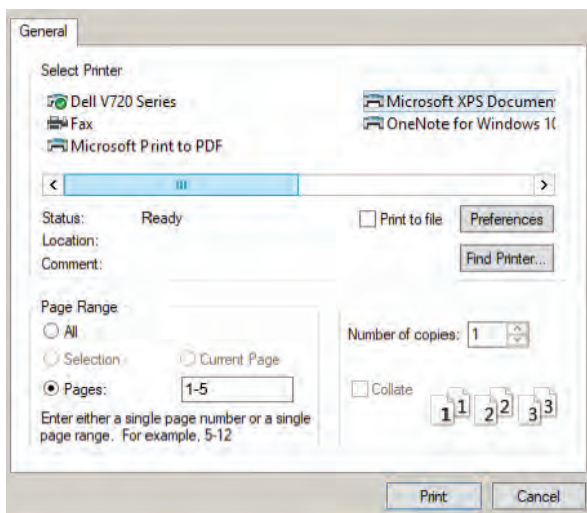

Getting the latest version of documents

You can get the latest version of this users guide as well as other product information and literature by visiting the InFocus website.

Visit infocus.com, and enter your projector model number in the search box.

Set up your InFocus

Turning the projector on / turning the projector off

Turning on your InFocus projector

1. Securely connect the power cord to the projector and to the mains outlet. When connected, the On/Standby LED will turn red.
2. Connect your signal/source cable to you source device and the projector.
3. Turn on the projector by pressing the  either on the projector keypad or the remote control.

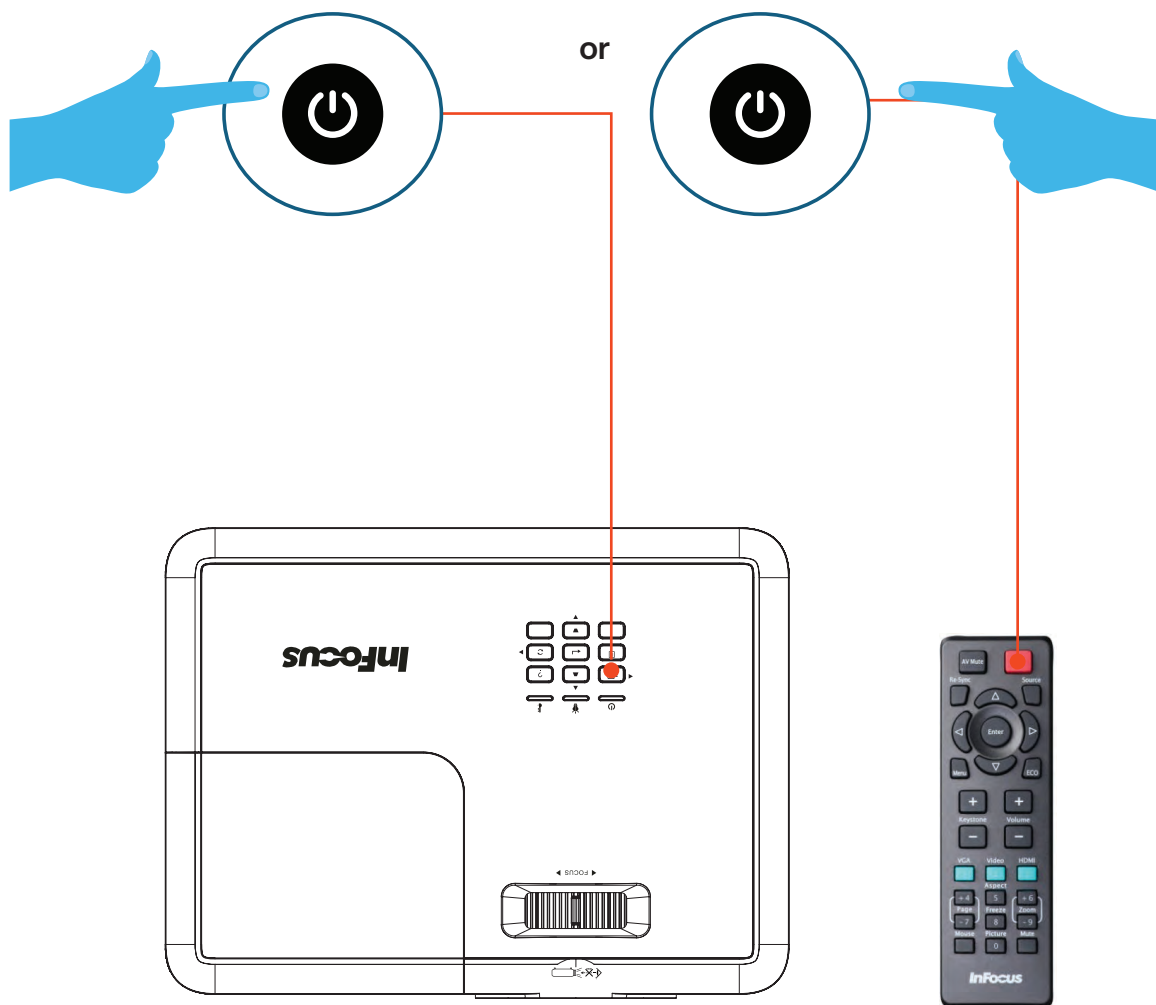

NOTE The power cable that is supplied with this projector conforms to electrical safety regulations. Do not use a power cable other than the one supplied with the projector. If using the projector overseas, check the power supply voltage, outlet shape and electrical rating of the projector that conform to the local standards, and purchase a proper power cable in the country.

i NOTE

The following conditions must be observed regardless of the country of use.

- The power cable must have the approval marks from the standards authority of the country where the projector is to be used.
- The plug must be of the same shape as the outlets in the country of use.

Examples of standards authorities or certification marks are detailed below

Country name	Standards authority or certification mark
United States of America	UL
Canada	CSA
United Kingdom	BSI
Italy	IMQ
Australia	SAA
Austria	OVE
Switzerland	SEV
Sweden	SEMKO
Denmark	DEMKO
Germany	VDE

Country name	Standards authority or certification mark
Norway	NEMKO
Finland	FIMKO
France	LCIE
Netherlands	KEMA
Belgium	CEBEC
Japan	PSE
Korea	EK
China	CCC
Singapore	PSB

4. The InFocus start up screen (see below) will be display after approximately 10 seconds and the On/Stand-by LED will be flashing blue and then steady blue.



i NOTE





The size and clarity of the InFocus logo on the startup screen will depend on the resolution of the projector you have purchased, this is expected and normal behavior.

i NOTE

The first time the projector is turned on, you will be prompted to select the preferred language and projection orientation

Set up your InFocus

Turning off your InFocus projector

1. Turn off the projector by pressing the  either on the projector keypad or the remote control.
2. The following message will be displayed: Power Off? Press  power key again to confirm turning off your projector.
3. If the  is not pressed a second time, the message will disappear after 10 seconds and the projector will not be turned off. When you press the  button for the second time, the projector will turn off.
4. The cooling fans will continue to operate for about 10 seconds for the cooling cycle and the On/Standby LED will flash blue. When the On/Standby LED turns solid red, this indicates the projector has entered standby mode. If you wish to turn the projector back on, you must wait until the cooling cycle has finished and the projector has entered standby mode. When the projector is in standby mode, simply press the  button again to turn on the projector.
5. Disconnect the power cord from the electrical outlet and the projector.

NOTE Cool down time for the IN118AA and IN188BB is 120 seconds

NOTE There is a direct correlation between the number of on/off cycles of the projector, proper cooling of the lamp and expected lamp life. Always allow the projector fan to turn off after you power down and before you unplug the projector power cord from the electrical outlet

Keypad

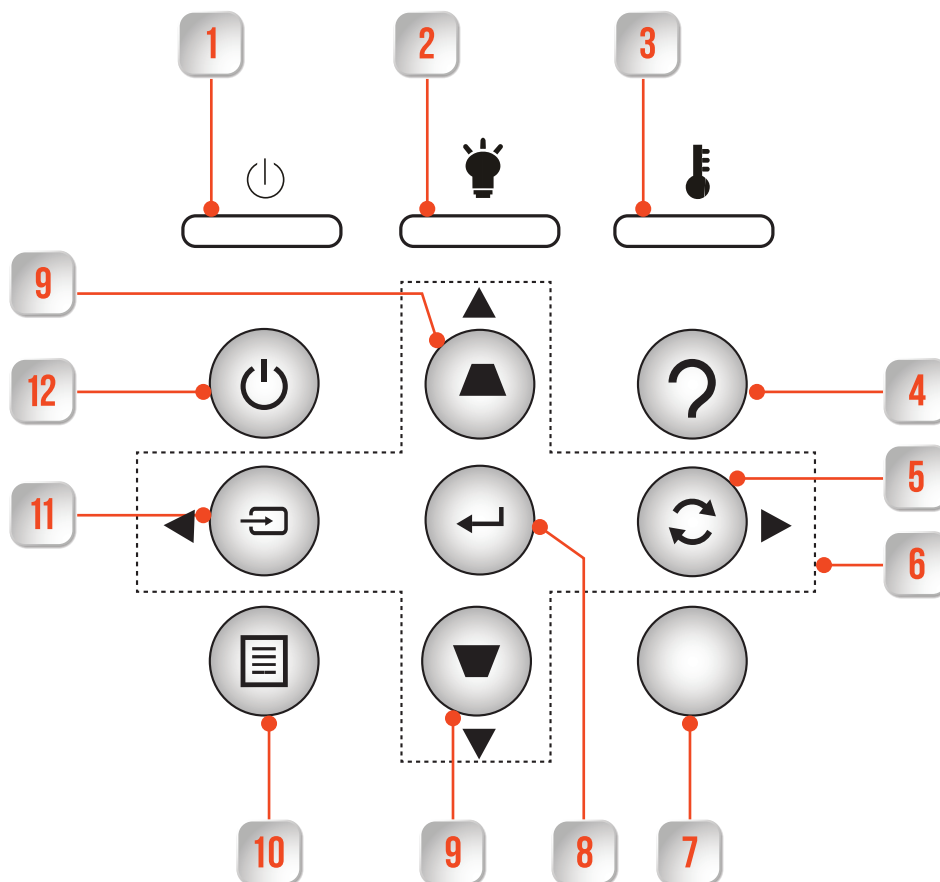

No.	Item
1.	On/Standby LED
2.	Lamp LED
3.	Temp LED
4.	Help

No.	Item
5.	Re-Sync
6.	Four Directional Select Keys
7.	IR Receiver
8.	Enter

No.	Item
9.	Keystone Correction
10.	Menu
11.	Source
12.	Power

Installing batteries in remote control

Installing / replacing the batteries

i NOTE | Batteries are not supplied with any InFocus projector. Please purchase two AAA batteries for use in the remote control of this projector.

1. Remove the battery cover on the back of the remote control.

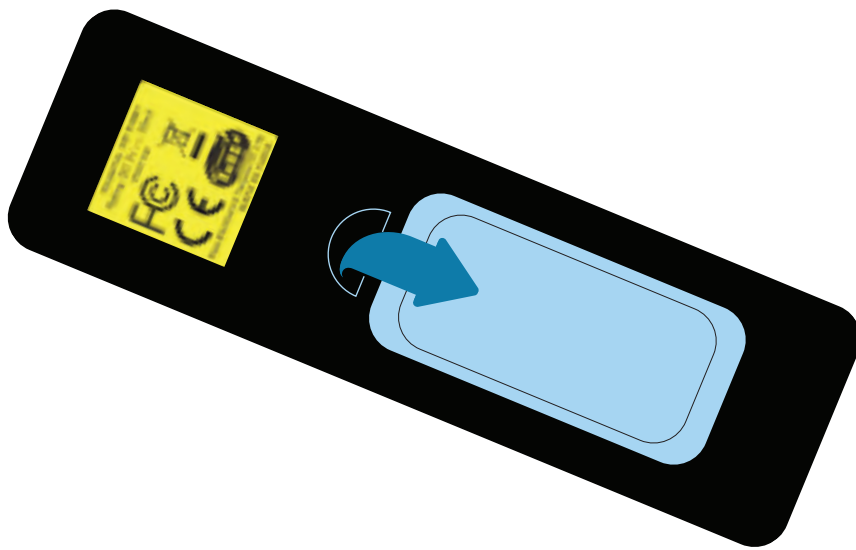

2. Insert AAA batteries in the battery compartment as illustrated.

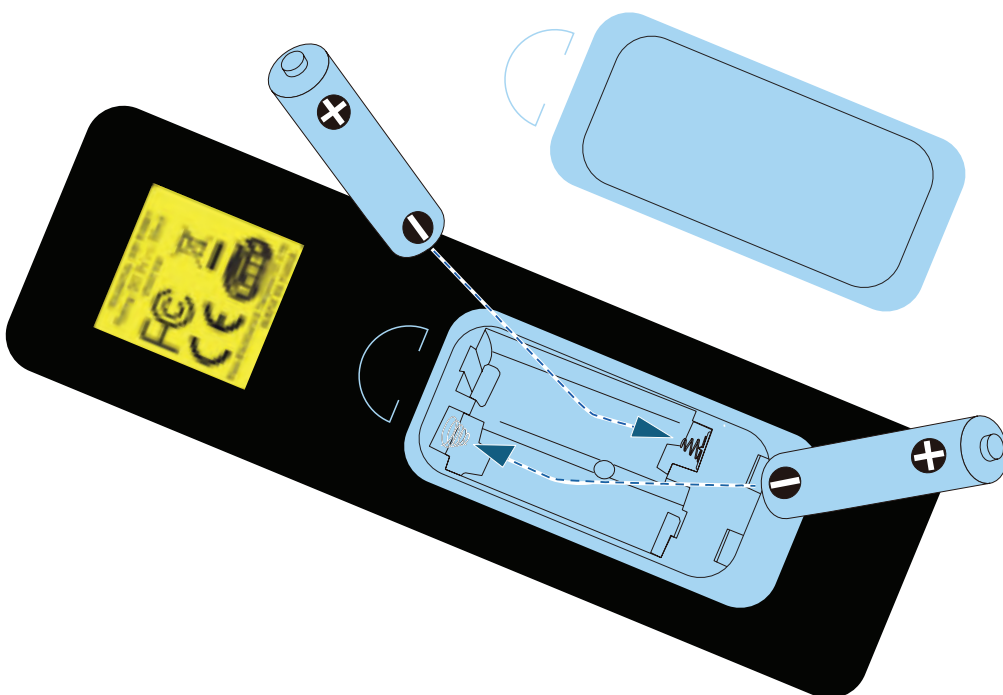

Set up your InFocus

3. Replace back cover on remote control, press down until it clicks in to place.

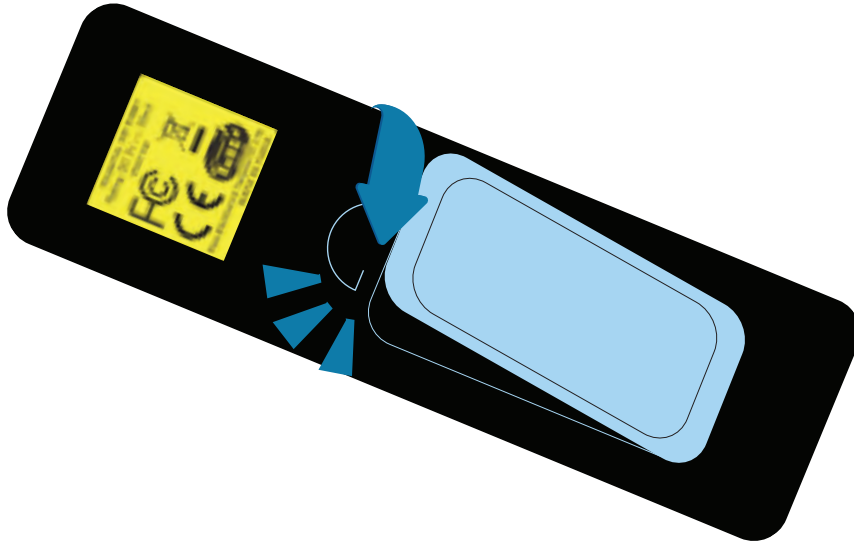

NOTE | Replace only with the same or equivalent type batteries.

CAUTION | Incorrect battery usage may cause leakage of battery fluid and battery rupture, which could result in fire, injury or corrosion of the projector. When replacing batteries, take the following precautions.

- ⑤ Insert batteries so that the polarities (+ and -) are correct.
- ⑤ Do not use batteries of different types or mix old and new batteries.
- ⑤ Do not use any batteries other than those specified.
- ⑤ If the batteries leak, wipe away battery fluid with a soft cloth. If fluid gets on your hands or in your eyes, wash and rinse immediately.
- ⑤ Replace the batteries as soon as they run out.
- ⑤ Remove the batteries if you will not be using the projector for a long period of time.
- ⑤ Do not expose batteries to heat or flame and do not put them in water.
- ⑤ Dispose of used batteries according to local regulations.
- ⑤ Keep batteries out of the reach of children. Batteries are choking hazards and are very dangerous if swallowed

Placement and distance from the screen

The projector can be placed on most flat surfaces to project and image. You can also install the projector in a ceiling mount if you wish to use it in a fixed location. An optional ceiling mount is required when suspending the projector from the ceiling.

Note the following points when selecting a location for your InFocus projector:

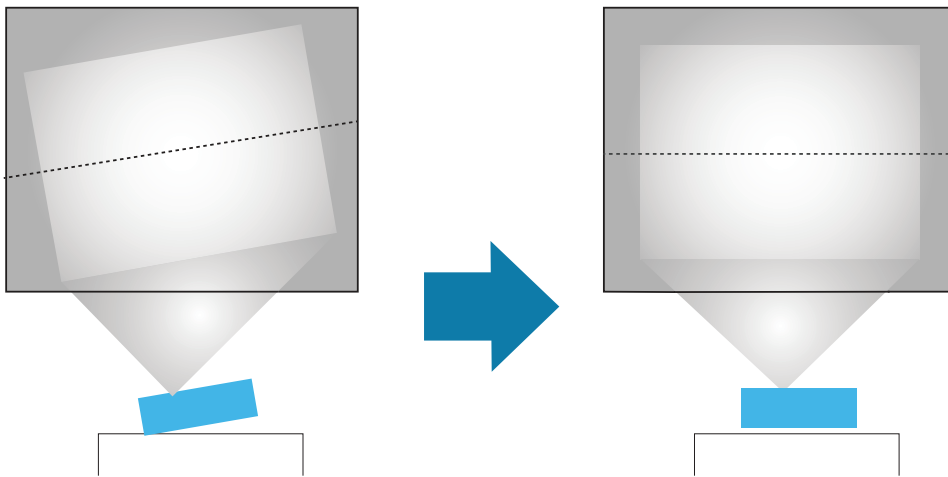

- 5 Place the projector on a sturdy, level surface or install it using a compatible mount.
- 5 Leave plenty of room around and under the projector for ventilation and do not place it next to or on top of anything that could block the vents.
- 5 Place the projector so that it squarely faces the screen and not at an angle.

i NOTE If you cannot install the projector squarely facing the screen, correct any resulting keystone distortion using the projector controls. For the best quality images, we recommend adjusting the installation position of the projector to achieve the correct image size and shape.

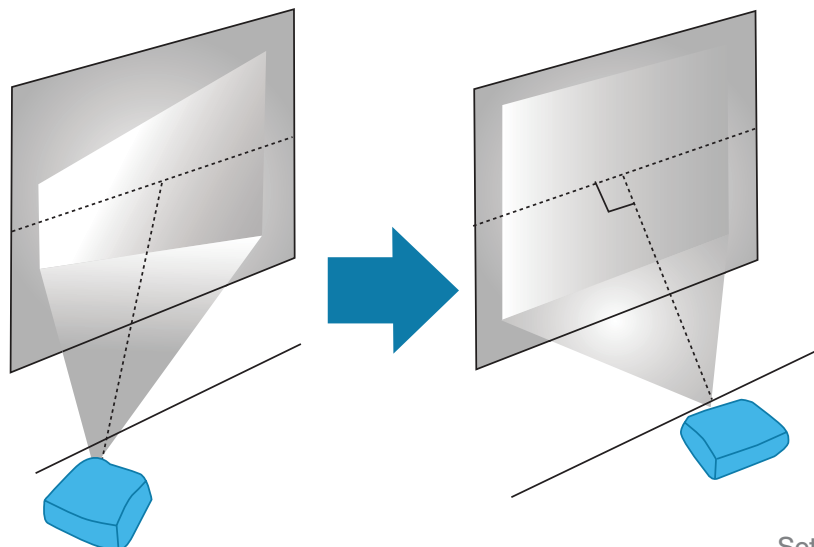

Set up your InFocus

Projection Distance

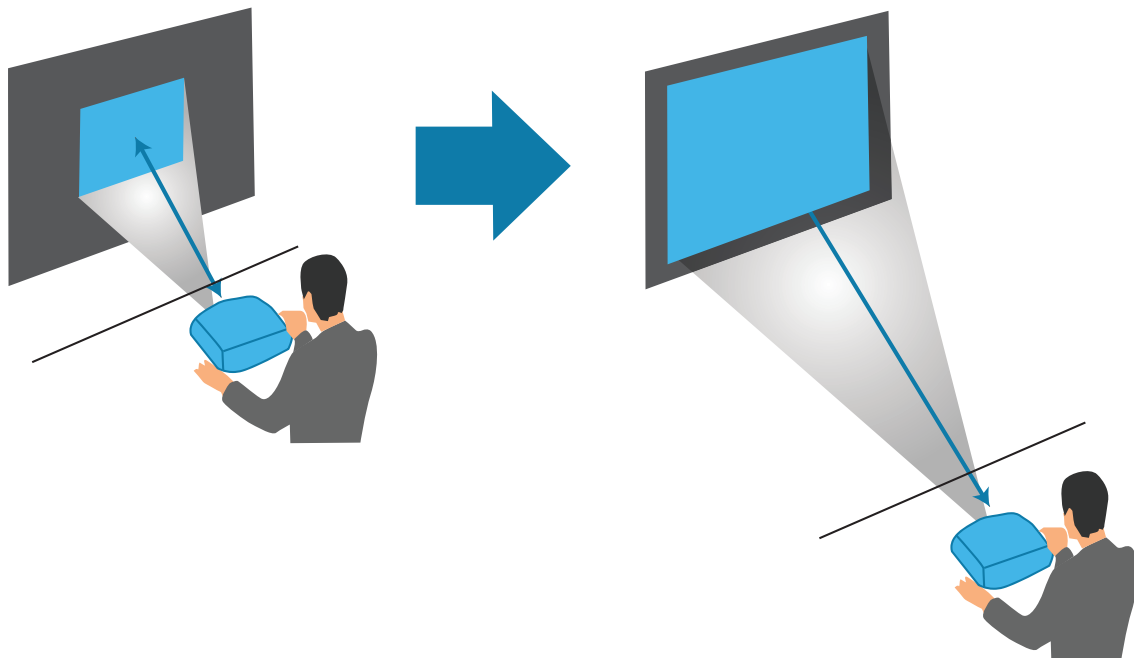

Projection distance

The distance at which you place the projector from the screen determines the approximate size of the image. The image size increases the farther the projector is from screen, but can vary depending on the zoom factor, aspect ratio, and other settings.

See the detailed Users Guide for projection distance and image size tables. The Users Guide can be found at infocus.com

NOTE | When using keystone correction your resulting image is slightly smaller.

WARNING | If you are installing the projector on the ceiling, this projector should be installed by qualified technicians using only approved mounting equipment. If installation work is not carried out correctly, the projector could fall down. This may result in injury or accidents. Contact your InFocus authorized dealer to carry out the installation work.

If you use a ceiling mount do not apply adhesives to the mount to prevent the screws from loosening, or if you use lubricants or oils on the projector, the projector housing may crack and the projector may fall from its ceiling mount. This could cause serious injury to anyone under the mount and could damage the projector. When installing or adjusting a ceiling mount, do not use adhesives to prevent the screws from loosening and do not use oils or lubricants.

 **CAUTION** | Do not block the slots and openings in the projector case.

- ⑤ They provide ventilation and prevent the projector from overheating.
- ⑤ When installing the projector close to a wall, make sure there is a gap as specified in the Users Guide between the wall and the air exhaust vent.

Do not place the projector in the following locations.

- ⑤ Badly ventilated or narrow places, such as inside a closet or in a book case.
- ⑤ On soft surfaces such as a rug, bedding, blanket, and so on.
- ⑤ Do not cover the projector with a blanket, curtain, or tablecloth.
- ⑤ Badly ventilated locations such as inside an AV rack or cabinet.
- ⑤ Locations subject to high temperatures, such as near heating equipment.
- ⑤ Do not install the projector in an airtight location.

If the projector needs to be installed in an airtight location, it is vital to ensure that air conditioning and ventilation equipment are also installed.

If the location is not sufficiently ventilated, heat exhausted from the projector will accumulate and could trigger the projector's built-in protection sensors causing the projector to shut down.

Set up your InFocus

Mounting modes

Your InFocus projector can be set up and installed in any of the following ways:

Front/Rear

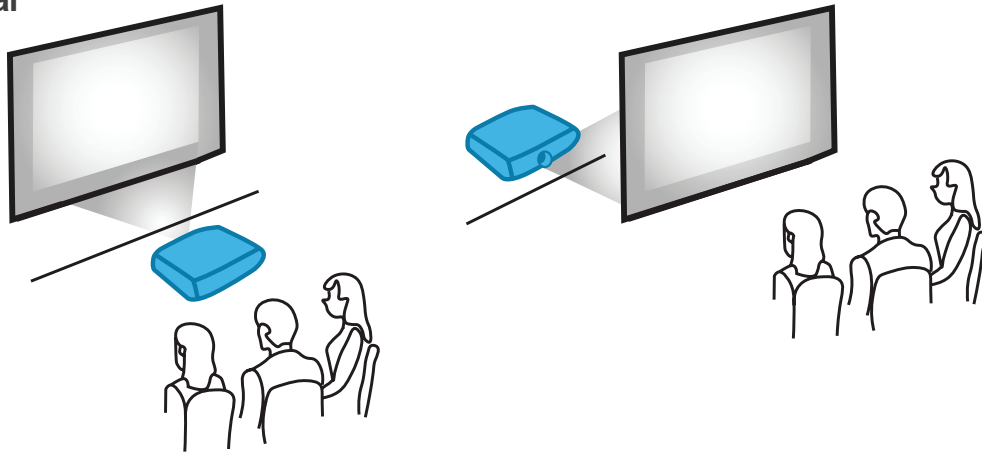

Front Ceiling/Rear Ceiling

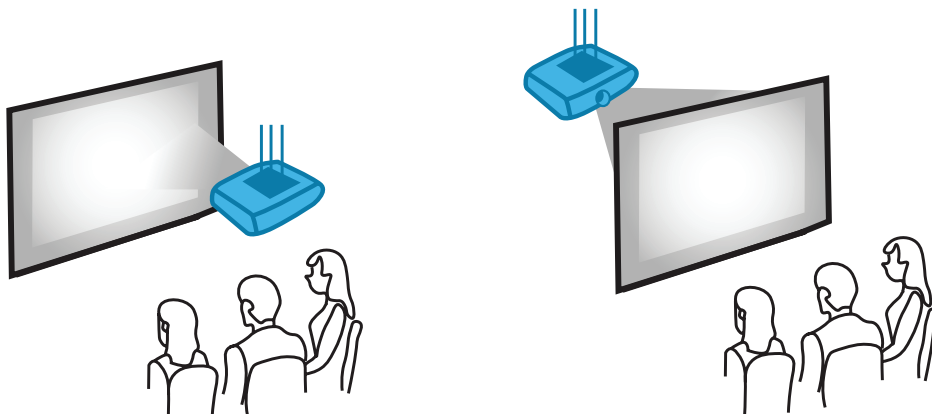

CAUTION | Do not operate the projector on its side, this may cause the projector to malfunction.

CAUTION | Do not look at the lens while the projector is on. Serious damage to your eyes could result. The following label, that is indicated near the lens-mounting-section on the projector cabinet, describes this projector is categorized in the risk group 2 of IEC 62471-5: 2015. As with any bright source, do not stare into the beam, RG2 IEC 62471-5: 2015.

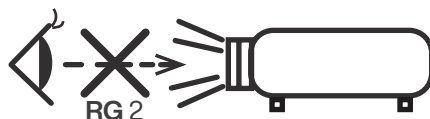

Using the projector on screen display (OSD)

OSD Menu tree

Additional details on each feature, function and option in the OSD Menu Tree is available in the detailed user guide which can be found at infocus.com

Default Setting		Default Setting By Source			Default Setting By Other		
MAIN	SUB LEVEL	SUB LEVEL 2	SUB LEVEL 3	SUB LEVEL 4	VALUE	COMMENTS	
IMAGE	Picture Mode				Presentation	1. RGB source default: Presentation	
					Bright		
					Movie	2. YUV source default: Movie	
					sRGB		
					DICOM SIM.		
					User		
					3D	3. 3D on default: 3D	
					ISF Day	4. ISF Day and ISF Night are valid while ISF Mode is On or Unlock	
				ISF Night			
	Wall Colour				Whiteboard		
					Blackboard		
					Light Yellow		
					Light Green		
					Light Blue		
					Pink		
					Gray		
	Brightness				-50 ~ 50		
	Contrast				-50 ~ 50		
	Sharpness				1 ~ 15		
	Colour				-50 ~ 50	Only for YUV source	
	Tint				-50 ~ 50	Only for YUV source	
	Advanced	Gamma				Film	NOTE With DICOM SIM Picture Mode selected or Blackboard, Wall Colour selected Gamma options will be hidden.
						Video	
						Graphics	
						Standard (2.2)	
						1.8	
						2.0	
			2.4				
BrilliantColor					1 ~ 10		
Colour Temp.					Warm		
					Medium		
				Cold			

Set up your InFocus

Default Setting		Default Setting By Source		Default Setting By Other				
MAIN	SUB LEVEL	SUB LEVEL 2	SUB LEVEL 3	SUB LEVEL 4	VALUE	COMMENTS		
IMAGE	Advanced	Colour Settings	Red	Hue	-50 ~ 50			
				Saturation	-50 ~ 50			
				Gain	-50 ~ 50			
				Exit				
			Green	Hue	-50 ~ 50			
				Saturation	-50 ~ 50			
				Gain	-50 ~ 50			
				Exit				
			Blue	Hue	-50 ~ 50			
				Saturation	-50 ~ 50			
				Gain	-50 ~ 50			
				Exit				
			Cyan	Hue	-50 ~ 50			
				Saturation	-50 ~ 50			
				Gain	-50 ~ 50			
				Exit				
			Magenta	Hue	-50 ~ 50			
				Saturation	-50 ~ 50			
				Gain	-50 ~ 50			
				Exit				
			Yellow	Hue	-50 ~ 50			
				Saturation	-50 ~ 50			
				Gain	-50 ~ 50			
				Exit				
			White	Red	-50 ~ 50			
				Green	-50 ~ 50			
				Blue	-50 ~ 50			
				Exit				
		Reset						
		Exit						
		RGB Gain/Bias	Red Gain			-50 ~ 50		
			Green Gain			-50 ~ 50		
			Blue Gain			-50 ~ 50		
			Red Bias			-50 ~ 50		
			Green Bias			-50 ~ 50		
			Blue Bias			-50 ~ 50		
			Reset					
		Exit						

Set up your InFocus

Default Setting		Default Setting By Source			Default Setting By Other			
MAIN	SUB LEVEL	SUB LEVEL 2	SUB LEVEL 3	SUB LEVEL 4	VALUE	COMMENTS		
IMAGE	Advanced	Colour Space			AUTO			
					RGB	Only for non-HDMI source		
					RGB (0~255)	Only for HDMI source		
					RGB (16~235)	Only for HDMI source		
					YUV			
			White Level			0 ~ 31	Only for S-Video	
			Black Level			-5 ~ 5	Only for S-Video	
			IRE			0	For S-Video Input Source NTSC Signal default: 7.5 PAL Signal default: 0 IRE Adjustment Only for NTSC-M/NTSC-J/NTSC-4.43/ PAL-M/PAL-60	
					7.5			
			Signal	Automatic			Off	NOTE: Only for Analog VGA source
							On	
				Phase			0~ 31	
				Frequency			-10 ~ 10	
				H. Position			-5 ~ 5	
				V. Position			-5 ~ 5	
	Exit							
	Exit							
DISPLAY	Format				4:3			
					16:9	For all models but WXGA & WUXGA models depend on Screen Type selection		
					16:10	Only for WXGA & WUXGA models depend on Screen Type selection		
					LBX	Only for WXGA, 1080p & WUXGA models.		
					Native	Original image without any scaling		
					Auto			
		Edge Mask			0~ 10			
		Zoom			-5 ~ 25			
		Image Shift	H			-100 ~ 100	NOTE: 50 adjustment of 2 steps per adjustment	
	V				-100 ~ 100	NOTE: 50 adjustment of 2 steps per adjustment		
	Exit							
	V Keystone				-40 ~ 40 -20 ~ 20 -10 ~ 10	-40 ~40 P130, P131 -20 ~ 20 P132 -10 ~ 10 P132 1080p/WUXGA		
	3D Mode				Off			
					DLP -Link			

Set up your InFocus

Default Setting		Default Setting By Source			Default Setting By Other			
MAIN	SUB LEVEL	SUB LEVEL 2	SUB LEVEL 3	SUB LEVEL 4	VALUE	COMMENTS		
DISPLAY	3D	3D - 2D			3D			
					L	Only display left frame		
					R	Only display right frame		
		3D Format					Auto	
							SBS	NOTE: SBS = Side by Side Half
							Top and Bottom	
							Frame Sequential	
		3D Sync. Invert					Off	
							On	
		Exit						
	Enhanced Gaming					Off	1. Only for 1920x1080 60Hz timing 2. Disable Keystone/Overscan/Zoom/Image Shift/Aspect Ratio when turn On	
						On		
	Picture Mode Lock					Off		
On								
SETUP	Language				English	English		
					Deutsch	German		
					Français	French		
					Svenska	Swedish		
					Español	Spanish		
					Português	Portuguese		
					Polski	Polish		
					Nederlands	Dutch		
					हिंदी	Hindi		
					Norsk/Dansk	Norwegian/Danish		
					Pilipino	Filipino		
					Melayu	Malay		
					Română	Romanian		
					Italiana	Italian		
					簡体中文	Simplified Chinese		
					Suomi	Finnish		
					ελληνικά	Greek		
			Русский	Russian				
			Magyar	Hungarian				

Set up your InFocus

Default Setting		Default Setting By Source		Default Setting By Other			
MAIN	SUB LEVEL	SUB LEVEL 2	SUB LEVEL 3	SUB LEVEL 4	VALUE	COMMENTS	
SETUP	Language			Čeština	Czechoslovak		
				عربي	Arabic		
				ไทย	Thai		
				Türkçe	Turkish		
				فارسی	Farsi		
				Tiếng Việt	Vietnamese		
				Bahasa Indonesia	Indonesian		
				বাংলা	Bengali		
	Projection			Front			
				Rear			
				Front-Ceiling			
				Rear-Ceiling			
	Menu Location			Top-Left			
				Top-Right			
				Center			
				Bottom-Left			
				Bottom-Right			
	Screen Type			16:10		1. Only for WXGA & WUXGA models	
				16:9		2. Relates to Format Setting	
	Security	Security			Off		
		Security Timer	Month			On	Default Password: 1234
			Day			0 ~ 12	
			Hour			0 ~ 30	
		Change Password				0 ~ 24	
	Project ID			0~ 99		P131, P132	
	Audio Settings	Mute			Off		
		Volume			On		
					0~ 10		
		Audio Input			Default		
	Exit				Audio in	Only for HDMI source	
	HDMI Link Settings	HDMI Link			Off		
					On		
		Power On Link			Mutual		
					PJ -> Device		
					Device -> PJ		

Set up your InFocus

Default Setting		Default Setting By Source			Default Setting By Other			
MAIN	SUB LEVEL	SUB LEVEL 2	SUB LEVEL 3	SUB LEVEL 4	VALUE	COMMENTS		
SETUP		Power Off Link			Off			
					On			
	Advanced	Logo				Default		
						Neutral		
		Background Colour					Black	
							Red	
							Blue	
							Green	
							White	
							Logo	
Information Hide					Off			
					On	NOTE: Warning messages & power off will not be hidden if activated		
Exit								
OPTIONS	Input Source				VGA			
					S-Video			
					HDMI			
					HDMI 2	P131, P132		
					Exit			
	Auto Source					Off		
						On		
	High Altitude					Off		
						On		
	Keypad Lock					Off	1. Keypad unlock hotkey: Press the "Enter" key on keypad for 5 secs to release keypad lock	
						On	2. Relate to IR Function: If Keypad Lock setting from Off to On, IR Function will be automatically changed to On	
	Test Pattern					Red Grid		
						Green Grid		
						Blue Grid		
						White		
	Remote Settings	IR Function				Off	NOTE: Relates to Keypad Lock: If IR Function setting from On to Off, Keypad Lock will be automatically changed to Off.	
						On		

Default Setting		Default Setting By Source			Default Setting By Other		
MAIN	SUB LEVEL	SUB LEVEL 2	SUB LEVEL 3	SUB LEVEL 4	VALUE	COMMENTS	
OPTIONS	Remote Settings	User 1			AV Mute	15 Users Settings & Presets Executed via the AV Mute Button on Remote Control	
					Wall Colour		
					Brightness		
					Contrast		
					Gamma		
					Colour Temp.		
					Colour Settings		
					RGB Gain/Bias		
					Language		
					Projection		
					Security		
					Test Pattern		
					Auto Power Off (min)		
					Sleep Timer (min)		
					Lamp Settings		
			INFO				
		Advanced	Direct Power On			Off	
						On	
			Signal Power On			Off	
						On	
			Auto Power Off (min)			0~ 180	One step: 5, DEFAULT 20
			Sleep Timer (min)			0 ~ 990	One step: 30
			Quick Resume			Off	
						On	
			VGA Out (Standby)			Off	Only Supported on P131 & P132 Models
						On	
		USB Power			Off		
					On	NOTE: USB Standby is not supported	
		Exit					
		Lamp Settings	Lamp Reminder			Off	
						On	
			BrightnessMode			Bright	
					Eco		
	Lamp Hours				Dynamic		

Set up your InFocus

Default Setting		Default Setting By Source			Default Setting By Other		
MAIN	SUB LEVEL	SUB LEVEL 2	SUB LEVEL 3	SUB LEVEL 4	VALUE	COMMENTS	
OPTIONS		Lamp Reset			No		
					Yes		
		Exit					
	Reset				No		
					Yes		
INFO	Regulatory				P130, P131 or P131	Regulatory Model of Projector Specified	
	Serial Number						
	Input Source						
	Resolution						
	Refresh Rate						
	Picture Mode						
	Lamp Hours	Bright					
		Eco					
		Dynamic					
		Total					
	Brightness Mode						
	Firmware Version	System					
MCU							
Project ID							

NOTE |

ISF

- The certified ISF technician will calibrate and optimize the projection image according to your actual environment.
- The ISF input password will be kept by technician only.
- “ISF Day” and “ISF Night” will not be shown in display mode if projector equipped with ISF function has not been calibrated by an ISF certified technician. For more information, please go to ISF official website: <https://www.imagingscience.com> and contact the dealer located in your country.
- The ISF calibration will be charged and guaranteed by ISF certified calibrator, and thereby InFocus is not responsible for the calibration service.

Front

P130, P131, P132 - 6 & 9 inputs/outputs

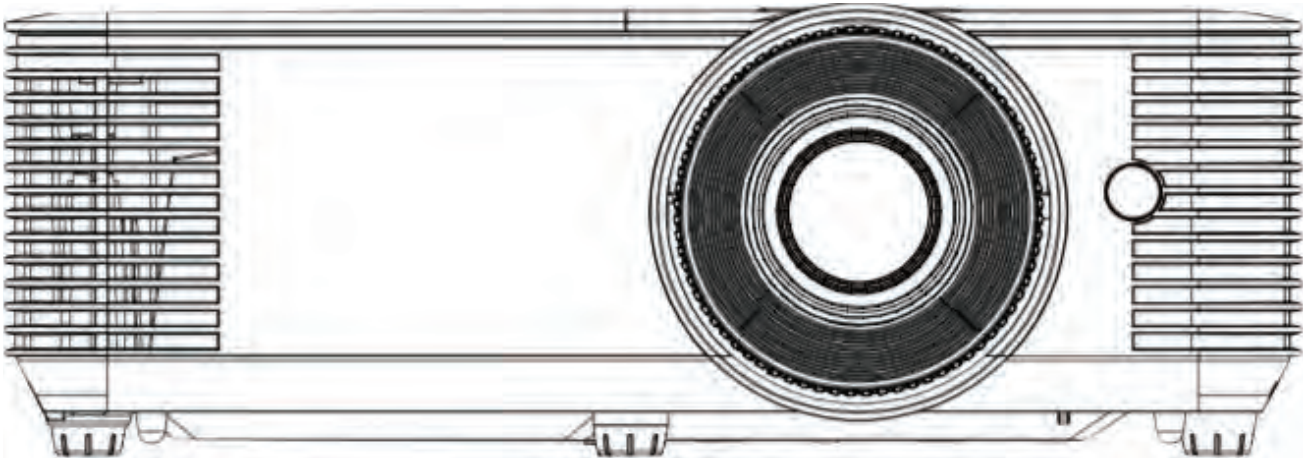

Back

P130 - 6 inputs/outputs

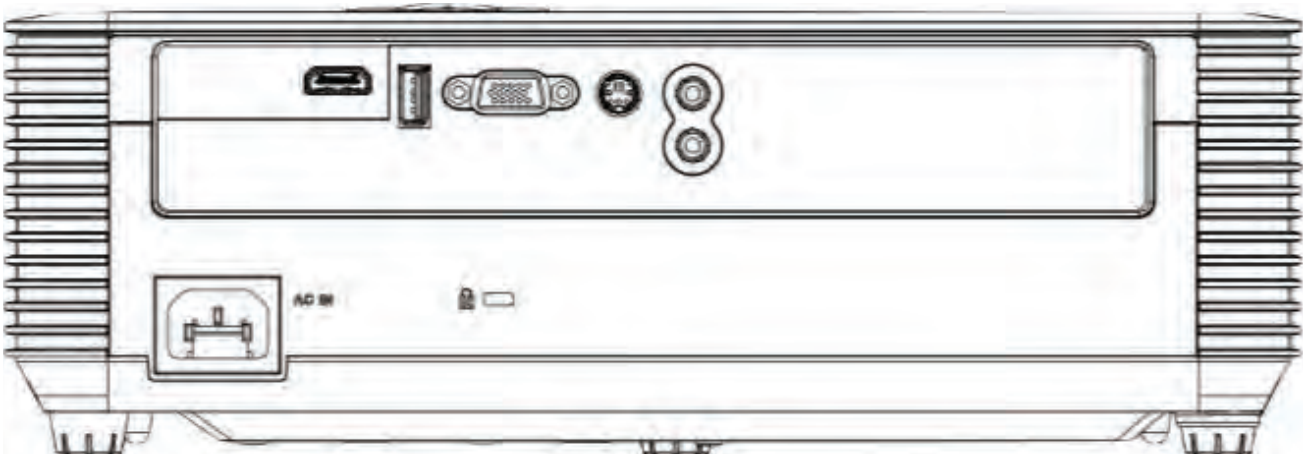

Views of your InFocus

Back

P131, P132 - 9 inputs/outputs

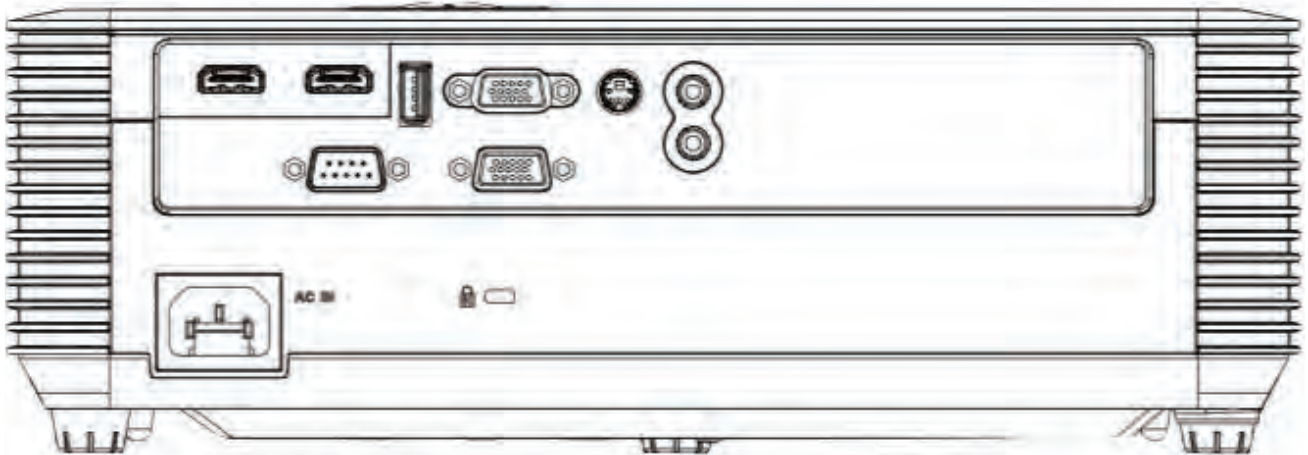

Top

P130, P131, P132 - 6 & 9 inputs/outputs

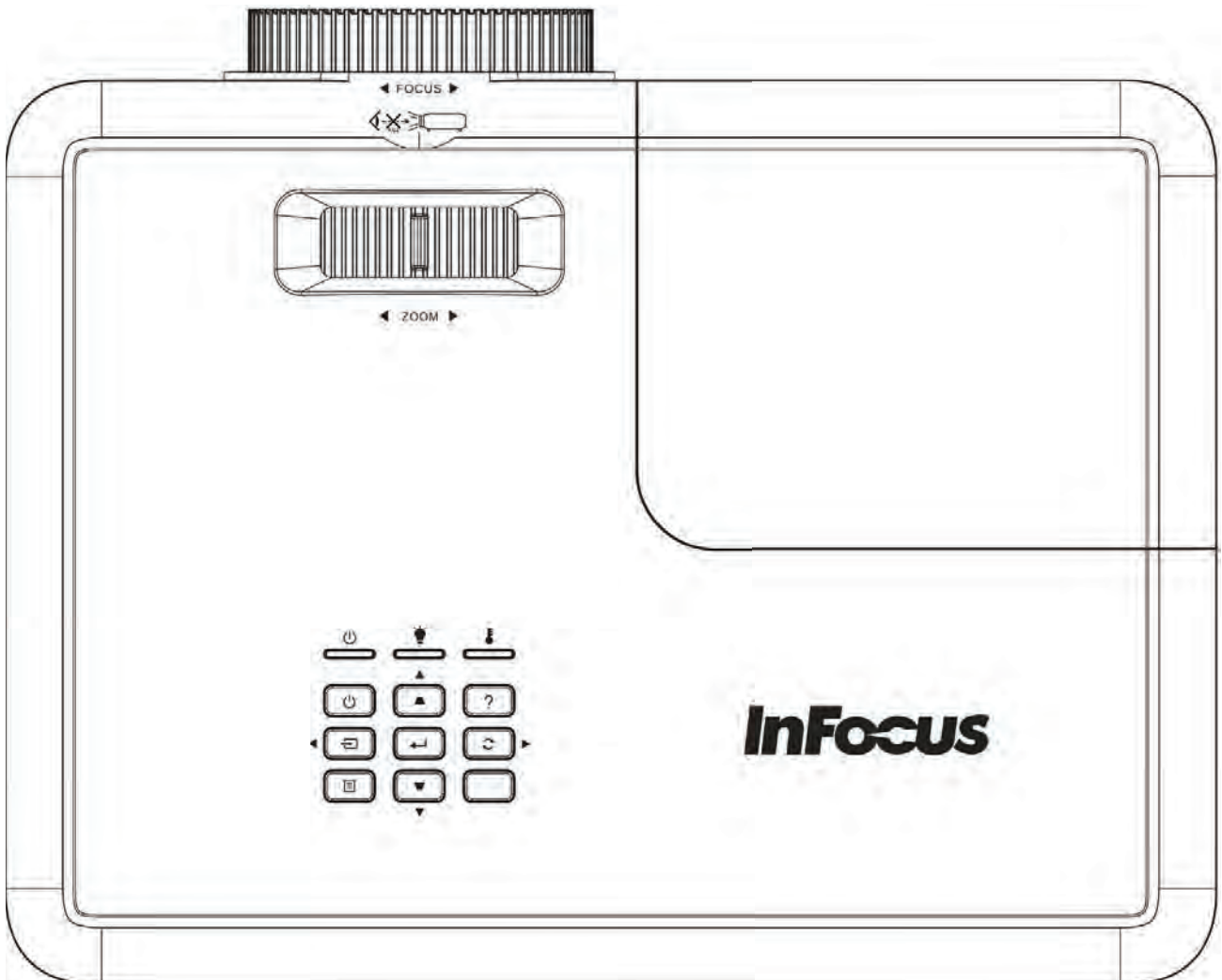

Left Side

P130, P131, P132 - 6 & 9 inputs/outputs

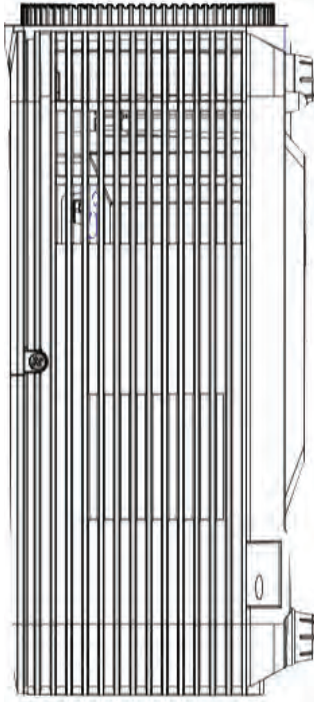

Right Side

P130, P131, P132 - 6 & 9 inputs/outputs

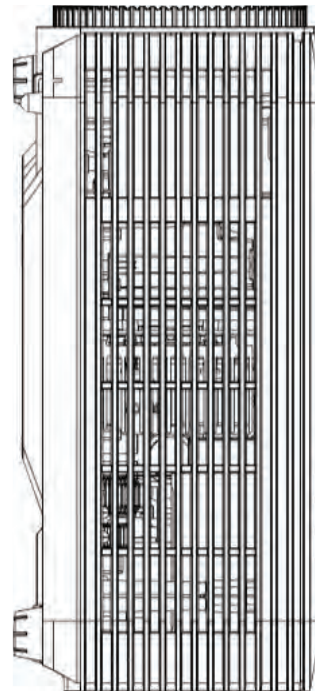

Bottom

P130, P131, P132 - 6 & 9 inputs/outputs

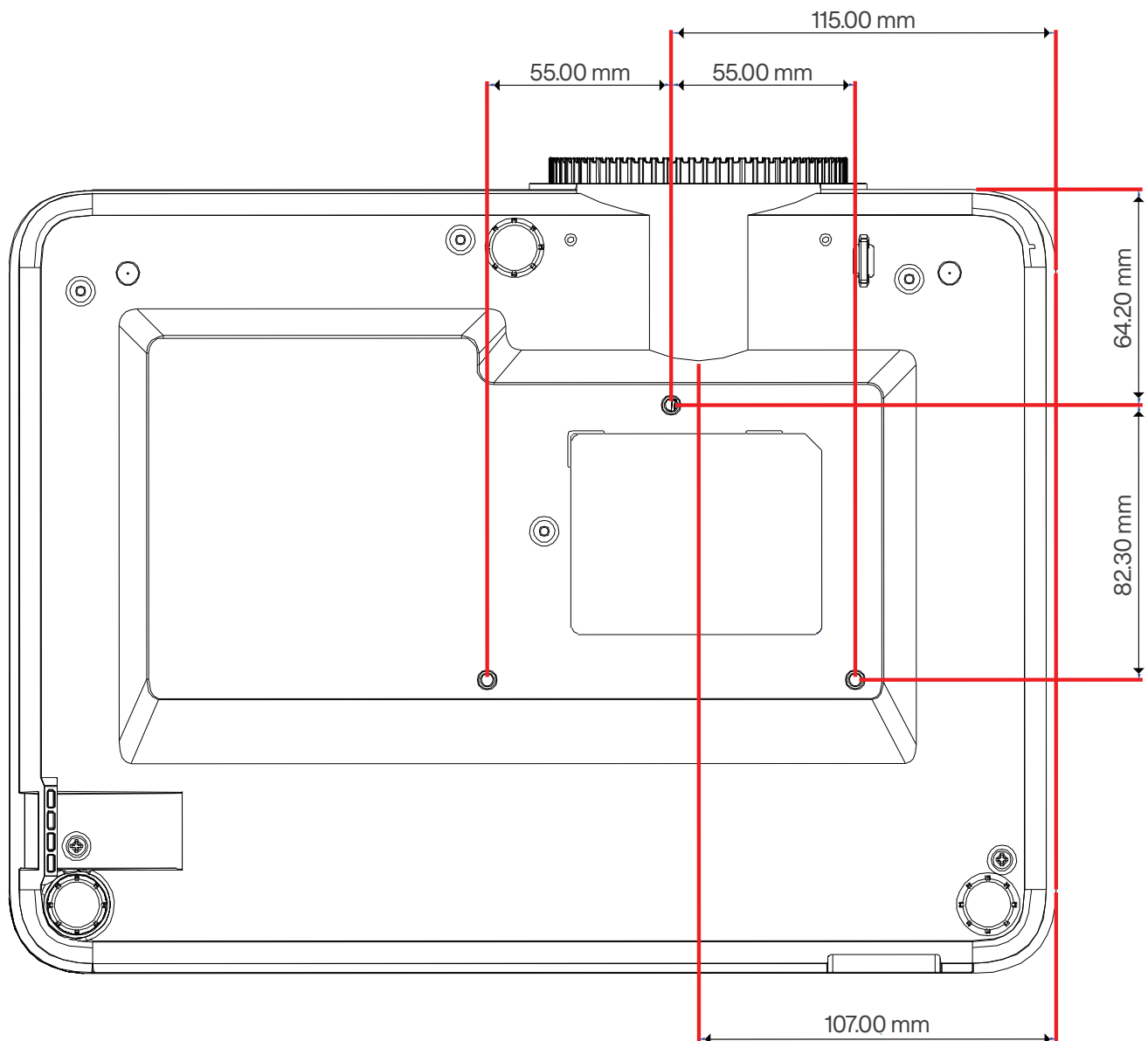

Remote control

Ships with regulatory model P130, P131, P132

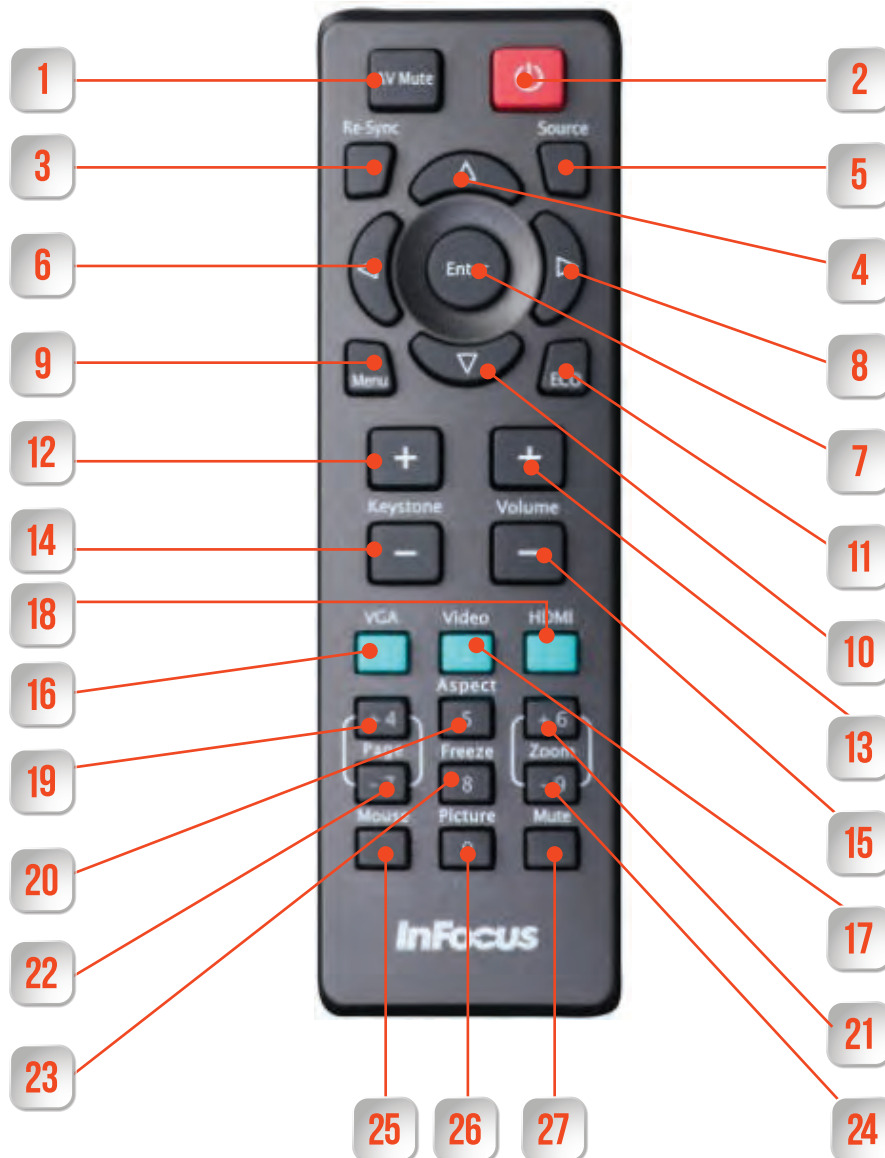

No	Key Fuction
1	AV mute
2	Power on/off
3	Re-Sync
4	Up
5	Source
6	Left
7	Enter
8	Right
9	Menu

No	Key Fuction	
10	Down	
11	Eco	
12	Keystone+	
13	Volume+	
14	Keystone-	
15	Volume-	
16	VGA	1
17	Video	2
18	HDMI	3

No	Key Fuction	
19	Page+	4
20	Aspect	5
21	Magnify+	6
22	Page-	7
23	Freeze	8
24	Magnify-	9
25	Mouse	
26	Picture	0
27	Mute	

NOTE | Some keys may have no function for models that do not support these features.

Views of your InFocus

Remote control effective range

Infra-Red (IR) remote control sensor is located on top of the projector. Ensure to hold the remote control at an angle within 30 degrees perpendicular to the projector's top IR remote control sensor to function correctly. The distance between the remote control and the sensor should not be longer than 6 meters (20 feet).

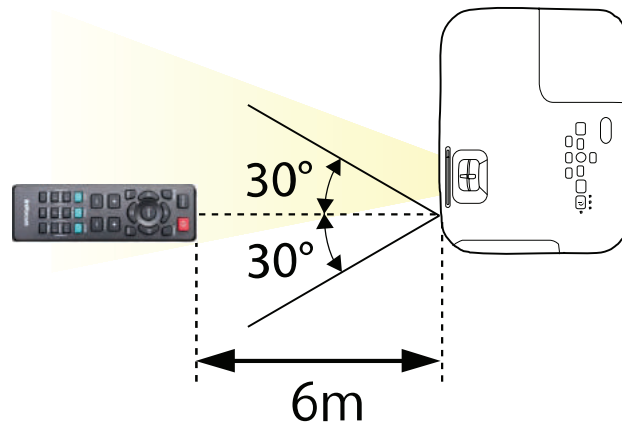

NOTE | When pointing the remote control directly (0 degrees angle) on the IR sensor, the distance between the remote control and the sensor should not be longer than 8 meters (~ 26 feet).

- ⑤ Make sure that there are no obstacles between the remote control and the IR sensor on the projector that might obstruct the infra-red beam.
- ⑤ Avoid using the remote control in direct sunlight or bright fluorescent lights at near range, as the projector may not respond to commands under these conditions.
- ⑤ Please keep the remote control at least 7 feet 2 meters away from fluorescent lamps otherwise the remote control may not operate as intended.
- ⑤ If the remote control is close to Inverter-Type fluorescent lamps, it might become ineffective from time to time.
- ⑤ If the remote control and the projector are within a very short distance, the remote control may become ineffective.
- ⑤ When pointing the remote control towards a projection screen or whiteboard, the effective distance of 20 feet 6 meters from remote to screen to projector may be shortened due to the IR reflectivity of the screen or white board surface.

Projector parts and functions

Front

P130, P131, P132 6 & 9 Input/Output Models



	Name	Function
1	Air Intake Vent	Air to cool the projector enters here
2	Keypad	Keys to operate the projector on screen display
3	Status and Warning LED's	Provide information on the status of the projector and error codes
4	Focus Ring	Used to focus the image (Not Applicable for P132 Short-Throw Models)
5	Optical Zoom Ring	Used to adjust the image size using optical zoom (Not Applicable for P132 Short-Throw Models)
6	Projector Lens	Images are projected from here
7	Lamp Door Housing	Housing for the projector lamp
8	Air Exhaust Vent	Hot air from the projector exits here
9	IR Remote Receiver	Receives commands from the remote control

Parts and functions

Back

P130 models 6 inputs/outputs



Name	Function
1 Power Inlet	Connects the power-cord to the projector
2 Kensington Lock Slot	Attach an optional Kensington lock here to secure your projector
3 HDMI input port	Inputs video signals to the projector from HDMI-compatible video equipment and computers. This projector is compatible with HDCP.
4 USB-A port	Delivers power 5V/1.5A to optional wireless devices connected to the HDMI port. Used to control the projector via an optional wired remote. Used for the delivery and updating of service firmware.
5 VGA input port	Inputs signal to the projector from a computer source over a VGA cable
6 S-Video input port	Inputs video signal to the projector from a source over a S-Video cable
7 Audio In port	Inputs audio signal from connected source to the projector
8 Audio Out Port	Outputs audio signal from the current input source to the projector to external speakers
9 Adjustable rear foot	Used to adjust and level the height of the projector
10 Fixed rear foot	Used in combination with the rear and front adjustable feet to level the projector

Back

9 inputs/outputs P131 & P132 models



Name	Function
1 Power Inlet	Connects the power-cord to the projector
2 Kensington Lock Slot	Attach an optional Kensington lock here to secure your projector
3 HDMI & HDMI 2 Input ports	Inputs video signals to the projector from HDMI compatible video equipment and computers. This projector is compatible with HDCP.
4 USB-A port	Delivers power 5V/1.5A to optional wireless devices connected to the HDMI port. Used to control the projector via an optional wired remote. Used for the delivery and updating of service firmware.
5 VGA input port	Inputs signal to the projector from a computer source over a VGA cable
6 S-Video input port	Inputs video signal to the projector from a source over a S-Video cable
7 Audio In port	Inputs audio signal from connected source to the projector
8 Audio Out Port	Outputs audio signal from the current input source to the projector to external speakers
9 Adjustable rear foot	Used to adjust and level the height of the projector
10 Fixed rear foot	Used in combination with the rear and front adjustable feet to level the projector
11 RS232 port	Connects a RS232 cable to a computer to control the projector.
12 VGA/Monitor Out Port	Outputs analog RGB signals from the VGA Input port to a monitor.

Bottom

P130, P131, P132 6 & 9 input/output models

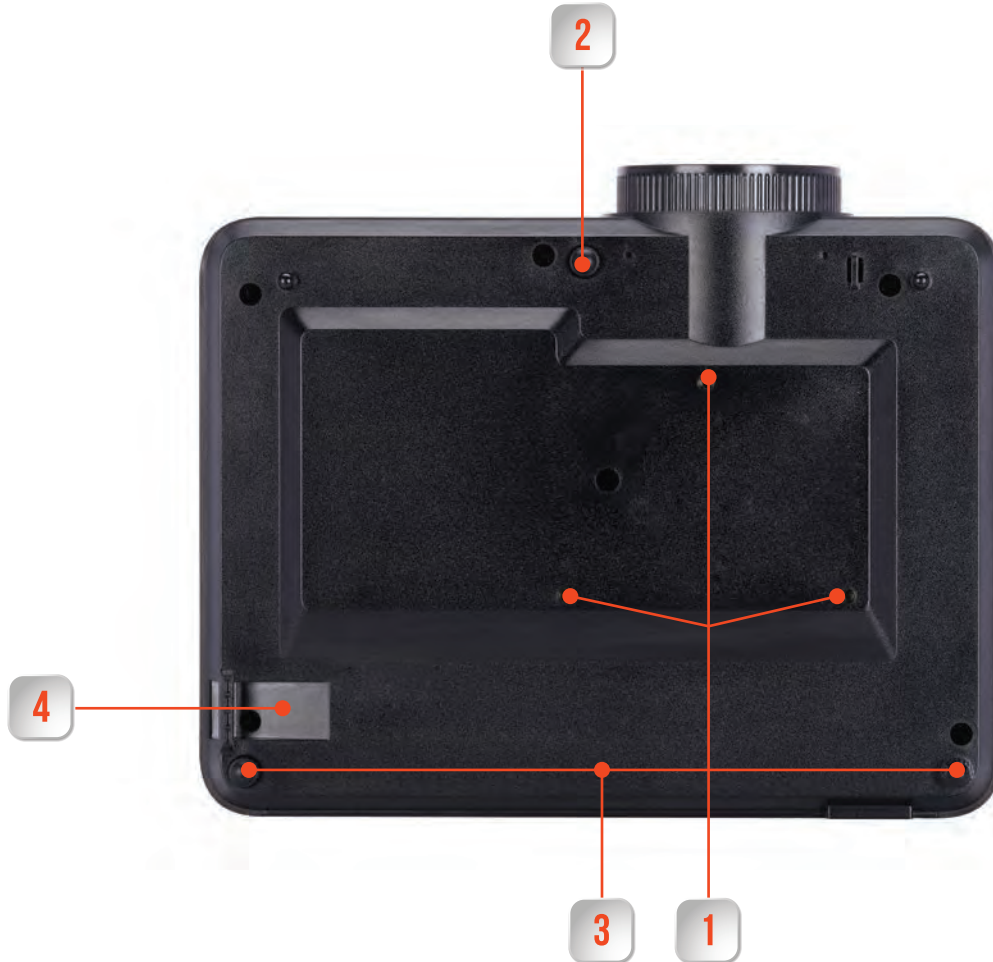

Name		Function
1	Mounting points for optional ceiling mount	Attach the optional ceiling mount when suspending the projector from a ceiling (three points)
2	Adjustable front foot	Used to level the projector or move the height of the image
3	Rear Feet (2)	Used to level the projector in combination with the front foot
4	Security cable attachment point	Pass a commercially available cable lock through here to secure the projector. You can also attach the optional commercially available wire through here to prevent the projector from falling when ceiling or wall mounted

Product features P130

PROJECTOR LINE	GENESIS				
PROJECTOR LINE RANGE	ESSENTIAL				
MODELS	IN112AA	IN114AA	IN116AA	IN118AA	IN119AA
	IN113AA	IN115AA	IN117AA	IN188AA	IN199AA
RESOLUTION	SVGA	XGA	WXGA	1080p	WUXGA
9 Picture Modes including DICOM Simulation, User Definable and ISF Night & Day	✓	✓	✓	✓	✓
7 Wall Colour Modes	✓	✓	✓	✓	✓
Brightness, Sharpness, Contrast, Colour, Tint, Gamma Adjustment Settings	✓	✓	✓	✓	✓
10 Step BrilliantColor Implementation	✓	✓	✓	✓	✓
Individual Hue, Saturation and Gain Adjustments for RGB, C, M, Y, W	✓	✓	✓	✓	✓
RGB Gain/Bias Adjustments	✓	✓	✓	✓	✓
5 Colour Space Adjustment Settings	✓	✓	✓	✓	✓
White and Black Level Adjustments	✓	✓	✓	✓	✓
IRE and Signal Settings and Adjustments	✓	✓	✓	✓	✓
Aspect Ratio Format Settings	✓	✓	✓	✓	✓
4:3	✓	✓	✓	✓	✓
16:9	✓	✓	✓	✓	✓
16:10	✓	✓	✓	✓	✓
Letter Box	✗	✗	✓	✗	✓
Native	✓	✓	✓	✓	✓
Auto	✓	✓	✓	✓	✓
Digital Edge Masking	✓	✓	✓	✓	✓
Digital Image Shift - Horizontal & Vertical	✓	✓	✓	✓	✓
Digital Zoom	✓	✓	✓	✓	✓
Vertical Keystone Adjustment	✓	✓	✓	✓	✓
3D Activation, DLP -Link Settings & Formats	✓	✓	✓	✓	✓
3D Sync Invert	✓	✓	✓	✓	✓
2D to 3D Setting	✓	✓	✓	✓	✓
Enhanced Low Latency Gaming Mode	✓	✓	✓	✓	✓
Picture Mode Lock	✓	✓	✓	✓	✓
27 Selectable OSD Languages	✓	✓	✓	✓	✓
Projection Modes - Front, Rear, Front Ceiling, Rear Ceiling	✓	✓	✓	✓	✓
OSD Menu Positioning	✓	✓	✓	✓	✓
ScreenType - Aspect Ratio Locking 16:10	✗	✗	✓	✗	✓
ScreenType - Aspect Ratio Locking 16:9	✓	✓	✓	✓	✓
Security On/Off Setting	✓	✓	✓	✓	✓
Security Timer	✓	✓	✓	✓	✓

Product features P130

PROJECTOR LINE	GENESIS				
PROJECTOR LINE RANGE	ESSENTIAL				
MODELS	IN112AA	IN114AA	IN116AA	IN118AA	IN119AA
	IN113AA	IN115AA	IN117AA	IN188AA	IN199AA
RESOLUTION	SVGA	XGA	WXGA	1080p	WUXGA
Security Password Selector	✓	✓	✓	✓	✓
Assignable Project ID Number	✗	✗	✗	✗	✗
Audio Input and Volume Settings	✓	✓	✓	✓	✓
HDMI Link Activation and Settings	✓	✓	✓	✓	✓
Startup Logo Removal and Background Colour Selector	✓	✓	✓	✓	✓
Projector Information Messaging Override	✓	✓	✓	✓	✓
Input Source Lock	✓	✓	✓	✓	✓
Auto Source Setting	✓	✓	✓	✓	✓
High Altitude Setting	✓	✓	✓	✓	✓
Keypad Lock Setting	✓	✓	✓	✓	✓
Built in Test Patterns	✓	✓	✓	✓	✓
IR Fuction Setting	✓	✓	✓	✓	✓
15 user presets with single key activation	✓	✓	✓	✓	✓
Direct Power On Setting	✓	✓	✓	✓	✓
Signal Power On Setting	✓	✓	✓	✓	✓
Auto Power Off Setting	✓	✓	✓	✓	✓
Sleep Timer Setting	✓	✓	✓	✓	✓
Quick Resume Setting	✓	✓	✓	✓	✓
VGA Out Standby Setting	✗	✗	✗	✗	✗
USB-A Power Setting	✓	✓	✓	✓	✓
Lamp Usage Reminder Setting	✓	✓	✓	✓	✓
Lamp Brightness Mode	✓	✓	✓	✓	✓
Projector Information Table	✓	✓	✓	✓	✓
24/7 Operation	✓	✓	✓	✓	✓
Waveform Lamp Colour Enhancement	✓	✓	✓	✓	✓
AV Mute	✓	✓	✓	✓	✓

PROJECTOR LINE	GENESIS				
PROJECTOR LINE RANGE	ESSENTIAL+				
MODELS	IN112BB	IN114BB	IN116BB	IN118BB	IN119BB
	IN113BB	IN115BB	IN117BB	IN188BB	IN199BB
RESOLUTION	SVGA	XGA	WXGA	1080p	WUXGA
9 Picture Modes including DICOM Simulation, User Definable and ISF Night & Day	✓	✓	✓	✓	✓
7 Wall Colour Modes	✓	✓	✓	✓	✓
Brightness, Sharpness, Contrast, Colour, Tint, Gamma Adjustment Settings	✓	✓	✓	✓	✓
10 Step BrilliantColour Implementation	✓	✓	✓	✓	✓
Individual Hue, Saturation and Gain Adjustments for R G B, C, M, Y, W	✓	✓	✓	✓	✓
RGB Gain/Bias Adjustments	✓	✓	✓	✓	✓
5 Colour Space Adjustment Settings	✓	✓	✓	✓	✓
White and Black Level Adjustments	✓	✓	✓	✓	✓
IRE and Signal Settings and Adjustments	✓	✓	✓	✓	✓
Aspect Ratio Format Settings	✓	✓	✓	✓	✓
4:3	✓	✓	✓	✓	✓
16:9	✓	✓	✓	✓	✓
16:10	✓	✓	✓	✓	✓
Letter Box	✗	✗	✓	✗	✓
Native	✓	✓	✓	✓	✓
Auto	✓	✓	✓	✓	✓
Digital Edge Masking	✓	✓	✓	✓	✓
Digital Image Shift - Horizontal & Vertical	✓	✓	✓	✓	✓
Digital Zoom	✓	✓	✓	✓	✓
Vertical Keystone Adjustment	✓	✓	✓	✓	✓
3D Activation, DLP -Link Settings & Formats	✓	✓	✓	✓	✓
3D Sync Invert	✓	✓	✓	✓	✓
2D to 3D Setting	✓	✓	✓	✓	✓
Enhanced Low Latency Gaming Mode	✓	✓	✓	✓	✓
Picture Mode Lock	✓	✓	✓	✓	✓
27 Selectable OSD Languages	✓	✓	✓	✓	✓
Projection Modes - Front, Rear, Front Ceiling, Rear Ceiling	✓	✓	✓	✓	✓
OSD Menu Positioning	✓	✓	✓	✓	✓
ScreenType - Aspect Ratio Locking 16:10	✗	✗	✓	✗	✓
ScreenType - Aspect Ratio Locking 16:9	✓	✓	✓	✓	✓
Security On/Off Setting	✓	✓	✓	✓	✓
Security Timer	✓	✓	✓	✓	✓

Product features P131

PROJECTOR LINE	GENESIS				
PROJECTOR LINE RANGE	ESSENTIAL+				
MODELS	IN112BB	IN114BB	IN116BB	IN118BB	IN119BB
	IN113BB	IN115BB	IN117BB	IN188BB	IN199BB
RESOLUTION	SVGA	XGA	WXGA	1080p	WUXGA
Security Password Selector	✓	✓	✓	✓	✓
Assignable Project ID Number	✓	✓	✓	✓	✓
Audio Input and Volume Settings	✓	✓	✓	✓	✓
HDMI Link Activation and Settings	✓	✓	✓	✓	✓
Startup Logo Removal and Background Colour Selector	✓	✓	✓	✓	✓
Projector Information Messaging Override	✓	✓	✓	✓	✓
Input Source Lock	✓	✓	✓	✓	✓
Auto Source Setting	✓	✓	✓	✓	✓
High Altitude Setting	✓	✓	✓	✓	✓
Keypad Lock Setting	✓	✓	✓	✓	✓
Built in Test Patterns	✓	✓	✓	✓	✓
IR Fuction Setting	✓	✓	✓	✓	✓
15 user presets with single key activation	✓	✓	✓	✓	✓
Direct Power On Setting	✓	✓	✓	✓	✓
Signal Power On Setting	✓	✓	✓	✓	✓
Auto Power Off Setting	✓	✓	✓	✓	✓
Sleep Timer Setting	✓	✓	✓	✓	✓
Quick Resume Setting	✓	✓	✓	✓	✓
VGA Out Standby Setting	✓	✓	✓	✓	✓
USB-A Power Setting	✓	✓	✓	✓	✓
Lamp Usage Reminder Setting	✓	✓	✓	✓	✓
Lamp Brightness Mode	✓	✓	✓	✓	✓
Projector Information Table	✓	✓	✓	✓	✓
24/7 Operation	✓	✓	✓	✓	✓
Waveform Lamp Colour Enhancement	✓	✓	✓	✓	✓
AV Mute	✓	✓	✓	✓	✓

PROJECTOR LINE	GENESIS		
PROJECTOR LINE RANGE	SHORT THROW		
MODELS	IN114BBST	IN116BBST	IN118BBST
	IN115BBST	IN117BBST	IN1188BBST
RESOLUTION	XGA	WXGA	1080p
9 Picture Modes including DICOM Simulation, User Definable and ISF Night & Day	✓	✓	✓
7 Wall Colour Modes	✓	✓	✓
Brightness, Sharpness, Contrast, Colour, Tint, Gamma Adjustment Settings	✓	✓	✓
10 Step BrilliantColour™ Implementation	✓	✓	✓
Individual Hue, Saturation and Gain Adjustments for R G B, C, M, Y, W	✓	✓	✓
RGB Gain/Bias Adjustments	✓	✓	✓
5 Colour Space Adjustment Settings	✓	✓	✓
White and Black Level Adjustments	✓	✓	✓
IRE and Signal Settings and Adjustments	✓	✓	✓
Aspect Ratio Format Settings	✓	✓	✓
4:3	✓	✓	✓
16:9	✓	✓	✓
16:10	✓	✓	✓
Letter Box	✗	✓	✓
Native	✓	✓	✓
Auto	✓	✓	✓
Digital Edge Masking	✓	✓	✓
Digital Image Shift - Horizontal & Vertical	✓	✓	✓
Digital Zoom	✓	✓	✓
Vertical Keystone Adjustment	✓	✓	✓
3D Activation, DLP -Link Settings & Formats	✓	✓	✓
3D Sync Invert	✓	✓	✓
2D to 3D Setting	✓	✓	✓
Enhanced Low Latency Gaming Mode	✓	✓	✓
Picture Mode Lock	✓	✓	✓
27 Selectable OSD Languages	✓	✓	✓
Projection Modes - Front, Rear, Front Ceiling, Rear Ceiling	✓	✓	✓
OSD Menu Positioning	✓	✓	✓
ScreenType - Aspect Ratio Locking 16:10	✗	✓	✗
ScreenType - Aspect Ratio Locking 16:9	✓	✓	✓
Security On/Off Setting	✓	✓	✓
Security Timer	✓	✓	✓

Product features P132

PROJECTOR LINE	GENESIS		
PROJECTOR LINE RANGE	SHORT THROW		
MODELS	IN114BBST	IN116BBST	IN118BBST
	IN115BBST	IN117BBST	IN1188BBST
RESOLUTION	XGA	WXGA	1080p
Security Password Selector	✓	✓	✓
Assignable Project ID Number	✓	✓	✓
Audio Input and Volume Settings	✓	✓	✓
HDMI Link Activation and Settings	✓	✓	✓
Startup Logo Removal and Background Colour Selector	✓	✓	✓
Projector Information Messaging Override	✓	✓	✓
Input Source Lock	✓	✓	✓
Auto Source Setting	✓	✓	✓
High Altitude Setting	✓	✓	✓
Keypad Lock Setting	✓	✓	✓
Built in Test Patterns	✓	✓	✓
IR Fuction Setting	✓	✓	✓
15 user presets with single key activation	✓	✓	✓
Direct Power On Setting	✓	✓	✓
Signal Power On Setting	✓	✓	✓
Auto Power Off Setting	✓	✓	✓
Sleep Timer Setting	✓	✓	✓
Quick Resume Setting	✓	✓	✓
VGA Out Standby Setting	✓	✓	✓
USB-A Power Setting	✓	✓	✓
Lamp Usage Reminder Setting	✓	✓	✓
Lamp Brightness Mode	✓	✓	✓
Projector Information Table	✓	✓	✓
24/7 Operation	✓	✓	✓
Waveform Lamp Colour Enhancement	✓	✓	✓
AV Mute	✓	✓	✓

Specifications overview P130

PROJECTOR LINE	GENESIS				
PROJECTOR LINE RANGE	ESSENTIAL				
MODELS	IN112AA	IN114AA	IN116AA	IN118AA	IN119AA
	IN113AA	IN115AA	IN117AA	IN188AA	IN199AA

DISPLAY & OPTICAL					
RESOLUTION	SVGA	XGA	WXGA	1080p	WUXGA
	800 x 600	1024 x 768	1200 x 800	1920 x 1080	1920 x 1200
LENS	Manual, 1:1 Zoom and Focus				
DISPLAY TECHNOLOGY	Texas Instruments DLP				
COLOUR REPRODUCTION	1073.4 Million Colours				
NATIVE ASPECT RATIO	4:3		16:10	16:9	16:10
COMPATIBLE ASPECT RATIO	16:9 & 16:10		16:9 & 4:3	16:10 & 4:3	16:9 & 4:3

ELECTRICAL	
INPUTS, OUTPUTS	1x HDMI 1x VGA, 1x S-VIDEO, 1x USB-A, 1x Audio In, 1x Audio Out
SPEAKER	Yes, 1x 3W
POWER REQUIRMENT	100-240V @ 50/60Hz

MECHANICAL	
INSTALLATION ORIENTATION	Front, Rear, Front Ceiling, Rear Ceiling
DIMENSIONS	313 x 236 x 107 mm / 12.32" x 9.29" x 4.21"
WEIGHT	2.6 Kg / 5.72 lb
ENVIRONMENTAL CONDITIONS	Operating in 5 ~ 40°C / 41 ~ 104°F, 10% to 85% humidity (non-condensing)

Specifications overview P131

PROJECTOR LINE	GENESIS				
PROJECTOR LINE RANGE	ESSENTIAL+				
MODELS	IN112BB	IN114BB	IN116BB	IN118BB	IN119BB
	IN113BB	IN115BB	IN117BB	IN118BB	IN119BB

DISPLAY & OPTICAL					
RESOLUTION	SVGA	XGA	WXGA	1080p	WUXGA
	800 x 600	1024 x 768	1200 x 800	1920 x 1080	1920 x 1200
LENS	Manual, 1:1 Zoom and Focus				
DISPLAY TECHNOLOGY	Texas Instruments DLP				
COLOUR REPRODUCTION	1073.4 Million Colours				
NATIVE ASPECT RATIO	4:3		16:10	16:9	16:10
COMPATIBLE ASPECT RATIO	16:9 & 16:10		16:9 & 4:3	16:10 & 4:3	16:9 & 4:3

ELECTRICAL	
INPUTS, OUTPUTS	2x HDMI 1x VGA, 1x VGA Out, 1x S-VIDEO, 1x USB-A, 1x Audio In, 1x Audio Out, 1x RS232
SPEAKER	Yes, 1x 10W
POWER REQUIREMENT	100-240V @ 50/60Hz

MECHANICAL	
INSTALLATION ORIENTATION	Front, Rear, Front Ceiling, Rear Ceiling
DIMENSIONS	313 x 236 x 107 mm / 12.32" x 9.29" x 4.21"
WEIGHT	2.6 Kg / 5.72 lb
ENVIRONMENTAL CONDITIONS	Operating in 5 ~ 40°C / 41 ~ 104°F, 10% to 85% humidity (non-condensing)

Specifications overview P132

PROJECTOR LINE	GENESIS		
	SHORT THROW		
PROJECTOR LINE RANGE	IN114BBST	IN116BBST	IN118BBST
MODELS	IN115BBST	IN117BBST	IN188BBST
DISPLAY & OPTICAL			
RESOLUTION	XGA	WXGA	1080p
	1024 x 768	1200 x 800	1920 x 1080
LENS	Fixed 1:1 Lens		
DISPLAY TECHNOLOGY	Texas Instruments DLP		
COLOUR REPRODUCTION	1073.4 Million Colours		
NATIVE ASPECT RATIO	4:3	16:10	16:9
COMPATIBLE ASPECT RATIO	16:9 & 16:10	16:9 & 4:3	16:10 & 4:3
ELECTRICAL			
INPUTS, OUTPUTS	2x HDMI , 1x VGA, 1x VGA Out, 1x S-VIDEO, 1x USB-A, 1x Audio In, 1x Audio Out, 1x RS232		
SPEAKER	Yes, 1x 10W		
POWER REQUIRMENT	100-240V @ 50/60Hz		
MECHANICAL			
INSTALLATION ORIENTATION	Front, Rear, Front Ceiling, Rear Ceiling		
DIMENSIONS	313 x 236 x 107 mm / 12.32" x 9.29" x 4.21"		
WEIGHT	2.9 Kg / 6.39 lb		
ENVIRONMENTAL CONDITIONS	Operating in 5 ~ 40°C / 41 ~ 104°F, 10% to 85% humidity (non-condensing)		

Environmental conditions

Be sure to observe the following precautions to avoid malfunctions, operating errors or damage to the projector.

Notes on handling and storage

- ⑤ Do not use or store the projector in places where it might be subjected to high and low extremes of temperature. Furthermore, avoid places where the temperature may change suddenly.
- ⑤ Be sure to observe the operating temperatures and storage temperatures given in the user guide when using and storing the projector.
- ⑤ When storing the projector, store it in a dry location.
- ⑤ Do not set up the projector in places where it might be subjected to vibration or shock.
- ⑤ Do not set up the projector near high-voltage electrical wires or sources of magnetic fields. These may interfere with correct operation.
- ⑤ Do not touch the lens with bare hands.
- ⑤ Always attach the lens cover to the lens when not using the projector, to prevent the lens from becoming dirty or damaged.
- ⑤ Remove the batteries from the remote control before storage. If the batteries are left in the remote control for long periods, they may leak.
- ⑤ Do not use or store the projector in places where smoke from oil or cigarettes may be present, as it can adversely affect the quality of the projected images.
- ⑤ Contact your dealer to clean the interior of the projector. If the interior of the projector has not been cleaned for a long time, dust may build up, which could cause fire or electric shock.
- ⑤ InFocus takes no responsibility for loss or damage caused by damage to the projector outside service warranty conditions.
- ⑤ When a still image is displayed for a long period of time, image retention may occur on the screen. Do not display images in the exact same position for long periods.

Notes on carrying the projector

- ⑤ Turn off the projector power and then disconnect the power cable from the outlet. Furthermore, check that all other cables have been disconnected.
- ⑤ Attach the lens cover to the lens.
- ⑤ Retract the adjustable foot.
- ⑤ If your model of projector has a handle, hold the projector by the handle when carrying it.
- ⑤ When carrying large or heavy models, make sure it is carried by the number of people specified in the user guide.

When transporting the projector to InFocus or a InFocus service center for repairs

The internal projector components consist of many glass parts and high-precision parts. When transporting the projector, take the following measures to protect the projector from any damage that might result from shock.

Enclose the projector securely in buffer material to protect it from shock, and place it into a strong cardboard container. Be sure to notify the carrier company that the contents are fragile.

InFocus, its service centers and authorized service partners do not accept liability for goods damaged during transit due to inadequate or improper packaging of the projector.

Power cables for Overseas Use

The power cable that is supplied with this projector conforms to electrical safety regulations. Do not use a power cable other than the one supplied with the projector. If using the projector overseas, check the power supply voltage, outlet shape and electrical rating of the projector that conform to the local standards, and purchase a proper power cable in the country.

Term	Description
1080i	1080i is ATSC high definition 1920 x 1080 interlaced video format where a frame of video is delivered in two fields. The first field contains the odd lines of the image, while the second field contains the even lines. Each field is updated every 1/60th of a second resulting in 30 frames of video per second.
1080p	1080p is ATSC high definition 1920 x 1080 progressive scan video format where a complete frame of video is delivered at either 60 or 24 frames per second.
16:9	Aspect ratio of an HDTV signal which is 16 units by 9 units, whatever size those units may be. In the film trade aspect ratios are described in relation to one, which means this aspect ratio is described as 16/9 or 1.78:1.
2:2 pull-down	Method for transferring 24 frame per second film to PAL/SECAM video running at 25 frames per second.
2:3 Pull-Down	2:3 pull-down, commonly called 3:2 pull-down, converts film footage to NTSC video. Film footage is shot at 24 frames per second (FPS) and NTSC video is shot at 30 FPS. 3:2 pull-down refers to the electronics needed to convert 24 FPS to 30 FPS so that it can be viewed on a NTSC video device. To accomplish this, 4 frames of film are converted to 5 frames of video by inserting an extra field of film frame every other frame.
3D Ready	A projector that is 3D Ready can accept a 120Hz frame-sequential 3D signal from a computer via either NVIDIA's 3D Vision system or one of several educational software suites. These projectors are not compatible with the HDMI 1.4 3D specification used on 3D Blu-ray players and set-top boxes. We also refer to this type of 3D as PC 3D Ready.
3LCD	Common 3 colour system for projecting images via LCD or liquid crystal display. Uses dichroic mirrors to separate the RGB components of white light coming from a projection lamp. Each colour is fed to separate LCD panels which control the amount of coloured light that passes through. The light from each LCD is recombined using a dichroic prism before going out the lens and on to a screen.
480i	480i is ATSC Standard Definition Television (SDTV) 720 x 480 or 640 x 480 interlaced video format where a frame of video is delivered in two fields. The first field contains the odd lines of the image and the second field contains the even lines. Each field is updated every 1/60th of a second resulting in 30 frames of video per second.
480p	480p is ATSC Enhanced Definition Television (EDTV) 720 x 480 progressive scan video format where a complete frame of video is delivered at either 30 or 24 frames per second. 480p also refers to a display format comprised of 854 x 480 pixels, 16:9 widescreen.
720p	720p is an ATSC high definition 1280 x 720 progressive scan video format where a complete frame of video is delivered at either 60, 30 or 24 frames per second.
Anamorphic	A technique for changing aspect ratios by optically or digitally stretching or compressing an image to or from a format with a different native aspect ratio. Movie studios used this technique to put the first widescreen movies on standard 35mm film and then used an anamorphic lens to recreate the image in the widescreen format in which it was originally shot.
Anamorphic Lens	An anamorphic lens is a lens that has different optical magnification along mutually perpendicular radii. This provides the ability to project a source image of one aspect ratio, such as 4:3, into a different aspect ratio, such as 16:9, by using different magnifications for the horizontal and the vertical dimensions of the projected image.
Anamorphic Ready	A projector that supports anamorphic projection using an optional anamorphic lens.
ANSI	American National Standards Institute. A private organization that coordinates and administers various voluntary consensus standards such as ANSI lumens. The first ANSI standard was for pipe threading in 1919 when it was called the American Engineering Standards Committee.

Glossary

Term	Description
ANSI Contrast	Contrast is the ratio between white and black. The larger the contrast ratio the greater the ability of a projector to show subtle colour details and tolerate extraneous room light. There are two methods used by the projection industry: 1) Full On/Off contrast measures the ratio of the light output of an all white image (full on) and the light output of an all black (full off) image. 2) ANSI contrast is measured with a pattern of 16 alternating black and white rectangles. The average light output from the white rectangles is divided by the average light output of the black rectangles to determine the ANSI contrast ratio. When comparing the contrast ratio of projectors make sure you are comparing the same type of contrast. Full On/Off contrast will always be a larger number than ANSI contrast for the same projector.
ANSI Lumens	ANSI lumens is a measurement of the overall brightness of a projector. Because the center of a projected image is brighter than the corners, ANSI lumens is the most accurate representation of the image brightness. ANSI lumens are calculated by dividing a square meter image into 9 equal rectangles, measuring the lux (or brightness) reading at the center of each rectangle, and averaging these nine points.
Aperture	A device that controls amount of light admitted.
Artifacts	Flaws and aberrations in a video image that derive from technical limitations in the capture, encoding/decoding, transmission, and display of a video signal.
Aspect Ratio	The ratio of image width to image height. Standard television is 4:3 or 1.33:1. Panavision or Cinemascope is 2.35:1 with 1.85:1 being quite common as well. Widescreen displays are 1.78:1 or 16:9. times the height. For example, if you want an image 40 inches high then you need a screen that is at least 40 * 1.78 inches wide or 71 inches. Other relatively common aspect ratios are 3:2, 4:3 and 5:4.
Bandwidth	The number of cycles per second (Hertz) expressed as the difference between the lower and upper limits of a frequency band; also, the width of a band of frequencies. Practically speaking, bandwidth is the amount of data that can pass through a given connection per unit of time.
Barrel Distortion	Distortion where screen image expands outward towards edges of the screen. Instead of being square, edges are curved outward like the edge of a barrel. Opposite of pincushion.
Bezel	The frame or face of a device, such as, a projector grill, or CRT or LCD display frame.
Black Level	The darkest part of a picture. This can vary between display devices and viewing environments. NTSC black is set at 7.5 IRE, which is very slightly gray. The white level divided by the black level gives a contrast ratio for a particular display device.
Blackboard Mode	Blackboard mode is a projector feature that allows the projector to detect the colour of the display surface such as a chalkboard or painted wall and automatically adjust its output to optimize accurate colour reproduction.
Blanking	The period of time that an electron gun is turned off to reposition itself to paint the next part of the video onto the CRT screen.
Bleeding	Video distortion where colour "bleeds" from an object onto other parts of the image which are not supposed to be that colour.
Blue Laser	Colour of the laser used with Blu-ray high definition DVDs. Blue laser light has a shorter wavelength than red, which is why blue lasers can retrieve and store more data in a given physical area.
BNC	Bayonet Nut Connector or British Naval Connector. A high quality, locking cable plug which is used extensively in professional video.
Bowing	Video distortion where lines which should be straight are curved. See barrel distortion and pincushioning.
Brightness	Overall light output from an image. While a brightness control can make an image brighter, it is best used to better define the black level of the image.

Term	Description
Brightness (Perceived)	The brightness of a projection system can be precisely measured with a light meter. For example, a typical movie theater is setup to deliver 16 foot-Lamberts. The higher the foot-Lamberts, the brighter the image. A common misconception is that a projector with twice the foot-Lamberts of another projector will be twice as bright. While it is true that a light meter will detect it as twice as bright, your eye will not. The perceived brightness will increase by about 50%. It will not double because the human eye has a logarithmic respond to light.
Brilliant Color	Brilliant Color - a technology developed by Texas Instruments® for its DLP® projectors that produces six channels of colour including red, green, blue, cyan, magenta, and yellow; thereby, allowing an increase in the colour gamut.
Calibrate	To adjust with reference to a standard.
Channel	A separate signal or signal path.
Closed Caption	Closed caption (CC) superimposes a transcript of the audio portion of a video program over the program image. Its primary use is to provide people that are deaf or hard of hearing the opportunity to read a transcript of the audio as it is being played. Closed Caption is also helpful for people learning to read or learning a foreign language. Closed Caption can also be used to display text unrelated to the program being viewed, such as weather or news.
Coated Optics	A variety of materials put on high quality lenses to minimize the amount of light reflected back to the lamp and the amount of ambient light that mingles with the focused light leaving the lens. Generally good coatings can add 15% or more to the lenses brightness. Other coatings are used for filtering colours.
Coaxial	An audio or video cable with a single internal wire with an outer shield that is ground. In audio, a speaker type where one speaker is positioned within another larger speaker's cone.
Colour Dynamics	The whitest whites, reddest reds, bluest blues and greenest greens. High colour dynamics are a result of dynamic range/contrast ratios. Having excellent colour dynamics implies rich colours, excellent definition, high contrast.
Colour Saturation	Measure of colour purity. Highly saturated colours emit a very narrow band of wavelengths of light instead of the broader spectrum of frequencies emitted from mixed colours. A display with good saturation capability will look vibrant.
Colour Temperature	Colour balance of white light which goes from red to blue as the temperature rises. Measured in degrees Kelvin, which starts at absolute 0 or -273 degrees Celsius, colour temperature matches the reference standard of the light being emitted from a carbon block heated to the stated degrees. For instance, the early morning sun is around 2500K, which is the same warm light that a carbon block heated to 2227° Celsius would emit. Heating the block further to ~10000° Celsius would emit the same bluish light of a blue-sky mid-day sun. Common colour temperatures are 5500 Kelvin (black and white movies) and 6500 Kelvin (standard colour films).
Colour Wheel	Rotating wheel with 3 or more translucent colour filters used to display sequential colour on single imager light valve based projection devices. The imager reflects or transmits the colour component of a given image when the wheel's corresponding colour filter is affecting the light passing through to the lens. A 1X wheel cycles through all colours in 1/60th of a second.
Component Video	Component Video is a method of delivering quality video (RGB) in a format that contains all the components of the original image. These components are referred to as luma and chroma and are defined as Y'Pb'Pr' for analog component and Y'Cb'Cr' for digital component. . It is comprised of luminance (Y) and two chrominance channels of blue minus luminance and red minus luminance.
Contrast	Contrast increases as the white point increases. Increasing the white point creates a greater difference between white and black.

Glossary

Term	Description
Contrast Ratio	<p>The ratio between white and black. The larger the contrast ratio the greater the ability of a video device to show subtle colour details and tolerate ambient room light.</p> <p>There are two industry methods used: 1) Full On/Off contrast measures the ratio of the light output of an all white image (full on) and the light output of an all black (full off) image. 2) ANSI contrast is measured with a pattern of 16 alternating black and white rectangles. The average light output from the white rectangles is divided by the average light output of the black rectangles to determine the ANSI contrast ratio. When comparing the contrast ratio of video devices make sure you are comparing the same type of contrast. Full On/Off contrast will always be a larger number than ANSI contrast for the same video device.</p>
Crestron RoomView	<p>Crestron RoomView Connected is built into projectors enabling direct network connectivity for remote management of AV networks.</p> <p>Crestron RoomView® Express software provides enterprise help desk management, remote monitoring and control of global AV networks without any special wiring, hardware or programming. Once connected to the network, classroom teachers and presenters can instantly control any installed RoomView Connected™ projector. With no programming required, AV and IT managers can globally monitor and control networked projectors throughout a school, campus, or corporate enterprise.</p> <p>Adding a Crestron control processor enables control of all AV devices, lighting and environmental systems on the network from any Crestron touch screen, Web browser and Apple® and Android® mobile devices including iPad™ and iPhone®.</p> <p>By leveraging the Ethernet port on RoomView Connected projectors and accessing RoomView, AV managers and support staff can remotely take control of classroom technology, troubleshoot and perform remote system diagnostics, track projector usage and lamp life, log network activity and much more. Remote capabilities allow efficient scheduling of projector power-off at preset times, routine maintenance, faster response times to support calls, alert notifications if projectors are disconnected, and broadcast messaging of emergency alerts to all projectors.</p>
Crosstalk	Interference of an electrical signal by another electrical signal in close proximity caused by its electromagnetism.
CRT	Cathode Ray Tube.
dB	dB or decibel is a measure of relative loudness. 0 dB is the threshold of hearing. 60 dB is equivalent to normal conversation. 120 to 140 dB is the threshold of pain such as a jackhammer or gun shot. 10 db of change will double the loudness.
Deinterlacer	Electronic component that converts an interlace video signal to progressive scan.
Deinterlacing	Act of converting an interlace video signal to progressive scan.
Diagonal	The diagonal of a screen or flat panel can be computed by using the Pythagorean theorem: squaring the width, squaring the height, adding them together and taking the square root. A 100" diagonal 16:9 screen measures 49" high by 87" wide; a 100" diagonal 4:3 screen measures 60" high by 80" wide. Use the Projection Calculator to get screen dimensions on all common aspect ratios.
Dichroic	A mirror or lens that reflects or refracts selective wavelengths of light. Typically used in projector light engines to separate the lamps "white" light into red, green, and blue light.
DICOM	A DICOM projector (Digital Imaging and Communications in Medicine) provides the medical profession with the ability to simulate 21 different levels of grayscale in the rendering of X-rays, CAT scans, MRIs and other medical imaging applications.
DisplayPort	DisplayPort is a digital display interface developed by the VESA. The interface is primarily used to connect a video source to a display device such as a computer monitor, though it can also be used to transmit audio, USB, and other forms of data. Displayport can be used to transmit audio and video simultaneously. The DisplayPort signal is not directly compatible with DVI or HDMI but passive adapters can be used to adjust the signal levels and convert the connector style.

Term	Description
Distortion	A usually undesirable variation from an intended output caused by the characteristics of a particular device.
Dithering	Method of displaying intermediate colours that don't exist in a limited palette by using a pattern of small dots out of that palette.
DLP	DLP (Digital Light Processing) is a commercial name for a display technology from Texas Instruments® (TI). The technology inside is often referred to as DMD (Digital Micro-Mirrors). It consists of an array of mirrors where each mirror represents a pixel element. For example, a high-definition DLP projector or rear projector with 1920 x 1080 pixel resolution would have over 2 million tiny mirrors. Each mirror is attached to an electronically driven hinge that controls the amount of coloured light that is reflected from the mirror into the projection lens and onto a screen. Projection systems using DLP technology use 1 to 3 DMD devices.
DMD	Digital Micromirror Device. Name of the actual imaging chip used in a Texas Instruments DLP projection systems.
DNR	Digital Noise Reduction. A system that reduces picture noise by comparing previous frames to the present and smoothing out what appears to be noise to the algorithm. Helps reduce flickering in still parts of a video image.
Document Camera	A document camera can be attached to any projector; however, there are projectors that integrate these features either as a camera on an arm that is attached to the projector or a document scanner that is built into the body of the projector.
Dolby Digital	A lossy compression system to deliver sound on DVDs, ATSC and DBS broadcasts in up to 5.1 channels. Also called AC-3. See AC-3.
Dolby EX	Backwards compatible system to add a sixth channel used for the middle rear playback to Dolby Digital (AC-3) making it 6.1 or 7.1 sound. 7.1 sound uses an additional center rear speaker playing back a duplicate track. Needs a Dolby EX decoder. See AC-3.
Dolby Pro Logic	An analog 4 channel surround sound system with left, right, center channels and a mono rear channel, typically duplicated across 2 speakers. Rear channel is limited to 7KHz and system stores all channels in a matrix recording on 2 discrete analog channels. Has difficulty playing back non-encoded material at full fidelity.
Dolby Pro Logic II	Updated version of Pro Logic. Offers better performance with playing back non-encoded sources over a surround sound system with full spatial cues and fidelity.
Downconvert	To convert a higher resolution signal to a lower resolution. For example, 720p to 480p.
DTV	Digital Television. A system that uses digital signals instead of analog including the ATSC standards, DBS and digital cable.
Dual Lamp	A Dual Lamp projector has two lamps where one lamp either serves as an automatic backup to the other lamp or is preprogrammed to switch at specific intervals. The benefit of this type of lamp system is it significantly reduces the probability of lamp failure during use.
DVI	Digital Visual Interface. DVI is a standard that defines the digital interface between digital devices such as projectors, flatscreens and personal computers. For devices that support DVI, a digital-to-digital connection can be made that eliminates the conversion to analog and thereby delivers an unblemished image. It can also carry an analog signal and comes as DVI-I (integrated - analog and digital), DVI-D (digital only) and DVI-A (analog only). Dual link DVI connections add additional resolution capabilities. Specifications on DVI are available at www.ddwg.org .
Dynamic Range	The ratio between the highest and lowest levels a device can perform. For a video device it is a measure of contrast ratio. For an audio device it is usually stated in dB.

Glossary

Term	Description
Edge Blending	When more than one projector is used side by side to project wider content into a seamless wide image, Edge Blending technology can be used. Edge blending can be done in the projector or with an external video processor. Edge blending works to remove the bright visible band that occurs when two images overlap. Edge blending will gradually fade out one of the images in the banded zone while the adjacent image is gradually faded up.
Edge Enhancement	A technique used to increase apparent resolution by increasing contrast around object edges. Usually counterproductive with already high-resolution sources and can become a source of image distortion.
EMI	Electro-Magnetic Interference.
Fill Rate	Given as a percentage, this characteristic indicates how smooth an image will look viewing a particular display. An imaging system with a low fill rate will exhibit a screen door pattern in its images.
Focal Length	The distance from the surface of a lens to its focal point.
Foot-Lambert (fL)	Measurement of luminance (brightness) emitted from a surface. One foot-Lambert is equal to one lumen per square foot. The metric equivalent of one foot-Lambert is 3.426259 nits or cd/m ² . The SMPTE standard for theater cinema is 16 fL.
Form Factor	A general description of a projector or flat panel's size and shape. For example, a light projector with a small case can be said to have a small form factor, and would be good for mobile presentation. Similarly, a flat panel that is slim and wall mountable would be considered to have a small form factor.
FPS	Frames Per Second.
Frame	A frame is one complete video image. When all lines of the video image are delivered sequentially, it is called progressive video. When the odd lines and even lines are delivered as separate fields, it is called interlace video.
Frame Interpolation	Frame interpolation, also called motion interpolation, is a video processing technique in which two sequential frames of video are analyzed for motion shifts that occur between Frame A and Frame B. Intermediate frames are then created and inserted between A and B to estimate incremental steps in the movement. The objective is to reduce motion blur and judder in order to achieve a cleaner and more stable video image.
Front Projection	A system where the projector sits in front of the screen with the image getting reflected back to the audience.
Full HD 3D	A projector that is Full HD 3D compatible can use any of the 3D formats enabled in the HDMI 1.4 3D specification: frame packing, top/bottom, or side-by-side. These projectors are compatible with the 1080p 3D signal from a Blu-ray player, set-top box, or other HDMI 1.4 device, but may not be compatible with 120Hz frame sequential 3D from a computer.
Full On/Off Contrast	Contrast is the ratio between white and black. The larger the contrast ratio the greater the ability of a projector or flat panel to show subtle colour details and tolerate extraneous room light. There are two methods used: 1) Full On/Off contrast measures the ratio of the light output of an all white image (full on) and the light output of an all black (full off) image. 2) ANSI contrast is measured with a pattern of 16 alternating black and white rectangles. The average light output from the white rectangles is divided by the average light output of the black rectangles to determine the ANSI contrast ratio. When comparing contrast ratio, make sure you are comparing the same type of contrast. Full On/Off contrast will always be a larger number than ANSI contrast for a given product.
Gamma	Relationship between input video voltage and output brightness. Determines how mid-tones appear as eye sensitivity is non-linear and display devices use different methods to account for this as well as their own display characteristics.

Term	Description
Gamma Correction	Adjustment to gamma or how gray levels between black and white are displayed as the eye is sensitive to these in a logarithmic manner. For example, good gamma correction allows subtle shadow detail in a dark image to be easily perceived.
Gauge	Wire thickness measure. The lower the gauge, the larger the wire.
Geometry	Characteristic of a display to accurately show an image without distorting it. When a display's geometry is good, it represents square objects as a square, etc. See pincushioning and barrel distortion.
Geometry Correction	Geometry Correction (sometimes referred to as Image Warping) is the process of digitally distorting a projected image so that it precisely matches a specific projection surface or shape. Image geometry correction compensates for the distortion created by off-axis projector or screen placement or non-flat screen surface, by applying a pre-compensating inverse distortion to that image in the digital domain.
Ghosting	A faint duplicate image, usually offset from primary image. Can be caused by multipath, which is a delayed, attenuated duplicate signal bounced off an object to an antenna or other interference.
Gray Scale	A table of shading devoid of colour, progressing from black to white. The number of discernible gray levels defines the colour resolution of the display device and is used to evaluate colour acuity and contrast.
HDBaseT®	HDBaseT® is an international standard for the transmission of ultra-high-definition video & audio, Ethernet, controls, USB and up to 100W of power over a single cable, for up to 100 meters. HDBaseT® eliminates cable clutter without compromising performance and high quality. The connector is typically a RJ48 8 pin Ethernet jack.
HDCP	HDCP (High-bandwidth Digital Content Protection) is a method for protecting copyrighted digital content that uses the DVI (Digital Visual Interface) or HDMI (High-Definition Multimedia Interface, previously known as DVI-CE) by encrypting its transmission between the video source such as a set-top box, DVD player, or computer and the digital display device such as a projector, monitor or television. To view digital HDCP protected content, both the sending and receiving device must support HDCP.
HDMI	<p>HDMI (High Definition Multimedia Interface) is an uncompressed, all-digital audio/video interface that supports audio/video sources such as a set-top box, DVD player, A/V receiver, and video monitors such as a digital projector or digital television (DTV). HDMI is backward compatible with DVI 1.0 specification and supports HDCP.</p> <p>HDMI supports standard, enhanced, or high-definition video, plus multi-channel digital audio, and interactive controls on a single cable. It transmits all ATSC (Advanced Television Systems Committee) HDTV standards and supports 8-channel digital audio. First product releases using HDMI occurred in 2003.</p>
HDR	High Dynamic Range (HDR) yields higher overall contrast than Standard Dynamic Range (SDR). Deeper blacks and brighter highlights result in a longer tonal scale that can render detail in shadows and highlights that tends to get lost in SDR. HDR systems generally come with wider colour gamuts for greater potential colour accuracy.
HDTV	High-Definition Television. Generic term that indicates a higher resolution format than previous standards. At present, denotes anything higher than a 480p signal. Most common formats are 720p, 1080i and 1080p.
HDTV capable	A television that supports 720p or 1080i or higher resolutions and has a built-in HDTV tuner for off-air reception of HD signals from a special antenna. To view cable and satellite HDTV programming, a cable set-top-box or satellite receiver is required.

Glossary

Term	Description
HDTV ready	A television that supports 720p or 1080i or higher resolutions and does not have a built-in HDTV tuner for off-air reception of HD signals from a special antenna. To view cable and satellite HDTV programming, a cable set-top-box or satellite receiver is required.
Horizontal Lens Shift	The purpose of Lens Shift is to eliminate keystone and provide greater flexibility in the placement of the projector relative to the screen. Lens shift may be a manual adjustment or motorized. Horizontal lens shift typically allows the projector to be placed anywhere between right and left edge of the projection screen and may also be used to geometrically align images when stacking projectors. Vertical lens shift is also available on some projectors.
Horizontal Resolution	Amount of pixels across an image, from left to right. A 1920 x 1080 HDTV has a horizontal resolution of 1920 pixels.
Horizontal Scan Rate	Period of time it takes to refresh an image on a screen, usually measured in Hertz (cycles per second). Computer monitors typically have scan rates starting at 60Hz going to 85Hz.
Hue	Hue or tint is the parameter of colour that allows us to distinguish between colours.
Hz	Hertz. Also called cycles per second and in video displays is the rate at which an image is refreshed.
IEEE 1394	Also called FireWire or iLink. A serial bus which can address up to 63 devices, communicating at up to 400Mbps but is limited to a cable length of 4.5 meters. Its content copy protection scheme is called DTCP or 5C. Most DV camcorders have a IEEE 1394 port as well as D-VHS VCRs and some set-top boxes for cable and satellite.
Infra-red Remote	An infra-red (IR) remote control transmits in the spectrum of infra-red light, such as a television remote. Unlike RF remotes, IR remotes must point at the receiver (line of sight) or reflect the IR from the screen to the receiver. Most projectors have an IR sensor in both the front and rear of the projector, whereas, flatpanels generally have a single IR sensor in the front of the unit. When working at or near the maximum distance, pointing right at the receiver will give better results.
Input Lag	Input lag is the delay between your video source sending a frame to your projector and the projector actually displaying that frame. This is a very important aspect of gaming, where an input lag of 40ms or less is preferred.
Interactive Projector	Interactive projectors became popular in 2010 and come in many variations. This technology encompasses any solution that enables active participation by the user with the projected content, rather than just the passive viewing of content. Typically the presenter is allowed to interact with either the projected image, the projector, or in some cases another device, using either an electronic pen, a mechanical pen or even a finger. These Interactive Projectors essentially create an electronic whiteboard on any surface where the image is projected allowing the presenter to interact with the projected image using a stylus that may be electronic or mechanical. Some interactive projectors allow user generated information to be captured and replayed, printed, or copied with or without the original projected image.
Interlaced	A process where a video image is delivered in two fields each containing half the video image rather than a single frame that contains the entire image. The first field contains all the odd lines and the second field contains all the even lines. For example, each 480i frame is made up of two fields of 263 and 262 lines of resolution and updated at 60Hz. 480 denotes the active picture area; however, the total frame size is actually 525 lines. 480i and 1080i are interlaced signals whereas 720p is a progressive signal where each video image is delivered in a single frame. Interlaced video was introduced with the first televisions because of bandwidth limitations.

Term	Description
Invert Image	Invert image flips the image from top to bottom, to compensate for ceiling mounting a projector upside down. Projectors typically ceiling-mount upside down, because most have a built-in offset that allows you to mount the screen at a comfortable height, yet still project an image without tilting the projector and causing keystone distortion.
ISF	Imaging Science Foundation. Organization that trains and accredits display calibration technicians as well as certifies display hardware. Designs standard testing and calibration procedures and tools.
Jaggy	The stair-step or sawtooth effect seen on lines that are not horizontal or vertical or the edge of objects in digital displays. Also known as aliasing. Smoothing and antialiasing techniques can reduce the effect of aliasing.
Jitter	Abrupt variations in signal amplitude or timing that cause reproduction instability in audio, video and data. Usually caused by bandwidth limitations or impedance termination issues that can sometimes be caused by the cable and/or connections you are using. Power supplies can also be a source of this problem.
JPEG	Joint Photographic Experts Group. Name of association that created the image file standard of the same name. A lossy compression scheme for storing high quality, full-colour images. Also used as a video format under the guise M-JPEG of which a variant is used for DV video.
Judder	Apparent stutter of on-screen movement. Motion judder in film is due to the fact that the 24 frame/second sampling rate is too slow to resolve camera panning motion. Judder is also caused by 3:2 pulldown where movie frames are on screen for differing times due to frame rate translations. Also occurs on PAL to NTSC conversions.
Kensington Lock	A security device found on projectors and other electronic equipment that allows the equipment to be secured by key or combination to another object using a rubberized cable.
Keystone	Keystoning occurs when the projector is not perpendicular to the screen, thereby creating an image that is not rectangular.
Keystone Correction	Keystone correction makes a projected image rectangular. This can be accomplished by positioning the projector to be perpendicular to the screen. Since this is not always possible, most projectors are equipped with keystone correction that allows the image to be keystone corrected (made rectangular) by adjusting optics, making mechanical adjustments, or applying digital scaling to the image. Keystone correction can be one or two dimensional and manual or automatic depending on the projector and the manufacturer. Be aware that digital scaling will introduce some artifacts that are more evident when viewing small text and less evident in presentation type material or video.
Latency	The time between a device being requested to do something and the start of the device actually doing it. It's a measurement usually used for LCDs where the shorter the latency the better. NISTC requires a latency of no more than 16ms in order to update the screen in time without leaving a ghost of the previous image.
LCD	Liquid Crystal Display. A display device for generating colour images using a matrix of LCD pixel elements. Each pixel element consists of 3 sub-pixels and an RGB colour filter of red (R), green (G), and blue (B). By controlling the voltage to each sub-pixel of an LCD, each cluster of RGB pixels can create a full spectrum of coloured light. LCDs are used in flatscreen displays, cameras and notebook computers to name a few. Nearly every projector made with LCD technology uses 3 separate LCDs, one each for red, green and blue. Light from the projector lamp is separated into RGB with a set of dichroic mirrors. The three light beams (RGB) are passed through separate LCDs and recombined to project a colour image.
LCoS	Liquid Crystal on Silicon. Type of LCD panel that reflects light as opposed to blocking it. Usually offers a comparatively high fill rate creating a smooth image but generally has difficulty giving a high contrast ratio.

Glossary

Term	Description
LED	Light Emitting Diode. A light generating technology that uses a semiconductor diode that emits monochromatic (single colour) light when charged. LEDs are used in remote controls that are used to control electronic devices such as large displays. They are also used in pocket projectors as a light source, large outdoor electronic displays, and as indicators on electronic devices such as power supplies and cameras.
LED Lamp	A type of projector lamp that uses one or more LEDs as its light source. The benefit of LED lamps is their long life.
Lens Memory	The ability to define and recall specific zoom lens positions so the projector can automatically configure subject matter of a given aspect ratio to a particular screen. This requires a projector with a powered zoom lens. Lens memory is often used to automatically set a zoom lens to fill a 2.4:1 format screen when displaying a 2.4 format film, then reset the lens to allow 16:9 aspect ratio material to fit the vertical height of the screen. Lens memory is typically used as a substitute for an anamorphic lens.
Lens Shift	The purpose of "lens shift" is to eliminate keystone correction and provide greater flexibility in the placement of the projector relative to the screen or the alignment of stacked projectors. This is accomplished by allowing the optical lens to be physically shifted vertically and/or horizontally. These adjustments may be manual or motorized depending on the projector. See horizontal lens shift and vertical lens shift for typical adjustment ranges.
Letterbox	A method of preserving the originally aspect ratio of a production when presented on a projector with a different aspect ratio. This is accomplished by showing the full image and black where no image exists.
Linearity	A display's ability to show an image's geometric characteristics accurately. Also called geometric linearity.
Long Throw Lens	A long throw lens allows greater distance between the projector and the screen while being able to maintain the image size and brightness of a shorter throw lens for any given projector. Depending on the room, a long throw lens may be required due to mounting constraints nearer the projected image.
Lumen	A measurement unit of total illumination. Typically a 100-watt light bulb outputs 1700 lumens over a wide area. Projector light output is measured in ANSI lumens. A projector with a higher lumen number will produce a brighter image for a given image size. See ANSI Lumens
Luminance	The black and white part of a video signal. It is signified by the letter Y. Signals with a separated luminance and colour signal avoid interference. This interference can result in dot crawl among other image artifacts.
Lux	A standard for measuring light equal to the amount of visible light per square meter incident on a surface. 1 lux = 1 lumen/square meter or 0.093 foot-candles.
M1-DA	A DVI connector that supports analog, digital video, a USB connection, and FireWire (IEEE1394). Used primarily with InFocus projectors. M1-DA (EVC or P&D) is 3 rows or 10 pins and looks a lot like the DVI-I except for 6 more pins. The maximum video resolution supported is 1280x1024. Maximum Distance Sometimes used to refer to the distance from the screen that a projector can focus the image. Most of the time, it is the manufacturer's opinion of how far from a screen the projector can be to cast an image that is useable (bright enough) in a fully darkened room. Consult the Projection Calculator for guidance on proper placement of a projector for a given screen and content.
Maximum Image Size	The largest image a projector can reasonable throw in a darkened room. Consult the Projection Calculator for guidance on proper placement of a projector for a given screen and content.

Term	Description
Maximum Resolution	Maximum Resolution refers to the highest resolution that a given display device can support. If the Maximum Resolution exceeds the Native Resolution, the image is usually scaled to match or approximate the Native Resolution of the projector. Some display devices allow pan and scan where rather than scaling the image, the display devices allows you to use the native resolution of the display to view portions of the higher resolution image. Scaling reduces the image resolution and produces some artifacts in the image that are more apparent when viewing text than graphics or video.
Memory Card	A feature on some projectors that allows photos, documents and/or presentation material to be projected using a memory card and thereby eliminating the need of a computer.
MHL (Mobile High-Definition Link)	Mobile High-Definition Link (MHL) is an industry standard for a mobile audio/video interface that lets you connect mobile devices such as smartphones and tablets to projectors and other HD video displays. MHL is a consortium made up of major companies in the consumer electronics industry, including SONY, Nokia, Samsung, Silicon Image, and Toshiba.
MHz	Megahertz. One million hertz or cycles per second.
Minimum Distance	The closest position that a projector can focus an image onto a screen.
Monitor Loophrough	An output on the projector or large-screen monitor that allows you to connect additional monitors or projectors to display the same image. Also known as "RGB out" or "VGA out."
Mono	Single channel sound.
Motion Artifacts	Any artifact caused by camera panning or object movement within video. Judder and combing are motion artifacts.
MPEG	Moving Picture Experts Group. A working group of ISO/IEC in charge of developing codecs and standards for moving pictures with synchronized audio.
Multi-Lamp	Some projectors use multiple lamps that can be controlled by the user to increase or decrease the brightness of the image. This lamp redundancy significantly minimizes the risk of total lamp failure during use. Another type of multi-lamp system is a Dual Lamp. With a dual lamp projector one lamp can serve as a backup to the other lamp in the event of failure or the lamps can be programmed to switch at specific intervals.
Native Aspect Ratio	Nearly every projector or display today will support multiple aspect ratios; however, each manufacturer must decide who their intended audience is and optimize the projector for that audience. This means each device has a native aspect ratio that is optimized for specific viewing material. Images shown in native aspect ratio will utilize the entire resolution of the display and achieve maximum brightness. Images shown in other than native aspect ratio will always have less resolution and less brightness than images shown in native aspect ratio.
Native Resolution	Native Resolution is the number of physical pixels in a display device. For example, an XGA display has a native resolution of 1024 physical pixels of resolution horizontally and 768 pixels vertically or 786,432 total pixels. See Maximum Resolution.
Negative Gain Screen	A screen with a gain rating of under 1 which actually reduces the amount of light reflected back from a projected image. Usually gray, they are used to increase apparent contrast by lowering the black level.
Noise	An unwanted random signal.
NSH	New Super High pressure projector lamp is a short arc metal halide lamp.
NTSC	National Television Standards Committee. Established the first colour TV standard in 1953 and is the North American standard for video and broadcasting. Also used in the Caribbean, South Korea, Japan and South America. A 30 fps signal with 525 lines of resolution of which 480 to 483 are viewable. Transmitted via a 6MHz channel.

Glossary

Term	Description
OEM	Original Equipment Manufacturer. A company that gathers components from other manufacturers and sells under their own name. An OEM version of a product is supported by the seller, not the actual manufacturer.
Ohm	Measure of electrical resistance, inductance or reactance.
OLED	Organic Light Emitting Diode. A self-illuminating, energy-efficient, direct-view imaging system. Uses an organic film sandwiched between 2 transparent electrodes.
Operate 24/7	Projectors that are identified as "Operate 24/7" means that the projector can operate continuously without a need to shutdown other than for maintenance.
Optical Digital Cable	Transfers digital signals as light pulses. Also called fibre-optic cable and is commonly used to send surround sound from a player to a receiver/decoder.
Optional Lenses	Typically the less expensive projectors come with a built-in lens that is designed to serve a specific type of setting or application. A projector that supports optional lenses can address a wide variety of installation needs. This gives a projector great flexibility at an incremental cost.
OSD	On Screen Display. Menu shown on display device screen allowing display adjustment without having dedicated physical controls such as knobs or buttons for each adjustable parameter.
Oversampling	Multiplies outgoing signal samples in order to more easily filter out aliased sounds but doesn't create fidelity that isn't there to begin with.
Overscan	Given as a percentage or pixel count, the amount that a particular display device crops the edges of an incoming video signal. This is done to ensure the image area contains only picture information.
Pan-and-Scan	A method to fit source material of a different resolution or aspect ratio onto another. Sometimes used with computer input when the input resolution exceeds the resolution of the display device. Used extensively for broadcast and DVDs, it simply crops the sides of widescreen material and the transfer operator chooses the best part of the frame to show. Often an electronic camera pan is used to change the area being shown. This is used when characters are talking to each other but one is off screen due to cropping and they become the focus of the shot.
PC 3D Ready	A projector that is PC 3D Ready can accept a 120Hz frame-sequential 3D signal from a computer via either NVIDIA's 3D Vision system or one of several educational software suites. These projectors are not compatible with the HDMI 1.4 3D specification used on 3D Blu-ray players and set-top boxes. This type of projector is also referred to as 3D Ready.
Persistence of Vision	The disposition of humans to amalgamate sequential still images into perceived motion. For most people, this occurs at around 16 fps.
Phase	The characteristic of when a wave is at its peak, trough, or zero point going up or down. Measured in degrees. Two sine waves of the same frequency that are 180 degrees out of phase will cancel each other out, yielding no signal.
Pico Projector	A marketing term to describe a small hand held projector that can fit in your pocket. A pico projector can be a stand-alone device that connects to a computer or other video device or a projection module that is integrated with a phone, portable computer, MP3 player or other small device.
Picture-in-picture	The ability of a projector (or any video display device) to display two independent video signals at once. One signal usually fills the main screen and the other is displayed in an inset window. Usually the audio from the image on the main screen is the default, and no audio is available on the inset picture.
Poly-Si (silicon) LCD	One of several projector display technologies. Monochrome Poly-Si LCDs are typically placed in each of the three colour (red, green, blue) light paths inside a projector to produce a colour image from a common light source. Poly-Si technology is a bit faster than the Active Matrix TFT providing slightly smoother video.

Term	Description
Power Focus	A motor driven lens that adjusts focus using a button on the projector's control panel and/or a remote control.
Power Output	With audio amplifiers, the amount of power sent to drive the speakers. Peak output is quite often specified, which is somewhat misleading compared to the average amount of power an amplifier can continuously produce (RMS rating).
Power Zoom	A zoom lens that is driven by a motor and controlled from the projector's control panel and/or remote control.
Pre-amp	A switching device used to select a line-level audio signal for amplification. Sometimes offers signal processing as well.
Progressive Scan	A display mode in which all the horizontal lines of an image are displayed at one time in a single frame, unlike an interlaced scan in which a frame consists of two separate fields with the first field consisting of odd horizontal lines and the second field even horizontal lines. Progressive scan is used by projectors, computer monitors, HDTV systems, and some digital camcorders. Progressive Scan requires a faster horizontal scan frequency than interlaced images of the same resolution
Projector	A projector is a device that integrates a light source, an optics system, electronics and display(s) for the purpose of projecting an image from a computer or video device onto a wall or screen for large image viewing. These devices attach to a computer or video device as you would connect a monitor or television.
QXGA	QXGA is a display resolution of 2048 horizontal pixels by 1536 vertical pixels giving a total display resolution of 3,145,728 pixels. A QXGA display has 4 times the resolution of an XGA display.
RCA Jacks	Unbalanced connection used extensively in consumer electronics to send a line-level signal. Also called phono.
Refresh Rate	The speed at which a display updates its picture given in Hz.
Resolution	A measure of the ability of a display or sound system to render detail.
RGB	Red, Green and Blue. A component signal representing each colour separately. Sync signals can be sent on green or sent separately as a composite signal or dual H/V signals (Horizontal sync/Vertical sync). Very common signal for analog computer displays.
RGB out	An output on the projector that allows you to connect additional monitors or projectors to display the same image. Also known as monitor loop-through or VGA out.
RS232	The RS232 port on a projector is typically used to connect an external control device like a wall plate controller or integrated whole room control system to your projector for turning it on and off remotely or changing the source input. The port is usually a male 9-pin D-sub connector.
S-Video	A video transmission standard that uses a 4 pin mini-DIN connector to send video information on two signal wires called luminance(brightness, Y) and chrominance(colour, C). S-Video is also referred to as Y/C. Considered a higher quality video source than composite video.
S/PDIF	Sony/Philips Digital InterFace. A transport protocol related to AES/EBU for sending PCM digital audio signals between devices. Uses either 75-Ohm coaxial cable or fiber-optic cable.
Sampling Frequency	The speed at which data representations of an analog signal are duplicated. The higher the number, the better the quality. Another quality aspect is the granularity of the scale used for representation where 16 bits allows 65536 discrete levels and 24 bits allows about 17 million.
Saturation	Saturation is a measure of colour intensity. In the absence of saturation the colour hue is a shade of grey. A highly saturated hue has a vivid, intense colour, while a less saturated hue appears more muted and grey.
Scan Rate	The line drawing speed of a display, usually given in kHz. A standard definition TV has a scan rate of 15.75 kHz which when you divide by 525 scan lines, gives a horizontal refresh rate of 30 fps or Hz.

Glossary

Term	Description
Screen Gain	As it applies to projectors, gain is the measurement of a projection screen's light reflectance with unity gain being one. A high gain screen will reflect more light along a narrower path than lower gain screen. Screen gains under one use a gray screen to absorb ambient light to help maintain contrast ratios.
Screen Trigger	A 12V connection from a projector to an electric screen which tells the screen to deploy when the projector is turned on and roll up when the projector is turned off.
SDI	Serial Digital Interface (SDI) is a standard for digital video transmission over coaxial cable. The most common data speed is 270 megabits per second (Mbps). However, speeds of up to 540 Mbps are theoretically possible. A related standard, known as high-definition serial digital interface (HD-SDI) provides a nominal data rate of 1.485 Gbit/s Standard 75-ohm cable is used.
SDTV	Standard Definition TeleVision. A class of digital television (DTV) that refers to the 480i format. 480i is an interlaced video format that produces a full frame of 480 lines of video in two successive fields. The first field includes the odd lines and the second field includes the even lines. Sometimes used to refer to regular television.
SECAM	Sequential Couleur avec Mémoire. A television standard closely related to PAL but with a different method of sending colour information. Runs at 625 horizontal lines of resolution updating 25 frames a second. Used in France and Russia as well as other countries. Many eastern European countries are starting to phase out SECAM in favor of PAL.
Shielded	A feature of speakers and cables where a metal layer is added to contain and protect a signal from creating or receiving electromagnetic interference.
Short Throw Lens	A lens designed to project a large image from a short distance.
Short Throw Projector	A projector with a short throw lens.
Short Throw Wall Mount Projector	A projector that mounts on a wall adjacent to the projection screen. The throw distance is generally just a few inches and allows people to move freely through the room without concern of intercepting the light path.
SHP	Super High Pressure. A type of projector lamp.
Signal-to-Noise Ratio	The ratio of noise to signal measured in dB. The higher the number, the better.
SPL	Sound Pressure Level. Commonly used to describe a speaker's efficiency at one watt at 1 meter distance. The actual amount of sound output using dB. There are various weightings used such as A, B or C which reflect the human ear's sensitivity at different sound levels. A-weighting is used for levels up to 55dB SPL, B-weighting from 55dB SPL to 85dB SPL and C-weighting for 85dB SPL up. A quiet office is 40dB SPL and a rock concert is 110dB SPL.
sRGB	sRGB stands for standard Red, Green, and Blue, and is a standard for rendering colour evenly across a variety of platforms.
Streaking	A visual artifact of trailing colours behind an on-screen object or across a screen.
Subpixel	On a flat-panel display, one of the primary colour picture elements of which 3 make up a full colour capable pixel.
SVGA	SVGA is a display resolution measuring 800 pixels horizontally by 600 pixels vertically giving a total display resolution of 480,000 individual pixels. SVGA has a 4:3 aspect ratio.
SXGA	SXGA is a display resolution measuring 1280 pixels horizontally by 1024 pixels vertically giving a total display resolution of 1,310,720 individual pixels. SXGA has a 5:4 aspect ratio.

Term	Description
TCO Certified Projectors	A TCO -labelled projector is certified to reproduce excellent images to a maximum projected image size, the TCO Image Size. In addition, the projector complies with stringent environmental requirements such as low energy consumption and minimal levels of environmentally hazardous substances. There is also an eco mode requirement so the projector can be set to lower luminosities, thus reducing noise, energy consumption and increasing the life of the bulb. The label also requires manufacturers to prove they are working proactively on environmental improvements to the production process and social responsibility issues.
Throw Distance	Throw distance is the measurement from the projector's lens to the screen. A projector with a zoom lens will have a range of throw distances for any given image size, while a projector without a zoom lens will only be able to project one image size at a given distance from the screen. In Projector Central's articles, throw distance is normally quoted for a 100" diagonal screen.
Throw Ratio	For any given projector, the width of the image (W) relative to the throw distance (D) is known as the throw ratio D/W. So for example, one of the most common projector throw ratio is 2.0. This means that for each foot of image width, the projector needs to be 2 feet away or $D/W = 2/1 = 2.0$.
Tint	Television control that varies the colour bias of an incoming video signal. Control needed due to colour variations in the NTSC signal caused by atmospheric conditions. Does not exist on PAL and SECAM televisions and adjustment should be unnecessary with directly linked video sources.
UHB	Ultra High Brightness. A projector lamp type.
UHF	Ultra High Frequency. The 300MHz to 3GHz band of radio frequencies used for broadcast television among other things including Wi-Fi .
UHP	Ultra High Pressure. An acronym attributed to projector lamps with an internal pressure of over 3000 lbs per square inch. Usually a mercury arc lamp. Also stands for Ultra High Performance.
Unbalanced	A type of wiring using ground as a shielding method. More susceptible to interference than balanced wiring.
Uniformity	A measurement of the evenness of the brightness of white or a particular colour across a display indicated as a percentage. A measurement of 80% means the brightness of an image is 20% less at its dimmest point compared to its brightest.
Unity Gain	A projection screen with a gain rating of one that reflects light with a wide viewing angle back to the viewer. See Gain.
Universal Remote	A remote control capable of running multiple components of multiple brands.
Upconvert	To convert a lower resolution signal to a higher resolution. For example, 480i to 720p.
UXGA	UXGA is a display resolution measuring 1600 pixels horizontally and 1200 pixels vertically giving a total display resolution of 1,920,000 individual pixels. UXGA has an aspect ratio of 4:3.
VBR	Variable Bit Rate. Refers to a variable data rate for encoding MPEG where picture quality is maintained but data rates change in accordance to the requirements of a video passage. Large amounts of movement and detail require higher data rates. VBR tends to create more space efficient MPEG files where picture quality is maintained but data rates change.
Vertical Lens Shift	The purpose of Lens Shift is to eliminate keystone and provide greater flexibility in the placement of the projector relative to the screen. Lens shift may be a manual adjustment or motorized depending on the projector. Vertical lens shift will typically allow the projector to be placed anywhere between 1.5 screen heights above or below the center of the projection screen and may also be used to geometrically align images when stacking projectors. Horizontal lens shift is also available on some projectors.
VGA	VGA is a display resolution measuring 640 horizontal pixels and 480 vertical pixels giving a total display resolution of 307,200 individual pixels. VGA has a 4:3 aspect ratio.

Glossary

Term	Description
VGA out	A 15-pin D-sub output on the projector that allows you to connect additional monitors or projectors to display the same image. Also known as monitor loop-through or RGB out.
Video Mirroring	An output connector on the projector that allows a monitor or another projector to share the same video source.
Volt	A measurement of electrical pressure.
Watt	A unit of power. Volts multiplied by amperage equals watts.
White Level	The signal level that corresponds to the maximum picture brightness. The white level is set by the contrast control.
Wi-Fi	Wi-Fi is Wireless Fidelity, and is a type of wireless network used to connect digital devices without the need for cables. It is mostly used for wireless broadband access and inexpensive consumer wireless antennas are available at electronics stores.
Widescreen	Any aspect ratio that is wider than 4:3. Widescreen televisions are 16 units wide and 9 units tall. Common widescreen film aspect ratios are 1.66:1, 1.85:1 and 2:35:1.
WMA	Windows Media Audio. Similar to MP3 but considered a more efficient compressor allowing for smaller file sizes for a given quality.
WSXGA	WSXGA defines a class of SXGA displays with a width resolution sufficient to create an aspect ratio of 16:9. A WSXGA display has 1920 to 1600 pixels horizontally and 1080 to 900 pixels vertically.
WXGA	WXGA defines a class of XGA displays with a width resolution sufficient to create an aspect ratio of 16:9. A WXGA display has 1366 to 1280 pixels horizontally and 768 to 720 pixels vertically.
XGA	XGA is a display resolution measuring 1024 pixels horizontally and 768 pixels vertically giving a total display resolution of 786,432 individual pixels. XGA has a 4:3 aspect ratio.
XLR	Balanced connection for audio components and used professionally.
XviD	A free and open source MPEG-4 video codec that was created by a group of volunteer programmers trying to overcome the closed source and platform limitations of DivX (XviD spelled backwards).
Y/C	Denotes a separated luminance/chrominance signal. Also called S-video. Offers higher resolutions and no cross interference between colour and black and white (luminance) signals which shows itself as dot crawl.
Y/Cb/Cr	Digital component video. Y stands for the luma signal itself and Cb is the blue signal subtracted from luma and finally, Cr equals the red signal subtracted from the luma signal.
Y/Pb/Pr	Analog component video. Y stands for the luma signal itself and Pb is the blue signal subtracted from luma and finally, Pr equals the red signal subtracted from the luma signal.
Zoom Lens	A lens with a variable focal length providing the ability to adjust the size of a projected image without moving the projector or provide a range of projector placements that can produce the same size image. See Zoom Ratio.
Zoom Ratio	Zoom ratio is the ratio between the smallest and largest image a lens can project from a fixed distance. For example, a 1.4:1 zoom lens ratio means that a 10 foot image without zoom would be a 14 foot image with full zoom. Conversely, a 10 foot diagonal image at 15 feet with no zoom would still be a 10 image at 21 feet at maximum zoom (15 x 1.4 = 21 feet). A zoom lens is "not as bright" as a fixed lens, and the higher the ratio, the less light output.

Getting help and contacting InFocus

Self help resources

The projector has a number of built-in help topic menus that allow you to navigate through the steps to resolve most standard issues. Details of each of these screens and the topics they address are detailed below. The help menu can be accessed by pressing the “HELP” button on the keypad to navigate through the menus and topics by following the onscreen instructions.

Please also refer to the more detailed Q&A section of the product users guide.

1. Image quality troubleshooting

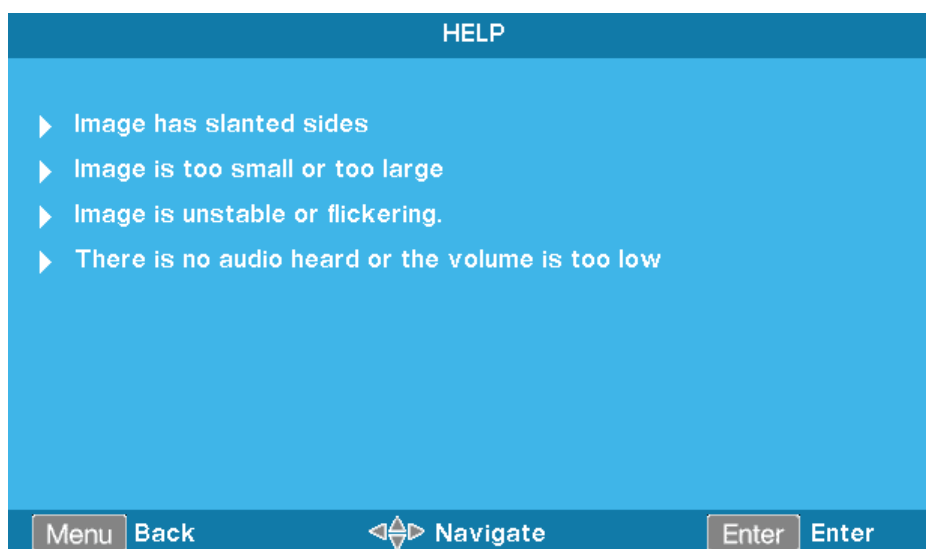

1a. Image slanted

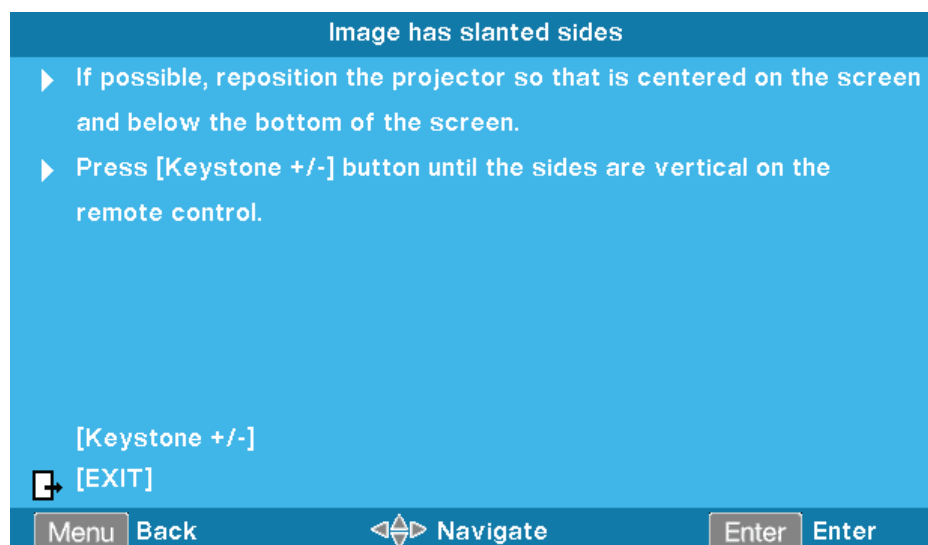

1b. Image size adjustment

Image is too small or too large

- ▶ Adjust the Zoom Ring on the top of the projector.
- ▶ Move the projector closer to or further from the screen.
- ▶ Press [Menu] button on the remote control or projector panel, go to Display | Format and try the different settings.

[DISPLAY | Format]

[EXIT]

Menu Back Navigate Enter Enter

1c. Image stability

Image is unstable or flickering.

- ▶ Use [Phase / Frequency] to correct it.
- ▶ Change the monitor colour setting on your computer.

[Phase]

[Frequency]

[EXIT]

Menu Back Navigate Enter Enter

1d. Audio troubleshooting

There is no audio heard or the volume is too low

- ▶ Is the volume setting at the minimum?
- ▶ Turn up the volume setting.
- ▶ Is the cable connected properly to the projector?
- ▶ Check the physical connection and ensure the cable is connected properly from the source to projector.

[Volume]

[EXIT]

Menu Back Navigate Enter Enter

2. No image troubleshooting

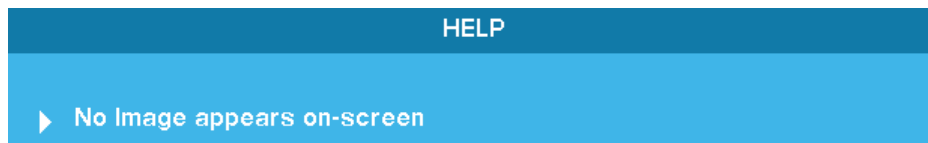

2a. No image on screen

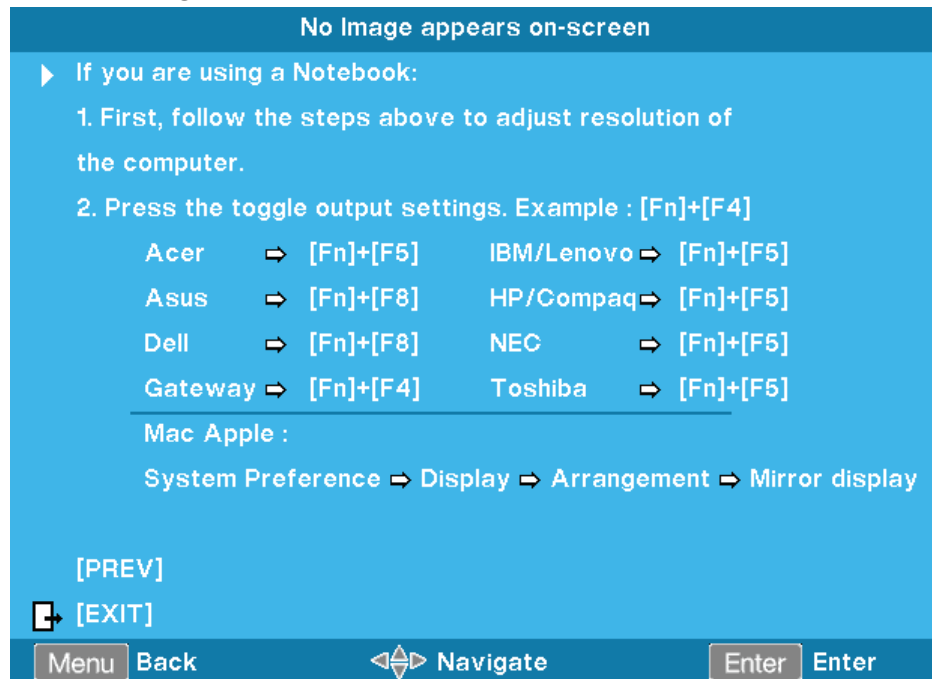

2b. No image on screen

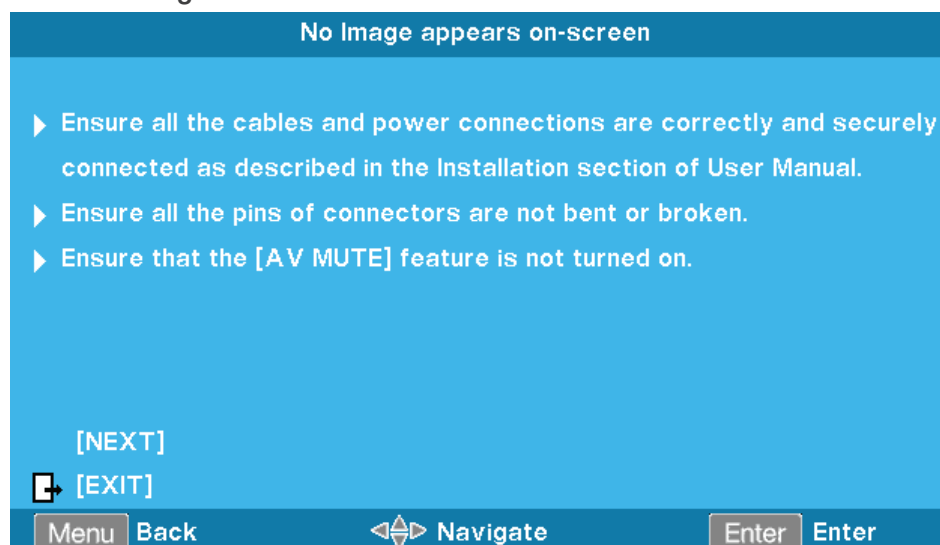

Contacting InFocus

InFocus technical support can be contacted at the below phone numbers within the stated operating hours, by using the enquiry form links provided or by visiting infocus.com and clicking on the chat support icon found on every page.

US & Canada

Mon-Fri | 6:00am - 5:00pm PST



United States

☎ 877-388-8360



Canada

☎ 877-388-8360

Technical support enquiry

Europe, Middle-East & Africa

Mon-Fri | 08:00 - 17:00 CET



Austria

☎ 0800 4636287



France

☎ 0800 905993



Germany

☎ 0800 1813649



Italy

☎ 0800 877238



Sweden

☎ 020 791251



Spain

☎ 0900 993163



Switzerland

☎ 0800 04636287



UK & Northern Ireland

☎ 0800 0286470



European Union

☎ +8000 463 6287

Technical Support Enquiry

Asia-Pacific region

Mon-Fri | 08:00 - 17:00 Local Time



Australia

+1300-577-321



India

+91 044-22252042
+91 044-42015277/89

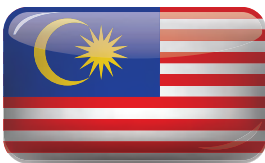

Malaysia

+607-3535133
+603-80708889



New Zealand

+64 008000 463-6287



Singapore

+65 93387857

Technical support enquiry



Portland, Oregon Home of InFocus Corporation

Regional & country specific notices

Disposing of your used product

In the European Union

EU-wide legislation as implemented in each Member State requires that used electrical and electronic products carrying the mark (below) must be disposed of separately from normal household waste. This includes projectors and their electrical accessories. When you dispose of such products, please follow the guidance of your local authority and/or ask the shop where you purchased the product.

After collecting the used products, they are reused and recycled in a proper way. This effort will help us reduce the waste as well as the negative impact to the human health and the environment at the minimum level.

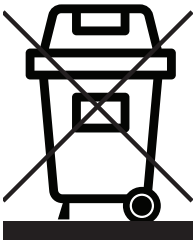

The mark on the electrical and electronic products only applies to the current European Union Member States.

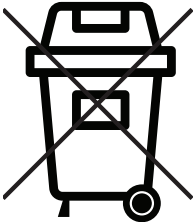

The crossed-out wheeled bin implies that used batteries should not be put to the general household waste!

There is a separate collection system for used batteries, to allow proper treatment and recycling in accordance with legislation.

According to the EU directive 2006/66/EC, the batteries can't be disposed improperly. The battery shall be separated to collect by local service.

Outside the European Union

If you wish to dispose of used electrical and electronic products outside the European union, please contact your local authority and ask for the correct method of disposal.

Californian residence

WARNING TO CALIFORNIA RESIDENTS:

Handling the cables supplied with this product will expose you to lead, a chemical known to the State of California to cause birth defects or other reproductive harm.

WASH HANDS AFTER HANDLING.

RF interference (for USA only)

Warning

The Federal Communications Commission does not allow any modifications or changes to the unit EXCEPT those specified by InFocus Corporation in this manual. Failure to comply with this government regulation could void your right to operate this equipment. This equipment has been tested and found to comply with the limits for a Class B digital device, pursuant to Part 15 of the FCC Rules. These limits are designed to provide reasonable protection against harmful interference in a residential installation. This equipment generates, uses, and can radiate radio frequency energy and, if not installed and used in accordance with the instructions, may cause harmful interference to radio communications. However, there is no guarantee that interference will not occur in a particular installation.

If this equipment does cause harmful interference to radio or television reception, which can be determined by turning the equipment off and on, the user is encouraged to try to correct the interference by one or more of the following measures:

- ⑤ Reorient or relocate the receiving antenna.
- ⑤ Increase the separation between the equipment and receiver.
- ⑤ Connect the equipment into an outlet on a circuit different from that to which the receiver is connected. • Consult the dealer or an experienced radio / TV technician for help.

Turkish RoHS information relevant for Turkish market

EEE Yönetmeliğine Uygundur.

This device is not intended for use in the direct field of view at visual display workplaces. To avoid incommoding reflections at visual display workplaces this device must not be placed in the direct field of view.

Lamps

US Residents

The lamp in this product contains mercury. Please dispose according to Local, State or Federal Laws.

Canadian Environmental Protection Act, 1999

The lamp(s) in this product contains mercury. Please dispose according to your local authority law.

FOR MORE INFORMATION, CONTACT

InFocus Corporation infocus.com

Notices

Warning

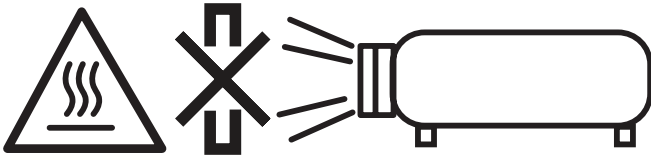

- ⓘ Do not cover the lens with the lens cap or equivalent while the projector is on. Doing so can lead to melting of the cap due to the heat emitted from the light output.
- ⓘ Do not place any objects, which are easily affected by heat, in front of the projection window. Doing so could lead to the object melting from the heat that is emitted from the light output.
- ⓘ Do not use a spray containing flammable gas to get rid of accumulated dust and dirt on the filters and the projection window. It may cause of fire.
- ⓘ Do not look at the lens while the projector is on. Serious damage to your eyes could result.

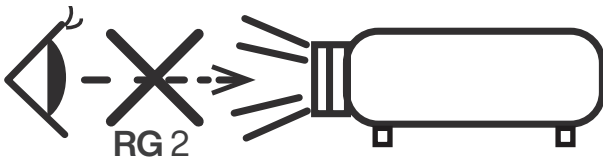

Manufacturer and EU importer in accordance with EU directives

Manufacturer: InFocus Corporation
13190 SW 68th Parkway, Suite 120
Portland,
Oregon 97223
United States

EU Importer: InFocus International B.V.
Kingsfordweg 103
1043 GP Amsterdam,
The Netherlands

Compliance statements for acoustic noise

Machine Noise Information Regulation - 3. GPSGV,

The highest sound pressure level is less than 70 dB (A) in accordance with EN ISO 7779.

FCC compliance statement

TRADE NAME:	DLP Projector
MODEL NUMBER:	IN112AA; IN119AA; IN112BB; IN114BB; IN113AA; IN114AA; IN115AA; V11; IN116AA; IN117AA; V13; IN118AA; IN188AA; IN199AA; IN113BB; IN115BB; IN116BB; IN117BB; IN118BB; IN188BB; IN119BB; IN199BB; IN114BBST; IN115BBST; V31; IN116BBST; IN117BBST; IN118BBST; IN188BBST; P130; P131; P132
COMPLIANCE TEST REPORT NUMBER:	ISL-20LE411FB
COMPLIANCE TEST REPORT DATE:	June 10, 2020
RESPONSIBLE PARTY (IN USA):	InFocus Corporation
ADDRESS:	13190 SW 68th Parkway, Suite 120 Portland, Oregon 97223 United States
TELEPHONE:	+1 503 2074700

This device complies with part 15 of the FCC Rules. Operation is subject to the following two conditions: (1) This device may not cause harmful interference, and (2) this device must accept any interference received, including interference that may cause undesired operation.

This equipment has been tested and found to comply with the limits for a Class B digital device, pursuant to Part 15 of the FCC rules as documented in the above referenced test report. These limits are designed to provide reasonable protection against harmful interference in a residential installation. This equipment generates, uses, and can radiate radio frequency energy and, if not installed and used in accordance with the instructions, may cause harmful interference to radio communications.

This equipment referenced in this declaration is identical to the unit tested and found acceptable with the standards. The technical records maintained by the responsible party continue to reflect the equipment being produced under this Declaration of Conformity within the variation that can be expected due to quantity production and testing on a statistical basis.

Date: October 1, 2020
InFocus Corporation

Restriction of use

When this product is used for applications requiring high reliability/safety, such as transportation devices related to aviation, rail, marine, automotive, disaster prevention devices; various safety devices, or functional/precision devices, you should use this product only after giving consideration to including fail-safes and redundancies into your design to maintain safety and total system reliability. Because this product was not intended for use in applications requiring extremely high reliability/safety, such as aerospace equipment, main communication equipment, nuclear power control equipment, or medical equipment related to direct medical care, etc., please make your own judgment on this product's suitability after a full evaluation.

Copyright notice

All rights reserved. No part of this publication may be reproduced, stored in a retrieval system, or transmitted in any form or by any means, electronic, mechanical, photocopying, recording, or otherwise, without the prior written permission of InFocus Corporation. The information contained herein is designed only for use with the InFocus products listed. InFocus is not responsible for any use of this information as applied to other products.

Neither InFocus Corporation nor its affiliates shall be liable to the purchaser of this product or third parties for damages, losses, costs, or expenses incurred by purchaser or third parties as a result of: accident, misuse, or abuse of this product or unauthorized modifications, repairs, or alterations to this product, or (excluding the U.S.) failure to strictly comply with InFocus Corporation's operating and maintenance instructions.

InFocus Corporation shall not be liable for any damages or problems arising from the use of any options or any consumable products other than those designated as Original InFocus Products or InFocus Approved Products by InFocus Corporation.

InFocus Corporation shall not be held liable for any damage resulting from electromagnetic interference that occurs from the use of any interface cables other than those designated as InFocus approved Products by InFocus Corporation.

Copyright attribution

Information is subject to change without notice.

© 2020 InFocus Corporation

Document No. 10000001 -EN

InFocus

RS232 Setting				Model Name	IN12BB	IN18BB	IN16BB	IN18DD	Notes
Baud Rate: 9600, Data Bits: 8, Parity: None, Stop Bits: 1, Flow Control: None, UART 16550 PFC: Disable Projector Return (Pass): P, Projector Return (Fail): F XX= 00-99 (Projector's ID), XX= 00 is for all projectors Note: 1. There is a <CR> after all ASCII commands 2. 00 is the HEX code for <CR> in ASCII code				IN12AA IN14AA/V11 IN16AA/V13 IN18AA IN19AA (w/o RS232)	IN12BB IN14BB IN14BBS1/V31	IN18BB IN18BBS1	IN16BB IN16BBS1 IN19BB	IN18DD	
SEND to Projector									
Index	ASCII Code	Command Set	Function	Value / Range	Support (Yes/No)				Notes
S001	--X00 1	7E 30 30 30 30 20 31 0D	Power	On	No	Yes	Yes	Yes	
	--X00 0	7E 30 30 30 30 20 30 0D		Off (0/2 for backward compatible)	No	Yes	Yes	Yes	
S002	--X00 1~nnnn	7E 30 30 30 30 20 31 20 a 0D	Power ON with Password ~nnnn	nnnn = Password -0000 (a=7E 30 30 30 30) -9999 (a=7E 39 39 39 39)	No	Yes	Yes	Yes	
S003	--X01 1	7E 30 30 30 31 20 31 0D	Reajync		No	Yes	Yes	Yes	
S004	--X02 1	7E 30 30 30 32 20 31 0D	AV Mute	On	No	Yes	Yes	Yes	
	--X02 0	7E 30 30 30 32 20 30 0D		Off (0/2 for backward compatible)	No	Yes	Yes	Yes	
S005	--X03 1	7E 30 30 30 33 20 31 0D	Mute	On	No	Yes	Yes	Yes	
	--X03 0	7E 30 30 30 33 20 30 0D		Off (0/2 for backward compatible)	No	Yes	Yes	Yes	
S006	--X04 1	7E 30 30 30 34 20 31 0D	Freeze	On	No	Yes	Yes	Yes	
	--X04 0	7E 30 30 30 34 20 30 0D		Off (0/2 for backward compatible)	No	Yes	Yes	Yes	
S007	--X05 1	7E 30 30 30 35 20 31 0D	Zoom Plus		No	Yes	Yes	Yes	
S008	--X06 1	7E 30 30 30 36 20 31 0D	Zoom Minus		No	Yes	Yes	Yes	
S009	--X11 0	7E 30 30 31 20 30 0D	IR Function	Off	No	Yes	Yes	Yes	
	--X11 1	7E 30 30 31 20 31 0D		On	No	Yes	Yes	Yes	
S010	--X12 5	7E 30 30 31 32 20 35 0D	Direct Source Commands	VGA	No	Yes	Yes	Yes	
	--X12 9	7E 30 30 31 32 20 39 0D		S-Video	No	Yes	Yes	Yes	
	--X12 10	7E 30 30 31 32 20 31 30 0D		Video	No	No	No	No	
	--X12 11	7E 30 30 31 32 20 31 0D		HDMI (HDMI 1)	No	Yes	Yes	Yes	
	--X12 15	7E 30 30 31 32 20 31 35 0D		HDMI 2	No	Yes	Yes	Yes	
	--X20 1	7E 30 30 32 30 20 31 0D		Presentation	No	Yes	Yes	Yes	
	--X20 2	7E 30 30 32 30 20 32 0D		Bright	No	Yes	Yes	Yes	
	--X20 3	7E 30 30 32 30 20 33 0D		Movie (Cinema)	No	Yes	Yes	Yes	
	--X20 4	7E 30 30 32 30 20 34 0D		sRGB	No	Yes	Yes	Yes	
	--X20 13	7E 30 30 32 30 20 31 33 0D		DICOM SIM.	No	Yes	Yes	Yes	
S011	--X20 5	7E 30 30 32 30 20 35 0D	Picture Mode	User	No	Yes	Yes	Yes	
	--X20 9	7E 30 30 32 30 20 39 0D		3D	No	Yes	Yes	Yes	
	--X20 14	7E 30 30 32 30 20 31 34 0D		ISF Day	No	Yes	Yes	Yes	
	--X20 15	7E 30 30 32 30 20 31 35 0D		ISF Night	No	Yes	Yes	Yes	
	S012	--X21 n		7E 30 30 32 31 20 a 0D	Brightness	n = -50 (a=2D 35 30) - 50 (a=35 30)	No	Yes	Yes
S013	--X22 n	7E 30 30 32 32 20 a 0D	Contrast	n = -50 (a=2D 35 30) - 50 (a=35 30)	No	Yes	Yes	Yes	
S014	--X23 n	7E 30 30 32 33 20 a 0D	Sharpness	n = 1 (a=31) - 15 (a=31 25)	No	Yes	Yes	Yes	
S015	--X24 n	7E 30 30 32 34 20 a 0D	RGB Gain/Bias Red Gain	n = -50 (a=2D 35 30) - 50 (a=35 30)	No	Yes	Yes	Yes	
S016	--X25 n	7E 30 30 32 35 20 a 0D	RGB Gain/Bias Green Gain	n = -50 (a=2D 35 30) - 50 (a=35 30)	No	Yes	Yes	Yes	
S017	--X26 n	7E 30 30 32 36 20 a 0D	RGB Gain/Bias Blue Gain	n = -50 (a=2D 35 30) - 50 (a=35 30)	No	Yes	Yes	Yes	
S018	--X27 n	7E 30 30 32 37 20 a 0D	RGB Gain/Bias Red Bias	n = -50 (a=2D 35 30) - 50 (a=35 30)	No	Yes	Yes	Yes	
S019	--X28 n	7E 30 30 32 38 20 a 0D	RGB Gain/Bias Green Bias	n = -50 (a=2D 35 30) - 50 (a=35 30)	No	Yes	Yes	Yes	
S020	--X29 n	7E 30 30 32 39 20 a 0D	RGB Gain/Bias Blue Bias	n = -50 (a=2D 35 30) - 50 (a=35 30)	No	Yes	Yes	Yes	
S021	--X34 n	7E 30 30 33 34 20 a 0D	BrilliantColor™	n = 1 (a=30) - 10 (a=31 30)	No	Yes	Yes	Yes	
S022	--X35 1	7E 30 30 33 35 20 31 0D	Gamma	Film	No	Yes	Yes	Yes	
	--X35 2	7E 30 30 33 35 20 32 0D		Video	No	Yes	Yes	Yes	
	--X35 3	7E 30 30 33 35 20 33 0D		Graphics	No	Yes	Yes	Yes	
	--X35 4	7E 30 30 33 35 20 34 0D		Standard (2.2)	No	Yes	Yes	Yes	
	--X35 5	7E 30 30 33 35 20 35 0D		18	No	Yes	Yes	Yes	
	--X35 6	7E 30 30 33 35 20 36 0D		2.0	No	Yes	Yes	Yes	
	--X35 12	7E 30 30 33 35 20 31 0D		2.4	No	Yes	Yes	Yes	
	--X36 1	7E 30 30 33 36 20 34 0D		Warm	No	Yes	Yes	Yes	
S023	--X36 2	7E 30 30 33 36 20 31 0D	Colour Temp.	Medium	No	Yes	Yes	Yes	
	--X36 3	7E 30 30 33 36 20 32 0D		Cold	No	Yes	Yes	Yes	
	--X37 1	7E 30 30 33 37 20 31 0D		Auto	No	Yes	Yes	Yes	
S024	--X37 2	7E 30 30 33 37 20 32 0D	Colour Space	RGB (0-255)	No	Yes	Yes	Yes	
	--X37 3	7E 30 30 33 37 20 33 0D		YUV	No	Yes	Yes	Yes	
	--X37 4	7E 30 30 33 37 20 34 0D		RGB(16 - 235)	No	Yes	Yes	Yes	
S025	--X44 n	7E 30 30 34 35 20 a 0D	Tint	n = -50 (a=2D 35 30) - 50 (a=35 30)	No	Yes	Yes	Yes	
S026	--X45 n	7E 30 30 34 34 20 a 0D	Colour (Saturation)	n = -50 (a=2D 35 30) - 50 (a=35 30)	No	Yes	Yes	Yes	
S027	--X60 1	7E 30 30 36 30 20 31 0D	Format (Aspect Ratio)	4:3	No	Yes	Yes	Yes	
	--X60 2	7E 30 30 36 30 20 32 0D		16:9	No	Yes	Yes	Yes	
	--X60 3	7E 30 30 36 30 20 33 0D		16:10	No	No	No	No	Only for WXGA/WUXGA
	--X60 5	7E 30 30 36 30 20 35 0D		LBX	No	No	Yes	Yes	Except for SVGA/XGA
	--X60 6	7E 30 30 36 30 20 36 0D		Native	No	Yes	Yes	Yes	
	--X60 7	7E 30 30 36 30 20 37 0D		Auto	No	Yes	Yes	Yes	
	S028	--X61 n		7E 30 30 36 31 20 a 0D	Edge mask	n = 0 (a=30) - 10 (a=31 30)	No	Yes	Yes
S029	--X62 n	7E 30 30 36 32 20 a 0D	Zoom	n = -5 (a=2D 35) - 25 (a=32 35)	No	Yes	Yes	Yes	
S030	--X63 n	7E 30 30 36 33 20 a 0D	H Image Shift	n = -100 (a=2D 31 30 30) - 100 (a= 31 30 30)	No	Yes	Yes	Yes	
S031	--X64 n	7E 30 30 36 34 20 a 0D	V Image Shift	n = -100 (a=2D 31 30 30) - 100 (a= 31 30 30)	No	Yes	Yes	Yes	
S033	--X66 n	7E 30 30 36 36 20 a 0D	V Keystone	RT: n = -40 (a=2D 34 30) - 40 (a=34 30) ST: n = -20 (a=2D 32 30) - 20 (a=32 30)	No	Yes	Yes	Yes	
S035	--X70 1	7E 30 30 37 30 20 31 0D	Language	English	No	Yes	Yes	Yes	English
	--X70 2	7E 30 30 37 30 20 32 0D		Deutsch	No	Yes	Yes	Yes	German
	--X70 3	7E 30 30 37 30 20 33 0D		Français	No	Yes	Yes	Yes	French
	--X70 4	7E 30 30 37 30 20 34 0D		Italiana	No	Yes	Yes	Yes	Italian
	--X70 5	7E 30 30 37 30 20 35 0D		Español	No	Yes	Yes	Yes	Spanish
	--X70 6	7E 30 30 37 30 20 36 0D		Português	No	Yes	Yes	Yes	Portuguese
	--X70 7	7E 30 30 37 30 20 37 0D		Polski	No	Yes	Yes	Yes	Polish
	--X70 8	7E 30 30 37 30 20 38 0D		Nederlands	No	Yes	Yes	Yes	Dutch
	--X70 9	7E 30 30 37 30 20 39 0D		Svenska	No	Yes	Yes	Yes	Swedish
	--X70 10	7E 30 30 37 30 20 31 30 0D		Norsk/Dansk	No	Yes	Yes	Yes	Norwegian/Danish
	--X70 11	7E 30 30 37 30 20 31 0D		Suomi	No	Yes	Yes	Yes	Finnish
	--X70 12	7E 30 30 37 30 20 31 32 0D		ελληνικά	No	Yes	Yes	Yes	Greek
	--X70 14	7E 30 30 37 30 20 31 34 0D		简体中文	No	Yes	Yes	Yes	Simplified Chinese
	--X70 17	7E 30 30 37 30 20 31 37 0D		Русский	No	Yes	Yes	Yes	Russian
	--X70 18	7E 30 30 37 30 20 31 38 0D		Magyar	No	Yes	Yes	Yes	Hungarian
	--X70 19	7E 30 30 37 30 20 31 39 0D		Čeština	No	Yes	Yes	Yes	Czechoslovak
	--X70 20	7E 30 30 37 30 20 32 30 0D		العربية	No	Yes	Yes	Yes	Arabic
	--X70 21	7E 30 30 37 30 20 32 31 0D		ไทย	No	Yes	Yes	Yes	Thai
	--X70 22	7E 30 30 37 30 20 32 32 0D		Türkçe	No	Yes	Yes	Yes	Turkish

RS232 Setting	Baud Rate: 9600, Data Bits: 8, Parity: None, Stop Bits: 1, Flow Control: None, UART 16550 PFC: Disable Projector Return (Pass): P, Projector Return (Fail): F XX= 00-99 (Projector's ID), XX= 00 is for all projectors Note: 1. There is a <CR> after all ASCII commands 2. 00 is the HEX code for <CR> in ASCII code	Model Name IN12AA IN144A/V11 IN16AA/V13 IN18AA IN19AA (w/o RS232)	IN12EB IN14EB IN14BSST1/V31	IN18BB IN18BSST	IN16BB IN16BSST IN19BB	IN18DD	Notes		
S036	--XX70 23	7E 30 30 37 30 20 32 33 0D	Projection	فارس	No	Yes	Yes	Yes	Farsi
	--XX70 24	7E 30 30 37 30 20 32 34 0D		हिंदी	No	Yes	Yes	Yes	Hindi
	--XX70 25	7E 30 30 37 30 20 32 35 0D		Tiếng Việt	No	Yes	Yes	Yes	Vietnamese
	--XX70 26	7E 30 30 37 30 20 32 36 0D		Bahasa Indonesia	No	Yes	Yes	Yes	Indonesian
	--XX70 27	7E 30 30 37 30 20 32 37 0D		Română	No	Yes	Yes	Yes	Romanian
	--XX70 29	7E 30 30 37 30 20 32 39 0D		Піліпін	No	Yes	Yes	Yes	Filipino
	--XX70 30	7E 30 30 37 30 20 33 30 0D		Melayu	No	Yes	Yes	Yes	Malay
	--XX70 31	7E 30 30 37 30 20 33 31 0D		বাংলা	No	Yes	Yes	Yes	Bengali
	--XX711	7E 30 30 37 31 20 31 0D		Front	No	Yes	Yes	Yes	
	--XX712	7E 30 30 37 31 20 32 0D		Rear	No	Yes	Yes	Yes	
	--XX713	7E 30 30 37 31 20 33 0D		Front-Ceiling	No	Yes	Yes	Yes	
--XX714	7E 30 30 37 31 20 34 0D		Rear-Ceiling	No	Yes	Yes	Yes		
S037	--XX72 1	7E 30 30 37 32 20 31 0D	Menu Location	Top Left	No	Yes	Yes	Yes	
	--XX72 2	7E 30 30 37 32 20 32 0D		Top Right	No	Yes	Yes	Yes	
	--XX72 3	7E 30 30 37 32 20 33 0D		Centre	No	Yes	Yes	Yes	
	--XX72 4	7E 30 30 37 32 20 34 0D		Bottom Left	No	Yes	Yes	Yes	
	--XX72 5	7E 30 30 37 32 20 35 0D		Bottom Right	No	Yes	Yes	Yes	
S038	--XX73 n	7E 30 30 37 33 20 a 0D	Signal Frequency	n = -5 (a=2D 35) - 5 (a=35) By signal	No	Yes	Yes	Yes	
S039	--XX74 n	7E 30 30 37 34 20 a 0D	Signal Phase	n = 0 (a=30) - 63 (a=36 33) By signal	No	Yes	Yes	Yes	
S040	--XX75 n	7E 30 30 37 35 20 a 0D	Signal H. Position	n = -5 (a=2D 35) - 5 (a=35) By timing	No	Yes	Yes	Yes	
S041	--XX76 n	7E 30 30 37 36 20 a 0D	Signal V. Position	n = -5 (a=2D 35) - 5 (a=35) By timing	No	Yes	Yes	Yes	
S042	--XX77 n	7E 30 30 37 37 20 aabbcc 0D	Security Security Timer Month/Day/Hour	n = mm/dd/hh mm=00 (aa=30 30) - 12 (aa=31 32) dd = 00 (bb=30 30) - 30 (bb=33 30) hh= 00 (cc=30 30) - 24 (cc=32 34)	No	Yes	Yes	Yes	
S043	--XX78 1 ~nmin	7E 30 30 37 38 20 31 0D	Security	On with password ~nmin = -0000 (a= 7E 30 30 30 30) ~9999 (a=7E 39 39 39 39) Off (0/2 for backward compatible) with password	No	Yes	Yes	Yes	Yes
	--XX78 0 ~nmin	7E 30 30 37 38 20 32 0 a 0D		~nmin = -0000 (a= 7E 30 30 30 30) ~9999 (a=7E 39 39 39 39)	No	Yes	Yes	Yes	Yes
S044	--XX79 n	7E 30 30 37 39 20 a 0D	Projector ID	n = 00 (a=30 30) - 99 (a=39 39)	No	Yes	Yes	Yes	
S045	--XX80 1	7E 30 30 38 30 20 31 0D	Mute	On	No	Yes	Yes	Yes	Yes
S045	--XX80 0	7E 30 30 38 30 20 30 0D		Off (0/2 for backward compatible)	No	Yes	Yes	Yes	Yes
S046	--XX81 n	7E 30 30 38 31 20 a 0D	Volume (Audio)	n = 0 (a=30) - 10 (a=31 30)	No	Yes	Yes	Yes	Yes
S048	--XX90 1	7E 30 30 39 31 20 31 0D	Screen Type (Only for WXGA/WUXGA)	16:10	No	No	No	Yes	No
	--XX90 0	7E 30 30 39 31 20 30 0D		16:9	No	No	No	Yes	No
S049	--XX91 1	7E 30 30 39 31 20 31 0D	Signal Automatic	On	No	Yes	Yes	Yes	Yes
	--XX91 0	7E 30 30 39 31 20 30 0D		Off	No	Yes	Yes	Yes	Yes
S050	--XX101 1	7E 30 30 31 30 31 20 31 0D	High Altitude	On	No	Yes	Yes	Yes	Yes
	--XX101 0	7E 30 30 31 30 31 20 30 0D		Off (0/2 for backward compatible)	No	Yes	Yes	Yes	Yes
S051	--XX102 1	7E 30 30 31 30 32 20 31 0D	Information Hide	On	No	Yes	Yes	Yes	Yes
	--XX102 0	7E 30 30 31 30 32 20 30 0D		Off (0/2 for backward compatible)	No	Yes	Yes	Yes	Yes
S052	--XX103 1	7E 30 30 31 30 33 20 31 0D	Keypad Lock	On	No	Yes	Yes	Yes	Yes
	--XX103 0	7E 30 30 31 30 33 20 30 0D		Off (0/2 for backward compatible)	No	Yes	Yes	Yes	Yes
S053	--XX104 0	7E 30 30 31 30 34 20 30 0D	Background Color	None	No	No	No	No	No
	--XX104 1	7E 30 30 31 30 34 20 31 0D		Blue	No	Yes	Yes	Yes	Yes
	--XX104 2	7E 30 30 31 30 34 20 32 0D		Black	No	Yes	Yes	Yes	Yes
	--XX104 3	7E 30 30 31 30 34 20 33 0D		Red	No	Yes	Yes	Yes	Yes
	--XX104 4	7E 30 30 31 30 34 20 34 0D		Green	No	Yes	Yes	Yes	Yes
	--XX104 5	7E 30 30 31 30 34 20 35 0D		White	No	Yes	Yes	Yes	Yes
S054	--XX105 1	7E 30 30 31 30 35 20 31 0D	Direct Power On	Logo	No	Yes	Yes	Yes	Yes
	--XX105 0	7E 30 30 31 30 35 20 30 0D		On	No	Yes	Yes	Yes	Yes
S055	--XX109 1	7E 30 30 31 30 39 20 31 0D	Lamp Reminder	On	No	Yes	Yes	Yes	Yes
	--XX109 0	7E 30 30 31 30 39 20 30 0D		Off (0/2 for backward compatible)	No	Yes	Yes	Yes	Yes
S056	--XX110 1	7E 30 30 31 31 30 20 31 0D	Brightness Mode	Bright	No	Yes	Yes	Yes	Yes
	--XX110 2	7E 30 30 31 31 30 20 32 0D		Eco	No	Yes	Yes	Yes	Yes
	--XX110 4	7E 30 30 31 31 30 20 34 0D		Dynamic	No	Yes	Yes	Yes	Yes
S057	--XX111 1	7E 30 30 31 31 31 20 31 0D	Lamp Reset	Yes	No	Yes	Yes	Yes	
S058	--XX113 1	7E 30 30 31 31 33 20 31 0D	Signal Power On	On	No	Yes	Yes	Yes	Yes
	--XX113 0	7E 30 30 31 31 33 20 30 0D		Off (0/2 for backward compatible)	No	Yes	Yes	Yes	Yes
S059	--XX106 n	7E 30 30 31 30 36 20 a 0D	Auto Power Off (min) * (5 minutes for each step.)	n = 0 (a=30) - 180 (a=31 38 30)	No	Yes	Yes	Yes	
S060	--XX107 n	7E 30 30 31 30 37 20 a 0D	Sleep Timer (min) * (30 minutes for each step.)	n = 0 (a=30) - 990 (a=39 39 30)	No	Yes	Yes	Yes	
S061	--XX112 1	7E 30 30 31 31 32 20 31 0D	Reset to Default Yes (P.S When security is off)	Yes with no password (Security is Off)	No	Yes	Yes	Yes	
S062	--XX112 1 ~nmin	7E 30 30 31 31 32 20 31 0D	Reset to Default Yes (P.S When security is On/ Off)	Yes with no password (Security is Off)	No	Yes	Yes	Yes	
S064	--XX115 1	7E 30 30 31 31 35 20 31 0D	Quick Resume	On	No	Yes	Yes	Yes	Yes
	--XX115 0	7E 30 30 31 31 35 20 30 0D		Off (0/2 for backward compatible)	No	Yes	Yes	Yes	Yes
S065	--XX140 10	7E 30 30 31 34 30 20 31 30 0D	IR Function	Up	No	Yes	Yes	Yes	Yes
	--XX140 11	7E 30 30 31 34 30 20 31 31 0D		Left	No	Yes	Yes	Yes	Yes
	--XX140 12	7E 30 30 31 34 30 20 31 32 0D		Enter (for Projection MENU)	No	Yes	Yes	Yes	Yes
	--XX140 13	7E 30 30 31 34 30 20 31 33 0D		Right	No	Yes	Yes	Yes	Yes
	--XX140 14	7E 30 30 31 34 30 20 31 34 0D		Down	No	Yes	Yes	Yes	Yes
	--XX140 15	7E 30 30 31 34 30 20 31 35 0D		Keystone +	No	Yes	Yes	Yes	Yes
	--XX140 16	7E 30 30 31 34 30 20 31 36 0D		Keystone -	No	Yes	Yes	Yes	Yes
	--XX140 17	7E 30 30 31 34 30 20 31 37 0D		Volume -	No	Yes	Yes	Yes	Yes
	--XX140 18	7E 30 30 31 34 30 20 31 38 0D		Volume +	No	Yes	Yes	Yes	Yes
	--XX140 19	7E 30 30 31 34 30 20 31 39 0D		Brightness	No	Yes	Yes	Yes	Yes
	--XX140 20	7E 30 30 31 34 30 20 32 30 0D		Menu	No	Yes	Yes	Yes	Yes
	--XX140 21	7E 30 30 31 34 30 20 32 31 0D		Zoom	No	Yes	Yes	Yes	Yes
	--XX140 28	7E 30 30 31 34 30 20 32 38 0D		Contrast	No	Yes	Yes	Yes	Yes
	--XX140 47	7E 30 30 31 34 30 20 34 37 0D		Source	No	Yes	Yes	Yes	Yes
--XX195 0	7E 30 30 31 39 35 20 30 0D	Off	No	Yes	Yes	Yes	Yes		

RS232 Setting		Model Name		Support (Yes/No)		Notes	
Baud Rate: 9600, Data Bits: 8, Parity: None, Stop Bits: 1, Flow Control: None, UART 16550 FIFO: Disable Projector Return (Pass): P, Projector Return (Fail): F XX= 00-99 (Projector's ID), XX= 00 is for all projectors Note: 1. There is a <CR> after all ASCII commands 2. 00 is the HEX code for <CR> in ASCII code		IN12AA IN114AA/V11 IN16AA/V13 IN18AA IN19AA (w/o RS232)		IN12BB IN14BB IN14BSST/V31	IN18BB IN18BBST	IN16BB IN16BBST IN19BB	IN18DD
S066	~XX195 1	7E 30 30 31 39 35 20 31 0D	Grid (Red)	No	Yes	Yes	Yes
	~XX195 2	7E 30 30 31 39 35 20 32 0D	White	No	Yes	Yes	Yes
	~XX195 3	7E 30 30 31 39 35 20 33 0D	Grid (Green)	No	Yes	Yes	Yes
S067	~XX195 4	7E 30 30 31 39 35 20 34 0D	Grid (Blue)	No	Yes	Yes	Yes
	~XX200 n	7E 30 30 32 30 30 20 a 0D	White level n = 0 (a=30) - 31 (a=33 31)	No	Yes	Yes	Yes
S068	~XX201 n	7E 30 30 32 30 31 20 a 0D	Black level n = -5 (a=2D 35) - 5 (a=35)	No	Yes	Yes	Yes
S069	~XX204 1	7E 30 30 32 30 34 20 31 0D	FE	No	Yes	Yes	Yes
	~XX204 0	7E 30 30 32 30 34 20 30 0D	7.5	No	Yes	Yes	Yes
S070	~XX210 n	7E 30 30 32 30 30 20 n 0D	Display message on the OSD n: 1-30 characters	No	No	No	No
S071	~XX215 1	7E 30 30 32 31 35 20 31 0D	Colour Setting	Reset	Yes	Yes	Yes
S072	~XX230 0	7E 30 30 32 33 30 20 30 0D	3D Mode	Off	Yes	Yes	Yes
	~XX230 1	7E 30 30 32 33 30 20 31 0D	DLP-Link	No	Yes	Yes	Yes
S073	~XX231 0	7E 30 30 32 33 31 20 30 0D	3D Sync Invert	Off	Yes	Yes	Yes
	~XX231 1	7E 30 30 32 33 31 20 31 0D	On	No	Yes	Yes	Yes
S074	~XX313 1	7E 30 30 33 31 33 20 31 0D	Information Menu	On	No	No	No
	~XX313 0	7E 30 30 33 31 33 20 30 0D	Off (0/2 for backward compatible)	No	No	No	No
S075	~XX320 1	7E 30 30 33 32 30 20 31 0D	Optional Filter Installed	Yes	No	No	No
	~XX320 0	7E 30 30 33 32 30 20 30 0D	No (0/2 for backward compatible)	No	No	No	No
S076	~XX322 0	7E 30 30 33 32 32 20 30 0D	Filter Reminder	Off	No	No	No
	~XX322 1	7E 30 30 33 32 32 20 31 0D	300hr	No	No	No	No
	~XX322 2	7E 30 30 33 32 32 20 32 0D	500hr	No	No	No	No
	~XX322 3	7E 30 30 33 32 32 20 33 0D	800hr	No	No	No	No
	~XX322 4	7E 30 30 33 32 32 20 34 0D	1000hr	No	No	No	No
S077	~XX323 1	7E 30 30 33 32 33 20 31 0D	Filter Reset	Yes	No	No	No
S078	~XX327 n	7E 30 30 33 32 37 20 a 0D	Colour Setting Red Hue n = -50 (a=2D 35 30) - 50 (a=35 30)	No	Yes	Yes	Yes
S079	~XX328 n	7E 30 30 33 32 38 20 a 0D	Colour Setting Green Hue n = -50 (a=2D 35 30) - 50 (a=35 30)	No	Yes	Yes	Yes
S080	~XX329 n	7E 30 30 33 32 39 20 a 0D	Colour Setting Blue Hue n = -50 (a=2D 35 30) - 50 (a=35 30)	No	Yes	Yes	Yes
S081	~XX330 n	7E 30 30 33 33 30 20 a 0D	Colour Setting Cyan Hue n = -50 (a=2D 35 30) - 50 (a=35 30)	No	Yes	Yes	Yes
S082	~XX331 n	7E 30 30 33 33 31 20 a 0D	Colour Setting Yellow Hue n = -50 (a=2D 35 30) - 50 (a=35 30)	No	Yes	Yes	Yes
S083	~XX332 n	7E 30 30 33 33 32 20 a 0D	Colour Setting Magenta Hue n = -50 (a=2D 35 30) - 50 (a=35 30)	No	Yes	Yes	Yes
S084	~XX333 n	7E 30 30 33 33 33 20 a 0D	Colour Setting Red Stutuation n = -50 (a=2D 35 30) - 50 (a=35 30)	No	Yes	Yes	Yes
S085	~XX334 n	7E 30 30 33 33 34 20 a 0D	Colour Setting Green Stutuation n = -50 (a=2D 35 30) - 50 (a=35 30)	No	Yes	Yes	Yes
S086	~XX335 n	7E 30 30 33 33 35 20 a 0D	Colour Setting Blue Stutuation n = -50 (a=2D 35 30) - 50 (a=35 30)	No	Yes	Yes	Yes
S087	~XX336 n	7E 30 30 33 33 36 20 a 0D	Colour Setting Cyan Stutuation n = -50 (a=2D 35 30) - 50 (a=35 30)	No	Yes	Yes	Yes
S088	~XX337 n	7E 30 30 33 33 37 20 a 0D	Colour Setting Yellow Stutuation n = -50 (a=2D 35 30) - 50 (a=35 30)	No	Yes	Yes	Yes
S089	~XX338 n	7E 30 30 33 33 38 20 a 0D	Colour Setting Magenta Stutuation n = -50 (a=2D 35 30) - 50 (a=35 30)	No	Yes	Yes	Yes
S090	~XX339 n	7E 30 30 33 33 39 20 a 0D	Colour Setting Red Gain n = -50 (a=2D 35 30) - 50 (a=35 30)	No	Yes	Yes	Yes
S091	~XX340 n	7E 30 30 33 34 30 20 a 0D	Colour Setting Green Gain n = -50 (a=2D 35 30) - 50 (a=35 30)	No	Yes	Yes	Yes
S092	~XX341 n	7E 30 30 33 34 31 20 a 0D	Colour Setting Blue Gain n = -50 (a=2D 35 30) - 50 (a=35 30)	No	Yes	Yes	Yes
S093	~XX342 n	7E 30 30 33 34 32 20 a 0D	Colour Setting Cyan Gain n = -50 (a=2D 35 30) - 50 (a=35 30)	No	Yes	Yes	Yes
S094	~XX343 n	7E 30 30 33 34 33 20 a 0D	Colour Setting Yellow Gain n = -50 (a=2D 35 30) - 50 (a=35 30)	No	Yes	Yes	Yes
S095	~XX344 n	7E 30 30 33 34 34 20 a 0D	Colour Setting Magenta Gain n = -50 (a=2D 35 30) - 50 (a=35 30)	No	Yes	Yes	Yes
S096	~XX345 n	7E 30 30 33 34 35 20 a 0D	Colour Setting White Red n = -50 (a=2D 35 30) - 50 (a=35 30)	No	Yes	Yes	Yes
S097	~XX346 n	7E 30 30 33 34 36 20 a 0D	Colour Setting White Green n = -50 (a=2D 35 30) - 50 (a=35 30)	No	Yes	Yes	Yes
S098	~XX347 n	7E 30 30 33 34 37 20 a 0D	Colour Setting White Blue n = -50 (a=2D 35 30) - 50 (a=35 30)	No	Yes	Yes	Yes
S099	~XX348 1	7E 30 30 33 34 38 20 31 0D	Display Mode Lock	On	No	Yes	Yes
	~XX348 0	7E 30 30 33 34 38 20 30 0D	Off	No	Yes	Yes	Yes
	~XX400 0	7E 30 30 34 30 30 20 30 0D	3D	No	Yes	Yes	Yes
S100	~XX400 1	7E 30 30 34 30 30 20 31 0D	3D→2D	L	No	Yes	Yes
	~XX400 2	7E 30 30 34 30 30 20 32 0D	R	No	Yes	Yes	Yes
S101	~XX405 0	7E 30 30 34 30 35 20 30 0D	3D Format	Auto	No	Yes	Yes
	~XX405 1	7E 30 30 34 30 35 20 31 0D	SBS	No	Yes	Yes	Yes
	~XX405 2	7E 30 30 34 30 35 20 32 0D	Top and Bottom	No	Yes	Yes	Yes
	~XX405 3	7E 30 30 34 30 35 20 33 0D	Frame Sequential	No	Yes	Yes	Yes
S108	~XX506 0	7E 30 30 35 30 36 20 30 0D	Wall Colour	Whiteboard	No	Yes	Yes
	~XX506 1	7E 30 30 35 30 36 20 31 0D	Blackboard	No	Yes	Yes	Yes
	~XX506 2	7E 30 30 35 30 36 20 32 0D	Light Yellow	No	Yes	Yes	Yes
	~XX506 3	7E 30 30 35 30 36 20 33 0D	Light Green	No	Yes	Yes	Yes
	~XX506 4	7E 30 30 35 30 36 20 34 0D	Light Blue	No	Yes	Yes	Yes
	~XX506 5	7E 30 30 35 30 36 20 35 0D	Pink	No	Yes	Yes	Yes
S109	~XX511 0	7E 30 30 35 31 31 20 30 0D	HDMI Link(CEC)	Off (0/2 for backward compatible)	No	Yes	Yes
	~XX511 1	7E 30 30 35 31 31 20 31 0D	On	No	Yes	Yes	Yes

SEND from Projector Automatically

Index	Command Set		Function	Projector Return	Support (Yes/No)				Notes
	ASCII Code	HEX Code							
A001	N/A	N/A	Projector Information a=0, Standby a=1, Warning a=2, Cooling a=3, Out of Range a=4, Lamp Fail a=6, Fan Lock a=7, Over Temperature a=8, Lamp Hours Running Out	INFOa	No	Yes	Yes	Yes	Yes

RS232 Setting		Baud Rate:9600,Data Bits:8,Parity:None,Stop Bits:1,Flow Control:None,UART16550 PPO:Disable Projector Return (Pass):P,Projector Return (Fail):F XX= 00-99 (Projector's ID),XX= 00 is for all projectors Note: 1. There is a <CR> after all ASCII commands 2. 00 is the HEX code for <CR> in ASCII code		Model Name IN12AA IN14AA/V11 IN16AA/V13 IN18AA IN19AA (w/o RS232)	IN12BB IN14BB IN14BBS1/V31	IN18BB IN18BBS1	IN16BB IN16BBS1 IN19BB	IN18DD	Notes	
READ from Projector										
Index	Command Set		Function	Projector Return	Support (Yes/No)					Notes
	ASCII Code	HEX Code								
R002	--XX108 1	7E 30 30 31 30 38 20 31 0D	Lamp Hours aaaaa=[5 digits] Total Lamp Hours	Okaaaa	No	Yes	Yes	Yes	Yes	
R003	--XX121 1	7E 30 30 31 32 31 20 31 0D	Input Source Commands a=0, None a=1, HDMI (HDMI 1) a=5, VGA a=9, S-Video a=10, Video a=15, HDMI 2	Ok	No	Yes	Yes	Yes	Yes	
R004	--XX122 1	7E 30 30 31 32 32 20 31 0D	Software Version aaaa=Software Version	Okaaaa	No	Yes	Yes	Yes	Yes	
R005	--XX123 1	7E 30 30 31 32 33 20 31 0D	Display Mode a=0, None a=1, Presentation a=2, Bright a=3, Movie (Cinema) a=4, sRGB a=5, User a=9, 3D a=13, DICOM SIM. a=14, ISF Day a=15, ISF Night	Ok	No	Yes	Yes	Yes	Yes	
R006	--XX124 1	7E 30 30 31 32 34 20 31 0D	Power State a=0, Off a=1, On	Ok	No	Yes	Yes	Yes	Yes	
R007	--XX125 1	7E 30 30 31 32 35 20 31 0D	Brightness aaa= 50→150	Okaaa	No	Yes	Yes	Yes	Yes	
R008	--XX126 1	7E 30 30 31 32 36 20 31 0D	Contrast aaa= 50→150	Okaaa	No	Yes	Yes	Yes	Yes	
R009	--XX127 1	7E 30 30 31 32 37 20 31 0D	Aspect Ratio aa=0, None aa=1, 4:3 aa=2, 16:9 aa=3, 16:10 aa=5, LBX aa=6, Native aa=7, Auto	Okaa	No	Yes	Yes	Yes	Yes	
R010	--XX128 1	7E 30 30 31 32 38 20 31 0D	Color Temperature a=1, Warm a=2, Medium a=3, Cold	Ok	No	Yes	Yes	Yes	Yes	
R011	--XX129 1	7E 30 30 31 32 39 20 31 0D	Projection Mode a=0, Front a=1, Rear a=2, Front-Ceiling a=3, Rear-Ceiling a=4, Screen	Ok	No	Yes	Yes	Yes	Yes	
R012	--XX150 1	7E 30 30 31 35 30 20 31 0D	a=Power Status a=0, Power Off a=1, Power On bbbb=Lamp Hours cc=Input Source cc=00, None cc=01, HDMI (HDMI 1) cc=05, VGA cc=09, S-Video cc=10, Video cc=15, HDMI 2 dddd=Software Version ee=Display Mode eeee=OS Menu	Okabbbccdddeee	No	Yes	Yes	Yes	Yes	
R013	--XX150 4	7E 30 30 31 35 30 20 34 0D	Resolution a=string (e.g. Ok1920x1080)	Ok	No	Yes	Yes	Yes	Yes	No signal (a=Ok0x0)
R015	--XX150 19	7E 30 30 31 35 30 20 31 39 0D	Refresh rate a=string (e.g. Ok60Hz)	Ok	No	Yes	Yes	Yes	Yes	No signal (a=Ok0Hz)
R016	--XX151 1	7E 30 30 31 35 31 20 31 0D	Model Name a=1, SVGA a=2, XGA a=3, WXGA a=4, 1080p a=5, WUXGA	Ok	No	Yes	Yes	Yes	Yes	
R017	--XX108 1	7E 30 30 31 30 38 20 31 0D	Lamp Hours aaaaa=00000-99999	Okaaaaa	No	Yes	Yes	Yes	Yes	
R018	--XX321 1	7E 30 30 33 32 31 20 31 0D	Filter Usage Hours aaaaa=00000-99999	Okaaaaa	No	No	No	No	No	
R019	--XX352 1	7E 30 30 33 35 32 20 31 0D	System Temperature aaa=000-999	Okaaa	No	Yes	Yes	Yes	Yes	
R020	--XX353 1	7E 30 30 33 35 33 20 31 0D	Serial Number a=string	Ok	No	Yes	Yes	Yes	Yes	
R022	--XX355 1	7E 30 30 33 35 35 20 31 0D	AV Mute a=0, Off a=1, On	Ok	No	Yes	Yes	Yes	Yes	
R023	--XX356 1	7E 30 30 33 35 36 20 31 0D	Mute a=0, Off a=1, On	Ok	No	Yes	Yes	Yes	Yes	
R025	--XX543 1	7E 30 30 35 34 33 20 31 0D	H Image Shift aaaa= 100→100	Okaaaa	No	Yes	Yes	Yes	Yes	
R026	--XX543 2	7E 30 30 35 34 33 20 32 0D	V Image Shift aaaa= 100→100	Okaaaa	No	Yes	Yes	Yes	Yes	
R027	--XX543 3	7E 30 30 35 34 33 20 33 0D	V Keystone aaa= 40→40	Okaaa	No	Yes	Yes	Yes	Yes	
R028	--XX558 1	7E 30 30 35 35 38 20 31 0D	Projector ID aa=00-99	Okaa	No	Yes	Yes	Yes	Yes	
Note 1: --xx112 1-mnnn (n=mn = password) When security is on, you need to add password after command or it will return F.										
Note 2: When the projector show other OSD, user key the command "--XX313 0 7E 30 30 33 31 33 20 30 0D Information menu Off (0/2 for backward compatible)" then it will return F.										