



Table of Contents

| | | | |
|--|----|---|----|
| Table of Contents | 1 | <i>Setup </i> | |
| Usage Notice | 2 | <i>Audio Settings</i> | 44 |
| <i>Safety Information</i> | 2 | <i>Setup </i> | |
| <i>Precautions</i> | 3 | <i>Advanced</i> | 45 |
| <i>Eye Safety Warnings</i> | 6 | <i>Options</i> | 46 |
| Introduction | 7 | <i>Options Advanced</i> | 48 |
| <i>Package Overview</i> | 7 | <i>Options </i> | |
| <i>Product Overview</i> | 8 | <i>Lamp Settings</i> | 49 |
| <i>Main Unit</i> | 8 | <i>Options </i> | 50 |
| <i>Keypad</i> | 9 | <i>Optional Filter</i> | 50 |
| <i>Input/Output Connections</i> | 10 | <i>Settings</i> | 50 |
| <i>Remote Control</i> | 11 | Appendices | 51 |
| Installation | 12 | <i>Troubleshooting</i> | 51 |
| <i>Connecting to the Projector</i> | 12 | <i>Image Problems</i> | 51 |
| <i>Connecting a Computer/Notebook</i> | 12 | <i>Other Problems</i> | 53 |
| <i>Connecting a Video source</i> | 13 | <i>Remote Control Problems</i> | 53 |
| <i>Connect to 3D Video Devices</i> | 14 | <i>LED Lighting Messages</i> | 54 |
| <i>Using the 3D glasses</i> | 16 | <i>On Screen Messages</i> | 55 |
| <i>Powering On/Off the Projector</i> | 17 | <i>Replacing the Lamp</i> | 56 |
| <i>Powering On the Projector</i> | 17 | <i>Installing and Cleaning the Dust Filter</i> .. | 58 |
| <i>Powering Off the Projector</i> | 18 | <i>Compatibility Modes</i> | 59 |
| <i>Warning Indicator</i> | 19 | <i>Ceiling Mount Installation</i> | 61 |
| <i>Adjusting the Projected Image</i> | 20 | <i>Regulation & Safety Notices</i> | 62 |
| <i>Adjusting the Projector's Height</i> | 20 | <i>FCC Notice</i> | 62 |
| <i>Adjusting the Projector's Zoom / Focus</i> .. | 21 | <i>Declaration of Conformity for</i> | |
| <i>Adjusting Projection Image Size</i> | 21 | <i>EU countries</i> | 63 |
| User Controls | 23 | | |
| <i>Keypad & Remote Control</i> | 23 | | |
| <i>Keypad</i> | 23 | | |
| <i>Remote Control</i> | 24 | | |
| <i>On-screen Display Menus</i> | 30 | | |
| <i>How to operate</i> | 30 | | |
| <i>Menu Tree</i> | 31 | | |
| <i>Image</i> | 35 | | |
| <i>Image Advanced</i> | 37 | | |
| <i>Display</i> | 39 | | |
| <i>Display 3D</i> | 41 | | |
| <i>Setup</i> | 42 | | |

Safety Information

| | |
|---|---|
|  | The lightning flash with arrow head within an equilateral triangle is intended to alert the user to the presence of uninsulated "dangerous voltage" within the product's enclosure that may be of sufficient magnitude to constitute a risk of electric shock to persons. |
|  | The exclamation point within an equilateral triangle is intended to alert the user to the presence of important operating and maintenance (servicing) instructions in the literature accompanying the appliance. |

WARNING: TO REDUCE THE RISK OF FIRE OR ELECTRIC SHOCK, DO NOT EXPOSE THIS APPLIANCE TO RAIN OR MOISTURE. DANGEROUS HIGH VOLTAGES ARE PRESENT INSIDE THE ENCLOSURE. DO NOT OPEN THE CABINET. REFER SERVICING TO QUALIFIED PERSONNEL ONLY.

Class B emissions limits

This Class B digital apparatus meets all requirements of the Canadian Interference-Causing Equipment Regulations.

Important Safety Instruction

1. Do not block any ventilation openings. To ensure reliable operation of the projector and to protect from over heating, it is recommended to install the projector in a location that does not block ventilation. As an example, do not place the projector on a crowded coffee table, sofa, bed, etc. Do not put the projector in an enclosure such as a book case or a cabinet that restricts air flow.
2. Do not use the projector near water or moisture. To reduce the risk of fire and/or electric shock, do not expose the projector to rain or moisture.
3. Do not install near heat sources such as radiators, heaters, stoves or any other apparatus such as amplifiers that emit heat.
4. Clean only with dry cloth.
5. Only use attachments/accessories specified by the manufacturer.
6. Do not use the unit if it has been physically damaged or abused. Physical damage/abuse would be (but not limited to):
 - Unit has been dropped.
 - Power supply cord or plug has been damaged.
 - Liquid has been spilled on to the projector.
 - Projector has been exposed to rain or moisture.
 - Something has fallen in the projector or something is loose inside.Do not attempt to service the unit yourself. Opening or removing covers may expose you to dangerous voltages or other hazards. Please call InFocus before you send the unit for repair.
7. Do not let objects or liquids enter the projector. They may touch dangerous voltage points and short out parts that could result in fire or electric shock.
8. See projector enclosure for safety related markings.
9. The unit should only be repaired by appropriate service personnel.

Precautions



Please follow all warnings, precautions and maintenance as recommended in this user's guide.



❖ When the lamp reaches the end of its life, the projector will not turn back on until the lamp module has been replaced. To replace the lamp, follow the procedures listed under "Replacing the Lamp" section on pages 56-57.

■ ■ Warning-

Do not look into the projector's lens when the lamp is on. The bright light may hurt your eyes.

■ ■ Warning-

To reduce the risk of fire or electric shock, do not expose this projector to rain or moisture.

■ ■ Warning-

Please do not open or disassemble the projector as this may cause electric shock.

■ ■ Warning-

When replacing the lamp, please allow the unit to cool down. Follow instructions as described on pages 56-57.

■ ■ Warning-

This projector will detect the life of the lamp itself. Please be sure to change the lamp when it shows warning messages.

■ ■ Warning-

Reset the "Lamp Reset" function from the on-screen display "Options|Lamp Settings" menu after replacing the lamp module (refer to page 49).

■ ■ Warning-

When switching the projector off, please ensure the cooling cycle has been completed before disconnecting power. Allow 90 seconds for the projector to cool down.

■ ■ Warning-

When the lamp is approaching to the end of its life time, the message "Lamp life exceeded." will show on the screen. Please contact your local reseller or service center to change the lamp as soon as possible.

Usage Notice

Do:

- ❖ Turn off and unplug the power plug from the AC outlet before cleaning the product.
- ❖ Use a soft dry cloth with mild detergent to clean the display housing.
- ❖ Disconnect the power plug from AC outlet if the product is not being used for a long period of time.

Do not:

- ❖ Block the slots and openings on the unit provided for ventilation.
- ❖ Use abrasive cleaners, waxes or solvents to clean the unit.
- ❖ Use under the following conditions:
 - In extremely hot, cold or humid environments.
 - ▶ Ensure that the ambient room temperature is within 5°C ~ 40°C
 - ▶ Relative humidity is 10% ~ 85%
 - In areas susceptible to excessive dust and dirt.
 - Near any appliance generating a strong magnetic field.
 - In direct sunlight.

Viewing 3D projection using the 3D function

IMPORTANT SAFETY INFORMATION. READ THE FOLLOWING WARNINGS BEFORE YOU OR YOUR CHILD USE THE 3D FUNCTION.

Warning

- ❖ Children and teenagers may be more susceptible to health issues associated with viewing in 3D and should be closely supervised when viewing these images.

Photosensitive Seizure Warning and Other Health Risks

- ❖ Some viewers may experience an epileptic seizure or stroke when exposed to certain flashing images or lights contained in certain Projector pictures or video games. If you suffer from, or have a family history of epilepsy or strokes, please consult with a medical specialist before using the 3D function.
- ❖ Even those without a personal or family history of epilepsy or stroke may have an undiagnosed condition that can cause photosensitive epileptic seizures.

Usage Notice

- ❖ Pregnant women, the elderly, sufferers of serious medical conditions, those who are sleep deprived or under the influence of alcohol should avoid utilizing the unit's 3D functionality.
- ❖ If you experience any of the following symptoms, stop viewing 3D pictures immediately and consult a medical specialist: (1) altered vision; (2) light-headedness; (3) dizziness; (4) involuntary movements such as eye or muscle twitching; (5) confusion; (6) nausea; (7) loss of awareness; (8) convulsions; (9) cramps; and/or (10) disorientation. Children and teenagers may be more likely than adults to experience these symptoms. Parents should monitor their children and ask whether they are experiencing these symptoms.
- ❖ Watching 3D projection may also cause motion sickness, perceptual after effects, disorientation, eye strain and decreased postural stability. It is recommended that users take frequent breaks to lessen the potential of these effects. If your eyes show signs of fatigue or dryness or if you have any of the above symptoms, immediately discontinue use of this device and do not resume using it for at least thirty minutes after the symptoms have subsided.
- ❖ Watching 3D projection while sitting too close to the screen for an extended period of time may damage your eyesight. The ideal viewing distance should be at least three times the screen height. It is recommended that the viewer's eyes are level with the screen.
- ❖ Watching 3D projection while wearing 3D glasses for an extended period of time may cause a headache or fatigue. If you experience a headache, fatigue or dizziness, stop viewing the 3D projection and rest.
- ❖ Do not use the 3D glasses for any other purpose than for watching 3D projection. Wearing the 3D glasses for any other purpose (as general spectacles, sunglasses, protective goggles, etc.) may be physically harmful to you and may weaken your eyesight.
- ❖ Viewing in 3D projection may cause disorientation for some viewers. Accordingly, DO NOT place your 3D PROJECTOR near open stairwells, cables, balconies, or other objects that can be tripped over, run into, knocked down, broken or fallen over.

Eye Safety Warnings



- ■ Avoid staring/facing directly into the projector beam at all times. Keep your back to the beam as much as possible.
- ■ When projector is used in a classroom, adequately supervise students when they are asked to point out something on the screen.
- ■ In order to minimize the lamp power, use room blinds to reduce ambient light levels.

Introduction

Package Overview

Unpack and inspect the box contents to ensure all parts listed below are in the box. If something is missing, please contact InFocus customer service.

Standard Accessories

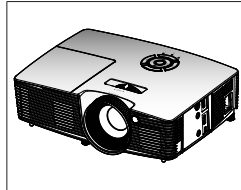

Projector

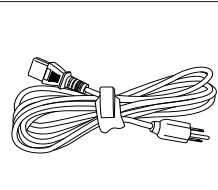

Power Lead

- CD User Manual
- Quick Start Card

Documentation

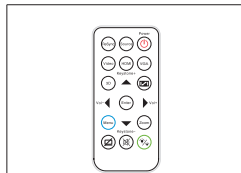

Remote

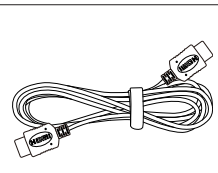

HDMI Cable

Introduction

Product Overview

Main Unit

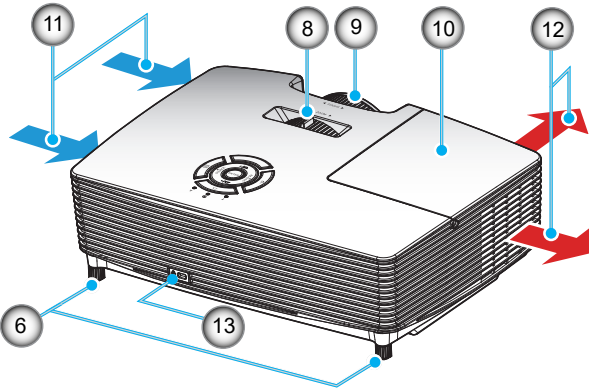
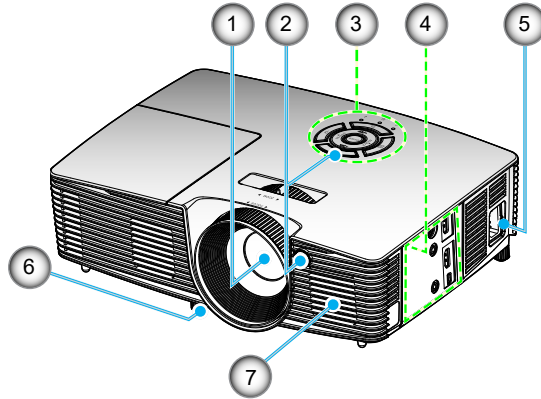

❖ Do not block projector in/out air vents.

- | | |
|-------------------------------|---------------------------|
| 1. Lens | 7. Speaker |
| 2. IR Receivers | 8. Zoom Lever |
| 3. Keypad | 9. Focus Ring |
| 4. Input / Output Connections | 10. Lamp Cover |
| 5. Power Socket | 11. Ventilation (inlet) |
| 6. Tilt-Adjustment Feet | 12. Ventilation (outlet) |
| | 13. Kensington™ Lock Port |

Keypad

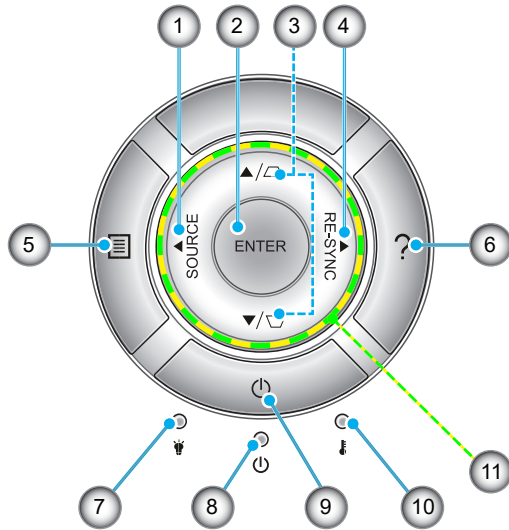

1. Source
2. Enter
3. Keystone Correction
4. Re-Sync
5. Menu
6. Help
7. Lamp LED
8. On/Standby LED
9. Power
10. Temperature LED
11. Four Directional Select Keys

Introduction

Input/Output Connections

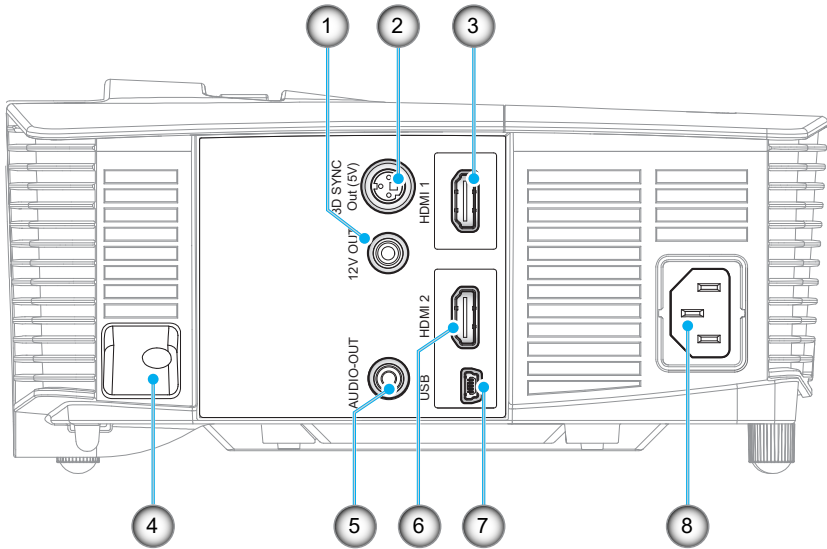

1. 12V Relay Trigger (12V, 250mA, 3.5mm mini jack)
2. 3D Sync Out (5V) connector
3. HDMI 1 connector
4. Security Bar
5. Audio Out connector (3.5mm mini jack)
6. HDMI 2 connector
7. USB-B mini connector (Firmware upgrade)
8. Power Socket



- ❖ Remote mouse requires special remote.

Remote Control



❖ The interface is subject to model's specifications.

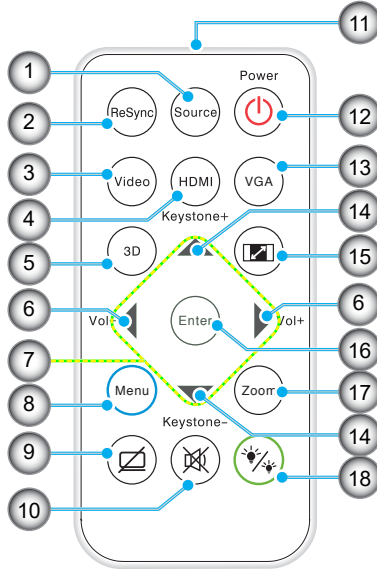

1. Source
2. Re-Sync
3. Video Not Available
4. HDMI
5. 3D
6. Volume +/-
7. Four Directional Select Keys
8. Menu
9. AV Mute
10. Mute
11. IR LED
12. Power On/Off
13. VGA Not Available
14. Keystone +/- and Remote Mouse function
15. Aspect
16. Enter and Enable Remote Mouse function
17. Zoom
18. Brightness Mode

Installation

Connecting to the Projector

Connecting a Computer/Notebook

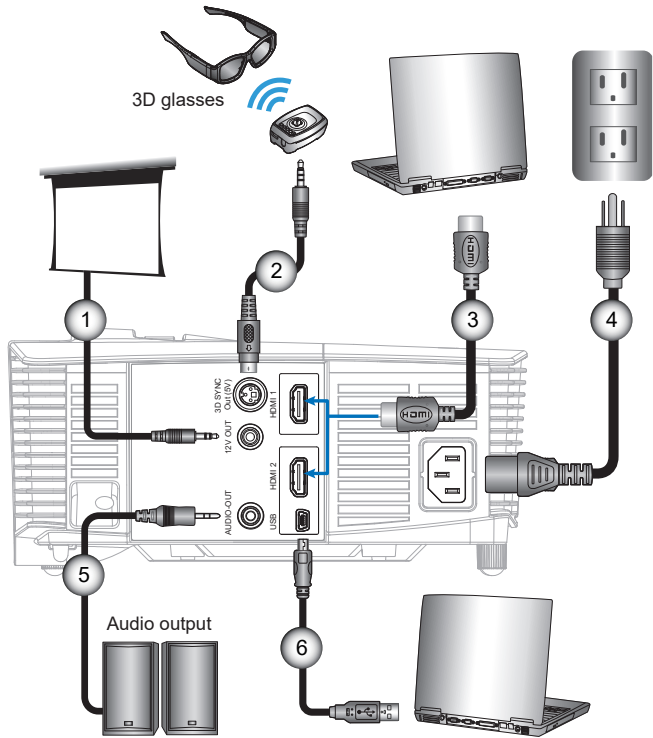

- ❖ Due to the difference in applications for each country, some regions may have different accessories.
- ❖ (*) Optional accessory

| | |
|--------|-------------------|
| 1..... | *12V DC plug |
| 2..... | *3D emitter cable |
| 3..... | HDMI cable |
| 4..... | Power cord |
| 5..... | *Audio out cable |
| 6..... | *USB cable |

Installation

Connecting a Video source

DVD player, Blu-ray player, Set-top box,
HDTV receiver, Games console

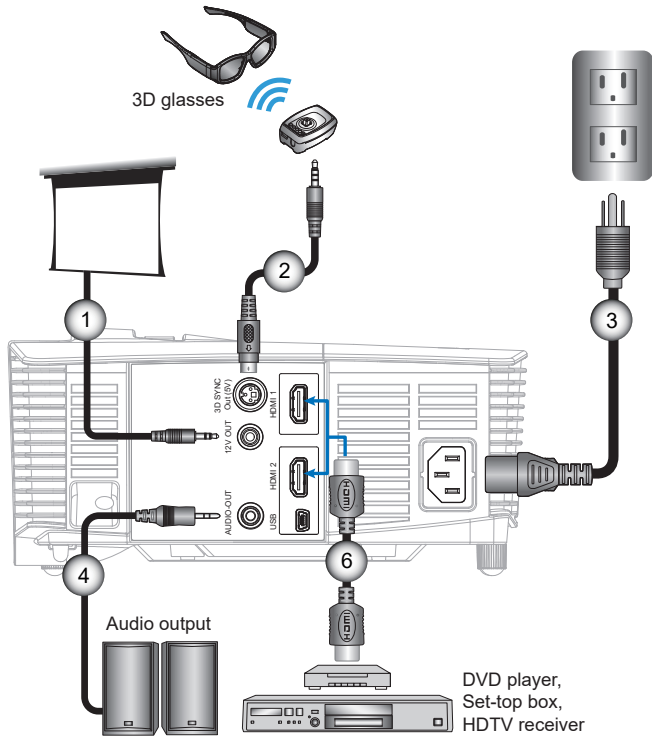

- ❖ Due to the difference in applications for each country, some regions may have different accessories.
- ❖ (*) Optional accessory

- | | |
|--------|-------------------|
| 1..... | *12V DC plug |
| 2..... | *3D emitter cable |
| 3..... | Power cord |
| 4..... | *Audio out cable |
| 5..... | HDMI cable |



- ❖ The 3D video source device must be powered on before the 3D projector.



- ❖ If input video is normal 2D, please press "3D Format" and switch to "Auto".
- ❖ If "SBS Mode" is active, 2D video content will not display correctly.

Connect to 3D Video Devices

Once you have connected your devices together with HDMI cables, as shown in the diagram, you are ready to begin. Power ON your 3D video source and your 3D projector.

PlayStation® 3 Games

- Make sure that you have updated your console to the latest software version.
- Go to the "Settings menu -> Display settings -> Video output -> HDMI". Select "Automatic" and follow the on-screen instructions.
- Insert your 3D game disc. Alternatively you can download games (and 3D updates) via the PlayStation® network.
- Launch the game. In the in-game menu, select "Play in 3D".

Blu-ray 3D™ Player

- Make sure that your player can support 3D Blu-ray™ disc and that 3D output is enabled.
- Insert the 3D Blu-ray™ disc into the player, press "Play".

3D TV (e.g. SKY 3D, DirectTV)

- Contact your TV service provider to enable any 3D channels on your channel package.
- Once enabled, switch to the 3D channel.
- You should see two images side-by-side.
- Switch to the "SBS Mode" of the 3D projector. The option is located in the "Display" section of the projector OSD menu.

3D Device (e.g. 3D DV/DC) with 2D 1080i side by side signal output

- Connect your 3D device and switch to out 3D content with 2D side-by-side output to 3D Projector.
 - You should see two images side-by-side.
- Switch to the "SBS Mode" of the 3D projector. The option is located in the "Display" section of the projector OSD menu.

If watching 3D content from an HDMI 1.4a source (e.g. 3D Blu-ray) your 3D glasses should always be in sync. If watching 3D content from an HDMI 1.3 source (e.g. 3D broadcast using SBS mode) it may be necessary to use the projector's 3D Sync-Invert option to optimize your 3D experience. The option is located in the "Display ->3D" section of the projector OSD menu.

Installation

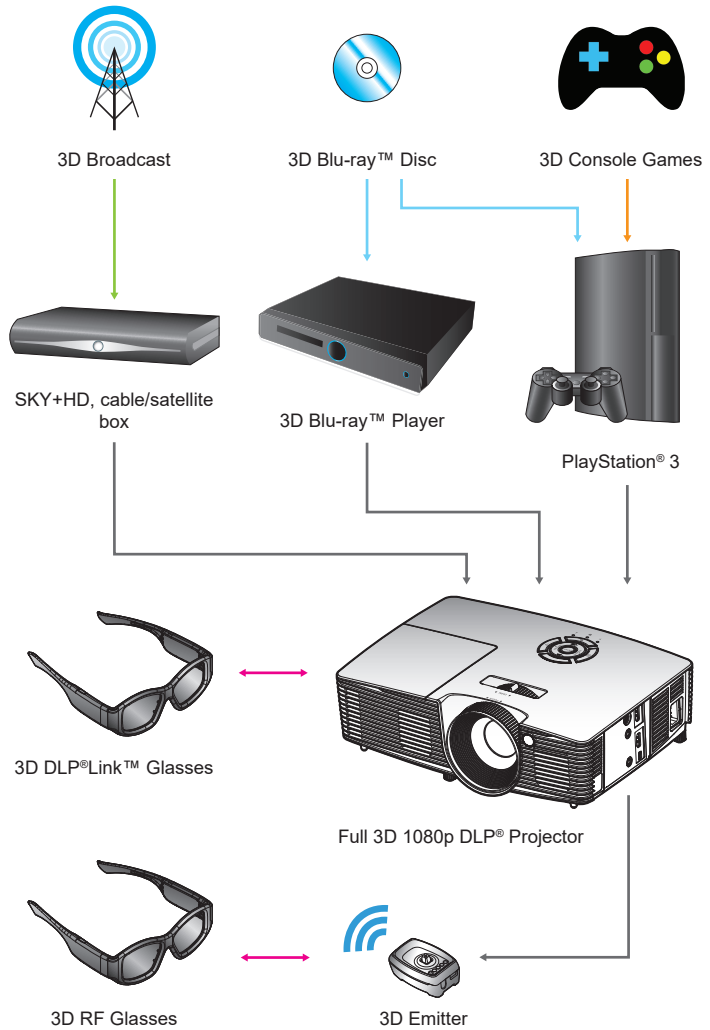



❖ For more detailed information, please refer to 3D glasses user's guide.

Using the 3D glasses

1. To turn ON 3D glasses.
2. Verify that 3D content is being sent to the projector and signal is compatible with projector specifications.
3. Turn on the "3D Mode" (Off/DLP-Link/IR - depending on which type of glasses you are using) of the 3D projector. The option is located in the "Display" section of the projector OSD menu.
4. Turn on 3D glasses and verify image appears in 3D without eyestrain.
5. If the image does not appear in 3D, please check 3D device set up correctly to send out 3D image or not. Or "SBS" mode should be turned on when input signal is 2D 1080i side-by-side. Repeat previous steps 1 ~ 4.
6. It may be necessary to use projector's "3D Sync. Invert" option to optimize your 3D experience. The option is located in the "Display" section of the projector OSD menu.
7. To turn OFF 3D glasses: Press the "Power" button and hold until the LED switches off.
8. For more detailed information, please refer to the 3D glasses user's guide, or manufacturer's Website.

Powering On/Off the Projector

Powering On the Projector

1. Securely connect the power cord and signal cable. When connected, the On/Standby LED will turn Red.
2. Turn on the lamp by pressing “**⏻**” button either on the top of the projector or on the remote. The On/Standby LED will now blink Blue.

The startup screen will display in approximately 10 seconds. The first time you use the projector, you will be asked to select the preferred language.

3. Turn on and connect the source that you want to display on the screen (computer, notebook, video player, etc). The projector will detect the source automatically. If not, push menu button and go to “Options”. Make sure that the “Source Lock” has been set to “Off”.
- ❖ If you connect multiple sources at the same time, press the “SOURCE” button on the Keypad or direct source keys on the remote control to switch between inputs.

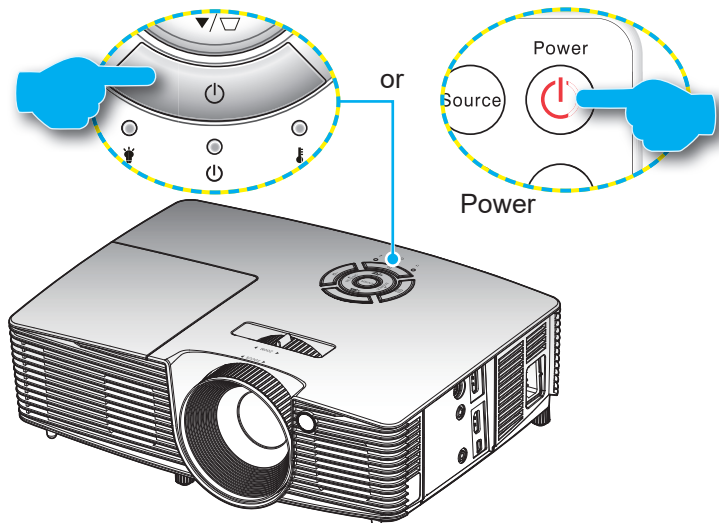

- ❖ Turn on the projector first and then select the signal sources.

Powering Off the Projector

1. Press the “⏻” button on the Keypad or the remote control to turn off the projector. The following message will be displayed on the screen.

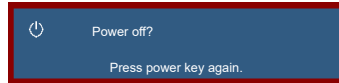

Press the “⏻” button again to confirm otherwise the message will disappear after 15 seconds. When you press the “⏻” button for the second time, the projector will display countdown timer and will shut down.

2. The cooling fans continue to operate for about 10 seconds for cooling cycle and the On/Standby LED will flash Blue. When the On/Standby LED lights solid Red, the projector has entered standby mode.

If you wish to turn the projector back on, you must wait until the projector has completed the cooling cycle and has entered standby mode. Once in standby mode, simply press “⏻” button to restart the projector.



- ❖ Contact InFocus if the projector displays these symptoms.

Warning Indicator

When the warning indicators (see below) come on, the projector will automatically shutdown:

- ❖ “LAMP” LED indicator is lit Red and if “On/Standby” indicator flashes Red.
- ❖ “TEMP” LED indicator is lit Red and if “On/Standby” indicator flashes Red. This indicates the projector has overheated. Under normal conditions, the projector can be switched back on.
- ❖ “TEMP” LED indicator flashes Red and if “On/Standby” indicator flashes Red.

Unplug the power cord from the projector, wait for 30 seconds and try again. If the warning indicator lights up again, please contact your nearest service center for assistance.

Adjusting the Projected Image

Adjusting the Projector's Height

The projector is equipped with elevator feet for adjusting the image height.

1. Locate the adjustable foot you wish to modify on the underside of the projector.
2. Rotate the adjustable ring clockwise to raise the projector or counter clockwise to lower it. Repeat with the remaining feet as needed.

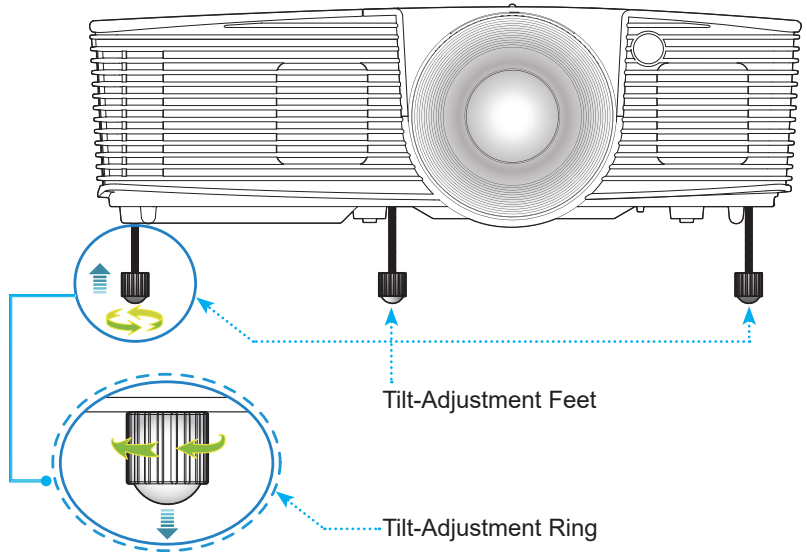

Installation

Adjusting the Projector's Zoom / Focus

You may turn the zoom ring to zoom in or out. To focus the image, rotate the focus ring until the image is clear.

- ▶ Standard throw series: The projector will focus at distances from 3.94 to 24.61 feet (1.2 to 7.5 meters).

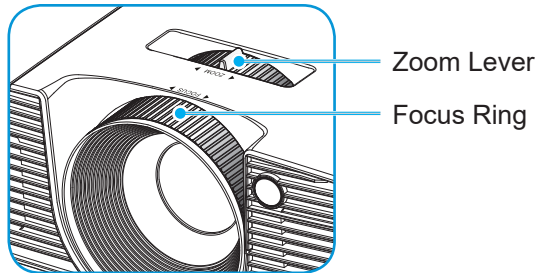

Adjusting Projection Image Size

- ▶ Projection Image Size from 37.0" to 301.0" (0.94 to 7.65 meters).

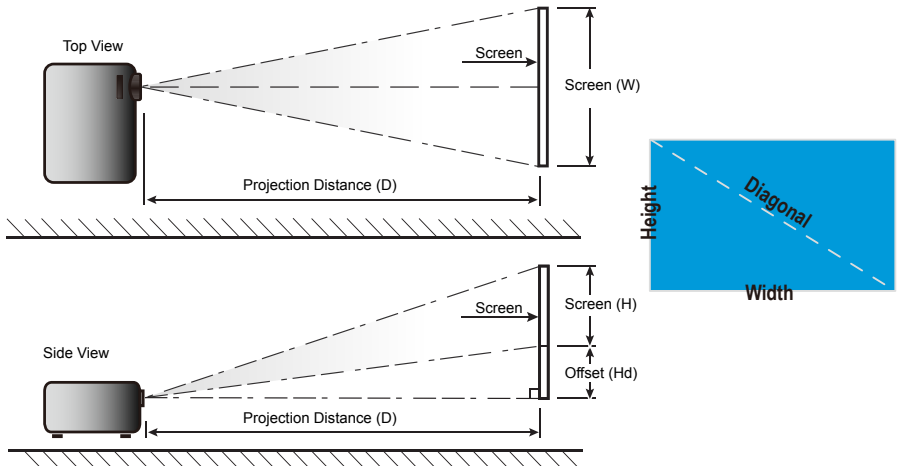

Installation

Standard throw

| Diagonal length (inch) size of 16:9 Screen | Screen Size W x H | | | | Projection Distance (D) | | | | Offset (Hd) | |
|--|-------------------|--------|--------|--------|-------------------------|------|--------|--------|-------------|--------|
| | (m) | | (inch) | | (m) | | (inch) | | (m) | (inch) |
| | Width | Height | Width | Height | wide | tele | wide | tele | | |
| 37.00 | 0.82 | 0.46 | 32.25 | 18.14 | 0.92 | 1.20 | 36.22 | 47.24 | 0.07 | 2.90 |
| 50.00 | 1.11 | 0.62 | 43.58 | 24.51 | 1.24 | 1.62 | 48.82 | 63.78 | 0.10 | 3.92 |
| 60.00 | 1.33 | 0.75 | 52.29 | 29.42 | 1.49 | 1.95 | 58.66 | 76.77 | 0.12 | 4.71 |
| 70.00 | 1.55 | 0.87 | 61.01 | 34.32 | 1.74 | 2.27 | 68.50 | 89.37 | 0.14 | 5.49 |
| 80.00 | 1.77 | 1.00 | 69.73 | 39.22 | 1.99 | 2.60 | 78.35 | 102.36 | 0.16 | 6.28 |
| 90.00 | 1.99 | 1.12 | 78.44 | 44.12 | 2.24 | 2.92 | 88.19 | 114.96 | 0.18 | 7.06 |
| 100.00 | 2.21 | 1.25 | 87.16 | 49.03 | 2.49 | 3.25 | 98.03 | 127.95 | 0.20 | 7.84 |
| 120.00 | 2.66 | 1.49 | 104.59 | 58.83 | 2.99 | 3.90 | 117.72 | 153.54 | 0.24 | 9.41 |
| 150.00 | 3.32 | 1.87 | 130.74 | 73.54 | 3.73 | 4.87 | 146.85 | 191.73 | 0.30 | 11.77 |
| 180.00 | 3.98 | 2.24 | 156.88 | 88.25 | 4.48 | 5.85 | 176.38 | 230.31 | 0.36 | 14.12 |
| 250.00 | 5.53 | 3.11 | 217.89 | 122.57 | 6.22 | 8.12 | 244.88 | 319.69 | 0.50 | 19.61 |
| 301.00 | 6.66 | 3.75 | 262.34 | 147.57 | 7.49 | 9.78 | 294.88 | 385.04 | 0.60 | 23.61 |





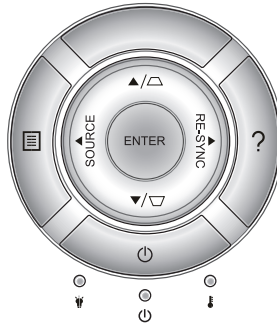

❖ This table is for user's reference only.

Keypad & Remote Control

Keypad



Using the Keypad

| | | |
|------------------------------|---|---|
| POWER |  | Refer to the “Power On/Off the Projector” section on pages 17-18. |
| RE-SYNC | RE-SYNC | Automatically synchronize the projector to the input source. |
| ENTER | ENTER | Confirm your item selection. |
| SOURCE | SOURCE | Press “SOURCE” to select an input signal. |
| Menu |  | Press “Menu” to launch the on-screen display (OSD) menu. To exit OSD, Press “Menu” again. |
| Help |  | Help Menu (only available when OSD menu is not shown). |
| Four Directional Select Keys | | Use ▲ ▼ ◀ ▶ to select items or make adjustments to your selection. |
| Keystone |  | Use ▽ ▹ to adjust image distortion caused by tilting the projector. (±40 degrees) |
| Lamp LED |  | Indicate the projector’s lamp status. |
| Temp LED |  | Indicate the projector’s temperature status. |
| On/Standby LED |  | Indicate the projector’s status. |

User Controls

Remote Control

Using the Remote Control

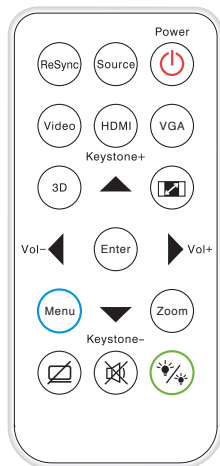

❖ The interface is subject to model's specifications.

| | | |
|------------------------------|--|---|
| Power | | Refer to the "Power On/Off the Projector" section on pages 13-14. |
| Source | | Press "Source" to select an input signal. |
| Re-Sync | | Automatically synchronizes the projector to the input source. |
| Video | | Video Not Available |
| HDMI | | Press "HDMI" to choose HDMI source. (For certain model) |
| 3D | | Press the "3D" to turn the 3D OSD menu on/off. |
| Four Directional Select Keys | | Use ▲ ▼ ◀ ▶ to select items or make adjustments to your selection. |
| AV Mute | | Momentarily turns off/on the audio and video. |
| Enter | | Confirm your item selection and Enables Remote Mouse function. |
| Mute | | Momentarily turns off/on the audio. |
| Keystone +/- | | Adjust image distortion caused by tilting the projector. |
| Aspect | | Use this function to choose your desired aspect ratio. |
| Menu | | Press "Menu" to launch the on-screen display (OSD) menu. To exit OSD, press "Menu" again. |
| Volume +/- | | Adjust to increase / decrease the volume. |
| Brightness Mode | | Change the brightness mode: Bright->Eco->Dynamic. (refer to page 43) |
| Zoom | | Zoom in on an image. Press ◀ ▶ buttons to alter zoom. |

Remote Control Battery Installation

1. Press firmly and slide the battery cover off.

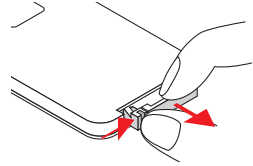

2. Install new battery into the compartment. Remove the old battery and install new one (CR2025). Ensure that the side with a "+" is facing up.

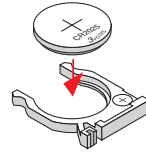

3. Put the cover back.

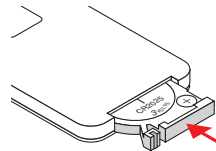

To ensure safe operation, please observe the following precautions :

- ▶ Use CR2025 type battery.
- ▶ Avoid contact with water or liquid.
- ▶ Do not expose the remote control to moisture or heat.
- ▶ Do not drop the remote control.
- ▶ If the battery has leaked in the remote control, carefully wipe the case clean and install new battery.
- ▶ Risk of an explosion if battery is replaced by an incorrect type.
- ▶ Dispose of used battery according to the instructions.

User Controls

Using the HELP button

The HELP function ensures easy setup and operation.

- ▶ Press the “?” button on the Keypad to open the Help Menu.

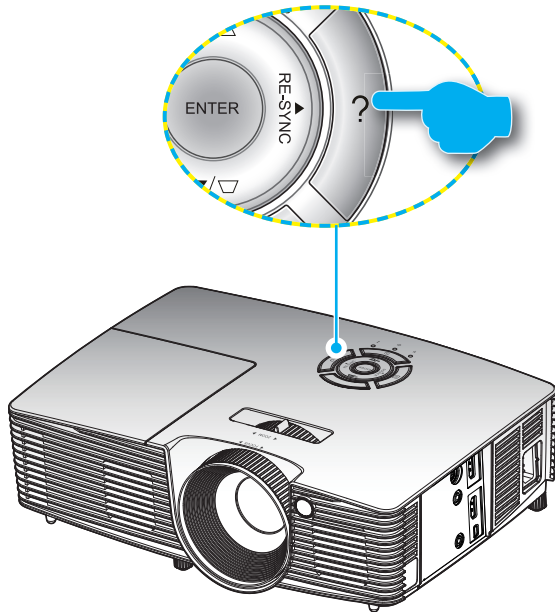

User Controls

- ▶ Help menu button functions only when no input source is detected.



- ❖ Please refer to the “Troubleshooting” section on pages 45-50 for more details.

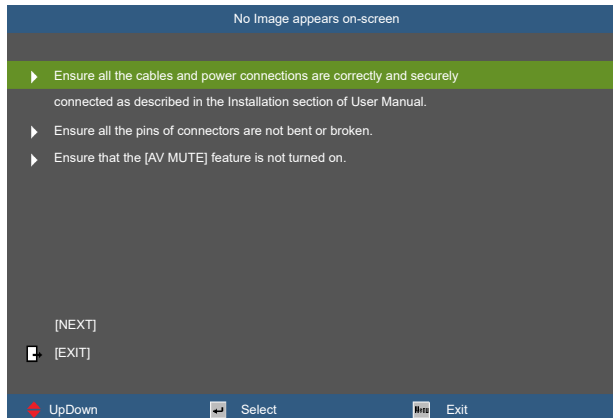
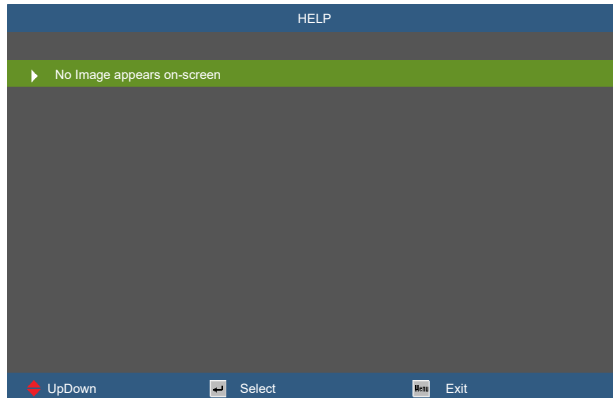

User Controls

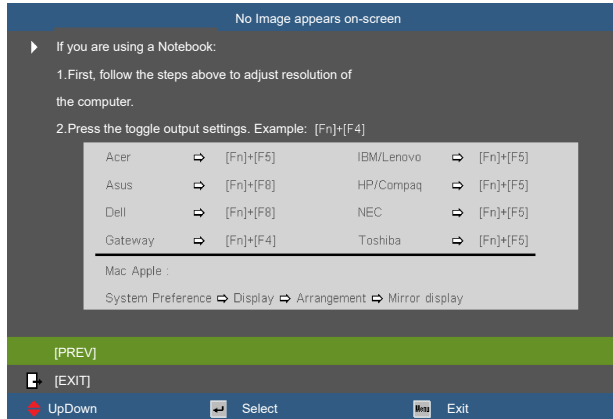

- ▶ If input source is detected and help button is pressed, the following pages will appear to help diagnose any problems.

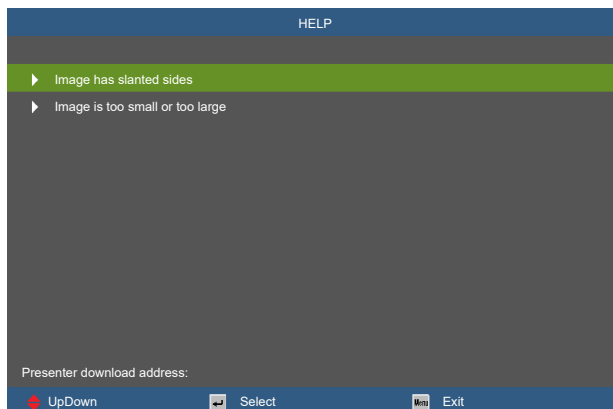

User Controls

Image is too small or too large

- ▶ Adjust the Zoom Ring on the top of the projector.
- ▶ Move the projector closer to or further from the screen.
- ▶ Press [Menu] button on the remote control or projector panel, go to Display | Format and try the different settings.

[DISPLAY | Format]

[EXIT]

UpDown Select Exit

On-screen Display Menus

The Projector has multilingual On-screen Display menus that allow you to make image adjustments and change a variety of settings. The projector will automatically detect the source.

How to operate

1. To open the OSD menu, press “Menu” on the Remote Control or Keypad.
2. When OSD is displayed, use ◀▶ keys to select any item in the main menu. While making a selection on a particular page, press ▼ or “Enter” key to enter sub menu.
3. Use ▲▼ keys to select the desired item and adjust the settings using ◀▶ key.
4. Select the next item to be adjusted in the sub menu and adjust as described above.
5. Press “Enter” to confirm, and the screen will return to the main menu.
6. To exit, press “Menu” again. The OSD menu will close and the projector will automatically save the new settings.

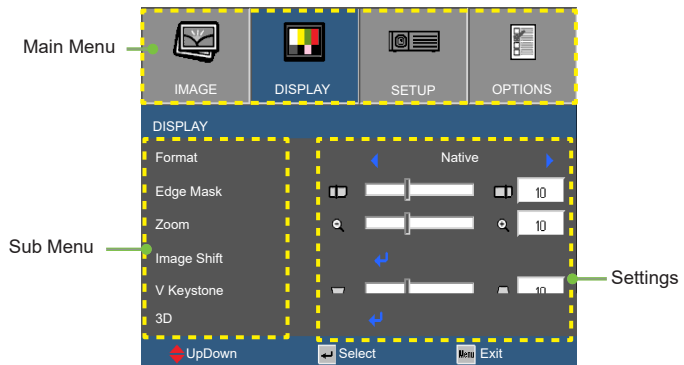









Menu Tree

| Main Menu | Sub Menu | Sub Menu2 | Sub Menu3 | Submenu4 | Values | |
|-----------|--------------|-----------------|-----------|------------|------------------------|--------------|
| Image | Display Mode | | | | Presentation [Default] | |
| | | | | | Bright | |
| | | | | | Movie | |
| | | | | | sRGB | |
| | | | | | Blackboard | |
| | | | | | User | |
| | Brightness | | | | -50~50 | |
| | Contrast | | | | -50~50 | |
| | Sharpness | | | | 1~15 | |
| | Color | | | | -50~50 [Default:0] | |
| | Tint | | | | -50~50 [Default:0] | |
| | | Gamma | Film | | | |
| | | | Video | | | |
| | | | Graphics | | | |
| | | | Standard | | | |
| | | BrilliantColor™ | | | | 1~10 |
| | | Color Temp. | | | | Warm |
| | | | | | | Medium |
| | | | | | | Cold |
| | | Color Settings | Red | Hue | | -50~50 |
| | | | | Saturation | | -50~50 |
| | | | | Gain | | -50~50 |
| | | | Green | Hue | | -50~50 |
| | | | | Saturation | | -50~50 |
| | | | | Gain | | -50~50 |
| | | | Blue | Hue | | -50~50 |
| | | | | Saturation | | -50~50 |
| | | | | Gain | | -50~50 |
| | | | Cyan | Hue | | -50~50 |
| | | | | Saturation | | -50~50 |
| | | | | Gain | | -50~50 |
| | | | Magenta | Hue | | -50~50 |
| | | | | Saturation | | -50~50 |
| | | | | Gain | | -50~50 |
| | | | Yellow | Hue | | -50~50 |
| | | | | Saturation | | -50~50 |
| | | | | Gain | | -50~50 |
| | White | | Red | | -50~50 | |
| | | | Green | | -50~50 | |
| | | | Blue | | -50~50 | |
| | Reset | | | | | Yes |
| | | | | | | No [Default] |
| | Exit | | | | | |

User Controls

| Main Menu | Sub Menu | Sub Menu2 | Sub Menu3 | Submenu4 | Values | | |
|-----------------|-------------|-----------------------------|-----------|---------------|-----------------------|------------------|--------------|
| Image | Advanced | Color Space (HDMI Input) | | | Auto [Default] | | |
| | | | | | RGB(0~255) | | |
| | | | | | RGB(16~235) | | |
| | | Exit | | | YUV | | |
| Dispaly | Format | | | | 4:3 | | |
| | | | | | 16:9 | | |
| | | | | | LBX | | |
| | | | | | Native | | |
| | Edge Mask | | | | Auto [Default] | | |
| | Zoom | | | | 0~10 [Default:0] | | |
| | | | | | -5~25 [Default:0] | | |
| | Image Shift | H | | | -100~+100 [Default:0] | | |
| | | V | | | -100~+100 [Default:0] | | |
| | V Keystone | | | | -40~+40 [Default:0] | | |
| | 3D | | 3D Mode | | | Off [Default] | |
| | | | | | | DLP-Link | |
| | | | | | | IR | |
| | | | 3D→2D | | | | 3D [Default] |
| | | | | | | | L |
| | | | | | | | R |
| 3D Format | | | | | | Auto [Default] | |
| | | | | | | SBS | |
| | | | | | | Top and Bottom | |
| 3D Sync. Invert | | | | | | Frame Sequential | |
| | | | | On | | | |
| Exit | | | | Off [Default] | | | |
| Setup | Language | | | | English [Default] | | |
| | | | | | Deutsch | | |
| | | | | | Français | | |
| | | | | | Italiano | | |
| | | | | | Español | | |
| | | | | | Português | | |
| | | | | | Hindi | | |
| | | | | | Nederlands | | |
| | | | | | Norsk/Dansk | | |
| | | | | | Polski | | |
| | | | | | Русский | | |
| | | | | | Filipinos | | |
| | | | | | Malay | | |
| | | | | | Magyar | | |
| | | | | | Čeština | | |
| | | | | | عربي | | |
| | | | 繁體中文 | | | | |
| | | | 簡體中文 | | | | |
| | | | 日本語 | | | | |

User Controls

| Main Menu | Sub Menu | Sub Menu2 | Sub Menu3 | Submenu4 | Values | |
|----------------|------------------|------------------|-----------|----------|--------------------------|--|
| Setup | Language | | | | 한국어 | |
| | | | | | ไทย | |
| | | | | | Türkçe | |
| | | | | | Farsi | |
| | | | | | Vietnamese | |
| | | | | | Romanian | |
| | | | | | Indonesian | |
| | Projection | | | | | Front [Default]  |
| | | | | | | Front-Ceiling  |
| | | | | | | Rear  |
| | | | | | | Rear-Ceiling  |
| | Menu Location | | | | | Top-Left  |
| | | | | | | Top-Right  |
| | | | | | | Center [Default]  |
| | | | | | | Bottom-Left  |
| | | | | | | Bottom-Right  |
| | Audio Settings | Internal Speaker | | | | On [Default] Off |
| | | Mute | | | | On Off [Default] |
| | | Volume | | | | 0~10 [Default:5] |
| | | Exit | | | | |
| | Advanced | Logo | | | | Default [Default] Neutral |
| Exit | | | | | | |
| Options | Input Source | | | | HDMI1 [Default] HDMI2 | |
| | Source Lock | | | | On Off [Default] | |
| | High Altitude | | | | On Off [Default] | |
| | Information Hide | | | | | On Off [Default] |
| | | | | | | NOTE: Warning messages and the Power Off message are not hidden when Information Hide is set to On. |
| | Keypad Lock | | | | On Off [Default] | |
| | Test Pattern | | | | | Grid [Default] White Pattern |
| | | | | | | Off |
| | IR Function | | | | | On [Default] Top |
| | | | | | | Front |

User Controls

| Main Menu | Sub Menu | Sub Menu2 | Sub Menu3 | Submenu4 | Values | | |
|-----------|--------------------------|---------------------------|-----------|----------|----------------|--------------------------------------|-----------------|
| | Background Color | | | | Black | | |
| | | | | | Red | | |
| | | | | | Blue [Default] | | |
| | | | | | Green | | |
| | | | | | White | | |
| | 12V Trigger | | | | | Off [Default] | |
| | | | | | | On | |
| | | | | | | Auto 3D | |
| | Advanced | Direct Power On | | | | On | |
| | | | | | | Off [Default] | |
| | | Auto Power Off (min) | | | | 0~180 [Default:20] | |
| | | | | | | NOTE: One step is 5 minutes. | |
| | | Sleep Timer (min) | | | | 0~990 [Default:0] | |
| | | | | | | NOTE: One step is 30 minutes. | |
| | | Quick resume | | | | On | |
| | | Exit | | | | Off [Default] | |
| | Lamp Settings | Lamp Hour | | | | 0~9999 [Default:0] (display only) | |
| | | Lamp Reminder | | | | On [Default] | |
| | | | | | | Off | |
| | | Lamp Mode | | | | Bright [Default] | |
| | | | | | | Eco. | |
| | | | | | | Dynamic | |
| | | Lamp Reset | | | | Yes | |
| | | Exit | | | | No [Default] | |
| | Optional Filter Settings | Optional Filter Installed | | | | No | |
| | | | | | | Yes [Default] | |
| | | Filter Usage Hours | | | | 0~9999 [Default:0] (display only) | |
| | | | | | | Off | |
| | | Filter Reminder | | | | | 300Hr |
| | | | | | | | 500Hr [Default] |
| | | | | | | | 800Hr |
| | | | | | | | 1000Hr |
| | | Filter Reset | | | | No [Default] | |
| | | Exit | | | | Yes | |
| | Reset | | | | | No [Default] | |
| | Exit | | | | | Yes | |

Image

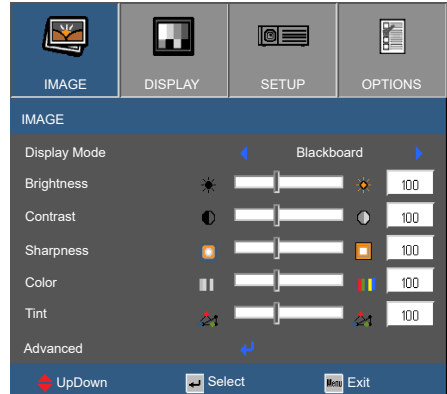

Display Mode

There are many factory presets optimized for various types of images.

- ▶ Presentation: Good color and brightness from PC input.
- ▶ Bright: Maximum brightness from PC input.
- ▶ Movie: For home theater.
- ▶ sRGB: Standardised accurate color.
- ▶ Blackboard: This mode should be selected to achieve optimum color settings when projecting onto a blackboard (green).
- ▶ User: User's settings.
- ▶ 3D: Recommend setting for 3D mode enabled. Any further adjustments by the user in 3D will be saved in this mode for further use.

Brightness

Adjust the brightness of the image.

- ▶ Press the ◀ to darken image.
- ▶ Press the ▶ to lighten the image.

Contrast

The contrast controls the degree of difference between the lightest and darkest parts of the picture.

- ▶ Press the ◀ to decrease the contrast.
- ▶ Press the ▶ to increase the contrast.

User Controls

Sharpness

Adjust the sharpness of the image.

- ▶ Press the ◀ to decrease the sharpness.
- ▶ Press the ▶ to increase the sharpness.

Color

Adjust a video image from black and white to fully saturated color.

- ▶ Press the ◀ to decrease the amount of saturation in the image.
- ▶ Press the ▶ to increase the amount of saturation in the image.

Tint

Adjust the color balance of red and green.

- ▶ Press the ◀ to increase the amount of green in the image.
- ▶ Press the ▶ to increase the amount of red in the image.

Image | Advanced

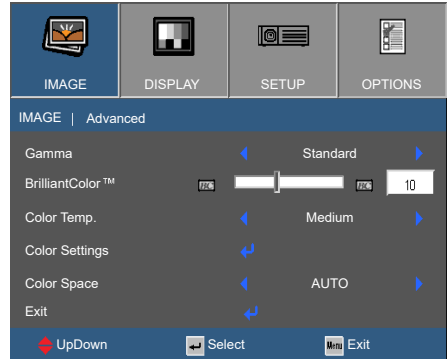

Gamma

This allows you to set up gamma curve type. After the initial setup and fine tuning is completed, utilize the Gamma Adjustment steps to optimize your image output.

- ▶ Film: for home theater.
- ▶ Video: for video or TV source.
- ▶ Graphics: for PC / Photo source.
- ▶ Standard: for standardized setting.

BrilliantColor™

This adjustable item utilizes a new color-processing algorithm and enhancements to enable higher brightness while providing true more vibrant colors in the image. The range is from “1” to “10”. If you prefer a stronger enhanced image, adjust toward the maximum setting. For a smoother, more natural image, adjust toward the minimum setting.

Color Temp.

Select a color temperature from Warm, Medium, and Cold.

Color Settings

Press **↩** into the next menu and then use **▲** or **▼** to select item.

User Controls

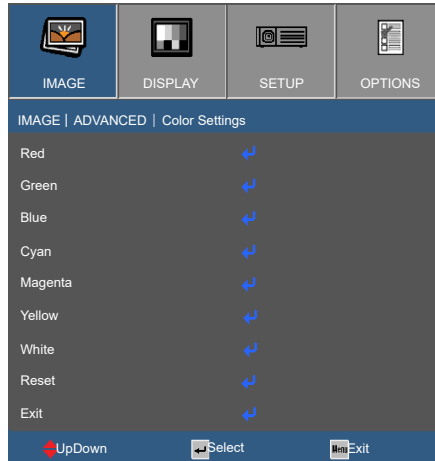

- ▶ Red/Green/Blue/Cyan/Magenta/Yellow: Use ◀ or ▶ to select Hue, Saturation, and Gain Colors.



- ▶ White: Use ◀ or ▶ to select Red, Green, and Blue Colors.



- ▶ Reset: Choose “Yes” to return the factory default settings for color adjustments.
- ▶ Exit: Choose Exit to exit the Advanced Color Settings menu.

Color Space

Select an appropriate color matrix type from Auto, RGB(0-255), RGB(16-235) or YUV.

Display

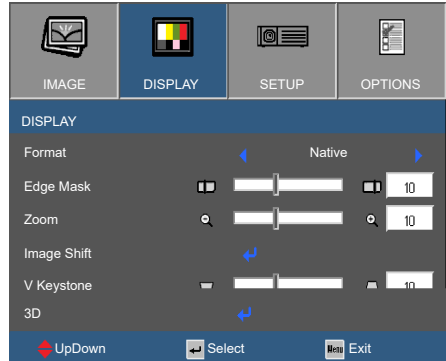

Format

Use this function to choose your desired aspect ratio.

- ▶ 4:3: This format is for 4x3 input sources.
- ▶ 16:9: This format is for 16x9 input sources, like HDTV and DVD enhanced for Widescreen TV.
- ▶ LBX: This format is for non-16x9, letterbox source and for users who use external anamorphic lens to display 2.35:1 aspect ratio using full resolution.
- ▶ Native: This format displays the original image without scaling.
- ▶ Auto: Automatically selects the appropriate display format.

Detailed information about LBX mode:

1. Some Letter-Box Format DVDs are not enhanced for 16x9 TVs. In this situation the image will not look right when displayed in 16:9 mode. In this situation please try using the 4:3 mode to view the DVD. If the content is not 4:3, there will be black bars around the image in 16:9 display. For this type of content, you can use LBX mode to fill the image on the 16:9 display.
2. If you use an external anamorphic lens, LBX mode also allows you to watch 2.35:1 content (including Anamorphic DVD and HDTV film sources) that supports anamorphic aspect ratio enhanced for 16x9 displays. Lamp power and vertical resolution are fully utilized.

User Controls

| 16:9 Screen | 480i/p | 576i/p | 1080i/p | 720p | PC |
|-------------|--|--------|---------|------|----|
| 4:3 | 1440 x 1080 center | | | | |
| 16:9 | 1920 x 1080 center | | | | |
| LBX | 1920 x 1440 center, then get the central 1920 x 1080 image to display | | | | |
| Native | 1:1 mapping and centered. No scaling will be made; the resolution is dependent on which input source and is then displayed. | | | | |



- ❖ Each I/O has different setting of "Edge Mask".
- ❖ "Edge Mask" and "Zoom" can't work at same time.

Edge Mask

Edge mask the image to remove video encoding noise on the edge of video source.

Zoom

- ▶ Press the ◀ to reduce the size of an image.
- ▶ Press the ▶ to magnify an image on the projection screen.

Image Shift

Press ↩ into the next menu as below and then use ▲ or ▼ to select item.

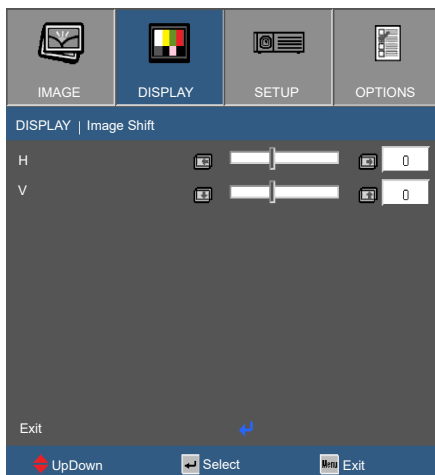

- ▶ H: Use the ◀ ▶ to shift the projected image position horizontally.
- ▶ V: Use the ◀ ▶ to shift the projected image position vertically.

V Keystone

Press the ◀ or ▶ to adjust image distortion vertically and make a squarer image.

Display | 3D

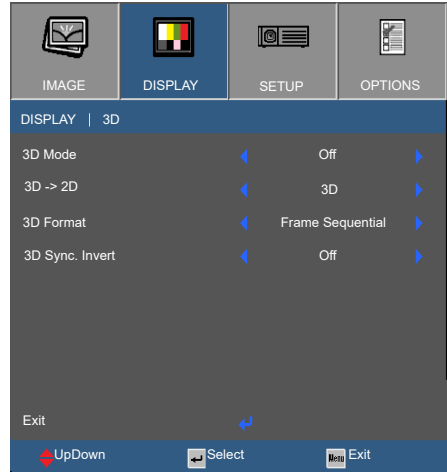

- ❖ Compatible 3D source, 3D content and active shutter glasses are required for 3D viewing.
- ❖ 3D Format is only supported on 3D Timing on page 60.
- ❖ "3D Format" is only supported on non-HDMI 1.4a 3D timing.
- ❖ "3D Sync. Invert" is only available when 3D is enabled and this mode 3D is for DLP link glass only.

3D Mode

- ▶ Off: Select "Off" to turn off 3D mode.
- ▶ DLP-Link: Select "DLP-Link" to use optimized settings for DLP Link 3D Glasses. (refer to page 16).
- ▶ IR: Select "IR" to use optimized setting for IR 3D Glasses.

3D -> 2D

- ▶ 3D: Display 3D signal.
- ▶ L (Left): Display the left frame of 3D content.
- ▶ R (Right): Display the right frame of 3D content.

3D Format

- ▶ Auto: When a 3D identification signal is detected, the 3D format is selected automatically.
- ▶ SBS: Display 3D signal in "Side-by-Side" format.
- ▶ Top and Bottom: Display 3D signal in "Top and Bottom" format.
- ▶ Frame Sequential: Display 3D signal in "Frame Sequential" format.

3D Sync. Invert

- ▶ Press the "On" to invert left and right frame contents.
- ▶ Press the "Off" for default frame contents.

Exit

- ▶ Exit the 3D menu.

User Controls

Setup

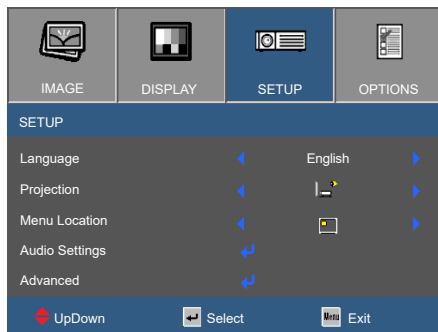

Language

Choose the multilingual OSD menu. Press the ◀ or ▶ into the sub menu and then use the ▲ or ▼ key to select your preferred language. Press “Enter” to finalize the selection.



Projection



- ❖ Rear-Desktop and Rear-Ceiling are to be used with a translucent screen.



Front

This is the default selection. The image is projected straight on the screen.



Front-Ceiling

When selected, the image will turn upside down.



Rear

When selected, the image will appear reversed.



Rear-Ceiling

When selected, the image will appear reversed in upside down position

Menu Location

Choose the menu location on the display screen.

Setup | Audio Settings

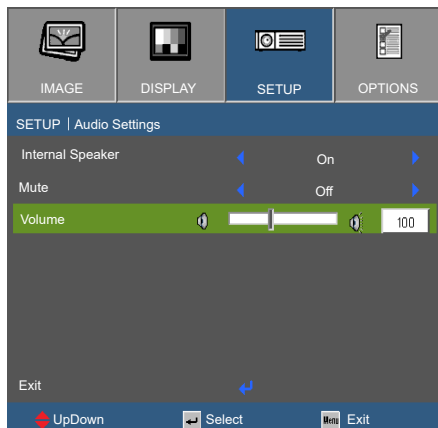

- ❖ "Mute" function affects both internal and external speaker volume.

Internal Speaker

Choose the "On" or "Off" to turn on or off the internal speaker.

Mute

- ▶ Choose the "On" to turn mute on.
- ▶ Choose the "Off" to turn mute off.

Volume

- ▶ Press the ◀ to decrease the volume.
- ▶ Press the ▶ to increase the volume.

Exit

Exit the Audio menu.

Setup | Advanced

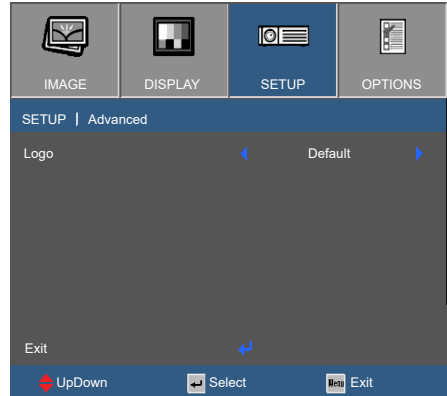

Logo

Use this function to set the desired startup screen. If changes are made they will take effect the next time the projector is powered on.

- ▶ Default: The default startup screen.
- ▶ Neutral: Logo is not displayed on startup screen.

Exit

Exit the Setup Advanced menu.

Options

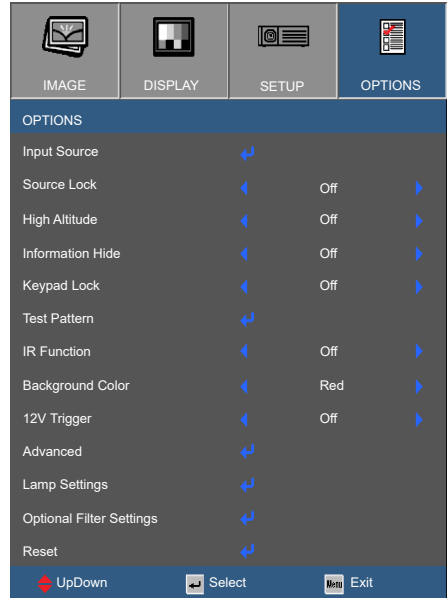

Input Source

Use this option to enable/disable input sources. Press the ← to enter the sub menu and select which sources you require. Press “Enter” to finalize the selection. The projector will only search for inputs that are enabled.

Source Lock

- ▶ On: The projector will only search current input connection.
- ▶ Off: The projector will search for other signals if the current input signal is lost.

High Altitude

When “On” is selected, the fans will spin faster. This feature is useful in high altitude areas where the air is thin.

Information Hide

- ▶ On: Choose “On” to hide the info message.
- ▶ Off: Choose “Off” to show the “searching” message.

Keypad Lock

When the keypad lock function is “On”, the Keypad will be locked however, the projector can be operated by the remote control. By selecting “Off”, you will be able to reuse the Keypad.



- ❖ To turn off the keypad lock, press and hold “Enter” key on top of the projector for 5 seconds.



- ❖ “Front” and “Top” can’t be selected under standby mode.

Test Pattern

Display a test pattern. There are Grid and White Pattern.

IR Function

- ▶ Off: Choose “Off”, the projector can’t be operated by the remote control from front or top IR receiver. By selecting “Off”, you will be able to use the Keypad keys.
- ▶ On: Choose “On” the projector can be operated by the remote control from the top and front IR receivers.
- ▶ Top: Choose “Top”, the projector can be operated by the remote control from top IR receiver.
- ▶ Front: Choose “Front”, the projector can be operated by the remote control from front IR receiver.

Background Color

Use this feature to display a “Black”, “Red”, “Blue”, “Green”, or “White”, screen when no signal is available.

12V Trigger



- ❖ 12V Trigger supports up to a 250ma relay.

- ▶ Off: Choose “Off” to disable the trigger.
- ▶ On: Choose “On” to enable the trigger.
- ▶ Auto 3D: When “Auto 3D” is enabled, the projector will automatically detect when a 3D image is shown and will activate the trigger on this port.

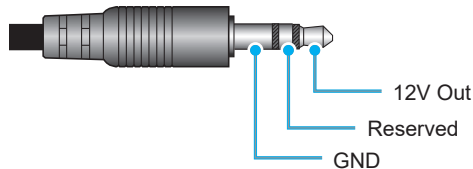

Reset

Choose “Yes” to return the display parameters on all menus to the factory default settings.

Exit

Exit the OSD menu.

Options | Advanced

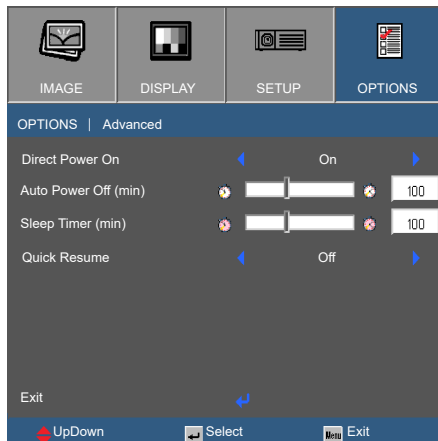

Direct Power On

Choose “On” to activate Direct Power mode. The projector will automatically power on when AC power is supplied, without pressing the “” key on the projector Keypad or on the remote control.

Auto Power Off (min)

Sets the countdown timer interval. The countdown timer will start when there is no signal being sent to the projector. The projector will automatically power off when the countdown has finished (in minutes).



- ❖ The value of sleep timer will be reset to zero after the projector power off.

Sleep Timer (min)

Sets the countdown timer interval. The countdown timer will start with or without a signal being sent to the projector. The projector will automatically power off when the countdown has finished (in minutes).

Quick Resume

- ▶ On: If the projector is accidentally turned off, this feature allows the projector to be instantly powered on again, if selected within a period of 100 seconds.
- ▶ Off: The fan will start cooling the system immediately when user turns off the projector.

Exit

Exit the Options Advanced menu.

Options | Lamp Settings

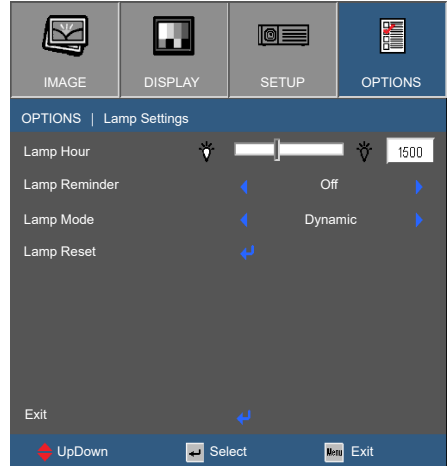

- ❖ When ambient temperature is over 40°C in operating, the projector will switch to Eco automatically.
- ❖ "Lamp Mode" can be independently set for 2D and 3D.

Lamp Hour

Display the projection time.

Lamp Reminder

Choose this function to show or to hide the warning message when the changing lamp message is displayed.

The message will appear 30 hours before suggested replacement of lamp.

Lamp Mode

- ▶ Bright: Choose "Bright" to increase the brightness.
- ▶ Eco.: Choose "Eco." to dim the projector lamp which will lower power consumption and extend the lamp life.
- ▶ Dynamic: Choose "Dynamic" to dim the lamp power which will be based on brightness level of the content and adjust lamp power consumption between 100% and 30% dynamically. The lamp life will be extended.

Lamp Reset

Reset the lamp hour counter after replacing the lamp.

Exit

Exit the Lamp Settings menu.

Options | Optional Filter Settings

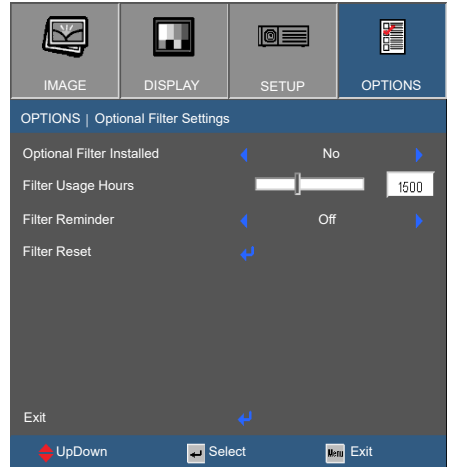

Optional Filter Installed

Select "Yes" to display warning message after 500 hours of use.
Select "No" to turn off warning message.

The default setting for Filter is "No". After assembling filter, please turn on the projector then press "Menu", go to "OPTIONS -> Optional Filter Settings -> Optional Filter Installed" and select "Yes".

Filter Usage Hours

Display the filter time.

Filter Reminder

Choose this function to show or hide the warning message when the changing filter message is displayed. (Factory default setting: 500 hours)

Filter Reset

Reset the dust filter counter after replacing or cleaning the dust filter.

Exit

Exit the Optional Filter Settings menu.

Troubleshooting

If you experience a problem with your projector, please refer to the following information. If a problem persists, please contact your local reseller or service center.

Image Problems

No image appears on-screen

- ▶ Ensure all the cables and power connections are correctly and securely connected as described in the “Installation” section.
- ▶ Ensure the pins of connectors are not crooked or broken.
- ▶ Check if the projection lamp has been securely installed. Please refer to the “Replacing the Lamp” section.
- ▶ Ensure that the “AVMute” is not turned on.

Image is out of focus

- ▶ Adjust the Focus Ring on the projector lens.
- ▶ Make sure the projection screen is between the required distance from the projector. (refer to pages 21-22)

The image is stretched when displaying 16:9 DVD title

- ▶ When you play anamorphic DVD or 16:9 DVD, the projector will show the best image in 16: 9 format on projector side.
- ▶ If you play the LBX format DVD title, please change the format as LBX in projector OSD.
- ▶ If you play 4:3 format DVD title, please change the format as 4:3 in projector OSD.
- ▶ If the image is still stretched, you will also need to adjust the aspect ratio by referring to the following:
- ▶ Please setup the display format as 16:9 (wide) aspect ratio type on your DVD player.

Image is too small or too large

- ▶ Adjust the zoom lever on the top of the projector.
- ▶ Move the projector closer to or further from the screen.
- ▶ Press “Menu” on the projector panel, go to “Display-->Format”. Try the different settings.

Image has slanted sides:

- ▶ If possible, reposition the projector so that it is centered on the screen and below the bottom of the screen.
- ▶ Use “Display-->V Keystone” from the OSD to make an adjustment.

Image is reversed

- ▶ Select “Setup-->Projection” from the OSD and adjust the projection direction.

Blurry double image

- ▶ Press “3D Format” button and switch to “Off” to avoid normal 2D image is blurry double image.

Two images, side-by-side format

- ▶ Press “3D Format” button and switch to “SBS” for input signal is HDMI 1.3 2D 1080i side-by-side.

Image does not display in 3D

- ▶ Check if the battery of 3D glasses is drained.
- ▶ Check if the 3D glasses is turned on.
- ▶ When the input signal is HDMI 1.3 2D (1080i side-by-side half), press “3D Format” button and switch to “SBS”.

Other Problems

The projector stops responding to all controls

- ▶ If possible, turn off the projector, then unplug the power cord and wait at least 20 seconds before reconnecting power.

Lamp burns out or makes a popping sound

- ▶ When the lamp reaches its end of life, it will burn out and may make a loud popping sound. If this happens, the projector will not turn on until the lamp module has been replaced. To replace the lamp, follow the procedures in the “Replacing the Lamp” section.





































Remote Control Problems

If the remote control does not work



- ▶ Check the operating angle of the remote control is within $\pm 15^\circ$ both horizontally and vertically of one of the IR receivers on the projector.
- ▶ Make sure there are not any obstructions between the remote control and the projector. Move to within 6 m (20 ft) of the projector.
- ▶ Make sure batteries are inserted correctly.
- ▶ Replace batteries if they are exhausted.

Appendices

LED Lighting Messages

| Message |  On/Standby LED |  On/Standby LED |  Temp LED |  Lamp LED |
|-------------------------------------|--|--|--|---|
| | (Red) | (Blue) | (Red) | (Red) |
| Standby state (Input power cord) |  |  |  |  |
| Power on (Warming) |  | Flashing 0.5 sec off and 0.5 sec light |  |  |
| Power on & Lamp lighting |  | |  |  |
| Power off (Cooling) |  | Flashing 0.5 sec off and 0.5 sec light. Back to Red steady light when cooling fan turns off. |  |  |
| Quick Resume (100 secs) |  | Flashing 0.25 sec off and 0.25 sec light |  |  |
| Error (Lamp failure) | Flashing |  |  |  |
| Error (Fan failure) | Flashing |  | Flashing |  |
| Error (Over Temp) | Flashing |  |  |  |
| Standby State (Burn in mode) |  | Flashing |  |  |
| Burnin (Warming) |  | Flashing |  |  |
| Burnin (Cooling) |  | Flashing |  |  |



❖ Steady light → 
No light → 

* Power LED be ON when OSD appears, be OFF when OSD disappears.

On Screen Messages

❖ Fan locked menu:

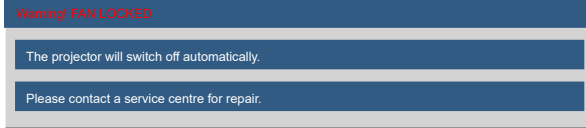

❖ Lamp warning:

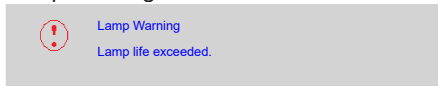

❖ Dust warning:



❖ Over temperature menu:

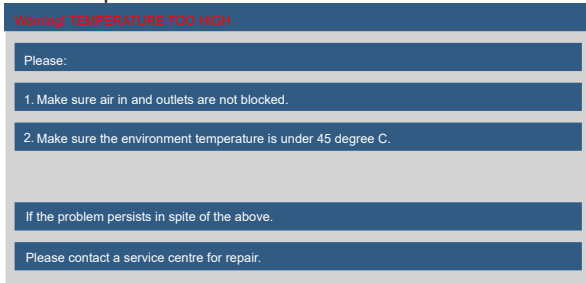

Replacing the Lamp

The projector automatically detects the lamp life. When the lamp life is nearing the end of use, you will receive a warning message.

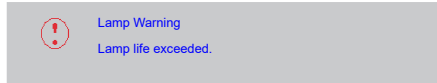

When you see this message, please contact your local reseller or service center to change the lamp as soon as possible. Make sure the projector has been cooled down for at least 30 minutes before changing the lamp.



Warning: If ceiling mounted, please use caution when opening the lamp access panel. It is recommended to wear safety glasses if changing the bulb when ceiling mounted. "Caution must be used to prevent any loose parts from falling out of projector."



Warning: Lamp compartment is hot! Allow it to cool down before changing lamp!



Warning: To reduce the risk of personal injury, do not drop the lamp module or touch the lamp bulb. The bulb may shatter and cause injury if it is dropped.



- ❖ The screw on the lamp cover and the lamp cannot be removed.
- ❖ The projector cannot be turned on if the lamp cover has not been placed back on the projector.
- ❖ Do not touch the glass area of the lamp. Hand oil can cause the lamp to shatter. Use a dry cloth to clean the lamp module if it was accidentally touched.

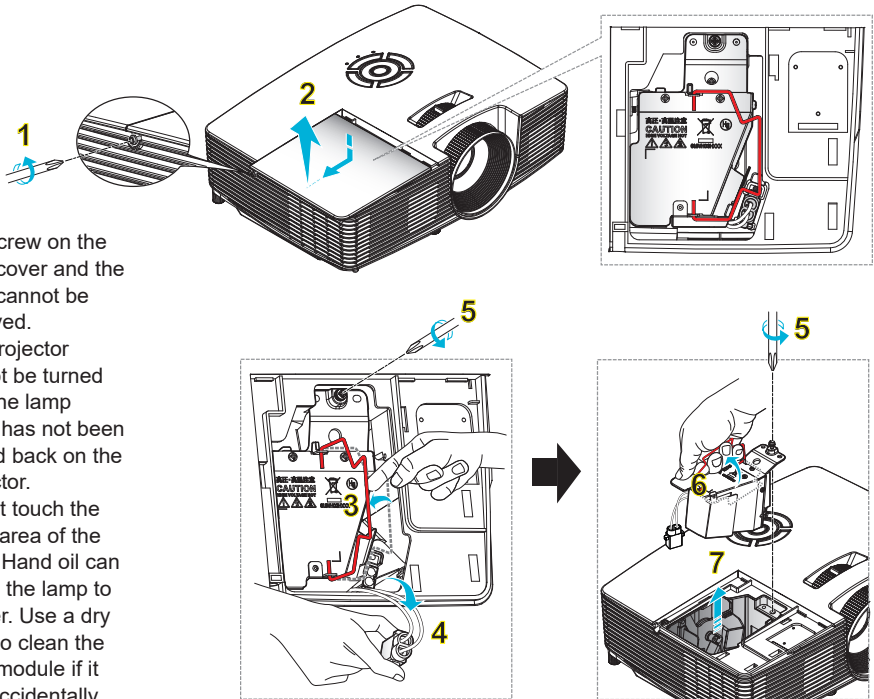

Lamp Replacement Procedure:

1. Switch off the power to the projector by pressing the “” button on Keypad of the projector or on the remote control.
2. Allow the projector to cool down for at least 30 minutes.
3. Disconnect the power cord.
4. Unscrew the one screw on the cover. **1**
5. Push up and remove the cover. **2**
6. Lift up the lamp handle. **3**
7. Press on the both sides then lift up and remove the lamp cord. **4**
8. Unscrew the one screw on the lamp module. **5**
9. Lift up the lamp handle **6** and remove the lamp module slowly and carefully. **7**

To replace the lamp module, reverse the previous steps.

10. Turn on the projector and reset the lamp timer.

Lamp Reset: (i) Press “Menu” → (ii) Select “Options” → (iii) Select “Lamp Settings” → (iv) Select “Lamp Reset” → (v) Select “Yes”.

Installing and Cleaning the Dust Filter



- ❖ Dust filters are only required/ supplied in selected regions with excessive dust.
- ❖ Dust filter is an optional service part.

Installing the Dust Filter

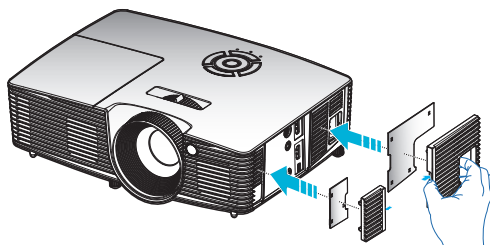

Cleaning the Dust Filter

We recommend cleaning the dust filter every three months; clean it more often if the projector is used in a dusty environment.

Procedure:

1. Switch off the power to the projector by pressing the “**⏻**” button on the Keypad of the projector or on the remote control.
2. Disconnect the power cord.
3. Remove the dust filter slowly and carefully.
4. Clean or replace the dust filter.
5. To install the dust filter, reverse the previous steps.

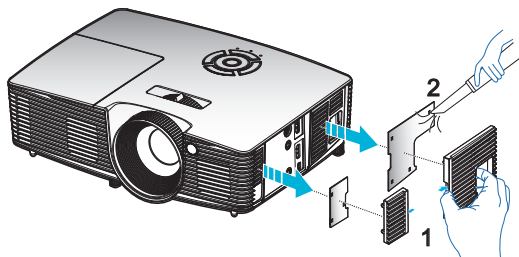

Compatibility Modes

HDMI/DVI-D Compatibility

| Digital | | |
|-----------------------|--------------------|---------------------------|
| B0/Established timing | B0/Standard timing | B0/Detail timing: |
| 720 x 400 @ 70Hz | SVGA: | Native timing: |
| 640 x 480 @ 60Hz | 800 x 600 @ 120Hz | XGA: 1024 x 768 @ 60Hz |
| 640 x 480 @ 67Hz | 1024 x 768 @ 120Hz | WXGA: 1280 x 800 @ 60Hz; |
| 640 x 480 @ 72Hz | 1280 x 800 @ 60Hz | 1280 x 720 @ 60Hz |
| 640 x 480 @ 75Hz | 1280 x 1024 @ 60Hz | 1080P: 1920 x 1080 @ 60Hz |
| 800 x 600 @ 56Hz | 1680 x 1050 @ 60Hz | |
| 800 x 600 @ 60Hz | 1280 x 720 @ 60Hz | |
| 800 x 600 @ 72Hz | 1280 x 720 @ 120Hz | |
| 800 x 600 @ 75Hz | 1600 x 1200 @ 60Hz | |
| 832 x 624 @ 75Hz | | |
| 1024 x 768 @ 60Hz | XGA/WXGA: | |
| 1024 x 768 @ 70Hz | 1440 x 900 @ 60Hz | |
| 1024 x 768 @ 75Hz | 1024 x 768 @ 120Hz | |
| 1280 x 1024 @ 75Hz | 1280 x 800 @ 60Hz | |
| 1152 x 870 @ 75Hz | 1280 x 1024 @ 60Hz | |
| | 1680 x 1050 @ 60Hz | |
| | 1280 x 720 @ 60Hz | |
| | 1280 x 720 @ 120Hz | |
| | 1600 x 1200 @ 60Hz | |
| | | |
| | 1080P: | |
| | 1280 x 720 @ 60Hz | |
| | 1280 x 800 @ 60Hz | |
| | 1280 x 1024 @ 60Hz | |
| | 1400 x 1050 @ 60Hz | |
| | 1600 x 1200 @ 60Hz | |
| | 1440 x 900 @ 60Hz | |
| | 1280 x 720 @ 120Hz | |
| | 1024 x 768 @ 120Hz | |

Appendices

| Digital | |
|-------------------------|---------------------|
| B1/Video mode | B1/Detail timing: |
| 640 x 480p @ 60Hz | 720 x 480p @ 60Hz |
| 720 x 480p @ 60Hz | 1280 x 720p @ 60Hz |
| 1280 x 720p @ 60Hz | 1366 x 768 @ 60Hz |
| 1920 x 1080i @ 60Hz | 1920 x 1080i @ 50Hz |
| 720(1440) x 480i @ 60Hz | 1920 x 1080p @ 60Hz |
| 1920 x 1080p @ 60Hz | |
| 720 x 576p @ 50Hz | |
| 1280 x 720p @ 50Hz | |
| 1920 x 1080i @ 50Hz | |
| 720(1440) x 576i @ 50Hz | |
| 1920 x 1080p @ 50Hz | |
| 1920 x 1080p @ 24Hz | |
| 1920 x 1080p @ 30Hz | |

3D Input Video Compatibility

| Input resolution | Input timing | | |
|---------------------|----------------------|---------------------------------------|-------------------------------------|
| HDMI 1.4a 3D Input | 1280 x 720p @ 50Hz | Top-and-Bottom | |
| | 1280 x 720p @ 60Hz | Top-and-Bottom | |
| | 1280 x 720p @ 50Hz | Frame packing | |
| | 1280 x 720p @ 60Hz | Frame packing | |
| | 1920 x 1080i @ 50 Hz | Side-by-Side (Half) | |
| | 1920 x 1080i @ 60 Hz | Side-by-Side (Half) | |
| | 1920 x 1080p @ 24 Hz | Top-and-Bottom | |
| | 1920 x 1080p @ 24 Hz | Frame packing | |
| HDMI 1.3 3D Content | 1920 x 1080i @ 50Hz | Side-by-Side (Half) | While 3D Format is "SBS" |
| | 1920 x 1080i @ 60Hz | | |
| | 1280 x 720p @ 50Hz | | |
| | 1280 x 720p @ 60Hz | | |
| | 1920 x 1080i @ 50Hz | Top-and-Bottom | While 3D Format is "Top and Bottom" |
| | 1920 x 1080i @ 60Hz | | |
| | 1280 x 720p @ 50Hz | | |
| | 1280 x 720p @ 60Hz | | |
| 480i | HQFS | While 3D Format is "Frame sequential" | |

Ceiling Mount Installation

1. To prevent damage to your projector, please use the InFocus ceiling mount.
2. If you wish to use a third party ceiling mount kit, please ensure the screws used to attach a mount to the projector meet the following specifications:

- ▶ Screw type: M4*3
- ▶ Minimum screw length: 10mm



❖ Please note that damage resulting from incorrect installation will void the warranty.



⚠ Warning:

1. If you buy a ceiling mount from another company, please be sure to use the correct screw size. Screw size will vary depending on the thickness of the mounting plate.
2. Be sure to keep at least 10 cm gap between the ceiling and the bottom of the projector.
3. Avoid installing the projector near a heat source.

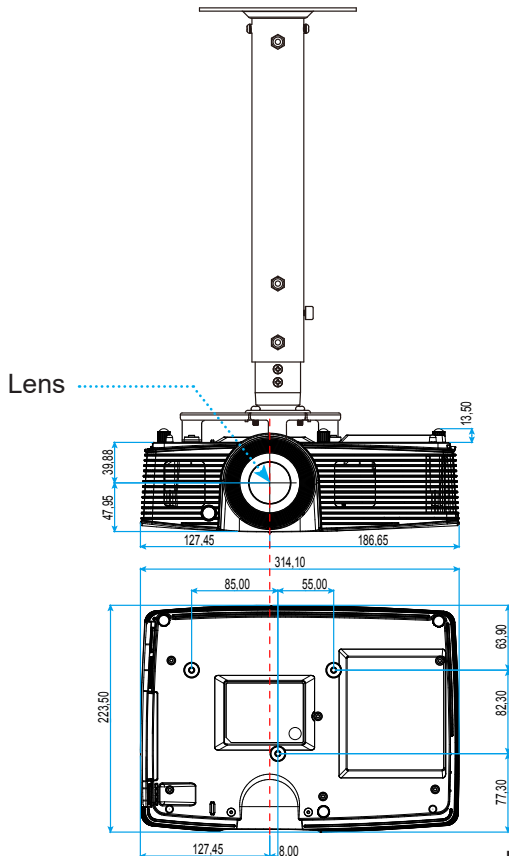

Unit: mm

Regulation & Safety Notices

This appendix lists the general notices of your projector.

FCC Notice

This device has been tested and found to comply with the limits for a Class B digital device pursuant to Part 15 of the FCC rules. These limits are designed to provide reasonable protection against harmful interference in a residential installation. This device generates, uses and can radiate radio frequency energy and, if not installed and used in accordance with the instructions, may cause harmful interference to radio communications.

However, there is no guarantee that interference will not occur in a particular installation. If this device does cause harmful interference to radio or television reception, which can be determined by turning the device off and on, the user is encouraged to try to correct the interference by one or more of the following measures:

- ❖ Reorient or relocate the receiving antenna.
- ❖ Increase the separation between the device and receiver.
- ❖ Connect the device into an outlet on a circuit different from that to which the receiver is connected.
- ❖ Consult the dealer or an experienced radio/television technician for help.

Notice: Shielded cables

All connections to other computing devices must be made using shielded cables to maintain compliance with FCC regulations.

Caution

Changes or modifications not expressly approved by the manufacturer could void the user's authority, which is granted by the Federal Communications Commission, to operate this projector.

Operation Conditions

This device complies with Part 15 of the FCC Rules. Operation is subject to the following two conditions:

1. This device may not cause harmful interference and
2. This device must accept any interference received, including interference that may cause undesired operation.

Notice: Canadian users

This Class B digital apparatus complies with Canadian ICES-003.

Remarque à l'intention des utilisateurs canadiens

Cet appareil numérique de la classe B est conforme à la norme NMB-003 du Canada.

Declaration of Conformity for EU countries

- EMC Directive 2004/108/EC (including amendments)
- Low Voltage Directive 2006/95/EC
- R & TTE Directive 1999/5/EC (if product has RF function)



Disposal instructions

Do not throw this electronic device into the trash when discarding. To minimize pollution and ensure utmost protection of the global environment, please recycle it.

