

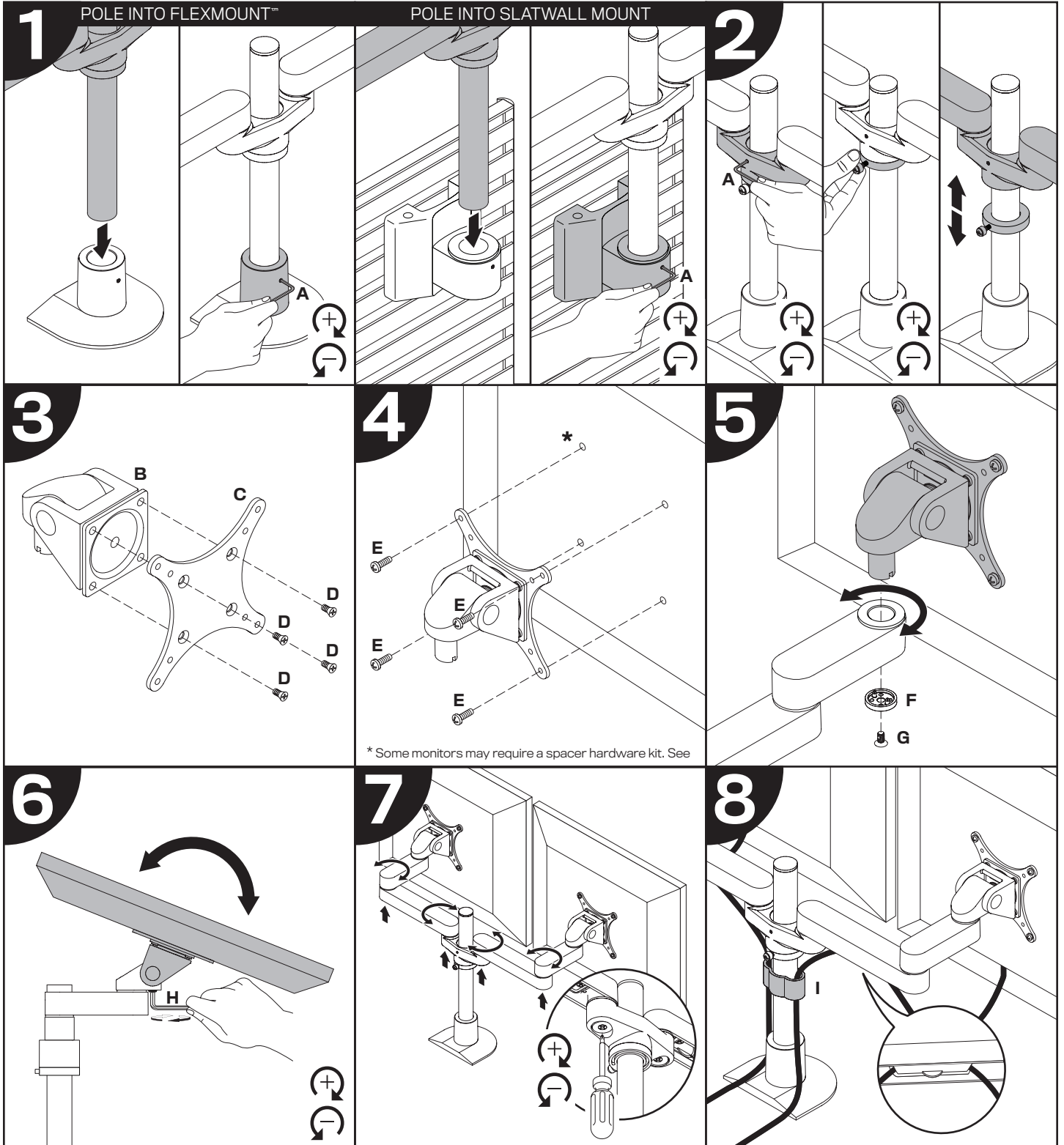

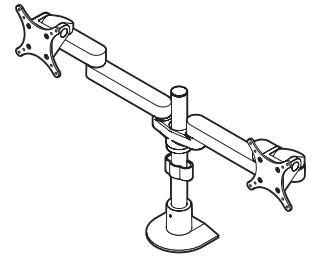



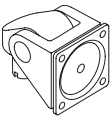

Innovative Ergonomic Solutions companies

MODEL 9120



MODEL 9120

ITEM	DESCRIPTION / PART NO.	
A		3/32" Allen Wrench 1 700146
B		Monitor Tilter 1 405397
C		75/100mm VESA® Adapter Plate 1 105587
D		10-32 x 3/8" Phillips Flat Head Screw 1 702281 (4-pack)
E		M4 x 12mm Phillips Pan Head Screw 1 702096 (4-pack)

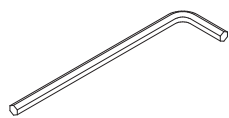
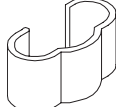
ITEM	DESCRIPTION / PART NO.	
F		Dog Washer 1 105189
G		0-32 x 3/8" FPhMS w/Lock Patch 1 705198
H		7/32" Allen Wrench 1 701127
I		Cable Clip 1 702506

OPTIONAL SPACER KITS In some cases, the mounting surface on your monitor may be recessed further than permitted by VESA® standards. As a result, a spacer kit may be required.

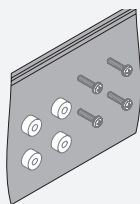
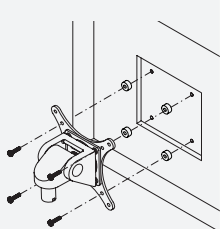

.25" Spacer Hardware Kit
 (4) .25" Spacers
 (4) M4 x 18mm Phillips Pan Head Screws
 Order # P404923-B

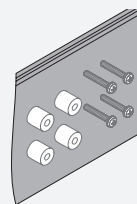

.5" Spacer Hardware Kit
 (4) .5" Spacers
 (4) M4 x 25mm Phillips Pan Head Screws
 Order # P404923-C