

AC/DC High Power Electronic Load

AEL-5000 Series

USER MANUAL



ISO-9001 CERTIFIED MANUFACTURER

GW INSTEK

This manual contains proprietary information, which is protected by copyright. All rights are reserved. No part of this manual may be photocopied, reproduced or translated to another language without prior written consent of Good Will company.

The information in this manual was correct at the time of printing. However, Good Will continues to improve products and reserves the rights to change specification, equipment, and maintenance procedures at any time without notice.

Good Will Instrument Co., Ltd.
No. 7-1, Jhongsing Rd., Tucheng Dist., New Taipei City 236, Taiwan.

Table of Contents

SAFETY INSTRUCTIONS	4
GETTING STARTED	8
The most complete measurement function	9
AEL-5000 Series Introduction	11
Accessories	16
Operating Mode Description	18
Operating Area	22
Appearance	27
FUNCTION DESCRIPTION	39
Function keys description	40
Store or Recall functions	56
Sequence Functions	57
Wave Function description	61
Test Function description	71
Entry key description	102
CONNECTION	104
Rear Panel	105
Connecting the I-monitor to an oscilloscope	109
Master/Slave Description	110
2 operating modes for Master/Slave	112
REMOTE operating	117
INSTALLATION	120
Check line voltage	121
Grounding requirements	122
Power up	123
Connection to the load Input Terminal	124
Interface Card	125

RS232 interface option.....	126
GPIB interface option	127
USB interface option.....	127
LAN interface option	127
I/O connection	128
Load wire inductance.....	129
Parallel and three-phase control	133
REMOTE CONTROL.....	134
Interface Configuration	135
Communication Interface programming command list.....	137
Command Syntax.....	148
Command List	150
PRESET Commands	152
Limit Commands	165
STATE commands	167
System Commands	173
Measure Commands.....	176
APPLICATION.....	178
Local sense connections	179
Remote sense connections	181
Constant Current mode and LIN mode application	183
Constant Resistance mode application	185
Constant Voltage mode application	187
Constant Power mode application	189
Battery discharge test application.....	191
Current protection component test.....	194
AC rectified load simulation.....	197
Parallel operation	198
Inrush Current	200
Power Supply OCP testing	203
Power Supply OPP testing	205
SHORT testing.....	207

BW Setting.....	209
Special waveform applications.....	210
APPENDIX.....	211
Replacing the Fuse.....	212
AEL-5000 Default Settings	214
AEL-5000 Dimensions.....	218
AEL-5000 series Specifications	222
Declaration of Conformity.....	244
GPIB programming Example.....	245
AEL-5000 Series USB Instruction	249
AEL-5000 series Auto, Sequence function provide EDIT, ENTER, EXIT, TEST and STORE 5 keys operation.....	251
AEL-5000 Series LAN Instruction	255

S SAFETY INSTRUCTIONS

This chapter contains important safety instructions that you must follow during operation and storage. Read the following before any operation to insure your safety and to keep the instrument in the best possible condition.

Safety Symbols

These safety symbols may appear in this manual or on the instrument.



WARNING

Warning: Identifies conditions or practices that could result in injury or loss of life.



CAUTION

Caution: Identifies conditions or practices that could result in damage to the instrument or to other properties.



DANGER High Voltage



Attention Refer to the Manual



Earth (ground) Terminal



Frame or Chassis Terminal



Do not dispose electronic equipment as unsorted municipal waste. Please use a separate collection facility or contact the supplier from which this instrument was purchased.

Safety Guidelines

General Guideline



CAUTION

- Do not place any heavy object on the instrument. Note: Only 2 units can be stacked vertically.
- Avoid severe impact or rough handling that leads to damaging the instrument.
- Do not discharge static electricity to the instrument.
- Use only crimped wires, not bare wires, for the terminals.
- Do not block the cooling fan opening.
- Do not disassemble the instrument unless you are qualified.
- The equipment is not for measurements performed for CAT II, III and IV.

(Measurement categories) EN 61010-1:2010 specifies the measurement categories and their requirements as follows.

- Measurement category IV is for measurement performed at the source of low-voltage installation.
- Measurement category III is for measurement performed in the building installation.
- Measurement category II is for measurement performed on the circuits directly connected to the low voltage installation.
- 0 is for measurements performed on circuits not directly connected to Mains.

Do NOT position the equipment so that it is difficult to disconnect the appliance inlet or the power plug.

If the equipment is used in a manner not specified by the manufacturer, the protection provided by the equipment may be impaired.

Power Supply



WARNING

- AC Input voltage range: 100Vac~240Vac \pm 10%
- Frequency: 47-63Hz
- Power for every model

Model	Power
AEL-5002-350-18.75, AEL-5003-350-28 AEL-5004-350-37.5	150VA
AEL-5002-425-18.75 AEL-5003-425-28 AEL-5004-425-37.5	
AEL-5003-480-18.75 AEL-5004-480-28	
AEL-5006-350-56 AEL-5008-350-75 AEL-5006-425-56 AEL-5008-425-75	270VA
AEL-5012-350-112.5 AEL-5012-425-112.5	390VA
AEL-5015-350-112.5 AEL-5015-425-112.5	510VA
AEL-5019-350-112.5 AEL-5019-425-112.5	630VA
AEL-5023-350-112.5 AEL-5023-425-112.5	750VA

- To avoid electrical shock connect the protective grounding conductor of the AC power cord to an earth ground.
- To avoid electric shock, the power cord protective grounding conductor must be connected to ground. No operator serviceable components inside. Do not remove covers. Refer servicing to qualified personnel.

Cleaning

- Disconnect the power cord before cleaning.
- Use a soft cloth dampened in a solution of mild detergent and water. Do not spray any liquid.
- Do not use chemicals containing harsh material such as benzene, toluene, xylene, and acetone.

Operation Environment

- Location: Indoor, no direct sunlight, dust free, almost non-conductive pollution (Note below)
- Temperature: 0°C to 40°C
- Humidity: 0 to 85% RH
- Altitude: <2000m
- Overvoltage category II

(Pollution Degree) EN 61010-1:2010 specifies the pollution degrees and their requirements as follows. The instrument falls under degree 2.

Pollution refers to “addition of foreign matter, solid, liquid, or gaseous (ionized gases), that may produce a reduction of dielectric strength or surface resistivity”.

- Pollution degree 1: No pollution or only dry, non-conductive pollution occurs. The pollution has no influence.
- Pollution degree 2: Normally only non-conductive pollution occurs. Occasionally, however, a temporary conductivity caused by condensation must be expected.
- Pollution degree 3: Conductive pollution occurs, or dry, non-conductive pollution occurs which becomes conductive due to condensation which is expected. In such conditions, equipment is normally protected against exposure to direct sunlight, precipitation, and full wind pressure, but neither temperature nor humidity is controlled.

Storage environment

- Location: Indoor
- Temperature: -20°C to 70°C
- Humidity: <90% RH

Disposal



Do not dispose this instrument as unsorted municipal waste. Please use a separate collection facility or contact the supplier from which this instrument was purchased. Please make sure discarded electrical waste is properly recycled to reduce environmental impact.

GETTING STARTED

AEL-5000 Series is suitable for the step, square and sine wave of the AC Power device test. Especially for the uninterruptible power supply UPS, Inverter, fuses, circuit breakers, power regulator AVR, Battery, AC/ DC power supply/ components ... and so on, absolutely is the best test solution in the market.

AEL-5000 LOAD Operating mode

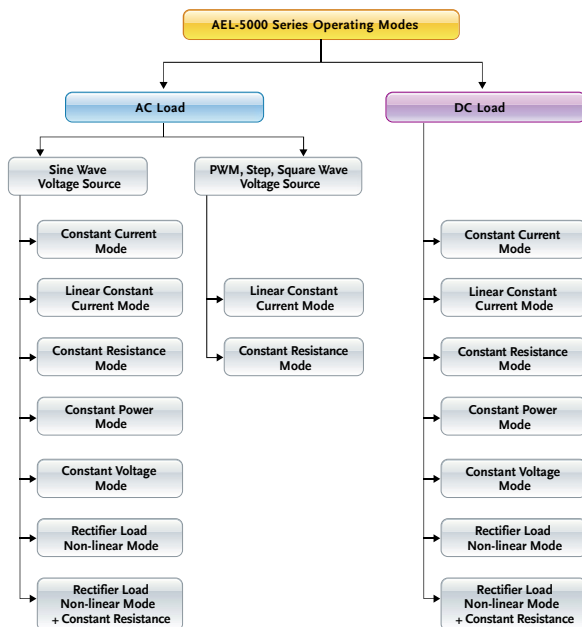

The most complete measurement function

AEL-5000 Series AC/ DC electronic load has built-in 16-bit precision measurement circuit, providing accurate measurement values, measuring items include voltage rms (V_{rms}), current rms (A_{rms}), watts (Watt), volt ampere (VA), crest factor (CF), power factor (PF), voltage total harmonic distortion (VTHD), voltage harmonics (VH), current total harmonic distortion (ITHD), current Harmonics (IH), peak current (I_{peak}), maximum ampere (A_{max}), minimum ampere (A_{min}), maximum voltage (V_{max}), and minimum voltage (V_{min}).

In addition to these measurement functions, it also provides time measurement, such as UPS back up time, fuses and circuit breakers' trip or blow time and Off-line UPS transfer time.

Note*1 : ms= milli - siemens = $1/k\Omega$

Note*2 : The operating temperature range is $0 \sim 40^{\circ}C$, accuracy of this specification is $25^{\circ}C \pm 5^{\circ}C$

AEL-5000 test mode

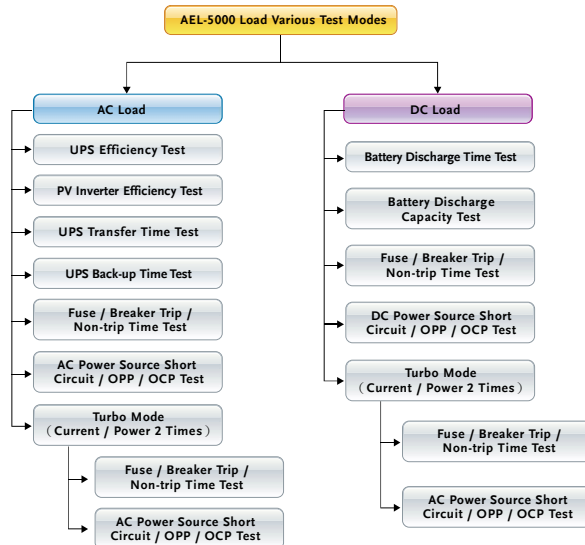



AEL-5000 Series Introduction..... 11

- Model Line Up 11
- Main Features 12
- Protection features 14

Accessories..... 16

- AEL-5002-xxx-18.75/AEL-5003-xxx-28/
AEL-5004-xxx-37.5 16
- AEL-5006-xxx-56/AEL-5008-xxx-78/AEL-5012-xxx-
112.5/AEL-5015-xxx-112.5/AEL-5019-xxx-112.5
/AEL-5023-xxx/112.5 16

Operating Mode Description 18

- AC load mode 18
- DC load mode 20

Operating Area 22

Appearance..... 27

- Front Panel..... 27
- LCD Display 29

AEL-5000 Series Introduction

Model Line Up

When Turbo is off

Model	Voltage (Volt)	Current	Power
AEL-5002-350-18.75	50~350Vrms/500Vdc	18.75 Arms / 56.25Apeak	1875 W
AEL-5003-350-28	50~350Vrms/500Vdc	28 Arms / 84Apeak	2800W
AEL-5004-350-37.5	50~350Vrms/500Vdc	37.5 Arms / 112.5Apeak	3750 W
AEL-5006-350-56	50~350Vrms/500Vdc	56.0Arms/168Aprak	5600W
AEL-5008-350-75	50~350Vrms/500Vdc	75.0Arms/225Aprak	7500W
AEL-5012-350-112.5	50~350Vrms/500Vdc	112.5.0Arms/337.5Aprak	11250W
AEL-5015-350-112.5	50~350Vrms/500Vdc	112.5.0Arms/337.5Aprak	15000W
AEL-5019-350-112.5	50~350Vrms/500Vdc	112.5.0Arms/337.5Aprak	18750W
AEL-5023-350-112.5	50~350Vrms/500Vdc	112.5.0Arms/337.5Aprak	22500W
AEL-5002-425-18.75	50~425Vrms/600Vdc	18.75 Arms / 56.25Apeak	1875 W
AEL-5003-425-28	50~425Vrms/600Vdc	28 Arms / 84Apeak	2800W
AEL-5004-425-37.5	50~425Vrms/600Vdc	37.5 Arms / 112.5Apeak	3750 W
AEL-5006-425-56	50~425Vrms/600Vdc	56.0Arms/168Aprak	5600W
AEL-5008-425-75	50~425Vrms/600Vdc	75.0Arms/225Aprak	7500W
AEL-5012-425-112.5	50~425Vrms/600Vdc	112.5.0Arms/337.5Aprak	11250W
AEL-5015-425-112.5	50~425Vrms/600Vdc	112.5.0Arms/337.5Aprak	15000W
AEL-5019-425-112.5	50~425Vrms/600Vdc	112.5.0Arms/337.5Aprak	18750W
AEL-5023-425-112.5	50~425Vrms/600Vdc	112.5.0Arms/337.5Aprak	22500W
AEL-5003-480-18.75	50~480Vrms/700Vdc	18.75 Arms / 56.25Apeak	2800W
AEL-5004-480-28	50~480Vrms/700Vdc	28 Arms / 84Apeak	3750 W

When Turbo is on

Model	Voltage (Volt)	Current	Power
AEL-5002-350-18.75	50~350Vrms/500Vdc	37.5Arms/56.25Apeak	3750W
AEL-5003-350-28	50~350Vrms/500Vdc	56Arms/84Apeak	5600W
AEL-5004-350-37.5	50~350Vrms/500Vdc	75.0Arms/112.5Apeak	7500W
AEL-5006-350-56	50~350Vrms/500Vdc	112.0Arms/168Aprak	11200W
AEL-5008-350-75	50~350Vrms/500Vdc	150.0Arms/225Aprak	15000W
AEL-5012-350-112.5	50~350Vrms/500Vdc	225.0Arms/337.5Aprak	22500W
AEL-5015-350-112.5	50~350Vrms/500Vdc	225.0Arms/337.5Aprak	30000W
AEL-5019-350-112.5	50~350Vrms/500Vdc	225.0Arms/337.5Aprak	37500W

AEL-5023-350-112.5	50~350Vrms/500Vdc	225.0Arms/337.5Aprak	45000W
AEL-5002-425-18.75	50~425Vrms/600Vdc	37.5Arms/56.25Apeak	3750W
AEL-5003-425-28	50~425Vrms/600Vdc	56Arms/84Apeak	5600W
AEL-5004-425-37.5	50~425Vrms/600Vdc	75.0Arms/112.5Apeak	7500W
AEL-5006-425-56	50~425Vrms/600Vdc	112.0Arms/168Aprak	11200W
AEL-5008-425-75	50~425Vrms/600Vdc	150.0Arms/225Aprak	15000W
AEL-5012-425-112.5	50~425Vrms/600Vdc	225.0Arms/337.5Aprak	22500W
AEL-5015-425-112.5	50~425Vrms/600Vdc	225.0Arms/337.5Aprak	30000W
AEL-5019-425-112.5	50~425Vrms/600Vdc	225.0Arms/337.5Aprak	37500W
AEL-5023-425-112.5	50~425Vrms/600Vdc	225.0Arms/337.5Aprak	45000W
AEL-5003-480-18.75	50~480Vrms/700Vdc	37.5Arms/56.25Apeak	5600W
AEL-5004-480-28	50~480Vrms/700Vdc	56Arms/84Apeak	7500W

Main Features

- Performance**
- Four meters can be displayed V/A/W Meter, display the Voltage (Vrms, Vpeak, Vmax., Vmin), Current (Irms, I Peak, Imax. Imin.) Watt, Voltampere (VA), Frequency, Crest Factor, Power Factor, Total Harmonic Distortion of Voltage (VTHD), Voltage Harmonic (VH), Total Harmonic Distortion of Current (ITHD), Current Harmonic (IH) Remote Control via a choice of Computer interfaces.
 - Support on-load boot; at first set Load ON to support on-load boot, inverter or uninterruptible power supply is turned on directly with the set load current, used to verify whether the starter is stable when the Inverter is connected.
 - Supports the loading and unloading angle control; the loading and unloading angle control, the full range of 0-359 degrees can be set to verify whether the Inverter output voltage transient response is stable when the actual electrical plugging and unplugging, and whether Overshoot/Undershoot is within the

allowable range.

- Support positive half-cycle or negative half-cycle loading; used to verify whether the inverter output voltage remains stable when the actual appliance has only positive half-cycle or negative half-cycle load current.
- Supports SCR/TRIAC current phase modulation waveforms, 90 degree Trailing edge and Leading Edge.
- Supports the Inrush Current of the power supply at startup and the Surge Current test when the load is suddenly plugged in (Hot Plug-in).

Features

- AC / DC load with CC, Linear CC, CR, CV, CP and Rectifier Load mode
 - Frequency Range : DC, 40~440Hz
 - Crest factor adjustable range : 1.4~5.0
 - Power factor (PF) adjustable range: 0~1 lead or (~1~0)lag
 - Built-in test modes include UPS Efficiency, PV Inverter Efficiency, UPS Back-up time, Battery Discharge time, UPS transfer time, Fuse/Breaker Trip / Non-Trip, short circuit simulation, OCP, OPP, etc.
 - Turbo mode, which can withstand up to twice the current (225A) and power (45KW) electronic load in a short time, the most suitable for Fuse / Breaker and AC power short circuit, OCP, OPP test.
 - Up to three parallel up to 22500W and three-phase Δ or Y load synchronization control.
 - Maximum power of single-phase can up to 180KW, 3-phase total power up to 540KW 3-phase Δ or Y connection parallel connection can be controlled by external voltage for CC, Linear CC, CR, CP, CV mode (Option)
 - Measure the fuse and circuit breaker trip or
-

blow time

- Measure the UPS OFF- line transfer time (Transfer time)
- Perform short circuit simulation(can set the short circuit time), OCP, OPP test
- Over voltage warning, over current, over power, over temperature protection.
- 150 set Store/Recall memory.

Interface

- Optional interface: GPIB, RS232, USB, LAN.

Protection features

The protection features of the AEL-5000 series electronic load modules are as follows:

Overvoltage protection The Electronic Load input will turn OFF if the overvoltage circuit is tripped. The message OVP will be displayed on the LCD. When the OVP fault has been removed the load can be set to sink power again. While the unit will attempt to protect itself given an OVP state it is strongly advised to guard against any potential OVP fault state by using external protection and the correctly rated electronic load.

The Overvoltage protection circuit is set at a predetermined voltage and cannot be adjusted. The OVP level is 105% of the AEL-5000 Series nominal voltage rating.

Caution Never apply an AC voltage to the input of the AEL-5000 Series Load. Do not apply a DC voltage that is higher than AEL-5000 Series Load rating. If this advice is ignored it is likely that damage will be caused to the electronic load module. This damage will not be covered by the warranty.

Over current protection (OCP) The OCP protection will engage if the current being taken by the load reaches 105% of the load module's maximum current. The message OCP

	will be displayed on the front panel and the unit will switch to its LOAD OFF state. Once the source of the over current has been removed the load can be switched on again.
Over power protection (OPP)	The AEL-5000 Series Electronic Load monitors the power dissipation level. The input to the load is automatically switched to LOAD OFF if the power dissipation is greater than 105% of the rated power input. If an over power condition occurs the display will show OPP
Over temperature protection	The load internal temperature at the heat sink is monitored. If the temperature reaches approximately 100°C the OTP message will be displayed and the unit will automatically switch to the LOAD OFF state. If an OTP error occurs please check the ambient temperature is between 0 to 40°C. Also ensure that the front and rear air vents of the mainframe are not obstructed. The air flow is taken from the front of the mainframe and exhausted from the rear. Therefore a suitable gap needs to be left at the rear of the mainframe. A minimum of 15cm is recommended. After a suitable cooling period the load can be switched.

Accessories

AEL-5002-xxx-18.75/AEL-5003-xxx-28/AEL-5004-xxx-37.5

Standard Accessories	Description	PCs
AEL-5000 series operation manual	It can be downloaded from GW instek website.	1
Terminal PTV1-12; PIN TRML 6		6
SLS10B RED; PLUG CONN 20A RED		1
SLS10B BLK; PLUG CONN 20A BLK		1
RNB 22-6S RING TRML,#4		2
HD-DSUB	15pin MALE to MALE 150cm	1

AEL-5006-xxx-56/AEL-5008-xxx-78/AEL-5012-xxx-112.5/AEL-5015-xxx-112.5/AEL-5019-xxx-112.5/AEL-5023-xxx/112.5

Standard Accessories	Description	PCs
AEL-5000 series operation manual	It can be downloaded from GW instek website.	
Round terminal PVL-1-4		2
Round terminal RNYBS8-4		2
Terminal PTV1-12		6
HD-DSUB	15pin MALE to MALE 150cm	1
Optional Accessories	Description	PCs
GPIB+RS232 interface	PEL-030	1
RS232 interface	PEL-023	1
GPIB interface	PEL-022	1

USB interface + USB driver(The driver can be downloaded from GW instek website)	PEL-025	1
LAN interface + LAN driver (The driver can be downloaded from GW instek website)	PEL-024	1
GPIB cable	GTL-250 GPIB Cable,0.6m	1
GPIB cable	GTL-248 GPIB Cable,2m	1
USB cable	GTL-246 USB Cable,1.2m	1
AEL-5000, AEL-5006, AEL-5008, AEL-5012 and AEL-5015 handle	PEL-028	1
AEL-5002, AEL-5003 and AEL-5004 handle	PEL-029	1
AEL-5000, AEL-5000 GPIB and RS-232 interface	PEL-030	1

Operating Mode Description

AC load mode

CC Mode With the operating mode of Constant Current, the AEL-5000 Series electronic load will sink a current in accordance with the programmed value regardless of the input voltage

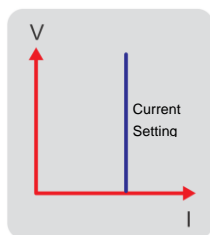

Linear C.C. Mode During Linear C.C. mode, the load current input into AEL-5000 Series High Power Electronic Load depends on the current setting regardless of the input voltage, e.g., the current setting remains unchanged. Please refer to Fig.1-8. The load input current signal will follow input voltage signal that is useful for step wave-form and square wave-form device.

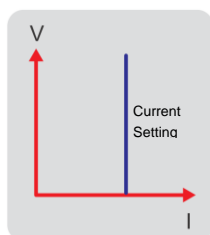

CR Mode At Constant Resistance mode, the AEL-5000 Series Electronic Load will sink a current linearly proportional to the load input voltage in accordance with the programmed resistance setting

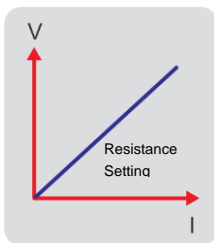

CP Mode

At Constant Power mode, the AEL-5000 Series Electronic Load will attempt to sink load power (load voltage * load current) in accordance with the programmed power.

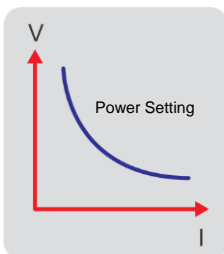

CV Mode

At Constant Voltage mode, the AEL-5000 Series Electronic Load will attempt to sink enough current until the load input voltage reaches the programmed value.

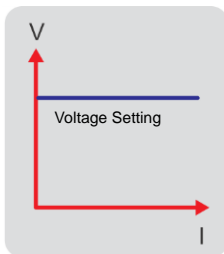

DC load mode

CC Mode

With the operating mode of Constant Current, the AEL-5000 Series electronic load will sink a current in accordance with the programmed value regardless of the input voltage

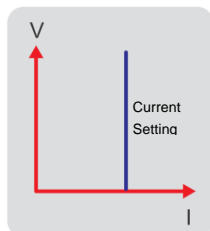

CR Mode

At Constant Resistance mode, the AEL-5000 Series Electronic Load will sink a current linearly proportional to the load input voltage in accordance with the programmed resistance setting

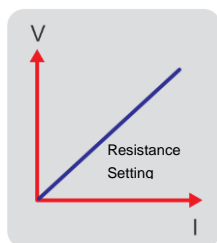

CP Mode

At Constant Power mode, the AEL-5000 Series Electronic Load will attempt to sink load power (load voltage * load current) in accordance with the programmed power.

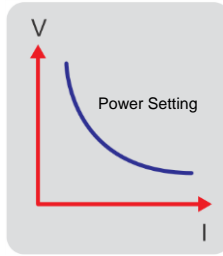

CV Mode

At Constant Voltage mode, the AEL-5000 Series Electronic Load will attempt to sink enough current until the load input voltage reaches the programmed value.

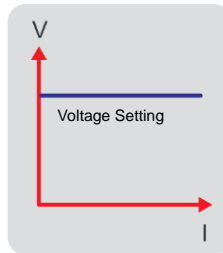

Operating Area

AEL-5000 Series AC/DC electronic load can be used to work with GPIB, RS232, USB or LAN interface and panel manual operation can be made available.

The electronic load operating environment temperature is 0 °C ~ 40 °C, full power operation for a period of time may produce OTP.

AEL-5002-350-18.75

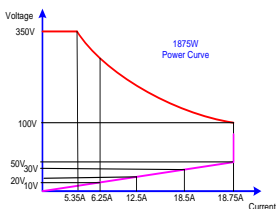

AEL-5003-350-28

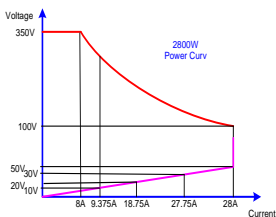

AEL-5004-350-37.5

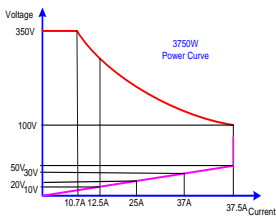

AEL-5002-425-18.75

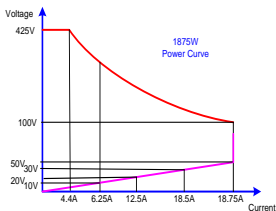

AEL-5003-425-28

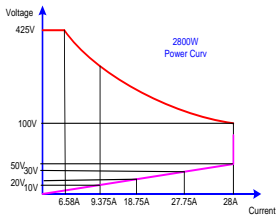

AEL-5004-425-37.5

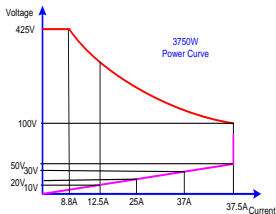

AEL-5006-350-56

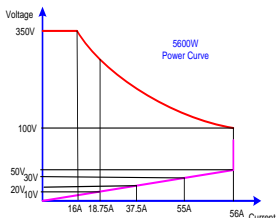

AEL-5008-350-75

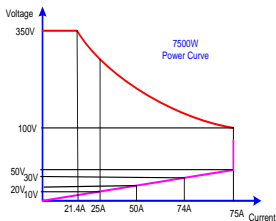

AEL-5012-350-112.5

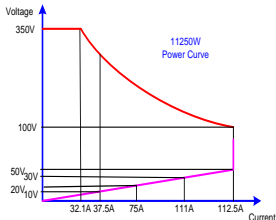

AEL-5015-350-112.5

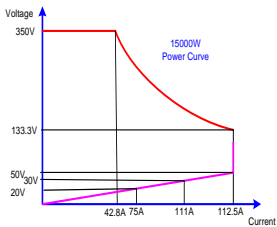

AEL-5019-350-112.5

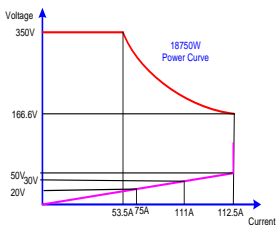

AEL-5023-350-112.5

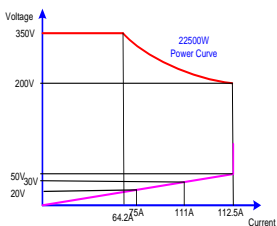

AEL-5006-425-56

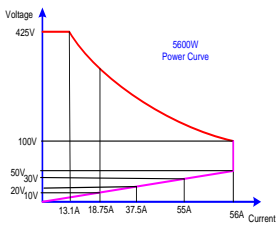

AEL-5008-425-75

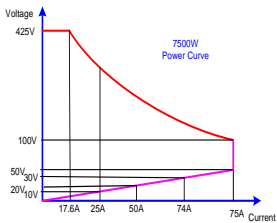

AEL-5012-425-112.5

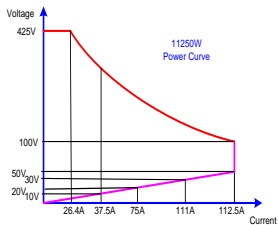

AEL-5015-425-112.5

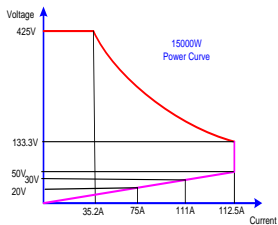

AEL-5019-425-112.5

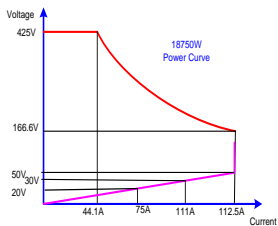

AEL-5023-425-112.5

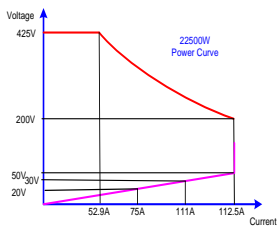

AEL-5003-480-18.75

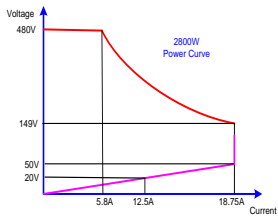

AEL-5004-480-28

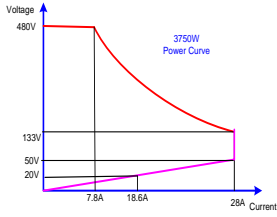

Appearance

Front Panel

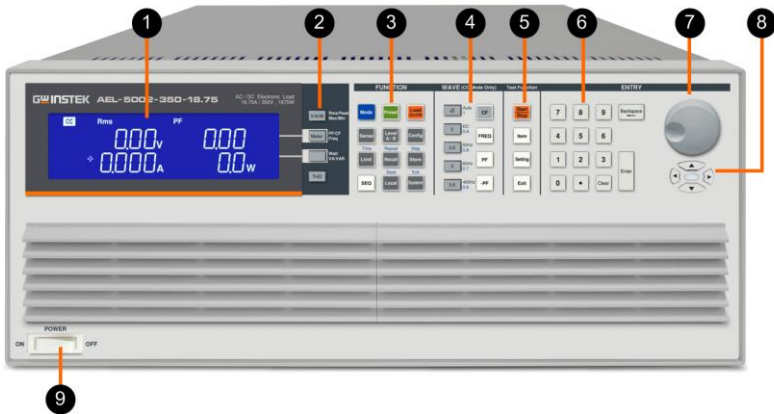

- | | | |
|---|----------------------------|---|
| 1 | LCD Multi-function display | Four meters can display the voltage value at the same time Voltage(V_{rms} , V_{peak} , V_{max} , V_{min}), Current (I_{rms} , I_{peak} , I_{max} , I_{min}), Watt, Voltampere (VA), Frequency, Crest Factor, Power Factor, Total Harmonic Distortion of Voltage(VTHD), Voltage Harmonic (VH), Total Harmonic Distortion of Current (ITHD), Current Harmonic (IH) |
| 2 | Meter Switch button | V/AW keys can set the display Rms/Peak/Max/Min, Meter key can select PF/CF/FREQ, switchable display WATT/VA/VAR keys, THD keys choose to display THD. |
| 3 | Operate function keys | Mode, Preset ON/OFF, Load ON/OFF, Sense ON/OFF, Level A/B, Config, Limit, Recall, Store, SET, Local, System operate keys. |
| 4 | Waveform library keys | These keys can be quickly set CF /2/2.5/3/3.5, PF0.6/0.7/0.8/0.9/1.0, FREQ Auto/50Hz/60Hz/400Hz |

- 5 Test function keys These keys can select Short/OPP/OCP/Non-L/NL-CR/Fuse/Batt(Battery Discharge)Trans(UPS transfer time) test functions.
- 6 Number keypad
- 7 Knob setting
- 8 Power switch
- 9 Cursor and button setting

LCD Display

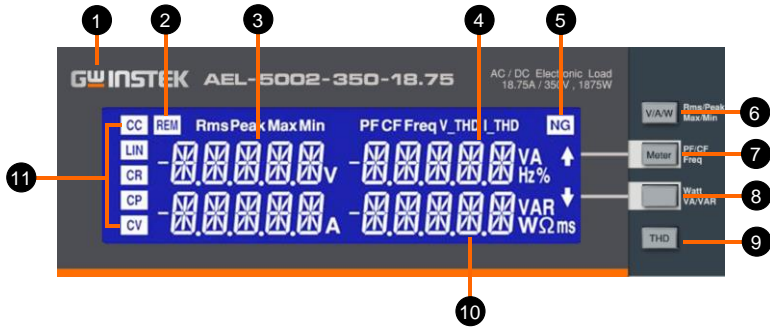

- | | |
|--------------------------------|--|
| 1 Model number and sink ranges | Refers to model number, voltage, current and power specification of AEL-5000 Series High Power AC/DC Electronic Load. |
| 2 REM LCD Indicator | When AEL-5000 Series AC/DC Electronic Load is connected with computer program for control and operation, REM LED Indicator will come on. In such a case, panel manual operation will become null and void. When REM LED indicator comes off, panel manual operation will resume. |
| 3 Left 5 digit LCD display | The 5 digit LCD display is a multi-function display. The function of the display changes depending whether the user is in NORMAL mode or in a SHORT, OPP, Non-L, NL+CR, FUSE, BATT , TRANS, INRUSH, SURGE test modes |
| Normal mode | <p>The left 5 digit display displays the voltage present at the load’s input terminals. The value displayed will include the automatic voltage compensation if the sense terminals are also connected to the device under test (DUT).</p> <p>If V-sense is set to “ON” and the sense terminals are connected to the DUT the load will check and compensate for all voltage</p> |

	drops.
Test mode	<p>If the Item buttons are pressed the left display will show a text Message that correlates with the selected test function.</p> <ul style="list-style-type: none"> • SHORT test selected: left display will show "Short". • OPP test selected: left display will show "OPP". • OCP test selected: left display will show "OCP". • Non-L test selected: left display will show "Non-L". • NL+CR test selected: left display will show "NL+CR". • FUSE test selected: left display will show "FUSE". • BATT test selected: left display will show "BATT". • TRANS test selected: left display will show "TRANS". • INRUSH test selected: left display will show "INRUSH". • SURGE test selected: left display will show "SURGE". <p>During the test the left display will show the load Input voltage.</p>
4 Right upper 5 digit LCD display	The right upper 5 digit displays also changes function depending if the user is in normal mode or has entered a setting menu.
Normal mode	In normal mode the middle LCD display functions as a 5 digit ammeter. The 5 digit DAM shows the load current flowing into the DC load when the Load is ON.
Setting mode	If CONFIG, LIMIT, buttons are pressed the middle LCD show a text message according to

the setting function it is in. Each subsequent press of the button moves the display to the next available function. The sequence of each setting menu is detailed below

- CONFIG:
Sequence is "EXTIN OFF" → SYNC OFF → "LD ON" → "LDOFF" → "BW" → "AVG" → "CPRSP" → "CYCLE" → "SNUB".
- LIMIT:
Sequence is "V_Hi" → "V_Lo" → "I_Hi" → "I_Lo" → "W_Hi" → "W_Lo" → "VA_Hi" → "VA_Lo" → "OPL" → "OCL" → "NG".

5 NG LCD indicator The user can adjust upper and lower limits for voltage, current and power within the CONFIG menu and turn the NG Indicator ON. If a voltmeter, ammeter or wattmeter measurement is outside these set limits then the NG indicator will illuminate.

6 V/A/W key There are four operating modes. These can be selected in turn by pressing the "V/A/W" key on the AEL-5000 Series AC/DC Electronic Load. The sequence is:

- Rms
- Peak
- Max
- Min

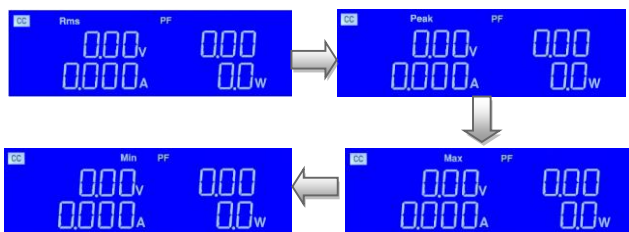

7 Master key There are three operating modes. These can be selected in turn by pressing the "Meter" key on the AEL-5000 Series AC/DC Electronic Load. The sequence is:

- PF
- CF
- Freq

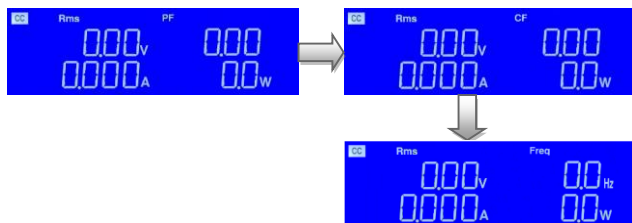

**8 WATT/VA/
VAR Key**

There are three operating modes. These can be selected in turn by pressing the “WATT/VA/VAR” key on the AEL-5000 series AC/DC Electronic Load. The sequence is:

- W
- VA
- VAR

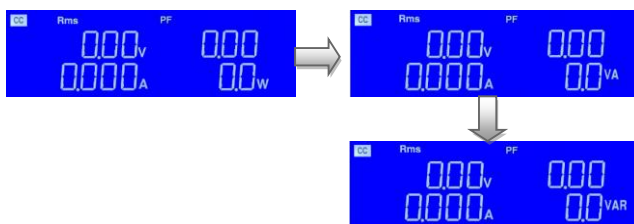

9 THD Key

There are four operating modes. These can be selected in turn by pressing the “THD” key on the AEL-5000 Series AC/DC Electronic Load. The sequence is:

- V_THD
- I_THD
- V_H
- I_H
- PF

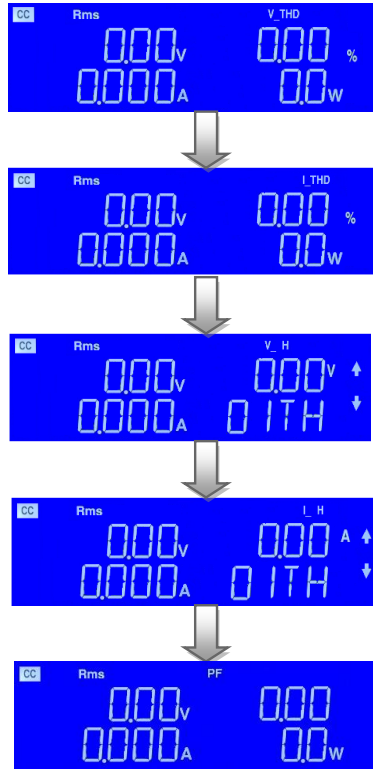

- In V_H operating modes, these can be selected in turn by pressing the “PF/ CF/ FREQ” key and WATT/ VA/ VAR Key to adjust, the setting range is 01TH ~ 50TH.



- In I_H operating modes, these can be selected in turn by pressing the “PF/ CF/ FREQ” key and WATT/ VA/ VAR Key to adjust, the setting range is 01TH~ 50TH.



10	Right lower 5 digit LCD display	The right 5 digit displays also changes function depending if the unit is in normal mode or one of the setting menus has been activated.
	Normal mode	In normal mode the right 5 digit displays shows the power consumption in Watts (W).
	Setting mode	<p>The right display together with the rotary adjustment knob is used to set values.</p> <p>The value changes according to the setting function that is active. The middle LCD provides a text message to tell the user which part of the setting menu is active.</p> <p>PRESET mode</p> <p>The value of the setting entered on the right display changes depending on the operating MODE that has been selected</p> <ul style="list-style-type: none"> • If CC mode is selected the right display provides setting in amps "A". • If LIN mode is selected the right display provides setting in amps "A" • If CR mode is selected the right display provides setting in ohms "Ω"

- If CP mode is selected the right display provides setting in watts “W”.
 - If CV mode is selected the right display provides setting in volts “V”.
-

LIMIT

Each press of the LIMIT button changes the middle LCD text. The sequence and the corresponding setting value shown on the bottom display is as follows:

- V_Hi (left limit voltage) displays the set value in volts “V”
 - V_Lo (right limit voltage) displays the set value in volts “V”
 - I_Hi (left limit current) displays the set value in amps “A”
 - I_Lo (right limit current) displays the set value in amps “A”
 - W_Hi (left limit power) displays the set value in watts “W”
 - W_Lo (right limit power) displays the set value in watts “W”
 - VA_Hi (left limit power) displays the set value in VA “VA”
 - VA_Lo (right limit power) displays the set value in VA “VA”
 - OPL (right limit power) displays the set value in watts “W”
 - OCL (right limit power) displays the set value in amps “A”
 - NG displays whether the NG flag is set to “ON” or “OFF”.
-

CONFIG

Each press of the CONFIG button changes the right upper LCD Text.

The sequence and the corresponding setting

value shown on the bottom displays are as follows:

- EXTIN can be set to "OFF" or "ON"
 - SYNC can be set to "OFF" or "ON"
 - LD ON
 - LDOFF
 - BW can be set to 1~15.
 - AVG can be set to 1, 2, 4, 8, 16.
 - CPRSP can be set to 0~7.
 - CYCLE can be set to 1~16.
 - SNUB can be set to "AUTO" or "ON" or "OFF".
-

SHORT Test

This allows the parameters of the short test to be set up.

Each press of the Item button and Setting button moves the setting function. The sequence of the short test along with the setting value is as follows:

- Short Press Start (pressing the red START/STOP button starts the test)
TURBO shows the ON or OFF.
- TIME shows the duration of the SHORT test. "CONTI", on the bottom display indicates continuous. Time can be adjusted in "ms".
- V-Hi (voltage high threshold) displays the set value in volts "V"
- V-Lo (voltage low threshold) displays the set value in volts "V"

When the test is started the right display will show RUN. When the test has finished the right display will show END.

OPP Test

This allows the parameters of the over power

protection test to be set up. Each press of the Item button and Setting button moves the set function. The sequence of the OPP test along with the setting value is as follows:

- OPP Press Start (pressing the red START/STOP button starts the test) TURBO shows the ON or OFF.
- PSTAR (power start point) right display provides setting in watts "W"
- PSTEP (power steps) right display provides setting in watts "W"
- PSTOP (power stop point) right display provides setting in watts "W"
- VTH (voltage threshold) right display provides setting in volts "V"

When the test is started the right display will show the power value being taken by the load. If the Device Under Test is able to supply the load according to the values set then the right display will show PASS and the right display will show the maximum power taken during the OPP test. If, during the test, OTP is displayed the over temperature protection has been engaged. Similarly if OPP is shown on the display the over power protection has been activated.

OCP Test

This allows the parameters of the over current protection test to be set up. Each press of the Item button and Setting button moves the setting function. The sequence of the OCP test along with the setting value is as follows:

- OCP Press Start (pressing the red START/STOP button starts the test) TURBO shows the ON or OFF.
 - ISTAR (current start point) right display provides setting in amps "A"
-

- ISTEP (current steps) right display provides setting in amps "A"
- ISTOP (current stop point) right display provides setting in amps "A"
- VTH (voltage threshold) right display provides setting in volts "V"

When the test is started the right display will show the current value being taken by the load. If the Device under Test is able to supply the load according to the values set then the middle display will show PASS and the right display will show the maximum current taken during the OCP test. If, during the test, OTP is displayed the over temperature protection has been engaged. Similarly if OPP is shown on the display the over power protection has been activated.

11 Mode and Indicators

On the AEL-5000 Series AC/DC Electronic Load, there are 5 working modes which can be selected by MODE key with the sequence of Constant Current, Linear Constant Current, Constant Resistance, Constant Power and Constant Voltage. Then switching can be made in such a sequence. However, LED indicator of CC, LIN, CR, CP and CV will display the working mode selected.

F FUNCTION DESCRIPTION

Function keys description	40
Store or Recall functions	56
Sequence Functions	57
Wave Function description.....	61
Test Function description	71
Entry key description	102

Function keys description



Mode and CC,
LIN, CR, CP,
CV Indicator



There are five operating modes. These can be selected in turn by pressing the “MODE” key on the AEL-5000 series AC/DC Electronic Load module. The sequence is:

- (CC) Constant Current
- (LIN) Linear Constant Current
- (CR) Constant Resistance
- (CP) Constant Power
- (CV) Constant Voltage

The appropriate LCD will illuminate according to the operating mode is selected.

Load key and
LED
indicators

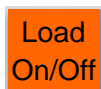

The input to the AEL-5000 Series AC/DC Electronic Load can be switched ON/OFF by using the “LOAD” button. Indication of the ON/OFF state is provided by illumination of the button.

LOAD button lit = LOAD ON (load sinks according to the preset values)

LOAD button unlit = LOAD OFF (the load does not sink current)

Turning the LOAD OFF does not affect

the preset values. When the LOAD ON state is enabled the unit will revert to sinking according to the preset values.

LD ON and LDOFF are set the open and close loading angle control, the full range of 0-359 degree.

Level A/B key and LED indicators

A grey square button with the text "Level A/B" in white.

Pressing Level Key will be B, press again will be A, further pressing will be B again and so on. B means Level B (LED ON), e.g., to move out Level A, then move in level B. A means Level A (LED OFF), e.g., to move out Level B, then move in Level A.

Under the condition of setting Memory A or B, this key is mainly for setting the values of groups A/B for rapid switching load current or resistance.

Sense key and LED indicators

A grey square button with the text "Sense" in white.

The voltmeter and internal trigger circuit of AEL-5000 series AC/DC electronic load can be controlled by this Key thus determining whether or not the input to the voltmeter is made from the AC input terminal (OFF) or Vsense terminal (ON). Upon Vsense ON, LED indicator will be ON and the 5 digit voltmeter can display the voltage read from Vsense. Upon Vsense OFF, the 5 digit voltmeter can display the voltage read from AC input terminal.

Preset key and LED indicators

A green square button with the text "Preset" in white.

If the PRESET key is pressed the button will become lit indicating that the PRESET mode has been accessed. The lowest 5 digit display will change from showing the power consumption in watts to displaying the value to be preset. The value that can be programmed changes according to the operating mode that has been selected.

- Constant Current (CC) mode:
The A and B levels of load current can be preset at right lower 5 digit LCD. The "A" LED will be lit indicating the setting value is amps.
- Linear Constant Current (LIN) mode:
The A and B levels of load current can be preset at right lower 5 digit LCD. The "A" LED will be lit indicating the setting value is amps.
- Constant Resistance (CR) mode:
The A and B levels of load resistance can be preset on the right lower 5 digit LCD. The " Ω " LED will be lit indicating the setting value is ohms.
- Constant Voltage (CV) mode:
The A and B levels of load voltage can be preset on the right lower 5 digit LCD. The "V" LED will be lit indicating the setting value is volts.
- Constant Power (CP) mode:
The A and B levels of load power can be preset on the right lower 5 digit LCD. The "W" LED will be lit indicating the setting value is watts.

Limit key



The LIMIT button allows the user to set left and right thresholds for voltage, current or power. These threshold settings are used in conjunction with the NG function to flag when the load is operating outside the desired limit.

Each press of the LIMIT key enables a different value to be entered. On first press of the LIMIT key the button will illuminate and V-Hi will be displayed on the right LCD. The setting is made with

the rotary knob and can be read from the right LCD during setting. The setting sequence is shown below:

- V_Hi (DVM upper limit)
- V_Lo (DVM lower limit)
- I_Hi (DAM upper limit)
- I_Lo (DAM lower limit)
- W_Hi (DWM upper limit)
- W_Lo (DWM lower limit)
- VA Hi
- VA Lo
- OPL
- OCL
- NG OFF/ON (No Good Flag)
- LIMIT setting function OFF

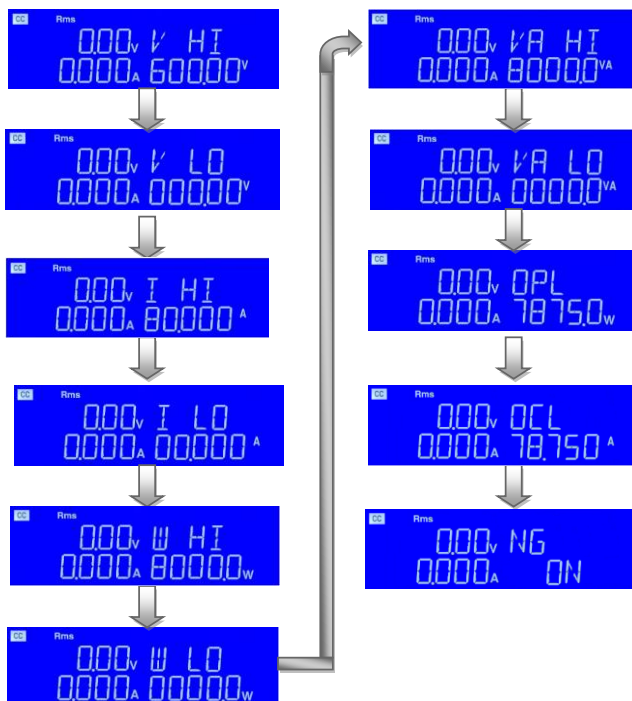



- Setting upper limit voltage V_H , the right upper 5 digit monitor display the "V-Hi" and right lower monitor display upper limit of the voltmeter with the unit as "V", The V-Hi set range from 0.00 V to 600.00V step 0.01V by rotating the Setting knob.

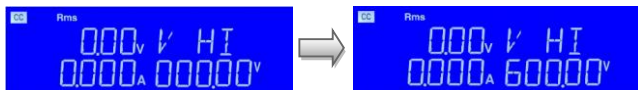

- Setting lower limit voltage V_L , the right upper 5 digit monitor display "V-Lo" and right lower monitor display lower limit of the voltmeter with the unit as "V", The V-Lo set range from 0.00 V to 600.00V step 0.01V by rotating the Setting knob.

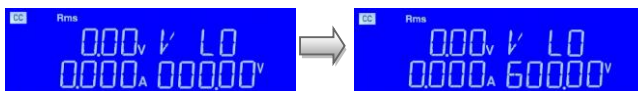

- Setting upper limit current I_H , the right upper 5 digit monitor display "I-Hi" and right lower monitor display upper limit of the voltmeter with the unit as "A", The I-Hi set range from 0.000 A to 80.000A step 0.001A by rotating the Setting knob.

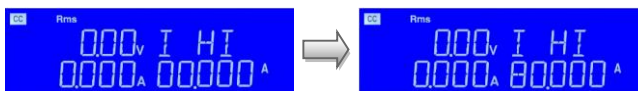

- Setting lower limit current I_L , the right upper 5 digit monitor display "I-Lo" and right lower monitor display lower limit of the voltmeter with the unit as "A", The I-Lo set range from 0.000 A to 80.000A step 0.001A by rotating the Setting knob.

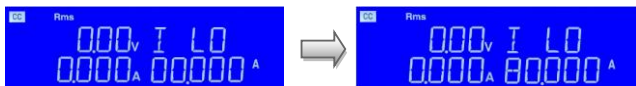

- Setting upper limit power WH, the right upper 5 digit monitor display "W-Hi" and right lower monitor display upper limit of the voltmeter with the unit as "W", The W-Hi set range from 0 W to 8000.0W step 1W by rotating the Setting knob.



- Setting lower limit power WL, the right upper 5 digit monitor display "W-Lo" and right lower monitor display lower limit of the voltmeter with the unit as "W", The W-Lo set range from 0.0 W to 8000.0W step 0.1W by rotating the Setting knob.

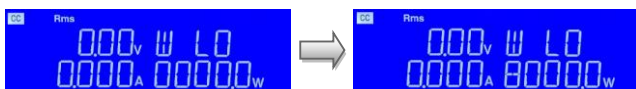

- Setting upper limit power VAH, the right upper 5 digit monitor display "VA-Hi" and right lower monitor display upper limit of the voltmeter with the unit as "VA", The VA-Hi set range from 0 VA to 8000.0VA step 0.1VA by rotating the Setting knob.

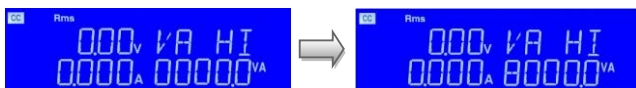



- Setting lower limit power VAL, the right upper 5 digit monitor display "VA-Lo" and right lower monitor display lower limit of the voltmeter with the unit as "W", The VA-Lo set range from 0.0 VA to 8000.0VA step 0.1VA by rotating the Setting knob.

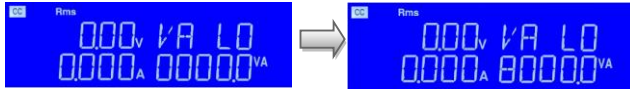

- Setting OPL, the right upper 5 digit monitor display "OPL" and right lower monitor display upper limit of the voltmeter with the unit as "W", The OPL set range from 0.1W to 7875W step 0.1W by rotating the Setting knob.

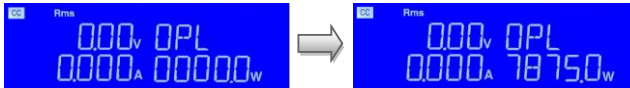

- Setting OCL, the right upper 5 digit monitor display "OCL" and right lower monitor display upper limit of the voltmeter with the unit as "A", The OCL set range from 0.001 A to 78.75A step 0.001A by rotating the Setting knob.



- Setting NG ON/OFF, When exceed VH, VL, IH, IL, WH, WL, VAH, VAL One of these whether NG on LCD display.

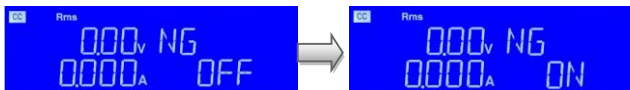

Limit

- CC mode, press limits key to set the V-Hi and V-Lo voltage upper and lower limits of the GO / NG.

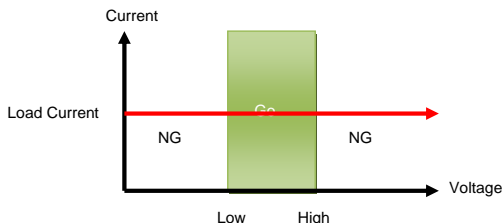

Limit

- CR mode, press limits key to set the V-Hi and V-Lo voltage upper and lower limits of the GO / NG.

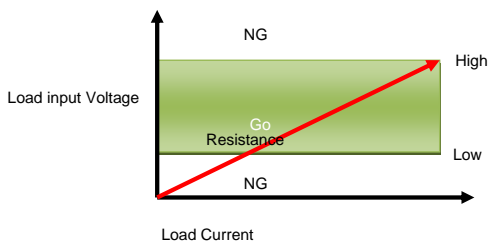

Limit

- CV mode, press limits key to set the I-Hi and I-Lo Current upper and lower limits of the GO / NG.

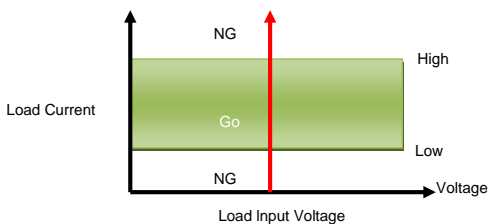

Limit

- CP mode, press limits key to set the W-Hi and W-Lo power upper and lower limits of the GO / NG.

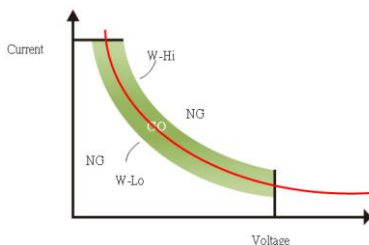

Config key

Config

The CONFIG key allows the sense function to engage automatically or switched ON. The CONFIG key also enables the LOAD to automatically turn ON/OFF When a voltage level is reached.

Each press of the CONFIG key moves the menu on one step. On first press of the CONFIG key the button will illuminate and EXTIN will be displayed on the Right upper LCD. The value is adjusted with the rotary knob and can be read from the right LCD during setting. The setting sequence is shown below:

- EXTIN OFF (Option)
- SYNC OFF
- LD ON
- LD OFF
- BW
- AVG
- CPRSP
- CYCLE
- SNUB
- Exit CONFIG options

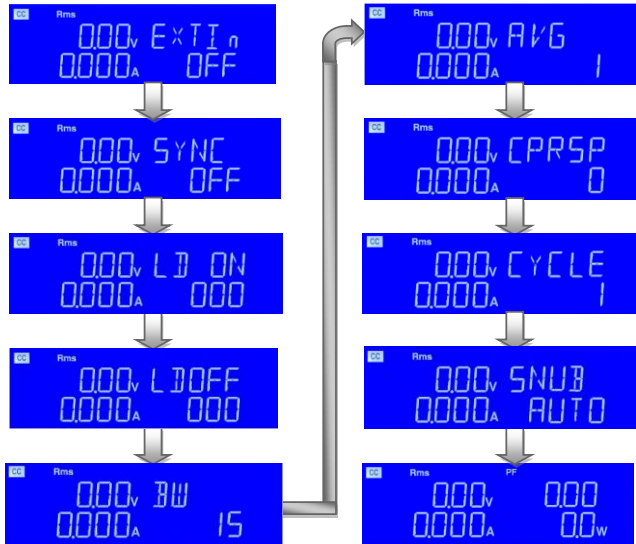

- The right upper 5 digit monitor display the EXTIN and right lower monitor display OFF or ON for external input disable or enable. Default is OFF

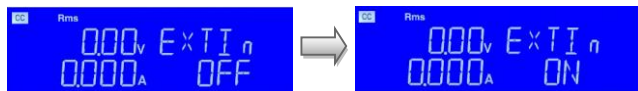

- The right upper 5 digit monitor display the SYNC and right lower monitor display OFF or ON for synchronous from external source disable or enable of rear panel I/O input terminal. Default is OFF.

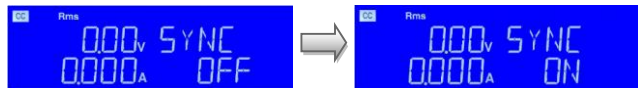

- The right upper 5 digit monitor display the LDON and right lower monitor display load on angle setting with the unit as “degree”. The range is 0 to 359 degree.

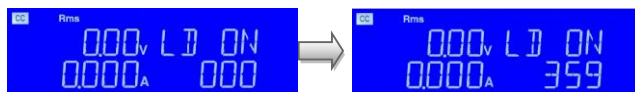

- The right upper 5 digit monitor display the LDOFF and right lower monitor display load off angle setting with the unit as “degree”. The range is 0 to 359 degree.

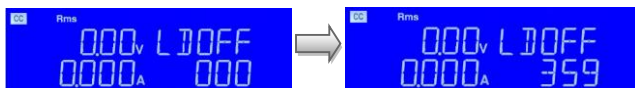

- The right upper 5 digit monitor display the BW and right lower monitor display 13 for different bandwidth. The range is 00~15, Default is 13.

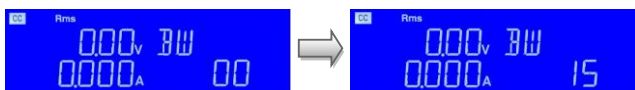

- The right upper 5 digit monitor display the AVG and right lower monitor display 1 for average value. The range is 1, 2, 4, 8, 16. Default is 1.

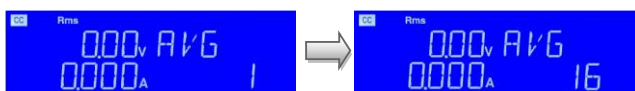

- The right upper 5 digit monitor display the CPRSP and right lower monitor Display 0 for CPRSP value. The range is 0~7, Default is 0.
CPRSP is set to the constant power response speed 0~3 for linear current constant power load, 0 is the fastest to adjust the load power response, 3 is the slowest. 4~7 is the standard current constant power load 4 to adjust the load power The response is the fastest, and the slowest default is 0.



- The right upper 5 digit monitor display the CYCLE and right lower monitor display 1 for CYCLE value. The range is 1~16, Default is 1.

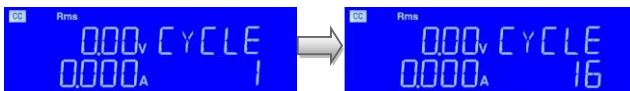

- The right upper 5 digit monitor display the SNUB and right lower monitor display "AUTO", use the knob and the key to switch AUTO or ON or OFF.

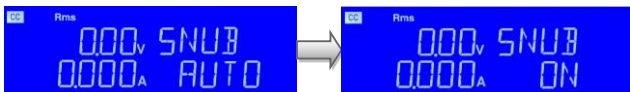

System key



Press SYSTEM to set the argument, GPIB address, RS232 BAUD- RATE, WAKE UP and buzzer Alarm power ON/OFF and Master/Slave control.



Setting system parameters

Set GPIB address, RS232 BAUD RATE, WAKE UP, Buzzer ON/OFF and Master/Slave control.

Set GPIB address



First press SYSTEM key, the Left 5 digit monitor display the "GPIb", the right upper 5 digit monitor display "Addr", the right lower 5 digit monitor display setting GPIB address of the representative, Press UP, DOWN buttons to adjust the GPIB address 1~30, Key and then press ENTER, AEL-5000 series GPIB Address value is saved, Press system key four times to leave the GPIB address configuration State.

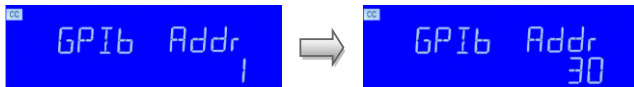

Set RS232
BAUD RATE

System

SYSTEM key first by the second, the Left 5 digit monitor display the "RS232", the right upper 5 digit monitor display the "baud" and right lower monitor display setting BAUD-RATE value, Press UP, DOWN buttons to adjust the value of BAUD RATE, Key and then press ENTER, AEL-5000 Series is saved setting BAUD RATE, press system key three times to leave the BAUD-RATE setting state.

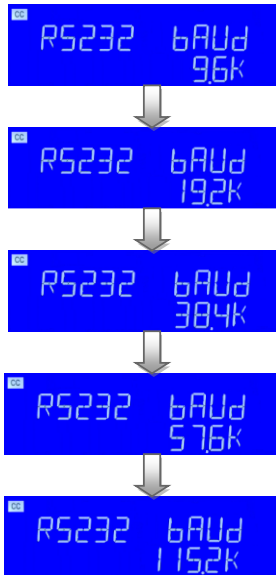

WAKE-UP
function

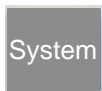

This function is designed for auto setting the load status and load level in turning on The AEL-5000 Series every time. SYSTEM key first by the three.

The Left 5 digit monitor display the "WAKE", the right upper 5 digit monitor display the "UP", and right lower monitor display setting value, Press UP, DOWN buttons to adjust the 0~150.

Press ENTER key to be stored, press system key two times to leave the WAKE-UP setting state, If set to "0" means do not call.

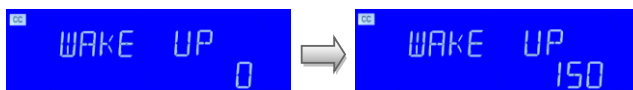

Buzzer ON/
OFF

This is the test set automatically (AUTO SEQUENCE) at the end, if it increases buzzer function, if set to ON, Then when the test result is PASS automatically when the buzzer will call out, if the test result is FAIL when the buzzer will call the second tone.

Setting method:

First by 4 Times SYSTEM key and The Left 5 digit monitor display the "SEq", the right upper 5 digit monitor display the "bEEP", right 5 digit LCD Display setting ON or OFF, press UP DOWN key to adjust.

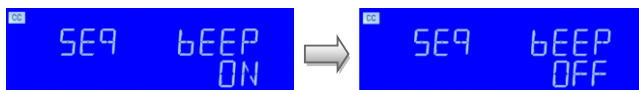

Note Setting system parameters, if the input is required to use the KEYPAD ENTER button to confirm, otherwise AEL-5000 Series will not save the changes the settings.

Pass: Automatic test mode, no NG state, is the PASS.
Fail: Automatic test mode, any test if the NG then is the FAIL.

Local key



Press LOCAL key to exit REMOTE mode

Store or Recall functions

The function keys on the front panel of AEL-5000 Series mainframe are designed for high testing throughput purpose. There are 150 operation states or testing steps can be store in the EEPROM memory of AEL-5000 Series electronic load respectively, each state can store or recall the load status and level for Electronic load simultaneously.

Store key

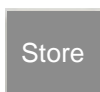

Process

- Set the load status and load level.
- Press SHIFT key then press the STORE key to enter the storage state.
- Press UP, DOWN key or KEYPAD to adjust, press the ENTER OK to Save the STATE.

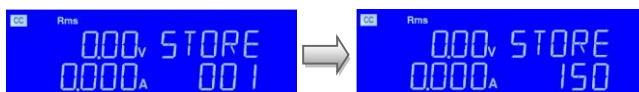

Recall key

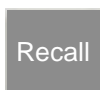

Process

- Press RECALL to enter the call state.
- Press UP, DOWN key or KEYPAD to adjust.
- Finally press the ENTER key to confirm, in the electronic load front panel, set the value that would call out the information in accordance with resetting.

Sequence Functions

SEQ key



Press SEQ key to enter SEQ setting mode, LED indicator ON, the setting sequence is as follows:

Use UP and DOWN keys to set EDIT F1 or TEST F1 mode, if you want to leave SYSTEM (Exit)

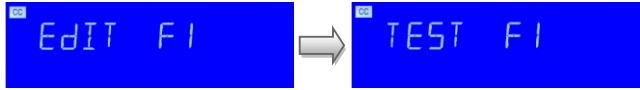

Edit mode



- Press SHIFT key, press the SEQ. key to enter the AUTO SEQUENCE Mode, Press UP, DOWN key to select EDIT, the LCD display shows "EDIT" on left 5 Digit LCD display, the right 5 digit LCD display "FX", "FX" means to select the state F1-F9, Press keypad key 1 ~ 9 choose F1 ~ F9.

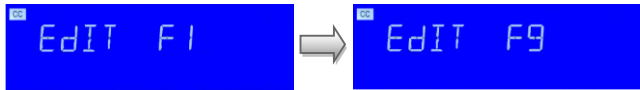

- Press ENTER key, the LCD display shows "FX-XX" on left 5 digit LCD display, middle 5 digit LCD display "STATE", right 5 digit LCD display setting 1~150, "FX" means to select the state F1-F9. "XX" means the test STEP01-16, setting state value, press UP and down Key or keypad to adjust setting.

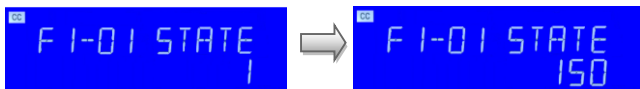

Test time setting

- Press ENTER to set TIME value, press UP, DOWN keys or KEYPAD to adjust settings, range from 100 ms~9999ms. Press SAVE key to finish editing the action is set to REPEAT, If you do not save the settings, press the EXIT key to leave edit mode.

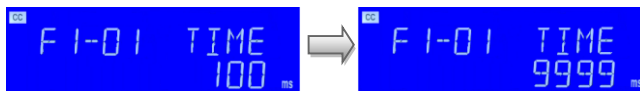

- Setting REPEAT (REPEAT TEST), Press UP and DOWN key or Keypad to adjust setting 0~9999, Press SAVE REPEAT Value, or press EXIT key exit EDIT MODE.

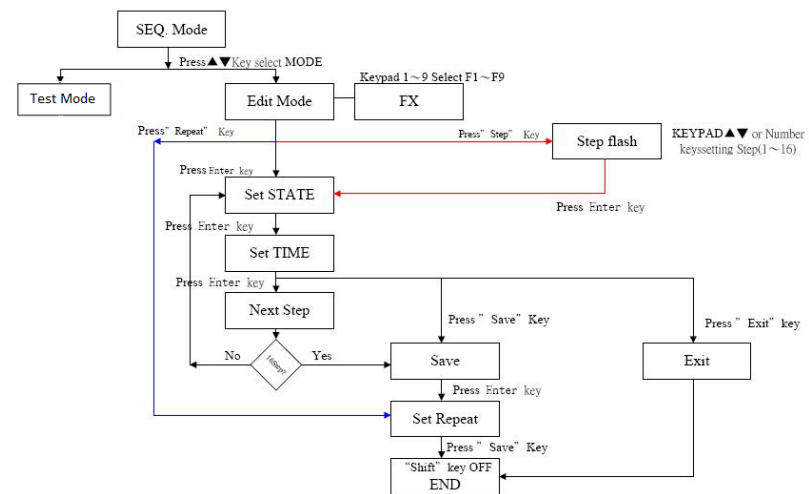
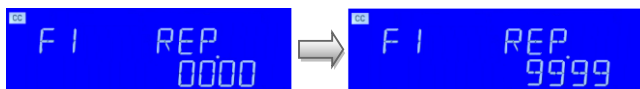

Store (Edit) mode operation flow chart

Test mode

SEQ

- Press the SHIFT and SEQ key simultaneously to enter the AUTO SEQUENCE Mode, and press UP or DOWN key to TEST function, To use the key pad to setting 1~9 for F1 to F9 and press ENTER key to execute the automatic test mode.

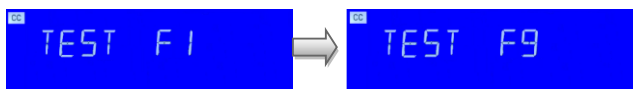

To execute the automatically test mode the LCD display will display "SXX", S means step and XX means step no(step 1~16) to indicated which step no under the testing, if the test Result is NG; the LCD display will show "NG" (flashing) and suspension of the test until user press ENTER key to continue test or press EXIT key to leave the test mode, the automatically test mode will be finish when test to the end of step or press EXIT key to leave the test mode.

If all the test steps are OK, the test result is PASS, LCD display will show "PASS"; if any one step is NG, the test result will be FAIL; LCD display will show "FAIL", If the beeper ON/OFF is set to ON, when the test result is PASS the beeper will beep one sound, if the test result is FAIL, the beeper will beep 2 sounds.

When the test is finished, user can press the ENTER key again to test or press EXIT key to leave the test mode.

Example 1

- The test step setting to 16 step, press the TEST key, the execute result is PASS, the LCD display shown PASS.

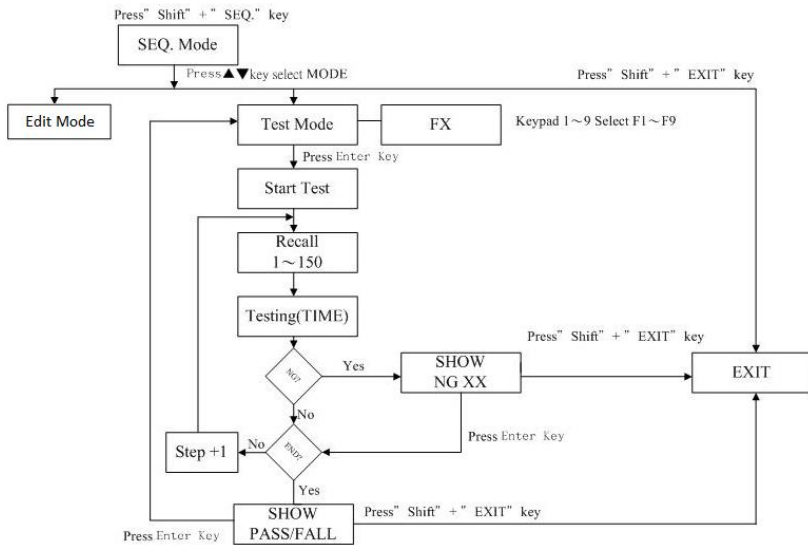
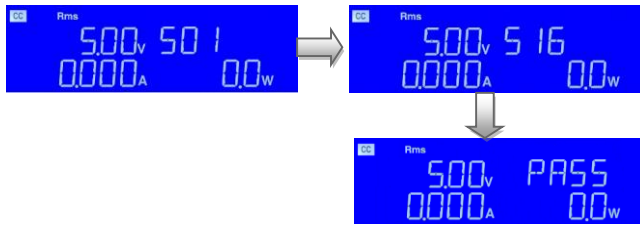

Test mode operation flow chart

Wave Function description



CF key and $\sqrt{2}$, 2, 2.5, 3, 3.5 keys



CF key only functions upon C.C. and C.P. mode and all LED off upon Linear C.C., C.R. and C.V. mode. $\sqrt{2}$, 2, 2.5, 3, 3.5 keys are used to quick change the current C.F. (Crest Factor) of C.C. mode. However, adjust the CF by number key or Up, Down or rotary switch to setting the C.F. values.

The CF key can be set to the range of 1.0, 1.1, 1.2, 1.3, 1.4 to 5.0, and the CF 1.0 to 1.3 is the SCR/TRIAC current phase modulation waveforms and the half-wave load simulation. The waveforms of the first cycle and the last cycle may differ depending on the angle setting of LD ON and LDOFF. The setting sequence is as follows:

- 1.4 ~5.0
- (1.3)TRAIL: Trailing edge
- (1.2)LEAD: Leading edge
- (1.1)LDNEG: negative half-cycle loading
- (1.0) LDPOS: positive half-cycle loading

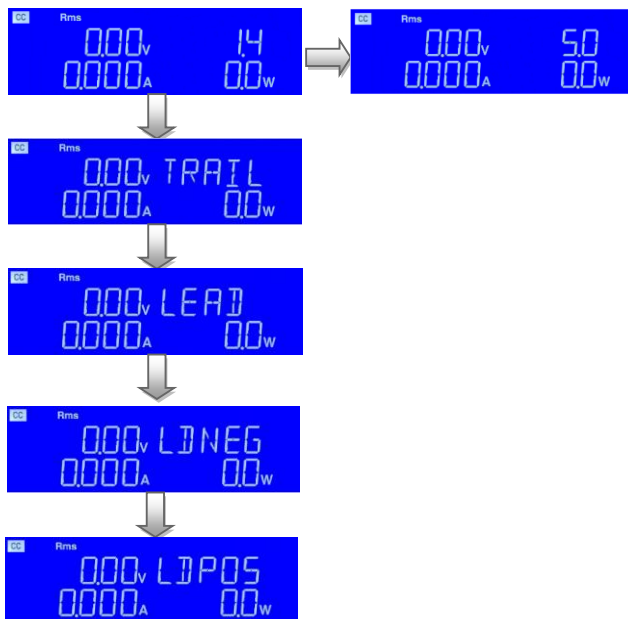

Press the CF key, and $\sqrt{2}$ key settings will be automatically saved and exit.

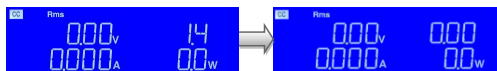
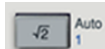

Press the CF key, and 2 key settings will be automatically saved and exit.

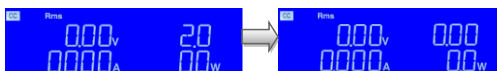
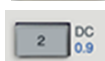

Press the CF key, and 2.5 key settings will be automatically saved and exit.

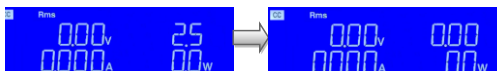

Press the CF key, and 3.0 key settings will be automatically saved and exit.

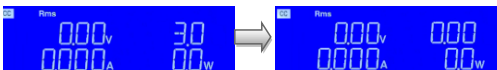

CF

Press the CF key, and 3.5 key settings will be automatically saved and exit.

3.5 400Hz
0.6

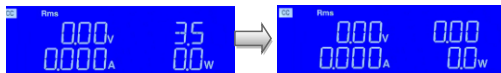

CF

Press the CF key, setting range from 1.4 to 5.0, step 0.1 by rotating the Setting knob, press the ENTER key after the completion of the setting will be automatically stored.

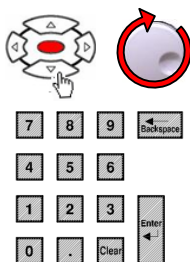

Note

CF (crest factor) range 1.4142 ~ 5.0, AEL-5000 Series full scale current is 3 times the peak, if use the CF peak 5.0, AEL-5000 scale current so the current must be reduced to 45A, in order to reach the peak 5.0.

- Current phase modulation waveform load

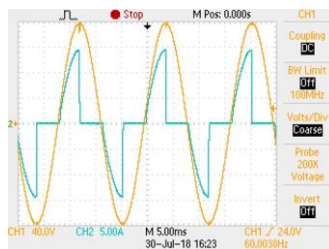

90 degree SCR Trailing edge current waveform

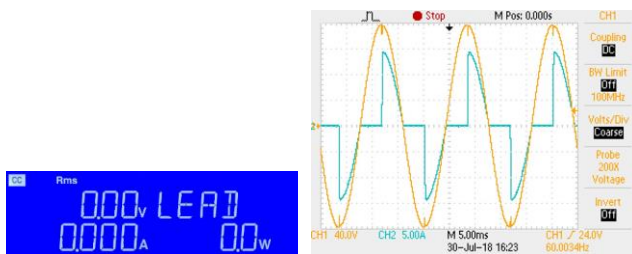

90 degree SCR Leading edge current waveform

- Positive half-cycle or negative half-cycle load setting use the knob and key to adjust the CF value, or press the CF key, the Keypad key enters 1.1 (LDNEG), the monitor displays LDNEG is negative half-cycle loading, the Keypad key enters 1.0 (LDPOS), LDPOS for positive half-cycle loading.

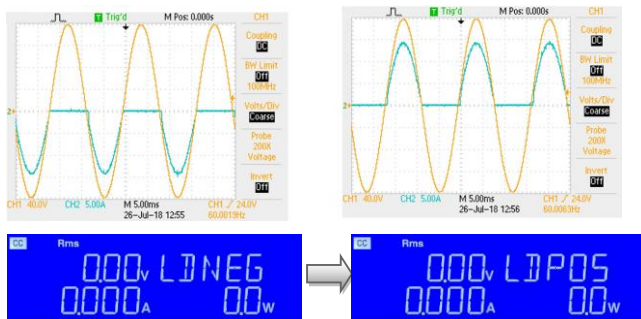

- Adjustment of CF
 The adjustable range of CF will be different due to PF. Therefore, it is necessary to select the appropriate PF to make the CF setting value within the adjustable range. When the CF setting value is not within the adjustable range under this PF setting value, the system will automatically adjust the PF setting value so that the CF setting value is as required by the user. For example, if CF set to 1.8, the adjustable range of the PF setting value is between 0.8 and 0.9, so the system will automatically adjust PF setting value from 0.75 to 0.8.

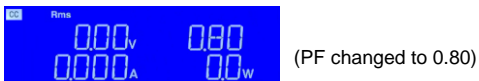

FREQ key and Auto, DC, 50Hz, 60Hz 400Hz keys



FREQ key only functions upon C.C. and C.P. mode and all LED off upon Linear C.C., C.R. and C.V. mode. Auto, DC, 50Hz, 60Hz and 400Hz keys are used to quick change the frequency of C.C. and C.P. mode. However, adjust the frequency by number key or Up, Down or rotary switch to setting the frequency values. The range is 40~440Hz.



Press the FREQ key, and Auto key settings will be automatically saved and exit.



Press the FREQ key and DC key settings will be automatically saved and exit.



FREQ

Press the FREQ key and 50Hz key settings will be automatically saved and exit.

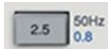

FREQ

Press the FREQ key and 60Hz key settings will be automatically saved and exit.

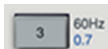

FREQ

Press the FREQ key and 400Hz key settings will be automatically saved and exit.

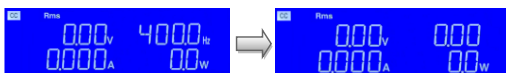
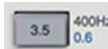

FREQ

Press the FREQ key, setting range from AUTO to 440Hz, step 0.1 by rotating the Setting knob, press the ENTER key after the completion of the setting will be automatically stored.

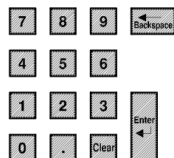
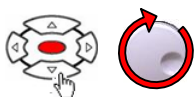

PF key and 1, 0.9, 0.8, 0.7, 0.6 keys



PF (lead) key only functions upon C.C. and C.P. mode and all LED off upon Linear C.C., C.R. and C.V. mode.



1, 0.9, 0.8, 0.7 and 0.6 keys are used to quick change the P.F. (Crest Factor) of C.C. and C.P. mode.

However, adjust the PF by number key or Up, Down or rotary switch to setting the P.F. values. The range is 0 ~ 1.



- Press the PF key and 1 key settings will be automatically saved and exit.

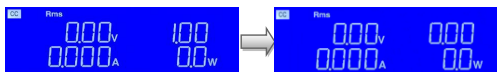

- Press the PF key and 0.9 key settings will be automatically saved and exit.

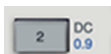

- Press the PF key and 0.8 key settings will be automatically saved and exit.



- Press the PF key and 0.7 key settings will be automatically saved and exit.

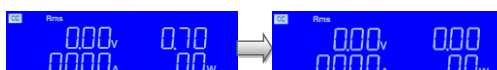

- Press the PF key and 0.6 key settings will be automatically saved and exit.





- Press the PF key, setting range from 0.01 to 1.00, step 0.01 by rotating the Setting knob, press the ENTER key after the completion of the setting will be automatically stored.

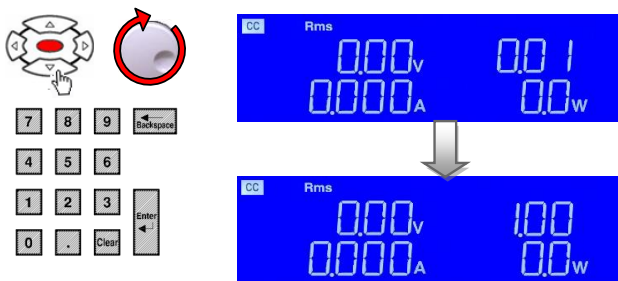

- Adjustment of PF

The adjustable range of PF will be different due to CF. Therefore, it is necessary to select the appropriate CF to make the PF setting value within the adjustable range. When the PF setting value is not within the adjustable range under this CF setting value, the system will automatically adjust the CF setting value so that the PF setting value is as required by the user.

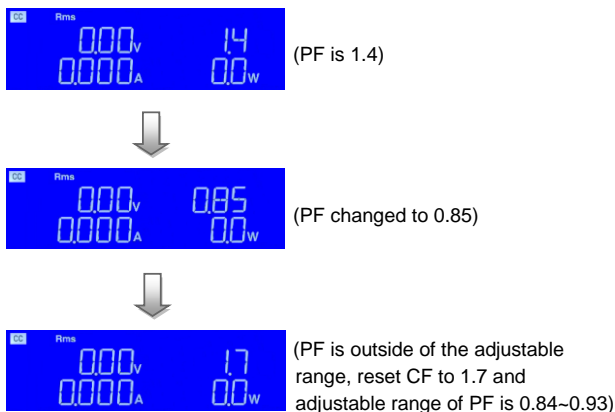

-PF key and 1, 0.9, 0.8, 0.7, 0.6 keys

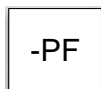

PF (lag) key only functions upon C.C. and C.P. mode and all LED off upon Linear C.C., C.R. and C.V. mode.



1, 0.9, 0.8, 0.7 and 0.6 keys are used to quick change the P.F. (Crest factor) of C.C. and C.P. mode.

However, adjust the PF by number key or Up, Down or rotary switch to setting the P.F. values. The range is 0 ~ -1.

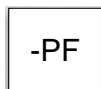

- Press the -PF key and 1 key settings will be automatically saved and exit.

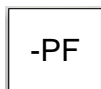
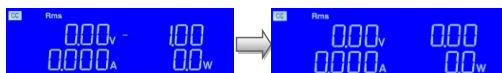

- Press the -PF key and 0.9 key settings will be automatically saved and exit.

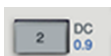

- Press the -PF key and 0.8 key settings will be automatically saved and exit.

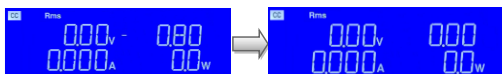

- Press the -PF key and 0.7 key settings will be automatically saved and exit.

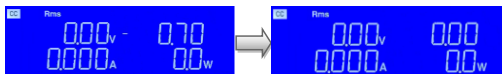
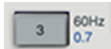

- Press the -PF key and 0.6 key settings will be automatically saved and exit.

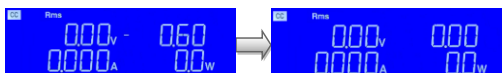

-PF

- Press the -PF key, setting range from -0.01 to -1.00, step 0.01 by rotating the Setting knob, press the ENTER key after the completion of the setting will be automatically stored.

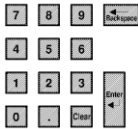

PF setting range, when CF is set to 2, the PF setting range is 0.55~0.8.

PF vs CF
curve
graph

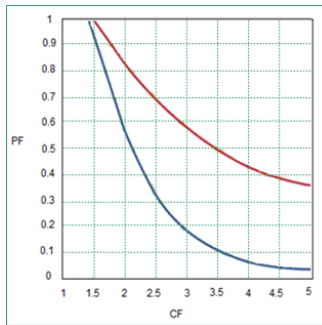

Test Function description



Item, Setting
and Exit keys

Item

Setting

Exit

Item, Setting and Exit key for Test. There are ten operating modes. These can be selected in turn by pressing the "Item" key on the AEL-5000 series AC/DC Electronic Load module. The sequence is:

- SHORT
- OPP
- OCP
- Non-L
- NL+CR
- FUSE
- BATT
- TRANS
- INRUSH
- SURGE

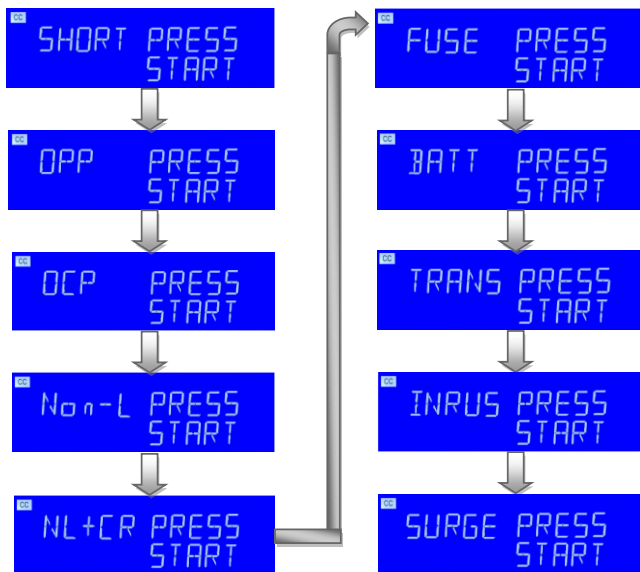

The SHORT parameters setting

The SHORT test will attempt to sink high current up to the AEL-5000 Series AC/DC load maximum current in order to check the power source’s protection and behavior. The test time can be adjusted and threshold values for the High and low voltage limits set.

Item

Pressing the Item key once will cause the button to illuminate. The Message “SHORT PRESS START” will be shown across the displays.

Setting

Each press of the Setting key moves the menu on one step. The left and right LCDs show the currently selected test parameter as text. The value is adjusted by the rotary knob and can be read from the right display during setting.

The setting sequence is shown below:

- SHORT PRESS START
- SHORT TURBO
- SHORT Time CONTI
- SHORT V HI
- SHORT V LO

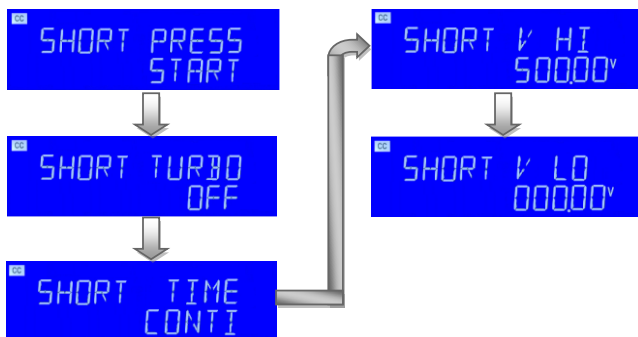

- The right upper 5 digit monitor display the Turbo and right lower monitor display "OFF", use the knob and the key to switch ON or OFF.

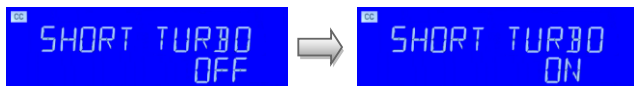

- The setting short test time, right upper 5 digit monitor display the TIME and right lower monitor display "CONTI", the setting range is "CONTI" means continue.



- **SHORT TIME:** setting the Short test time, the left 5 digit monitor display the "SHORT", the right upper 5 digit monitor display the TIME and right lower monitor display "100ms", the range is 100ms to 10000ms. The short test will be no time limitation when setting to CONTI until press "START/STOP" key to stop the short test.

Note TURBO ON state, the test time up to 1000ms.



- **V-Hi:** Short test voltage check upper limitation setting, the Left 5 digit monitor display the "SHORT", the right upper 5 digit monitor display the "V-HI" and right lower monitor display setting value, the unit is "V". The range is 0.01V to 500.00V.

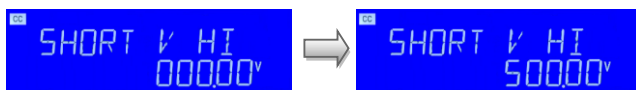

- **V-Lo :** Short test voltage check lower limitation setting, the Left 5 digit monitor display the "SHORT", the right upper 5 digit monitor display the "V-Lo" and right lower monitor display setting value, the unit is "V". The range is 0.01V to 500.00V.

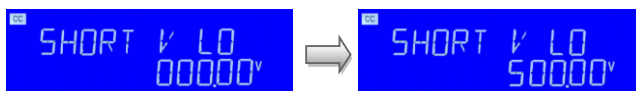

A square button with an orange background and a white border. The word "Start" is written in white above a horizontal white line, and the word "Stop" is written in white below the line.

Once the test parameters have been entered the test is started by pressing the red START/STOP button while the SHORT PRESS START text is displayed. During the test the bottom LCD will show run and the actual short current will be displayed on the right upper LCD.

Note

- The message PASS END will be displayed if the measured voltage levels stay within the V_{Hi} and V_{Lo} threshold levels during the test.
- The message FAIL END will be displayed if the measured voltage levels fall outside the V_{Hi} and V_{Lo} threshold levels during the test. The NG flag will also illuminate.
- If continuous short time is selected the test is ended by pressing the red START/STOP button.

OPP parameters setting

The OPP allows the parameters of an Over Power Protection test to be entered. The OPP test will ramp up the load power in steps to validate the Device under test's (DUT) protection and behavior. A voltage threshold level can be set. If the voltage measured during the test is lower than the set Threshold voltage then the test will fail and the display will signal OPP ERROR. Similarly a power threshold (P STOP) can be set. If the measured power reaches the P STOP threshold the test will be discontinued and the OPP ERROR message will be displayed.

A square button with a white background and a black border. The word "Item" is written in black in the center.

Pressing the Item key once will cause the button to illuminate. The message "OPP PRESS START" will be shown across the displays.

Setting

Each press of the Setting button moves the menu on one step. The Left and Middle LCDs show the currently selected test parameter as text. The value is adjusted by the rotary knob and can be read from the Right display during setting.

The setting sequence is shown below:

- OPP PRESS START
- OPP TURBO
- OPP PSTAR
- OPP PSTEP
- OPP PSTOP
- OPP VTH

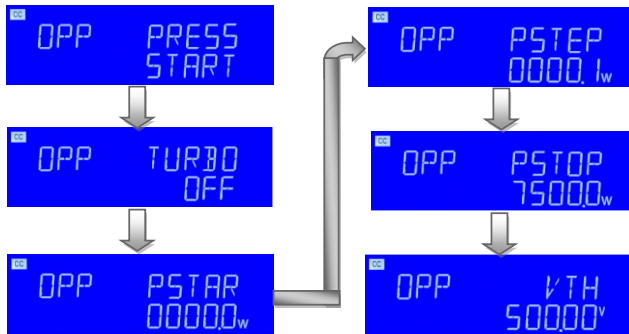

The right upper 5 digit monitor display the Turbo and right lower monitor display "OFF" ,use the knob and the key to switch ON or OFF.

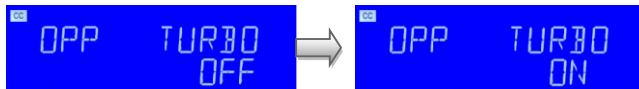

- PSTAR: setting the start power, the Left 5 digit monitor display the "OPP" ,the right upper 5 digit monitor display the "PSTAR", and right lower monitor display setting value, the unit is "W". The range is 0.1W to the full scale of the CP mode specification.

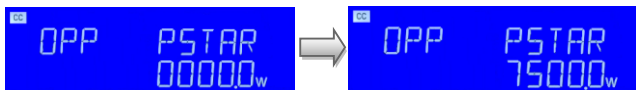

- PSTEP: setting the increment step power, the Left 5 digit monitor display the "OPP" ,the right upper 5 digit monitor display the "PSTEP", and right lower monitor display setting value, the unit is "W". The range is 0.1W to the full scale of the CP mode specification.

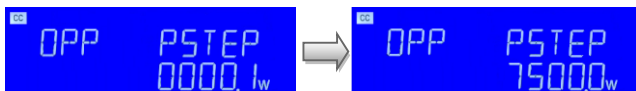

- PSTOP: setting the stop power, the Left 5 digit monitor display the "OPP" ,the right upper 5 digit monitor display the "PSTOP", and right lower monitor display setting value, the unit is "W". The range is 0.1W to the full scale of the CP mode specification.

Note

The maximum settable stop power in TURBO ON state is the "PSTAR + 10X PSTEP" power.

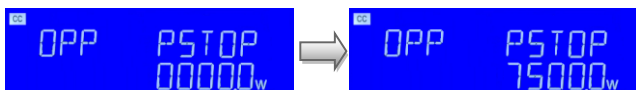

- Vth : Setting threshold voltage; the Left 5 digit monitor display the “OPP” ,the right upper 5 digit monitor display the “VTH” , and right lower monitor display setting value, the unit is “V”. The range is 0.01V to the full scale of the Voltage specification.

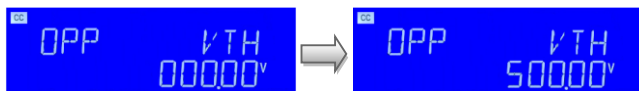

OCP parameters setting

The OCP allows the parameters of an Over Current Protection test to be entered. The OCP test will ramp up the load current in steps to validate the Device Under test’s (DUT) protection and behavior. A voltage threshold level can be set. If the voltage measured during the test is lower than the set Threshold voltage then the test will fail and the display will signal OCP ERROR. Similarly a current Threshold (I STOP) can be set. If the measured Current reaches the I STOP Threshold the test will be discontinued and the OCP ERROR message will be displayed.

Item

Pressing the Item key once will cause the button to illuminate. The message “OCP PRESS START” will be shown across the displays.

Setting

Each press of the setting button moves the menu on one step. The Left and right LCDs show the currently selected test parameter as text. The value is adjusted by the rotary knob and can be read from the Right display during setting.

The setting sequence is shown below:

- OCP PRESS START
- OCP TURBO
- OCP ISTAR
- OCP ISTEP
- OCP ISTOP
- OCP VTH

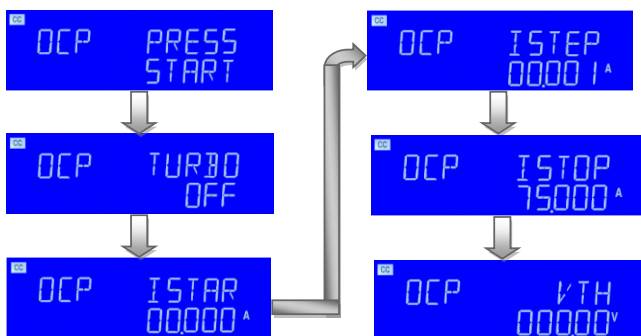

- The right upper 5 digit monitor display the Turbo and right lower monitor display "OFF", use the knob and the key to switch ON or OFF.

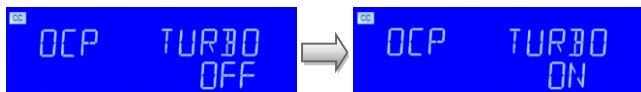

- ISTAR: setting the start current point, the Left 5 digit monitor display the "OCP", the right upper 5 digit monitor display the "ISTAR", and right lower monitor display setting value, the unit is "A". The range is 0.001A to the full

scale of the CC mode specification.

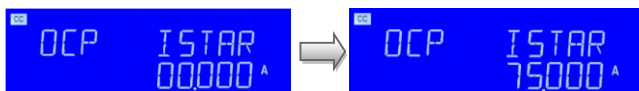

- **ISTEP**: setting the increment step current point, the Left 5 digit monitor display the "OCP", the right upper 5 digit monitor display the "ISTEP", and right lower monitor display setting value, the unit is "A". The range is 0.001A to the full scale of the CC mode specification.

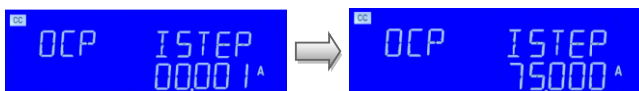

- **ISTOP**: setting the stop current point, the Left 5 digit monitor display the "OCP", the right upper 5 digit monitor display the "ISTOP", and right lower monitor display setting value, the unit is "A". The range is 0.001A to the full scale of the CC mode specification. TURBO ON state, the maximum stop current that can be set is "ISTAR + 10X ISTEP current value.

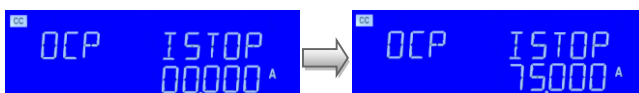

- **Vth**: Setting threshold voltage; the Left 5 digit monitor display the "OCP", the right upper 5 digit monitor display the "VTH", and right lower monitor display setting value, the unit is "V". The range is 0.01V to the full scale of the Voltage specification.

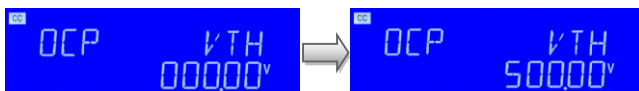



Once the test parameters have been entered the test is started by pressing the red START/STOP button while the OCP PRESS START text is displayed. During the Test the middle LCD will show run and the actual current being Taken will be displayed on the Right LCD

Note

The message OCP ERROR will be displayed if the DUT fails the test. The reasons for failure are due to one of the following conditions:

- (a) The voltage level of the DUT falls below the set voltage threshold (OCP Vth) during the test
- (b) The current taken from the DUT reaches the OCP I STOP setting.

The message PASS will be displayed if the DUTs voltage stays above the set threshold. Also to PASS the OCP the current taken from the DUT cannot equal the I STOP setting.

If the DUT passes the OCP test the maximum current taken during the test is displayed on the right LCD. Upon PASS or OCP ERROR the test will automatically stop. The red START/STOP button can be used during the test to immediately cease operation.

The Non-L parameters setting



Pressing the Item key once will cause the button to illuminate. The message “Non-L PRESS START” will be shown across the displays.



Each press of the setting button moves the menu on one step. The Left and right LCDs show the currently selected test parameter as text. The value is adjusted by the rotary knob and can be read from the Right display during setting.

The setting sequence is shown below:

- Non-L PRESS START
- Non-L CC

- Non-L PF

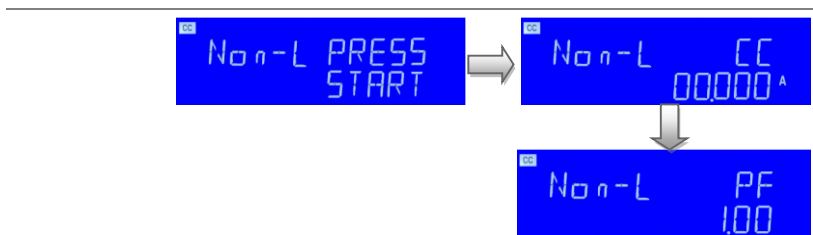

- Non-L CC: setting the Non-L current point, the Left 5 digit monitor display the “Non-L” ,the right upper 5 digit monitor display the “CC”, and right lower monitor display setting value, the unit is “A”. The range is 0.001A to the full scale of the CC mode specification.



- Non-L PF: setting the PF, the Left 5 digit monitor display the “Non-L” ,the right upper 5 digit monitor display the “PF”, and right lower monitor display setting value, The range is 0.01 ~ 1.00.



The NL+CR parameters setting

Item

Pressing the Item key once will cause the button to illuminate. The message “NL+CR PRESS START” will be shown across the displays.

Setting

Each press of the setting button moves the menu on one step. The Left and right LCDs show the currently selected test parameter as text. The value is adjusted by the rotary knob and can be read from the Right display during setting.

The setting sequence is shown below:

- NL+CR PRESS START
- NL+CR CC
- NL+CR CR

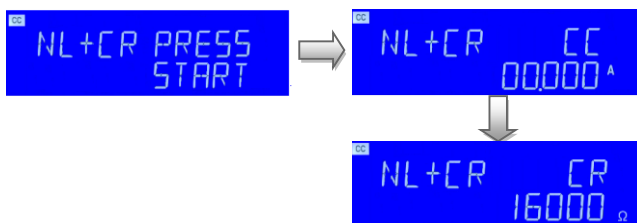

- NL+CR CC: setting the NL+CR CC current point, the Left 5 digit monitor display the "NL+CR", the right upper 5 digit monitor display the "CC", and right lower monitor display setting value, the unit is "A". The range is 0.001A to the full scale of the CC mode specification.

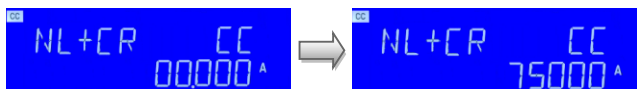

- NL+CR CR: setting the NL+CR CR resistance point, the Left 5 digit monitor display the "NL+CR", the right upper 5 digit monitor display the "CR", and right lower monitor display setting value, the unit is "Ω". The range is 1.6000Ω to the full scale of the CR mode specification.

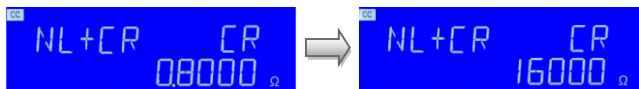

The FUSE parameters setting

Item

Pressing the Item key once will cause the button to illuminate. The message "FUSE PRESS START" will be shown across the displays.

Setting

Each press of the Setting button moves the menu on one step. The Left and right LCDs show the currently selected test parameter as text. The value is adjusted by the rotary knob and can be read from the Right display during setting.

The setting sequence is shown below:

- FUSE PRESS START
- FUSE TURBO OFF
- FUSE CC
- FUSE TIME
- FUSE REP.
- FUSE TYPE TRIP

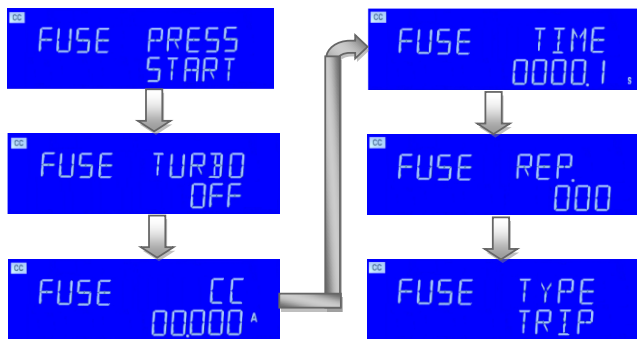

- Setting the fuse TURBO, The Left 5 digit monitor display the "FUSE", the right upper 5 Digit monitor display the "TURBO", and right lower monitor display OFF; use the knob and the key to ON or OFF

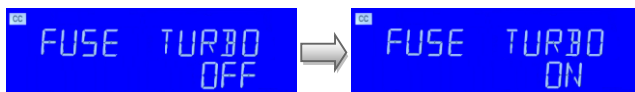

- FUSE CC : setting the fuse current point, the Left 5 digit monitor display the "FUSE", the right upper 5 digit monitor display the "CC", and right lower monitor display setting value, the unit is "A". The range is 0.001A to the full scale of the CC mode specification.

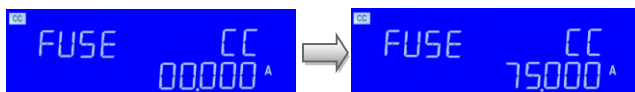

- FUSE TIME: setting the fuse test time, the Left 5 digit monitor display the "FUSE", the right upper 5 digit monitor display the "TIME", and right lower monitor display setting value, the unit is "S". The range is 0.1S ~9999.9S.

Note If the TURBO is ON, the maximum settable time is one second.



- FUSE REP: setting the fuse test times, the Left 5 digit monitor display the "FUSE", the right upper 5 digit monitor display the "REP.", and right lower monitor display setting value. The range is 0 ~255.

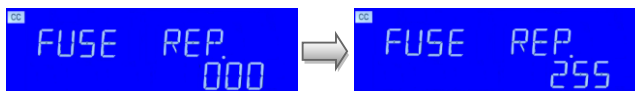

- The right upper 5 digit monitor display the TYPE and right lower monitor display "TRIP", use the knob and the key to TRIP or NTRIP.

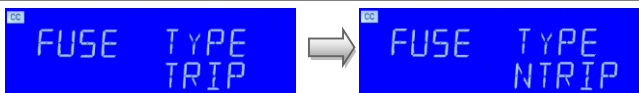

The BATT parameters setting

Item

Pressing the Item key once will cause the button to illuminate. The message “BATT PRESS START” will be shown across the displays.

Setting

Each press of the setting button moves the menu on one step. The Left and right LCDs show the currently selected test parameter as text. The value is adjusted by the rotary knob and can be read from the Right display during setting.

The setting sequence is shown below:

- BATT PRESS START
- BATT MODE CC
- BATT CC
- BATT CF
- BATT PF LEAD
- BATT PF
- BATT TIME
- BATT VTH

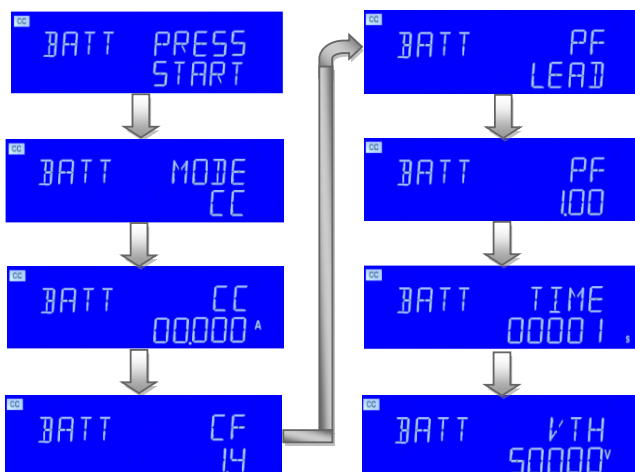

- The Left 5 digit monitor display the "BATT", the right upper 5 digit monitor Display the "MODE", and right lower monitor display the "CC", use the knob and the key to switch CC, LIN, CR or CP.

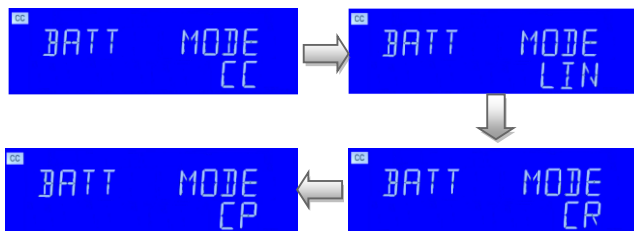

- BATT CC : setting the battery current point, the Left 5 digit monitor display the "BATT", the right upper 5 digit monitor display the "CC", and right lower monitor display setting value, the unit is "A". The range is 0.001A to the full scale of the CC mode specification.

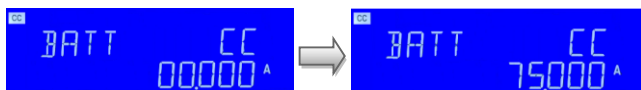

- BATT CF: setting the CF, the Left 5 digit monitor display the "BATT", the right upper 5 digit monitor display the "CF", and right lower monitor display setting value. The range is 1.0, 1.1, 1.2, 1.3, 1.4~5.0,

The setting sequence is shown below:

- BATT CF 1.4 ~5.0
- (1.3) BATT CF TRAIL: Trailing edge
- (1.2) BATT CF LEAD: Leading edge
- (1.1) BATT CF LDNEG: negative half-cycle loading
- (1.0) BATT CF LDPOS: positive half-cycle loading

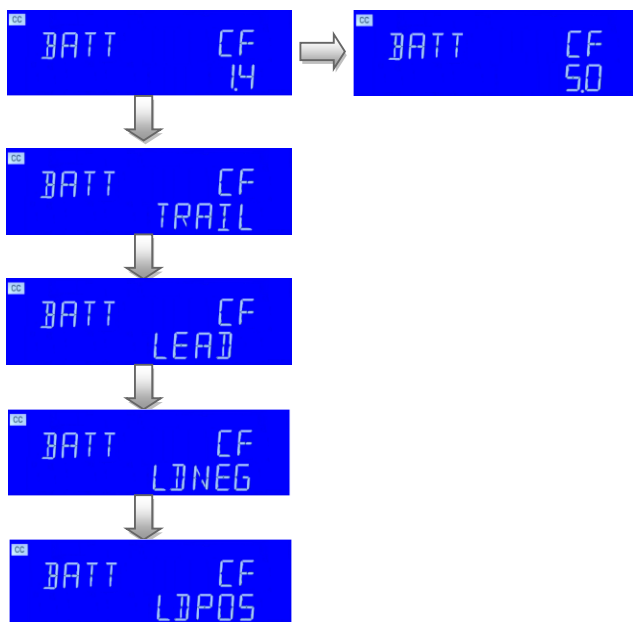

- The left 5 digit monitor display the “BATT”, the right upper 5 digit monitor display the “PF”, and right lower monitor display the “LEAD”, use the knob and the key to LEAD or LAG.

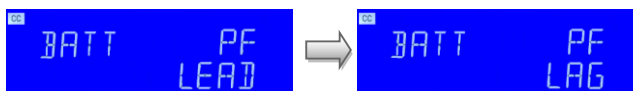

- BATT CF: setting the PF, the Left 5 digit monitor display the “BATT”, the right upper 5 digit monitor display the “PF”, and right lower monitor display setting value. The range is 0.01 ~1.00.

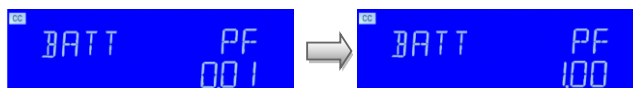

- BATT TIME: setting the battery test time, the Left 5 digit monitor display the "BATT", the right upper 5 digit monitor display the "TIME", and right lower monitor display setting value, the unit is "S". The range is 1S ~99999S.

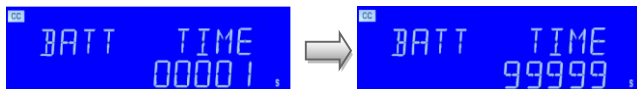

- BATT VTH: the Left 5 digit monitor display the "BATT", the right upper 5 digit monitor display the "VTH", and right lower monitor display setting value, the unit is "V". The range is 0.01V to the full scale of the Voltage specification.

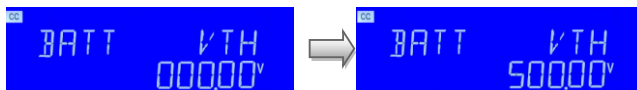

Item

Setting

Exit

Press the Item key to enter the Item setting mode BATT PRESS START, the LED indicator is ON, and then press the Setting key. The LED indicator is ON. To exit the setting, press the EXIT key and select LIN MODE.

The setting sequence is as follows:

- BATT PRESS START
- BATT MODE LIN
- BATT LIN
- BATT TIME
- BATT VTH

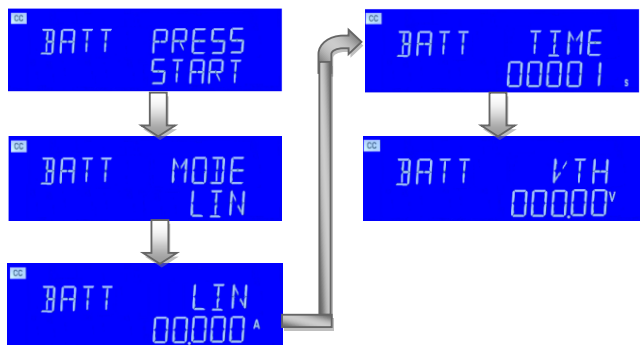

- BATT LIN : setting the BATT LIN, the Left 5 digit monitor display the “BATT” ,the right upper 5 digit monitor display the “LIN”, and right lower monitor display setting value, the unit is “A”. The range is 0.001A to the full scale of the CC mode specification.

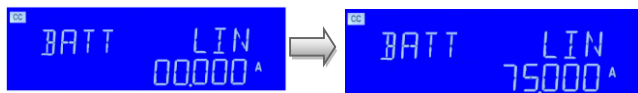

- BATT TIME: setting the BATT TIME, the Left 5 digit monitor display the “BATT” ,the right upper 5 digit monitor display the “TIME”, and right lower monitor display setting value, the unit is “S”. The range is 1s to the 99999s.

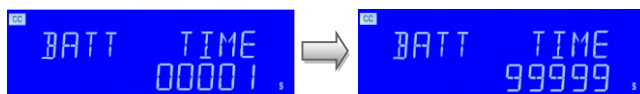

- BATT Vth: Setting BATT threshold voltage; the Left 5 digit monitor display the “BATT” ,the right upper 5 digit monitor display the “VTH”, and right lower monitor display setting value, the unit is “V”. The range is 0.01V to the full scale of the Voltage specification.

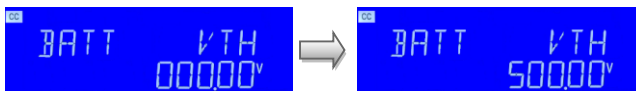

Item

Press the Item key to enter the Item setting mode BATT PRESS START, the LED indicators is ON, and then press the setting key. The LED indicator is ON. To exit the setting, press the EXIT key and select CR MODE.

Setting

Exit

The setting sequence is as follows:

- BATT PRESS START
- BATT MODE CR
- BATT LIN
- BATT TIME
- BATT VTH

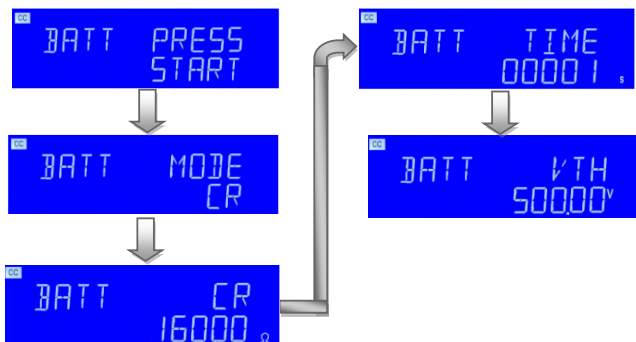

- BATT CR : setting the BATT CR, the Left 5 digit monitor display the "BATT", the right upper 5 digit monitor display the "CR", and right lower monitor display setting value, the unit is "Ω". The range is 0.8Ω to the full scale of the CR mode specification.

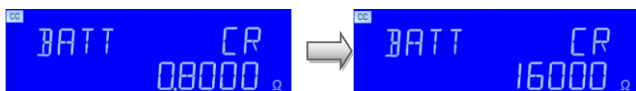

- BATT TIME: setting the BATT TIME, the Left 5 digit monitor display the "BATT", the right upper 5 digit monitor display the "TIME", and right lower monitor display setting value, the unit is "S". The range is 1s to the 99999s.

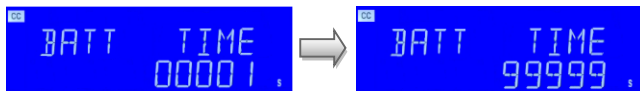

- BATT Vth: Setting BATT threshold voltage; the Left 5 digit monitor display the "BATT", the right upper 5 digit monitor display the "VTH", and right lower monitor display setting value, the unit is "V". The range is 0.01V to the full scale of the Voltage specification.

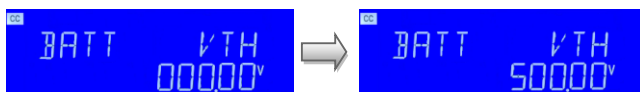

Item

Setting

Exit

Press the Item key to enter the Item setting mode BATT PRESS START, the LED indicators is ON, and then press the Setting key. The LED indicator is ON. To exit the setting, press the EXIT key and select CP MODE.

The setting sequence is as follows:

- BATT PRESS START
- BATT MODE CP
- BATT CP
- BATT CF
- BATT PF LEAD
- BATT PF
- BATT TIME
- BATT VTH

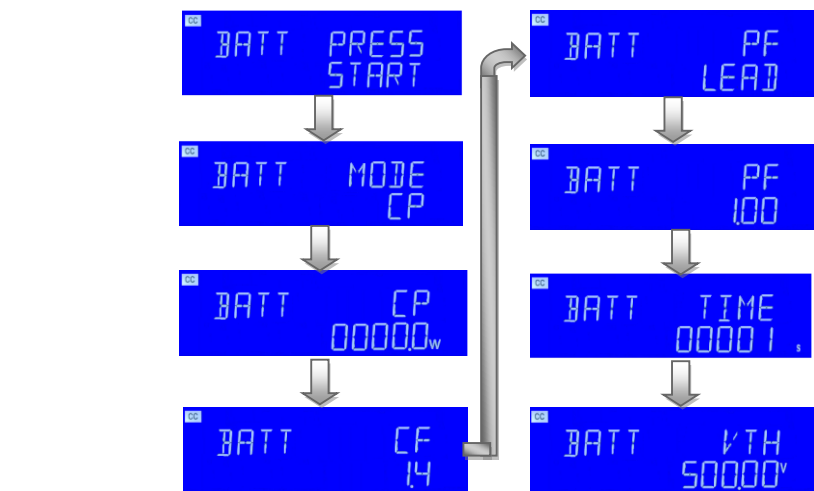

- BATT CP: setting the BATT CP, the Left 5 digit monitor display the “BATT” ,the right upper 5 digit monitor display the “CP” , and right lower monitor display setting value, the unit is “W”. The range is 0.1W to the full scale of the CP mode specification.

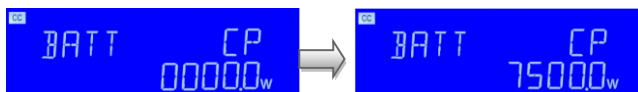

- BATT CF: setting the CF, the Left 5 digit monitor display the “BATT” ,the right upper 5 digit monitor display the “CF” , and right lower monitor display setting value. The range is 1.0, 1.1, 1.2, 1.3, 1.4 ~5.0,

The setting sequence is shown below:

- BATT CF 1.4 ~5.0
- (1.3) BATT CF TRAIL: Trailing edge
- (1.2) BATT CF LEAD: Leading edge
- (1.1) BATT CF LDNEG: negative half-cycle loading
- (1.0) BATT CF LDPOS: positive half-

cycle loading

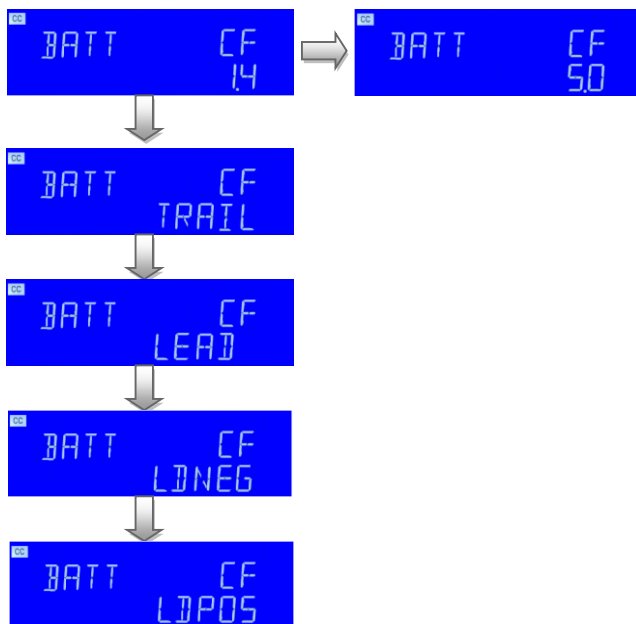

- BATT CF: setting the PF, the Left 5 digit monitor display the "BATT", the right upper 5 digit monitor display the "PF", and right lower monitor display setting value. The range is 0.01 ~1.00.



- BATT TIME: setting the Battery test time, the Left 5 digit monitor display the "BATT", the right upper 5 digit monitor display the "TIME", and right lower monitor display setting value, the unit is "S". The range is 1S ~99999S.

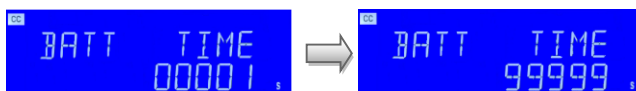

- BATT VTH: the Left 5 digit monitor display the "BATT", the right upper 5 digit monitor display the "VTH", and right lower monitor display setting value, the unit is "V". The range is 0.01V to the full scale of the Voltage specification.

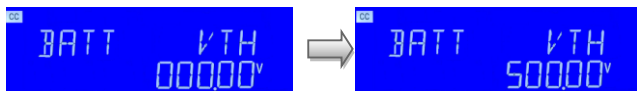

The TRANS parameters setting

Item

Pressing the Item key once will cause the button to illuminate. The message "TRANS PRESS START" will be shown across the displays.

Setting

Each press of the Setting button moves the menu on one step. The Left and right LCDs show the currently selected test parameter as text. The value is adjusted by the rotary knob and can be read from the Right display during setting.

The setting sequence is shown below:

- TRANS PRESS START
- TRANS CC

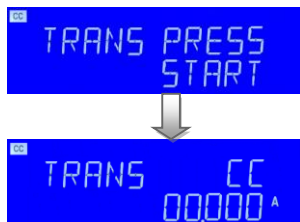

- TRANS CC : setting the Battery current point, the Left 5 digit monitor display the "TRANS", the right upper 5 digit monitor display the "CC", and right lower monitor display setting value, the unit is "A". The range is 0.001A to the full scale of the CC mode specification.

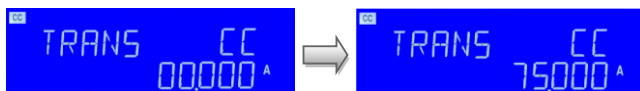

The INRUS parameters setting

Item

Pressing the Item key once will cause the button to illuminate. The message “INRUS PRESS START” will be shown across the displays.

Setting

Each press of the setting button moves the menu on one step. The Left and right LCDs show the currently selected test parameter as text. The value is adjusted by the rotary knob and can be read from the Right display during setting.

The setting sequence is shown below:

- INRUS PRESS START
- INRUS FREQ
- INRUS ISTAR
- INRUS ISTEP
- INRUS TIME
- INRUS ISTOP

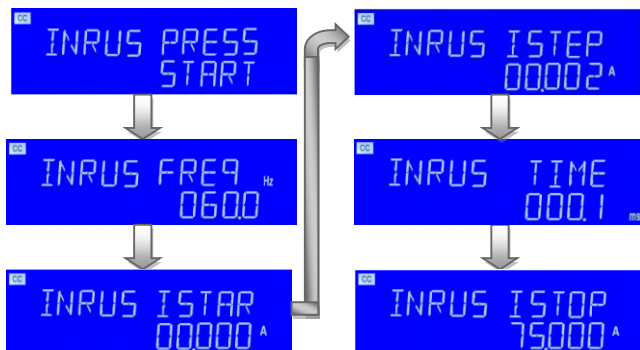

- INRUS FREQ: setting the INRUS FREQ, the Left 5 digit monitor display the "INRUS", the right upper 5 digit monitor display the "FREQ", and Right lower monitor display setting value, the unit is "Hz", use the knob and button to set the Range from DC and 40~ 440Hz.

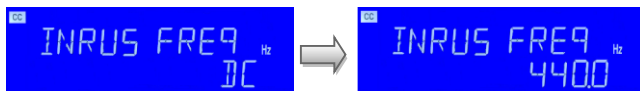

- INRUS ISTAR: setting the INRUS ISTAR, the Left 5 digit monitor display the "INRUS", the right upper 5 digit monitor display the "ISTAR", and right lower monitor display setting value, the unit is "A". Use the knob and button to set the starting current value, the setting range from 0.000A to 150.00A.

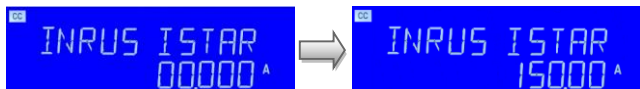

- INRUS ISTEP : setting the INRUS ISTEP, the Left 5 digit monitor display the "INRUS", the right upper 5 digit monitor display the "ISTEP", and right lower monitor display setting value, the unit is "A". Use the knob and button to set the ISTEP current value, the setting range from 0.000 A to 150.00A.

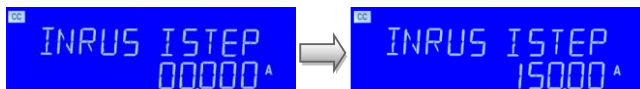

- INRUS TIME : setting the INRUS TIME, the Left 5 digit monitor display the “INRUS”, the right upper 5 digit monitor display the “TIME”, and right lower monitor display setting value, the unit is “ms”. Use the knob and button to set the time, the setting range from 0.1ms to the 100.0ms.

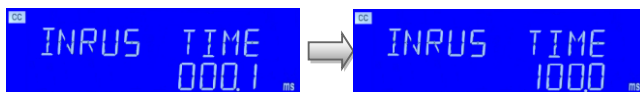

- INRUS ISTOP: setting the INRUS ISTOP, the Left 5 digit monitor display the “INRUS”, the right upper 5 digit monitor display the “ISTOP”, and right lower monitor display setting value, the unit is “A”. Use the knob and button to set the ISTOP current value, the setting range from 0.000 A to 75.000A.

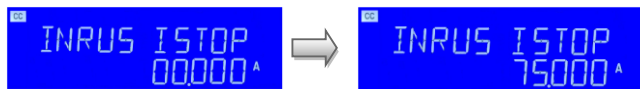

The SURGE parameters setting

Item

Pressing the Item key once will cause the button to illuminate. The message “SURGE PRESS START” will be shown across the displays.

Setting

Each press of the setting button moves the menu on one step. The Left and right LCDs show the currently selected test parameter as text. The value is adjusted by the rotary knob and can be read from the Right display during Setting.

The setting sequence is shown below:

- SURGE PRESS START
- SURGE FREQ
- SURGE S1
- SURGE T1

- SURGE S2
- SURGE T2
- SURGE S3
- SURGE T3

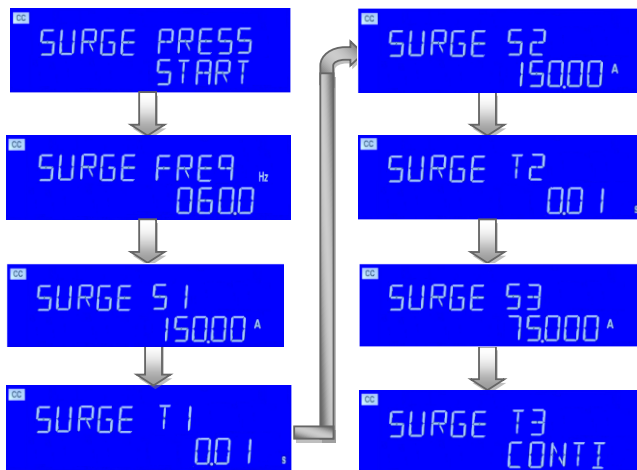

- SURGE FREQ: setting the SURGE FREQ, the Left 5 digit monitor display the "SURGE", the right upper 5 digit monitor display the "FREQ", and Right lower monitor display setting value, the unit is "Hz", use the knob and button to set the Frequency value, the setting range from DC and 40~ 440Hz.

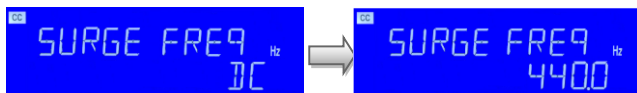

- SURGE S1: setting the SURGE S1, the Left 5 digit monitor display the "SURGE", the right upper 5 digit monitor display the "S1", and right lower monitor display setting value, the unit is "A", use the knob and button to set the first surge current value, the setting range from 0.000A to the 150.00A.

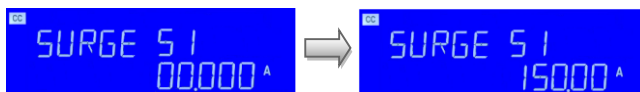

- SURGE T1: setting the SURGE T1, the Left 5 digit monitor display the "SURGE", the right upper 5 digit monitor display the "T1", and right lower monitor display setting value, the unit is "S", use the knob and button to set the first surge current time value, the setting range from 0.01s to the 0.50s.

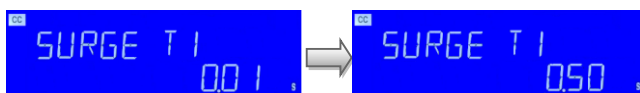

- SURGE S2: setting the SURGE S2, the Left 5 digit monitor display the "SURGE", the right upper 5 digit monitor display the "S2", and right lower monitor display setting value, the unit is "A", use the knob and button to set the second surge current value, the setting range from 0.000A to the 150.00A.

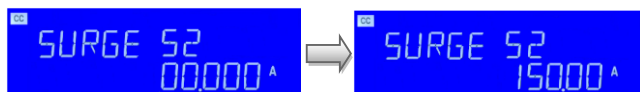

- SURGE T2: setting the SURGE T2, the Left 5 digit monitor display the "SURGE", the right upper 5 digit monitor display the "T2", and right lower monitor display setting value, the unit is "S", use the knob and button to set the second surge current time value, the setting range from 0.01s to the 0.50s.

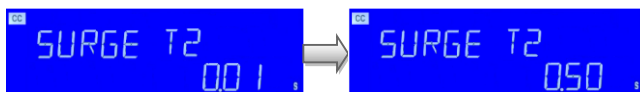

- SURGE S3: setting the SURGE S3, the Left 5 digit monitor display the "SURGE", the right upper 5 digit monitor display the "S3", and right lower monitor display setting value, the unit is "A", use the knob and button to set the Third surge current value, the setting range from 0.000A to the 75.000A.

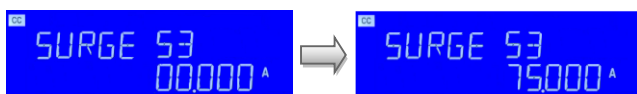

Start/Stop Key



Pressing the Item key once will cause the button to illuminate. The message "SURGE PRESS START" will be shown across the displays. The red START/STOP key is used in conjunction with the SHORT, OCP, OPP, Non-L, NL+CR, FUSE, BATT, TRANS test functions. It is used to START a test according to the set parameters or to STOP a test before PASS or FAIL is signaled. Please refer to the preceding sections for more information on the SHORT, OCP, OPP, Non-L, NL+CR, FUSE, BATT, TRANS tests.

Entry key description



Rotary Knob and ARROW Keys The ROTARY knob and ARROW keys are used to increase or decrease the set values.

- Clockwise the rotary switch and UP arrow key to increase the setting values.

- Anti-clockwise the rotary switch and DOWN arrow key to decrease the setting values.

- Keypad KEY: When using the Keypad, please enter the number, press the Enter key.

- Backspace KEY: Setting, press the Clear key to clear the input value.

Note	In CR mode, increase setting value define for current value, so clockwise the rotary switch and press UP key will decrease the resistance value to increase the current value. Anti-clockwise the rotary switch and press DOWN key will increase the resistance value to decrease the current value.
------	--

C CONNECTION

Rear Panel	105
Connecting the I-monitor to an oscilloscope	109
Master/Slave Description	110
2 operating modes for Master/Slave	112
Boost mode	112
3PH mode.....	113
REMOTE operating	117

typical
connection of
AEL-5000 Series
load module

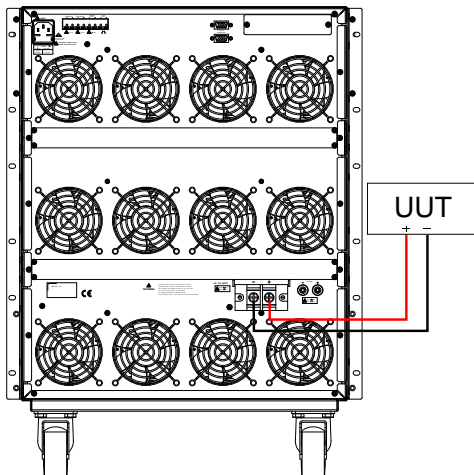

V-sense input
terminal

In order to solve the voltage drop of the conductor under the condition of big load current, Vsense-CLIP cable can be used to connect with the specific point to be measured thus obtaining the specific voltage value.

typical
connection of
AEL-5000 Series
load module

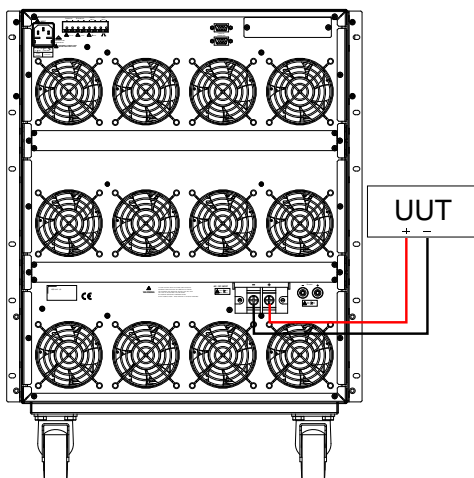

I-monitor

The I-monitor is provided as a socket. It is designed to enable the user to monitor the

Electronic Load's input current or short current. The I-monitor's signal is 0V to 10V. This signal is proportional to the full scale current that the particular electronic load is capable of.

Example

AEL-5008-350-75: $I_{max} = 75A$ therefore I-monitor $10V = 75A$ so $1V = 7.5A$

Please refer to the specification paragraph for the maximum current that each AEL-5000 series load is capable of.



CAUTION

The current monitor of this unit is NOT isolated. Please be careful when you connect an oscilloscope. Improper connections are likely to cause damage. Please follow the connection rule on below.

An equivalent circuit in terms of the current monitor

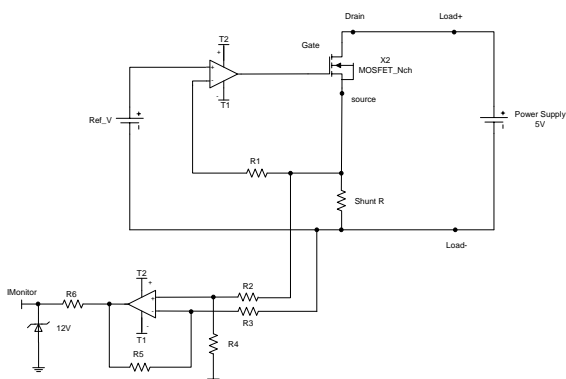

V-monitor

V-monitor output signal is mainly designed connection to the oscilloscope, observe UUT Voltage waveform, The V-monitor's signal is 0V to 10V.

Analog programming input

The Electronic Load has an analog programming input on the rear panel of the mainframe. The analogue programming input enables the load module to track and load according to an external 0-10V (ac or ac + dc) signal.

The analog programming input is configured as a terminal on the mainframe's rear panel.

The AEL-5000 series Load will attempt to load proportionally according to the signal and the load module's maximum current or power range.

For example: AEL-5008-350-75: $I_{max} = 75A$ and $P_{max} = 7500W$

So in CC mode if analogue programming input is $5V = 37.5A$ load setting or in CP mode if analogue programming input is $1V = 750W$ load setting

In the Constant Current mode, $0V$ to $10V$ analog input signal can be set to $0A$ to full scale of the load current to AEL-5008-350-75 $350V / 75A / 7500W$ electronic load, $10V$ analog input signal can produce $75A$ load current.

In the Constant power mode, $0V$ to $10V$ analog input signal can be set to $0W$ to full scale of the load power to AEL-5008-350-75 $350V / 75A / 7500W$ electronic load, $10V$ analog input signal can produce $7500W$ load Power.

Note

The above operation must be LOAD ON

Connecting the I-monitor to an oscilloscope

When you connect this product to an oscilloscope, please ensure the correct polarities of the connecting probes as shown in fig below

(Correct)
Connections to
an oscilloscope

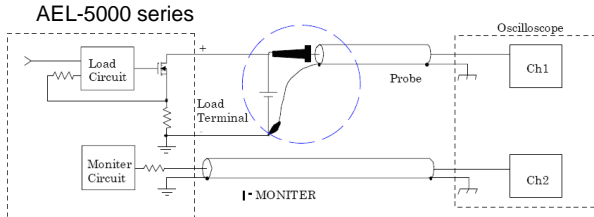

WARNING

(Wrong)
Connections to
an oscilloscope

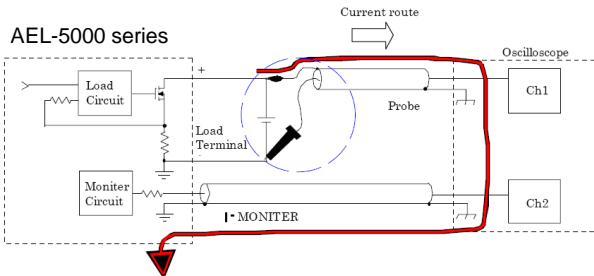

If the probes connection is reversed as shown above, a large current would flow through the probe and the internal circuitry of the oscilloscope is likely to be damaged.

Master/Slave Description

Background AEL-5000 Series “MASTER / SLAVE” Parallel function, 1 Master, 7 SLAVE, setting method press the System key to set the CONTROL MODE to select ALONE, MASTER or SLAVE1 ~ 7, Press the ENTER key to set, when Power off Data will not be lost, this parameter is saved. Master will automatically detect whether there is slave machine, if there is no Slave Machine will run “ALONE Mode”, if the Slave machine will run “MASTER Mode”.

Master machine measuring current and power meter is to show the total current and total power (Master + Slave), the voltage meter is displayed by the Master Machine, the Slave machine voltage meter position will display “SL1” ~ “SL7”.

Note

- Master/Slave operation in parallel cannot be performed on different models.
- When Master / Slave is operated in parallel, the left and right keys are invalid.
- Master/Slave operation in parallel, When Limit is set OPL or OCL functions, Slave will not display the setting value.

- CTRL ALONE
- CTRL MASTE 3PH
- CTRL MASTE bOOST
- CTRL SLAVE 1
- CTRL SLAVE 2
- CTRL SLAVE 3
- CTRL SLAVE 4
- CTRL SLAVE 5
- CTRL SLAVE 6
- CTRL SLAVE 7

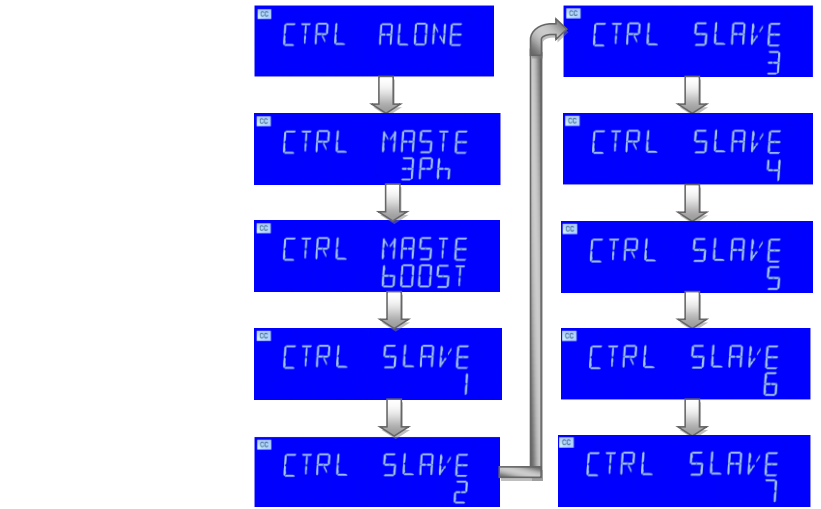

2 operating modes for Master/Slave

Boost mode

Boost mode is for master / slave parallel application, the setting current will be actively shared to each load, Master ammeter will show the total current that is the sum of all ammeters, Slave voltmeter will show SL1 ~ SL2, the others are unchanged.

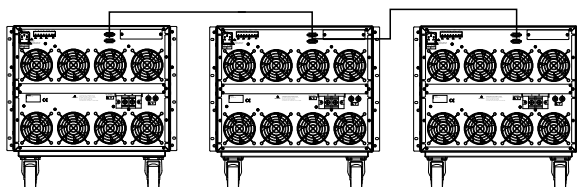

- The following procedure should be followed before applying power on Master/Slave mains:
Step1. Turn on (O) the Slave POWER switch.
Step2. Turn on (O) the Master POWER switch.
- The following procedure should be followed before applying power off
Master/Slave mains:
Step1. Turn off (I) the Master POWER switch.
Step2. Turn off (I) the Slave POWER switch.

Parallel method Use HD-DSUB 15pin 1: 1 Cable to connect the MASTER and SLAVE rear panel, HD-DSUB 15pin connector (connect the upper and lower Connectors)

Caution Do not use VGA Cable, because of internal pin4 ~ 8, 11 and chassis short circuit.

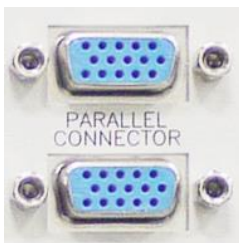

3PH mode

3PH mode is for 3 phase application, three AEL-5000 Series can be connected for three phase Δ or Y connection, the setting current value (single-phase current value) will be sent to each Slave unit automatically, the user does not have to set each unit.

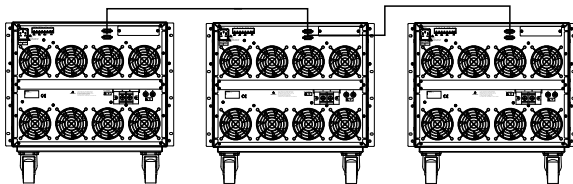











Master 3phase (AEL-5008-350-75 MASTER 3ph/SLAVE model
Manual operation the following is example)

PRESET setting: CC/LIN/CR/CV/CP Mode as Figure, CC setting 60A=Master 60A + Slave 1 60A+ Slave 2 60A, LIN setting 60A=Master 60A + Slave 1 60A+ Slave 2 60A, CR:

1.8333 Ω =Master=Slave
1=1.8333 Ω =Slave2=1.8333 Ω ,

CP: 6600W=Master 6600W = Slave 1 6600W=Slave 2 6600W.

CV: 110V=Master 110V= Slave 1=110V =Slave 2=110V.

CC is set to 60A	Master 3phase Display	
	Slave 1 Display	
	Slave 2 Display	
LIN is set to 60A	Master 3phase Display	
	Slave 1 Display	
	Slave 2 Display	
CR is set to 1.8333Ω	Master 3phase Display	
	Slave 1 Display	
	Slave 2 Display	
CP is set to 6600W	Master 3phase Display	
	Slave 1 Display	

Slave 2 Display



CV is set to 110V Master 3phase Display



Slave 1 Display



Slave 2 Display



Master boost Manual operation (AEL-5008-350-75 MASTER boost/SLAVE model the following is example)

PRESET Setting: CC/LIN/CR/CV/CP Mode as Figure, CC setting 180A=Master 60A + Slave 1 60A+ Slave 2 60A, LIN setting 180A=Master 180A + Slave 1 60A+ Slave2 60A,

CR: 800Ω = Master// Slave1// Slave2 = 800Ω // 2400Ω // 2400

CP: 22500W = Master 22500W+Slave 1 7500W + Slave 2 7500W.

CC is set to 180A Master booster Display



Slave 1 Display



Slave 2 Display



LIN is set to 180A	Master booster Display	
	Slave 1 Display	
	Slave 2 Display	
CR is set to 2400Ω	Master booster Display	
	Slave 1 Display	
	Slave 2 Display	
CP is set to 22500W	Master booster Display	
	Slave 1 Display	
	Slave 2 Display	

Note Master Mode operation except CC /LIN / CR / CV / CP MODE, The following functions will be disabled.

- Recall/Store Disable.
- ALL test item functions disable.(That will be enable When master mode setting to 3PH)
- EXTIN Disable

REMOTE operating

Master Mode can use the command as follows

SETTING PRESET NUMERIC COMMAND	REMARK
MODE {SP} {CC LIN CR CV CP} {;} NL}	
OCL{SP} {NR2} {;} NL}	
OPL{SP} {NR2} {;} NL}	
SENS {SP} {ON OFF 1 0} {;} NL}	0:OFF, 1:ON
ON:ANG{SP} {NR2} {;} NL}	
OFF:ANG{SP} {NR2} {;} NL}	
CC CURR:{A B} {SP} {NR2}{;} NL}	
LIN:{A B} {SP} {NR2}{;} NL}	
CR RES:{A B} {SP} {NR2}{;} NL}	
CV VOLT: {A B}{SP}{NR2}{;} NL}	
CVI: {A B}{SP}{NR2}{;} NL}	
CP:{A B} {SP} {NR2}{;} NL}	
MODE {SP} {CC LIN CR CP} {;} NL}	
LEV {SP} { A B 0 1} {;} NL}	
FREQ {SP} {AUTO NR2} {;} NL}	0, 40~440Hz
PF {SP} {NR2} {;} NL}	
CF {SP} {NR2} {;} NL}	1.4~5.0
LOAD {SP}{ON OFF 1 0} {;} NL}	
MEAS:CURR {?}{;} NL}	
MEAS:VOLT {?}{;} NL}	
MEAS:POW {?}{;} NL}	
MEAS:VA {?}{;} NL}	
MEAS:VAR {?}{;} NL}	
MEAS:PF {?}{;} NL}	
MEAS:CF {?}{;} NL}	
MEAS:FREQ {?}{;} NL}	
MEAS:V_THD {?}{;} NL}	
MEAS:I_THD {?}{;} NL}	
MEAS:V_HARM {?}{;} NL}	
MEAS:I_HARM {?}{;} NL}	

HARM {SP} {NR1} {;} NL}	1~50;select Harmonic step
SYNC {SP}{ON OFF} {;} NL}	
MEAS:TYPE{SP} {RMS PEAK MAX MIN} {;} NL}	
REMOTE {;} NL}	RS232/USB/LAN command
LOCAL{;} NL}	RS232/USB/LAN command

AUTO SEQUENCE 3PH MODE can't be used command

AUTO SEQUENCE Set the command	NOTE	RETURN
FILE {SP} {n}{;} NL}	n=1~9	1~9
STEP {SP} {n} {;} NL}	n=1~32	1~32
TOTSTEP {SP} {n}{;} NL}	Total step n=1~32	1~32
SB {SP} {n} {;} NL}	LOAD State n=1~150	1~150
TIME {SP} {NR2} {;} NL}	100~9999 (ms)	100~9999 (msec)
SAVE {;} NL}	Save "File n" data	
REPEAT {SP} {n} {;} NL}	n=0~9999	0~9999
RUN {SP} {F} {n} {;} NL}	n=1~9	AUTO REPLY "PASS" or "FAIL:XX" (XX=NG STEP)
BEEP{SP}{ON OFF}{;} NL}	SET BUZZER ON/OFF	

3PH Mode use the command: In addition 3PH Mode can use the "GLOB:" command in table below

COMMAND	RETURN
	Master,Slave1,Slave2,
GLOB: MEAS: CURR {?}{;} NL}	###.###,###.###,###.###,
GLOB: MEAS: VOLT {?}{;} NL}	###.##,###.##,###.##,
GLOB: MEAS: POW {?}{;} NL}	#####.#,#####.#,#####.##,
GLOB: MEAS: VAR {?}{;} NL}	#####.#,#####.#,#####.##,

GLOB: MEAS: VA {?}; NL}	#####.#,#####.#,#####.#,
GLOB: MEAS: V_THD {?}; NL}	###.##,###.##,###.##,
GLOB: MEAS: I_THD {?}; NL}	###.##,###.##,###.##,
GLOB: MEAS: V_HARM {?}; NL}	###.##,###.##,###.##,
GLOB: MEAS: I_HARM {?}; NL}	###.###,###.###,###.###,
GLOB: MEAS: PF {?}; NL}	###.##,###.##,###.##,
GLOB: MEAS: CF {?}; NL}	#####.#,#####.#,#####.#,
GLOB: MEAS: FREQ {?}; NL}	#####.#,#####.#,#####.#,

INSTALLATION

Check line voltage.....	121
Grounding requirements.....	122
Power up	123
Connection to the load Input Terminal.....	124
Interface Card	125
GPIB & RS232 interface option.....	125
RS232 interface option.....	126
GPIB interface option	127
USB interface option.....	127
LAN interface option	127
I/O connection	128
Load wire inductance.....	129
Parallel and three-phase control	133
3 phase Y connection.....	133
3 phase Δ connection	133
Parallel connection.....	133

Check line voltage

Background The AEL-5000 Series high power AC/DC load can operation with 100 Vac ~240Vac input as indicated on the label on the rear panel. Make sure that the factory check mark corresponds to your nominal line voltage. Skip this procedure if the label is corrected marked.

- Installation**
1. With the AEL-5000 Series AC/DC load power OFF, disconnect the power cord.
 2. Refer the drawing on the rear panel of AEL-5000 Series high power load below.

Model	Fuse spec
AEL-5023-350-112.5 AEL-5023-425-112.5	T10A/250V(5*20mm)
AEL-5019-350-112.5 AEL-5019-425-112.5	T8A/250V(5*20mm)
AEL-5015-350-112.5 AEL-5015-425-112.5	T6A/250V(5*20mm)
AEL-5012-350-112.5 AEL-5012-425-112.5	T4A/250V(5*20mm)
AEL-5008-350-75 AEL-5008-425-75 AEL-5006-350-56 AEL-5006-425-56	T3A/250V(5*20mm)
AEL-5002-350-18.75 AEL-5002-450-18.75 AEL-5003-480-18.75 AEL-5003-350-28 AEL-5003-425-28 AEL-5004-480-28 AEL-5004-350-27.5 ALE-5004-425-37.5	T2A/250V(5*20mm)

Grounding requirements

Installation

1. It is requested to use the 3Pin plug connector only for AEL-5000 Series mainframe to out of danger when electric leakage. And the complete and proper grounded is necessary.
 2. The AEL-5000 Series high power AC/DC load is equipped with three conductor cable which plugs in an appropriate receptacle to ground the instrument's cover.
-

Power up

The following procedure should be followed before applying mains power:

- | | |
|-----------|--|
| Procedure | <ol style="list-style-type: none">1. Turn off (O) the POWER switch.2. Check that the power cord is corrected.3. Check that nothing is connected to the DC INPUT on the rear panels.4. Turn on POWER switch. |
|-----------|--|
-

Connection to the load Input Terminal

Connection procedure of the load input terminal on the rear panel

- | | |
|-----------|---|
| Procedure | <ol style="list-style-type: none">1. Turn off POWER switch.2. Check that the output of the equipment under test is off.3. Connect the load wire to the load input terminal on the rear panel.4. Check the polarity of the connection and connect the load wire to the output |
|-----------|---|
-

Note	Avoid equipment damaged, don't input the DC voltage standard output to the DC Load input terminal, if calibration voltage meter required, please input the DC voltage standard to the Vsense input.
------	---

Interface Card

GPIB & RS232 interface option

Connection procedure of the load input terminal on the rear panel

- | | |
|-----------|--|
| Procedure | <ol style="list-style-type: none"> 1. GPIB + RS232 interface is on the rear panel of AEL-5000 Series Mainframe for application GPIB or RS232 . 2. GPIB and RS232 interface can only be used at the same time, to Change the interface must reboot unit. 3. GPIB connection with three important limitations as Described below: <ul style="list-style-type: none"> • The maximum number of devices including the controller is no More than 15. • The maximum length of all cable is no more than 2 meters times The Number of devices connected together, up to 20 meters Maximum. 4. RS232 Female Block connections on the back panel, the Connecting Device and the computer RS232 port to one-way Connection. |
|-----------|--|
-

The figure below shows the RS232 connector (Female) on the rear panel Connects AEL-5000 Series Mainframe to RS232 port of computer in one By one Configuration .The RS232 BAUD-RATE can be set in the front Panel, it Will be lit the GPIB Address when press the “SYSTEM” button. Press it again, it will be lit the BAUD-RATE.

AEL-5000 Series
GPIB & RS232
interface

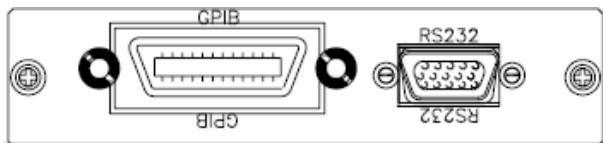

RS232 interface option

Connection procedure of the load input terminal on the rear panel

The figure below shows the RS232 connector (Female) on the rear panel connects AEL-5000 Series mainframe to RS232 port of computer in one by one configuration. The RS232 BAUD-RATE can be set in the front panel, it will be lit the GPIB address when press the "SYSTEM" button. Press it again, it will be lit the BAUD-RATE.

AEL-5000 Series
RS232 interface



GPIB interface option

Connection procedure of the load input terminal on the rear panel

The maximum number of devices including the controller is no more than 15.

The maximum length of all cable is no more than 2 meters times the Number of devices connected together, up to 20 meters maximum.

AEL-5000 Series
GPIB interface

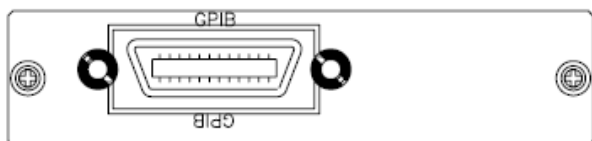

USB interface option

Connection procedure of the load input terminal on the rear panel

The figure below shows the USB connector in the rear panel of AEL-5000 Series mainframe.

AEL-5000 USB
interface



Note

Please refer Appendix on page 249 for details about USB instruction.

LAN interface option

Connection procedure of the load input terminal on the rear panel

The figure below shows the LAN connector in the rear panel of AEL-5000 Series mainframe.

AEL-5000 LAN interface



Note Please refer Appendix on page 255 for details about LAN instruction.

I/O connection

Connection procedure of the load input terminal on the rear panel

AEL-5000 Series I/O Interface with I monitor, V-monitor, Analog Programming Input, SYNC input

AEL-5000 Series I/O Connection

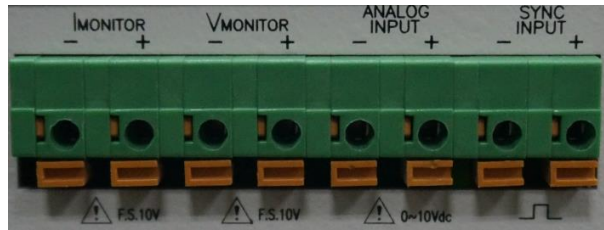

Load wire inductance

Connection procedure of the load input terminal on the rear panel

The load wiring has an inductance (L). When the current (I) varies in short time period, It generates a large voltage at both ends of the wiring cable. This voltage applies to all of the load input terminals of the AEL-5000 Series when the impedance of the EUT is relatively small. The voltage generated by the load wire inductance (L) and the current variation (I) is expressed using the following equation.

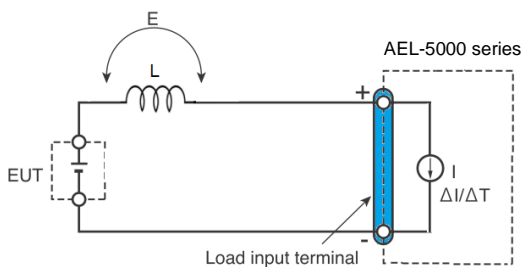

$$E = L \times (\Delta I / \Delta T)$$

E: Voltage generated by the wire inductance

L: Load wire inductance

ΔI : Amount of Current variation

ΔT : Variation period of current

In general, the wire inductance can be measured approximately $1 \mu\text{H}$ per 1 meter. If the 10 meters of Load wires is connected between the EUT and the electronic load (AEL-5000 Series) with the current Variation of $2 \text{ A}/\mu\text{s}$, the voltage generated by the wire inductance Will be 20 V.

The negative polarity of the load input terminal is the reference potential of the external Control signal, Therefore, the device connected to the external control terminal may get malfunctioned.

When operating under the constant voltage (CV) mode or constant resistance (CR) mode or constant power (CP), the load current is varied by the voltage at the load input terminal, so the operation can be affected easily by the generated voltage.

The wiring to the EUT should be twisted and the shortest as possible.

If the load wire is long or has a large loop, the wire inductance is increased. Consequently, the Current variation that results when switching occurs will cause a large voltage drop.

When the value of instantaneous voltage drops under the minimum operating voltage depends on the generated voltage at the load input terminal, the response of recovery will be extensively delayed.

In such event, the electronic load (AEL-5008-350-75) may generate unstable oscillation. In such condition, the input voltage may exceed the maximum input voltage and Cause damage to the AEL-5000 series.

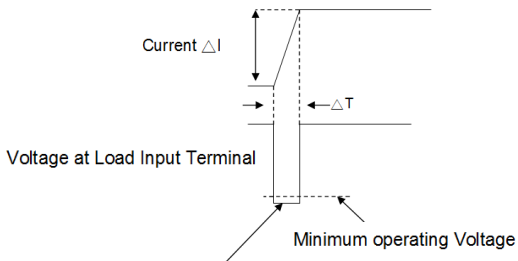

When the Voltage drops under minimum operating voltage, the electronic load may generate unstable oscillation

Waveform example:
Generate unstable oscillation

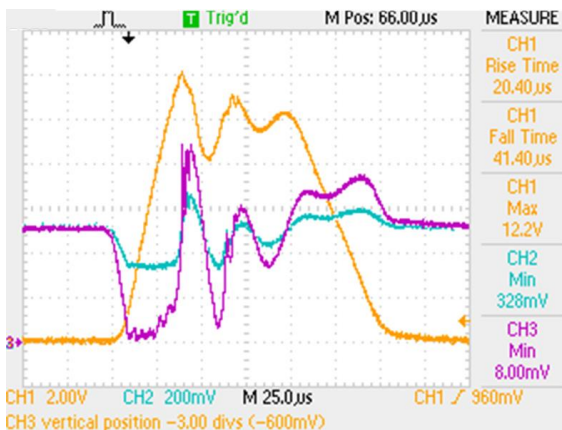

CH1= Imonitor

CH2=Power Supply output Voltage (x10)

CH3= LOAD Input Voltage (x10)

You must be careful especially when the slew rate setting is high or switching is performed using large currents through parallel operation.

To prevent problems, connect the AEL-5000 series and the equipment under test using the shortest Twisted Wire possible to keep the voltage caused by inductance between the minimum operating Voltage and the maximum input voltage range or set a low slew rate.

If the high-speed response operation is not required, decrease the slew rate setting.

In such settings, the value of DI / DT will be decreased, accordingly the generated voltage Will be reduced even the inductance of load wiring can't be reduced.

In the case of DC operation also, the phase delay of the current may cause instability in the AEL-5000 series Control inducing oscillation. In this case also, connect the AEL-5000 series and the equipment under test using the shortest twisted wire possible.

If only DC operation is required, a capacitor may be connected to the load Input Terminal as shown in Fig below to alleviate oscillation. In this case, use the capacitor within its Allowable ripple current.

Length of wiring

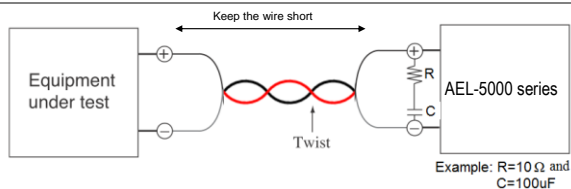

Parallel and three-phase control

3 phase Y connection

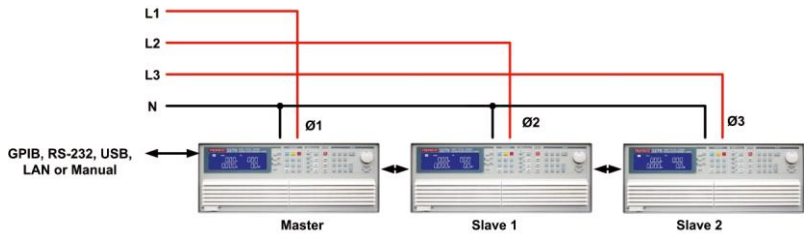

3 phase Δ connection

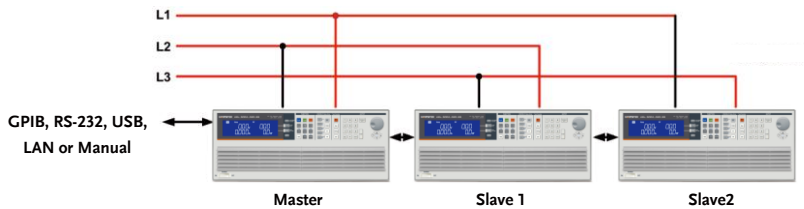

Parallel connection

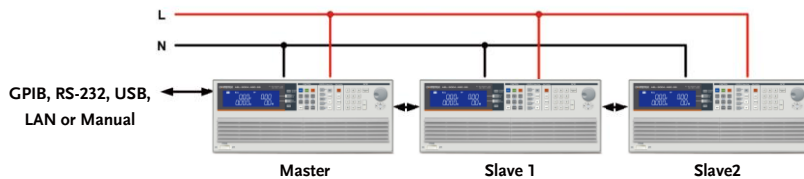

REMOTE CONTROL

The rear panel remote control interface of AEL-5000 Series mainframe is designed to connect PC or NOTEBOOK PC with remote control interface, the NOTEBOOK PC acts as a remote controller of AEL-5000 Series Electronic Load.

This feature can be used as an automatic load/cross load regulation and centering voltage testing for a switching power supply or an rechargeable battery charge/discharge characteristic testing. The function capability of rear panel remote control interface not only can set the load level and load status, but also can read back the load voltage and load current.

Note	When use USB/LAN interface controls the AEL-5000 series, the AEL-5000 series will convert the USB/LAN interface to RS232 interface
------	--

Interface Configuration	135
Configure RS232C	135
Communication Interface programming	
command list.....	137
SIMPLE TYPE FORMAT	137
System command.....	141
Measure command	141
AUTO SEQUENCE.....	142
COMPLEX TYPE FORMAT	142
Command Syntax	148
The description of abbreviation	148
Communication Interface programming command syntax	
description	148
Command List	150

Interface Configuration

Configure RS232C

The following RS232 commands are same as GPIB commands. The RS232 protocol in AEL-5000 Series mainframe is listing below:

RS232C Configuration	Baud Rate	9600~115200bps
	Stop Bit	1 bit
	Data Bit	8 bits
	Parity	None
	Handshaking	Hardware (RTS/CTS)

The RS232 Interface connector of AEL-5000 Series rear panel

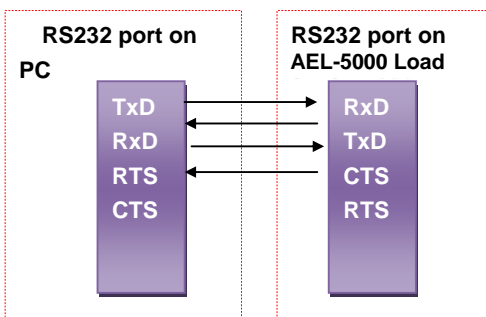

Inside of AEL-5000 series Mainframe

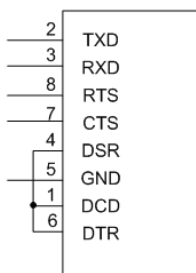

Pin Assignment

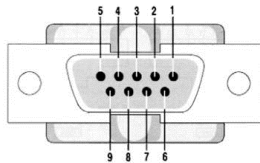

PIN	Abbreviation	Description
Pin1	CD	Carrier Detect
Pin2	RXD	Receive
Pin3	TXD	Transmit
Pin4	DTR	Data Terminal Ready
Pin5	GND	Ground
Pin6	DSR	Data Set Ready
Pin7	RTS	Request To Send
Pin8	CTS	Clear To Send
Pin9	RI	Ring Indicator

Communication Interface programming command list

SIMPLE TYPE FORMAT

Table: Communication interface programming setting command summary

SETTING PRESET NUMERIC COMMAND	Note
HARM{SP} {NR1} {;} NL}	HARMONICS 1~50
LIN:{A B} {SP} {NR2}{;} NL}	
CC CURR:{A B} {SP} {NR2}{;} NL}	
CP:{A B} {SP} {NR2}{;} NL}	
CR RES:{A B} {SP} {NR2}{;} NL}	
CV VOLT:{A B} {SP} {NR2}{;} NL}	
CVI:{A B} {SP} {NR2}{;} NL}	CV CURR
TCONFIG{SP}{NORMAL OCP OPP SHORT NLIN NLCR FUSE BATT TRANS INRUSH SURGE }{;} NL}	
OCP:START {SP} {NR2}{;} NL}	
OCP:STEP {SP} {NR2}{;} NL}	
OCP:STOP {SP} {NR2}{;} NL}	
VTH {SP} {NR2}{;} NL}	
OPP:START {SP} {NR2}{;} NL}	
OPP:STEP {SP} {NR2}{;} NL}	
OPP:STOP {SP} {NR2}{;} NL}	
STIME {SP} {NR2}{;} NL}	
PF {SP} {+ -} {NR2}{;} NL}	Power factor
CF {SP} {NR2}{;} NL}	Crest factor
BATT:MODE {SP}{CC LIN CV CP}{;} NL}	
BATT:TIME {SP} {NR1}{;} NL}	
EXTIN{SP}{ON OFF}{;} NL}	
TURBO {SP}{ON OFF}{;} NL}	
FUSE:CC {SP}{NR2}{;} NL}	
FUSE:TIME {SP} {NR2}{;} NL}	

FUSE:TYPE {SP} {TRIP NTRIP}{; NL}	
FUSE:REP {SP} {NR1}{; NL}	
AVG{SP} {NR2}{; NL}	NR2:1 2 4 8 16
CPRSP{SP} {NR2}{; NL}{; NL}	NR2:0~7
CYCLE{SP} {NR2}{; NL}	NR2:1~16
ON:ANG{SP} {NR2}{; NL}	0~359
OFF:ANG{SP} {NR2}{; NL}	0~359
BW {SP} {NR2}{; NL}	
FREQ {SP} {AUTO NR2}{; NL}	0,40~440Hz
ITIME {SP} {NR2}{; NL}	0.1ms~100.0ms
ISTART {SP} {NR2}{; NL}	
ISTEP {SP} {NR2}{; NL}	
ISTOP{SP} {NR2}{; NL}	
SURGE:Tn{SP} {NR2}{; NL}	
SURGE:Sn{SP} {NR2}{; NL}	
SNUB {SP} AUTO ON OFF{; NL}	

Table: Communication Interface programming query command summary

QUERY PRESET NUMERIC COMMAND	RETURN
HARM{?}{NR2}{; NL}	##
LIN:{A B}{?}{; NL}	###.###
CC CURR:{A B}{?}{; NL}	###.###
CP:{A B}{?}{; NL}	#####.#
CR RES:{A B}{?}{; NL}	#####.#####
CV VOLT:{A B}{?}{; NL}	###.###
CVI{?}{; NL}	###.###
TCONFIG {?}{; NL}	1:NORMAL 7:FUSE 2:SHORT 8:BATT 3:OPP 9:Trans 4:OCP 10:INRUSH 5: non-LIN 11:SURGE 6: nocLIN+CR
OCP: START{?}{; NL}	###.###
OCP: STEP{?}{; NL}	###.###
OCP: STOP{?}{; NL}	###.###
VTH {?}{; NL}	###.###
OPP: START{?}{; NL}	#####.#
OPP: STEP{?}{; NL}	#####.#

OPP: STOP{?}; NL}	#####.#
STIME{?}; NL}	#####
PF {?}; NL}	###.##
CF {?}{NR2}; NL}	#####
OCP{?}; NL}	###.###
OPP{?}; NL}	#####.#
BATT:MODE {?}; NL}	0~3=CC/LIN/CR/CP
BATT:TIME {?}; NL}	#####
DISC:TIME {?}; NL}	
DISC:AH {?}; NL}	
EXTIN{?}; NL}	0~1
TURBO{?}; NL}	0~1
FUSE:CC {?}; NL}	###.###
FUSE:TIME {?}; NL}	#####
FUSE:TYPE {?}; NL}	0~1
FUSE:REP {?}; NL}	0~255
TRIP:TIME {?}; NL}	#####
TRANS:TIME {?}; NL}	###.##
AVG {?}; NL}	1 2 4 8 16
CPRSP {?}; NL}	0~7
CYCLE {?}; NL}	1~16
ON: ANG {?}; NL}	#####
OFF: ANG {?}; NL}	#####
REP: COUNT {?}; NL}	#####
BW {?}; NL}	1~15
FREQ {?}; NL}	###.##
ITIME {?}; NL}	#####
ISTART {?}; NL}	###.###
ISTEP {?}; NL}	###.###
ISTOP {?}; NL}	###.###
SURGE: Tn{?}; NL}	###.##
SURGE:Sn{?}; NL}	###.###
SNUB {?}; NL}	

Table: Communication Interface programming limit command summary

LIMIT COMMAND	RETURN
IH IL {SP} {NR2} {; NL}	
IH IL {?} {; NL}	###.###
WH WL {SP} {NR2} {; NL}	
WH WL {?} {; NL}	#####.#
VH VL {SP} {NR2} {; NL}	
VH VL {?} {; NL}	###.##
SVH SVL {SP} {NR2} {; NL}	
SVH SVL {?} {; NL}	###.##
VAH VAL {SP} {NR2} {; NL}	
VAH VAL {?} {; NL}	#####.#
OPL OCL {SP} {NR2} {; NL}	Over power limit/Over current limit
OPL OCL {?} {; NL}	#####.# / ###.###

Table: STAGE COMMAND SUMMARY

STAGE COMMAND	REMARK
LOAD {SP} {ON OFF 1 0} {; NL}	
LOAD {?} {; NL}	0:OFF 1:ON
MODE {SP} {CC LIN CR CV CP} {; NL}	
MODE {?} {; NL}	0 1 2 3 4:CC LIN CR CV CP
SHOR {SP} {ON OFF 1 0} {; NL}	
SHOR {?} {; NL}	0:OFF 1:ON
PRES {SP} {ON OFF 1 0} {; NL}	
PRES {?} {; NL}	0:OFF 1:ON
SENS {SP} {ON OFF AUTO 1 0} {; NL}	
SENS {?} {; NL}	0:OFF/AUTO 1:ON
LEV {SP} { LOW HIGH 0 1} {; NL}	
LEV {?} {; NL}	0:LOW/A 1:HIGH/B
CLR {; NL}	
CLR:METER {; NL}	
ERR {?} {; NL}	

NG {?}; NL}	0:GO 1:NG
PROT {?}; NL}	
NGENABLE{SP}{ON OFF}; NL}	
START{; NL}	
STOP{; NL}	
TESTING {?}; NL}	0:TEST END,1:TESTING
SYNC {SP}{ON OFF 1 0} {; NL}	
SYNC {?} {; NL}	0:OFF 1:ON

System command

Table: SYSTEM COMMAND SUMMARY

COMMAND	NOTE	RETURN
RECALL {SP} {m }; NL}	m=1~150 , m:STATE	
STORE {SP} {m }; NL}	m=1~150 m:STATE	
REMOTE {; NL}	RS232/USB/LAN command	
LOCAL{; NL}	RS232/USB/LAN command	
NAME {?} {; NL}		“XXXXX”

Measure command

Table: MEASURE COMMAND SUMMARY

COMMAND	RETURN
MEAS:TYPE{SP} {RMS PEAK MAX MIN} {; NL}	
MEAS:CURRE {?}; NL}	###.###
MEAS:VOLT {?}; NL}	###.##
MEAS:POW {?}; NL}	#####.#
MEAS:VAR {?}; NL}	#####.#
MEAS:VA {?}; NL}	#####.#
MEAS:V_THD {?}; NL}	###.##
MEAS:I_THD {?}; NL}	###.##
MEAS:V_HARM {?}; NL}	###.##
MEAS:I_HARM {?}; NL}	###.###

Remark	<ol style="list-style-type: none"> 1. Current engineering unit: A/Arms 2. Resistance engineering unit: Ω 3. Voltage engineering unit: V/Vrms 4. Period engineering unit: mS 5. Frequency engineering unit: Hz. 6. Power engineering unit: W 7. Volt-Ampere engineering unit: VA
--------	--

AUTO SEQUENCE

Table: Auto sequence command list

AUTO SEQUENCE SET COMMAND	NOTE	RETURN
FILE {SP} {n}{; NL}	n=1~9	1~9
STEP {SP} {n} {; NL}	n=1~16	1~32
TOTSTEP {SP} {n}{; NL}	Total step n=1~16	1~32
SB {SP} {n} {; NL}	LOAD State n=1~150	1~150
TIME {SP} {NR2} {; NL}	100~9999(ms)	100~9999(msec)
SAVE {; NL}	Save "File n" data	
REPEAT {SP} {n} {; NL}	n=0~9999	0~9999
RUN {SP} {F} {n} {; NL}	n=1~9	AUTO REPLY "PASS" or "FAIL:XX" (XX=NG STEP)
BEEP{SP}{ON OFF}{; NL}	SET BUZZER ON/OFF	

COMPLEX TYPE FORMAT

Table: Communication Interface programming setting command summary

SETTING COMMAND SUMMARY	REMARK
[PRESet:]HARMonics{SP} {NR1} {; NL}	
[PRESet:]LIN:A B {SP} {NR2} {; NL}	
[PRESet:]CC CURR:{A B} {SP} {NR2}{; NL}	
[PRESet:]CP:{A B} {SP} {NR2}{; NL}	
[PRESet:] CR RES:{A B} {SP} {NR2}{; NL}	

[PRESet:] CV VOLT:{A B} {SP} {NR2}{;} NL}	
[PRESet:] CVI:{A B} {SP} {NR2}{;} NL}	
[PRESet:] TCONFIG {SP} {NORMAL OCP OPP SHORT NLIN NLCR FUSE BATT TRANS INRUSH SURGE }{;} NL}	
[PRESet:]OCP:START {SP} {NR2}{;} NL}	
[PRESet:]OCP:STEP {SP} {NR2}{;} NL}	
[PRESet:]OCP:STOP {SP} {NR2}{;} NL}	
[PRESet:]VTH {SP} {NR2}{;} NL}	
[PRESet:]OPP:START {SP} {NR2}{;} NL}	
[PRESet:]OPP:STEP {SP} {NR2}{;} NL}	
[PRESet:]OPP:STOP {SP} {NR2}{;} NL}	
[PRESet:]STIME {SP} {NR2}{;} NL}	
[PRESet:]PF {SP} {+ -} {NR2}{;} NL}	Power factor
[PRESet:]CF {SP} {NR2}{;} NL}	Crest factor
[PRESet:]BATT:MODE {SP}{CC LIN CV CP}{;} NL}	
[PRESet:]BATT:TIME {SP} {NR1}{;} NL}	
[PRESet:]EXTIN {SP} {ON OFF}{;} NL}	
[PRESet:]TURBO {SP} {ON OFF}{;} NL}	
[PRESet:]FUSE: CC{SP}{NR2}{;} NL}	
[PRESet:]FUSE: TIME {SP} {NR2}{;} NL}	
[PRESet:]FUSE: TYPE {SP} {TRIP NTRIP}{;} NL}	
[PRESet:]FUSE: REP {SP} {NR1}{;} NL}	NR2:1 2 4 8 16
[PRESet:]CPRSP{SP} {NR2}{;} NL}	NR2:0~7
[PRESet:]CYCLE{SP} {NR2}{;} NL}	NR2:1~16
[PRESet:]ON:ANG{SP} {NR2}{;} NL}	0~359
[PRESet:]OFF:ANG{SP} {NR2}{;} NL}	0~359
[PRESet:]BW{SP} {NR2}{;} NL}	
[PRESet:]FREQ{SP} {AUTO NR2}{;} NL}	0, 40~440Hz
[PRESet:]ITIME {SP} {NR2}{;} NL}	0.1ms~100.0ms
[PRESet:]ISTART {SP} {NR2}{;} NL}	
[PRESet:]ISTEP {SP} {NR2}{;} NL}	
[PRESet:]ISTOP{SP} {NR2}{;} NL}	
[PRESet:]SURGE:Tn{SP} {NR2}{;} NL}	
[PRESet:]SURGE:Sn{SP} {NR2}{;} NL}	
[PRESet:]SNUB {SP} AUTO ON OFF{;} NL}	

Table: Communication Interface programming query command summary

QUERY COMMAND SUMMARY	RETURN
[PRESet:]HARMonics{?}; NL}	##
[PRESet:]LIN:{A B}{?}; NL}	###.###
[PRESet:]CC CURR:{A B}{?}{?}; NL}	###.###
[PRESet:]CP:{A B}{?}{?}; NL}	#####.#
[PRESet:]CR RES:{A B}{?}{?}; NL}	#####.#####
[PRESet:]CV VOLT:{A B}{?}{?}; NL}	###.##
[PRESet:] TCONFIG {?}; NL}	1:NORMAL 7:FUSE 2:SHORT 8:BATT 3:OPP 9:Trans 4:OCP 10:INRUSH 5: non-LIN 11:SURGE 6: nocLIN+CR
[PRESet:]OCP: START {?}{?}; NL}	###.###
[PRESet:]OCP: STEP {?}; NL}	###.###
[PRESet:]OCP: STOP {?}; NL}	###.###
[PRESet:]VTH {?}; NL}	###.##
[PRESet:]OPP: START {?}{?}; NL}	#####.#
[PRESet:]OPP: STEP {?}; NL}	#####.#
[PRESet:]OPP: STOP {?}; NL}	#####.#
[PRESet:]STIME {?}; NL}	#####
[PRESet:]PF {?}; NL}	###.##
[PRESet:]CF {?}; NL}	#####.#
[PRESet:]OCP {?}; NL}	
[PRESet:]OPP {?}; NL}	
[PRESet:]BATT MODE {?}; NL}	
[PRESet:]BATT TIME {?}; NL}	
[PRESet:]DISC: TIME {?}; NL}	
[PRESet:]DISC: AH {?}; NL}	
[PRESet:]EXTIN {?}; NL}	
[PRESet:]TURBO {?}; NL}	
[PRESet:]FUSE: CC {?}; NL}	
[PRESet:]FUSE: TIME {?}; NL}	
[PRESet:]FUSE: TYPE {?}; NL}	
[PRESet:]FUSE: REP {?}; NL}	
[PRESet:]TRIP: TIME {?}; NL}	

[PRESet:]TRANS: TIME {?}; NL}	
[PRESet:]AVG {?}; NL}	1 2 4 8 16
[PRESet:]CPRSP {?}; NL}	0~7
[PRESet:]CYCLE {?}; NL}	1~16
[PRESet:]ON: ANG {?}; NL}	#####
[PRESet:]OFF: ANG {?}; NL}	#####
[PRESet:]REP: COUNT {?}; NL}	#####
[PRESet:]BW {?}; NL}	1~15
[PRESet:]FREQ {?}; NL}	###.#
[PRESet:]ITIME {?}; NL}	####.#
[PRESet:]ISTART {?}; NL}	###.###
[PRESet:]ISTEP {?}; NL}	###.###
[PRESet:]ISTOP {?}; NL}	###.###
[PRESet:]SURGE: Tn{?}; NL}	###.##
[PRESet:]SURGE:Sn{?}; NL}	###.###
[PRESet:]SNUB {?}; NL}	

Table: Communication Interface programming limit command summary

LIMIT	RETURN
LIMit:CURRent:{HIGH LOW}{SP}{NR2}; NL}	
LIMit:CURRent:{HIGH LOW}{?}; NL}	###.###
IH IL{SP}{NR2}; NL}	
IH IL {?}; NL}	###.###
LIMit:POWEr:{HIGH LOW}{SP}{NR2}; NL}	
LIMit:POWEr:{HIGH LOW}{?}; NL}	#####.#
WH WL{SP}{NR2}; NL}	
WH WL {?}; NL}	#####.#
LIMit:VOLTagE:{HIGH LOW}{SP}{NR2}; NL}	
LIMit:VOLTagE:{HIGH LOW}{?}; NL}	###.##
VH VL{SP}{NR2}; NL}	
VH VL {?}; NL}	###.##
SVH SVL{SP}{NR2}; NL}	
SVH SVL {?}; NL}	###.##
VAH VAL{SP}{NR2}; NL}	
VAH VAL {?}; NL}	#####.#
OPL OCL{SP}{NR2}; NL}	Over power limit/Over

	current limit
OPL OCL {?}; NL}	#####.# / ###.###

Table: STAGE COMMAND SUMMARY

STAGE COMMAND	REMARK
[STATe:] LOAD {SP}{ON OFF} {; NL}	
[STATe:] LOAD {?} {; NL}	0:OFF 1:ON
[STATe:] MODE {SP} {CC LIN CR CV CP} {; NL}	
[STATe:] MODE {?} {; NL}	0 1 2 3 4:CC LIN CR CV CP
[STATe:] SHORt {SP} {ON OFF} {; NL}	
[STATe:] SHORt {?} {; NL}	0:OFF 1:ON
[STATe:] PRESet {SP} {ON OFF} {; NL}	
[STATe:] PRESet {?} {; NL}	0:OFF 1:ON
[STATe:] SENSe {SP} {ON OFF AUTO} {; NL}	
[STATe:] SENSe {?} {; NL}	0:OFF 1:ON
[STATe:] LEVEl {SP} {A B} {; NL}	
[STATe:] LEVEl {?} {; NL}	0:A 1:B
[STATe:] LEV{SP} {A B} {; NL}	
[STATe:] LEV{?} {; NL}	0:A 1:B
[STATe:] CLRerr{; NL}	
[STATe:] CLR:METER{ ; NL}	
[STATe:] ERRor {?}; NL}	
[STATe:] NO{SP}GOOD {?}; NL}	0:GO 1:NG
[STATe:] NG {?}; NL}	0:GO 1:NG
[STATe:] PROTEct {?}; NL}	
[STATe:] NGENABLE{SP}{ON OFF}; NL}	
[STATe:]START{; NL}	
[STATe:]STOP{; NL}	
[STATe:]TESTING {?}; NL}	0:TEST END,1:TESTING
[STATe:]SYNCronize{SP}{ON OFF} {; NL}	
[STATe:] SYNCronize {?} {; NL}	0:OFF 1:ON

Table: SYSTEM COMMAND SUMMARY

COMMAND	NOTE	RETURN
[SYStem:]RECall {SP} {m} {;} NL}	m=1~150	
[SYStem:]STORe {SP} {m} {;} NL}	m=1~150	
[SYStem:]REMOTE {;} NL}	RS232/USB/LAN command	
[SYStem:]LOCAL{;} NL}	RS232/USB/LAN command	
[SYStem:]NAME {?} {;} NL}		“XXXXXX”

Table: MEASURE COMMAND SUMMARY

COMMAND	RETURN
MEASure:TYPE{SP} {RMS PEAK MAX MIN} {;} NL}	
MEASure:CURREnt {?}{;} NL}	###.###
MEASure:VOLTage {?}{;} NL}	###.##
MEASure:POW {?}{;} NL}	#####.#
MEASure:VAR {?}{;} NL}	#####.#
MEASure:VA {?}{;} NL}	#####.#
MEASure:V_THD {?}{;} NL}	###.##
MEASure:I_THD {?}{;} NL}	###.##
MEASure:V_HARM {?}{;} NL}	###.##
MEASure:I_HARM {?}{;} NL}	###.###

- Remark
1. Current engineering unit: A/Arms
 2. Resistance engineering unit: Ω
 3. Voltage engineering unit: V/Vrms
 4. Period engineering unit: mS
 5. Frequency engineering unit: Hz.
 6. Power engineering unit: W
 7. Volt-Ampere engineering unit: VA

Command Syntax

The description of abbreviation

Command Tree	SP: Space, the ASCII code is 20 Hexadecimal. ;:Semicolon, Program line terminator, the ASCII code is 0A Hexadecimal. NL:New line, Program line terminator, the ASCII code is 0A Hexadecimal. NR2:Digits with decimal point. It can be accepted in the range and format of ###.#####. For Example: 30.12345, 5.0 The description of GPIB programming command syntax.
--------------	---

Communication Interface programming command syntax description

{ }	The contents of the { } symbol must be used as a part or data of the GPIB command, it cannot be omitted.
[]	The contents of the [] symbol indicates the command can be used or not. It depends on the testing application.

| This symbol means option. For example “LOW | HIGH” means it can only use LOW or HIGH as the command, it can choose only one as the setting command.

Terminator: You have to send the program line terminator character after send the GPIB command, the available command terminator characters which can be accepted in AEL-5000 Series mainframe is listed in table below

LF
LF WITH EOI
CR , LF
CR , LF WITH EOI

Semicolon “;”:The semicolon “;” is a back-up command, the semicolon allows you to combine command statement on one line to create command message.

Command List

PRESET Commands.....	152
HARM.....	152
LIN.....	152
ON:ANG.....	152
OFF:ANG.....	152
CC CURR:A B.....	153
CP:A B.....	153
CR RES:A B.....	153
CV VOLT:A B.....	154
CVI VOLT:A B.....	154
TCONFIG.....	154
ITIME.....	155
ISTART.....	155
ISTEP.....	155
ISTOP.....	156
SURGE:Tn.....	156
SURGE:Sn.....	156
OCP:START.....	157
OCP:STEP.....	157
OCP:STOP.....	157
VTH.....	157
OPP:START.....	158
OPP:START.....	158
OPP:STOP.....	158
STIME.....	158
PF.....	159
CF.....	159
BATT:MODE.....	159
BATT:TIME.....	159
DISC:TIME.....	160
DISC:AH.....	160
EXTIN:ON/OFF*(This function is optional).....	160
TURBO:{SP} {ON OFF}.....	160
FUSE:CC.....	161
FUSE:TIME.....	161
FUSE:TYPE.....	161
FUSE:REP.....	161
TRIP:TIME.....	162
TRANS:TIME.....	162
AVG.....	162
CPRSP.....	162

CYCLE.....	163
BW	163
FREQ	163
REP:COUNT.....	164
Limit Commands	165
[LIMit:]CURRent: {HIGH LOW} or IH IL	165
[LIMit:]POWer: {HIGH LOW} or WH WL	165
[LIMit:]VOLTage: {HIGH LOW} or VH VL	166
SVH SVL.....	166
STATE commands	167
[STATe:]LOAD {SP} {ON OFF}	167
[STATe:]MODE {SP} {CC CR CV CP}	167
[STATe:]PRESet {SP} {ON OFF}	168
[STATe:]SENSe {SP} {ON OFF}	169
[STATe:]LEVel {SP} {A B} or LEV {SP} {A B}	169
[STATe:]CLRrerr	170
[STATe:]CLR:Meter.....	170
[STATe:]ERRor	170
[STATe:]NG?	170
[STATe:]PROTEct?	171
[STATe:]NGEABLE {ON OFF}	171
[STATe:]START	171
[STATe:]STOP.....	172
[STATe:]TESTING?	172
[STATe:]SYNCronize.....	172
System Commands	173
[SYStem:]RECall {SP} m {,n}	173
[SYStem:]STORe {SP} m {,n}	173
[SYStem:]NAME?	174
[SYStem:]REMOTE	174
[SYStem:]LOCAL	175
Measure Commands	176
MEASure:CURRent?	176
MEASure:VOLTage?	176
MEASure:POWer?	176
MEASure:VAR?	176
MEASure:VA?	177
MEASure:V_THD?	177
MEASure:L_THD?.....	177
MEASure:V_HARM?.....	177
MEASure:L_HARM?	177

PRESET Commands

Set and Read the Default of Load

HARM

Set →
→ Query

Description	Set and read the HARMONICS
Syntax	[PRESet:]HARM{SP}{NR1}{: NL}
Query Syntax	[PRESet:]HARM{?}{: NL}
Parameter	<NR1> HARMONICS 1~50 1~50

LIN

Set →
→ Query

Description	Set and read the linear current.
Syntax	[PRESet:]LIN:A B{SP}{NR2}{: NL}
Query Syntax	[PRESet:]LIN:A B{?}{: NL}

ON:ANG

Set →
→ Query

Description	Set and Read the loading angle control. The full range of 0-359 degree.
Syntax	[PRESet:]ON:ANG {SP}{NR2}{: NL}
Query Syntax	[PRESet:]ON:ANG{?}{: NL}
Parameter	<NR1> 0~359

OFF:ANG

Set →
→ Query

Description	Set and Read the unloading angle control. The full range of 0-359 degree.
-------------	---

Syntax	[PRESet:]OFF:ANG {SP}{NR2}{; NL}
--------	----------------------------------

Query Syntax	[PRESet:]OFF: ANG{?}{; NL}
--------------	----------------------------

Parameter	<NR1>
-----------	-------

	0~359
--	-------

CC|CURR:A|B

Description	Set and read the current of A or B. This command is for setting the required Load current. And this command must be followed the next notices: Level A load and Level B load current settings are independent. The unit is A.
-------------	---

Syntax	[PRESet:]CC CURR:{A B}{SP}{NR2}{; NL}
--------	---------------------------------------

Query Syntax	[PRESet:]CC CURR:{A B}{?}{; NL}
--------------	---------------------------------

CP:A|B

Description	Set and read the value of Watt. This command is for setting the required value of Watt, and the unit is W.
-------------	--

Syntax	[PRESet:]CP:{A B}{SP}{NR2}{; NL}
--------	----------------------------------

Query Syntax	[PRESet:]CP:{A B}{?}{; NL}
--------------	----------------------------

CR|RES:A|B

Description	Set and read the value of Resistance. This command is used for setting the required value of Load Resistance. And this command must be followed the next notices: Level A load and Level B load resistance settings are independent. The unit is Ω .
-------------	---

Syntax	[PRESet:]CR RES:{A B}{SP}{NR2}{; NL}
--------	--------------------------------------

Query Syntax	[PRESet:]CR RES:{A B}{?}{; NL}
--------------	--------------------------------

CV|VOLT:A|B

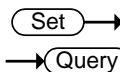

Description	Set and read the value of voltage. This command is for setting the required value of voltage, and the unit is V.
Syntax	[PRESet:]CV:{A B}{SP}{NR2}{:}; NL} [PRESet:]VOLT:{A B}{SP}{NR2}{:}; NL}
Query Syntax	[PRESet:]CV:{A B}{?}{:};NL} [PRESet:]VOLT:{A B}{?}{:};NL}

CVI|VOLT:A|B

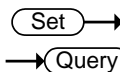

Description	Set and read the value of voltage. This command is for setting the required value of voltage, and the unit is V.
Syntax	[PRESet:]CVI:{A B}{SP}{NR2}{:}; NL}
Query Syntax	[PRESet:]CVI:{A B}{?}{:};NL}

TCONFIG

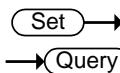

Description Set and read a test Item. There are nine options of this command. Those are NORMAL mode, OCP test, OPP test, SHORT, NLIN, NLCR, FUSE, BATT, TRANS, INRUSH, SURGE test.

Syntax **[PRESet:] TONFIG {NORMAL|OCP|OVP|OPP|SHORT|NLIN|NLCR|FUSE|BATT|TRANS|INRUSH|SURGE}{:};|NL}**

Query Syntax **[PRESet:] TONFIG {?} {:};|NL}**

Parameter	<NR2>	
	1	NORMAL
	2	SHORT
	3	OPP

4	OCP
5	non-LIN
6	nocLIN+CR
7	FUSE
8	BATT
9	Trans
10	INRUSH
11	SURGE

ITIME

Set →

→ Query

Description Set and read the INRUSH current time. Use this command to set the interval for current decrement. The setting range is 0.1ms~100.0ms.

Syntax [PRESet:]TIME{SP}{NR2}{:|NL}

Query Syntax [PRESet:]ITIME{?}

Parameter <NR2>
0.1ms~100.0ms

ISTART

Set →

→ Query

Description Set and read the starting current set point for the inrush current test. The starting current is set to twice the current specification.

Syntax [PRESet:]ISTART{SP}{NR2}{:|NL}

Query Syntax [PRESet:]ISTART{?}

ISTEP

Set →

→ Query

Description Set and read the set value of the decrement current of the inrush current test. The step current is set to twice the current specification.

Syntax **[PRESet:]ISTEP{SP}{NR2}{;|NL}**
 Query Syntax **[PRESet:]ISTEP{?}**

ISTOP

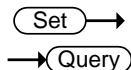

Description Set and read the set value of the minimum current for the inrush current test. Minimum current setting range current specification.

Syntax **[PRESet:]ISTOP{SP}{NR2}{;|NL}**
 Query Syntax **[PRESet:]ISTOP{?}**

SURGE:Tn

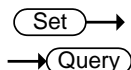

Description Set and read the time setting for the surge current test.
 n: 1~3, the time to load current in three stages. When n=1, 2, the time setting range is 0.01~0.50 seconds. When n=3, the time setting range is 0.01~9.99 seconds or continuous loading.





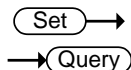



Syntax **[PRESet:]SURGE:Tn{SP}{NR2}{;|NL}**
 Query Syntax **[PRESet:]SURGE:Tn{?}**

SURGE:Sn



Description Set and read the load current value of the surge current test.
 n: 1~3, the load current in three stages. When n=1, 2, the load current setting range is twice the current specification. When n=3, the load current setting range is the current specification.

Syntax **[PRESet:]SURGE:Sn{SP}{NR2}{;|NL}**
 Query Syntax **[PRESet:]SURGE:Sn{?}**

		
OCP:START		
Description	Set and read the initial value of OCP test. This command is used for setting the required initial value (I-START) of OCP	
Syntax	[PRESet:]OCP:START{SP}{NR2}{:} NL}	
Query Syntax	[PRESet:]OCP:START{?}{:} NL}	
		
OCP:STEP		
Description	Set and read the increasing value of OCP test. This command is used for setting the increasing value (I-STEP) of OCP test.	
Syntax	[PRESet:]OCP:STEP{SP}{NR2}{:} NL}	
Query Syntax	[PRESet:]OCP:STEP{?}{:} NL}	
		
OCP:STOP		
Description	Set and read the maximum value of OCP test. This command is used for setting the maximum value (I-STOP) of OCP	
Syntax	[PRESet:]OCP:STOP{SP}{NR2}{:} NL}	
Query Syntax	[PRESet:]OCP:STOEP{?}{:} NL}	
		
VTH		
Description	Set and read the value of the threshold voltage. This command is used for setting the Threshold Voltage. That is the OCP/OPP of this Load model when the output voltage of appliance is lower or equaled to the VTH.	
Syntax	[PRESet:]VTH{SP}{NR2}{:} NL}	
Query Syntax	[PRESet:]VTH{?}{:} NL}	

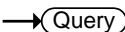
		 
<hr/>		
OPP:START		
Description	Set and read the initial value of OPP test. This command is used for setting the required initial value (P-START) of OPP	
Syntax	[PRESet:]VTH{SP}{NR2}{:}; NL}	
Query Syntax	[PRESet:]VTH?}{:}; NL}	

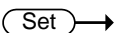
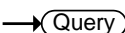
		 
<hr/>		
OPP:START		
Description	Set and read the increasing value of OPP test. This command is used for setting the increasing value (P-STEP) of OPP test.	
Syntax	[PRESet:]OPP:STEP{SP}{NR2}{:}; NL}	
Query Syntax	[PRESet:]OPP:STEP?}{:}; NL}	

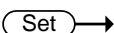
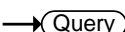
		 
<hr/>		
OPP:STOP		
Description	Set and read the maximum value of OPP test. This command is used for setting the maximum value (P-STOP) of OCP	
Syntax	[PRESet:]OPP:STOP{SP}{NR2}{:}; NL}	
Query Syntax	[PRESet:]OPP:STOEP?}{:}; NL}	

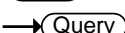
		 
<hr/>		
STIME		
Description	Set and read time of the short-circuit test. This command is used for setting time of the short-circuit test. If time set to 0, it means that have no the time limit and continue to be short -circuited. The unit is milli-second (ms)	
Syntax	[PRESet:]STIME{SP}{NR2}{:}; NL}	
Query Syntax	[PRESet:]STIME?}{:}; NL}	

Set →
 → Query

PF

Description Set and read power factor. This command is set Power factor, the setting range is 0.01 ~ 1.00.

Syntax [PRESet:]PF{SP}{+|-}{NR2}{:};|NL}

Query Syntax [PRESet:]PF{?}{:};|NL}

Set →
 → Query

CF

Description Set and read crest factor. This command is set crest factor, the setting range is 1.4142~5.0.

Syntax [PRESet:]CF{SP}{NR2}{:};|NL}

Query Syntax [PRESet:]CF{?}{:};|NL}

Set →
 → Query

BATT:MODE

Description Set and read the Battery test mode. This command is set and read the Battery test mode.

Syntax [PRESet:]BATT:MODE{SP}{CC|CR|CV|CP|LIN}{:};|NL}

Query Syntax [PRESet:]BATT:MODE{?}{:};|NL}

Parameter	<NR2>	
	0	CC
	1	LIN
	2	CR
	3	CP

Set →
 → Query

BATT:TIME

Description Set and read the battery test time. This command is set and read the battery test time, the setting range is 1s~99999s.

Syntax **[PRESet:]BATT:TIME{SP}{NR1}{:|NL}**
 Query Syntax **[PRESet:]BATT:TIME{?}{:|NL}**

DISC:TIME → **Query**

Description Read the battery discharge time. This command is when the test end, read the battery discharge time, the Range of 1s ~ 99999s.

Query Syntax **[PRESet:]DISC:TIME{?}{:|NL}**

DISC:AH → **Query**

Description Read the battery capacity. This command is when the test end, read the battery capacity.

Query Syntax **[PRESet:]DISC:AH{?}{:|NL}**

EXTIN:ON/OFF*(This function is optional)
Set →
 → Query

Description Set the external input signal. This command is to set EXTIN ON or OFF.

Query Syntax **[PRESet:]EXTIN:{SP} ON|OFF}{:|NL}**
[PRESet:]EXTIN{?}{:|NL}

TURBO:{SP}{ON|OFF}
Set →
 → Query

Description Set and read the TURBO mode can be set to ON or OFF. In TURBO mode, output double maximum rated current in short time.

Syntax **[PRESet:]TURBO{ON|OFF}{:|NL}**
 Query Syntax **[PRESet:]TURBO{?}{:|NL}**

Parameter	<NR2>	
	0	OFF
	1	ON

		Set →
		→ Query
<hr/>		
FUSE:CC		
Description	Set and read fuse test current value. This command is to set or read the fuse test current value, In normal mode The range is 0 ~ 75A, In TURBO mode the range is 0 ~ 150A.	
Syntax	[PRESet:]FUSE:CC{SP}{NR2}{:}; NL}	
Query Syntax	[PRESet:]FUSE:CC(?){:}; NL}	
<hr/>		
		Set →
		→ Query
<hr/>		
FUSE:TIME		
Description	Set and read fuse test time. This command is to set or read the fuse test time, the setting range is 0.1s ~ 9999.9s.	
Syntax	[PRESet:]FUSE:TIME{SP}{NR2}{:}; NL}	
Query Syntax	[PRESet:]FUSE:TIME(?){:}; NL}	
<hr/>		
		Set →
		→ Query
<hr/>		
FUSE:TYPE		
Description	Set and read fuse type. This command is to set or read fuse TRIP or NTRIP.	
Syntax	[PRESet:]FUSE:TYPE{SP}{TRIP NTRIP}{:}; NL}	
Query Syntax	[PRESet:]FUSE:TYPE(?){:}; NL}	
Parameter	<NR2>	
	0	TRIP
	1	NTRIP
<hr/>		
		Set →
		→ Query
<hr/>		
FUSE:REP		
Description	Set and read the fuse repeat tests number of times. The setting range is 0 ~ 255 times.	

Syntax **[PRESet:]FUSE:REP{SP}{NR1}{;|NL}**
 Query Syntax **[PRESet:]FUSE:REP?{;|NL}**

TRIP:TIME → **Query**

Description Read the fuse fusing time. This command is when the test end, read the fuse fusing time.

Query Syntax **[PRESet:]TRIP:TIME?{;|NL}**

TRANS:TIME → **Query**

Description Read UPS Transfer time. This command is when the test end, read the UPS Transfer time.

Query Syntax **[PRESet:]TRANS:TIME?{;|NL}**

AVG
Set →
 → Query

Description Set and read back the average 1, 2, 4, 8, and 16. Set and read back the average 1, 2, 4, 8, and 16, the default is 1 without Averaging.

Syntax **[PRESet:]AVG{SP}{NR2}{;|NL}**

Query Syntax **[PRESet:]AVG?{; |NL}**

Parameter **<NR2>**

- 1
- 2
- 4
- 8
- 16

CPRSP
Set →
 → Query

Description Set and read back the CPRSP 0~7. The default is 0.

Syntax	[PRESet:]CPRSP{SP}{NR2}{; NL}
Query Syntax	[PRESet:]CPRSP?{; NL}
Parameter	<NR2>
	0~7

CYCLE

Set →

→ Query

Description Set and read back the CYCLE. It can be set from 1 to 16. Default setting set is 8. That is 8 weeks to do the meter value processing.

Syntax	[PRESet:]CYCLE{SP}{NR2}{; NL}
Query Syntax	[PRESet:]CYCLE?{; NL}
Parameter	<NR2>
	1~16

BW

Set →

→ Query

Description Set and read the bandwidth from 0 to 15 band width, 15 is the fastest, and the initial Value is 13.

Syntax	[PRESet:]BW{SP}{NR2}{; NL}
Query Syntax	[PRESet:]BW?{; NL}

FREQ

Set →

→ Query

Description Set and read the frequency ,range from 40 to 440 Hz.

Syntax	[PRESet:]FREQ{SP}{AUTO NR2}{; NL}
Query Syntax	[PRESet:]FREQ?{; NL}
Parameter	<NR2>
	0,40~440Hz

REP:COUNT

→ Query

Description	Read the number of repeated tests.
-------------	------------------------------------

Query Syntax	[PRESet:]REP: COUNT? {; NL}
--------------	-----------------------------

Limit Commands

Set and read the top and bottom of the Load judgment NG limit

[LIMit:]CURRent:{HIGH|LOW} or IH|IL (Set) →
→ (Query)

Description This command is to set the lower limit value of threshold current. When load sink current is lower than this lower limit value or higher than the upper limit value, NG indicating light will come on to indicate "NO GOOD".

Syntax [LIMit:]CURRent:{HIGH|LOW}{SP}{NR2 }{;|NL}
[IH|IL]{SP}{NR2}{;|NL}

Query Syntax [LIMit:]CURRent:{HIGH|LOW}{?}{;|NL}
[IH|IL] ?{;|NL}

[LIMit:]POWer:{HIGH|LOW} or WH|WL (Set) →
→ (Query)

Description This command is to set the upper/lower limit value of threshold power (WATT). When power (WATT) is lower than this lower limit value or higher than the upper limit value, NG indicating light will come on to indicate "NO GOOD"

Syntax [LIMit:]POWer:{HIGH|LOW}{SP}{NR2 }{;|NL}
[WH|WL]{SP}{NR2}{;|NL}

Query Syntax [LIMit:]POWer:{HIGH|LOW}{?}{;|NL}
[WH|WL] ?{;|NL}

[LIMit:]VOLTage:{HIGH|LOW} or VH|VL

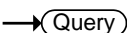

Description This command is to set the upper/lower limit value of threshold voltage. When input voltage is lower than the lower limit value or higher than the upper limit value, NG indicating light will come on to indicate "NO GOOD".

Syntax [LIMit:]VOLTage:{HIGH|LOW}{SP}{NR2 }{;|NL}
 [VH|VL]{SP}{NR2}{;|NL}

Query Syntax [LIMit:]VOLTage:{HIGH|LOW}{?}{;|NL}
 [VH|VL] ?{;|NL}

SVH|SVL



Description This command is to set the upper/lower limit value of short current. When short current is lower than the lower limit value or higher than the upper limit value, NG indicating light will come on to indicate "NO GOOD".

Syntax [LIMit:]{SVH|SVL}{SP}{NR2 }{;|NL}

Query Syntax [LIMit:]{SVH|SVL}{?}{;|NL}

STATE commands

Set and read the status of Load

[STATe:]LOAD{SP}{ON|OFF}
 →
 →

Description Set and read the status of Sink Current or not. This command is used for setting the status of Sink Current. When setting it to ON, the Load is going to sink current from appliance. When setting it to OFF, the Load would not act.

Syntax [STATe:]LOAD{SP}{ON|OFF}{:|NL}

Query Syntax [STATe:]LOAD?{:|NL}

Parameter	0	OFF
	1	ON

[STATe:]MODE{SP}{CC|CR|CV|CP}
 →
 →

Description Set and read the mode of LOAD. Load is acting under these four modes as the following table. When reading the Loading Operation mode, the return value 0 | 1 | 2 | 3 | 4 are meant to be CC | LIN | CR | CV | CP

Syntax [STATe:]MODE{SP}{CC|CR|CV|CP}{:|NL}

Query Syntax [STATe:]MODE?{:|NL}

Module for each series	Model	CC	LIN	CR	CV	CP
	(Value)	0	1	2	3	4
	AEL-5002-350-18.75	V	V	V	V	V
	AEL-5003-350-28	V	V	V	V	V
	AEL-5004-350-37.5	V	V	V	V	V
	AEL-5006-350-56	V	V	V	V	V
	AEL-5008-350-75	V	V	V	V	V
	AEL-5012-350-112.5	V	V	V	V	V
	AEL-5015-350-112.5	V	V	V	V	V
	AEL-5019-350-112.5	V	V	V	V	V
	AEL-5023-350-112.5	V	V	V	V	V
	AEL-5002-425-18.75	V	V	V	V	V
	AEL-5003-425-28	V	V	V	V	V
	AEL-5004-425-37.5	V	V	V	V	V
	AEL-5006-425-56	V	V	V	V	V
	AEL-5008-425-112.5	V	V	V	V	V
	AEL-5012-425-112.5	V	V	V	V	V
	AEL-5015-425-112.5	V	V	V	V	V
	AEL-5019-425-112.5	V	V	V	V	V
	AEL-5023-425-112.5	V	V	V	V	V
	AEL-5003-480-18.75	V	V	V	V	V
	AEL-5004-480-28	V	V	V	V	V

[STATe:]PRESet{SP}{ON|OFF}



Description Set the left or right digit multi-function meter to display the programming load level. This command is for select the left 5 digit LCD display to show current setting or DWM.

Pres ON: To select the LCD display to shows current setting.

Pres OFF: To select the LCD Display is "DWM"

Syntax [STATe:]PRESet{SP}{ON|OFF}{:};|NL}

Query Syntax [STATe:]PRESet{?}{:};|NL}

Parameter 0 OFF

1 ON

[STATe:]SENSE{SP}{ON|OFF}



Description Set and read the Load voltage to read whether is carried by the VSENSE or not. This command is for setting the Load voltage to read whether is carried by VSENSE or INPUT Connector. When setting for ON, the voltage is got from VSENSE, and setting for OFF, the voltage is got from INPUT Connector.

Syntax	[STATe:]SENSE{SP}{ON OFF }{; NL}	
Query Syntax	[STATe:]SENSE{?}{; NL}	
Parameter	0	OFF
	1	ON

[STATe:]LEVEl{SP}{A|B} or LEV{SP}{A|B}



Description Set and read the A and B of Load. LEV LOW is a low level value of current on CC mode. It is a low level value of resistance on CR mode. It is a low level value of voltage on CV mode. It is a low level value of power on CP mode.

Syntax	[STATe:]LEVEl{SP}{A B }{; NL}	
	[STATe:]LEV{SP}{A B}{; NL}	
Query Syntax	[STATe:]LEVEl{?}{; NL}	
	[STATe:]LEV{?}{; NL}	
Parameter	0	A
	1	B

[STATe:]CLRerr (Set) →

Description Clear the error flag of AEL-5000 Series which during the period of working. This command is for clearing the contents in the register of PROT and ERR. After implementation, the contents of these two registers will be "0".

Syntax **[STATe:]CLRerr{;|NL}**

[STATe:]CLR:Meter (Set) →

Description Clear the meter record value. Clear the maximum and minimum recorded values of the RMS measured by the meter.

Syntax **[STATe:]CLR:Meter{;|NL}**

[STATe:]ERRor → (Query)

Description Read status register value. This command is to confirm the load status.

Query Syntax **[STATe:]ERRor{?}{;|NL}**

[STATe:]NG? → (Query)

Description Query if there have NG flag in this AEL-5000 Series. Set command NG? To show the NG status. Set for "0" the LCD of NG (NO GOOD) will be put out. Set "1", the LCD will be lit.

Query Syntax **[STATe:]NG{?}{;|NL} PROTECT?**

Return Parameter	0	GO
	1	NG

[STATe:]PROTe:? →(Query)

Description Query if there have protection flag which had been set in this AEL-5000 series. PROT? Means the status of Protection of AEL-5008-350-75. "1" means OPP occurred."4" means OVP. "8" means OCP. Table below shows the corresponding number of protection status use command CLR to clear the register of PROT status to be "0"

Query Syntax **[STATe:]PROTe{?} {;|NL}**

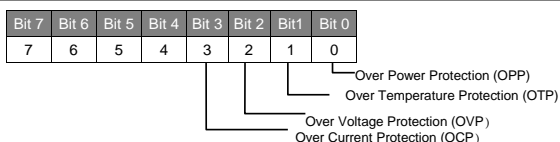

Register of PROT status	BIT ID	BIT VALUE	REMARK
	bit 0	0 = Off, 1 = Triggered	Over Power Protection (OPP)
	bit 1	0 = Off, 1 = Triggered	Over Temperature Protection (OTP)
	bit 2	0 = Off, 1 = Triggered	Over Voltage Protection (OVP)
	bit 3	0 = Off, 1 = Triggered	Over Current Protection (OCP)

[STATe:]NGEABLE {ON|OFF} (Set) →

Description Set the GO/NG check function enable or disable. To set the function of NG judgment opens when POWER ON. When setting for POWER OFF, the function of NG judgment will not be implemented.

Syntax **[STATe:]NGEABLE{ON|OFF} {;|NL}**

[STATe:]START (Set) →

Description Set for load to implement the test, and according to TEST CONFIG (TCONFIG), the Load will start to test the items and parameters which are required

Syntax **[STATe:]START{;|NL}**

[STATe:]STOP Set →

Description Set for load to stop the test

Syntax **[STATe:]STOP{;|NL}**

[STATe:]TESTING? Set →

Description Check whether the current electronic load is in the test state, 1: testing 0: test end.

Syntax **[STATe:]TESTING{?}{;|NL}**

Return Parameter	0	Test END
	1	Testing

Example
 START
 TESTING?
 NG?
 STOP

[STATe:]SYNCronize Set →
→ Query

Description Electronic load sync signal. 1: SYNC ON 0: SYNC OFF.

Syntax **[STATe:]SYNCronize{SP}{ON|OFF}{;|NL}**

Query Syntax **[STATe:]SYNCronize{?}{;|NL}**

Return Parameter	0	OFF
	1	ON

System Commands

Set and Read the Status of AEL-5000 series

[SYStem:]RECall{SP}m{n}

Set →

Description Recall the status of loading which had been saved in the Memory. This command is for recalling the status of Load which had been saved in the Memory. m(STATE)=1~150.

Syntax [SYStem:]RECall{SP}m{n}

Example **RECALL 2**

Recall the status of Loading which had been saved in the 2nd of the memory

[SYStem:]STORe{SP}m{n}

Set →

Description Save the status of Loading to the Memory. This command is for saving the status of Loading to the Memory. m(STATE)=1~150

Syntax [SYStem:] STORe{SP}m{n}

Example **STORE 2**

Save the status of loading which had been saved in the 2nd of memory.

[SYStem:]NAME?

→ **Query**

Description Read the model number of Load. This command is for reading the model number of Load. If no module is operating, the display will be lit "NULL", or it will be lit the model number

Model
(Value)
AEL-5002-350-18.75
AEL-5003-350-28
AEL-5004-350-37.5
AEL-5006-350-56
AEL-5008-350-75
AEL-5012-350-112.5
AEL-5015-350-112.5
AEL-5019-350-112.5
AEL-5023-350-112.5
AEL-5002-425-18.75
AEL-5003-425-28
AEL-5004-425-37.5
AEL-5006-425-56
AEL-5008-425-75
AEL-5012-425-112.5
AEL-5015-425-112.5
AEL-5019-425-112.5
AEL-5023-425-112.5
AEL-5003-480-18.75
AEL-5004-480-28

Query Syntax **[SYStem:]NAME{?}{;|NL}**

[SYStem:]REMOTE

Set →

Description Command to enter the REMOTE status (only for RS232). This command is for controlling the RS232

Syntax **[SYStem:]REMOTE{;|NL}**

[SYStem:]LOCAL**Set** →

Description	Command to exit the REMOTE status (only for RS232). This command is for finishing the RS232
Syntax	[SYStem:]LOCAL{; NL}

Measure Commands

Measure the actual current and voltage value of Load

MEASure:CURRent?

→ Query

Description Read the current which is loading of Load. Read the five numbers of current meters, and the unit is Ampere (A)

Query Syntax **MEASure:CURRent{?};|NL}**

MEASure:VOLTage?

→ Query

Description Read the voltage which is loading of Load. Read the five numbers of current meters, and the unit is Voltage (V)

Query Syntax **MEASure:VOLTage{?};|NL}**

MEASure:POWer?

→ Query

Description Read the power which is loading of Load. Read the five numbers of current meters, and the unit is Watt (W)

Query Syntax **MEASure:POWer{?};|NL}**

MEASure:VAR?

→ Query

Description Read the reactive power which is loading of Load, Unit is Var.

Query Syntax **MEASure:VAR{?};|NL}**

MEASure:VA? → Query

Description Read the apparent power which is loading of load.
Unit is VA

Query Syntax **MEASure:VA{?}{;|NL}**

MEASure:V_THD? → Query

Description Read the voltage harmonic distortion of the Load.

Query Syntax **MEASure:V_HD{?}{;|NL}**

MEASure:I_THD? → Query

Description Read the current harmonic distortion of the Load.

Query Syntax **MEASure:I_HD{?}{;|NL}**

MEASure:V_HARM? → Query

Description Read the voltage harmonic distortion order of the load.

Query Syntax **MEASure:V_HARM{?}{;|NL}**

MEASure:I_HARM? → Query

Description Read the current harmonic distortion order of the Load.

Query Syntax **MEASure:I_HARM{?}{;|NL}**

A APPLICATION

This chapter details the basic operating modes along with some common applications in which the AEL-5000 series Electronic Load is used.

Local sense connections	179
Remote sense connections	181
Constant Current mode and LIN mode application	183
Constant Resistance mode application	185
Constant Voltage mode application	187
Constant Power mode application	189
Battery discharge test application	191
Current protection component test.....	194
AC rectified load simulation.....	197
Parallel operation	198
Inrush Current	200
Power Supply OCP testing	203
Power Supply OPP testing	205
SHORT testing.....	207
BW Setting.....	209
Special waveform applications	210

Local sense connections

Background

Local sensing is used in applications where the lead lengths are relatively short, or where load regulation is not critical. When connected in local sense mode the 5 digit voltage meter of the AEL-5000 Series Electronic load measures the voltage at its DC input terminals. The connecting leads between the DUT and the Electronic Load should be bundled or tie wrapped together to minimize inductance.

The diagram below illustrates a typical set up with the electronic load connected to the DC power supply.

Local voltage sense connections

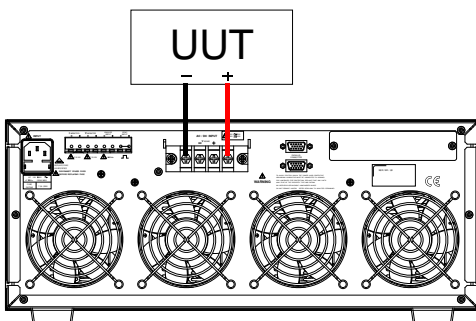

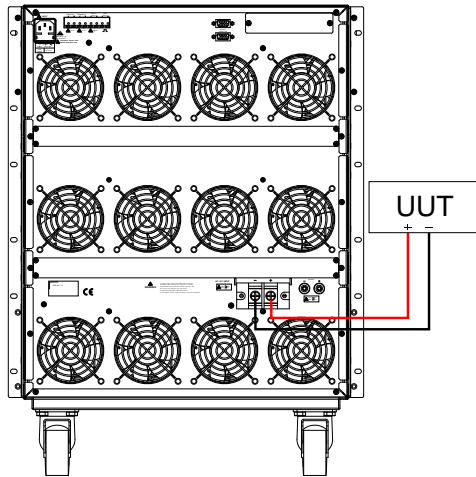

Remote sense connections

Background

Remote sensing compensates for the voltage drop in applications that require long lead lengths. It is useful under low voltage high current conditions. The remote voltage sense terminals (V_{s+}) and (V_{s-}) of the load are connected to (+) and (-) output of the AC/DC Source. Be sure to observe the correct polarity or damage may occur. The power and sense cables should be bundled or tie wrapped together to minimize inductance.

The diagram below illustrates a typical set up with the electronic load connected for remote sense operation.

If V-sense is set to 'ON' and the sense terminals are connected to the DUT the load will check and compensate for all voltage drops. The maximum voltage sense compensation is the same as the rating of the AEL-5008-350-75.

Remote voltage sense connections

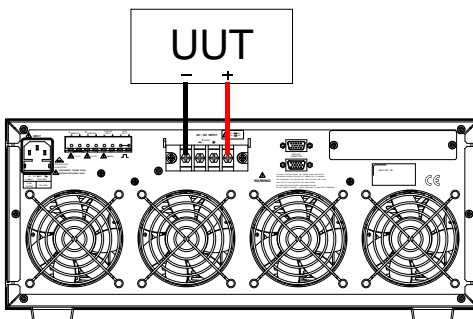

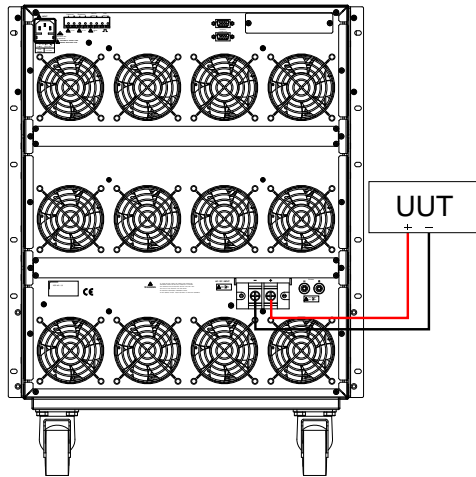

Constant Current mode and LIN mode application

Background

The Constant Current (CC) mode is ideal for testing the Load Regulation, Cross Regulation, Output Voltage and Dynamic Regulation of the power supply under test. The CC mode can also be used to test the Discharge Characteristics and the Life Cycle of cells and battery packs. In CC operation the AEL-5000 Series can operate as a static load with switchable high and low current levels. It is also possible to operate the load dynamically enabling the user to adjust sink current with time.

During Linear C.C. mode, the load current input into AEL-5000 Series High Power Electronic Load depends on the current setting regardless of the input voltage, e.g., the current setting remains unchanged. The load input current signal will follow input voltage signal that is useful for step wave-form and square wave-form device.

The LIN mode is within a AGC circuit and the control signal will response with input voltage. We call it LIN mode.

The AGC circuit produces a constant amplitude output signal so long as the amplitude of the input signal exceeds an adjustable reference voltage applied to the peak detector. The reference voltage may be changed to change the range of input voltage resulting in a constant-amplitude output.

The AGC circuit responds almost instantly to control a sudden increase in input voltage.

The AGC circuit is especially suitable for Step waveform, Square waveform and the input

voltage with distortion waveform.

Constant current
and mode
application

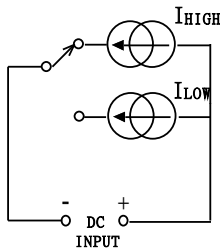
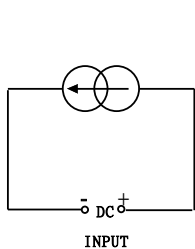
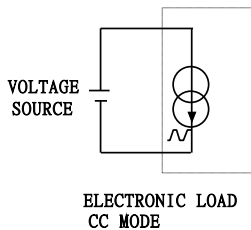
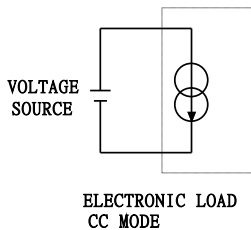

Constant Resistance mode application

Operating in Constant Resistance mode is useful for testing both voltage and current sources. The CR mode is particularly suited for the “soft start” of power supplies. This is explained in more detail below.

Power supply
power up
sequence

Power supply power up sequence
In constant current mode the demand at initial “Load ON” of the preset current value is almost instantaneous. This might cause the Device under Test (DUT) problems meeting the relatively high current demand at initial switch on.

Example

A 5V/50A output power supply may not be able to deliver 50A over its entire start-up range of 0-5 volts. In many cases the power supply’s short circuit or over current protection circuit cause the power supply to shut down. This is because the power supply is trying to deliver the 50A at a voltage level that is too low.

The answer to this problem is not to use CC mode but to use CR mode instead. This is because in CR mode the current and voltage ramp up together providing a ‘soft start’ when compared to standard CC mode.

However please note that with the AEL-5000 Series of Electronic Loads an adjustable current ramp can be set. This feature is found within the dynamic settings as RISE slew rate. Even in static mode the AEL-5000 Series load will regulate its current demand at ‘Load ON’ in line with the adjusted RISE slew rate. The FALL slew rate also in the dynamic settings allows the current ramp down to be controlled at ‘Load OFF’.

Constant
Resistance mode
Application

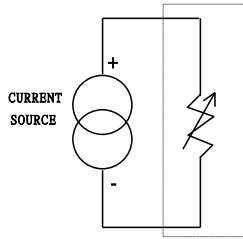

ELECTRONIC LLOAD
CR MODE

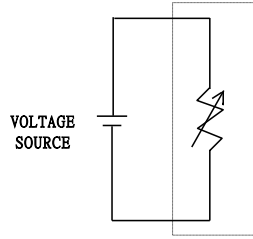

ELECTRONIC LLOAD
CR MODE

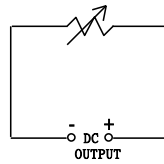
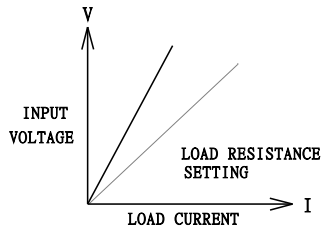

Constant Voltage mode application

In Constant Voltage (CV) operation the load will attempt to sink as much current as required in order to reach the set voltage value. CV operation is useful in checking the load regulation of dc current sources. The CV mode is also ideal for characterizing the current limit of dc power supplies. These application areas are explained a little more below.

Current source testing

- A common application for a dc current source is as a battery charger. Most battery chargers are designed to automatically adjust their charging current according to the battery voltage. In CV mode the electronic load will sink the current that is needed to reach the desired voltage. The CV mode is therefore ideal for checking the charge current at a particular voltage level.

If the battery charger is tested at a number of different voltage levels in CV mode a current curve can be recorded. Thus the battery charger's load regulation can be checked during development, production and batch testing.

Power supply current limit characterization

- The current limit is a necessary function for power supplies. The fold back current limit curve is very common for fixed output switching power supplies. The constant current limit curve is more popular for adjustable laboratory power supplies.
-

It is very difficult or impossible to find the current limit curve by CC or CR mode. However it becomes simple by using CV mode. The user sets the CV voltage and Records the output current. Plotting the current measurements against the voltage Settings result in the output current limit curve of a power supply.

Constant Voltage mode application

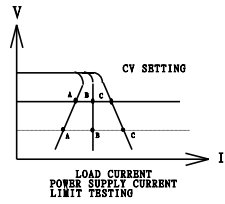
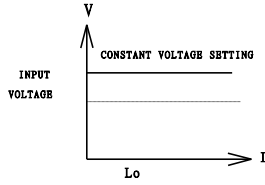
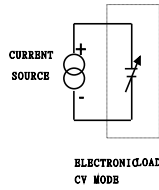
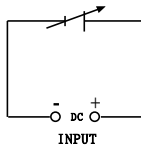

Constant Power mode application

Battery Evaluation Primary or secondary batteries are the power source for a wide range of portable electronics products, such as notebook computers, video cameras and mobile phones. To ensure long usage times and customer satisfaction the battery pack should be able to provide a constant power for the longest time possible.

It can be measured that the output voltage of a battery will drop over time (Fig a). The rate of voltage decay depends on a number of factors including duty cycle, chemistry type, battery age and ambient temperature.

So to keep the device powered for the longest possible time the battery must be able to provide a stable power output regardless of output voltage (Fig c). In order to maintain a constant power the output current will need to increase over time to compensate for the reducing voltage (Fig b).

Operating the AEL-5000 Series electronic load in CP mode is ideal for testing the characteristics of a battery. This is because as the battery voltage drops the load current will automatically increase in order to keep the CP setting. By logging sink values against time the test engineer can also measure the battery's energy capacity at various discharge rates.

The AEL-5000 Series also features an adjustable Load OFF setting. This allows a voltage level to be set so that the electronic load automatically stops sinking power upon reaching this preset voltage. This can be used to ensure the battery is not subjected to a damaging deep discharge.

Along with static operation the load can also be operated dynamically in CP mode. The dynamic

functions allow the ramp, fall and plateau times to be adjusted between 2 levels of power. This capability means that 'real world' loads can be more accurately simulated. For example the dynamic mode could be used to test the performance of a battery that is required to provide power pulses to transmit data from a radio frequency terminal.

Constant power mode application

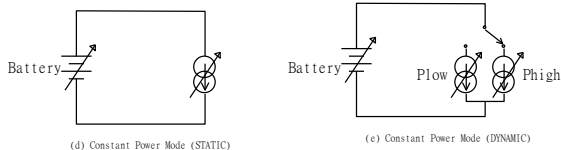
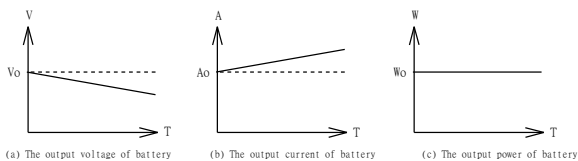

Battery discharge test application

The AEL-5000 Series AC & DC electronic load has built-in new TYPE1 ~ TYPE3 battery discharge test, you can select the desired battery test mode, the test results can be directly displayed on the LCD display for battery AH capacity, the voltage value after discharge and the cumulative discharge time.

Constant Current Discharge Test 1. Set mode is constant current



2. Set discharge current



3. Set the crest factor.

This function is only used when testing UPS discharge. When testing the battery discharge is no CF function.



4. Set the Phase Lead or lag.

This function is only used when testing UPS discharge. When testing the battery discharge is no Phase Lead or lag function.



5. Set the Phase angle.

This function is only used when testing UPS discharge. When testing the battery discharge is no Phase angle function.

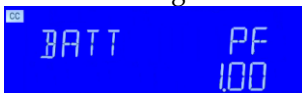

6. Set the discharge time.



7. Set the UVP Voltage.



CC+UVP Battery discharge mode Type 1

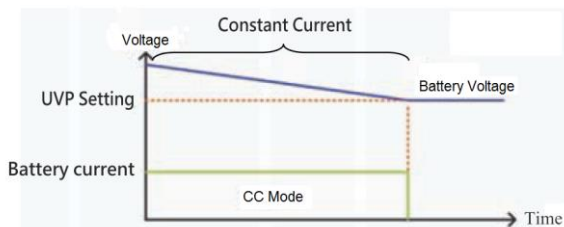

Constant Power Discharge Test

1. Set mode is constant power.



2. Set the discharge power.



3. Set the crest factor.

This function is only used when testing UPS discharge. When testing the battery discharge is no CF function.



4. Set the Phase Lead or lag.

This function is only used when testing UPS discharge. When testing the battery discharge is no Phase Lead or lag function.



5. Set the Phase angle.

This function is only used when testing UPS discharge. When testing the battery discharge is no Phase angle function.



- Set the discharge time.



- Set the UVP Voltage.



CC+UVP Battery discharge mode Type 2

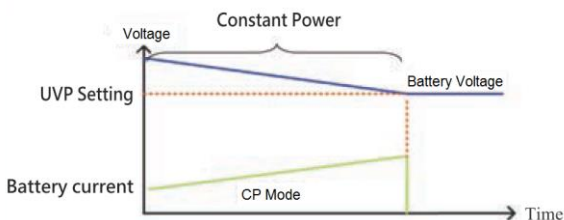

Setting the discharge time Test

- Set the discharge time from 1 to 99999 seconds. When the discharge time reaches the set time, the discharge will automatically stop and the measured battery capacity and voltage will be monitored and displayed.



CC+UVP Battery discharge mode Type 3

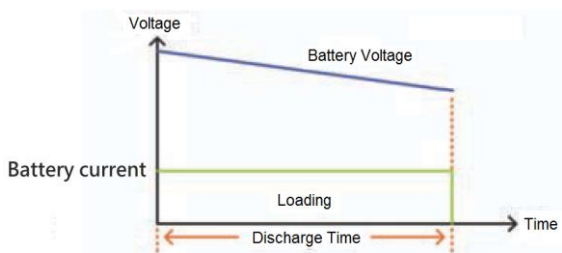

Current protection component test

Background

Current protection component include fuse, circuit breakers and a new PTC resettable fuse etc., its function is when the circuit current exceeds the design of the rated value. That is, if the load exceeds the design of the current capacity, the circuit will be disconnected, in order to avoid overheating, even fire. At the abnormal situation occurs it must be able to provide circuit break protection capability, while within the normal current range it must continue to provide current.



Fuse



Breaker



PTC

MODEL		AEL-5002-350-18.75	AEL-5003-350-28	AEL-5004-350-37.5
Power(W)		1875W	2800W	3750W
Current(Ampere)		18.75Arms/56.25Apek	28Arms/84Apek	37.5 Arms/12.5Apek
Voltage(Volt)		50~350Vrms/500Vdc		
Fuse Test mode				
Max. current	Turbo OFF	18.75Arms	28.0Arms	37.5Arms
	Turbo ON	37.5Arms	56.0Arms	75.0Arms(x2)
Trip & Non-Trip Time	Turbo OFF	0.1~9999.9 sec.		
	Turbo ON	0.1~1.0 sec.		
Meas. Accuracy		0.003 sec.		
Repeat Cycle		0~255		
Short/OPP/OCP Test Function				
Short Time	Turbo OFF	0.1 ~10 sec. or Cont.		
	Turbo ON	0.1~1 sec.		
OPP/OCP Step Time	Turbo OFF	100ms		
	Turbo ON	100ms. Up to 10 Steps		
OCP Istop	Turbo OFF	18.75Arms	28.0Arms	37.5Arms
	Turbo ON	37.5Arms	56.0Arms	75.0Arms
OPP Pstop	Turbo OFF	1875W	2800W	3750W
	Turbo ON	3750W	5600W	7500W



Turbo OFF, Short 100ms 37.5A
Test result screen

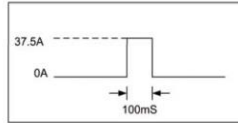

Turbo OFF, Short 100ms 37.5A Setting

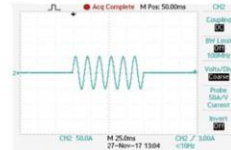

Turbo OFF, Short 100ms 37.5A
The actual test waveform



Turbo ON, Short 100ms 75.0A
Test result screen

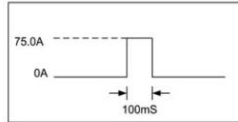

Turbo ON, Short 100ms 75.0A Setting

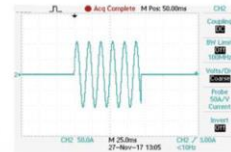

Turbo ON, Short 100ms 75.0A
The actual test waveform

The current protection component has usually a product relationship of current and time. That is, the greater the current through the current protection component, the shorter the reaction time to protect the circuit.

Due to this feature, the AEL-5000 Series AC & DC electronic load, in particular for the verification of current protection components, has developed a Fuse Test function to test and verify such protection element with an electronic load of rated current and power.

Basically, Fuse test has Trip (fuse) and Non-Trip (no fuse) 2 types. Fuse test setting parameters include test current (Istart), test time (Time), test repeat number REPEAT TIME etc.

In the Trip fuse test, it is used to test when the current occurs too large abnormalities must be able to provide the protection of the circuit break that means current protection components need the fuse action, therefore the test current needs to be greater than the fuse current rating.

For the trip test mode of the AEL-5000 Series AC & DC electronic load, the LCD shows the repeat times and the blow time of current protection component after the tested fuse blows. In the Non-Trip fuse test, the current protection component is required to

achieve non-blow action, so the test current needs to be lower than the fuse current rating that is used to verify the fuse must not blow during normal current range. For the Non-trip test mode of the AEL-5000 Series AC & DC electronic load, the LCD display shows Repeat number information after the tested fuse does not blow.



Turbo : OFF, Fuse mode
Test result screen

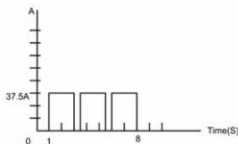

Setting : Turbo : OFF, Fuse ON
CC pulse 37.5A, 2S, Test 3 cycles

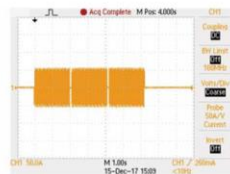

Turbo : OFF, Fuse ON, CC pulse 37.5A, 2S,
Test 3 cycles the actual test waveform



Turbo ON, Fuse mode
Test result screen

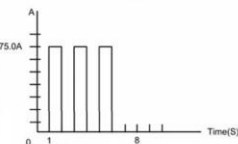

Setting : Turbo : ON, Fuse ON
CC pulse 75.0A, 1S, Test 3 cycles

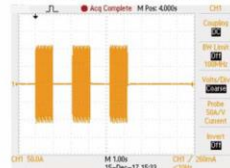

Turbo : ON, Fuse ON, CC pulse 75A, 1S,
Test 3 cycles the actual test waveform

AC rectified load simulation

Background

The AEL-5000 series AC/DC electronic load AC rectified load mode is fully compliance with the IEC test specification requirements for the UPS, IEC 62040-3 UPS Efficiency Measurement Non-linear and IEC 61683 Resistive Plus Non-Linear, respectively, AEL-5000 series AC rectifier load mode is used CC + CR load mode and maintain current THD at 80%, to simulate the actual electronic device which is connecting the UPS. (IEC62040-3 UPS Efficiency Measurement non-Linear and IEC61683 Resistive Plus Non-linear)

AC rectified load mode

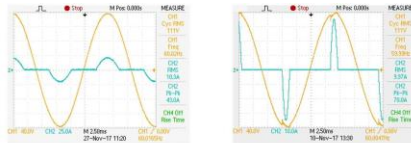
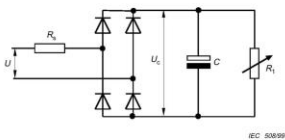

UPS test Non-Linear CC mode

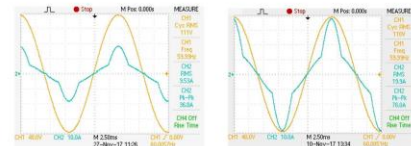

110V, 5A + 220hm Test Waveform 110V, 10A + 110hm Test Waveform
PV Inverter test Non-Linear CC + Resistive mode(CC+CR)

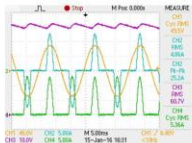

V/A Waveform

Parallel operation

Background

It is possible to operate load in parallel if the power and/or current capability of a single AEL-5000 series load is not sufficient.

The positive and negative outputs of the power supply are connected individually to each load module as shown in the Fig below. The setting is made at each individual load module. The total load current is the sum of the load currents being taken by each load.

While in static mode the load modules can be set to operate in CC, CR or CP. When using multiple loads to sink power from a single DC Source it is not permissible to operate in dynamic mode.

AEL-5000 Series load parallel operation

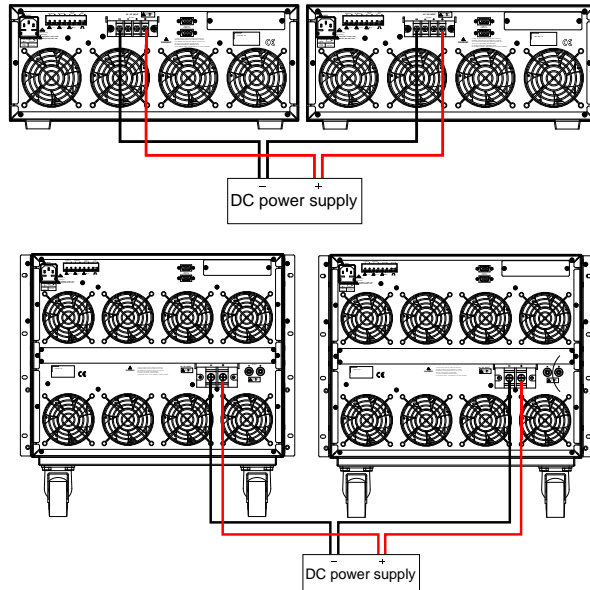

Note

- The electronic load only may carry on the parallel operation under the fixed electric current pattern.
- The electronic load do not use under series connection.

Inrush Current

Supporting the capacitive load of the power supply at startup and the sudden load access test during operation to verify the current when the appliance is turned on and when the appliance is suddenly connected, Is the Inverter output voltage transient response stable, as shown in figure a and b.

Fig. a Inrush Current test at power on

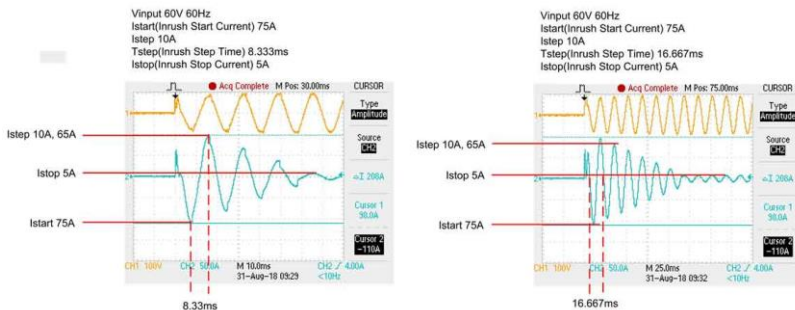
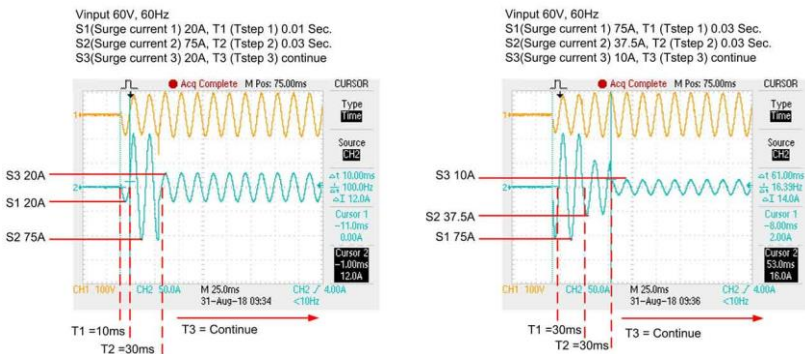

Fig. b Surge Current test when the appliance is connected



MODEL	AEL-5002-350-18.75	AEL-5003-350-28	AEL-5004-350-37.5
Programmable Inrush current simulation: Istart - Istop / Tsep			
Istart, Inrush Start Current	0~37.5A	0~56A	0~75A
Inrush Step time	0.1mS~100mS		
Istop, Inrush stop current	0~18.75A	0~28A	0~37.5A
Programmable Surge current simulation: S1/T1 - S2/T2 - S3/T3			
S1 and S2 Current	0~37.5A	0~56A	0~75A

T1 and T2 Time	0.01S~0.5Sec.		
S3 Current	0~18.75A	0~28A	0~37.5A
T3 Time	0.01S ~ 9.99Sec. or Cont.		

MODEL	AEL-5002-425-18.75	AEL-5003-425-28	AEL-5004-425-37.5
Programmable Inrush current simulation: Istart - Istop / Tsep			
Istart, Inrush Start Current	0~37.5A	0~56A	0~75A
Inrush Step time	0.1mS~100mS		
Istop, Inrush stop current	0~18.75A	0~28A	0~37.5A
Programmable Surge current simulation: S1/T1 - S2/T2 - S3/T3			
S1 and S2 Current	0~37.5A	0~56A	0~75A
T1 and T2 Time	0.01S~0.5Sec.		
S3 Current	0~18.75A	0~28A	0~37.5A
T3 Time	0.01S ~ 9.99Sec. or Cont.		

MODEL	AEL-5006-350-56	AEL-5008-350-75	AEL-5012-350-112.5
Programmable Inrush current simulation: Istart - Istop / Tsep			
Istart, Inrush Start Current	0~112A	0~150A	0~225A
Inrush Step time	0.1mS~100mS		
Istop, Inrush stop current	0~56A	0~75A	0~112.5A
Programmable Surge current simulation: S1/T1 - S2/T2 - S3/T3			
S1 and S2 Current	0~112A	0~150A	0~225A
T1 and T2 Time	0.01S~0.5Sec.		
S3 Current	0~56A	0~75A	0~112.5A
T3 Time	0.01S ~ 9.99Sec. or Cont.		

MODEL	AEL-5015-350-112.5	AEL-5019-350-112.5	AEL-5023-350-112.5
Programmable Inrush current simulation: Istart - Istop / Tsep			
Istart, Inrush Start Current	0~225A	0~225A	0~225A
Inrush Step time	0.1mS~100mS		
Istop, Inrush stop current	0~112.5A	0~112.5A	0~112.5A
Programmable Surge current simulation: S1/T1 - S2/T2 - S3/T3			
S1 and S2 Current	0~225A	0~225A	0~225A
T1 and T2 Time	0.01S~0.5Sec.		
S3 Current	0~112.5A	0~112.5A	0~112.5A
T3 Time	0.01S ~ 9.99Sec. or Cont.		

MODEL	AEL-5006-425-56	AEL-5008-425-75	AEL-5012-425-112.5
Programmable Inrush current simulation: Istart - Istop / Tsep			
Istart, Inrush Start Current	0~112A	0~150A	0~225A
Inrush Step time	0.1mS~100mS		
Istop, Inrush stop current	0~56A	0~75A	0~112.5A
Programmable Surge current simulation: S1/T1 - S2/T2 - S3/T3			
S1 and S2 Current	0~112A	0~150A	0~225A
T1 and T2 Time	0.01S~0.5Sec.		
S3 Current	0~56A	0~75A	0~112.5A

T3 Time	0.01S ~ 9.99Sec. or Cont.
---------	---------------------------

MODEL	AEL-5015-425-112.5	AEL-5019-425-112.5	AEL-5023-425-112.5
Programmable Inrush current simulation: Istart - Istop / Tsep			
Istart, Inrush Start Current	0~225A	0~225A	0~225A
Inrush Step time	0.1mS~100mS		
Istop, Inrush stop current	0~112.5A	0~112.5A	0~112.5A
Programmable Surge current simulation: S1/T1 - S2/T2 - S3/T3			
S1 and S2 Current	0~225A	0~225A	0~225A
T1 and T2 Time	0.01S~0.5Sec.		
S3 Current	0~112.5A	0~112.5A	0~112.5A
T3 Time	0.01S ~ 9.99Sec. or Cont.		

MODEL	AEL-5003-480-18.75	AEL-5004-480-28
Programmable Inrush current simulation: Istart - Istop / Tsep		
Istart, Inrush Start Current	0~37.5A	0~56A
Inrush Step time	0.1mS~100mS	
Istop, Inrush stop current	0~18.75A	0~28A
Programmable Surge current simulation: S1/T1 - S2/T2 - S3/T3		
S1 and S2 Current	0~37.5A	0~56A
T1 and T2 Time	0.01S~0.5Sec.	
S3 Current	0~18.75A	0~28A
T3 Time	0.01S ~ 9.99Sec. or Cont.	

Power Supply OCP testing

OCP Manual control

1. Press Limit Key function to setting I_{Hi} 8A.



2. Press Limit Key function to setting I_{Lo} 0A.



3. Setting OCP test, press OCP key to the next step.

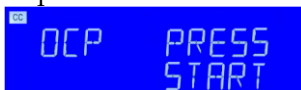

4. Setting start load current 0A, press OCP key to the next step.



5. Setting step load current 0.01A, press OCP key to the next step.

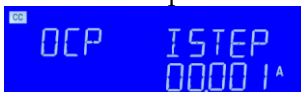

6. Setting stop load current 5A, press OCP key to the next step.

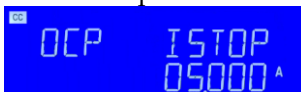

7. Setting OCP V_{TH} 5.00V, press OCP key to the next step.



8. Press START/STOP test key.
-



9. The UUT's output voltage drop-out lower than the threshold voltage (V-th setting), and the OCP trip point is between I_Hi and I_Lo limitation, then right upper 5 digits LCD display will shows "PASS", otherwise shows "FAIL".



OCP Remote control	REMOTE	(Set Remote)
	TCONFIG OCP	(Set OCP test)
	OCP:START 0.1	(Set start load current 0.1A)
	OCP:STEP 0.01	(Set step load current 0.01A)
	OCP:STOP 2	(Set stop load current 2A)
	VTH 3.0	(Set OCP VTH 3.0V)
	IL 0	(Set current low limit 0A)
	IH 2	(Set current high limit 2A)
	NGENABLE ON	(Set NG Enable ON)
	START	(Start OCP testing)
	TESTING?	(Ask Testing? 1: Testing, 0: Testing End)
	NG?	(Ask PASS/FAIL?, 0: PASS, 1: FAIL)
	OCP?	(Ask OCP current value)
STOP	(Stop OCP testing)	

Power Supply OPP testing

OPP Manual control

1. Press Limit Key function to setting W_Hi 30.00W.



2. Press Limit Key function to setting W_Lo 0W.



3. Setting OPP test, press OPP key to the next step.



4. Setting start load current 0W, press OPP key to the next step.



5. Setting step load current 5W, press OPP key to the next step.



6. Setting stop load current 100W, press OPP key to the next step.



7. Setting OPP VTH 5.00V, press OPP key to the next step.



8. Press START/STOP test key.
-



9. The UUT's output voltage drop-out lower than the threshold voltage (V-th setting), and the OPP trip point is between W_Hi and W_Lo limitation, then Right upper 5 digits LCD display will shows "PASS", otherwise shows "FAIL".



OPP Remote control	REMOTE	(Set Remote)
	TCONFIG OPP	(Set OPP test)
	OPP:START 3	(Set start load watt 3W)
	OPP:STEP 1	(Set step load watt 1W)
	OPP:STOP 5	(Set stop load watt 5W)
	VTH 3.0	(Set OPP VTH 3.0V)
	WL 0	(Set watt low limit 0W)
	WH 5	(Set watt high limit 5W)
	NGENABLE ON	(Set NG Enable ON)
	START	(Start OPP testing)
	TESTING?	(Ask Testing? 1: Testing, 0: Testing End)
	NG?	(Ask PASS/FAIL?, 0: PASS, 1 : FAIL)
	OPP?	(Ask OPP watt value)
	STOP	(Stop OPP testing)

SHORT testing

SHORT Manual control

1. Setting SHORT test, press Short key to the next step.



2. Press UP key, setting Short time to 1000ms, press Short key to the next Step.



3. Press down key, setting V-Hi voltage to 6.00V, press Short key to the next Step.



4. Press down key, setting V-Lo voltage to 0V, press Short key to the next step.



5. Press START/STOP test key.



6. Short test finish, the UUT's drop voltage is between V_Hi and V_Lo limitation, then right upper 5 digits LCD display will shows "PASS"



7. The UUT's not drop voltage is between V_Hi and V_Lo limitation, LCD display will shows FAIL.
-



SHORT Remote control	REMOTE	(Set Remote)
	TCONFIG SHORT	(Set SHORT test)
	STIME 1	(Set short time 1ms)
	START	(Start SHORT testing)
	TESTING?	(Ask Testing? 1: Testing, 0: Testing End)
	STOP	(Stop SHORT testing)

BW Setting

Background

In order to match the bandwidth of different UUTs, the AEL-5000 Series electronic load is designed with a settable bandwidth function. The setting range is 0 ~ 15, where 0 is the slowest and 15 is the fastest. When the bandwidth of the UUT does not match the bandwidth of the electronic load, there will be oscillations.

Please adjust the BW setting value appropriately to meet the UUT response speed.

Vin=110V/60Hz;
SET LIN 20A
BW=15
CH1=Vininput ;
CH2=Current



Vin=110V/60Hz ;
SET LIN 20A
BW=13
CH1=Vininput ;
CH2=Current

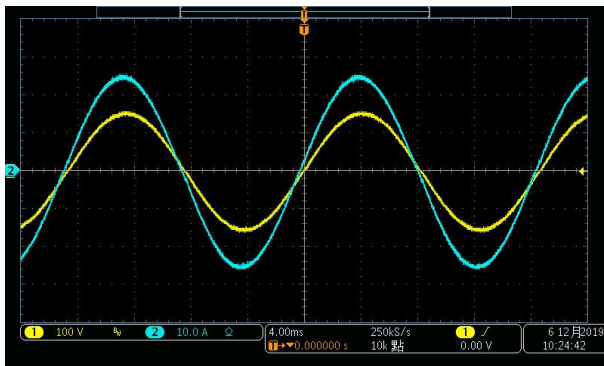

Special waveform applications

Background

The simulated UPS or the DUT whose load current will alternate on / off, is designed to have a waveform of 1ms ON and 1ms OFF at 50Hz or 60Hz. The setting method is in the constant current mode. After pressing the CF key, enter 5.1 or 5.2 From the number keys, and then press “Enter” to set. When the setting is completed, the frequency will be set to the corresponding value simultaneously.

CF = 5.1: Frequency 60Hz, 1ms ON / 1ms OFF.

CF = 5.2: Frequency 50Hz, 1ms ON / 1ms OFF.

Vin=110V/60Hz;
SET CC 5A
CF=5.1

CH1=Vinput;
CH2=Current

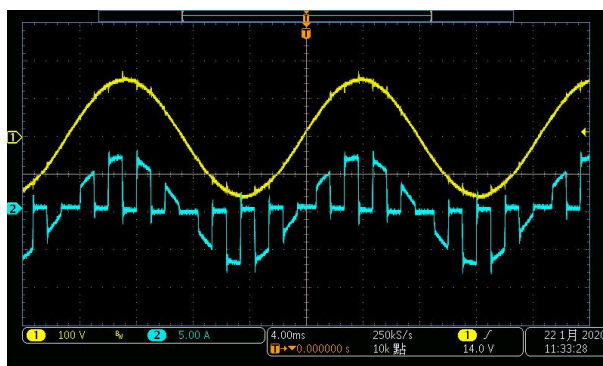

Vin=110V/50Hz;
SET CC 5A
CF=5.2

CH1=Vinput;
CH2=Current

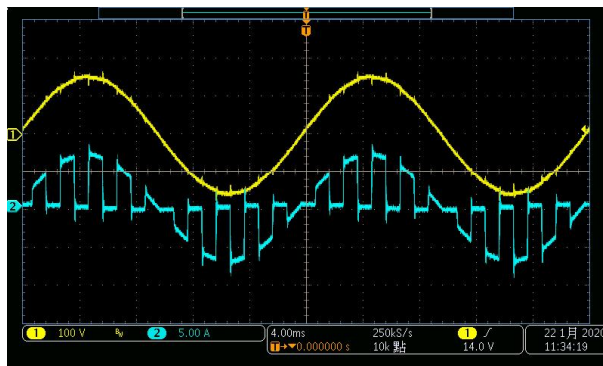

APPENDIX

Replacing the Fuse.....	212
AEL-5000 Default Settings	214
AEL-5000 Dimensions.....	218
AEL-5002-XXX-XX.....	218
AEL-5006-XXX-XX.....	218
AEL-5012-XXX-XX.....	219
AEL-5019-XXX-XX.....	220
AEL-5023-XXX-XX.....	221
AEL-5000 series Specifications	222
AEL-5002-350-18.75, AEL-5003-350-28, AEL-5004-350-37.5.....	222
AEL-5002-425-18.75, AEL-5003-425-28, AEL-5004-425-37.5.....	225
AEL-5006-350-56, AEL-5008-350-75, AEL-5012-350-112.5.....	228
AEL-5015-350-112.5, AEL-5019-350-112.5, AEL-5023-350-112.5.....	231
AEL-5006-425-56, AEL-5008-425-75, AEL-5012-425-112.5.....	234
AEL-5015-425-112.5, AEL-5019-425-112.5, AEL-5023-425-112.5.....	237
AEL-5003-480-18.75, AEL-5004-480-28.....	240
Declaration of Conformity.....	244
GPIB programming Example.....	245
BASICA Example Program.....	247
AEL-5000 Series USB Instruction	249
AEL-5000 series Auto, Sequence function provide EDIT, ENTER, EXIT, TEST and STORE 5 keys operation.....	251
AEL-5000 Series LAN Instruction	255

Replacing the Fuse

Background This product has the power fuse, and exchanges it according to the following procedure.

Caution Never fail to turn off the power of this product, and disconnect the plug of the AC Power cable.

Warning To avoid the fire or electronic shock, the Fuse that will be used in the product should have the safety standard in the area of the region you use. Any use of improper Fuse or shorting the Fuse holder would be extremely dangerous and would be strictly prohibited.

Before exchanging the Fuse, if there are abnormal odor or abnormal noise

Please stop using immediately and ask for the repair.

Procedure

1. Check the rating of the line fuse and replace it with the correct fuse if necessary.
100V~240V

Model	Fuse spec
AEL-5023-350-112.5 AEL-5023-425-112.5	T10A/250V(5*20mm)
AEL-5019-350-112.5 AEL-5019-425-112.5	T8A/250V(5*20mm)
AEL-5015-350-112.5 AEL-5015-425-112.5	T6A/250V(5*20mm)
AEL-5012-350-112.5 AEL-5012-425-112.5	T4A/250V(5*20mm)
AEL-5008-350-75 AEL-5008-425-75	T3A/250V(5*20mm)

AEL-5006-350-56

AEL-5006-425-56

AEL-5002-350-18.75 T2A/250V(5*20mm)

AEL-5002-450-18.75

AEL-5003-480-18.75

AEL-5003-350-28

AEL-5003-425-28

AEL-5004-480-28

AEL-5004-350-27.5

AEL-5004-425-37.5

2. The AC line fuse is located below the AC line receptacle see Fig 2-2. Use a small screwdriver to extract the fuse holder, to change a new one. Change an appropriate specifications fuse
3. Reinstall fuse holder and connect the power cord.

AEL-5000 Series
fuse holder

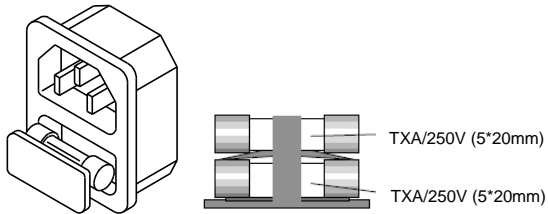

AEL-5000 Default Settings

The following default settings are the factory configuration settings for the load.

Model	AEL-5002-350-18.75	AEL-5003-350-28	AEL-5004-350-37.5
	AEL-5002-425-18.75	AEL-5003-425-28	AEL-5004-425-37.5
Item	Initial value		
CC A+Preset	0.000A	0.000A	0.000A
CC B+Preset	0.000A	0.000A	0.000A
LIN A+Preset	0.000A	0.000A	0.000A
LIN B+Preset	0.000A	0.000A	0.000A
CR A+Preset	64000Ω	40000Ω	32000Ω
CR B+Preset	64000Ω	40000Ω	32000Ω
CP A+Preset	0.0W	0.0W	0.0W
CP B+Preset	0.0W	0.0W	0.0W
CV A+Preset	500.00V	500.00V	500.00V
CV B+Preset	500.00V	500.00V	500.00V

Model	AEL-5006-350-56	AEL-5008-350-75	AEL-5012-350-112.5
	AEL-5006-425-56	AEL-5008-425-75	AEL-5012-425-112.5
Item	Initial value		
CC A+Preset	0.000A	0.000A	0.000A
CC B+Preset	0.000A	0.000A	0.000A
LIN A+Preset	0.000A	0.000A	0.000A
LIN B+Preset	0.000A	0.000A	0.000A
CR A+Preset	20000Ω	16000Ω	10666Ω
CR B+Preset	20000Ω	16000Ω	10666Ω
CP A+Preset	0.0W	0.0W	0.0W
CP B+Preset	0.0W	0.0W	0.0W
CV A+Preset	500.00V	500.00V	500.00V
CV B+Preset	500.00V	500.00V	500.00V

Model	AEL-5015-350-112.5	AEL-5019-350-112.5	AEL-5023-350-112.5
	AEL-5015-425-112.5	AEL-5019-425-112.5	AEL-5023-425-112.5
Item	Initial value		
CC A+Preset	0.000A	0.000A	0.000A
CC B+Preset	0.000A	0.000A	0.000A
LIN A+Preset	0.000A	0.000A	0.000A
LIN B+Preset	0.000A	0.000A	0.000A

CR A+Preset	10666Ω	10666Ω	10666Ω
CR B+Preset	10666Ω	10666Ω	10666Ω
CP A+Preset	0.0W	0.0W	0.0W
CP B+Preset	0.0W	0.0W	0.0W
CV A+Preset	500.00V	500.00V	500.00V
CV B+Preset	500.00V	500.00V	500.00V

Model	AEL-5003-480-18.75	AEL-5004-480-28
Item	Initial value	
CC A+Preset	0.000A	0.000A
CC B+Preset	0.000A	0.000A
LIN A+Preset	0.000A	0.000A
LIN B+Preset	0.000A	0.000A
CR A+Preset	80000Ω	50000Ω
CR B+Preset	80000Ω	500000Ω
CP A+Preset	0.0W	0.0W
CP B+Preset	0.0W	0.0W
CV A+Preset	500.00V	500.00V
CV B+Preset	500.00V	500.00V

Model	AEL-5002-350-18.75	AEL-5003-350-28	AEL-5004-350-37.5
Item	Initial value for Limit		
V_Hi	600.00V	600.00V	600.00V
V_Lo	0.00V	0.00V	0.00V
I_Hi	20.000A	30.000A	40.000A
I_Lo	0.000A	0.000A	0.000A
W_Hi	2000.0W	3000.0W	4000.0W
W_Lo	0.0W	0.0W	0.0W
VA_Hi	2000.0VA	3000.0VA	4000.0VA
VA_Lo	0.0VA	0.0VA	0.0VA
OPL	1968.75W	2940.0W	3937.5W
OCL	19.687A	29.400A	39.375A

Model	AEL-5006-350-56	AEL-5008-350-75	AEL-5012-350-112.5
Item	Initial value for Limit		
V_Hi	600.00V	600.00V	600.00V
V_Lo	0.00V	0.00V	0.00V
I_Hi	115.00A	80.000A	115.00A

I_Lo	0.000A	0.000A	0.000A
W_Hi	6000W	8000.0W	11500W
W_Lo	0.0W	0.0W	0.0W
VA_Hi	6000VA	8000.0VA	11500VA
VA_Lo	0.0VA	0.0VA	0.0VA
OPL	5880W	7875W	11812W
OCL	58.8A	78.75A	118.12A

Model	AEL-5015-350-112.5	AEL-5019-350-112.5	AEL-5023-350-112.5
Item	Initial value for Limit		
V_Hi	600.00V	600.00V	600.00V
V_Lo	0.00V	0.00V	0.00V
I_Hi	115.00A	115.00A	115.00A
I_Lo	0.000A	0.000A	0.000A
W_Hi	15500W	19000W	23000W
W_Lo	0.0W	0.0W	0.0W
VA_Hi	15500VA	19000VA	23000VA
VA_Lo	0.0VA	0.0VA	0.0VA
OPL	15750W	19687W	23625W
OCL	118.12A	118.12A	118.12A

Model	AEL-5003-480-18.75	AEL-5004-480-18.75
Item	Initial value for Limit	
V_Hi	750.00V	750.00V
V_Lo	0.00V	0.00V
I_Hi	20.000A	30.000A
I_Lo	0.000A	0.000A
W_Hi	3000.0W	4000.0W
W_Lo	0.0W	0.0W
VA_Hi	2000.0VA	4000.0VA
VA_Lo	0.0VA	0.0VA
OPL	2940.0W	3937.5W
OCL	19.687A	29.400A

Model	For all models of AEL-5000 series
Item	Initial value for Config
EXTIN	OFF
SYNC	OFF
LD ON	0

LDOFF	0
BW	13
AVG	1
CPRSP	0
CYCLE	1

AEL-5000 Dimensions

AEL-5002-XXX-XX

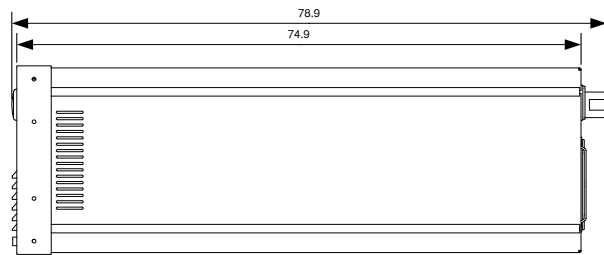
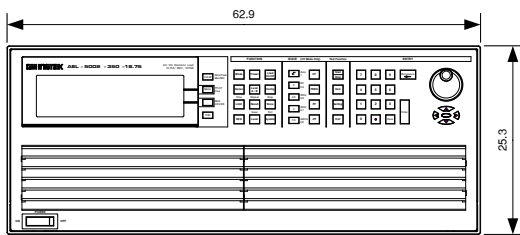

AEL-5006-XXX-XX

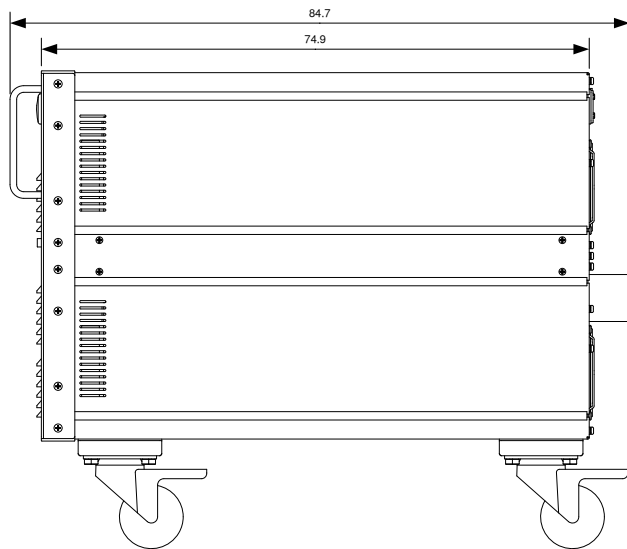
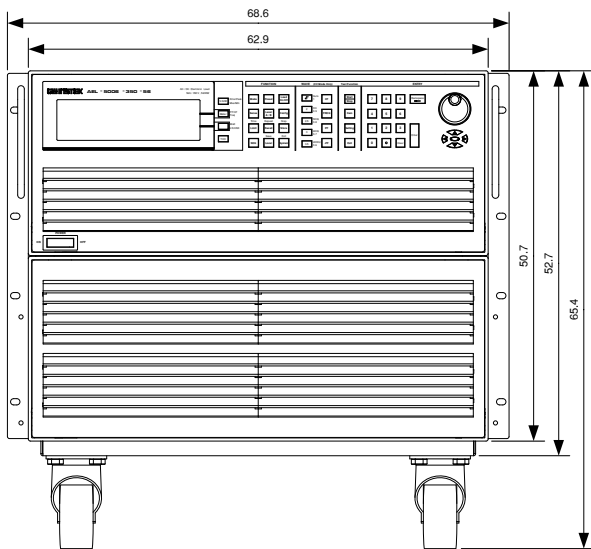

AEL-5012-XXX-XX

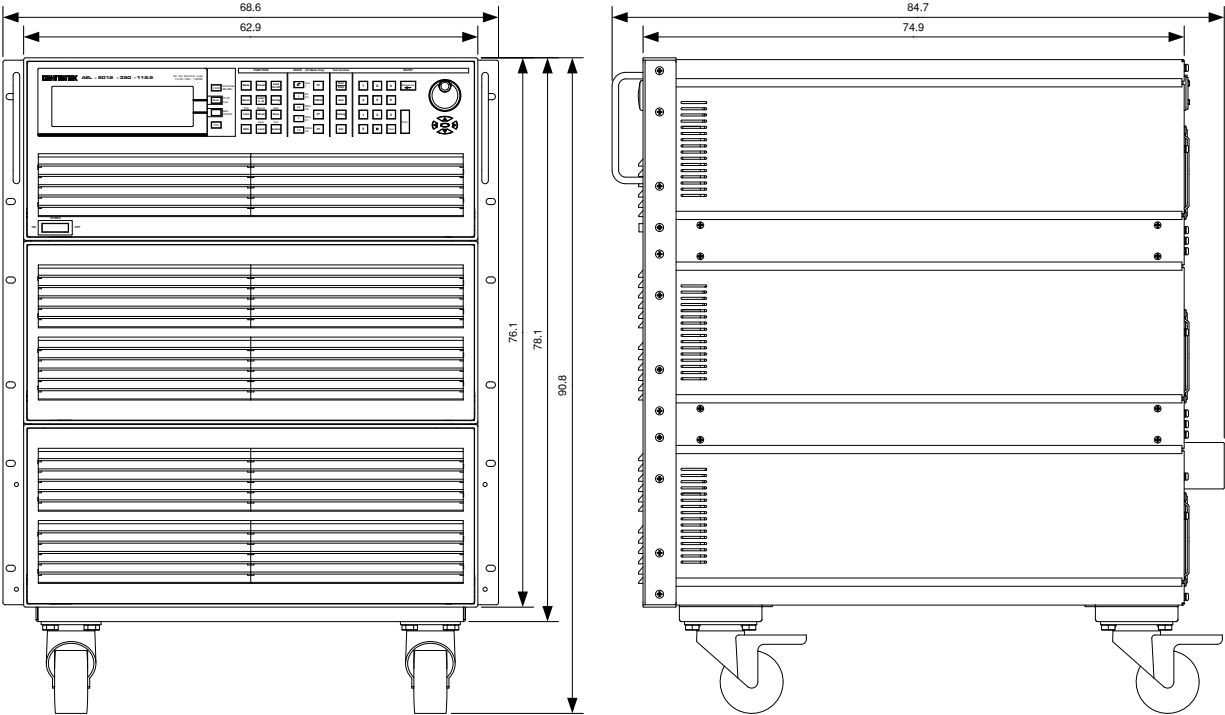

AEL-5019-XXX-XX

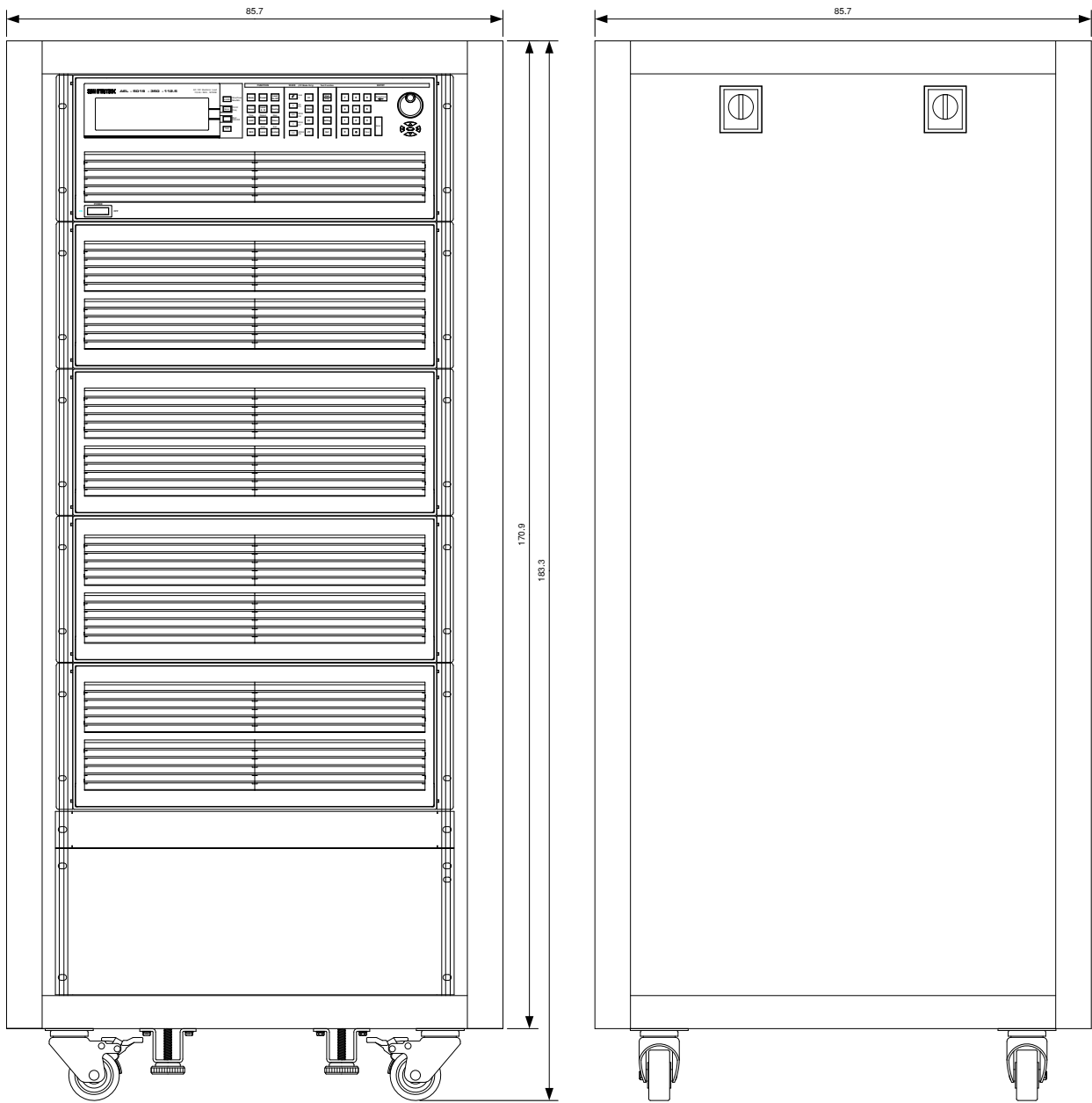

AEL-5023-XXX-XX

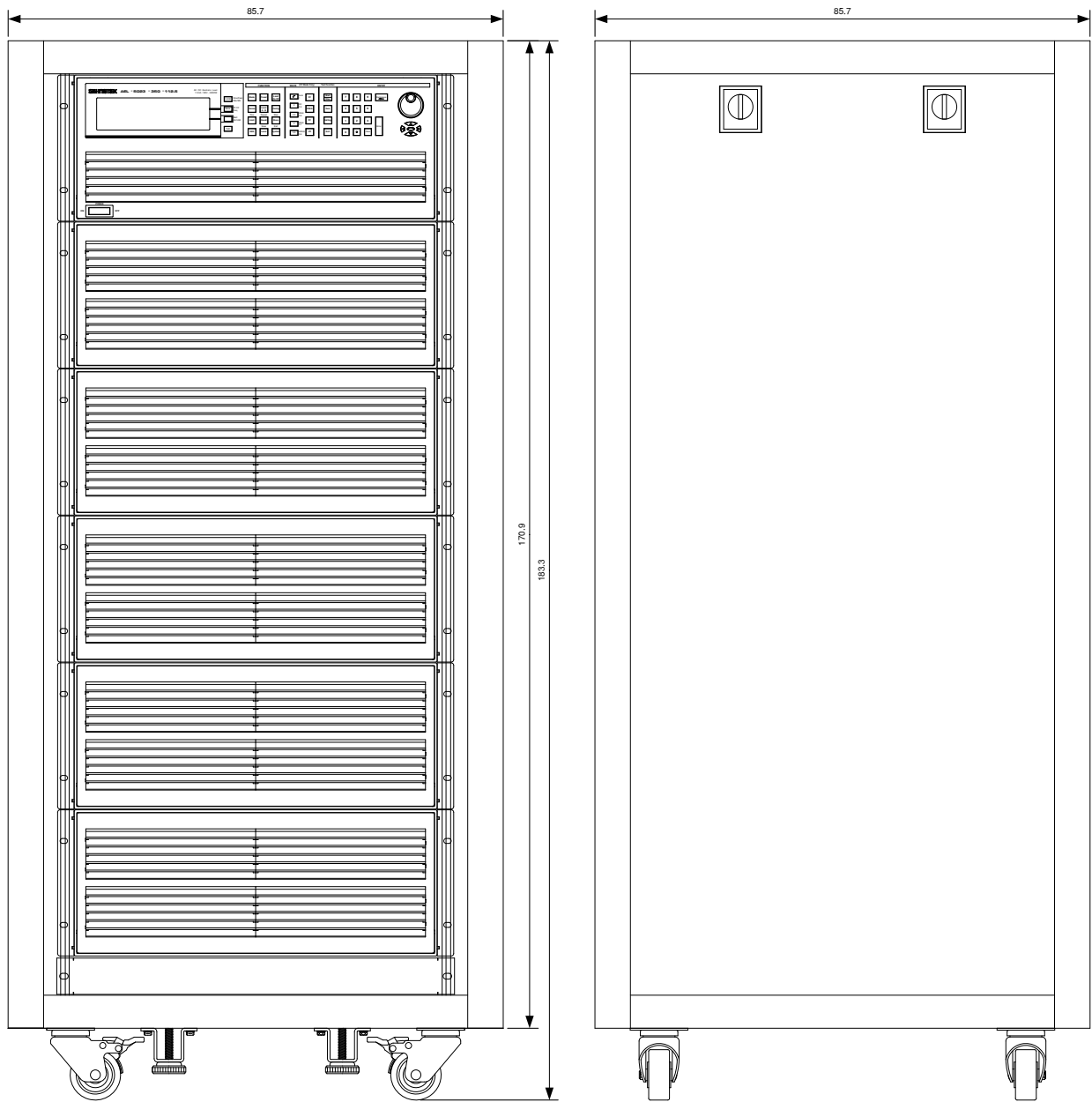

AEL-5000 series Specifications

The specifications apply when the AEL-5000 is powered on for at least 30 minutes. Note that the high frequency and high voltage options are listed as separate specifications.

AEL-5002-350-18.75, AEL-5003-350-28, AEL-5004-350-37.5

MODEL	AEL-5002-350-18.75	AEL-5003-350-28	AEL-5004-350-37.5
Power (W)	1875 W	2800W	3750 W
Current(Ampere)	18.75 Arms/56.25Apeak	28 Arms / 84Apeak	37.5 Arms / 112.5Apeak
Voltage(Volt)	50~350Vrms / 500Vdc		
Frequency Range	DC, 40 ~ 440Hz(CC, CP Mode), DC ~ 440Hz(LIN, CR, CV Mode)		
PROTECTIONS			
Over Power Protection	≅ 1968.75Wrms or Programmable	≅2940Wrms or Programmable	≅3937.5Wrms or Programmable
Over Current Protection	≅ 19.687 Arms or Programmable	≅ 29.4 Arms or Programmable	≅39.375 Arms, or Programmable
Over Voltage Protection	≅ 367.5 Vrms/525Vdc		
Over Temp. Protection	Yes		
OPERATION MODE			
Constant Current Mode for Sine-Wave			
Range	0~18.75A	0~28A	0~37.5A
Resolution	0.3125mA/16bits	0.5mA/16bits	0.625mA/16bits
Accuracy	±(0.1% of setting + 0.2% of range) @ 50/60Hz		
Linear Constant Current Mode for Sine-Wave, Square-Wave or Quasi-Square Wave, PWM Wave			
Range	0~18.75A	0~28A	0~37.5A
Resolution	0.3125mA/16bits	0.5mA/16bits	0.625mA/16bits
Accuracy	±(0.1% of setting + 0.2% of range) @ 50/60Hz		
Constant Resistance Mode			
Range	3.2 ohm ~ 64K ohm	2.0 ohm ~ 40K ohm	1.6 ohm ~ 32K ohm
Resolution ^{*1}	0.0052083mS/16bits	0.0083333mS/16bits	0.010416mS/16bits
Accuracy	±0.2% of (setting + range) @ 50/60Hz		
Constant Voltage Mode			
Range	50~350Vrms / 500Vdc		
Resolution	0.01V		
Accuracy	±(0.1 of setting + 0.1%of range)		
Constant Power Mode			
Range	1875W	2800W	3750W
Resolution	0.1W	0.1W	0.1W
Accuracy	±(0.1 of setting + 0.1%of range)		
CREST factor (CC & CP MODE ONLY)			
Range	√2~5		

Resolution	0.1			
Accuracy	(0.5% / Irms) + 1% F.S.			
Power factor (CC & CP MODE ONLY)				
Range	0~1 Lag or Lead			
Resolution	0.01			
Accuracy	1% F.S.			
TEST MODE				
UPS Efficient Measurement	Non-Linear Mode			
Operating Frequency	Auto ; 40~440Hz			
Current Range	0~18.75A	0~28A	0~37.5A	
PF Range	0~1			
Measuring Efficiency for PV System, Power Conditioners for THD 80%	Resistive + Non-Linear Mode			
Operating Frequency	Auto ; 40~440Hz			
Current Range	0~18.75A	0~28A	0~37.5A	
Resistive Range	3.2 ohm ~ 64K ohm	2.0 ohm ~ 40K ohm	1.6 ohm ~ 32K ohm	
UPS Back-Up function (CC, LIN, CR, CP)				
UVP (VTH)	50~350Vrms / 500Vdc			
UPS Back-Up Time	1~99999 Sec. (>27H)			
Battery Discharge function (CC, LIN, CR, CP)				
UVP (VTH)	50~350Vrms / 500Vdc			
Battery Discharge Time	1~99999 Sec. (>27H)			
UPS Transfer Time				
Current Range	0~18.75A	0~28A	0~37.5A	
UVP (VTH)	2.5V			
Time range	0.15mS~999.99mS			
Fuse Test mode				
Max. Current	Turbo OFF	18.75Arms	28.0Arms	37.5Arms
	Turbo ON	37.5Arms (x2) ^{*3}	56.0Arms (x2) ^{*3}	75.0Arms (x2) ^{*3}
Trip & Non-Trip Time	Turbo OFF	0.1~9999.9sec.		
	Turbo ON	0.1~1.0sec.		
Meas. Accuracy	±0.003 Sec.			
Repeat Cycle	0~255			
Short/OPP/OCF Test Function				
Short Time	Turbo OFF	0.1S ~ 10Sec. or Cont.		
	Turbo ON	0.1S ~ 1Sec		
OPP/OCF Step Time	Turbo OFF	100ms		
	Turbo ON	100ms, up to 10 Steps		
OCP Istop	Turbo OFF	18.75Arms	28.0Arms	37.5Arms
	Turbo ON	37.5Arms	56.0Arms	75.0Arms
OPP Pstop	Turbo OFF	1875W	2800W	3750W
	Turbo ON	3750W	5600W	7500W
Programmable Inrush current simulation: Istart - Istop/ Tsep				

Istart, Inrush Start Current	0~37.5A	0~56A	0~75A
Inrush Step time	0.1mS~100mS		
Istop, Inrush stop current	0~18.75A	0~28A	0~37.5A
Programmable Surge current simulation: S1/T1 - S2/T2 - S3/T3			
S1 and S2 Current	0~37.5A	0~56A	0~75A
T1 and T2 Time	0.01S ~ 0.5Sec.		
S3 Current	0~18.75A	0~28A	0~37.5A
T3 Time	0.01S~9.99Sec. Or Cont.		
MEASUREMENTS			
VOLTAGE READBACK A METER			
Range	500V		
Resolution	0.01V		
Accuracy	±0.05% of (reading + range)		
Parameter	Vrms, V Max/Min, ±Vpk		
CURRENT READBACK A METER			
Range	9.375Arms/18.75Arms	14Arms/28Arms	18.75Arms/37.5Arms
Resolution	0.2mA/0.4mA	0.3mA/0.6mA	0.4mA/0.8mA
Accuracy	±0.05% of (reading + range)@ 50/60Hz, ±0.4% of (reading + range)		
Parameter	Irms, I Max/Min, ±Ipk		
WATT READBACK W METER			
Range	1875W	2800W	3750W
Resolution	0.03125W	0.05W	0.0625W
Accuracy	±0.1% of (reading + range)		
VA METER	Vrms x Arms correspond to Vrms and Arms		
Power Factor METER			
Range	±0.000~1.000		
Accuracy	±(0.002±(0.001/PF)*F)		
Frequency METER(V)			
Range	DC,40~440Hz		
Accuracy	0.1%		
Other Parameter METER			
VA, VAR, CF_I, Ipeak, Imax., Imin. Vmax., Vmin., IHD, VHD, ITHD, VTHD			
OTHERS			
Start up loading	Yes , Power on loading during Inverter / UPS start up		
Load ON / OFF Angle	0 ~ 359 degree can be programmed for the angle of load ON and load OFF loading		
Half cycle and SCR/TRIAC loading	Positive or Negative half cycle, 90° Trailing edge or Leading edge current waveform can be programmed		
Master/Slave (3 phase or Parallel application)	Yes, 1 master and up to 7 slave unit		
External programming input(OPTION)	F.S / 10Vdc, Resolution 0.1V		
External SYNC input	TTL		
Vmonitor (Isolated)	±500V / ±10V		
Imonitor (Isolated)	±56.25Apk / ±10Vpk	±84Apk / ±10Vpk	±112.5Apk / ±10Vpk
Interface (OPTION)	GPIB; RS-232; LAN; USB		

MAX. Power consumption	150VA	150VA	150VA
Operation Temperature *2	0 ~ 40 °C		
Current of input impedance (mA) @ 50/60Hz ; @400Hz	~V*0.3 ; ~V*2.2	~V*0.45 ; ~V*3.3	~V*0.6 ; ~V*4.4
Dimension (H x W x D)	177 x 440 x 558 mm	177 x 440 x 558mm	177 x 440 x 558 mm
Weight	21.5Kg	27.5Kg	33.5Kg

AEL-5002-425-18.75, AEL-5003-425-28, AEL-5004-425-37.5

MODEL	AEL-5002-425-18.75	AEL-5003-425-28	AEL-5004-425-37.5
Power (W)	1875 W	2800W	3750 W
Current(Ampere)	18.75 Arms/56.25Apeak	28 Arms / 84Apeak	37.5 Arms / 112.5Apeak
Voltage(Volt)	50~425Vrms / 600Vdc		
Frequency Range	DC, 40 ~ 440Hz(CC, CP Mode), DC ~ 440Hz(LIN, CR, CV Mode)		
PROTECTIONS			
Over Power Protection	≅ 1968.75Wrms or Programmable	≅ 2940Wrms or Programmable	≅ 3937.5Wrms or Programmable
Over Current Protection	≅ 19.687 Arms or Programmable	≅ 29.4 Arms or Programmable	≅ 39.375 Arms, or Programmable
Over Voltage Protection	≅ 446.25 Vrms/630Vdc		
Over Temp. Protection	Yes		
OPERATION MODE			
Constant Current Mode for Sine-Wave			
Range	0~18.75A	0~28A	0~37.5A
Resolution	0.3125mA/16bits	0.5mA/16bits	0.625mA/16bits
Accuracy	±(0.1% of setting + 0.2% of range) @ 50/60Hz		
Linear Constant Current Mode for Sine-Wave, Square-Wave or Quasi-Square Wave, PWM Wave			
Range	0~18.75A	0~28A	0~37.5A
Resolution	0.3125mA/16bits	0.5mA/16bits	0.625mA/16bits
Accuracy	±(0.1% of setting + 0.2% of range) @ 50/60Hz		
Constant Resistance Mode			
Range	3.2 ohm ~ 64K ohm	2.0 ohm ~ 40K ohm	1.6 ohm ~ 32K ohm
Resolution*1	0.0052083mS/16bits	0.0083333mS/16bits	0.010416mS/16bits
Accuracy	±0.2% of (setting + range) @ 50/60Hz		
Constant Voltage Mode			
Range	50~425Vrms /600Vdc		
Resolution	0.1V		
Accuracy	±(0.1 of setting + 0.1%of range)		
Constant Power Mode			
Range	1875W	2800W	3750W
Resolution	0.1W	0.1W	0.1W
Accuracy	±(0.1 of setting + 0.1%of range)		
CREST factor (CC & CP MODE ONLY)			
Range	√2~5		
Resolution	0.1		

Accuracy	(0.5% / Irms) + 1% F.S.			
Power factor (CC & CP MODE ONLY)				
Range	0~1 Lag or Lead			
Resolution	0.01			
Accuracy	1% F.S.			
TEST MODE				
UPS Efficient Measurement	Non-Linear Mode			
Operating Frequency	Auto ; 40~440Hz			
Current Range	0~18.75A	0~28A	0~37.5A	
PF Range	0~1			
Measuring Efficiency for PV System, Power Conditioners for THD	Resistive + Non-Linear Mode			
80%				
Operating Frequency	Auto ; 40~440Hz			
Current Range	0~18.75A	0~28A	0~37.5A	
Resistive Range	3.2 ohm ~ 64K ohm	2.0 ohm ~ 40K ohm	1.6 ohm ~ 32K ohm	
UPS Back-Up function(CC,LIN,CR,CP)				
UVP (VTH)	50~425Vrms / 600Vdc			
UPS Back-Up Time	1~99999 Sec. (>27H)			
Battery Discharge function(CC,LIN,CR,CP)				
UVP (VTH)	50~425Vrms / 600Vdc			
Battery Discharge Time	1~99999 Sec. (>27H)			
UPS Transfer Time				
Current Range	0~18.75A	0~28A	0~37.5A	
UVP (VTH)	2.5V			
Time range	0.15mS~999.99mS			
Fuse Test mode				
Max. Current	Turbo OFF	18.75Arms	28.0Arms	37.5Arms
	Turbo ON	37.5Arms (x2) ^{*3}	56.0Arms (x2) ^{*3}	75.0Arms (x2) ^{*3}
Trip & Non-Trip Time	Turbo OFF	0.1~9999.9sec.		
	Turbo ON	0.1~1.0sec.		
Meas. Accuracy	±0.003 Sec.			
Repeat Cycle	0~255			
Short/OPP/OCP Test Function				
Short Time	Turbo OFF	0.1S ~ 10Sec. or Cont.		
	Turbo ON	0.1S ~ 1Sec		
OPP/OCP Step Time	Turbo OFF	100ms		
	Turbo ON	100ms, up to 10 Steps		
OCP Istop	Turbo OFF	18.75Arms	28.0Arms	37.5Arms
	Turbo ON	37.5Arms	56.0Arms	75.0Arms
OPP Pstop	Turbo OFF	1875W	2800W	3750W
	Turbo ON	3750W	5600W	7500W
Programmable Inrush current simulation: Istart - Istop/ Tsep				
Istart, Inrush Start Current	0~37.5A	0~56A	0~75A	

Inrush Step time	0.1mS~100mS		
Istop, Inrush stop current	0~18.75A	0~28A	0~37.5A
Programmable Surge current simulation: S1/T1 - S2/T2 - S3/T3			
S1 and S2 Current	0~37.5A	0~56A	0~75A
T1 and T2 Time	0.01S ~ 0.5Sec.		
S3 Current	0~18.75A	0~28A	0~37.5A
T3 Time	0.01S~9.99Sec. Or Cont.		
MEASUREMENTS			
VOLTAGE READBACK A METER			
Range	600V		
Resolution	0.01V		
Accuracy	±0.05% of (reading + range)		
Parameter	Vrms, V Max/Min, ±Vpk		
CURRENT READBACK A METER			
Range	9.375Arms/18.75Arms	14Arms/28Arms	18.75Arms/37.5Arms
Resolution	0.2mA/0.4mA	0.3mA/0.6mA	0.4mA/0.8mA
Accuracy	±0.05% of (reading + range) @ 50/60Hz		
Parameter	Irms, I Max/Min, ±Ipk		
WATT READBACK W METER			
Range	1875W	2800W	3750W
Resolution	0.03125W	0.05W	0.0625W
Accuracy	±0.1% of (reading + range)		
VA METER	Vrms x Arms correspond to Vrms and Arms		
Power Factor METER			
Range	±0.000~1.000		
Accuracy	±(0.002±(0.001/PF))*F		
Frequency METER(V)			
Range	DC,40~440Hz		
Accuracy	0.1%		
Other Parameter METER			
VA, VAR, CF_L, Ipeak, Imax., Imin. Vmax., Vmin., IHD, VHD, ITHD, VTHD			
OTHERS			
Start up loading	Yes , Power on loading during Inverter / UPS start up		
Load ON / OFF Angle	0 ~ 359 degree can be programmed for the angle of load ON and load OFF loading		
Half cycle and SCR/TRIAC loading	Positive or Negative half cycle, 90° Trailing edge or Leading edge current waveform can be programmed		
Master/Slave (3 phase or Parallel application)	Yes, 1 master and up to 7 slave unit		
External programming input(OPTION)	F.S / 10Vdc, Resolution 0.1V		
External SYNC input	TTL		
Vmonitor (Isolated)	±600V / ±10V		
Imonitor (Isolated)	±56.25Apk / ±10Vpk	±84Apk / ±10Vpk	±112.5Apk / ±10Vpk
Interface (OPTION)	GPIB; RS-232; LAN; USB		
MAX. Power consumption	150VA	150VA	150VA

Operation Temperature *2	0 ~ 40 °C		
Current of input impedance(mA) @ 50/60Hz ; @400Hz	~V*0.3 ; ~V*2.2	~V*0.45 ; ~V*3.3	~V*0.6 ; ~V*4.4
Dimension(H x W x D)	177 x 440 x 558 mm	177 x 440 x 558mm	177 x 440 x 558 mm
Weight	21.5Kg	27.5Kg	33.5Kg

AEL-5006-350-56, AEL-5008-350-75, AEL-5012-350-112.5

MODEL	AEL-5006-350-56	AEL-5008-350-75	AEL-5012-350-112.5
Power (W)	5600 W	7500 W	11250W
Current(Ampere)	56 Arms / 168Apeak	75 Arms / 225Apeak	112.5Arms/337.5Apeak
Voltage(Volt)	50~350Vrms / 500Vdc		
Frequency Range	DC, 40 ~ 440Hz(CC, CP Mode), DC ~ 440Hz(LIN, CR, CV Mode)		
PROTECTIONS			
Over Power Protection	≒ 5880Wrms or Programmable	≒ 7875Wrms or Programmable	≒ 11812.5Wrms or Programmable
Over Current Protection	≒ 58.8 Arms, or Programmable	≒ 78.75 Arms, or Programmable	≒ 118.125 Arms or Programmable
Over Voltage Protection	≒ 367.5 Vrms/525Vdc		
Over Temp. Protection	Yes		
OPERATION MODE			
Constant Current Mode for Sine-Wave			
Range	0~56A	0~75A	0~112.5A
Resolution	1mA/16bits	1.25mA/16bits	1.875mA/16bits
Accuracy	±(0.1% of setting + 0.2% of range)@ 50/60Hz, ± 0.5% of(setting + range)		
Linear Constant Current Mode for Sine-Wave, Square-Wave or Quasi-Square Wave, PWM Wave			
Range	0~56A	0~75A	0~112.5A
Resolution	1mA/16bits	1.25mA/16bits	1.875mA/16bits
Accuracy	±(0.1% of setting + 0.2% of range)@ 50/60Hz, ± 0.5% of (setting + range)		
Constant Resistance Mode			
Range	1 ohm ~ 20K ohm	0.8 ohm ~ 16K ohm	0.533ohm ~10.666K ohm
Resolution*1	0.016666mS/16bits	0.020832mS/16bits	0.031248mS/16bits
Accuracy	±0.2% of (setting + range)@ 50/60Hz, ± (0.5% of setting + 2% of range)		
Constant Voltage Mode			
Range	50~350Vrms / 500Vdc		
Resolution	0.1V		
Accuracy	±0.2% of (setting + range)@ 50/60Hz, ±0.4% of (setting + range)		
Constant Power Mode			
Range	5600W	7500W	11250W
Resolution	0.1W	0.1W	1W
Accuracy	±0.2% of (setting + range)@ 50/60Hz		
CREST factor (CC & CP MODE ONLY)			
Range	√ 2~5		

Resolution	0.1		
Accuracy	(0.5% / Irms) + 1% F.S.		
Power factor (CC & CP MODE ONLY)			
Range	0~1 Lag or Lead		
Resolution	0.01		
Accuracy	1% F.S.		
TEST MODE			
UPS Efficient Measurement	Non-Linear Mode		
Operating Frequency	Auto ; 40~440Hz		
Current Range	0~56A	0~75A	0~112.5A
PF Range	0~1		
Measuring Efficiency for PV System, Power Conditioners for THD 80%	Resistive + Non-Linear Mode		
Operating Frequency	Auto ; 40~440Hz		
Current Range	0~56A	0~75A	0~112.5A
Resistive Range	1 ohm ~ 20K ohm	0.8 ohm ~ 16K ohm	0.533 ohm ~ 10.666K ohm
UPS Back-Up function (CC, LIN, CR, CP)			
UVP (VTH)	50~350Vrms / 500Vdc		
UPS Back-Up Time	1~99999 Sec. (>27H)		
Battery Discharge function (CC, LIN, CR, CP)			
UVP (VTH)	50~350Vrms / 500Vdc		
Battery Discharge Time	1~99999 Sec. (>27H)		
UPS Transfer Time			
Current Range	0~56A	0~75A	0~112.5A
UVP (VTH)	2.5V		
Time range	0.15mS~999.99mS		
Fuse Test mode			
Max. Current	Turbo OFF	75Arms	112.5Arms
	Turbo ON	150Arms (x2) ^{*3}	225Arms (x2) ^{*3}
Trip & Non-Trip Time	Turbo OFF	0.1~9999.9sec.	
	Turbo ON	0.1~1.0sec.	
Meas. Accuracy	±0.003 Sec.		
Repeat Cycle	0~255		
Short/OPP/OCF Test Function			
Short Time	Turbo OFF	0.1S ~ 10Sec. or Cont.	
	Turbo ON	0.1S ~ 1Sec	
OPP/OCF Step Time	Turbo OFF	100ms	
	Turbo ON	100ms, up to 10 Steps	
OCF Istop	Turbo OFF	56Arms	112.5Arms
	Turbo ON	112Arms	225Arms
OPP Pstop	Turbo OFF	5600W	11250W
	Turbo ON	11200W	22500W
Programmable Inrush current simulation: Istart - Istop/ Tsep			

Istart, Inrush Start Current	0~112A	0~150A	0~225A
Inrush Step time	0.1mS~100mS		
Istop, Inrush stop current	0~56A	0~75A	0~112.5A
Programmable Surge current simulation: S1/T1 - S2/T2 - S3/T3			
S1 and S2 Current	0~112A	0~150A	0~225A
T1 and T2 Time	0.01S ~ 0.5Sec.		
S3 Current	0~56A	0~75A	0~112.5A
T3 Time	0.01S~9.99Sec. Or Cont.		
MEASUREMENTS			
VOLTAGE READBACK A METER			
Range	500V		
Resolution	0.01V		
Accuracy	±0.05% of (reading + range)		
Parameter	Vrms, V Max/Min, ±Vpk		
CURRENT READBACK A METER			
Range	28Arms/56Arms	37.5Arms/75Arms	56.25Arms/112.5Arms
Resolution	0.6mA/1.2mA	0.8mA/1.6mA	1.2mA/2.4mA
Accuracy	±0.01% of (reading + range)@ 50/60Hz		
Parameter	Irms, I Max/Min, ±Ipk		
WATT READBACK W METER			
Range	5600W	7500W	11250W
Resolution	0.1W	0.125W	0.1875W
Accuracy	±0.2% of (reading + range)		
VA METER	Vrms x Arms correspond to Vrms and Arms		
Power Factor METER			
Range	±0.000~1.000		
Accuracy	±(0.002±(0.001/PF)*F)		
Frequency METER(V)			
Range	DC,40~440Hz		
Accuracy	0.1%		
Other Parameter METER			
VA, VAR, CF_I, Ipeak, Imax., Imin. Vmax., Vmin., IHD, VHD, ITHD, VTHD			
OTHERS			
Start up loading	Yes , Power on loading during Inverter / UPS start up		
Load ON / OFF Angle	0 ~ 359 degree can be programmed for the angle of load ON and load OFF loading		
Half cycle and SCR/TRIAC loading	Positive or Negative half cycle, 90° Trailing edge or Leading edge current waveform can be programmed		
Master/Slave (3 phase or Parallel application)	Yes, 1 master and up to 7 slave unit		
External programming input(OPTION)	F.S / 10Vdc, Resolution 0.1V		
External SYNC input	TTL		
Vmonitor (Isolated)	±500V / ±10V		
Imonitor (Isolated)	±168Apk / ±10Vpk	±225Apk / ±10Vpk	±337.5Apk / ±10Vpk
Interface (OPTION)	GPIO; RS-232; LAN; USB		
MAX. Power consumption	270VA	270VA	390VA

Operation Temperature *2	0 ~ 40 °C		
Current of input impedance(mA) @ 50/60Hz ; @400Hz	~V*0.9 ; ~V*6.6	~V*1.2 ; ~V*8.8	~V*1.8 ; ~V*13.2
Dimension(H x W x D)	458 x 480 x 590 mm	458 x 480 x 590 mm	636 x 480 x 590 mm
Weight	58 kg	70 kg	105kg

AEL-5015-350-112.5, AEL-5019-350-112.5, AEL-5023-350-112.5

MODEL	AEL-5015-350-112.5	AEL-5019-350-112.5	AEL-5023-350-112.5
Power (W)	15000 W	18750W	22500W
Current(Ampere)	112.5 Arms/ 337.5Apeak	112.5 Arms/ 337.5Apeak	112.5 Arms/ 337.5Apeak
Voltage(Volt)	50~350Vrms / 500Vdc		
Frequency Range	DC, 40 ~ 440Hz(CC, CP Mode), DC ~ 440Hz(LIN, CR, CV Mode)		
PROTECTIONS			
Over Power Protection	≅ 11812.5Wrms or Programmable	≅ 19687.5Wrms or Programmable	≅ 23625Wrms or Programmable
Over Current Protection	≅ 118.125 Arms or Programmable	≅ 118.125 Arms or Programmable	≅ 118.125 Arms or Programmable
Over Voltage Protection	≅ 367.5 Vrms/525Vdc		
Over Temp. Protection	Yes		
OPERATION MODE			
Constant Current Mode for Sine-Wave			
Range	0~112.5A	0~112.5A	0~112.5A
Resolution	1.875mA/16bits	1.875mA/16bits	1.875mA/16bits
Accuracy	±(0.1% of setting + 0.2% of range) @ 50/60Hz, ± 0.5% of (setting + range)		
Linear Constant Current Mode for Sine-Wave, Square-Wave or Quasi-Square Wave, PWM Wave			
Range	0~112.5A	0~112.5A	0~112.5A
Resolution	1.875mA/16bits	1.875mA/16bits	1.875mA/16bits
Accuracy	±(0.1% of setting + 0.2% of range) @ 50/60Hz, ± 0.5% of (setting + range)		
Constant Resistance Mode			
Range	0.533 ohm ~ 0.666K ohm	0.533 ohm ~ 10.666K ohm	0.533 ohm ~ 10.666K ohm
Resolution*1	0.031248mS/16bits	0.031248mS/16bits	0.031248mS/16bits
Accuracy	±0.2% of (setting + range) @ 50/60Hz, ± (0.5% of setting + 2% of range)		
Constant Voltage Mode			
Range	50~350Vrms / 500Vdc		
Resolution	0.1V		
Accuracy	±0.2% of (setting + range) @ 50/60Hz, ±0.4% of (setting + range)		
Constant Power Mode			
Range	15000 W	18750W	22500W

Resolution	1W	1W	1W
Accuracy	±0.2% of (setting + range)@ 50/60Hz, ±0.4% of (setting + range)		
CREST factor (CC & CP MODE ONLY)			
Range	√2~5		
Resolution	0.1		
Accuracy	(0.5% / Irms) + 1%F.S.		
Power factor (CC & CP MODE ONLY)			
Range	0~1 Lag or Lead		
Resolution	0.01		
Accuracy	1%F.S.		
TEST MODE			
UPS Efficient Measurement	Non-Linear Mode		
Operating Frequency	Auto ; 40~440Hz		
Current Range	0~112.5A	0~112.5A	0~112.5A
PF Range	0 ~1		
Measuring Efficiency for PV System, Power Conditioners for THD 80%	Resistive + Non-Linear Mode		
Operating Frequency	Auto ; 40~440Hz		
Current Range	0~112.5A	0~112.5A	0~112.5A
Resistive Range	0.533 ohm ~ 10.666K ohm	0.533 ohm ~ 10.666K ohm	0.533 ohm ~ 10.666K ohm
UPS Back-Up function(CC,LIN,CR,CP)			
UVP (VTH)	50~350Vrms / 500Vdc		
UPS Back-Up Time	1~99999 Sec. (>27H)		
Battery Discharge function(CC,LIN,CR,CP)			
UVP (VTH)	50~350Vrms / 500Vdc		
Battery Discharge Time	1~99999 Sec. (>27H)		
UPS Transfer Time			
Current Range	0~112.5A	0~112.5A	0~112.5A
UVP (VTH)	2.5V		
Time range	0.15mS~999.99mS		
Fuse Test mode			
Max. Current	Turbo OFF 112.5Arms	112.5Arms	112.5Arms
	Turbo ON 225Arms(x2) ^{*3}	225Arms(x2) ^{*3}	225Arms(x2) ^{*3}
Trip & Non-Trip Time	Turbo OFF 0.1~9999.9sec.		
	Turbo ON 0.1~1.0sec.		
Meas. Accuracy	±0.003 Sec.		
Repeat Cycle	0~255		
Short/OPP/OCP Test Function			
Short Time	Turbo OFF 0.1S ~ 10Sec. or Cont.		
	Turbo ON 0.1S ~ 1Sec		
OPP/OCP	Turbo OFF 100ms		
Step Time	Turbo ON 100ms, up to 10 Steps		

OCP Istop	Turbo OFF	112.5Arms	112.5Arms	112.5Arms
	Turbo ON	225Arms	225Arms	225Arms
OPP Pstop	Turbo OFF	15000W	18750W	22500W
	Turbo ON	30000W	37500W	45000W
Programmable Inrush current simulation: Istart - Istop/ Tsep				
Istart, Inrush Start Current		0~225A	0~225A	0~225A
Inrush Step time		0.1mS~100mS		
Istop, Inrush stop current		0~112.5A	0~112.5A	0~112.5A
Programmable Surge current simulation: S1/T1 - S2/T2 - S3/T3				
S1 and S2 Current		0~225A	0~225A	0~225A
T1 and T2 Time		0.01S ~ 0.5Sec.		
S3 Current		0~112.5A	0~112.5A	0~112.5A
T3 Time		0.01S~9.99Sec. Or Cont.		
MEASUREMENTS				
VOLTAGE READBACK A METER				
Range		500V		
Resolution		0.01V		
Accuracy		±0.05% of (reading + range)		
Parameter		Vrms, V Max/Min, ±Vpk		
CURRENT READBACK A METER				
Range		56.25Arms/112.5Arms	56.25Arms/112.5Arms	56.25Arms/112.5Arms
Resolution		1.2mA/2.4mA	1.2mA/2.4mA	1.2mA/2.4mA
Accuracy		±0.1% of (reading + range)@ 50/60Hz, ±0.4% of (reading + range)		
Parameter		Irms, I Max/Min, ±Ipk		
WATT READBACK W METER				
Range		15000W	18750W	22500W
Resolution		0.25W	0.3125W	0.375W
Accuracy		±0.2% of (reading + range)@ 50/60Hz, ±0.4% of (reading + range)		
VA METER		Vrms x Arms correspond to Vrms and Arms		
Power Factor METER				
Range		±0.000~1.000		
Accuracy		±(0.002±(0.001/PF)*F)		
Frequency METER(V)				
Range		DC,40~440Hz		
Accuracy		0.1%		
Other Parameter METER				
		VA, VAR, CF_L, Ipeak, Imax., Imin. Vmax., Vmin., IHD, VHD, ITHD, VTHD		
OTHERS				
Start up loading		Yes , Power on loading during Inverter / UPS start up		
Load ON / OFF Angle		0 ~ 359 degree can be programmed for the angle of load ON and load OFF loading		
Half cycle and SCR/TRIAC loading		Positive or Negative half cycle, 90° Trailing edge or Leading edge current waveform can be programmed		
Master/Slave (3 phase or Parallel application)		Yes, 1 master and up to 7 slave unit		

External programming input(OPTION)	F.S / 10Vdc, Resolution 0.1V		
External SYNC input	TTL		
Vmonitor (Isolated)	±500V / ±10V		
Imonitor (Isolated)	±337.5Apk / ±10Vpk	±337.5Apk / ±10Vpk	±337.5Apk / ±10Vpk
Interface (OPTION)	GPIB; RS-232; LAN; USB		
MAX. Power consumption	510VA	630VA	750VA
Operation Temperature *2	0 ~ 40 °C		
Current of input impedance(mA) @ 50/60Hz ; @400Hz	~V*2.4; ~V*17.6	~V*3.0 ; ~V*22	~V*3.6 ; ~V*26.4
Dimension(H x W x D)	814 x 480 x 590 mm	1283 x 600 x 600 mm	1283 x 600 x 600 mm
Weight	140kg	260kg	295kg

AEL-5006-425-56, AEL-5008-425-75, AEL-5012-425-112.5

MODEL	AEL-5006-425-56	AEL-5008-425-75	AEL-5012-425-112.5
Power (W)	5600 W	7500 W	11250W
Current(Ampere)	56 Arms / 168Apeak	75 Arms / 225Apeak	112.5 Arms/337.5Apeak
Voltage(Volt)	50~425Vrms /600Vdc		
Frequency Range	DC, 40 ~ 440Hz(CC, CP Mode), DC ~ 440Hz(LIN, CR, CV Mode)		
PROTECTIONS			
Over Power Protection	≒ 5880Wrms or Programmable	≒ 7875Wrms or Programmable	≒ 11812.5Wrms or Programmable
Over Current Protection	≒ 58.8 Arms, or Programmable	≒ 78.75 Arms, or Programmable	≒ 118.125 Arms or Programmable
Over Voltage Protection	≒ 446.25 Vrms/630Vdc		
Over Temp. Protection	Yes		
OPERATION MODE			
Constant Current Mode for Sine-Wave			
Range	0~56A	0~75A	0~112.5A
Resolution	1mA/16bits	1.25mA/16bits	1.875mA/16bits
Accuracy	±(0.1% of setting + 0.2% of range)@ 50/60Hz, ± 0.5% of(setting + range)		
Linear Constant Current Mode for Sine-Wave, Square-Wave or Quasi-Square Wave, PWM Wave			
Range	0~56A	0~75A	0~112.5A
Resolution	1mA/16bits	1.25mA/16bits	1.875mA/16bits
Accuracy	±(0.1% of setting + 0.2% of range)@ 50/60Hz, ± 0.5% of (setting + range)		
Constant Resistance Mode			
Range	1 ohm ~ 20K ohm	0.8 ohm ~ 16K ohm	0.533ohm~10.666K ohm
Resolution*1	0.016666mS/16bits	0.020832mS/16bits	0.031248mS/16bits
Accuracy	±0.2% of (setting + range)@ 50/60Hz, ± (0.5% of setting + 2% of range)		
Constant Voltage Mode			
Range	50~425Vrms / 600Vdc		

Resolution	0.1V		
Accuracy	±0.2% of (setting + range) @ 50/60Hz, ±0.4% of (setting + range)		
Constant Power Mode			
Range	5600W	7500W	11250W
Resolution	1W	1W	1W
Accuracy	±0.2% of (setting + range) @ 50/60Hz, ±0.4% of (setting + range)		
CREST factor (CC & CP MODE ONLY)			
Range	√2~5		
Resolution	0.1		
Accuracy	(0.5% / I _{rms}) + 1% F.S.		
Power factor (CC & CP MODE ONLY)			
Range	0~1 Lag or Lead		
Resolution	0.01		
Accuracy	1% F.S.		
TEST MODE			
UPS Efficient Measurement	Non-Linear Mode		
Operating Frequency	Auto ; 40~440Hz		
Current Range	0~56A	0~75A	0~112.5A
PF Range	0 ~1		
Measuring Efficiency for PV System, Power Conditioners for THD 80%	Resistive + Non-Linear Mode		
Operating Frequency	Auto ; 40~440Hz		
Current Range	0~56A	0~75A	0~112.5A
Resistive Range	1 ohm ~ 20K ohm	0.8 ohm ~ 16K ohm	0.533 ohm~10.666K ohm
UPS Back-Up function(CC,LIN,CR,CP)			
UVP (VTH)	50~425Vrms / 600Vdc		
UPS Back-Up Time	1~99999 Sec. (>27H)		
Battery Discharge function(CC,LIN,CR,CP)			
UVP (VTH)	50~425Vrms / 600Vdc		
Battery Discharge Time	1~99999 Sec. (>27H)		
UPS Transfer Time			
Current Range	0~56A	0~75A	0~112.5A
UVP (VTH)	2.5V		
Time range	0.15mS~999.99mS		
Fuse Test mode			
Max. Current	Turbo OFF	75Arms	112.5Arms
	Turbo ON	150Arms(x2) ^{*3}	225Arms(x2) ^{*3}
Trip & Non-Trip Time	Turbo OFF	0.1~9999.9sec.	
	Turbo ON	0.1~1.0sec.	
Meas. Accuracy	±0.003 Sec.		
Repeat Cycle	0~255		
Short/OPP/OCP Test Function			
Short Time	Turbo OFF	0.1S ~ 10Sec. or Cont.	

	Turbo ON	0.1S ~ 1Sec		
OPP/OCP	Turbo OFF	100ms		
Step Time	Turbo ON	100ms, up to 10 Steps		
OCP Istop	Turbo OFF	56Arms	75Arms	112.5Arms
	Turbo ON	112Arms	150Arms	225Arms
OPP Pstop	Turbo OFF	5600W	7500W	11250W
	Turbo ON	11200W	15000W	22500W
Programmable Inrush current simulation: Istart - Istop/ Tsep				
Istart, Inrush Start Current	0~112A	0~150A	0~225A	
Inrush Step time	0.1mS~100mS			
Istop, Inrush stop current	0~56A	0~75A	0~112.5A	
Programmable Surge current simulation: S1/T1 - S2/T2 - S3/T3				
S1 and S2 Current	0~112A	0~150A	0~225A	
T1 and T2 Time	0.01S ~ 0.5Sec.			
S3 Current	0~56A	0~75A	0~112.5A	
T3 Time	0.01S~9.99Sec. Or Cont.			
MEASUREMENTS				
VOLTAGE READBACK A METER				
Range	600V			
Resolution	0.01V			
Accuracy	±0.05% of (reading + range)			
Parameter	Vrms, V Max/Min, ±Vpk			
CURRENT READBACK A METER				
Range	28Arms/56Arms	37.5Arms/75Arms	56.25Arms/112.5Arms	
Resolution	0.6mA/1.2mA	0.8mA/1.6mA	1.2mA/2.4mA	
Accuracy	±0.1% of (reading + range) @ 50/60Hz, ±0.4% of (reading + range)			
Parameter	Irms, I Max/Min, ±Ipk			
WATT READBACK W METER				
Range	5600W	7500W	11250W	
Resolution	0.1W	0.125W	0.1875W	
Accuracy	±0.2% of (reading + range) @ 50/60Hz, ±0.4% of (reading + range)			
VA METER				
Vrms x Arms correspond to Vrms and Arms				
Power Factor METER				
Range	±0.000~1.000			
Accuracy	±(0.002±(0.001/PF))*F			
Frequency METER(V)				
Range	DC,40~440Hz			
Accuracy	0.1%			
Other Parameter METER				
VA, VAR, CF_I, Ipeak, Imax., Imin. Vmax., Vmin., IHD, VHD, ITHD, VTHD				
OTHERS				
Start up loading	Yes , Power on loading during Inverter / UPS start up			
Load ON / OFF Angle	0 ~ 359 degree can be programmed for the angle of load ON and load OFF loading			
Half cycle and	Positive or Negative half cycle, 90° Trailing edge or Leading edge			

SCR/TRIAC loading	current waveform can be programmed		
Master/Slave (3 phase or Parallel application)	Yes, 1 master and up to 7 slave unit		
External programming input(OPTION)	F.S / 10Vdc, Resolution 0.1V		
External SYNC input	TTL		
Vmonitor (Isolated)	±600V / ±10V		
Imonitor (Isolated)	±168Apk / ±10Vpk	±225Apk / ±10Vpk	±337.5Apk / ±10Vpk
Interface (OPTION)	GPIB; RS-232; LAN; USB		
MAX. Power consumption	270VA	270VA	390VA
Operation Temperature	*2 0 ~ 40 °C		
Current of input impedance(mA) @ 50/60Hz ; @400Hz	~V*0.9 ; ~V*6.6	~V*1.2 ; ~V*8.8	~V*1.8 ; ~V*13.2
Dimension(H x W x D)	458 x 480 x 590 mm	458 x 480 x 590 mm	636 x 480 x 590 mm
Weight	58 kg	70 kg	105kg

AEL-5015-425-112.5, AEL-5019-425-112.5, AEL-5023-425-112.5

MODEL	AEL-5015-425-112.5	AEL-5019-425-112.5	AEL-5023-425-112.5
Power (W)	15000 W	18750W	22500W
Current(Ampere)	112.5 Arms/337.5Apeak	112.5 Arms/337.5Apeak	112.5Arms/337.5Apeak
Voltage(Volt)	50~425Vrms /600Vdc		
Frequency Range	DC, 40 ~ 440Hz(CC, CP Mode), DC ~ 440Hz(LIN, CR, CV Mode)		
PROTECTIONS			
Over Power Protection	≅ 15750Wrms or Programmable	≅ 19687.5Wrms or Programmable	≅ 23625Wrms or Programmable
Over Current Protection	≅ 118.125 Arms or Programmable	≅ 118.125 Arms or Programmable	≅ 118.125 Arms or Programmable
Over Voltage Protection	≅ 446.25 Vrms/630Vdc		
Over Temp. Protection	Yes		
OPERATION MODE			
Constant Current Mode for Sine-Wave			
Range	0~112.5A	0~112.5A	0~112.5A
Resolution	1.875mA/16bits	1.875mA/16bits	1.875mA/16bits
Accuracy	±(0.1% of setting + 0.2% of range) @ 50/60Hz, ± 0.5% of(setting + range)		
Linear Constant Current Mode for Sine-Wave, Square-Wave or Quasi-Square Wave, PWM Wave			
Range	0~112.5A	0~112.5A	0~112.5A
Resolution	1.875mA/16bits	1.875mA/16bits	1.875mA/16bits
Accuracy	±(0.1% of setting + 0.2% of range) @ 50/60Hz, ± 0.5% of (setting + range)		

Constant Resistance Mode			
Range	0.533 ohm ~ 10.666K ohm	0.533 ohm ~ 10.666K ohm	0.533 ohm ~ 10.666K ohm
Resolution ^{*1}	0.031248mS/16bits	0.031248mS/16bits	0.031248mS/16bits
Accuracy	±0.2% of (setting + range) @ 50/60Hz, ± (0.5% of setting + 2% of range)		
Constant Voltage Mode			
Range	50~425Vrms / 600Vdc		
Resolution	0.1V		
Accuracy	±0.2% of (setting + range) @ 50/60Hz, ±0.4% of (setting + range)		
Constant Power Mode			
Range	15000 W	18750W	22500W
Resolution	1W	1W	1W
Accuracy	±0.2% of (setting + range) @ 50/60Hz, ±0.4% of (setting + range)		
CREST factor (CC & CP MODE ONLY)			
Range	√2~5		
Resolution	0.1		
Accuracy	(0.5% / Irms) + 1%F.S.		
Power factor (CC & CP MODE ONLY)			
Range	0~1 Lag or Lead		
Resolution	0.01		
Accuracy	1%F.S.		
TEST MODE			
UPS Efficient Measurement	Non-Linear Mode		
Operating Frequency	Auto; 40~440Hz		
Current Range	0~112.5A	0~112.5A	0~112.5A
PF Range	0 ~1		
Measuring Efficiency for PV System, Power Conditioners for THD	Resistive + Non-Linear Mode		
80%			
Operating Frequency	Auto ; 40~440Hz		
Current Range	0~112.5A	0~112.5A	0~112.5A
Resistive Range	0.533 ohm ~ 10.666K ohm	0.533 ohm ~ 10.666K ohm	0.533 ohm ~ 10.666K ohm
UPS Back-Up function(CC,LIN,CR,CP)			
UVP (VTH)	50~425Vrms / 600Vdc		
UPS Back-Up Time	1~99999 Sec. (>27H)		
Battery Discharge function(CC,LIN,CR,CP)			
UVP (VTH)	50~425Vrms / 600Vdc		
Battery Discharge Time	1~99999 Sec. (>27H)		
UPS Transfer Time			
Current Range	0~112.5A	0~112.5A	0~112.5A
UVP (VTH)	2.5V		
Time range	0.15mS~999.99mS		

Fuse Test mode				
Max. Current	Turbo OFF	112.5Arms	112.5Arms	112.5Arms
	Turbo ON	225Arms(x2)*3	225Arms(x2)*3	225Arms(x2)*3
Trip & Non-Trip Time	Turbo OFF	0.1~9999.9sec.		
	Turbo ON	0.1~1.0sec.		
Meas. Accuracy	±0.003 Sec.			
Repeat Cycle	0~255			
Short/OPP/OCP Test Function				
Short Time	Turbo OFF	0.1S ~ 10Sec. or Cont.		
	Turbo ON	0.1S ~ 1Sec		
OPP/OCP	Turbo OFF	100ms		
Step Time	Turbo ON	100ms, up to 10 Steps		
OCP Istop	Turbo OFF	112.5Arms	112.5Arms	112.5Arms
	Turbo ON	225Arms	225Arms	225Arms
OPP Pstop	Turbo OFF	15000W	18750W	22500W
	Turbo ON	30000W	37500W	45000W
Programmable Inrush current simulation: Istart - Istop/ Tsep				
Istart, Inrush Start Current	0~225A		0~225A	0~225A
Inrush Step time	0.1mS~100mS			
Istop, Inrush stop current	0~112.5A		0~112.5A	0~112.5A
Programmable Surge current simulation: S1/T1 - S2/T2 - S3/T3				
S1 and S2 Current	0~225A		0~225A	0~225A
T1 and T2 Time	0.01S ~ 0.5Sec.			
S3 Current	0~112.5A		0~112.5A	0~112.5A
T3 Time	0.01S~9.99Sec. Or Cont.			
MEASUREMENTS				
VOLTAGE READBACK A METER				
Range	600V			
Resolution	0.01V			
Accuracy	±0.05% of (reading + range)			
Parameter	Vrms, V Max/Min, ±Vpk			
CURRENT READBACK A METER				
Range	56.25Arms/112.5Arms	56.25Arms/112.5Arms	56.25Arms/112.5Arms	
Resolution	1.2mA/2.4mA	1.2mA/2.4mA	1.2mA/2.4mA	
Accuracy	±0.1% of (reading + range)@ 50/60Hz, ±0.4% of (reading + range)			
Parameter	Irms, I Max/Min, ±IpK			
WATT READBACK W METER				
Range	15000W	18750W	22500W	
Resolution	0.25W	0.3125W	0.375W	
Accuracy	±0.2% of (reading + range)@ 50/60Hz, ±0.4% of (reading + range)			
VA METER	Vrms x Arms correspond to Vrms and Arms			
Power Factor METER				
Range	±0.000~1.000			
Accuracy	±(0.002±(0.001/PF)*F)			
Frequency METER(V)				

Range	DC,40~440Hz		
Accuracy	0.1%		
Other Parameter	METER		
	VA, VAR, CF_I, Ipeak, Imax., Imin. Vmax., Vmin., IHD, VHD, ITHD, VTHD		
OTHERS			
Start up loading	Yes, Power on loading during Inverter / UPS start up		
Load ON / OFF Angle	0 ~ 359 degree can be programmed for the angle of load ON and load OFF loading		
Half cycle and SCR/TRIAC loading	Positive or Negative half cycle, 90° Trailing edge or Leading edge current waveform can be programmed		
Master/Slave (3 phase or Parallel application)	Yes, 1 master and up to 7 slave unit		
External programming input(OPTION)	F.S / 10Vdc, Resolution 0.1V		
External SYNC input	TTL		
Vmonitor (Isolated)	±600V / ±10V		
Imonitor (Isolated)	±337.5Apk / ±10Vpk	±337.5Apk / ±10Vpk	±337.5Apk / ±10Vpk
Interface (OPTION)	GPIB; RS-232; LAN; USB		
MAX. Power consumption	510VA	630VA	750VA
Operation Temperature *2	0 ~ 40 °C		
Current of input impedance(mA) @ 50/60Hz ; @400Hz	~V*2.4 ; ~V*17.6	~V*3.0 ; ~V*22	~V*3.6 ; ~V*26.4
Dimension(H x W x D)	814 x 480 x 590 mm	1283 x 600 x 600 mm	1283 x 600 x 600 mm
Weight	140kg	260kg	295kg

AEL-5003-480-18.75, AEL-5004-480-28

MODEL	AEL-5003-480-18.75	AEL-5004-480-28
Power (W)	2800W	3750 W
Current(Ampere)	18.75 Arms / 56.25Apeak	28 Arms / 84Apeak
Voltage(Volt)	50~480Vrms /700Vdc	
Frequency Range	DC, 40 ~ 70Hz(CC, CP Mode), DC ~ 70Hz(LIN, CR, CV Mode)	
PROTECTIONS		
Over Power Protection	≈ 2940Wrms or Programmable	≈ 3937.5Wrms or Programmable
Over Current Protection	≈ 19.687 Arms or Programmable	≈ 29.4 Arms or Programmable
Over Voltage Protection	≈ 504Vrms / 735Vdc	
Over Temp. Protection	Yes	
OPERATION MODE		
Constant Current Mode for Sine-Wave		
Range	0~18.75A	0~28A
Resolution	0.3125mA/16bits	0.5mA/16bits
Accuracy	±(0.1% of setting + 0.2% of range)@ 50/60Hz, ± 0.5% of(setting + range)	

Linear Constant Current Mode for Sine-Wave, Square-Wave or Quasi-Square Wave, PWM Wave		
Range	0~18.75A	0~28A
Resolution	0.3125mA/16bits	0.5mA/16bits
Accuracy	±(0.1% of setting + 0.2% of range)@ 50/60Hz, ± 0.5% of (setting + range)	
Constant Resistance Mode		
Range	4 ohm ~ 80K ohm	2.5 ohm ~ 50K ohm
Resolution*1	0.004166mS/16bits	0.006666mS/16bits
Accuracy	±0.2% of (setting + range)@ 50/60Hz, ± (0.5% of setting + 2% of range)	
Constant Voltage Mode		
Range	50~480Vrms / 700Vdc	
Resolution	0.0125V	
Accuracy	±(0.1% of setting + 0.1 of range)	
Constant Power Mode		
Range	2800W	3750W
Resolution	0.1W	0.1W
Accuracy	±(0.1% of setting + 0.1 of range)	
CREST factor (CC & CP MODE ONLY)		
Range	√2~5	
Resolution	0.1	
Accuracy	(0.5% / Irms) + 1% F.S.	
Power factor (CC & CP MODE ONLY)		
Range	0~1 Lag or Lead	
Resolution	0.01	
Accuracy	1% F.S.	
TEST MODE		
UPS Efficient Measurement	Non-Linear Mode	
Operating Frequency	Auto; 40~70Hz	
Current Range	0~18.75A	0~28A
PF Range	0 ~1	
Measuring Efficiency for PV System, Power Conditioners for THD 80%	Resistive + Non-Linear Mode	
Operating Frequency	Auto ; 40~70Hz	
Current Range	0~18.75A	0~28A
Resistive Range	4 ohm ~ 80K ohm	2.5 ohm ~ 50K ohm
UPS Back-Up function(CC,LIN,CR,CP)		
UVP (VTH)	50~480Vrms / 700Vdc	
UPS Back-Up Time	1~99999 Sec. (>27H)	
Battery Discharge function(CC,LIN,CR,CP)		
UVP (VTH)	50~480Vrms / 700Vdc	
Battery Discharge Time	1~99999 Sec. (>27H)	
UPS Transfer Time		
Current Range	0~18.75A	0~28A

UVP (VTH)	2.5V	
Time range	0.15mS~999.99mS	
Fuse Test mode		
Max. Current	Turbo OFF	18.75Arms
	Turbo ON	37.5Arms(x2) ^{*3}
Trip & Non-Trip Time	Turbo OFF	0.1~9999.9sec.
	Turbo ON	0.1~1.0sec.
Meas. Accuracy	±0.003 Sec.	
Repeat Cycle	0~255	
Short/OPP/OCP Test Function		
Short Time	Turbo OFF	0.1S ~ 10Sec. or Cont.
	Turbo ON	0.1S ~ 1Sec
OPP/OCP Step Time	Turbo OFF	100ms
	Turbo ON	100ms, up to 10 Steps
OCP Istop	Turbo OFF	18.75Arms
	Turbo ON	37.5Arms
OPP Pstop	Turbo OFF	2800W
	Turbo ON	5600W
Programmable Inrush current simulation: Istart - Istop/ Tsep		
Istart, Inrush Start Current	0~37.5A	0~56A
Inrush Step time	0.1mS~100mS	
Istop, Inrush stop current	0~18.75A	0~28A
Programmable Surge current simulation: S1/T1 - S2/T2 - S3/T3		
S1 and S2 Current	0~37.5A	0~56A
T1 and T2 Time	0.01S ~ 0.5Sec.	
S3 Current	0~18.75A	0~28A
T3 Time	0.01S~9.99Sec. Or Cont.	
MEASUREMENTS		
VOLTAGE READBACK A METER		
Range	600V	
Resolution	0.01V	
Accuracy	±0.05% of (reading + range)	
Parameter	Vrms, V Max/Min, ±Vpk	
CURRENT READBACK A METER		
Range	9.375Arms/18.75Arms	14Arms/28Arms
Resolution	0.2mA/0.4mA	0.3mA/0.6mA
Accuracy	±0.1% of (reading + range) @ 50/60Hz, ±0.4% of (reading + range)	
Parameter	Irms, I Max/Min, ±Ipk	
WATT READBACK W METER		
Range	2800W	3750W
Resolution	0.05W	0.0625W
Accuracy	±0.1% of (reading + range)	
VA METER		
	Vrms x Arms correspond to Vrms and Arms	
Power Factor METER		
Range	±0.000~1.000	
Accuracy	±(0.002±(0.001/PF))*F	
Frequency METER(V)		

Range	DC,40~70Hz	
Accuracy	0.1%	
Other Parameter METER	VA, VAR, CF_I, Ipeak, Imax., Imin. Vmax., Vmin., IHD, VHD, ITHD, VTHD	
OTHERS		
Start up loading	Yes , Power on loading during Inverter / UPS start up	
Load ON / OFF Angle	0 ~ 359 degree can be programmed for the angle of load ON and load OFF loading	
Half cycle and SCR/TRIAC loading	Positive or Negative half cycle, 90° Trailing edge or Leading edge current waveform can be programmed	
Master/Slave (3 phase or Parallel application)	Yes, 1 master and up to 7 slave unit	
External programming input(OPTION)	F.S / 10Vdc, Resolution 0.1V	
External SYNC input	TTL	
Vmonitor (Isolated)	±700V / ±10V	
Imonitor (Isolated)	±56.25Apk /±10Vpk	±84Apk /±10Vpk
Interface (OPTION)	GPIB; RS-232; LAN; USB	
MAX. Power consumption	150VA	150VA
Operation Temperature *2	0 ~ 40 °C	
Current of input impedance(mA) @ 50/60Hz ; @400Hz	~V*0.3 ; ~V*2.2	~V*0.4 ; ~V*2.95
Dimension(H x W x D)	177 x 440 x 558 mm	177 x 440 x 558 mm
Weight	27.5Kg	33.5Kg

*1 ms (millisiemens) is the unit of conductance(G), one siemens equal to 1/Ω

*2 Operating temperature range is 0~40°C, all specification apply for 25°C±5°C, Except as noted

*3 Turbo mode for up to 2X Current rating & Power rating support Fuse, Short/OCP/OPP test function

* All specifications apply for 50/60Hz.

* All specifications subject to change without notice.

Declaration of Conformity

We

GOOD WILL INSTRUMENT CO., LTD.

declare that the below mentioned product

Type of Product: AC/DC High Power Electronic Load

Model Number: AEL-5000

is herewith confirmed to comply with the requirements set out in the Council Directive on the Approximation of the Law of Member States relating to EMC (2014/30/EU), LVD (2014/35/EU), WEEE (2012/19/EU) and RoHS (2011/65/EU & 2015/863/EU).

For the evaluation regarding the Electromagnetic Compatibility and Low Voltage Directive, the following standards were applied:

© EMC	
EN 61326-1:2012 EN 61326-2-1:2006	Electrical equipment for measurement, control and laboratory use — EMC requirements (2013)
Conducted and Radiated Emissions EN 55011:2009+A1:2010	Electrical Fast Transients IEC 61000-4-4:2012
Current Harmonic EN 61000-3-2:2014	Surge Immunity IEC 61000-4-5:2005
Voltage Fluctuation EN 61000-3-3:2013	Conducted Susceptibility IEC 61000-4-6:2013
Electrostatic Discharge IEC 61000-4-2:2008	Power Frequency Magnetic Field IEC 61000-4-8:2009
Radiated Immunity IEC 61000-4-3:2006/1:2007/A2:2010	Voltage Dips/ Interrupts EN 61000-4-11:2004
Low Voltage Equipment Directive 2014/35/EU	
Safety Requirements	IEC 61010-1:2010 EN 61010-1:2010

GOODWILL INSTRUMENT CO., LTD.

No. 7-1, Jhongsing Road, Tucheng District, New Taipei City 236, Taiwan

Tel: [+886-2-2268-0389](tel:+886-2-2268-0389)

Fax: [+886-2-2268-0639](tel:+886-2-2268-0639)

Web: <http://www.gwinstek.com> Email: marketing@goodwill.com.tw

GOODWILL INSTRUMENT (SUZHOU) CO., LTD.

No. 521, Zhujiang Road, Snd, Suzhou Jiangsu 215011, China

Tel: [+86-512-6661-7177](tel:+86-512-6661-7177)

Fax: [+86-512-6661-7277](tel:+86-512-6661-7277)

Web: <http://www.instek.com.cn> Email: marketing@instek.com.cn

GOODWILL INSTRUMENT EURO B.V.

De Run 5427A, 5504DG Veldhoven, The Netherlands

Tel: [+31-\(0\)40-2557790](tel:+31-(0)40-2557790)

Fax: [+31-\(0\)40-2541194](tel:+31-(0)40-2541194)

Email: sales@gw-instek.eu

GPIB programming Example

C Example Program

```
/* Link this program with appropriate *cib*.obj. */

/* This application program is written in TURBO C 2.0 for the IBM
PC-AT compatible. The National Instruments Cooperation (NIC)
Model PC-2A board provides the interface between the PC-AT and
a PRODIGIT MPAL ELECTRONIC LOAD. The appropriate
*cib*.obj file is required in each program to properly link the NIC
board to C LANGUAGE. and include the <decl.h.> HEADER FILE
to C LANGUAGE. */

#include <stdio.h>
#include <dos.h>
#include <math.h>
#include "decl.h"      /* NI GPIB CARD HEADER FILE */

main()
{
    char ouster[20],rdbuf[15],spec[10];
    int i,ch,load;

    /* Assign unique identifier to the device "dev5" and store in
variable load. check for error. ibfind error = negative value
returned. */
    if((load = ibfind("dev5")) < 0) /* Device variable name is load
*/
    {
        /* GPIB address is 5 */
        printf("\r*** INTERFACE ERROR ! ***\a\n");
        printf("\r\nError routine to notify that ibfind failed.\n");
        printf("\r\nCheck software configuration.\n");
    }
}
```

```
    exit(1);
}
/* Clear the device */
if((ibclr(load)) & ERR);
{
    printf("INTERFACE ERROR ! \a");
    exit (1);
}
clrscr();
/* Clear load error register */
{
    outstr=chan[0];
    ibwrt(load,outstr,6);
    ibwrt(load,"CLR",3);
}

    ibwrt( load,"NAME?",5);           /* Get the AEL-5000
Series load specification */
    strset(rdbuf,'\0');             /* Clear rdbuf string
buffer */
    strset(spec,'\0');              /* Clear spec string buffer
*/
    ibrd(load,spec,20);
    if (spec[3] == '9')
        printf("\n AEL-5000 Series specification error !");
/* Set the channel 1, preset off, current sink 1.0 amps and load on
commands to the load. */
    ibwrt( load,"chan 1;pres off;curr:low 0.0;curr:high 1.0;load on ",43);
    ibwrt( load,"meas:curr ?",10);
/* Get the load actually sink current from the load */
    ibrd( load,rdbuf,20);
```

```
/* go to local. */  
  ibloc(load);  
}
```

BASICA Example Program

LOAD DECL.BAS using BASICA MERGE command.

```
100 REM You must merge this code with DECL.BAS  
105 REM  
110 REM Assign a unique identifier to the device "dev5" and store it  
in variable load%.  
125 REM  
130     udname$ = "dev5"  
140     CALL ibfind (udname$,load%)  
145 REM  
150 REM Check for error on ibfind call  
155 REM  
160     IF load% < 0 THEN GOTO 2000  
165 REM  
170 REM Clear the device  
175 REM  
180     CALL ibclr (load%)  
185 REM  
190 REM Get the 36260 load specification  
195 REM  
200     wrt$ = "NAME?" : CALL ibwrt(load%,wrt$)  
210     rd$ = space$(20) : CALL ibrd(load%,rd$)  
215 REM  
220 REM Set the preset off, current sink 1.0 amps and load on  
commands to the load.  
225 REM
```

```
230      wrt$ = "pres off;curr:low 0.0;curr:high 1.0;load on"
240      CALL ibwrt(load%,wrt$)
245 REM
250 REM Get the load actially sink current from the load
255 REM
260      wrt$ = "meas:curr?" : CALL ibwrt(load%,wrt$)
270      rd$ = space$(20) : CALL ibrd(load%,rd$)
275 REM
280 REM Go to local
285 REM
290 CALL ibloc(load%)

2000 REM Error routine to notify that ibfind failed.
2010 REM Check software configuration.
2020 PRINT "ibfind error !" : STOP
```

AEL-5000 Series USB Instruction

Background

1. Install the USB DRIVER select USB\SETUP\PL-2303 Driver Installer.exe

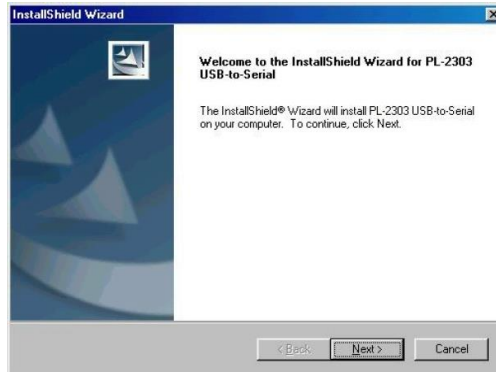

2. After the installation, connect the AEL-5000 Series and PC with USB. Then select the item USB to Serial Port (COM3), set the BAUD-RATE and Flow control to 115200bps and Hardware to control AEL-5000 Series with COM3.

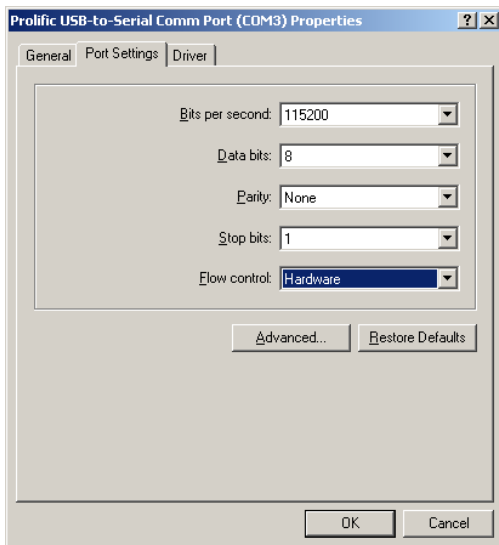
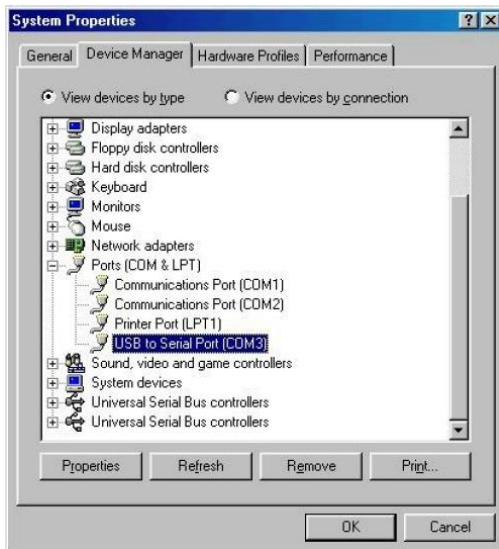

AEL-5000 series Auto, Sequence function provide EDIT, ENTER, EXIT, TEST and STORE 5 keys operation

- | | |
|-----------|--|
| Edit mode | <ol style="list-style-type: none">1. Set mode, Range, current level ... Load Setting an, Load ON.2. Press STORE key to store the load setting in memory STATE3. Repeat 1~2, for the sequence load setting.4. Press Shift + SEQ. key of AEL-5000 Series front panel.5. Press up/down key to select Edit Mode.6. Press 1~9 number key program number.7. Press STATE up/down key to select memory state.8. Press ENTER to next step.9. Repeat 6~8 to edit Step of sequence10. Press SAVE to confirm the step11. LCD shows "rept" to setting repeat count.12. Press up/down key to set repeat count of sequence loop.13. Press ENTER to confirm the sequence edit. |
| Test mode | <ol style="list-style-type: none">1. Press Shift + SEQ. key of AEL-5000 Series front panel.2. Press up/down key to select Test Mode.3. Press 1~9 number to select sequence number4. Press ENTER to execution the sequence5. The LCD shows "PASS" or "FAIL" after testing. |

AUTO SEQUENCE:

AUTO SEQUENCE SET COMMAND	NOTE	RETURN
FILE {SP} {n} { ; NL }	n=1~9	1~9
STEP {SP} {n} { ; NL }	n=1~16	1~16
TOTSTEP {SP} {n} { ; NL }	Total step n=1~16	1~16
SB {SP} {m} { ; NL }	m=1~150 m:STATE	
TIME {SP} {NR2} { ; NL }	100~9999(ms)	100~9999(ms)
SAVE { ; NL }	Save "File n" data	
REPEAT {SP} {n} { ; NL }	n=0~9999	0~9999
RUN {SP} {F} {n} { ; NL }	N=1~9	AUTO REPLY "PASS" or "FAIL:XX" (XX=NG STEP)

Example Sequence

In this example, we will create a program based on following Figure.

The program repeats steps 1 to 8 two times. After repeating the sequence two times, the load is turned off and the sequence ends.

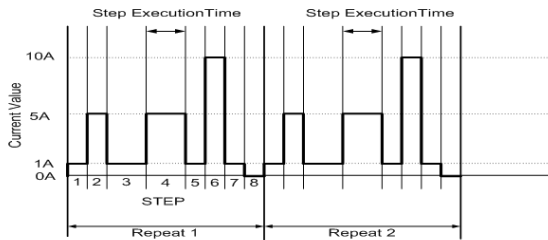

Sequence Number	Step Number	Current Value	Execution Time(T1+T2)
3	1	1A	200mS

3	2	5A	200mS
3	3	1A	400mS
3	4	5A	400mS
3	5	1A	200mS
3	6	10A	200mS
3	7	1A	200mS
3	8	0A	200mS

Example
Sequence

1. Setting the Load current level and store to state 1~8
2. Set the operation mode
Press the mode key to CC mode.
3. Set the range
Press RANGE key to force range 2
4. Press Load ON
5. Set the current value as step 1~8 and store to memory state 1~8
6. Press EDIT key of AEL-5000 Series mainframe
7. Press up/down key to select Edit Mode
8. Press sequence number 3 to edit the sequence.
9. Press up/down key to memory state 1
10. Press ENTER key to confirm the sequence memory
11. Press up/down key to setting execution time
12. Press ENTER key to confirm the sequence step
13. Repeat 8~12 to setting step 1~8
14. Press SAVE key to confirm step 1~8
15. Press up/down key to 1 to repeat one times.
16. Press ENTER to confirm the repeat count.

Testing Waveform



AEL-5000 Series LAN Instruction

Background

1. Connecting AC power and the network line to the AEL-5000 Series mainframe, connect the other Side of the network line to the HUB.
2. Run the ETM.EXE which bellows the path of the LAN on the CDROM drive, it will show as fig below. If not , please press F5 to search again, or check the first step was succeed or not.

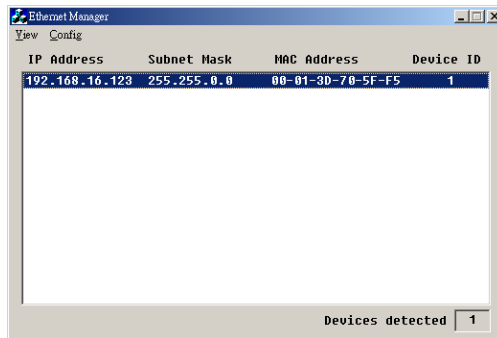

3. It will be shown the installation which has been searched on the screen , click it and select the Set IP Address bellows Config :



4. Set a useful IP Address and Subnet Mask.
5. It will be shown the Setup Device as the following figure if all steps was corrected to be run.

Controller Setup	
IP address	192.168.16.128
Subnet mask	255.255.255.0
Gateway address	0.0.0.0
Network link speed	Auto
DHCP client	Enable
Socket port of HTTP setup	80
Socket port of serial I/O	4001 TCP Server
Socket port of digital I/O	5001 TCP Server
Destination IP address / socket port (TCP client and UDP) Connection	0.0.0.0 0 Auto
TCP socket inactive timeout (minutes)	0
Serial I/O settings (baud rate, parity, data bits, stop bits)	115200 N 8 1
Interface of serial I/O	RS 232 (RTS/CTS)
Packet mode of serial input	Disable
Device ID	1
Report device ID when connected	Disable
Setup password	
Update	

6. Insert the numbers as the following :
 - IP Address: as recommended according to your network
 - A. Subnet Mask: as recommended according to your network
 - B. Gateway Address: as recommended according to your network
 - C. Network link speed: Auto
 - D. DHCP client: Enable
 - E. Socket port of HTTP setup: 80
 - F. Socket port of serial I/O: 4001 , TCP Server
 - G. Socket port of digital I/O: 5001 , TCP Server
 - H. Destination IP address / socket port (TCP client and UDP) Connection: Auto
 - I. TCP socket inactive timeout(minutes) : Set the network disconnection after N minutes, set 0 minutes will work forever.
 - J. Serial I/O settings (baud rate, parity, data, bits, stop bits): 115200, N, 8, 1
 - K. Interface of serial I/O: RS 232 (RTS/CTS)

- L. Packet mode of serial input: Disable
- M. Device ID : 5
- N. Report device ID when connected : Auto
- O. Setup password: Not required