

# DC Electronic Load

PEL-3000(H)

---

## PROGRAMMING MANUAL

VERSION: 1.11



ISO-9001 CERTIFIED MANUFACTURER

**GW INSTEK**

This manual contains proprietary information, which is protected by copyright. All rights are reserved. No part of this manual may be photocopied, reproduced or translated to another language without prior written consent of Good Will company.

The information in this manual was correct at the time of printing. However, Good Will continues to improve products and reserves the rights to change specification, equipment, and maintenance procedures at any time without notice.

**Good Will Instrument Co., Ltd.**  
**No. 7-1, Jhongsing Rd., Tucheng Dist., New Taipei City 236, Taiwan.**

# Table of Contents

<b>I</b> INTERFACE OVERVIEW .....	<b>2</b>
Appearance .....	3
Interface Configuration .....	9
<b>C</b> COMMAND OVERVIEW .....	<b>18</b>
Command Syntax .....	19
Command List .....	24
Status Register Overview .....	203
Error Messages .....	215

# INTERFACE OVERVIEW

This chapter describes basic configuration of IEEE488.2 based remote control.

---

Appearance .....	3
Front Panel .....	3
PEL-3021/ PEL-3041 .....	3
PEL-3021H/ PEL-3041H .....	3
PEL-3111 .....	4
PEL-3111H .....	5
PEL-3211(H) Booster Pack .....	5
Rear Panel .....	6
PEL-3021/ PEL-3041 .....	6
PEL-3021H/ PEL-3041H .....	7
PEL-3111 .....	7
PEL-3111H .....	8
PEL-3211 Booster Pack .....	8
PEL-3211H Booster Pack .....	8
Interface Configuration .....	9
Configure to USB Remote Interface .....	9
Configure GPIB Interface .....	9
Configure RS232C .....	10
RS232C/USB Remote Control Function Check .....	11
Using Realterm to Establish a Remote Connection .....	12
GPIB Function Check .....	15

# Appearance

## Front Panel

PEL-3021/ PEL-3041

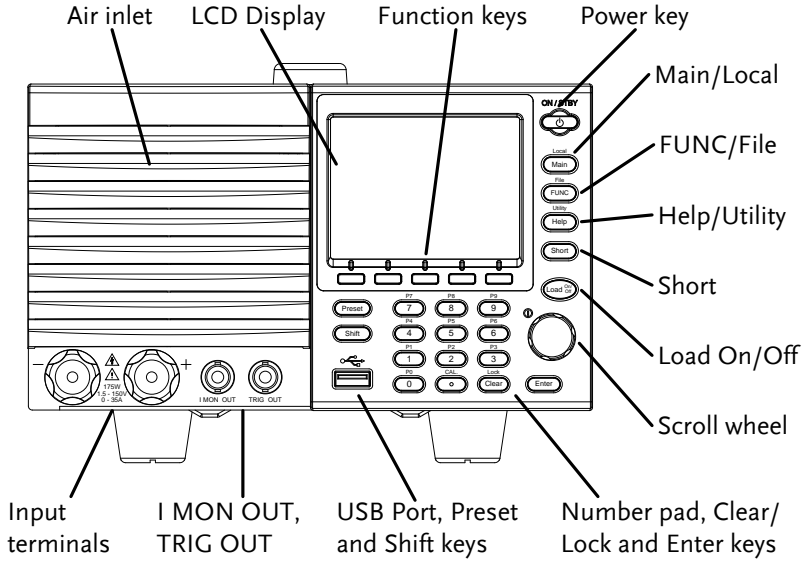

PEL-3021H/ PEL-3041H

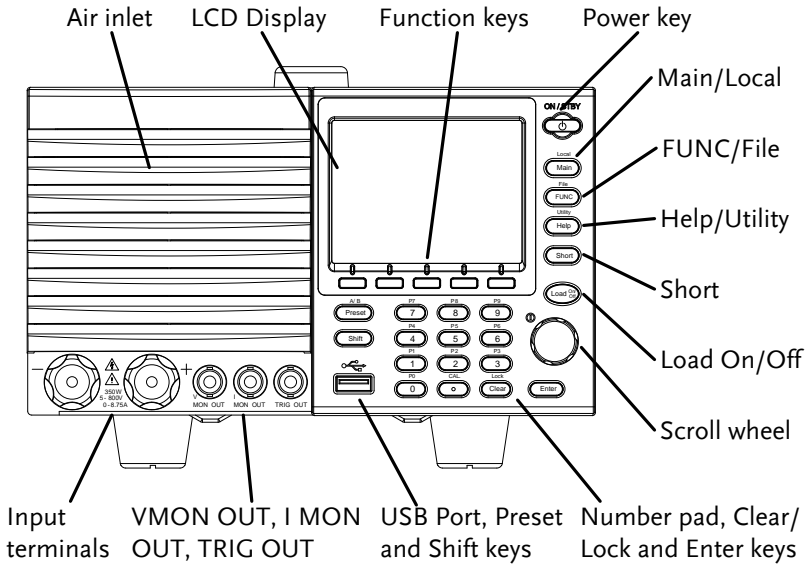

**PEL-3111**

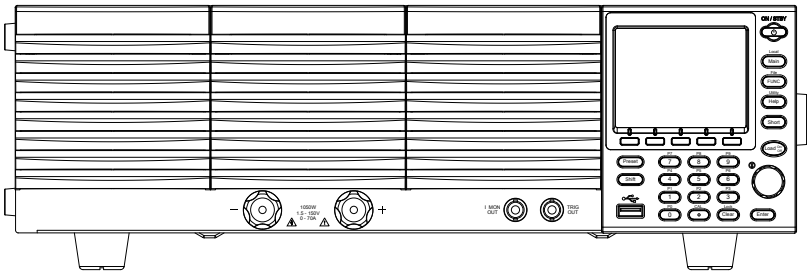

PEL-3111H

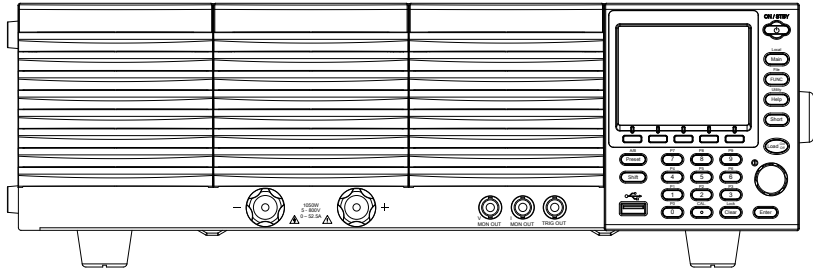

PEL-3211 (H) Booster Pack

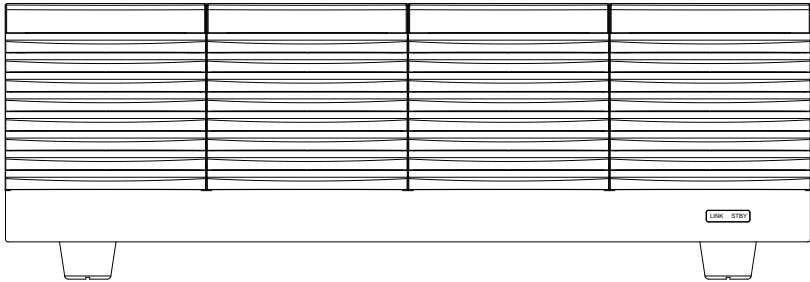

Rear Panel

PEL-3021/ PEL-3041

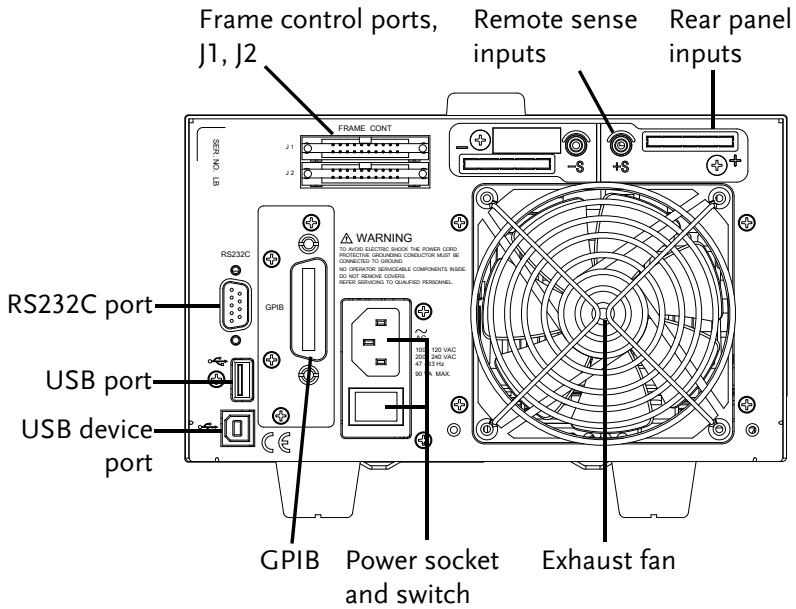



PEL-3021H/ PEL-3041H

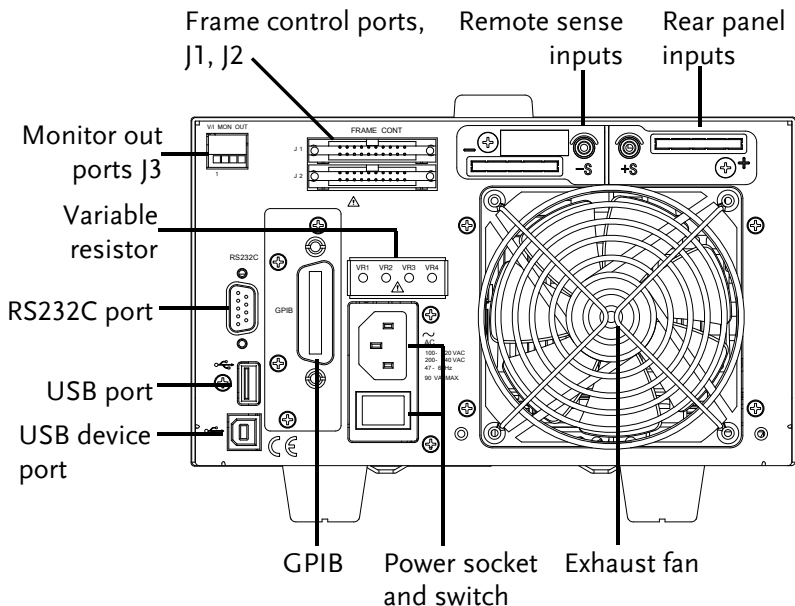

PEL-3111

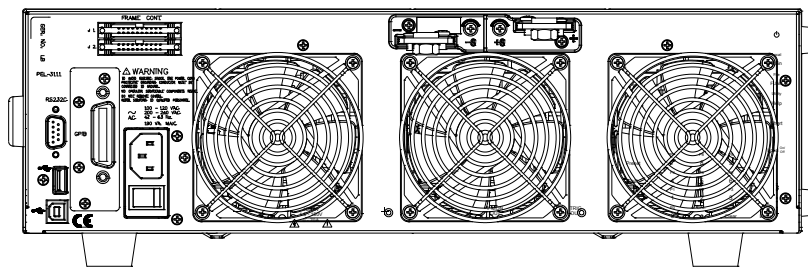

**PEL-3111H**

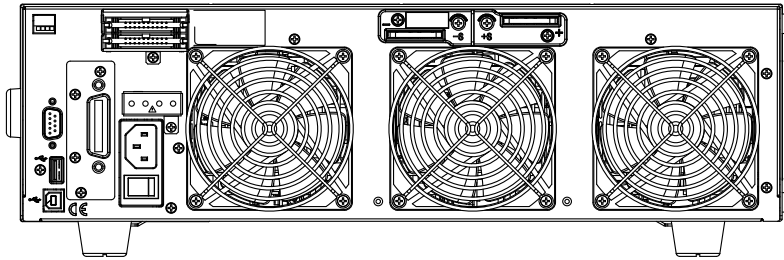

**PEL-3211 Booster Pack**

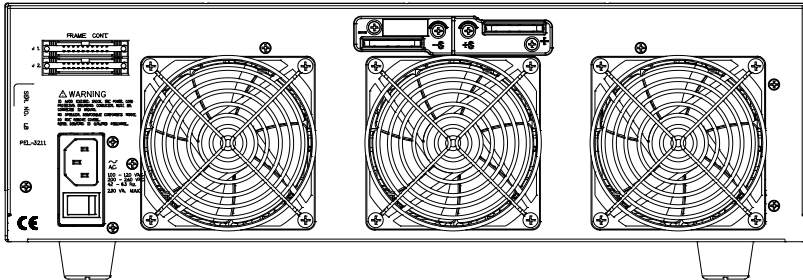

**PEL-3211H Booster Pack**

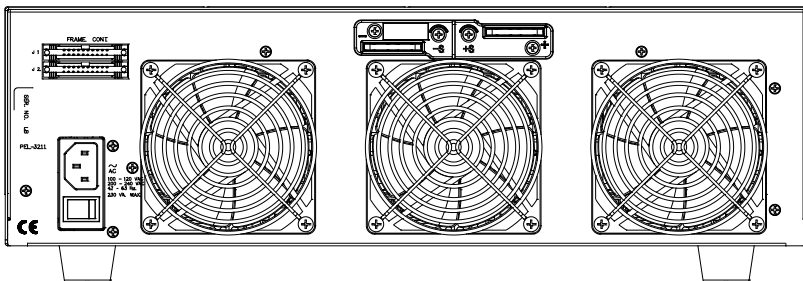

## Interface Configuration

### Configure to USB Remote Interface



---

USB configuration	PC side connector	Type A, host
	PEL-3000(H) side connector	Rear panel Type B, slave
	Speed	2.0 (full speed)
	USB Class	USB CDC ACM

---

 Note	Before USB can be used for remote control, it is necessary to install the PEL-3000(H) USB device driver, located on the accompanying User Manual CD.
--	--



---

Operation	1. Connect the USB cable to the rear panel USB B port.
	2. Press  +  > <i>Interface[F3]</i> and set the <i>Interface</i> setting to <i>USB</i> .

### Configure GPIB Interface

To use GPIB, the optional GPIB port must be installed.

---

Operation	1. Ensure the PEL-3000(H) is off before proceeding.
	2. Connect a GPIB cable from a GPIB controller to the GPIB port on the PEL-3000(H).
	3. Turn the PEL-3000(H) on.
	4. Press  +  > <i>Interface[F3]</i> and set the <i>Interface</i> setting to <i>GPIB</i> .
	5. Set the GPIB address.

---

GPIB address	0-30
--------------	------

- GPIB constraints
- *Maximum 15 devices altogether, 20m cable length, 2m between each device*
  - *Unique address assigned to each device*
  - *At least 2/3 of the devices turned On*
  - *No loop or parallel connection*

Pin Assignment



Pin	Signal	Pin	Signal
1-4	Data I/O 1-4	13-16	Data I/O 5-8
5	EOI	17	REN
6	DAV	18	Ground (DAV)
7	NRFD	19	Ground (NRFD)
8	NDAC	20	Ground (NDAC)
9	IFC	21	Ground (IFC)
10	SRQ	22	Ground (SRQ)
11	ATN	23	Ground (ATN)
12	SHIELD Ground	24	Single GND

## Configure RS232C

RS232C Configuration	Connector	DB-9, Male
	Baud Rate	2400, 4800, 9600, 19200, 38400
	Stop Bit	1, 2
	Parity	None, Odd, Even

Operation

1. Connect an RS232C cable from the PC to the rear panel RS232 port.
2. Press **Shift** + **Utility Help** > *Interface*[F3] and set the *Interface* setting to RS232.
3. Set the *Baud Rate*, *Stop Bit* and *Parity* settings.

Pin Assignment

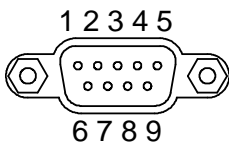

- 2: RxD (Receive data)
- 3: TxD (Transmit data)
- 5: GND
- 4, 6 - 9: No connection

PC Connection

Use a null modem connection as shown in the diagram below.

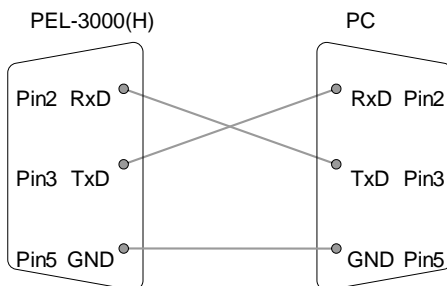

## RS232C/USB Remote Control Function Check

Functionality check

Invoke a terminal application such as Realterm.  
 For RS-232C, set the COM port, baud rate, stop bit, data bit and parity accordingly.  
 To check the COM settings in Windows, see the Device Manager. For example, in WinXP go to the Control panel → System → Hardware tab.

 Note

If you are not familiar with using a terminal application to send/receive remote commands from the serial port or via a USB connection, please page 12 (Using Realterm to Establish a Remote Connection) for more information.

Run this query command via the terminal after the instrument has been configured for RS-232/USB remote control

\*idn?

This should return the Manufacturer, Model number, Serial number, and Firmware version in

the following format.

- *GW-INSTEK, PEL-3000(H), XXXXXXXXXXXXX, V.X.X.X.X*

Manufacturer: GW-INSTEK

Model number : PEL-3000(H)

Serial number : XXXXXXXXXXXXX

Firmware version : V.X.X.X

---



Note

For further details, please see the programming manual, available on the GW Instek web site @ [www.gwinstek.com](http://www.gwinstek.com).

---

## Using Realterm to Establish a Remote Connection

---

### Background

Realterm is a terminal program that can be used to communicate with a device attached to the serial port of a PC or via an emulated serial port via USB.

The following instructions apply to version 1.99.0.27. Even though Realterm is used as an example to establish a remote connection, any terminal program can be used that has similar functionality.

---



Note

Realterm can be downloaded on Sourceforge.net free of charge.

For more information please see <http://realterm.sourceforge.net/>

---

### Operation

1. Download Realterm and install according to the instructions on the Realterm website.
2. Connect the PEL-3000(H) via USB (page 9) or via RS232 (page 10).
3. If using RS232, make note of the configured baud rate, stop bits and parity.
4. Go to the Windows device manager and find the COM port number for the connection. For example, go to the Start menu > Control

## Panel &gt; Device Manager

Double click the *Ports* icon to reveal the connected serial port devices and the COM port for the each connected device.

If using USB, the baud rate, stop bit and parity settings can be viewed by right-clicking connected device and selecting the *Properties* option.

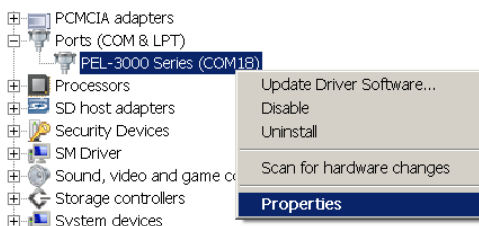

5. Start Realterm on the PC as an administrator.

Click:

Start menu>All Programs>RealTerm>realterm

Tip: to run as an administrator, you can right click the Realterm icon in the Windows Start menu and select the *Run as Administrator* option.

6. After Realterm has started, click on the *Port* tab.

Enter the *Baud*, *Parity*, *Data bits*, *Stop bits* and *Port* number configuration for the connection.

The *Hardware Flow Control*, *Software Flow Control* options can be left at the default settings.

7. Press *Open* to connect to the PEL-3000(H).

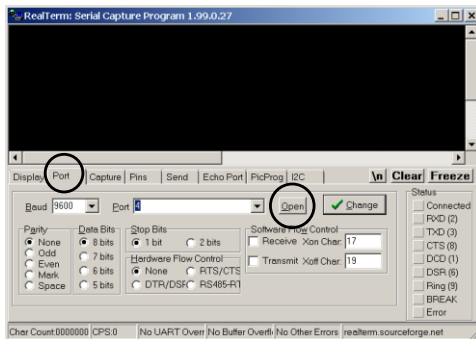

8. Click on the *Send* tab.

In the *EOL* configuration, check on the +*CR* and +*LF* check boxes.

Enter the query:

*\*idn?*

Click on *Send ASCII*.

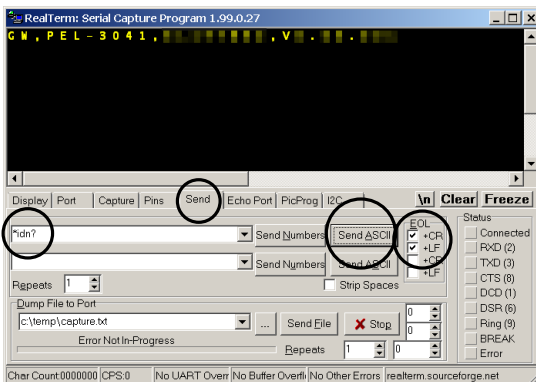

9. The terminal display will return the following:

GW, PEL-3XXX(H),EXXXXXXX,VX.XX.XXX

(manufacturer, model, serial number, version)

10. If Realterm fails to connect to the PEL-3000(H), please check all the cables and settings and try again.



## GPIB Function Check

---

Functionality check      Please use the National Instruments Measurement & Automation Controller software to confirm GPIB functionality.

See the National Instrument website,  
<http://www.ni.com> for details.



Note

For further details, please see the programming manual, available on the GW Instek web site @ [www.gwinstek.com](http://www.gwinstek.com).

---

Operation

1. Start the NI Measurement and Automation Explorer (MAX) program. Using Windows, press:



Start>All Programs>National Instruments>Measurement & Automation



2. From the Configuration panel access;  
My System>Devices and Interfaces>GPIB0
3. Press the Scan for Instruments button.

4. In the *Connected Instruments* panel the PEL-3000(H) should be detected as *Instrument 0* with the address the same as that configured on the PEL-3000(H).
5. Double click the *Instrument 0* icon.

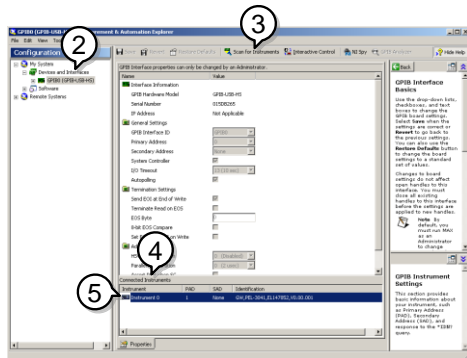

6. Click on *Communicate with Instrument*.
7. In the *NI-488.2 Communicator* window, ensure *\*IDN?* is written in the *Send String:* text box. Click on the *Query* button to send the *\*IDN?* query to the instrument.
8. The *String Received* text box will display the query return:  
 GW, PEL-3XXX(H),EXXXXXXX,VX.XX.XXX  
 (manufacturer, model, serial number, version)



# C COMMAND OVERVIEW

The Command overview chapter lists all PEL-3000(H) commands in functional order as well as alphabetical order. The command syntax section shows you the basic syntax rules you have to apply when using commands.

---

Command Syntax .....	19
Command List .....	24
Status Register Overview .....	203
Introduction to the Status Registers.....	203
Configuration in the Status register.....	204
Csummary Status Register Group .....	205
Operation Byte Register Group .....	207
Questionable Status Register Group.....	208
Standard Event Status Register Group .....	210
Status Byte Register Group.....	212
Error Messages .....	215

## Command Syntax

Compatible Standard	IEEE488.2	Partial compatibility
	SCPI, 1999	Partial compatibility

**Command Structure** SCPI (Standard Commands for Programmable Instruments) commands follow a tree-like structure, organized into nodes. Each level of the command tree is a node. Each keyword in a SCPI command represents each node in the command tree. Each keyword (node) of a SCPI command is separated by a colon (:).

For example, the diagram below shows an SCPI sub-structure and a command example.

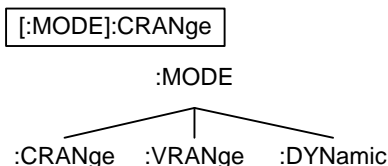

**Command types** There are a number of different instrument commands and queries. A command sends instructions or data to the unit and a query receives data or status information from the unit.

### Command types

**Simple** A single command with/without a parameter

**Example** :CONFigure:SHORT HOLD

**Query**                      A query is a simple or compound command followed by a question mark (?). A parameter (data) is returned.

**Example**                    :CONFigure:SHORT?

**Compound**                Two or more commands on the same command line. Compound commands are separated with either a semi-colon (;) or a semi-colon and a colon (;:).

A semi-colon is used to join two related commands, with the caveat that the last command must begin at the last node of the first command.

A semi-colon and colon are used to combine two commands from different nodes.

**Example**                    CONFigure:VON  
MAX;:CONFigure:VDElay MIN

**Command Forms**        Commands and queries have two different forms, long and short. The command syntax is written with the short form of the command in capitals and the remainder (long form) in lower case.

The commands can be written in capitals or lower-case, just so long as the short or long forms are complete. An incomplete command will not be recognized.

Below are examples of correctly written commands.

Long form :CURRent:LEVel?  
 :CURRENT:LEVEL?  
 :current:level?

Short form :CURR:LEV?  
 :curr:lev?

**Square Brackets** Commands that contain square brackets indicate that the contents are optional. The function of the command is the same with or without the square bracketed items, as shown below

For example for the query:  
 “[:CONFIgure]:GNG [:PASS]?”

Both “:CONFIgure:GNG:PASS?” and “:GNG?” are both valid forms.

**Command Format**

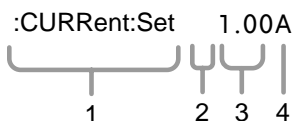

- 1. Command header
- 2. Space
- 3. Parameter 1
- 4. Unit or suffix.

Common Unit Parameters	Type	Description	Example
	<Boolean>	boolean logic	0, 1
	<NR1>	integers	0, 1, 2, 3
	<NR2>	decimal numbers	0.1, 3.14, 8.5
	<NR3>	floating point	4.5e-1, 8.25e+1
	<NRf>	any of NR1, 2, 3	1, 1.5, 4.5e-1

[MIN] (Optional parameter) For commands, this will set the setting to the lowest value. This parameter can be used in place of any numerical parameter where indicated.

For queries, it will return the lowest possible value allowed for the particular setting.

[MAX] (Optional parameter) For commands, this will set the setting to the highest value. This parameter can be used in place of any numerical parameter where indicated.

For queries, it will return the highest possible value allowed for the particular setting.

Unit Suffixes (Optional parameters) Unit suffixes can be optionally used with most NRf type input parameters.

[A] Amps 1.00A

[%] Percentage 10%

[V] Volts 5.00V

[W] Watts 3.00W

[ms] milliseconds 20ms

[mV] Millivolts 150mV

[s] Seconds 5s

[mS] Reciprocal of 1000 ohms 20mS

[OHM] Ohm 50OHM

[mA/us] Millamps/microsecond 100mA/us

[Hz] Hertz 1000Hz



Note: For [OHM] return values, an infinite resistance (open) will be returned as 9.9e<sup>37</sup>.

---

Message Terminator	LF	Line feed code (0x0A)
--------------------	----	-----------------------

---

## Command List

Common Commands	*CLS .....	32
	*ESE .....	32
	*ESR .....	33
	*IDN .....	33
	*OPC .....	34
	*RCL .....	34
	*RST .....	35
	*SAV .....	35
	*SRE .....	35
	*STB .....	36
	*TRG .....	36
	*TST .....	37

Trigger Commands	:ABORt .....	38
	:INPut[:STATe]:TRIGgered .....	39
	:INITiate[:IMMediate] .....	39
	:INITiate:CONTInuous .....	40
	:TRIGger[:DELay]:TIME .....	40
	:TRIGger[:PULSe]:WIDTh .....	41

Input Commands	:INPut .....	42
	:INPut:MODE .....	42
	[:INPut]:SHORT .....	43

Measurement Commands	:MEASure:CURRent .....	44
	:MEASure:ETIME .....	44
	:MEASure:POWer .....	44
	:MEASure:VOLTage .....	45

Fetch Subsystem Commands	:FETCh:CURRent .....	46
	:FETCh:POWer .....	46
	:FETCh:VOLTage .....	46

Configure Subsystem Commands	[:CONFigure]:OCP.....	48
	[:CONFigure]:OPP.....	49
	[:CONFigure]:UVP.....	50
	[:CONFigure]:UVP:TIME.....	50
	[:CONFigure]:OVP.....	51
	[:CONFigure]:SStart.....	52
	[:CONFigure]:VON.....	52
	[:CONFigure]:VDElay.....	53
	:CONFigure:RESPonse.....	54
	[:CONFigure]:CNTime.....	54
	[:CONFigure]:COTime.....	55
	[:CONFigure]:CRUnit.....	55
	:CONFigure:DYNamic.....	56
	:CONFigure:MEMory.....	56
	:CONFigure:SHORt.....	57
	:CONFigure:SHORt:SAFety.....	58
	:CONFigure:SHORt:FUNCTion.....	58
	[:CONFigure]:GNG:MODE.....	59
	[:CONFigure]:GNG:H.....	60
	[:CONFigure]:GNG:L.....	60
	[:CONFigure]:GNG:C.....	61
	[:CONFigure]:GNG:DTIME.....	62
	[:CONFigure]:GNG:SPEctest.....	62
	[:CONFigure]:GNG[:PASS].....	63
<hr/>		
Parallel Command	[:CONFigure]:PARAllel.....	64
<hr/>		
Step Resolution Commands	:CONFigure:STATus.....	65
	[:CONFigure]:STEP:CC.....	66
	[:CONFigure]:STEP:CCH.....	66
	[:CONFigure]:STEP:CCM.....	67
	[:CONFigure]:STEP:CCL.....	67
	[:CONFigure]:STEP:CR.....	68
	[:CONFigure]:STEP:CRH.....	68
	[:CONFigure]:STEP:CRM.....	69
	[:CONFigure]:STEP:CRL.....	70
	[:CONFigure]:STEP:CV.....	70
	[:CONFigure]:STEP:CVH.....	71
	[:CONFigure]:STEP:CVL.....	71
	[:CONFigure]:STEP:CP.....	72

	[:CONFigure]:STEP:CPH .....	72
	[:CONFigure]:STEP:CPM.....	73
	[:CONFigure]:STEP:CPL .....	74
<hr/>		
External Control	[:CONFigure]:EXTernal[:CONTRol].....	75
Commands	[:CONFigure]:EXTernal:CV .....	75
	[:CONFigure]:EXTernal:LOADonin .....	76
<hr/>		
Mode Subsystem	:MODE .....	77
Commands	[:MODE]:CRANge .....	77
	[:MODE]:VRANge.....	78
	[:MODE]:RESPonse .....	78
	[:MODE]:DYNamic .....	79
<hr/>		
Current	:CURRent[:VA] .....	80
Subsystem	:CURRent[:VA]:TRIGgered .....	81
Commands	:CURRent:VB .....	81
	:CURRent:SRATe .....	82
	:CURRent:L1 .....	82
	:CURRent:L2.....	83
	:CURRent:SET .....	84
	:CURRent:LEVel.....	84
	:CURRent:RISE.....	85
	:CURRent:FALL .....	86
	:CURRent:T1 .....	86
	:CURRent:T2 .....	87
	:CURRent:FREQUency .....	88
	:CURRent:DUTY.....	88
	:CURRent:RECall.....	89
<hr/>		
Resistance	:RESistance[:VA] .....	90
Subsystem	:RESistance[:VA]:TRIGgered .....	91
Commands	:RESistance:VB .....	91
	:RESistance:SRATe.....	92
	:RESistance:L1 .....	93
	:RESistance:L2.....	93
	:RESistance:SET.....	94
	:RESistance:LEVel .....	95
	:RESistance:RISE .....	95
	:RESistance:FALL.....	96

:RESistance:T1.....	97
:RESistance:T2.....	97
:RESistance:FREQuency.....	98
:RESistance:DUTY.....	99
:CONductance[:VA].....	99
:CONductance[:VA]:TRIGgered.....	100
:CONductance:VB.....	100
:CONductance:L1.....	101
:CONductance:L2.....	102
:CONductance:SET.....	103
:CONductance:RECall.....	103
:RESistance:RECall.....	104

Voltage	:VOLTage[:VA].....	105
Subsystem	:VOLTage:VB.....	105
Commands	:VOLTage:RECall.....	106

Power Subsystem	:POWER[:VA].....	107
Commands	:POWER:VB.....	108
	:POWER:L1.....	108
	:POWER:L2.....	109
	:POWER:SET.....	110
	:POWER:LEVel.....	110
	:POWER:T1.....	111
	:POWER:T2.....	112
	:POWER:FREQuency.....	112
	:POWER:DUTY.....	113
	:POWER:RECall.....	114

Program	:FUNction[:COMplete][:RING]:TIME.....	115
Commands	:PROGram:STATe.....	116
	:PROGram.....	117
	:PROGram[:RECall]:DEFault.....	118
	:PROGram:STARt.....	118
	:PROGram:STEP.....	119
	:PROGram:MEMory.....	119
	:PROGram:RUN.....	120
	:PROGram:ONTime.....	120
	:PROGram:OFFTime.....	121
	:PROGram:PFTime.....	121
	:PROGram:STIME.....	122

[:PROGram]:CHAI:n:STARt .....	123
[:PROGram]:CHAI:n .....	123
[:PROGram]:CHAI:n:P2P .....	124
[:PROGram]:CHAI:n[:RECall]:DEFault .....	125
:PROGram:SAVE .....	125

Normal sequence	:NSEquence:STATe .....	126
Commands	:NSEquence .....	127
	:NSEquence:STARt .....	129
	:NSEquence:NUMBER .....	130
	:NSEquence:MEMO .....	130
	:NSEquence:MODE .....	131
	:NSEquence:RANGe .....	131
	:NSEquence:LOOP .....	132
	:NSEquence:LLOAD .....	133
	:NSEquence:LAST .....	133
	:NSEquence:CHAI:n .....	134
	:NSEquence:EDIT .....	134
	:NSEquence:EDIT:POINT .....	136
	:NSEquence:EDIT:END .....	136
	:NSEquence[:DELet]:ALL .....	136
	:NSEquence:SAVE .....	137
	:NSEquence:COTime .....	137

Fast sequence	:FSEquence:STATe .....	138
Commands	:FSEquence .....	139
	:FSEquence:MEMO .....	140
	:FSEquence:MODE .....	141
	:FSEquence:RANGe .....	141
	:FSEquence:LOOP .....	142
	:FSEquence:TBASE .....	143
	:FSEquence:LLOAD .....	143
	:FSEquence:LAST .....	144
	:FSEquence:RPTStep .....	144
	:FSEquence:EDIT .....	145
	:FSEquence:EDIT:POINT .....	146
	:FSEquence:EDIT:END .....	146
	:FSEquence[:DELet]:ALL .....	146
	:FSEquence[:EDIT]:FILL .....	147
	:FSEquence:SAVE .....	147

OCP test	:OCP:STATe.....	149
Commands	:OCP:EDIT[:CHANnel].....	150
	:OCP[:CHANnel]:NUMBer.....	151
	:OCP:MEMO.....	151
	:OCP[:CHANnel]:RANGe.....	152
	:OCP[:CHANnel]:STARt.....	152
	:OCP[:CHANnel]:END.....	153
	:OCP[:CHANnel]:STEP:CURRent.....	153
	:OCP[:CHANnel]:STEP:TIME.....	154
	:OCP[:CHANnel]:DELay.....	154
	:OCP[:CHANnel]:TRIGger.....	155
	:OCP[:CHANnel]:LAST.....	155
	:OCP:CHANnel:STATus.....	156
	:OCP:RESult.....	156
	:OCP:RUN.....	157

OPP test	:OPP:STATe.....	158
Command	:OPP:EDIT[:CHANnel].....	159
	:OPP[:CHANnel]:NUMBer.....	160
	:OPP:MEMO.....	160
	:OPP[:CHANnel]:RANGe.....	161
	:OPP[:CHANnel]:STARt.....	161
	:OPP[:CHANnel]:END.....	162
	:OPP[:CHANnel]:STEP:WATT.....	163
	:OPP[:CHANnel]:STEP:TIME.....	163
	:OPP[:CHANnel]:DELay.....	164
	:OPP[:CHANnel]:TRIGger.....	164
	:OPP[:CHANnel]:LAST.....	165
	:OPP:CHANnel:STATus.....	166
	:OPP:RESult.....	166
	:OPP:RUN.....	166

BATT test Command	:BATTery:STATe.....	167
	:BATT:EDIT.....	168
	:BATTery [:CHANnel]:NUMBer.....	169
	:BATTery:MEMO.....	170
	:BATTery:MODE.....	170
	:BATTery:RANGe.....	171
	:BATTery:VALue.....	171
	:BATTery:RISE.....	172
	:BATTery:FALL.....	172

:BATTery:STOP:VOLTage.....	173
:BATTery:STOP:TIME .....	174
:BATTery:STOP:AH .....	174
:BATTery:DATAlog:TIMer .....	175
:BATT:CHANnel:STATus .....	175
:BATT:RESult.....	176
:BATT:RUN.....	176

Utility Commands	:UTILity:SYSTem.....	177
	:UTILity:LOAD .....	178
	:UTILity:LOAD:MODE .....	178
	:UTILity:LOAD:RANGe .....	179
	:UTILity:TIME .....	179
	:UTILity:KNOB.....	180
	:UTILity:SPEAKER.....	181
	:UTILity:ALARm.....	181
	:UTILity:UNReg.....	182
	:UTILity:GNG .....	183
	:UTILity:CONTrast.....	183
	:UTILity:BRIGhtness.....	184
	:UTILity:LANGUage .....	184
	:UTILity:REMote.....	185
	:UTILity:REMote:MODE.....	185

Interface	:UTILity:INTerface.....	186
Commands	:UTILity:BRATe.....	186
	:UTILity:SBIT .....	187
	:UTILity:PARity .....	187

File Commands	:MEMory:SAVE .....	189
	:MEMory:RECall.....	189
	:PREset:SAVE .....	190
	:PREset:RECall.....	190
	:SETup:SAVE .....	190
	:SETup:RECall.....	190
	:FACTory[:RECall] .....	191
	:USER[:DEFault]:SAVE .....	191
	:USER[:DEFault]:RECall.....	191



---

SCPI Status	:SYSTem:ERRor .....	192
Commands	:STATus:PRESet .....	192

---

Csummary Status	:STATus:CSUMmary:CONDition .....	194
Commands	:STATus:CSUMmary:ENABle .....	194
	:STATus:CSUMmary[:EVENT] .....	195
	:STATus:CSUMmary:NTRansition .....	195
	:STATus:CSUMmary:PTRansition .....	195

---

Operation Status	:STATus:QUESTionable:CONDition .....	200
Commands	:STATus:QUESTionable:ENABle .....	200
	:STATus:QUESTionable[:EVENT] .....	201
	:STATus:QUESTionable:NTRansition .....	201
	:STATus:QUESTionable:PTRansition .....	201

---

Questionable Status	:STATus:QUESTionable:CONDition .....	200
Commands	:STATus:QUESTionable:ENABle .....	200
	:STATus:QUESTionable[:EVENT] .....	201
	:STATus:QUESTionable:NTRansition .....	201
	:STATus:QUESTionable:PTRansition .....	201

## Common Commands

*CLS .....	32
*ESE .....	32
*ESR .....	33
*IDN .....	33
*OPC .....	34
*RCL .....	34
*RST .....	35
*SAV .....	35
*SRE .....	35
*STB .....	36
*TRG .....	36
*TST .....	37

### \*CLS



Description	Clears all Event registers and queues.
Syntax	*CLS
Example	*CLS Clears all Event registers and queues.

### \*ESE

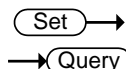

Description	Queries or sets the Standard Event Status Enable register. The Standard Event Status Enable register determines which events can set the Event Summary bit (ESB) in the Status Byte Register. Any bits that are set to 1 enable the corresponding event. Each event is represented by a bit in the Standard Event Status Enable register.  Refer to section “ <b>Standard Event Status register group</b> ” on page 210 for more information on bit.
Syntax	*ESE <NRF>
Query Syntax	*ESE?

Parameter	<NR1> 1	Sets the Standard Event Status Enable register.
Return parameter	Return in "<NR1>" the set value of the Standard Event Status Enable register.	
Example	*ESE 8	Sets bit 3 of the ESE register.
Query example	*ESE? >12	Bits 2 and 3 are set in the Standard Event Status Enable register.

## \*ESR

→ Query

Description	Reads the Standard Event Status register. This command will also clear the Standard Event Status register.  Refer to section " <b>Standard Event Status register group</b> " on page 210 for more information on bit.
Query Syntax	*ESR?
Return parameter	Return in "<NR1>" the set value of the Standard Event Status register.
Query example	*ESR? >48  Bits 5 and 6 are set in the Standard Event register.

## \*IDN

→ Query

Description	Queries the manufacturer, model number, serial number, and firmware version of the instrument.
Query Syntax	*IDN?

Return parameter	<string>	Returns the manufacturer name.
	<string>	Returns the model number.
	<NR1>	Returns the serial number.
	<string>	Returns the version of firmware

Query example \* IDN?  
 > GWInstek, PEL-3111H,12345678,V1.01.001  
 It is a response equipment manufacturer, model number, serial number, and firmware version.

Set →

**\*OPC**

→ Query

**Description** This command sets the OPC (Operation Command Bit) bit (bit 0) of the Standard Event Status Register after the instrument has completed all pending operations. The query will return the status of the OPC bit.

**Syntax** \*OPC

**Query Syntax** \*OPC?

**Return parameter** 1 Operation complete

**Example** \*OPC

**Query Example** \*OPC?  
 >1  
 Indicates that all pending operations are complete.

**\*RCL**

Set →

**Description** The Recall Instrument State command restores the instrument settings from a previously saved memory setting.

**Syntax** \*RCL <NR1>

**Parameter** <NR1> Memory number 1 to 256

**Example** \*RCL 20  
 Recall setting memory 20.

Same function command :MEMory:RECall

**\*RST**

Set →

Description Resets the unit. This is command forces the ABORt, and \*CLS

Syntax \*RST

Example \*RST  
Resets the unit.

**\*SAV**

Set →

Description The Save Instrument State command saves the instrument settings to one of the memory setting slots.

Syntax \*SAV <NR1>

Parameter <NR1> Memory number 1 to 256

Example \*SAV 20  
Saves the current setting to memory 20.

Same function command :MEMory:SAVe

**\*SRE**

Set →

→ Query

Description Queries or sets the Service Request Enable register. The Service Request Enable register determines which events in the Status Byte register can set the Master Summary bit (MSB) in the Status Byte Register. Any bits that are set to 1 will cause the MSS bit to be set.  
  
Refer to section “**Status byte register group**” on page 212 for more information on bit.

Syntax \*SRE <NRf>

Query Syntax	*SRE?	
Parameter	<NR1>	Sets the set value of the Service Request Enable register.
Return parameter	Return in "<NR1>" the set value of the Service Request Enable register.	
Example	*SRE 8	Sets bit 3 of the Service Request Enable register.
Query example	*SRE? >12  Bits 2 and 3 are set in the Service Request Enable register.	

**\*STB**

→ Query

Description	<p>Reads the Status Byte register. This command will not clear the Status Byte register.</p> <p>If the Master Summary Status bit (MSS) is set, it indicates that there is a reason for a service request.</p> <p>Refer to section “<b>Status byte register group</b>” on page 212 for more information on bit.</p>	
Query Syntax	*STB?	
Return parameter	Return in "<NR1>" the value of the Status Byte register.	
Query example	*STB? >36  Bits 2 and 5 are set in the Status Byte register.	

**\*TRG**

Set →

Description	This command triggers the unit.	
Syntax	*TRG	

Example	*TRG Issue the enforcement trigger.
Related Commands	:INITiate:CONTinuous, :INITiate[:IMMediate]

**\*TST**

→ Query

Description	This command is a standard SCPI self-test command. The PEL-3000(H) does not perform any self-tests so will always return 0 (pass) for this command.
Query Syntax	*TST?
Return parameter	<NR1> Pass
Query example	*TST? >0

## Trigger Commands

:ABORt .....	38
:INPut[:STATe]:TRIGgered .....	39
:INITiate[:IMMediate] .....	39
:INITiate:CONTinuous .....	40
:TRIGger[:DELay]:TIME .....	40
:TRIGger[:PULSe]:WIDTh .....	41

## Trigger States

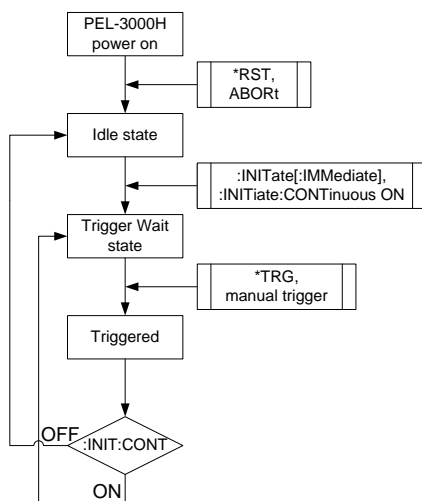

### :ABORt

Set →

Description	Clears the trigger wait status and returns to the idle state.
Query Syntax	:ABORt
Example	:ABOR Clears the trigger wait status.



**:INPut[:STATe]:TRIGgered** (Set) →  
→ (Query)

Description	Sets whether to turn on the load input when the trigger is activated. Sets when PEL-3000H is on idle state.	
Syntax	:INPut[:STATe]:TRIGgered {<Boolean> OFF   ON }	
Query Syntax	:INPut[:STATe]:TRIGgered?	
Parameter	OFF or 0	Not change the load input in when the trigger active.
	ON or 1	Turn on the load input in when the trigger active.
Example	:INP:TRIG ON Turn on the load input in when the trigger active.	
Related Commands	*TRG, :INITiate:CONTInuous, :INITiate[:IMMEDIATE]	

**:INITiate[:IMMEDIATE]** (Set) →

Description	Sets the trigger to the wait state. If the trigger is activated, the trigger will automatically go to the idle state.	
Query Syntax	:INITiate[:IMMEDIATE]	
Example	:INIT Sets the trigger to the wait state.	
Related Commands	*TRG, :INPut[:STATe]:TRIGgered, :CURRent[:VA]:TRIGgered, :RESistance[:VA]:TRIGgered	

**:INITiate:CONTInuous** (Set) →  
→ (Query)

Description	Sets or queries for state of the continuous waiting for the trigger.	
 Note	Release of the trigger wait state requires activation of the trigger.	
Syntax	:INITiate:CONTInuous {<Boolean> OFF   ON }	
Query Syntax	:INITiate:CONTInuous?	
Parameter	OFF or 0	Remove the continuous waiting for the trigger.
	ON or 1	Sets to continuous waiting for the trigger.
Example	:INIT:CONT ON Sets to continuous waiting for the trigger.	
Query example	:INITiate:CONT? >1 Setting in a continuous wait for trigger, and wait for the trigger.	
Related Commands	*TRG, :INPut[:STATe]:TRIGgered, :CURRent[:VA]:TRIGgered, :RESistance[:VA]:TRIGgered	

**:TRIGger[:DELay]:TIME** (Set) →  
→ (Query)

Description	The command determines how long to delay any action after a trigger is received. Equivalent to using the “Trig In Delay” setting on the front panel.	
Syntax	:TRIGger[:DELay]:TIME <NR2> MINimum MAXimum	
Query Syntax	:TRIGger[:DELay]:TIME? [MINimum MAXimum]	
Parameter	<NR2>	0 ~ 0.005s (0 ~ 5000us)
	MINimum	Minimum delay time

	<b>MAXimum</b>	Maximum delay time
Return parameter	Returns the delay time	
Example	:TRIG:TIME 0.005 Sets the trigger in delay to 5ms.	
Query example	:TRIG:TIME? >0.0050000 Returns the delay time in seconds.	
<div style="display: flex; justify-content: space-between; align-items: center;"> <span style="border: 1px solid black; border-radius: 10px; padding: 2px 5px;">Set</span> →                                   → <span style="border: 1px solid black; border-radius: 10px; padding: 2px 5px;">Query</span> </div>		
<b>:TRIGger[:PULSe]:WIDTh</b>		
Description	Sets and queries for the trigger output signal's pulse width.	
Syntax	:TRIGger[:PULSe]:WIDTh <NR2> MINimum MAXimum	
Query Syntax	:TRIGger[:PULSe]:WIDTh? [MINimum MAXimum]	
Parameter	<b>&lt;NR2&gt;</b>	0.0000025~0.005s (2.5us ~ 5000us)
	<b>MINimum</b>	
	<b>MAXimum</b>	
Return parameter	Returns the pulse width	
Example	:TRIG:WIDTh 0.005 Sets the trigger pulse width to 5ms.	
Query example	TRIG:WIDTh? >0.0050000 Returns the pulse width of the trigger output.	

## Input Commands

:INPut.....	42
:INPut:MODE.....	42
[:INPut]:SHORT.....	43

### :INPut

Set →

→ Query

Description	Sets and queries for the status of the load. Setting stop and restart of program, sequence, OCP test.	
Syntax	:INPut {<Boolean> OFF   ON }	
Query Syntax	:INPut?	
Parameter	OFF or 0	Sets the off the load input setting. Sets stop of program, sequence, OCP test.
	ON or 1	Sets the on the load input setting. Sets restart of program, sequence, OCP test.
Return parameter	Return in "<Boolean>" the set value of the load input.	
Example	:INP ON the on the load input setting.	
Query example	:INP? >1 Load input setting is on.	

### :INPut:MODE

Set →

→ Query

Description	Sets and queries for the operating function of the load.	
Syntax	:INPut:MODE{LOAD PROG NSEQ FSEQ}	
Query Syntax	:INPut:MODE	
Parameter	LOAD	Sets the manual operation.
	PROG	Sets the program function.
	NSEQ	Sets the normal sequence function.

	<b>FSEQ</b>	Sets the fast sequence function.
--	-------------	----------------------------------

Example	:INPut:MODE LOAD	
		Sets to the manual operation.

Query example	:INPut:MODE?	
	>LOAD	
		Mode of operation is the manual operation.

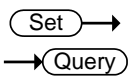

**[:INPut]:SHORT**

Description	Sets and queries for the input terminals state (open or short).	
-------------	---	--

Syntax	[:INPut]:SHORT {<Boolean> OFF   ON }	
--------	--------------------------------------	--

Query Syntax	[:INPut]:SHORT?	
--------------	-----------------	--

Parameter	OFF or 0	Sets the open.
	ON or 1	Sets the short.

Return parameter	Return in "<Boolean>" the input terminals state.	
------------------	--	--

Example	:SHOR ON	
		Sets the short.

Query example	:SHOR?	
	>1	
		The input terminals state is short.

## Measurement Commands

:MEASure:CURRent.....	44
:MEASure:ETIME.....	44
:MEASure:POWer .....	44
:MEASure:VOLTage .....	45

### :MEASure:CURRent → Query

Description	Query of current measurement.
Query Syntax	:MEASure:CURRent?
Return parameter	Return the current measurement (<NR2>). The unit is the [A].
Query example	:MEAS:CURR? >0.50000  Current measurement is 0.5A.

### :MEASure:ETIME → Query

Description	Query of the elapsed time of the load-on.
Query Syntax	:MEASure:ETIME?
Return parameter	Return the elapsed time (<NR2>) of the load-on. The unit is the seconds.
Query example	:MEAS:ETIM? >10.0  The elapsed time of the load-on is 10 seconds.

### :MEASure:POWer → Query

Description	Query of power measurement.
Query Syntax	:MEASure:POWer?
Return parameter	Return the power measurement (<NR2>). The unit is the [W].

---

Query example    :MEAS:POWer?  
                  >15.00000  
  
                  Power measurement is 15W.

---

## :MEASure:VOLTage

---

Description      Query of voltage measurement.

---

Query Syntax     :MEASure:VOLTage?

---

Return parameter Return the voltage measurement (<NR2>). The unit is the [V].

---

Query example    :MEAS:VOLT?  
                  >5.00000  
  
                  Voltage measurement is 5V.

---

## Fetch Subsystem

:FETCh:CURRent.....	46
:FETCh:POWer.....	46
:FETCh:VOLTage .....	46

### :FETCh:CURRent

→ Query

**Description** This query returns the real-time current of the load input.

**Query syntax** :FETCh:CURRent?

**Return parameter** Returns the real-time current .The unit is [A]

**Query example** :FETC:CURR?  
>0.5000

The load has a current of 0.5 amps at the input.

### :FETCh:POWer

→ Query

**Description** This query returns the real-time power of the load input.

**Query syntax** :FETCh:POWer?

**Return parameter** Returns the real-time power. The unit is [W].

**Query example** :FETC:POW?  
>15.00000

The load is at 15 watts.

### :FETCh:VOLTage

→ Query

**Description** This query returns the real-time voltage of the load input.

**Query syntax** :FETCh:VOLTage?

**Return parameter** Returns the real-time voltage. The unit is [V].



Query example    :FETC:VOLT?  
                  >5.00000

The load has a voltage of 5 volts at the input.

## Configure Subsystem Commands

[:CONFigure]:OCP .....	48
[:CONFigure]:OPP .....	49
[:CONFigure]:UVP .....	50
[:CONFigure]:UVP:TIME .....	50
[:CONFigure]:OVP .....	51
[:CONFigure]:SStart .....	52
[:CONFigure]:VON .....	52
[:CONFigure]:VDElay .....	53
:CONFigure:RESPOse .....	54
[:CONFigure]:CNTime .....	54
[:CONFigure]:COTime .....	55
[:CONFigure]:CRUnit .....	55
:CONFigure:DYNamic .....	56
:CONFigure:MEMory .....	56
:CONFigure:SHORt .....	57
:CONFigure:SHORt:SAFety .....	58
:CONFigure:SHORt:FUNcTion .....	58
[:CONFigure]:GNG:MODE .....	59
[:CONFigure]:GNG:H .....	60
[:CONFigure]:GNG:L .....	60
[:CONFigure]:GNG:C .....	61
[:CONFigure]:GNG:DTIME .....	62
[:CONFigure]:GNG:SPECtest .....	62
[:CONFigure]:GNG[:PASS] .....	63

### [:CONFigure]:OCP

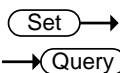

Description	Sets and queries for the OCP trip settings. The OCP limit can be set to a specific value or the trip setting can be set to either limit the current or to turn the load off.
Syntax	[:CONFigure]:OCP {<NRF>[ A ]   MINimum   MAXimum   LIMit   LOFF}
Query Syntax	[:CONFigure]:OCP?

<NRf>[A]	Current limit value.
MINimum	Minimum current limit value.
MAXimum	Maximum current limit value.
LIMit	Limit the current.
LOFF	Turn the load off.

**Return parameter** Returns OCP setting followed by the OCP value, by the "{Load off | LIMIT},<NR2>" string.

**Example1** :OCP LIM  
Sets the OCP setting to limit.

**Example2** :OCP 19.250  
Sets the OCP value to 19.25A.

**Query example** :OCP?  
>LIMIT, 19.250  
The OCP setting is LIMIT and the OCP value is 19.25A.

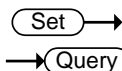

**[[:CONFigure]:OPP**

**Description** Sets or queries for the OPP trip settings. The OPP limit can be set to a specific value or the trip setting can be set to either limit the power or to turn the load off.

**Syntax** [[:CONFigure]:OPP {<NRf> [W] | MINimum | MAXimum | LIMit | LOFF}

**Query Syntax** [[:CONFigure]:OPP?

<b>Parameter</b>	<NRf>[W]	Power limit value.
	MINimum	Minimum power limits value.
	MAXimum	Maximum power limits value.
	LIMit	Limit the power
	LOFF	Turn the load off

**Return parameter** Returns a string with OPP setting followed by the OPP value, by the "{Load off | LIMIT},<NR2>" string.

Example1	:OPP LIM Sets the OCP setting to limit.
Example2	:OPP 10.000 Sets the OPP value to 10W.
Query example	:OPP? >LIMIT, 10.000 The OPP setting is limited and the OPP value is 10.000W.

Set →

→ Query

**[:CONFigure]:UVP**

Description	Sets or queries for the UVP trip settings.	
Syntax	[:CONFigure]:UVP {<NRf>[ V ]   MINimum   MAXimum }	
Query Syntax	[:CONFigure]:UVP?	
Parameter	<NRf>[V]	Under voltage limit value. ; 0 = OFF
	MINimum	Minimum value. (UVP setting is OFF.)
	MAXimum	Maximum value.
Return parameter	Return the set value of the UVP, by the "<NR2>" string	

Example1	:UVP 10.0 Sets the UVP setting to 10V.
----------	---

Query example	:UVP? > 10.0 The UVP setting is 10V.
---------------	--

Set →

→ Query

**[:CONFigure]:UVP:TIME**

Description	Sets and queries for the UVP ring time setting.	
Syntax	[:CONFigure]:UVP:TIME {<NR1>   MINimum   MAXimum   INFINITY}	
Query Syntax	[:CONFigure]:UVP:TIME? [MINimum   MAXimum]	

Parameter	<NR1>[s] MINimum MAXimum INFinity	The ring time in seconds(0~600); 0 = OFF Minimum ring time Maximum ring time Sets the ring time to infinity.
Return parameter	<NR1> Infinity OFF	The ring time in seconds Infinite Function complete ring time is off.
Example	:UVP:TIME 5	Sets the UVP ring time to 5 seconds.
Query example	:UVP:TIME? >5	The UVP ring time is 5 seconds.

**[[:CONFIgure]:OVP** 

Description	Sets or queries for the OVP trip settings.	
Syntax	[:CONFIgure]:OVP {<NRf>[V]   MINimum  MAXimum}	
Query Syntax	[:CONFIgure]:OVP?	
Parameter	<NRf>[V] MINimum MAXimum	Over voltage limit value. Minimum value. Maximum value. (OVP setting is OFF.)
Return parameter	Return the set value of the OVP, by the "{<NR2>   OFF}" string. "OFF" is a function off.	
Example1	:OVP 10.00	Sets the OVP setting to 10V.
Query example	:OVP? > 10.0000	The OVP setting is 10.0000V.

Set →

→ Query

**[:CONFigure]:SStart**

Description	Sets and queries for the Soft Start time setting.	
Syntax	[:CONFigure]:SStart {<NRf>[s]   MINimum  MAXimum   OFF}	
Query Syntax	[:CONFigure]:SStart?	
Parameter	<NRf>[s]	The soft start time in seconds.
	MINimum	Minimum time = 0 second
	MAXimum	Maximum time
	OFF	OFF = 0 second
Return parameter	Return the set value of the soft-start time, by the "{<NR2>   OFF}" string. "OFF" is a function off.	
Example	:SST OFF Turns the soft start function off.	
Query example	:SST? >OFF The soft start function is off.	

Set →

→ Query

**[:CONFigure]:VON**

Description	Sets and queries for the Von voltage settings and latch.	
Syntax	[:CONFigure]:VON {<NRf>[ V ]   MINimum  MAXimum   LON   LOFF}	
Query Syntax	[:CONFigure]:VON?	
Parameter	{<NRf>[V]	The Von voltage value.
	MINimum	Minimum Von voltage value.
	MAXimum	Maximum Von voltage value.
	LON	Latch on
	LOFF	Latch off

**Return parameter** Return the Von value and the mode of operation, by the " Latch:{OFF | ON},<NR2>" string.

**Example** :VON 10.0V LON  
Sets the Von voltage value to 10.0 volts. And Von latch ON.

**Query example** :VON?  
>Latch OFF, 0.00  
The Von voltage value is 0V.

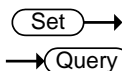

**[[:CONFIgure]:VDElay**

**Description** Sets and queries for the Von Delay settings in seconds.

**Syntax** [[:CONFIgure]:VDElay {<NRf>[s] | MINimum | MAXimum}

**Query Syntax** [[:CONFIgure]:VDElay?

<b>Parameter</b>	<NRf>[s]	The delay time in seconds
	OFF	Disable the delay time
	MINimum	Minimum delay time
	MAXimum	Maximum delay time

**Return parameter** Return the set value of the delay time, by the "{<NR2> | OFF}" string. "OFF" is a function off.

**Example 1** :VDEL 2.5 ms  
Sets the delay time to 2.5ms.

**Example 2** :VDEL 0.0025s  
Sets the delay time to 2.5ms.

**Query example** :VDEL?  
>0.0025  
The delay time is 2.5ms.

Set →  
→ Query

**:CONFigure:RESPonse**

Description	Sets and queries for the response speed of the CC, CR and CP mode.	
Syntax	:CONFigure:RESPonse{<NR2>   MINimum   MAXimum}	
Query Syntax	:CONFigure:RESPonse?	
Parameter	<NR2>	0.1, 0.2, 0.5, 1.0
	MINimum	Minimum response speed
	MAXimum	Maximum response speed
Return parameter	Return the set value of the response speed, by the "<NR2>" string.	
Example	:CONF:RESP MAX Sets the response to the maximum of the CC, CR and CP mode.	
Query example	:CONF:RESP? >1.0 Response speed of the CC, CR and CP mode is 1.0.	

Set →  
→ Query

**[:CONFigure]:CNTTime**

Description	Sets and queries for the Count Timer function.	
Syntax	[:CONFigure]:CNTTime {<Boolean>  OFF   ON }	
Query Syntax	[:CONFigure]:CNTTime?	
Parameter	OFF	Turns the Count Time timer off.
	ON	Turns the Count Time timer on
Example	:CNT ON Turns the Count Time timer on.	
Query example	CNT? >ON Count Time timer is turned on.	



		Set →
		→ Query
<b>[[:CONFigure]:COTime</b>		
Description	Sets and queries for the load cutoff time. A cutoff time of 0 seconds is the equivalent of disabling the cutoff time.	
Syntax	[:CONFigure]:COTime {<NRf>[s]  OFF MINimum  MAXimum}	
Query Syntax	[:CONFigure]:COTime?	
Parameter	<NRf>[s]	Cut off time in seconds (1~3599999)
	OFF	Turns the cutoff time off.
	MINimum	Sets the cutoff time to the maximum
	MAXimum	Sets the cutoff time to the minimum
Return parameter	Return the set value of the Cut-off time, by the "{<NR1>   OFF}" string. "OFF" is a function off.	
Example	:COT MAX Sets the cutoff time to the maximum.	
Query example	:COT? >500 The cutoff time is set to500 seconds.	

		Set →
		→ Query
<b>[[:CONFigure]:CRUnit</b>		
Description	Sets and queries for the CR mode setting units.	
Syntax	[:CONFigure]:CRUNit {OHM MHO}	
Query Syntax	[:CONFigure]:CRUNit?	
Parameter	OHM	Set the units to "Ω".
	MHO	Set the units to "mS" (conductance)
Example	:CRU OHM Sets the CR mode units to ohms.	

Query example :CRU?  
 >OHM  
 The CR mode units are ohms.

Set →

→ Query

**:CONFigure:DYNamic**

**Description** Sets and queries for the setting conditions of dynamic mode. Setting conditions can select the duty cycle or the timer, the percentage or the value.

**Syntax** :CONFigure:DYNamic { VALue | PERCent | TIME | FDUTy }

**Query Syntax** :CONFigure:DYNamic?

<b>Parameter</b>	VALue	Set the units to Value.
	PERCent	Set the units to Percent.
	TIME	Use timers for timing.
	FDUTy	Use duty cycle for timing.

**Return parameter** Return the unit and the timing mode, by the "{ Value | Percent},{T1/T2 | Fre./Duty}" string.

**Example** :CONF:DYN VAL  
 Sets the dynamic mode units to value.

**Query example** :CONF:DYN?  
 > Value,T1,T2  
 The dynamic mode becomes a value setup and timer setup.

Set →

→ Query

**:CONFigure:MEMory**

**Description** This command configures the how the files are recalled Local operation mode. By default when you try to recall a file or setting from memory, a message will appear asking you to press the Enter key to confirm each time you wish to recall. This command enables (SAFety) or disables this feature

(DIRect).

Syntax	:CONFigure:MEMory {SAFety   DIRect }	
Query Syntax	:CONFigure:MEMory?	
Parameter	SAFety	Safety setting.
	DIRect	Directly recall the chosen file.
Return parameter	Return the presence or absence of confirmation of recall, by the "{ Safety   Direct }" string.	
Example	:CONF:MEM SAF Enables the safety setting.	
Query example	:CONF:MEM? >Safety The safety setting is enabled.	

Set →

→ Query

**:CONFigure:SHORT**

Description	Sets and queries for the short key behavior.	
Syntax	:CONFigure:SHORT { TOGGle   HOLD }	
Query Syntax	:CONFigure:SHORT?	
Parameter	HOLD	Sets the short key configuration to hold
	TOGGle	Sets the short key configuration to toggle
Return parameter	Return the short key Action, by the "{Toggle   Hold}" string.	
Example	:CONF:SHOR TOGG Sets the short key configuration to toggle.	
Query example	:CONF:SHOR? >Toggle The short key is configured to toggle.	

Set →  
 → Query

**:CONFigure:SHORT:SAFety**

---

Description	Turns the Short Safety function on/off. The short safety function requires the load to already be turned on before the load can be shorted using the Short key or :INPut:SHORT command.	
Syntax	:CONFigure:SHORT:SAFety {<bool> OFF ON}	
Query Syntax	:CONFigure:SHORT:SAFety?	
Parameter	OFF   0	OFF
	ON   1	ON
Return parameter	Return the short safety function on/off.	
Example	:CONF:SHOR:SAF OFF Sets the Short Safety off.	
Query example	:CONF:SHOR:SAF? >OFF  Short safety is turned off.	

Set →  
 → Query

**:CONFigure:SHORT:FUNction**

---

Description	Enables or disables the short function by short key. The load cannot be shorted until the short function has been enabled with this function.	
Syntax	CONFigure:SHORT:FUNction {<Boolean> OFF ON}	
Query Syntax	:CONFigure:SHORT:FUNction?	
Parameter	OFF   0	Disables the short function
	ON   1	Enables the short function
Return parameter	Return the short key/short function.	
Example	:CONF:SHOR:FUNC ON Enables the short function.	

Query example :CONF:SHOR:FUNC?  
>ON

Indicates that the short function is enabled.

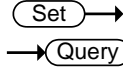

**[[:CONFigure]:GNG:MODE**

**Description** Sets and queries for the entry mode for the Go-NoGo settings. The entry mode determines whether the Go-NoGo limits are set as values or as a percentage value from a center reference value.

**Syntax** [[:CONFigure]:GNG:MODE {PERCent | VALue }

**Query Syntax** [[:CONFigure]:GNG:MODE?

<b>Parameter</b>	PERCent	Sets the entry mode to %.
	VALue	Sets the entry mode to value

**Return parameter** Returns the Setting value of Go-NoGo input mode, by the "{Percent | Value}" string.

**Example** :GNG:MODE PERC  
Sets the entry mode to %.

**Query example** :GNG:MODE?  
>Percent  
The entry mode is %.

**Related Commands** [[:CONFigure]:GNG:H  
[[:CONFigure]:GNG:L  
[[:CONFigure]:GNG:C

Set →

→ Query

**[[:CONFigure]:GNG:H**

Description	Sets and queries for the high voltage/current limit value. If the entry mode is set to value, the high voltage/current limit value units are in volts/amps. If the entry mode is set to percent, the high voltage/current limit value units are in percent.	
Syntax	[:CONFigure]:GNG:H <NRf>	
Query Syntax	[:CONFigure]:GNG:H?	
Parameter	<NRf>	Sets the high voltage/current limit value in volts/amps or in percent.
Return parameter	Returns the voltage/current upper limit value, by the "{<NR2>}" string.	
Example	:GNG:H 100.0 Sets the high voltage limit value to 100%.	
Query example	:GNG:H? >100.0 Returns the high voltage limit value as 100.0%.	
Related Commands	[:CONFigure]:GNG:Mode [:CONFigure]:GNG:L	

Set →

→ Query

**[[:CONFigure]:GNG:L**

Description	Sets and queries for the low voltage/current limit value. If the entry mode is set to value, the low voltage/current limit value units are in volts/amps. If the entry mode is set to percent, the low voltage/current limit value units are in percent.	
Syntax	[:CONFigure]:GNG:L <NRf>	
Query Syntax	[:CONFigure]:GNG:L?	

Parameter	<NRf>	Sets the low voltage/current limit value in volts/amps or in percent.
Return parameter	Returns the voltage/current lower limit value, by the "{<NR2>}" string.	
Example	:GNG:L 10.0	Sets the low voltage limit value to 10%.
Query example	:GNG:L? >10.0	Returns the low voltage limit value as 10.0%.
Related Commands	[:CONFigure]:GNG:Mode [:CONFigure]:GNG:H	

**[:CONFigure]:GNG:C**

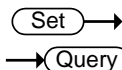

Description	Sets and queries for the center voltage/current limit value. The center voltage limit value is used as the center reference value when the entry mode is set to percent.	
Syntax	[:CONFigure]:GNG:C <NRf>	
Query Syntax	[:CONFigure]:GNG:C?	
Parameter	<NRf>	Sets the center voltage/current limit value in volts/amps.
Return parameter	Returns the Center value of voltage/current, by the "{<NR2>}" string.	
Example	:GNG:C 10.0	Sets the center voltage/current limit value to 10V or 10A.
Query example	:GNG:C? >10.0	Returns the center voltage/current limit value of 10V or 10A.
Related Commands	[:CONFigure]:GNG:Mode	

Set →  
 → Query

**[:CONFigure]:GNG:DTIME**

---

Description	Sets and queries for the Go-NoGo delay time.	
Syntax	[:CONFigure]:GNG:DTIME {<NRf>[s]   MINimum   MAXimum }	
Query Syntax	[:CONFigure]:GNG:DTIME?	
Parameter	<NRf>[s]	Sets the Go-NoGo delay time in seconds (0.0~1.0) with 0.1 second resolution.
	MINimum	Minimum delay time
	MAXimum	Maximum delay time
Return parameter	Returns the delay time in seconds, by the "<NR2>" string.	
Example	:GNG:DTIM 0.5 Sets the delay time to 0.5 seconds.	
Query example	:GNG:DTIM? >0.5 The delay time is 0.5 seconds.	

Set →  
 → Query

**[:CONFigure]:GNG:SPECTest**

---

Description	Sets and queries for Go-NoGo testing	
Syntax	[:CONFigure]:GNG:SPECTest {<Boolean> OFF   ON }	
Query Syntax	[:CONFigure]:GNG:SPECTest?	
Parameter	OFF	SPEC test = OFF
	ON	SPEC test = ON
Example	:GNG:SPECTest ON Turns Go-NoGo testing on.	
Query example	:GNG:SPECTest? >OFF Indicates that Go-NoGo testing is off.	



[:CONFigure]:GNG[:PASS]

→ Query

---

Description	Queries the Go-NoGo test result(s). This command can be used for all test modes (CC, CV, CR, CP).
Query Syntax	[:CONFigure]:GNG[:PASS]?
Return parameter	NG            No Go (fail) GO            Go (Pass)
Query example	:GNG? >GO Returns the Go-NoGo test result.

## Parallel Command

**[[:CONFigure]:PARAllel**

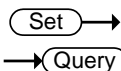

Description	Configures the unit for parallel operation, or queries its state. This command configures the unit as a Master or Slave, and configures how many slave units are connected if the unit is configured as a master.	
Syntax	[:CONFigure]:PARAllel { MASTer   SLAVe   OFF   P2   P3   P4   P5   B1   B2   B3   B4}	
Query Syntax	[:CONFigure]:PARAllel?	
Parameter	P2,P3,P4 or P5	Number of connected slaves
	B1,B2,B3 or B4	Number of connected Booster.
	OFF	Turn parallel mode off
	MASTer	Sets the unit to Master
	SLAVe	Sets the unit to Slave
Return parameter	Return the connections number and mode(master / slave). Response of master mode is the "Mode:Master,{Number:OFF Parallel Number:{2 3 4 5}   Booster Number: {1 2 3 4} }". Response of Slave mode is the ""Mode:Slave".	
Example 1	:PAR MAST Sets the unit to Master.	
Example 2	:PAR B2 Configures the unit for use with 2 booster units.	
Query example	:PAR? >Mode:Master, Number:OFF The unit is set to Master and there are no connected slaves.	

## Step Resolution Commands

:CONFigure:STATus .....	65
[[:CONFigure]:STEP:CC .....	66
[[:CONFigure]:STEP:CCH .....	66
[[:CONFigure]:STEP:CCM .....	67
[[:CONFigure]:STEP:CCL .....	67
[[:CONFigure]:STEP:CR .....	68
[[:CONFigure]:STEP:CRH .....	68
[[:CONFigure]:STEP:CRM .....	69
[[:CONFigure]:STEP:CRL .....	70
[[:CONFigure]:STEP:CV .....	70
[[:CONFigure]:STEP:CVH .....	71
[[:CONFigure]:STEP:CVL .....	71
[[:CONFigure]:STEP:CP .....	72
[[:CONFigure]:STEP:CPH .....	72
[[:CONFigure]:STEP:CPM .....	73
[[:CONFigure]:STEP:CPL .....	74

Set →

→ Query

### :CONFigure:STATus

Description	Sets the mode used for the set resolution when using the scroll wheel to edit parameters.	
Syntax	:CONFigure:STATus { STEP   CURSOR }	
Query Syntax	:CONFigure:STATus?	
Parameter	STEP	Knob Status = Step (coarse/fine)
	CURSOR	Knob Status = Cursor
Return parameter	<ASCII string>	Returns the Knob Status configuration as a string.
Example	:CONF:STAT STEP Sets the mode to STEP.	
Query example	:CONF:STAT? >Step Returns the mode.	

**[:CONFigure]:STEP:CC → Query**

Description	Queries the step resolution for each CC Mode range.
Query Syntax	<code>[:CONFigure]:STEP:CC?</code>
Return parameter	Returns the step resolution for each CC Mode range, by the "CCH:<NR2>, CCM:<NR2>, CCL:<NR2>" string. Unit is [A]
Query example	<code>:STEP:CC?</code> <code>&gt;CCH:0.0300, CCM:0.00300, CCL:0.000300</code> Returns the CC mode step resolution for each range.

(Set) →

**[:CONFigure]:STEP:CCH → Query**

Description	Sets and queries for the step resolution for CC High Range.	
 Note	The step resolution setting will be automatically rounded to the closest multiple of the base resolution.	
Syntax	<code>[:CONFigure]:STEP:CCH { &lt;NRf&gt;[A]   MINimum   MAXimum }</code>	
Query Syntax	<code>[:CONFigure]:STEP:CCH?</code>	
Parameter	<code>&lt;NRf&gt;[A]</code>	Step resolution. Unit is [A]
	<code>MINimum</code>	Minimum step resolution
	<code>MAXimum</code>	Maximum step resolution
Return parameter	Returns the range and the step resolution, by the "CCH:<NR2>" string.	
Example	<code>:STEP:CCH 0.03A</code> Sets the step resolution to 0.03A.	
Query example	<code>:STEP:CCH?</code> <code>&gt;CCH:0.0300</code> Returns the step resolution (0.03A).	

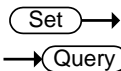

**[[:CONFigure]:STEP:CCM**

Description	Sets and queries for the step resolution for CC medium Range.	
Note	The step resolution setting will be automatically rounded to the closest multiple of the base resolution.	
Syntax	[:CONFigure]:STEP:CCM {<NRf>[A]   MINimum   MAXimum }	
Query Syntax	[:CONFigure]:STEP:CCM?	
Parameter	<NRf>[A]	Step resolution. Unit is [A]
	MINimum	Minimum step resolution
	MAXimum	Maximum step resolution
Return parameter	Returns the range and the step resolution, by the "CCM:<NR2>" string.	
Example	:STEP:CCM 0.003A Sets the step resolution to 0.003A.	
Query example	:STEP:CCM? >CCM:0.00300 Returns the step resolution (0.003A).	

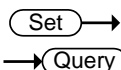

**[[:CONFigure]:STEP:CCL**

Description	Sets and queries for the step resolution for CC low Range.	
Note	The step resolution setting will be automatically rounded to the closest multiple of the base resolution.	
Syntax	[:CONFigure]:STEP:CCL {<NRf>[A]   MINimum   MAXimum }	
Query Syntax	[:CONFigure]:STEP:CCL?	
Parameter	<NRf>[A]	Step resolution. Unit is [A]

	MINimum	Minimum step resolution
	MAXimum	Maximum step resolution
Return parameter	Returns the range and the step resolution, by the "CCL:<NR2>" string.	
Example	:STEP:CCL 0.0003A Sets the step resolution to .0003A.	
Query example	:STEP:CCL? > CCL:0.000300 Returns the step resolution (0.0003A).	

**[[:CONFIgure]:STEP:CR → Query**

Description	Queries the step resolution for each CR Mode range.	
Query Syntax	[:CONFIgure]:STEP:CR?	
Return parameter	Returns the step resolution for each CR Mode range, by the " CRH:<NR2>, CRM:<NR2>, CRL:<NR2>" string. Unit is [mS]	
Query example	:STEP:CR? >CRH:3.00, CRM:0.300, CRL:0.0300 Returns the CR mode step resolution for each range.	

Set →

**[[:CONFIgure]:STEP:CRH → Query**

Description	Sets and queries for the step resolution for CR High Range.	
 Note	The step resolution setting will be automatically rounded to the closest multiple of the base resolution.	
Syntax	[:CONFIgure]:STEP:CRH {<NRF>[mS]   MINimum   MAXimum }	
Query Syntax	[:CONFIgure]:STEP:CRH?	
Parameter	<NRF>[mS]	Step resolution. Unit is [mS]
	MINimum	Minimum step resolution

	<b>MAXimum</b> Maximum step resolution
Return parameter	Returns the range and the step resolution, by the "CRH:<NR2>" string.
Example	:STEP:CRH 3 Sets the step resolution to 3mS.
Query example	:STEP:CRH? >CRH:3.00 Returns the step resolution (3mS).

**[[:CONFigure]:STEP:CRM**

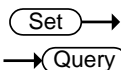

Description	Sets and queries for the step resolution for CR Medium Range.
 Note	The step resolution setting will be automatically rounded to the closest multiple of the base resolution.
Syntax	[[:CONFigure]:STEP:CRM {<Nrf>[mS]   MINimum   MAXimum }
Query Syntax	[[:CONFigure]:STEP:CRM?
Parameter	<Nrf>[mS] Step resolution. Unit is [mS] MINimum Minimum step resolution MAXimum Maximum step resolution
Return parameter	Returns the range and the step resolution, by the "CRM:<NR2>" string.
Example	:STEP:CRM 0.3 Sets the step resolution to 0.3mS.
Query example	:STEP:CRM? >CRM:0.300 Returns the step resolution (0.3mS).

Set →

→ Query

**[[:CONFigure]:STEP:CRL**

**Description** Sets and queries for the step resolution for CR Low Range.

 **Note** The step resolution setting will be automatically rounded to the closest multiple of the base resolution.

**Syntax** [[:CONFigure]:STEP:CRL {<NRf>[mS] | MINimum | MAXimum }

**Query Syntax** [[:CONFigure]:STEP:CRL?

<b>Parameter</b>	<b>&lt;NRf&gt;[mS]</b>	Step resolution. Unit is [mS]
	<b>MINimum</b>	Minimum step resolution
	<b>MAXimum</b>	Maximum step resolution

**Return parameter** Returns the range and the step resolution, by the "CRL:<NR2>" string.

**Example** :STEP:CRL 0.03  
Sets the step resolution to 0.03mS.

**Query example** :STEP:CRL?  
>CRL:0.0300  
Returns the step resolution (0.03mS).

**[[:CONFigure]:STEP:CV**

→ Query

**Description** Queries the step resolution for each CV Mode range.

**Query Syntax** [[:CONFigure]:STEP:CV?

**Return parameter** Returns the step resolution for each CV Mode range, by the "CVH:<NR2>, CVL:<NR2>" string. Unit is [V]

**Query example** :STEP:CV?  
>CVH:2.00, CVL:0.200  
Returns the CV mode step resolution for each range.



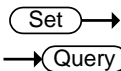

**[[:CONFigure]:STEP:CVH**

**Description** Sets and queries for the step resolution for CV High Range.

 **Note** The step resolution setting will be automatically rounded to the closest multiple of the base resolution.

**Syntax** [[:CONFigure]:STEP:CVH {<NRf>[V] | MINimum | MAXimum }

**Query Syntax** [[:CONFigure]:STEP:CVH?

<b>Parameter</b>	<NRf>[V]	Step resolution. Unit is [V]
	MINimum	Minimum step resolution
	MAXimum	Maximum step resolution

**Return parameter** Returns the range and the step resolution, by the "CVH:<NR2>" string.

**Example** :STEP:CVH 2V  
Sets the step resolution to 2V.

**Query example** :STEP:CVH?  
> CVH:2.00  
Returns the step resolution (2V).

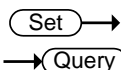

**[[:CONFigure]:STEP:CVL**

**Description** Sets and queries for the step resolution for CV Low Range.

 **Note** The step resolution setting will be automatically rounded to the closest multiple of the base resolution.

**Syntax** [[:CONFigure]:STEP:CVL {<NRf>[V] | MINimum | MAXimum }

**Query Syntax** [[:CONFigure]:STEP:CVL?

<b>Parameter</b>	<NRf>[V]	Step resolution. Unit is [V]
------------------	----------	------------------------------

	MINimum	Minimum step resolution
	MAXimum	Maximum step resolution
Return parameter	Returns the range and the step resolution, by the "CVL:<NR2>" string.	
Example	:STEP:CVL 0.2V Sets the step resolution to 0.2V.	
Query example	:STEP:CVL? > CVL:0.200 Returns the step resolution (0.2V).	

**[[:CONFIgure]:STEP:CP** → **Query**

Description	Queries the step resolution for each CP Mode range.	
Query Syntax	[:CONFIgure]:STEP:CP?	
Return parameter	Returns the step resolution for each CP Mode range, by the "CPH:<NR2>, CPM:<NR2>, CPL:<NR2>" string. Unit is [W]	
Query example	:STEP:CP? > CPH:1.00, CPM:0.100, CPL:0.0100 Returns the CP mode step resolution for each range.	

→ **Set** →

**[[:CONFIgure]:STEP:CPH** → **Query**

Description	Sets and queries for the step resolution for CP High Range.	
 Note	The step resolution setting will be automatically rounded to the closest multiple of the base resolution.	
Syntax	[:CONFIgure]:STEP:CPH {<NRF>[W]   MINimum   MAXimum }	
Query Syntax	[:CONFIgure]:STEP:CPH?	
Parameter	<NRF>[W]	Step resolution. Unit is [W]
	MINimum	Minimum step resolution

	<b>MAXimum</b> Maximum step resolution
Return parameter	Returns the range and the step resolution, by the "CPH:<NR2>" string.
Example	:STEP:CPH 1 Sets the step resolution to 1W.
Query example	:STEP:CPH? >CPH:1.00 Returns the step resolution (1W).

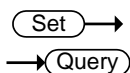

**[[:CONFIgure]:STEP:CPM**

Description	Sets and queries for the step resolution for CP Medium Range.
-------------	---

 Note	The step resolution setting will be automatically rounded to the closest multiple of the base resolution.
--	---

Syntax	[[:CONFIgure]:STEP:CPM {<NRf>[W]   MINimum   MAXimum }
--------	--

Query Syntax	[[:CONFIgure]:STEP:CPM?
--------------	-------------------------

Parameter	<NRf>[W] Step resolution. Unit is [W]
	MINimum Minimum step resolution
	MAXimum Maximum step resolution

Return parameter	Returns the range and the step resolution, by the "CPM:<NR2>" string.
------------------	---

Example	:STEP:CPM 0.1 Sets the step resolution to 0.1W.
---------	--

Query example	:STEP:CPM? >CPM:0.100 Returns the step resolution (0.1W).
---------------	---

Set →

→ Query

**[[:CONFigure]:STEP:CPL**

**Description**      Sets and queries for the step resolution for CP Low Range.

 **Note**      The step resolution setting will be automatically rounded to the closest multiple of the base resolution.

**Syntax**              [:CONFigure]:STEP:CPL {<NRf>[W] | MINimum | MAXimum }

**Query Syntax**      [:CONFigure]:STEP:CPL?

<b>Parameter</b>	<NRf>[W]	Step resolution. Unit is [W]
	MINimum	Minimum step resolution
	MAXimum	Maximum step resolution

**Return parameter** Returns the range and the step resolution, by the "CPL:<NR2>" string.

**Example**              :STEP:CPL 0.01  
Sets the step resolution to 0.01W.

**Query example**      :STEP:CPL?  
>CPM:0.0100  
Returns the step resolution (0.01W).

## External Control Commands

[:CONFigure]:EXTernal[:CONTRol].....	75
[:CONFigure]:EXTernal:CV .....	75
[:CONFigure]:EXTernal:LOADonin.....	76

### [:CONFigure]:EXTernal[:CONTRol]

Description	Sets and queries for the external control of CC, CR, CV, CP mode.	
Syntax	[:CONFi gure]:EXTernal[:CONTRol]{ OFF   VOLTage   RESistance   RINV }	
Query Syntax	[:CONFi gure]:EXTernal[:CONTRol]?	
Parameter	OFF	Disables external control
	VOLTage	Sets the unit to external voltage control
	RESistance	Sets the unit to external resistance control
	RINV	Sets the unit to external resistance (inverted) control
Return parameter	Returns mode of the external control, by the "Control:{OFF   Volt   Res   Rinverse}" string.	
Example	:EXT OFF Turns external control off.	
Query example	:EXT? >Control:OFF External control is setting is off.	

### [:CONFigure]:EXTernal:CV

Description	Sets and queries for the external control of +CV mode.	
 Note	Please set the unit to external control of CC, CR, CV, CP mode.	

Syntax	[:CONFigure]:EXTernal:CV { OFF   ON }	
Query Syntax	[:CONFigure]:EXTernal:CV?	
Parameter	OFF	Disables external control of +CV mode
	ON	Sets the unit to external control of +CV mode
Return parameter	Returns the external control of +CV mode configuration, by the "CV:{OFF   ON}" string.	
Example	:EXT:CV ON	Turns external control of +CV mode on.
Query example	:EXT:CV? >CV:ON	Uses external control of +CV mode.

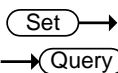

**[:CONFigure]:EXTernal:LOADonin**

Description	Sets and queries for turned on and off with the external switch.  External switch (LoadOn IN) is whether or not turned on the load setting of at the time of the open(HIGH) or closed(LOW).	
Syntax	[:CONFigure]:EXTernal:LOADonin {OFF   High   Low}	
Query Syntax	[:CONFigure]:EXTernal:LOADonin?	
Parameter	OFF	LoadOn IN = off
	HIGH	LoadOn IN = open
	LOW	LoadOn IN = closed
Return Parameter	Returns the setting value of external switch, by the "LoadOn In:{OFF   High   Low}" string.	
Example	:EXT:LOAD OFF	Turns The LoadOn IN off.
Query example	: EXT:LOAD? >LoadOn In:OFF	The LoadOn In setting is off.

## Mode Subsystem Commands

:MODE .....	77
[:MODE]:CRANge .....	77
[:MODE]:VRANge .....	78
[:MODE]:RESPonse .....	78
[:MODE]:DYNamic .....	79

### :MODE

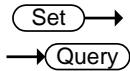

Description	Sets and queries for the operating modes.	
Syntax	:MODE {CC   CR   CV   CP   CCCV   CRCV   CPCV}	
Query Syntax	:MODE?	
Parameter	CC	CC mode
	CR	CR mode
	CV	CV mode
	CP	CP mode
	CCCV	CC + CV mode
	CRCV	CR + CV mode
	CPCV	CP + CV mode
Example	:MODE CC Sets the mode to CC mode.	
Query example	:MODE? >CC Returns the operating mode (CC mode).	

### [:MODE]:CRANge

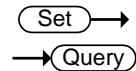

Description	Sets and queries for the current range of all the operating modes.	
Syntax	[:MODE]:CRANge {HIGH   MIDDLE   LOW}	
Query Syntax	[:MODE]:CRANge?	
Parameter	HIGH	High range

MIDDLE	Middle range
LOW	Low range

**Return parameter** Returns the setting of Setting of the current range, by the "{High | Mid | Low}" string.

**Example** :CRAN LOW  
Sets the current range to Low.

**Query example** :CRAN?  
>Low  
The current range is set to Low.

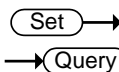

### **[[:MODE]:VRANge**

**Description** Sets and queries for the voltage range of all operating modes.

**Syntax** [[:MODE]:VRANge { HIGH | LOW }

**Query Syntax** [[:MODE]:VRANge?

Parameter	HIGH	High range
	LOW	Low range

**Return parameter** Returns the setting of Setting of the voltage range, by the "{High | Low}" string.

**Example** :VRAN LOW  
Sets the voltage range to Low.

**Query example** :VRAN?  
>Low  
The voltage range is set to Low.

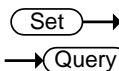

### **[[:MODE]:RESPonse**

**Description** Sets and queries for The response speed of the CV and +CV mode. The default is fast response.

**Syntax** [[:MODE]:RESPonse { FAST | RESP{ 6 | 5 | 4 | 3 | 2 | 1 } | SLOW }

**Query Syntax** [[:MODE]:RESPonse?



Parameter /	FAST   RESP6	Response speed
Return parameter	RESP5   RESP4   RESP3   RESP2   RESP1   SLOW	
Example	:RESP FAST	Sets the CV and +CV response to fast.
Query example	:RESP? >FAST	The speed response of CV and +CV mode is set to fast.

Set →  
 → Query

**[[:MODE]:DYNamic**

Description	Sets and queries for the Switching function.	
Syntax	[:MODE]:DYNamic { DYNamic   STATic }	
Query Syntax	[:MODE]:DYNamic?	
Parameter	DYNamic	Set to Dynamic mode
	STATic	Set to Static mode
Return parameter	Returns the Setting of Switching function, by the "{Dynamic   Static}" string.	
Example	:DYN DYN	Set the switching function to dynamic
Query example	:DYN? >Dynamic	The switching function is set to dynamic mode.

## Current Subsystem Commands

:CURRent[:VA]	80
:CURRent[:VA]:TRIGgered	81
:CURRent:VB	81
:CURRent:SRATe	82
:CURRent:L1	82
:CURRent:L2	83
:CURRent:SET	84
:CURRent:LEVel	84
:CURRent:RISE	85
:CURRent:FALL	86
:CURRent:T1	86
:CURRent:T2	87
:CURRent:FREQuency	88
:CURRent:DUTY	88
:CURRent:RECall	89

### :CURRent[:VA]

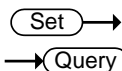

**Description** Sets and queries for the “A Value” current of the CC static mode.



A different current value can be set for each current range (High/Mid/Low).

The [:VA] node can only be omitted when in static mode.

**Syntax** :CURRent[:VA] {<NRf>[A] | MINimum | MAXimum }

**Query Syntax** :CURRent[:VA]?

<b>Parameter</b>	<NRf>[A]	“A Value” current value
	MINimum	Minimum current level
	MAXimum	Maximum current level

**Return parameter** Return the current value of “A Value”, by the “<NR2>” string.

**Example** :CURR MIN  
Sets the current value to the minimum.

Query example :CURR?  
>1.0000  
Current setting of "A Value" is set to 1A.

**:CURRent[:VA]:TRIGgered** (Set) →

Description Set the current value when the trigger is activated.

Syntax :CURRent[:VA]:TRIGgered {<NR2>[A] | MINimum | MAXimum }

Parameter	<NRf>[A]	"A Value" current value
	MINimum	Minimum current level
	MAXimum	Maximum current level

Example :CURR:TRIG MIN  
Set the minimum current value when the trigger is activated.

Related Commands \*TRG, :INITiate:CONTInuous, :INITiate[:IMMEDIATE]

**:CURRent:VB** (Set) →  
→ (Query)

Description Sets and queries for the "B Value" current of the CC static mode.

 Note A different current value can be set for each current range (High/Mid/Low).

Syntax :CURRent:VB {<NRf>[A] | MINimum | MAXimum }

Query Syntax :CURRent:VB?

Parameter	<NRf>[A]	"B Value" current value
	MINimum	Minimum current level
	MAXimum	Maximum current level

Return parameter Return the Current value of "B Value", by the "<NR2>" string.

Example :CURR:VB MIN  
Sets the current value to the minimum.

Query example :CURR:VB?  
 >1.0000  
 Current setting of "B Value" is set to 1A.

Set →

**:CURRent:SRATe**

→ Query

Description	Sets and queries for the current slew rate of CC static mode.	
Syntax	:CURRent:SRATe {<NRf>   MINimum   MAXimum }	
Query Syntax	:CURRent:SRATe?	
Parameter	<NRf>	Sets the slew rate in mA/us
	MINimum	Set to the lowest slew rate
	MAXimum	Set to the highest slew rate
Return parameter	Return the slew rate, by the "<NR2>" string.	
Example	:CURR:SRAT MIN Sets the slew rate to the minimum.	

Query example :CURR:SRAT?  
 >5.0000  
 The slew rate is set to 5mA/us.

Set →

**:CURRent:L1**

→ Query

Description	Sets and queries for the "Level1" current of the CC dynamic mode.  This command applies in "Dyna.Level" is "Value".	
-------------	---	--

 Note A different current value can be set for each range (High/Mid/Low).

Syntax	:CURRent:L1 {<NRf>[ A ]   MINimum   MAXimum }	
Query Syntax	:CURRent:L1?	
Parameter	<NRf>[A]	"Level1" current value
	MINimum	Minimum current level

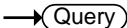
	<b>MAXimum</b> Maximum current level
Return parameter	Return the current value of "Level1", by the "<NR2>" string.
Example	:CURR:L1 MIN Sets the current value to the minimum.
Query example	:CURR:L1? >1.0000 Current setting of " Level1" is set to 1A.
 	
<b>:CURRent:L2</b>	

**Description** Sets and queries for the "Level2" current of the CC dynamic mode.  
This command applies in "Dyna.Level" is "Value".

 **Note** A different current value can be set for each range (High/Mid/Low).

**Syntax** :CURRent:L2 {<NRf>[ A ] | MINimum | MAXimum }

**Query Syntax** :CURRent:L2?

<b>Parameter</b>	<NRf>[A]	"Level2" current value
	MINimum	Minimum current level
	MAXimum	Maximum current level

**Return parameter** Return the current value of "Level2", by the "<NR2>" string.

**Example** :CURR:L2 MIN  
Sets the current value to the minimum.

**Query example** :CURR:L2?  
>1.0000  
Current setting of " Level2" is set to 1A.

**:CURRent:SET** 



Description	Sets and queries for the "Set" current of the CC dynamic mode. This command applies in "Dyna.Level" is "Percent".	
Syntax	:CURRent:SET{<NRF>[A]   MINimum   MAXimum }	
Query Syntax	:CURRent:SET?	
Parameter	<NRF>[A]	The current value at the time of "Level=100%"
	MINimum	Minimum current value
	MAXimum	Maximum current value
Return parameter	Return the current value of "Level = 100%", by the "<NR2>" string.	
Example	:CURR:SET MIN Sets the minimum current value of "Level = 100%".	
Query example	:CURR:SET? >1.0 Current value of "Level = 100%" is set to 1A.	
Related Commands	:CURRent:LEVel	

**:CURRent:LEVel** 



Description	Sets and queries for the "Level" % of the CC dynamic mode. This command applies in "Dyna.Level" is "Percent".	
Syntax	:CURRent:LEVel {<NRF>   MINimum   MAXimum }	
Query Syntax	:CURRent:LEVel?	
Parameter	<NRF>	% of "SET" current level (unit is [%])
	MINimum	Minimum % of "SET" current level

	<b>MAXimum</b> Maximum % of "SET" current level
Return parameter	Return the current of "% Level", by the "<NR2>" string.
Example	:CURR:LEV MIN Sets the % level current value to the minimum.
Query example	:CURR:LEV? >50 Percentage of the set current value is set to 50%.
Related Commands	:CURRent:SET



Description	Sets and queries for the rising current slew rate of the CC dynamic mode.	
Syntax	:CURRent:RISE {<NRf>   MINimum   MAXimum }	
Query Syntax	:CURRent:RISE?	
Parameter	<NRf>	Rising current slew rate(unit is [mA/us])
	MINimum	Minimum slew rate
	MAXimum	Maximum slew rate
Return parameter	Return the rise of the current slew rate, by the "<NR2>" string.	
Example	:CURR:RISE MIN Sets the rising slew rate to the minimum.	
Query example	:CURR:RISE? >5000 Returns the rising slew rate as 5000mA/us.	
Related Commands	:CURRent:FALL	

Set →

→ Query

**:CURRent:FALL**

**Description** Sets and queries for the falling of the current slew rate of the CC dynamic mode.

**Syntax** :CURRent:FALL {<NRf> | MINimum | MAXimum }

**Query Syntax** :CURRent:FALL?

<b>Parameter</b>	<b>&lt;NRf&gt;</b>	Falling current slew rate (unit is [mA/us])
	<b>MINimum</b>	Minimum slew rate
	<b>MAXimum</b>	Maximum slew rate

**Return parameter** Return the falling of the current slew rate, by the "<NR2>" string.

**Example** :CURR:FALL MIN  
Sets the falling slew rate to the minimum.

**Query example** :CURR:FALL?  
>5000  
Returns the falling slew rate as 5000mA/us.

**Related Commands** :CURRent: RISE

Set →

→ Query

**:CURRent:T1**

**Description** Sets and queries for the "Timer1" time of CC dynamic mode.  
This command applies in "Dyna.Time" is "T1/T2".

**Syntax** :CURRent:T1 {<NRf>[s] | MINimum | MAXimum }

**Query Syntax** :CURRent:T1?

<b>Parameter</b>	<b>&lt;NRf&gt;[s]</b>	T1 timer setting. (unit is seconds)
	<b>MINimum</b>	Minimum time
	<b>MAXimum</b>	Maximum time



Return parameter Return the setting of the timer T1, by the "<NR2>" string.

Example :CURR:T1 0.2  
Sets the setting of the timer T1.

Query example :CURR:T1?  
>0.2  
Return the setting of the timer T1.

Related Commands :CURRent:T2

**:CURRent:T2**

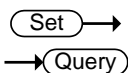

Description Sets and queries for the "Timer2" time of CC dynamic mode.  
This command applies in "Dyna.Time" is "T1/T2".

Syntax :CURRent:T2 {<NRf>[s] | MINimum | MAXimum }

Query Syntax :CURRent:T2?

Parameter	<NRf>[s]	T2 timer setting. (unit is seconds)
	MINimum	Minimum time
	MAXimum	Maximum time

Return parameter Return the setting of the timer T2, by the "<NR2>" string.

Example :CURR:T2 0.2  
Sets the setting of the timer T2.

Query example :CURR:T2?  
>0.2  
Returns the setting of the timer T2.

Related Commands :CURRent:T1

Set →  
 → Query

---

**:CURRent:FREQUency**

**Description**      Sets and queries for “Frequency” value of the CC dynamic mode.  
 This command applies in “Dyna.Time” is “Freq/Duty”.

**Syntax**            :CURRent:FREQUency {<NRf> | MINimum | MAXimum }

**Query Syntax**     :CURRent:FREQUency?

<b>Parameter</b>	<b>&lt;NRf&gt;</b>	Sets the switching frequency.(unit is Hz)
	<b>MINimum</b>	Minimum frequency
	<b>MAXimum</b>	Maximum frequency

**Return parameter** Return the switching frequency, by the "<NR2>" string.

**Example**            :CURR:FREQ 60  
 Sets frequency to 60Hz.

**Query example**    :CURR:FREQ?  
 >60  
 Returns the switching frequency as 60Hz.

**Related Commands**    :CURRent:DUTY

---

Set →  
 → Query

**:CURRent:DUTY**

**Description**      Sets and queries for “Duty” % of the CC dynamic mode.  
 This command applies in “Dyna.Time” is “Freq/Duty”.

**Syntax**            :CURRent:DUTY {<NRf> | MINimum | MAXimum }

**Query Syntax**     :CURRent:DUTY?

<b>Parameter</b>	<b>&lt;NRf&gt;</b>	Sets the duty cycle as a percentage.
------------------	--------------------	--------------------------------------

	MINimum	Minimum duty cycle
	MAXimum	Maximum duty cycle
Return parameter	Return the duty cycle of positive, by the "<NR2>" string.	
Example	:CURR:DUTY 50 Sets the duty cycle 50%.	
Query example	:CURR:DUTY? >50 Returns the duty cycle as 50%.	
Related Commands	:CURRent:FREQuency	

**:CURRent:RECall**

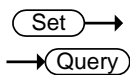

Description	Sets or queries whether A Value or B Value is the currently active value in CC static mode.	
Syntax	:CURRent:RECall {A   0   B   1}	
Query Syntax	:CURRent:RECall?	
Parameter	A or 0	CC active setting = A value
	B or 1	CC active setting = B value
Return parameter	0	CC active setting = A value
	1	CC active setting = B value
Example	:CURR:REC A Sets A value of CC setting mode to active.	
Query example	:CURR:REC? >0 Return the CC active setting.	

## Resistance Subsystem Commands

:RESistance[:VA]	90
:RESistance[:VA]:TRIGgered	91
:RESistance:VB	91
:RESistance:SRATe	92
:RESistance:L1	93
:RESistance:L2	93
:RESistance:SET	94
:RESistance:LEVel	95
:RESistance:RISE	95
:RESistance:FALL	96
:RESistance:T1	97
:RESistance:T2	97
:RESistance:FREQuency	98
:RESistance:DUTY	99
:CONDuctance[:VA]	99
:CONDuctance[:VA]:TRIGgered	100
:CONDuctance:VB	100
:CONDuctance:L1	101
:CONDuctance:L2	102
:CONDuctance:SET	103
:CONDuctance:RECall	103
:RESistance:RECall	104

**:RESistance[:VA]**

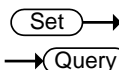

**Description** Sets and queries for the “A Value” resistance of the CR static mode.



Note

A different value can be set for each current range (High/Mid/Low).

The optional command node [:VA] can only be omitted when in static mode.

**Syntax** :RESistance[:VA] {<NRF>[OHM] | MINimum | MAXimum }

**Query Syntax** :RESistance[:VA]?

**Parameter** <NRF>[OHM] “A Value” resistance value

	MINimum	Minimum resistance level
	MAXimum	Maximum resistance level
Return parameter	Return the resistance value of "A Value", by the "<NR2>" string.	
Example	:RES:VA MIN Sets the resistance value to the minimum.	
Query example	:RES:VA? >9.840 Return the resistance value( $\Omega$ ) of "A Value".	

**:RESistance[:VA]:TRIGgered** (Set) →

Description	Set the resistance value when the trigger is activated.	
Syntax	:RESistance[:VA]:TRIGgered {<NRf>[OHM]   MINimum   MAXimum }	
Parameter	<NRf>[OHM]	"A Value" resistance value
	MINimum	Minimum resistance level
	MAXimum	Maximum resistance level
Example	:RES:TRIG MIN Set the minimum resistance value when the trigger is activated.	
Related Commands	*TRG, :INITiate:CONTinuous, :INITiate[:IMMEDIATE]	

**:RESistance:VB** (Set) →  
→ (Query)

Description	Sets and queries for the "B Value" resistance of the CR static mode.	
 Note	A different value can be set for each current range (High/Mid/Low).	
Syntax	:RESistance:VB {<NRf>[OHM]   MINimum   MAXimum }	

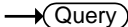
Query Syntax	:RESistance:VB?	
Parameter	<NRf>[OHM]	"B Value" resistance value
	MINimum	Minimum resistance level
	MAXimum	Maximum resistance level
Return parameter	Return the resistance value of "B Value", by the "<NR2>" string.	
Example	:RES:VB MIN Sets the resistance value to the minimum.	
Query example	:RES:VB? >9.840 Return the resistance value( $\Omega$ ) of "B Value".	
		
:RESistance:SRATe		

Description	Sets and queries for the current slew rate of CR static mode.	
Syntax	:RESistance:SRATe {<NRf>   MINimum   MAXimum }	
Query Syntax	:RESistance:SRATe?	
Parameter	<NRf>	Sets the slew rate in mA/us
	MINimum	Set to the lowest slew rate
	MAXimum	Set to the highest slew rate
Return parameter	Return the slew rate, by the "<NR2>" string.	
Example	:RES:SRAT MIN Sets the slew rate to the minimum.	
Query example	:RES:SRAT? >5.0000 Return the slew rate.	

**:RESistance:L1** 



Description	<p>Sets and queries for the "Level1" resistance of the CR dynamic mode.</p> <p>This command applies in "Dyna.Level" is "Value".</p>						
 Note	A different value can be set for each current range (High/Mid/Low).						
Syntax	:RESistance:L1 {<NRf>[OHM]   MINimum   MAXimum }						
Query Syntax	:RESistance:L1?						
Parameter	<table border="0"> <tr> <td style="background-color: #e0e0e0;">&lt;NRf&gt;[OHM]</td> <td>"level1" resistance value</td> </tr> <tr> <td style="background-color: #e0e0e0;">MINimum</td> <td>Minimum resistance level</td> </tr> <tr> <td style="background-color: #e0e0e0;">MAXimum</td> <td>Maximum resistance level</td> </tr> </table>	<NRf>[OHM]	"level1" resistance value	MINimum	Minimum resistance level	MAXimum	Maximum resistance level
<NRf>[OHM]	"level1" resistance value						
MINimum	Minimum resistance level						
MAXimum	Maximum resistance level						
Return parameter	Return the resistance value of "Level1", by the "<NR2>" string.						
Example	<p>:RES:L1 MIN</p> <p>Sets the resistance value to the minimum.</p>						
Query example	<p>:RES:L1?</p> <p>&gt;9.840</p> <p>Return the resistance value(<math>\Omega</math>) of "Level1".</p>						

**:RESistance:L2** 



Description	<p>Sets and queries for the "Level2" resistance of the CR dynamic mode.</p> <p>This command applies in "Dyna.Level" is "Value".</p>
 Note	A different value can be set for each current range (High/Mid/Low).
Syntax	:RESistance:L2 {<NRf>[OHM]   MINimum   MAXimum }

Query Syntax	:RESistance:L2?	
Parameter	<NRf>[OHM]	“level2” resistance value
	MINimum	Minimum resistance level
	MAXimum	Maximum resistance level
Return parameter	Return the resistance value of "Level2", by the "<NR2>" string.	
Example	:RES:L2 MIN Sets the resistance value to the minimum.	
Query example	:RES:L2? >9.840 Return the resistance value (Ω) of "Level2".	

Set →  
 → Query

**:RESistance:SET**

Description	Sets and queries for the “Set” resistance of the CR dynamic mode.  This command applies in “Dyna.Level” is “Percent”.	
Syntax	:RESistance:SET {<NRf>[OHM]   MINimum   MAXimum }	
Query Syntax	:RESistance:SET?	
Parameter	<NRf>[OHM]	“The resistance value at the time of "Level=100%"
	MINimum	Minimum resistance value
	MAXimum	Maximum resistance value
Return parameter	Return the resistance value of "Level = 100%", by the "<NR2>" string.	
Example	:RES:SET MIN Sets the minimum resistance value of "Level = 100%".	



Query example :RES:SET?  
>9.840

Return the resistance value ( $\Omega$ ) of "Level = 100%".

→ Set →

**:RESistance:LEVel**

→ Query

**Description** Sets and queries for the "Level" % (percentage of the Set conductance value) of the CR dynamic mode.

This command applies in "Dyna.Level" is "Percent".

**Syntax** :RESistance:LEVel {<NRf> | MINimum | MAXimum }

**Query Syntax** :RESistance:LEVel?

<b>Parameter</b>	<NRf>	% of "Set" value level (unit is %)
	MINimum	Minimum % of "Set" conductance level
	MAXimum	Maximum % of "Set" conductance level

**Return parameter** Return the Millisiemens of "% Level", by the "<NR2>" string.

**Example** :RES:LEV MIN  
Sets the % level Millisiemens value to the minimum.

**Query example** :RES:LEV?  
>50  
Return the Millisiemens of "50% Level".

**Related Commands** :RESistance:SET

→ Set →

**:RESistance:RISE**

→ Query

**Description** Sets and queries for the rising current slew rate of the CR dynamic mode.

**Syntax** :RESistance:RISE {<NRf> | MINimum | MAXimum }

**Query Syntax** :RESistance:RISE?

<b>Parameter</b>	<NRf>	Rising current slew rate(unit is [mA/us])
------------------	-------	---

MINimum	Minimum slew rate
MAXimum	Maximum slew rate

Return parameter Return the rise of the slew rate, by the "<NR2>" string.

Example :RES:RISE MIN  
Sets the rising slew rate to the minimum.

Query example :RES:RISE?  
>50.000  
Return the rise of the slew rate.

Related :RESistance:FALL  
Commands

**:RESistance:FALL**

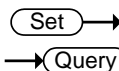

Description Sets and queries for the falling current slew rate of the CR dynamic mode.

Syntax :RESistance:FALL {<NRf> | MINimum | MAXimum }

Query Syntax :RESistance:FALL?

Parameter	<NRf>	Falling slew rate (unit is [mA/us])
	MINimum	Minimum slew rate
	MAXimum	Maximum slew rate

Return parameter Return the falling of the conductance slew rate, by the "<NR2>" string.

Example :RES:FALL MIN  
Sets the falling slew rate to the minimum.

Query example :RES:FALL?  
>50.000  
Return the falling of the slew rate.

Related :RESistance:RISE  
Commands

**:RESistance:T1**

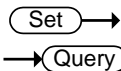

Description	Sets and queries for the “Timer1” time of CR dynamic mode.  This command applies in “Dyna.Time” is “T1/T2”.						
Syntax	:RESistance:T1 {<NRf>[s]   MINimum   MAXimum }						
Query Syntax	:RESistance:T1?						
Parameter	<table border="1"> <tr> <td>&lt;NRf&gt;[s]</td> <td>T1 timer setting. (unit is seconds)</td> </tr> <tr> <td>MINimum</td> <td>Minimum time</td> </tr> <tr> <td>MAXimum</td> <td>Maximum time</td> </tr> </table>	<NRf>[s]	T1 timer setting. (unit is seconds)	MINimum	Minimum time	MAXimum	Maximum time
<NRf>[s]	T1 timer setting. (unit is seconds)						
MINimum	Minimum time						
MAXimum	Maximum time						
Return parameter	Return the setting of the timer T1, by the "<NR2>" string.						
Example	:RES:T1 0.2  Sets the setting of the timer T1.						
Query example	: RES:T1? >0.2  Return the setting of the timer T1.						
Related Commands	:RESistance:T2						

**:RESistance:T2**

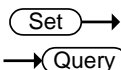

Description	Sets and queries for the “Timer2” time of CR dynamic mode.  This command applies in “Dyna.Time” is “T1/T2”.				
Syntax	:RESistance:T2 {<NRf>[s]   MINimum   MAXimum }				
Query Syntax	:RESistance:T2?				
Parameter	<table border="1"> <tr> <td>&lt;NRf&gt;[s]</td> <td>T2 timer setting. (unit is seconds)</td> </tr> <tr> <td>MINimum</td> <td>Minimum time</td> </tr> </table>	<NRf>[s]	T2 timer setting. (unit is seconds)	MINimum	Minimum time
<NRf>[s]	T2 timer setting. (unit is seconds)				
MINimum	Minimum time				

	<b>MAXimum</b> Maximum time
Return parameter	Return the setting of the timer T2, by the "<NR2>" string.
Example	:RES:T2 0.2 Sets the setting of the timer T2.
Query example	:RES:T2? >0.2 Return the setting of the timer T2.
Related Commands	:RESistance:T1

:RESistance:FREQUENCY 



Description	Sets and queries for "Frequency" value of the CR dynamic mode. This command applies in "Dyna.Time" is "Freq/Duty".	
Syntax	:RESistance:FREQUENCY {<NRf>   MINimum   MAXimum }	
Query Syntax	:RESistance:FREQUENCY?	
Parameter	<NRf>	Sets the switching frequency. (unit is hertz)
	MINimum	Minimum frequency
	MAXimum	Maximum frequency
Return parameter	Return the switching frequency, by the "<NR2>" string.	
Example	:RES:FREQ 60 Sets frequency to 60Hz.	
Query example	:RES:FREQ? >60 Returns the switching frequency as 60Hz.	
Related Commands	:RESistance:DUTY	

Set →

→ Query

**:RESistance:DUTY**

Description	Sets and queries for “Duty” % of the CR dynamic mode.  This command applies in “Dyna.Time” is “Freq/Duty”.	
Syntax	:RESistance:DUTY {<NRf>   MINimum   MAXimum }	
Query Syntax	:RESistance:DUTY?	
Parameter	<NRf>	Sets the duty as a percentage.
	MINimum	Minimum duty
	MAXimum	Maximum duty
Return parameter	Return the duty cycle of positive, by the "<NR2>" string.	
Example	:RES:DUTY 50  Sets the duty cycle 50%.	
Query example	:RES:DUTY? >50  Returns the duty cycle as 50%.	
Related Commands	:RESistance:FREQuency	

Set →

→ Query

**:CONDuctance[:VA]**

Description	Sets and queries for the “A Value” conductance of the CR static mode.	
 Note	A different value can be set for each current range (High/Mid/Low).  The optional command node [:VA] can only be omitted when in static mode.	
Syntax	:CONDuctance [:VA] {<NRf>[mS]   MINimum   MAXimum }	
Query Syntax	:RESistance[:VA]?	

Parameter	<NRf>[mS]	"A Value" conductance value. Unit is [mS]
	MINimum	Minimum conductance level
	MAXimum	Maximum conductance level
Return parameter	Return the conductance value of "A Value", by the "<NR2>" string.	
Example	:COND:VA MIN Sets the conductance value to the minimum.	
Query example	:COND:VA? >9.840 Return the conductance value (mS) of "A Value".	

**:CONDuctance[:VA]:TRIGgered** (Set) →

Description	Set the conductance value when the trigger is activated.	
Syntax	:CONDuctance[:VA]:TRIGgered {<NRf>[mS]   MINimum   MAXimum }	
Parameter	<NRf>[mS]	"A Value" conductance value. Unit is mS
	MINimum	Minimum conductance level
	MAXimum	Maximum conductance level
Example	:COND:TRIG MIN Set the minimum conductance value when the trigger is activated.	
Related Commands	*TRG, :INITiate:CONTinuous, :INITiate[:IMMediate]	

**:CONDuctance:VB** (Set) →  
→ (Query)

Description	Sets and queries for the "B Value" conductance of the CR static mode.
-------------	---



Note

A different value can be set for each current range (High/Mid/Low).

Syntax	:CONDuctance:VB {<NRf>[mS]   MINimum   MAXimum }	
Query Syntax	:CONDuctance:VB?	
Parameter	<NRf>[mS]	"B Value" conductance value. Unit is [mS]
	MINimum	Minimum conductance level
	MAXimum	Maximum conductance level
Return parameter	Return the conductance value of "B Value", by the "<NR2>" string.	
Example	:COND:VB MIN Sets the conductance value to the minimum.	
Query example	:COND:VB? >9.840 Return the conductance value ([mS]) of "B Value".	

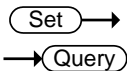

**:CONDuctance:L1**

Description	Sets and queries for the "Level1" conductance of the CR dynamic mode.  This command applies in "Dyna.Level" is "Value".	
 Note	A different value can be set for each current range (High/Mid/Low).	
Syntax	:CONDuctance:L1 {<NRf>[mS]   MINimum   MAXimum }	
Query Syntax	:CONDuctance:L1?	
Parameter	<NRf>[mS]	"level1" conductance value. Unit is [mS]
	MINimum	Minimum conductance level
	MAXimum	Maximum conductance level
Return parameter	Return the conductance value of "Level1", by the "<NR2>" string.	

Example :COND:L1 MIN  
Sets the conductance value to the minimum.

Query example :COND:L1?  
>9.840  
Return the conductance value ([mS]) of "Level1".

Set →

:CONDuctance:L2 → Query

Description Sets and queries for the "Level2" conductance of the CR dynamic mode.  
This command applies in "Dyna.Level" is "Value".

 Note A different value can be set for each current range (High/Mid/Low).

Syntax :CONDuctance:L2 {<NRf>[mS] | MINimum | MAXimum }

Query Syntax :CONDuctance:L2?

Parameter	<NRf>[mS]	"level2" conductance value. Unit is [mS]
	MINimum	Minimum conductance level
	MAXimum	Maximum conductance level

Return parameter Return the Millisiemens value of "Level2", by the "<NR2>" string.

Example :COND:L2 MIN  
Sets the conductance value to the minimum.

Query example :COND:L2?  
>9.840  
Return the conductance value ([mS]) of "Level2".

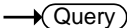

**:CONDuctance:SET** 

Description	Sets and queries for the “Set” conductance of the CR dynamic mode. This command applies in “Dyna.Level” is “Percent”.	
Syntax	:CONDuctance:SET {<NRf>[mS]   MINimum   MAXimum }	
Query Syntax	:CONDuctance:SET?	
Parameter	<NRf>[mS]	“The conductance value at the time of “Level=100%”. Unit is [mS]
	MINimum	Minimum conductance level
	MAXimum	Maximum conductance level
Return parameter	Return the conductance value of “Level = 100%”, by the “<NR2>” string.	
Example	:COND:SET MIN Sets the minimum conductance value of “Level = 100%”.	
Query example	:COND:SET? >9.840 Return the conductance value ([mS]) of “Level = 100%”.	

**:CONDuctance:RECall** 

Description	Sets or queries whether A Value or B Value is the currently active value in CR static mode when the units are set to Siemens.	
Syntax	:CONDuctance:RECall {A   0   B   1}	
Query Syntax	:CONDuctance:RECall?	
Parameter	A or 0	CR Value = A Value
	B or 1	CR Value = B Value

Return parameter	0	CR Value = A Value
	1	CR Value = B Value

Example :COND:REC A  
 Sets A value of CR conductance setting mode to active.

Query example :RES:REC?  
 >0  
 Return the CR conductance mode active setting.

**:RESistance:RECall** 



Description Sets or queries whether A Value or B Value is the currently active value in CR static mode when the units are set to ohm.

Syntax :RESistance:RECall {A | 0 | B | 1}

Query Syntax :RESistance:RECall?

Parameter	A or 0	CR Value = A Value
	B or 1	CR Value = B Value

Return parameter	0	CR Value = A Value
	1	CR Value = B Value

Example :RES:REC A  
 Sets A value of CR resistance setting mode to active.

Query example :RES:REC?  
 >0  
 Return the CR resistance mode active setting.

## Voltage Subsystem Commands

:VOLTage[:VA] .....	105
:VOLTage:VB.....	105
:VOLTage:RECall.....	106

:VOLTage[:VA] 



**Description** Sets and queries for the CV mode “A Value” voltage or the +CV voltage value.

 **Note** The same value applies for each current range (High/Mid/Low).  
The optional command node [:VA] can only be omitted when in static mode.

**Syntax** :VOLTage[:VA] {<NRf>[V] | MINimum | MAXimum }

**Query Syntax** :VOLTage[:VA]?

<b>Parameter</b>	<NRf>[V]	“A Value” voltage value
	MINimum	Minimum voltage level
	MAXimum	Maximum voltage level

**Return parameter** Return the voltage value of "A Value", by the "<NR2>" string.

**Example** :VOLT:VA MIN  
Sets the voltage value to the minimum.

**Query example** :VOLT:VA?  
>1.00  
Voltage setting of " A Value " is set to 1V.

:VOLTage:VB 



**Description** Sets and queries for the CV mode “B Value”.

 **Note** The same value applies for each current range (High/Mid/Low).

Syntax :VOLTage:VB {<NRf>[V] | MINimum | MAXimum }

Query Syntax :VOLTage:VB?

Parameter	<NRf>[V]	"B Value" voltage value
	MINimum	Minimum voltage level
	MAXimum	Maximum voltage level

Return parameter Return the voltage value of "B Value", by the "<NR2>" string.

Example :VOLT:VB MIN  
Sets the voltage value to the minimum.

Query example :VOLT:VB?  
>1.00  
Voltage setting of " B Value " is set to 1V.

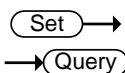

**:VOLTage:RECall**

Description Sets or queries whether A Value or B Value is the currently active value in CV mode.

Syntax :VOLTage:RECall {A | 0 | B | 1}

Query Syntax :VOLTage:RECall?

Parameter	A or 0	CV active setting = A Value
	B or 1	CV active setting = B Value
Return parameter	0	CV active setting = A Value
	1	CV active setting = B Value

Example :VOLT:REC A  
Sets A value of CV setting mode to active.

Query example :VOLT:REC?  
>0  
Return the CV active setting.

## Power Subsystem Commands

:POWer[:VA]	107
:POWer:VB	108
:POWer:L1	108
:POWer:L2	109
:POWer:SET	110
:POWer:LEVel	110
:POWer:T1	111
:POWer:T2	112
:POWer:FREQuency	112
:POWer:DUTY	113
:POWer:RECall	114

**:POWer[:VA]** 

**Description** Sets and queries for the “A Value” power of the CP static mode.

 **Note** A different current value can be set for each current range (High/Mid/Low).  
The [:VA] node can only be omitted when in static mode.

**Syntax** :POWer[:VA] {<NRf>[W] | MINimum | MAXimum }

**Query Syntax** :POWer[:VA]?

<b>Parameter</b>	<NRf>[W]	“A Value” power value
	MINimum	Minimum power level
	MAXimum	Maximum power level

**Return parameter** Return the power value of "A Value", by the "<NR2>" string.

**Example** :POW:VA MIN  
Sets the power value to the minimum.

**Query example** :POW:VA?  
>10  
Power setting of "A Value" is set to 10W.

Set →

→ Query

**:POWer:VB**

**Description** Sets and queries for the "B Value" power of the CP static mode.

 **Note** A different current value can be set for each current range (High/Mid/Low).

**Syntax** :POWer:VB {<NRf>[W] | MINimum | MAXimum }

**Query Syntax** :POWer:VB?

<b>Parameter</b>	<NRf>[W]	"B Value" power value
	MINimum	Minimum power level
	MAXimum	Maximum power level

**Return parameter** Return the power value of "B Value", by the "<NR2>" string.

**Example** :POW:VB MIN  
Sets the power value to the minimum.

**Query example** :POW:VB?  
>10  
Power setting of "B Value" is set to 10W.

Set →

→ Query

**:POWer:L1**

**Description** Sets and queries for the "Level1" power of the CP dynamic mode.

This command applies in "Dyna.Level" is "Value".

 **Note** A different "Level1" value can be set for different current ranges.

**Syntax** :POWer:L1 {<NRf>[W] | MINimum | MAXimum }

**Query Syntax** :POWer:L1?

<b>Parameter</b>	<NRf>[W]	"Level1" power value
	MINimum	Minimum power level

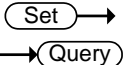
	<b>MAXimum</b> Maximum power level
Return parameter	Return the power value of "Level1", by the "<NR2>" string.
Example	:POW:L1 MIN Sets the power value to the minimum.
Query example	:POW:L1? >10 Power setting of " Level1" is set to 10W.
:POWer:L2	<div style="text-align: right;">  </div>

**Description** Sets and queries for the "Level2" power of the CP dynamic mode.  
This command applies in "Dyna.Level" is "Value".

 **Note** A different "Level2" value can be set to different current ranges.

**Syntax** :POWer:L2 {<NRf>[W] | MINimum | MAXimum }

**Query Syntax** :POWer:L2?

<b>Parameter</b>	<NRf>[W]	"Level2" power value
	<b>MINimum</b>	Minimum power level
	<b>MAXimum</b>	Maximum power level

**Return parameter** Return the power value of "Level2", by the "<NR2>" string.

**Example** :POW:L2 MIN  
Sets the power value to the minimum.

**Query example** :POW:L2?  
>10  
Power setting of " Level2" is set to 10W.

Set →  
 → Query

---

**:POWER:SET**

Description	Sets and queries for the "Set" power of the CP dynamic mode.  This command applies in "Dyna.Level" is "Percent".	
Syntax	:POWER:SET {<NRf>[W]   MINimum   MAXimum }	
Query Syntax	:POWER:SET?	
Parameter	<NRf>[W]	The power value at the time of "Level=100%"
	MINimum	Minimum power value
	MAXimum	Maximum power value
Return parameter	Return the power value of "Level = 100%", by the "<NR2>" string.	
Example	:POW:SET MIN  Sets the minimum power value of "Level = 100%".	
Query example	:POW:SET? >10  power value of "Level = 100%" is set to 10W.	
Related Commands	:POWER:LEVel	

Set →  
 → Query

---

**:POWER:LEVel**

Description	Sets and queries for the "Set" power of the CP dynamic mode.  This command applies in "Dyna.Level" is "Percent".	
Syntax	:POWER:LEVel {<NRf>   MINimum   MAXimum }	
Query Syntax	:POWER:LEVel?	
Parameter	<NRf>	% of "Set" power level (unit is %)
	MINimum	Minimum % power level



	<b>MAXimum</b> Maximum % power level
Return parameter	Return the power of "% Level", by the "<NR2>" string.
Example	:POW:LEV MIN Sets the % level power value to the minimum.
Query example	:POW:LEV? >50 Percentage of the set power value is set to 50%.
Related Commands	:POW:er:Set



Description	Sets and queries for the "Timer1" time of CP dynamic mode. This command applies in "Dyna.Time" is "T1/T2".
Syntax	:POW:er:T1 {<NRf>[s]   MINimum   MAXimum }
Query Syntax	:POW:er:T1?
Parameter	<b>&lt;NRf&gt;[s]</b> T1 timer setting. (unit is seconds) <b>MINimum</b> Minimum time <b>MAXimum</b> Maximum time
Return parameter	Return the setting of the timer T1, by the "<NR2>" string.
Example	:POW:er:T1 0.2 Sets the setting of the timer T1.
Query example	:POW:er:T1? >0.2 Return the setting of the timer T1.
Related Commands	:POW:er:T2

**:POWer:T2** 
 →  
 →

Description	Sets and queries for the "Timer2" time of CP dynamic mode.  This command applies in "Dyna.Time" is "T1/T2".	
Syntax	:POWer:T2 {<NRf>[S]   MINimum   MAXimum }	
Query Syntax	:POWer:T2?	
Parameter	<NRf>[S]	T2 timer setting. (unit is seconds)
	MINimum	Minimum time
	MAXimum	Maximum time
Return parameter	Return the setting of the timer T2, by the "<NR2>" string.	
Example	:POW:T2 0.2  Sets the setting of the timer T2.	
Query example	:POW:T2? >0.2  Returns the setting of the timer T2.	
Related Commands	:POWer:T1	

**:POWer:FREQuency** 
 →  
 →

Description	Sets and queries for "Frequency" value of the CP dynamic mode.  This command applies in "Dyna.Time" is "Freq/Duty".	
Syntax	:POWer:FREQuency {<NRf>   MINimum   MAXimum }	
Query Syntax	:POWer: FREQuency?	
Parameter	<NRf>	Sets the switching frequency. (unit is hertz).

	MINimum	Minimum frequency
	MAXimum	Maximum frequency
Return parameter	Return the switching frequency, by the "<NR2>" string.	
Example	:POW: FREQ 60 Sets the frequency to 60Hz.	
Query example	:POW: FREQ? >60 Returns the switching frequency as 60Hz.	
Related Commands	:POWer: DUTY	

**:POWer:DUTY**

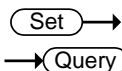

Description	Sets and queries for "Duty" % of the CP dynamic mode.  This command applies in "Dyna.Time" is "Freq/Duty".	
Syntax	:POWer:DUTY {<NRf>   MINimum   MAXimum }	
Query Syntax	:POWer:DUTY?	
Parameter	<NRf>	Sets the duty cycle as a percentage.
	MINimum	Minimum duty
	MAXimum	Maximum duty
Return parameter	Return the duty cycle of positive, by the "<NR2>" string.	
Example	:POW:DUTY 50 Sets the duty cycle 50%.	
Query example	:POW:DUTY? >50 Returns the duty cycle as 50%.	
Related Commands	:POWer:FREQuency	

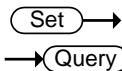

**:POWER:RECall**

Description	Sets or queries whether A Value or B Value is the currently active value in CP mode.	
Syntax	:POWER:RECall {A   0   B   1}	
Query Syntax	:POWER:RECall?	
Parameter	A or 0	CP active setting = A Value
	B or 1	CP active setting = B Value
Return parameter	0	CP active setting = A Value
	1	CP active setting = B Value
Example	:POW:REC A Sets A value of CP setting mode to active.	
Query example	:POW:REC? >0 Return the CP active setting.	

## Program Commands

To execute / stop the program function, use: INPUT command.

:FUNction[:COMPLete][:RING]:TIME .....	115
:PROGram:STATe .....	116
:PROGram .....	117
:PROGram[:RECall]:DEFault .....	118
:PROGram:STARt.....	118
:PROGram:STEP.....	119
:PROGram:MEMory.....	119
:PROGram:RUN.....	120
:PROGram:ONTime.....	120
:PROGram:OFFTime .....	121
:PROGram:PFTime.....	121
:PROGram:STIME.....	122
[:PROGram]:CHAin:STARt .....	123
[:PROGram]:CHAin.....	123
[:PROGram]:CHAin:P2P .....	124
[:PROGram]:CHAin[:RECall]:DEFault.....	125
:PROGram:SAVE.....	125

### :FUNction[:COMPLete][:RING]:TIME

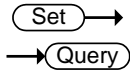

Description	Sets and queries for how long the alarm will buzz for after a program, NSEQ, FSEQ or OCP test function has finished.	
Syntax	:FUNction[:COMPLete][:RING]:TIME {<NR1>   MINimum   MAXimum   INFINITY}	
Query Syntax	:FUNction[:COMPLete][:RING]:TIME? [MINimum   MAXimum]	
Parameter	<NR1>	Alarm time in seconds (0~600); 0 = OFF
	MINimum	Minimum alarm time
	MAXimum	Maximum alarm time
	INFINITY	Sets the alarm time to infinity.
Return parameter	<NR1>	Alarm time in seconds

Infinity	Infinite
OFF	Function complete ring time is off.

Example :FUNC:TIME 5  
Sets the function complete ring time to 5s.

Query example :FUNC:TIME?  
>5  
The function complete ring time is set as 5s.

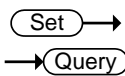

**:PROG:STATe**

Description Sets and queries for the state of the program function.

Syntax :PROG:STATe {ON | OFF | PAUSE | CONTINUE | NEXT}

Query Syntax :PROG:STATe?

Parameter	ON	Turn program function on
	OFF	Program function off
	PAUSE	Program function pause
	RUN	Program function running
	CONTINUE	Program function continue
	NEXT	Next step in the program function

Return parameter Return the state of the program function.  
Return the on status of program function, by the "ON,{STOP | RUN | PAUSE}" string. ("STOP": stopped, "RUN": running, "PAUSE": paused)  
Return the off status of program function, by the "OFF" string: Program function is off.

Example :PROG:STAT ON  
Turn program function on.

Query example :PROG:STAT?  
 >ON,STOP  
 Return the state of the program function.

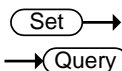

## :PROGram

Description Sets and queries for all parameters to specified step of the program function.

Parameters of “Timing Edit for Program”

Syntax :PROGram (1),(2),(3),(4),(5),(6),(7),(8)

Query Syntax :PROGram?

Parameter	(1) <NR1>	Program number (1~16)
	(2) <NR1>	Step number (1~16)
	(3) <NR1>	Internal memory number (1~256)
	(4) <ASCII string>	Processing settings AUTO: Run processing MANUAL: Wait for the start-up process. SKIP: Proceed to the next step
	(5) <NRf>	On-time (0.1~60)s
	(6) <NRf>	Off-time (Off,0.1~60)s
	(7) <NRf>	Delay time of the P/F (Off,0.0 ~119.9)s
	(8) <NRf>	Short time (Off,0.1 ~ On-Time)s
Return parameter	(1) <ASCII string>	Return the program function.{ON OFF}
	(2) <ASCII string>	Program number
	(3) <ASCII string>	Step number
	(4) <ASCII string>	Internal memory number
	(5) <ASCII string>	Processing is returned by Auto/Manual/Skip.

- (6) <ASCII string> On-time (unit is seconds)
- (7) <ASCII string> Off-time (unit is seconds)
- (8) <ASCII string> Delay time of the P/F (unit is seconds)
- (9) <ASCII string> Short time (unit is seconds)

**Example** :PROG 2,3,1,AUTO,40.1,0,0,0  
 Set all the parameters to specified program step.

**Query example** :PROG?  
 >Program:OFF; Start:1, Step:1, Memory:1, Run:Skip, On-Time:0.1, Off-Time:0.0, P/F-Time:0.0, Short-Time:0.0  
 Return the parameters of the program step that is selected after the state of the program function.

**:PROG[RECALL]:DEFAULT** (Set) →

**Description** All steps of a selected program are set by default value.

**Syntax** :PROG[RECALL]:DEFAULT

**Example** :PROG:DEF  
 All steps of a selected program are set by default value.

(Set) →

**:PROGRAM:START** → (Query)

**Description** Sets and queries for select program number. (Contents of PROG: )

**Syntax** :PROGRAM:START <NR1>

**Query Syntax** :PROGRAM:START?

**Parameter** <NR1> Program number to select. (1~16)

**Return parameter** Return the Program number in selected, by the "Start:<NR1>" string.



Example	:ROG:STAR 1 Sets to 1 of program number.
Query example	:PROG:STAR? >Start:1 Return The selected program number.

### :PROG:STEP

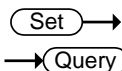

Description	Sets and queries for the step number of the program to select. (Contents of STEP:)
Syntax	:PROG:STEP <NR1>
Query Syntax	:PROG:STEP?
Parameter	<NR1> Step number to select. (1~16)
Return parameter	Return the step number of the program, by the "Step:<NR1>" string.
Example	:PROG:STEP 1 Sets to 1 of step number.
Query example	:PROG:STEP? >Step:1 Return the step number of the program.

### :PROG:MEMory

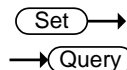

Description	Sets and queries for memory number of selected program steps. (Contents of Memory:)
Syntax	:PROG:MEMory <NR1>
Query Syntax	:PROG:MEMory?
Parameter	<NR1> Sets the memory number. (1~256)
Return parameter	Return the memory number of selected, by the "Memory:M<NR1>" string.
Example	:PROG:MEM 1 Sets to 1 of memory number.

Query example :PROG:MEM?  
 >Memory:M 1  
 Return the memory number of selected.

Set →

**:PROG:RUN**

→ Query

Description Sets and queries for execution process of selected program steps. (Contents of Run: )

Syntax :PROG:RUN { AUTO | MANual | SKIP}

Query Syntax :PROG:RUN?

Parameter	AUTO	Sets to auto-run processing.
	MANual	Sets to wait run.
	SKIP	Sets to the next processing steps.

Return parameter Return the execution process, by the "Run:{Auto | Manual | Skip}" string.

Example :PROG:RUN AUTO  
 Sets to auto-run processing.

Query example :PROG:RUN?  
 >Run:Auto  
 Return the execution process.

Set →

**:PROG:ONTime**

→ Query

Description Sets and queries for On time of selected program steps. (Contents of On-Time: )

Syntax :PROG:ONTime <NRf>

Query Syntax :PROG:ONTime?

Parameter	<NRf>	On time (0.1~60 seconds)
-----------	-------	--------------------------

Return parameter Return the On time of selected program steps, by the "On-Time:<NR2>" string.

Example :PROG:ONT 1  
 Sets to 1 second On time.

Query example :PROG:ONT?  
 >On-Time:0.1  
 Return in seconds On time.

Related :PROG:PFTime  
 Commands :PROG:STIME

**:PROG:OFFTime**

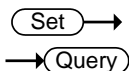

Description Sets and queries for Off time of selected program steps. (Contents of Off-Time: )

Syntax :PROG:OFFTime {<NRf> | OFF}

Query Syntax :PROG:OFFTime?

Parameter	<NRf>	Off time (Off,0.1~60 seconds) Setting of 0 is off Setting function.
	OFF	Setting off function

Return parameter Return the Off time of selected program steps, by the "Off-Time:<NR2>" string.  
 "Off-Time:0.0" is a function off.

Example :PROG:PFT 1  
 Sets to 1 second Off time.

Query example :PROG:OFFT?  
 >Off-Time:1.0  
 Return the Off time.

Related :PROG:PFTime  
 Commands

**:PROG:PFTime**

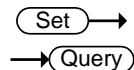

Description The pass / fail judgment (Go-NoGo Test) of the program selected step.  
 Sets and queries for the judgment delay time. (Contents of P/F-Time: )

Syntax :PROG:PFTime {<NRf> | OFF}

Query Syntax	:PROG:PFTime?	
Parameter	<NRf>	Set in seconds the judgment delay time. (Off,0.0~119.9)s  0 setting is off a judgment function.
	OFF	Sets off Judgment function
Return parameter	Return the judgment delay time, by the "P/F-Time:<NR2>" string.  "P/F-Time:0.0" is a function off.	
Example	:PROG:PFT 1  Delay time of the judgment sets 1 second.	
Query example	:PROG:PFT >P/F-Time:1.0  Return the judgment delay time.	
Related Commands	:PROG:OFFTime :PROG:ONTime	

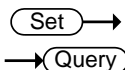



**:PROG:STIME**

Description	Sets and queries for load short time of selected program step. (Contents of Short-Time: )	
Syntax	:PROG:STIME <NR1>	
Query Syntax	:PROG:STIME?	
Parameter	<NRf>	Sets in time seconds of load short time. (Off,0.1 ~ On-Time)s  0 setting is the off feature of load short.
	OFF	Sets the off feature of load short.
Return parameter	Return the setting time of load short, by the "Short-Time:<NR2>" string.	
Example	:PROG:STIM 1  Sets to 1 second of load short.	

Query example :PROG:STIM?  
>Short-Time:0.0  
Return the setting time of load short.

Related :PROG:ONTime  
Commands

 →  
 → 

**[[:PROG:]:CHAI:STARt**

Description Sets and queries for the start program number of the program chain. (Contents of Start)  
Parameters of "Program Chain Set"

Syntax [[:PROG:]:CHAI:STARt <NR1>

Query Syntax [[:PROG:]:CHAI:STARt?

Parameter <NR1> Start program number.

Return parameter Return the start program number, by the "P<NR1>" string.

Example :CHA:STAR 1  
Sets to number 1 start program.

Query example :CHA:STAR?  
>P1  
Return the start program number.

 →  
 → 

**[[:PROG:]:CHAI**

Description Sets and queries for all chain of the program chain. (Contents of PXX)

Syntax [[:PROG:]:CHAI  
(1),(2),(3),(4),(5),(6),(7),(8),(9),(10),(11),(12),(13),(14),(15),(16)

Query Syntax [[:PROG:]:CHAI?

Parameter (1)~(16) <NR1> Is a program number to be chain. "OFF" sets off the chain.

Return parameter	<ASCII string>	Return the setting value of all program chain. "Off" is the end of the chain.
Example	<p>:CHA 4,OFF,OFF,5,6,OFF,OFF,OFF,OFF,OFF,OFF,OFF,OFF,OFF,OFF</p> <p>Configures the program chain as follows:</p> <p>P01→P04→P05→P06→OFF</p>	
Query example	<p>:CHA?</p> <p>&gt;P1-&gt;P4;P2-&gt;Off;P3-&gt;Off;P4-&gt;P5;P5-&gt;P6;P6-&gt;Off;P7-&gt;Off;P8-&gt;Off;P9-&gt;Off;P10-&gt;Off;P11-&gt;Off;P12-&gt;Off;P13-&gt;Off;P14-&gt;Off;P15-&gt;Off;P16-&gt;Off</p> <p>Return the setting value of all program chain.</p>	

**[[:PROG]am]:CHAin:P2P**

Description	Sets and queries for a single link in the program chain.	
Syntax	[:PROG]am]:CHAin:P2P (1),(2)	
Query Syntax	[:PROG]am]:CHAin:P2P? PX	
Parameter	(1) <NR1>	(1~16) Program number of single link.
	(2) {<NR1>   OFF}	(1~16) Program number that follows.
Query parameter	PX	P1~P16 The program number of the first link of the chain that you are inquiring about.
Return parameter	PX→PX OFF	Returns the program number that follows or OFF.
Example	<p>:CHA:P2P 4,3</p> <p>Program 4 will chain set in the program 3.P4→P3</p>	

Query example    :CHA:P2P? P4  
                   >P4->3  
 Indicates that program 3 follows from program 4 in  
 the chain.P4→P3

**[:PROGram]:CHAI[:RECall]:DEFault** (Set) →

Description	Turn off all the program chains.
Syntax	[:PROGram]:CHAI[:RECall]:DEFault
Example	:CHA:DEF Turn off all the program chain.

**:PROGram:SAVE** (Set) →

Description	Save program.
Syntax	:PROG:SAVE
Example	:PROG:SAVE Save program.

## Normal sequence Commands

To execute / stop the test, use: INPUT command.

:NSEquence:STATe .....	126
:NSEquence .....	127
:NSEquence:STARt .....	129
:NSEquence:NUMBer .....	130
:NSEquence:MEMO .....	130
:NSEquence:MODE .....	131
:NSEquence:RANGe .....	131
:NSEquence:LOOP .....	132
:NSEquence:LLOAD .....	133
:NSEquence:LAST .....	133
:NSEquence:CHAin .....	134
:NSEquence:EDIT .....	134
:NSEquence:EDIT:POINT .....	136
:NSEquence:EDIT:END .....	136
:NSEquence[:DELet]:ALL .....	136
:NSEquence:SAVE .....	137
:NSEquence:COTime .....	137

### :NSEquence:STATe

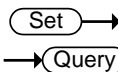

Description	Sets and queries for the state of the Normal Sequence function.	
Syntax	:NSEquence:STATe {OFF ON PAUSE CONTINUE EXT}	
Query Syntax	:NSEquence:STATe?	
Parameter	OFF	Normal sequence function Off
	ON	Normal sequence function On
	PAUSE	Pause sequence function
	CONTINUE	Continue sequence function
	NEXT	Go to next sequence function



**Return parameter** Return the state of the normal sequence function.

Return the on status of the normal sequence function, by the “ON, {STOP | RUN | PAUSE}” string. (“STOP”: stopped, “RUN”: running, “PAUSE”: Suspended)

Return the off status of the normal sequence function, by the “OFF” string. Normal sequence function is off

**Example** :PROG:STAT ON

Turn on the normal sequence function.

**Query example** :PROG:STAT?

>ON,STOP

Return the state of the normal sequence function.

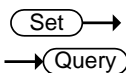

**:NSEquence**

**Description** Sets and queries for parameters of the Normal Sequence function.

Parameters of “Timing Edit for Normal Sequence”



**Note**

Cannot change the range and mode of the load when there is a step data.

**Syntax** :NSEquence (1),(2),(3),(4),(5),(6),(7),(8),(9)

**Query Syntax** :NSEquence?

<b>Parameter</b>	(1) <NR1>	Sets the start sequence number.(1~10)
	(2) <NR1>	Sets the sequence number.(1~10)
	(3) <ASCII string>	Sets the note of up to 12 characters.
		Enclose the string in double coat.
	(4) <ASCII string>	Sets the load mode. {CC   CR   CV   CP}

	(5) <ASCII string>	Sets the load range. {IHVH   IMVH   ILVH   IHVL   IMVL   ILVL}
	(6) <ASCII string>	Sets the loop count of the sequence.  <NR1> 0 is infinite times. 1~9999. INFINITY
	(7) <ASCII string>	Sets the Last Load after the end. {ON   OFF}
	(8) <NRf>	Sets the Last Value after the end. (The Last Load ON is enabled by ON.)
	(9) <ASCII string>	Sets the chain of the next sequence.  <NR1> : Sequence number OFF : No chain
Return parameter	(1) <ASCII string>	Return whether it is in normal sequence function state. {ON OFF}
	(2) <ASCII string>	Return the start sequence number setting.
	(3) <ASCII string>	Return the sequence number setting.
	(4) <ASCII string>	Return the contents of the memo.
	(5) <ASCII string>	Return the load mode setting. {CC   CR   CV   CP}
	(6) <ASCII string>	Return the load range setting. {IHVH   IMVH   ILVH   IHVL   IMVL   ILVL}
	(7) <ASCII string>	Return the loop count of the sequence. (Infinite times is the string "Infinity".)

(8) <ASCII string>	Return the Last Load after the end. {ON OFF}
(9) <ASCII string>	Return the Last Value after the end.
(10)<ASCII string>	Return the chain setting of the next sequence. (No-chain is a string "OFF".)

**Example** :NSEQ 1,1,"ABC",CC,ILVL,5,ON,1.5000,OFF  
 Sets the parameters of "Timing Edit for Normal Sequence".

**Query example** :NSEQ?  
 >NSeq:ON; Start:1, Seq No:1, Memo:ABC, Mode:CC, Range:ILVL, Loop:5, Last Load:ON, Last:1.5000, Chain:Off  
 Return the parameters of "Timing Edit for Normal Sequence".

**:NSEquence:START**

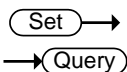

**Description** Sets and queries for the start sequence number of the normal sequence. (Contents of Start: )

**Syntax** :NSEquence:START <NR1>

**Query Syntax** :NSEquence:START?

**Parameter** <NR1> Sets the start sequence number. (1~10)

**Return parameter** Return the start sequence number of the normal sequence, by the "Start:<NR1>" string.

**Example** :NSEQ:STAR 1  
 Sets the start sequence number of the normal sequence.

**Query example** :NSEQ:STAR?  
 >Start:1  
 Return the start sequence number of normal sequence.

Set →  
 → Query

**:NSEquence:NUMBER**

Description	Sets and queries for the sequence number of the normal sequence. (Contents of Seq.No: )
Syntax	:NSEquence:NUMBER <NR1>
Query Syntax	:NSEquence:NUMBER?
Parameter	<NR1> Sets the sequence number. (1~10)
Return parameter	Return the sequence number of the normal sequence by the "Seq No:<NR1>" string.
Example	:NSEQ:NUMB 1 Sets to 1 of normal sequence number.
Query example	:NSEQ:NUMB? >Seq No:1 Return a sequence number that is selected.

Set →  
 → Query

**:NSEquence:MEMO**

Description	Sets and queries for the memo string of normal sequence. (Contents of Memo: )
Syntax	:NSEquence:MEMO <ASCII string>
Query Syntax	:NSEquence:MEMO?
Parameter	<ASCII string> Set the characters up to 12 characters. Enclose the string in double coat.
Return parameter	Return the memo of normal sequence that is selected, by the "Memo:<ASCII string>" string.
Example	:NSEQ:MEMO "ABCD" Sets the memo of step.
Query example	:NSEQ:MEMO? >Memo:ABCD Return the memo of step.

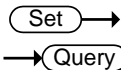

**:NSEquence:MODE**

Description	Sets and queries for the operating mode of the selected normal sequence. (Contents of Mode: )	
Syntax	:NSEquence:MODE {CC   CR   CV   CP}	
Query Syntax	:NSEquence:MODE?	
Parameter	CC	Sets to constant current mode.
	CR	Sets to constant resistance mode.
	CV	Sets to constant voltage mode.
	CP	Sets to constant power mode.
Return parameter	Return the operating mode of the normal sequence, by the “Mode:{CC   CR   CV   CP}” string.	
Example	:NSEQ:MODE CC Sets the operating mode of the normal sequence.	
Query example	:NSEQ:MODE? >Mode:CC Return the operating mode of the normal sequence.	

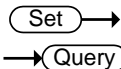

**:NSEquence:RANGe**

Description	Sets and queries for the operating range of the selected normal sequence. (Contents of Range: )	
Syntax	:NSEquence:RANGe { IHVH   IMVH   ILVH   IHVL   IMVL   ILVL}	
Query Syntax	:NSEquence:RANGe?	
Parameter	IHVH	Sets High current range and High voltage range.
	IMVH	Sets Middle current range and High voltage range.
	ILVH	Sets Low current range and High voltage range.

IHVL	Sets High current range and Low voltage range.
IMVL	Sets Middle current range and Low voltage range.
ILVL	Sets Low current range Low voltage range.

**Return parameter** Return the operating range of the normal sequence, by the "Range:{IHVH | IMVH | ILVH | IHVL | IMVL | ILVL}" string.

**Example** :NSEQ:RANG IHVL  
Sets operating of High current range and Low voltage range.

**Query example** :NSEQ:RANG?  
> Range:IHVL  
Return the operating range of settings.

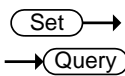

**:NSEQ:LOOP**

**Description** Sets and queries for number of loops of normal sequence. (Contents of Loop: )

**Syntax** :NSEQ:LOOP {<NR1> | INFinity }

**Query Syntax** :NSEQ:LOOP?

<b>Parameter</b>	<NR1>	Loop count setting. (1~9999)
	INFinity	Infinite number of times.

**Return parameter** Return the number of loops of normal sequence, by the "Loop:{<NR1> | Infinity}" string.

**Example** :NSEQ:LOOP 1  
Sets 1 to loop count of normal sequence.

**Query example** :NSEQ:LOOP?  
>Loop:Infinity  
Return the loop number of normal sequence.

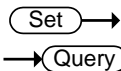

**:NSequence:LLOAD**

Description	Sets and queries for the Last Load state after the end of the normal sequence. (Contents of Last Load: )	
Syntax	:NSequence:LLOAD {ON   OFF}	
Query Syntax	:NSequence:LLOAD?	
Parameter	ON	Turns Last Load on.
	OFF	Turns Last Load off.
Return parameter	Return the Last Load state of the load after the end of the step, by the “Last Load:{ON   OFF}” string.	
Example	:NSEQ:LLOAD ON Turns Last Load on.	
Query example	:NSEQ:LLOAD? >Last Load:OFF Return the Last Load state after the end of the step.	
Related Commands	:NSequence:LAST	

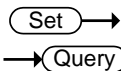

**:NSequence:LAST**

Description	Sets and queries for load value after the end of the normal sequence. (Contents of Last: )	
Syntax	:NSequence:LAST <NR2>	
Query Syntax	:NSequence:LAST?	
Parameter	<NR2>	Sets load value after the end of step.
Return parameter	Return load value of after the step the end, by the “Last:<NR2>” string.	
Example	:NSEQ:LAST 1 Sets load value of after the step the end.	

Query example :NSEQ:LAST?  
 >Last:1.00  
 Return load value of after the step the end.

Related :NSEquence:LLOAD  
 Commands

:NSEquence:CHAIIn (Set) →  
 → (Query)

Description Query and settings for the next sequence in the chain. (Contents of Chain: )

Syntax :NSEquence:CHAIIn {<NR1> | OFF}

Query Syntax :NSEquence:CHAIIn?

Parameter	<b>&lt;NR1&gt;</b>	The sequence number of the next sequence in the chain.
	OFF	chain is end.

Return parameter Return the chain of Normal sequence number, by the “Chain: {<NR1>|Off}” string. “Off” is the end of the chain.

Example :NSEQ:CHA 1  
 Sets the next sequence in the chain as S01.

Query example :NSEQ:CHA?  
 >Chain:1  
 Returns the next sequence in the chain (S01).

:NSEquence:EDIT (Set) →  
 → (Query)

Description Sets and queries for the data edit of normal sequence.  
 Parameters of “Data Edit for Normal Sequence”

Syntax :NSEquence:EDIT  
 (1),(2),(3),(4),(5),(6),(7),(8),(9),(10),(11)

Query Syntax :NSEquence:EDIT?

Parameter **(1) <NR1>** The edit step number.



	(2) <NR1>	The total number of steps.
	(3) <NRf>	Sets a load value of operation mode.
	(4) <NR1>	Sets hours.
	(5) <NR1>	Sets minute.
	(6) <NR1>	Sets seconds.
	(7) <NR1>	Sets milliseconds.
	(8) <ASCII string>	Load setting. {ON   OFF}
	(9) <ASCII string>	Lamp operation setting. {ON   OFF}
	(10)<ASCII string>	Trigger Output setting. {ON   OFF}
	(11)<ASCII string>	PAUSE Setting. {ON   OFF}
Return parameter	(1) <ASCII string>	Return the edit step number/total step number.
	(2) <ASCII string>	Return the setting value of the load of the operating mode.
	(3) <ASCII string>	Return the set time.
	(4) <ASCII string>	Return the setting of the load state.
	(5) <ASCII string>	Return the setting of the lamp operation.
	(6) <ASCII string>	Return the setting of TRIG OUT.
	(7) <ASCII string>	Return the setting of pause.
Example	:NSEQ:EDIT 1,2,1,1,2,3,4,OFF,OFF,OFF,OFF Sets the data of normal step sequence program.	
Query example	:NSEQ:EDIT? > Step:1/2, Value:1.000, Time:1H:2M:3S:4mS, LOAD:OFF, TRIG OUT:OFF, RAMP:OFF, PAUSE:OFF Return the selected step data of normal sequence program.	

**:NSEquence:EDIT:POINT** Set →  
→ Query

Description	Sets and queries for the edit step number of the normal sequence.	
Syntax	:NSEquence:EDIT:POINT {<NR1>}	
Query Syntax	:NSEquence:EDIT:POINT?	
Parameter/ Return parameter	<NR1>	1~1000 The edit step number of the normal sequence.
Example	:NSEquence:EDIT:POINT 10 Sets the edit step number 10.	
Query example	:NSEquence:EDIT:POINT? >10 Returns the edit step number.	
Related Commands	:NSEquence:EDIT:END?	

**:NSEquence:EDIT:END** → Query

Description	Returns the end of edit step number in the normal sequence.	
Query Syntax	:NSEquence:EDIT:END?	
Return parameter	<NR1>	1~1000
Query Example	:NSEquence:EDIT:END? > 20 Returns the end of edit step number.	

**:NSEquence[:DELet]:ALL** Set →

Description	Delete all the steps of the selected normal sequence.	
Syntax	:NSEquence[:DELet]:ALL	

Example :NSEQ:ALL  
Delete all the steps of the selected normal sequence.

**:NSEquence:SAVE** Set →

Description Save program of normal sequence.

Syntax :NSEquence:SAVE

Example :NSEQ:SAVE  
Save program of normal sequence.

Set →

**:NSEquence:COTime** → Query

Description Sets and queries for the display timer of the normal sequence.

Syntax :NSEquence:COTime {UP|DOWN}

Query Syntax :NSEquence:COTime?

Parameter UP Elapsed time (Count up)

DOWN Remaining (Count down)

Return parameter :NSEQ:COT UP  
Sets the display timer to UP (elapsed time).

Example :NSEQ:COT?  
>UP  
Returns the display timer as UP (elapsed time).

## Fast sequence Commands

To execute / stop the test, use: INPUT command.

:FSEquence:STATe .....	138
:FSEquence .....	139
:FSEquence:MEMO .....	140
:FSEquence:MODE .....	141
:FSEquence:RANGe .....	141
:FSEquence:LOOP .....	142
:FSEquence:TBASe .....	143
:FSEquence:LLOAD .....	143
:FSEquence:LAST .....	144
:FSEquence:RPTStep .....	144
:FSEquence:EDIT .....	145
:FSEquence:EDIT:POINT .....	146
:FSEquence:EDIT:END .....	146
:FSEquence[:DELet]:ALL .....	146
:FSEquence[:EDIT]:FILL .....	147
:FSEquence:SAVE .....	147

### :FSEquence:STATe

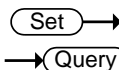

**Description** Sets and queries for the state of the fast sequence function.

**Syntax** :FSEquence:STATe {OFF | ON}

**Query Syntax** :FSEquence:STATe?

<b>Parameter</b>	OFF	Turn fast sequence function off
	ON	Turn fast sequence function on

**Return parameter** Return the state of the fast sequence function.  
 “ON, {STOP | RUN }” string. (“STOP”: stopped, “RUN”: running)  
 “OFF” string means that fast sequence is off.

**Example** :FSEQ:STAT ON  
 Turn on the fast sequence.

Query example :FSEQ:STAT?  
 >ON,STOP  
 The fast sequence function is on, and stopped

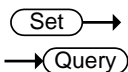

## :FSEquence

Description Sets and queries for parameters of fast sequence.  
 parameters of "Timing Edit Fast Sequence"

Syntax :FSEquence (1),(2),(3),(4),(5),(6),(7)

Query Syntax :FSEquence?

Parameter	(1) <ASCII string>	Sets the note of up to 12 characters. Enclose the string in double coat.
	(2) <ASCII string>	Sets the load mode. {CC   CR}
	(3) <ASCII string>	Sets the load range. {IHVH   IMVH   ILVH   IHVL   IMVL   ILVL}
	(4) <ASCII string>	Return the loop count of the sequence. (An infinite time is the string "Infinity".)
	(5) <NRf>	Sets the time base. (unit is seconds)
	(6) <ASCII string>	Sets the Last Load after the end. {ON   OFF}
	(7) <NRf>	Sets the Last Value after the end. (It is enabled by the Last Load ON.)
	(8) <NR1>	Sets the step number setting of the loop last.
Return parameter	(1) <ASCII string>	Return whether it is in fast sequence function state. {ON OFF}
	(2) <ASCII string>	Return the contents of the memo.

- (3) <ASCII string> Return the load mode setting. {CC | CR}
- (4) <ASCII string> Return the load range setting. {IHVH | IMVH | ILVH | IHVL | IMVL | ILVL}
- (5) <ASCII string> Return the loop count of the sequence. (An infinite time is the string "Infinity".)
- (6) <ASCII string> Return the time base. (unit is m seconds)
- (7) <ASCII string> Return the Last Load after the end. {ON|OFF}
- (8) <ASCII string> Return the Last Value after the end.
- (9) <ASCII string> Return the step number of the last loop.

Example :FSEQ "ABC",CC,IHVL,1,0.025,OFF,1.0,1  
Sets the parameters of "Timing Edit Fast Sequence".

Query example :FSEQ?  
> FSeq:OFF; Memo:ABC, Mode:CC, Range:IHVL, Loop:1, Time Base:25.000, Last Load:OFF, Last:1.00, RPTSTEP:1  
Return the parameters of "Timing Edit Fast Sequence".

Set →  
 → Query

**:FSEquence:MEMO**

Description Sets and queries for the memo of fast sequence. (Contents of Memo: )

Syntax :FSEquence:MEMO <ASCII string>

Query Syntax :FSEquence:MEMO?

Parameter <ASCII string> Set the characters up to 12 characters.  
Enclose the string in double coat.

Return parameter Return the memo of fast sequence, by the "Memo:<ASCII string>" string.

Example :FSEQ:MEMO "ABC"  
Sets the memo of fast sequence.

Query example :FSEQ:MEMO?  
>Memo: ABCD  
Return the memo of fast sequence.

### :FSEquence:MODE

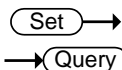

Description Sets and queries for the operating mode of fast sequence. (Contents of Mode: )

Syntax :FSEquence:MODE {CC | CR}

Query Syntax :FSEquence:MODE?

Parameter CC Sets to constant current mode.  
CR Sets to constant resistance mode.

Return parameter Return the operating mode of fast sequence, by the "Mode:{CC | CR}" string.

Example :FSEQ:MODE CC  
Sets the operating mode of the fast sequence.

Query example :FSEQ:MODE?  
>Mode:CC  
Return the operating mode of the fast sequence.

### :FSEquence:RANGe

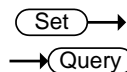

Description Sets and queries for the operating range of the fast sequence. (Contents of Range: )

Syntax :FSEquence:RANGe { IHVH | IMVH | ILVH | IHVL | IMVL | ILVL }

Query Syntax :FSEquence:RANGe?

Parameter IHVH Sets High current range and High voltage range.

IMVH	Sets Middle current range and High voltage range.
ILVH	Sets Low current range and High voltage range.
IHVL	Sets High current range and Low voltage range.
IMVL	Sets Middle current range and Low voltage range.
ILVL	Sets Low current range Low voltage range.

**Return parameter** Return the operating range of the fast sequence, by the "Range:{IHVH | IMVH | ILVH | IHVL | IMVL | ILVL}" string.

**Example** :FSEQ:RANG IHVL  
 Sets operating of High current range and Low voltage range.

**Query example** :FSEQ:RANG?  
 >Range:IHVH  
 Return the operating range of settings.

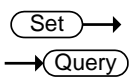

**:FSEQuence:LOOP**

<b>Description</b>	Sets and queries for number of loops of fast sequence. (Contents of Loop: )	
<b>Syntax</b>	:FSEQuence:LOOP {<NR1>   INFinity}	
<b>Query Syntax</b>	:FSEQuence:LOOP?	
<b>Parameter</b>	<NR1>	Loop count setting. (1~9999)
	INFinity	Infinite number of times.
<b>Return parameter</b>	Return the number of loops of fast sequence, by the "Loop:{<NR1>   Infinity}" string.	
<b>Example</b>	:FSEQ:LOOP 1 Sets 1 to loop count of fast sequence.	



Query example :FSEQ:LOOP?  
 >Loop:Infinity  
 Return the loop number of fast sequence.

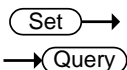

**:FSEquence:TBASe**

Description	Sets and queries for the time-based of fast sequence. (Contents of Time Base: )
Syntax	:FSEquence:TBASe <NRf>
Query Syntax	:FSEquence:TBASe?
Parameter	<NRf> Sets the time-base. (Unit is second.)
Return parameter	Return the time-based of fast sequence, by the "Time Base:<NR2>" string.
Example	:FSEQ:TBAS 0.6 Sets the 0.6 seconds to the time-base of fast sequence.

Query example :FSEQ:TBAS?  
 >Time Base:0.60000  
 Return the time-base.

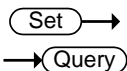

**:FSEquence:LLOAD**

Description	Sets and queries for the Last Load state of Fast sequence. (Contents of Last Load: )
Syntax	:FSEquence:LLOAD {ON   OFF}
Query Syntax	:FSEquence:LLOAD?
Parameter	ON Turns Last Load on. OFF Turns Last Load off.
Return parameter	Return the Last Load state, by the "Last Load:{ON   OFF}" string.
Example	:FSEQ:LLOAD ON Turns Last Load on.

Query example :FSEQ:LLOAD?  
 >Last Load:OFF  
 Return the Last Load state of Fast sequence.

Related Commands :FSEquence:LAST

:FSEquence:LAST Set →  
→ Query

Description Sets and queries for the Load Value after the end of Fast sequence. (Contents of Last: )

Syntax :FSEquence:LAST <NRf>

Query Syntax :FSEquence:LAST?

Parameter <NRf> Sets the load setting value of after the end of step. (It is enabled by load conditions ON.)

Return parameter Return the load setting value of after the end of step, by the "Last:<NR2>" string.

Example :FSEQ:LAST1  
 Sets the load setting value of after the end of step.

Query example :FSEQ:LAST?  
 >Last:0.070000  
 Return the load setting value of after the end of step.

Related Commands :FSEquence:LLOAD

:FSEquence:RPTStep Set →  
→ Query

Description Sets and queries for the last step number per loop of the fast sequence. (Contents of RPTSTEP: )

Syntax :FSEquence:RPTStep <NR1>

Query Syntax :FSEquence:RPTStep?

Parameter <NR1> Sets the step number of the last loop.

Return parameter Return the step number of the loop end of the fast sequence, by the “RPTSTEP:<NR1>” string.

Example :FSEQ:RPTS 1  
Sets the last step number per loop.

Query example :FSEQ:RPTS?  
>RPTSTEP:1  
Return the last step number per loop.

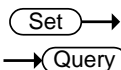

**:FSEquence:EDIT**

Description Sets and queries for data of fast sequence.  
Parameters of “Data Edit for Fast Sequence”

Syntax :FSEquence:EDIT (1),(2),(3),(4)

Query Syntax :FSEquence:EDIT?

Parameter	(1) <NR1>	Editing step.
	(2) <NR1>	Step total number.
	(3) <NRF>	Sets the load value of the operation mode.
	(4) <ASCII string>	Sets the TRIG OUT. {ON   OFF}

Return parameter	(1) <ASCII string>	Return the total of an edit step and a step.
	(2) <ASCII string>	Return the load setting value of the operation mode.
	(3) <ASCII string>	Return the TRIG OUT.

Example :FSEQ:EDIT 2,6,1,ON  
Sets the data of the fast sequence.

Query example :FSEQ:EDIT?  
> Step:0001/0003; Value:0.00, TRIG OUT:OFF  
Return the data of the fast sequence.

**:FSEquence:EDIT:POINT** Set →  
→ Query

Description	Sets and queries for the edit step number of the fast sequence.	
Syntax	:FSEquence:EDIT:POINT {<NR1>}	
Query Syntax	:FSEquence:EDIT:POINT?	
Parameter / Return parameter	<NR1>	1~1000 The edit step number of the fast sequence.
Example	:FSEquence:EDIT:POINT 10 Sets the edit step number 10.	
Query example	:FSEquence:EDIT:POINT? >10 Returns the edit step number.	
Related Commands	:FSEquence:EDIT:END?	

**:FSEquence:EDIT:END** → Query

Description	Returns the end of edit step number in the fast sequence.	
Query Syntax	:FSEquence:EDIT:END?	
Return parameter	<NR1>	1~1000
Query Example	:FSEquence:EDIT:END? > 20 Returns the end of edit step number.	

**:FSEquence[:DELet]:ALL** Set →

Description	Delete all programs of the fast sequence.	
Syntax	:FSEquence[:DELet]:ALL	

Example :FSEQ:ALL  
Delete all programs of the fast sequence.

**:FSEquence[:EDIT]:FILL**

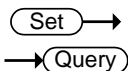

Description Query and setting for FILL of fast sequence.  
Parameters of “Fill Edit for Fast Sequence”

Syntax :FSEquence[:EDIT]:FILL (1),(2),(3),(4)

Query Syntax :FSEquence[:EDIT]:FILL?

Parameter	(1) <NRf>	Sets the start load value of the operating mode.
	(2) <NRf>	Sets the end load value of the operating mode.
	(3) <NR1>	Sets the step number of start.
	(4) <NR1>	Sets the step number of end.

Return parameter	(1)<ASCII string>	Return the start load value of the operating mode.
	(2)<ASCII string>	Return the end load value of the operating mode.
	(3)<ASCII string>	Return the step number of start.
	(4)<ASCII string>	Return the step number of end.

Example :FSEQ:FILL 0,5,1,6  
Sets the terms of the FILL to Fast sequence program.

Query example :FSEQ:FILL?  
>Start Value:0.00, End Value:5.00, Start Step:1, End Step:6  
Return the setting value of FILL of fast sequence.

**:FSEquence:SAVE**



Description Save program of fast sequence.

Syntax :FSEquence:SAVE

Example           : FSEQ:SAVE  
                  Save program of fast sequence.

## OCP Commands

To execute / stop the test, use: INPUT command.

:OCP:STATe .....	149
:OCP:EDIT[:CHANnel] .....	150
:OCP[:CHANnel]:NUMBer .....	151
:OCP:MEMO .....	151
:OCP[:CHANnel]:RANGe .....	152
:OCP[:CHANnel]:STARt .....	152
:OCP[:CHANnel]:END .....	153
:OCP[:CHANnel]:STEP:CURRent .....	153
:OCP[:CHANnel]:STEP:TIME .....	154
:OCP[:CHANnel]:DELay .....	154
:OCP[:CHANnel]:TRIGger .....	155
:OCP[:CHANnel]:LAST .....	155
:OCP:CHANnel:STATus .....	156
:OCP:RESult .....	156
:OCP:RUN .....	157

### :OCP:STATe

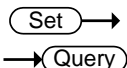

Description	Sets and queries for the state of the OCP function.	
Syntax	:OCP:STATe {<Boolean>   OFF   ON}	
Query Syntax	:OCP:STATe?	
Parameter	ON / 1	Turns the OCP function on
	OFF / 0	Turns the OCP function off
Return Parameter	ON, STOP	OCP function is on. OCP test stop.
	ON, RUN	OCP function is on. OCP test is running.
	ON, END	OCP function is on. OCP test is finished.
	OFF	OCP function is off.
Return	Return the OCP function state.	

example :OCP:STATe ON  
Turns the OCP function on.

Query example :OCP:STATe?  
OFF  
Indicates that the OCP function is turned off

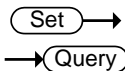

**:OCP:EDIT[:CHANnel]**

Description Sets and queries for the settings of the selected OCP memory number.

Parameters of "OCP Function"

Syntax :OCP:EDIT[:CHANnel]{<NR1>,LOW | MIDDLE | HIGH,<NR2>,<NR2>,<NR2>,<NR2>,<NR2>,<NR2>}

Query Syntax :OCP:EDIT?

Parameter	<NR1>	Memory Number (OCP.No:1~12)
	LOW   MIDDLE   HIGH	Current range (Range: )
	<NR2>	Start current value (Start C: unit A)
	<NR2>	End current value (End C: unit A)
	<NR2>	Current step value (Step C: unit A)
	<NR2>	Time step value (Step T:unit s)
	<NR2>	Delay time value (Delay:unit s)
	<NR2>	Trigger voltage (Trig V:unit V)
	<NR2>	Steady state current after test has finished (last C:unit A)

Return Parameter Return all the settings for the selected OCP memory number.  
Temp:<Seq\_1~Seq\_12>,Range:<High|Middle|Low>,  
Start C:<NR2>, End C:<NR2>, Step C:<NR2>,Step  
T:<NR2>, Delay: <NR2>, TrigV :<NR2>, Last C:<NR2>

example :OCP:EDIT 1, LOW, 0.5, 5.0, 0.1, 0.25, 0, 5.0, 1.0



Query example :OCP:EDIT?  
 Temp:Seq\_1, Range:High, Start C:0.36749, EndC:  
 0.36750, Step C:0.00001, Step T:5.00, Delay:0.00, Trig  
 V:0.01, Last C:0.00000

:OCP[:CHANnel]:NUMBer 

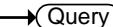

Description Sets and queries for the OCP memory number.  
 (Contents of OCP.No: )

Syntax :OCP[:CHANnel]:NUMBer <NR1>

Query Syntax :OCP[:CHANnel]:NUMBer?

Parameter <NR1> Sets the OCP memory number

Return Returns the OCP memory number

example :OCP:NUMB 1  
 Sets the OCP number is 1.

Query example :OCP:NUMB?  
 1  
 The OCP number is 1.

:OCP:MEMO 



Description Sets and queries for user-created note of the  
 currently selected OCP function.

Setting syntax :OCP:MEMO <string>

Setting parameter <string> Set the OCP note.

Setting example :OCP:MEMO abc  
 Set the OCP note is “abc”.

Query syntax :OCP:MEMO?

Return parameter <string> Return the OCP note.

Query example :OCP:MEMO?  
 abc  
 The OCP note is “abc”.

Set →  
 → Query

**:OCP[:CHANnel]:RANGe**

---

Description	Sets and queries for the channel range. (Contents of Range: )	
Syntax	:OCP[:CHANnel]:RANGe {LOW MIDDLE HIGH}	
Query Syntax	:OCP[:CHANnel]:RANGe?	
Parameter	LOW	CC Mode Low range.
	MIDDLE	CC Mode Middle range.
	HIGH	CC Mode High range.
Return	Return the OCPtest current range.	
example	:OCP:RANG LOW Set CC Mode Low range.	
Query example	:OCP:RANG? Low The range is CC Mode Low range.	

Set →  
 → Query

**:OCP[:CHANnel]:STARt**

---

Description	Sets and queries for the starting current value. (Contents of Start C: )	
Setting syntax	:OCP[:CHANnel]:STARt {<NR2> MINimum MAXimum}	
Setting parameter	<NR2>	The START current value in Amps.
	MINimum	Minimum starting current value.
	MAXimum	Maximum starting current value.
Setting example	:OCP:STAR 2 Set the start current to 2A.	
Query syntax	:OCP[:CHANnel]:STARt?	
Return parameter	<NR2>	Return the START current value in Amps.

Query example :OCP:STAR?  
0.1000  
Returns the starting current as 0.1A.

Set →  
 → Query

**:OCP[:CHANnel]:END**

Description Sets and queries for the ending current value of the test. The value must be higher than the DUT OCP value. (Contents of End C: )

Setting syntax :OCP[:CHANnel]:END  
{<NR2>|MINimum|MAXimum}

Setting parameter	<NR2>	The END current value in Amps.
	MINimum	Minimum ending current value.
	MAXimum	Maximum ending current value.

Setting example :OCP:END 2  
Set the END current to 2A.

Query syntax :OCP[:CHANnel]:END?

Return parameter <NR2> Return the END current value in Amps.

Query example :OCP:END?  
0.1000  
Returns the END current as 0.1A.

Set →  
 → Query

**:OCP[:CHANnel]:STEP:CURRent**

Description Sets and queries for the current step resolution of the OCP Test Automation. (Contents of Step C: )

Setting syntax :OCP[:CHANnel]:STEP:CURRent  
{<NR2>|MINimum|MAXimum}

Setting parameter	<NR2>	The current value in Amps.
	MINimum	Minimum current step resolution.
	MAXimum	Maximum current step resolution.

Setting example :OCP:STEP:CURR 0.1  
Set the step resolution as 0.1A.

Query syntax :OCP[:CHANnel]: STEP:CURRent?

Return parameter <NR2> Returns the current step resolution in Amps.

Query example :OCP:STEP:CURR?  
0.1000  
Returns the step resolution as 0.1A.

**:OCP[:CHANnel]:STEP:TIME**

Set →  
→ Query

Description Sets and queries for how long the step times of the OCP Test Automation function. (Contents of Step T: )

Setting syntax :OCP[:CHANnel]:STEP:TIME  
{<NR2>|MINimum|MAXimum}

Setting parameter <NR2>	The step time in seconds.
MINimum	Minimum step times.
MAXimum	Maximum step times.

Setting example :OCP:STEP:TIME 2  
Set the step time to 2second.

Query syntax :OCP[:CHANnel]:STEP:TIME?

Return parameter <NR2> Return the step time in seconds.

Set →  
→ Query

**:OCP[:CHANnel]:DELay**

Description Sets and queries for the test delay time of the OCP Test Automation function. (Contents of Delay: )

Setting syntax :OCP[:CHANnel]:DELay  
{<NR2>|MINimum|MAXimum}

Setting parameter <NR2>	The delay time in seconds
MINimum	Minimum test delay time.

**MAXimum** Maximum test delay time.

Setting example :OCP:DEL 2  
Set the delay time to 2s.

Query syntax :OCP[:CHANnel]:DElAY?

Return parameter <NR2> Return the delay time in seconds.

Query example :OCP:DEL?  
0.10  
Returns the delay time in seconds

Set →  
→ Query

**:OCP[:CHANnel]:TRIGger**

Description Sets and queries for the voltage trigger for when the power supply OCP has been triggered. (Contents of Trig V: )

Setting syntax :OCP[:CHANnel]:TRIGger  
{<NR2>|MINimum|MAXimum}

Setting parameter <NR2> The trigger voltage level.  
MINimum Minimum voltages trigger level.  
MAXimum Maximum voltage triggers level.

Setting example :OCP:TRIG 2  
Set the trigger voltage level to 2V.

Query syntax :OCP[:CHANnel]:TRIGger?

Return parameter <NR2> Return the trigger voltage level.

Query example :OCP:TRIG?  
2.0  
Returns the trigger level.

Set →  
→ Query

**:OCP[:CHANnel]:LAST**

Description Sets and queries for the current value of after the DUT OCP protection has been activated. (Contents of last C: )

Setting syntax :OCP[:CHANnel]:LAST  
 {<NR2>|MINimum|MAXimum}

Setting parameter <NR2> The current value in Amps.  
 MINimum Minimum current value.  
 MAXimum Maximum current value.

Setting example :OCP:LAST 2  
 Set the current value to 2A.

Query syntax :OCP[:CHANnel]:LAST?

Return parameter <NR2> Returns the current value in Amps.

Query example :OCP:LAST?  
 0.1000  
 Returns the current value.

**:OCP:CHANnel:STATus** → Query

Description Queries the status of the OCP Test Automation function.

Query Syntax :OCP:CHANnel:STATus?

Return Parameter 0 Test ended  
 1 OCP test active

Query example :OCP:CHAN:STAT?  
 0  
 The test has ended.

**:OCP:RESult** → Query

Description Returns the OCP Test Automation results.

Query Syntax :OCP:RESult?

Return Parameter <NR2>,<NR2> Returns the OCP current, voltage.

Query example :OCP:RES?  
 3.6750,0.10  
 OCP Current:3.675A, OCP Voltage:0.10V

---

**:OCP:RUN****Set** →

---

Description      Turns the load on for the OCP Test Automation function.

Same as :INPUT ON command.

---

Syntax            :OCP:RUN

---

## OPP test Commands

To execute / stop the test, use: INPUT command.

:OPP:STATe .....	158
:OPP:EDIT[:CHANnel] .....	159
:OPP[:CHANnel]:NUMBer .....	160
:OPP:MEMO .....	160
:OPP[:CHANnel]:RANGe .....	161
:OPP[:CHANnel]:STARt .....	161
:OPP[:CHANnel]:END .....	162
:OPP[:CHANnel]:STEP:WATT .....	163
:OPP[:CHANnel]:STEP:TIME .....	163
:OPP[:CHANnel]:DELay .....	164
:OPP[:CHANnel]:TRIGger .....	164
:OPP[:CHANnel]:LAST .....	165
:OPP:CHANnel:STATus .....	166
:OPP:RESult .....	166
:OPP:RUN .....	166

### :OPP:STATe

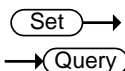

Description	Sets and queries for the state of the OPP function.	
Setting syntax	:OPP:STATe {<bool> OFF ON}	
Setting parameter	OFF   0	Turns the OPP function off.
	ON   1	Turns the OPP function on.
Setting example	:OPP:STATe ON	
	Turns the OPP function on.	
Query syntax	:OPP:STATe?	
Return Parameter	Return the OPP function state.	
	ON,	OPP function is on.
	STOP   RUN   END	“STOP” is OPP test stop, “RUN” is OPP test running, “END” is OPP test finished.
	OFF	OPP function is off.



Query example :OPP:STATE?

OFF

Indicates that the OPP function is turned off.

**:OPP:EDIT[:CHANnel]**

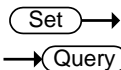

Description Sets and queries for the settings of the selected OPP memory number.

Parameters of "OPP Function"

Setting syntax :OPP:EDIT[:CHANnel](1),(2),(3),(4),(5),(6),(7),(8),(9)

Setting parameter	(1) <NR1>	Memory Number (OPP.No:1~12)
	(2) <ASCII string>	Current range (Range: ) LOW   MIDDLE   HIGH
	(3) <NR2>	Start watt value (Start W: unit W)
	(4) <NR2>	End watt value (End W: unit W)
	(5) <NR2>	Watt step value (Step W: unit W)
	(6) <NR2>	Time step value (Step T:unit s)
	(7) <NR2>	Delay time value (Delay: unit s)
	(8) <NR2>	Trigger voltage (Trig V:unit V)
	(9) <NR2>	Steady state watt after test has finished (last W:unit W)

Setting example :OPP:EDIT 1, LOW, 0.5, 5.0, 0.1, 0.25, 0, 5.0, 1.0

Query syntax :OPP:EDIT[:CHANnel]?

Return Parameter In the following order, return all the settings for the selected OPP memory number.

(1) Temp:Seq_<NR1>	OPP.No:1~12.
(2) Range: High   Middle   Low	Current range.
(3) Start W:<NR2>	Start watt value.
(4) End W:<NR2>	End watt value.

(5) Step W:<NR2>	Watt step value.
(6) Step T:<NR2>	Time step value.
(7) Delay: <NR2>	Delay time value.
(8) TrigV :<NR2>	Trigger voltage.
(9) Last W:<NR2>	Steady state watt after test has finished.

Query example :OPP:EDIT?  
 Temp:Seq\_1, Range: High, Start W:0.36749, End W:0.36750, Step W:0.00001, Step T:5.00, Delay:0.00,Trig V:0.01, Last W:0.00000

Set →  
 → Query

**:OPP[:CHANnel]:NUMBer**

**Description** Sets and queries for the OPP memory number. (Contents of OPP.No: )

**Setting syntax** :OPP[:CHANnel]:NUMBer <NR1>

**Setting parameter** <NR1> Sets the OPP memory number

**Setting example** :OPP:NUMB 1  
 Sets the OPP number is 1.

**Query syntax** :OPP[:CHANnel]:NUMBer?

**Return parameter** <NR1> Returns the OPP memory number.

**Query example** :OPP:NUMB?  
 1  
 The OPP number is 1.

Set →  
 → Query

**:OPP:MEMO**

**Description** Sets and queries for user-created note of the currently selected OPP function.

**Setting syntax** :OPP:MEMO <string>

**Setting parameter** <string> Set the OPP note.

Setting example :OPP:MEMO abc  
 Set the OPP note is “abc”.

Query syntax :OCP:MEMO?  
 Return parameter <string> Return the OCP note.  
 Query example :OCP:MEMO?  
 abc  
 The OCP note is “abc”.

 →  
 → 

**:OPP[:CHANnel]:RANGe**

Description Sets and queries for the channel range. (Contents of Range:)

Setting syntax :OPP[:CHANnel]:RANGe {LOW|MIDDLE|HIGH}

Setting parameter LOW CC Mode Low range.  
 MIDDLE CC Mode Middle range.  
 HIGH CC Mode High range.

Setting example :OPP:RANG LOW  
 Set CP Mode Low range.

Query syntax :OPP[:CHANnel]:RANGe?  
 Return parameter LOW | MIDDLE | HIGH Return the OPP test current range.

Query example :OPP:RANG?  
 Low  
 The range is CP Mode Low range.

 →  
 → 

**:OPP[:CHANnel]:START**

Description Sets and queries for the starting current value. (Contents of Start W:)

Setting syntax :OPP[:CHANnel]:START  
 {<NR2>|MINimum|MAXimum}

Setting parameter	<NR2>	The START watt value in Watts.
	MINimum	Minimum starting watt value.
	MAXimum	Maximum starting watt value.

Setting example :OPP:STAR 2  
Set the start watt to 2W.

Query syntax	:OPP[:CHANnel]:STARt?
Return parameter	<NR2> Return the START watt value in Watts.
Query example	:OPP:STAR? 0.1000 Returns the starting watt as 0.1W.

Set →  
 → Query

**:OPP[:CHANnel]:END**

Description Sets and queries for the ending watt value of the test. The value must be higher than the DUT OPP value. (Contents of End W: )

Setting syntax	:OPP[:CHANnel]:END {<NR2> MINimum MAXimum}
Setting parameter	<NR2> The END watt value in Amps. MINimum Minimum starting watt value. MAXimum Maximum starting watt value.

Setting example :OPP:END 2  
Set the END watt to 2A.

Query syntax	:OPP[:CHANnel]:END?
Return parameter	<NR2> Return the END watt value in Watts.
Query example	:OPP:END? 0.1000 Returns the END watt as 0.1W.

**:OPP[:CHANnel]:STEP:WATT** 

Description	Sets and queries for the current step resolution of the OPP Test Automation. (Contents of Step W:)	
Setting syntax	:OPP[:CHANnel]:STEP:WATT {<NR2> MINimum MAXimum}	
Setting parameter	<NR2>	The watt value in Watts.
	MINimum	Minimum watt step resolution.
	MAXimum	Maximum watt step resolution.
Setting example	:OPP:STEP:WATT 0.1 Set the step resolution as 0.1W.	
Query syntax	:OPP[:CHANnel]:STEP:WATT?	
Return parameter	<NR2>	Returns the Watt step resolution in Watts.
Query example	:OPP:STEP:WATT? 0.1000 Returns the step resolution as 0.1W.	

**:OPP[:CHANnel]:STEP:TIME** 

Description	Sets and queries for how long the step times of the OPP Test Automation function. (Contents of Step T:)	
Setting syntax	:OPP[:CHANnel]:STEP:TIME {<NR2> MINimum MAXimum}	
Setting parameter	<NR2>	The step time in seconds.
	MINimum	Minimum step times.
	MAXimum	Maximum step times.
Setting example	:OPP:STEP:TIME 2 Set the step time to 2second.	
Query syntax	:OPP[:CHANnel]:STEP:TIME?	

Return parameter <NR2> Return the step time in seconds.

Query example :OPP:STEP:TIME?

0.10

Returns the step time.

**:OPP[:CHANnel]:DELay**

Set →

→ Query

Description Sets and queries for the test delay time of the OPP Test Automation function. (Contents of Delay: )

Setting syntax :OPP[:CHANnel]:DELay  
{<NR2>|MINimum|MAXimum}

Setting parameter <NR2> The delay time in seconds

MINimum Minimum test delay time.

MAXimum Maximum test delay time.

Setting example :OPP:DEL 2

Set the delay time to 2s.

Query syntax :OPP[:CHANnel]:DELay?

Return parameter <NR2> Return the delay time in seconds.

Query example :OPP:DEL?

0.10

Returns the delay time in seconds.

**:OPP[:CHANnel]:TRIGger**

Set →

→ Query

Description Sets and queries for the voltage trigger for when the power supply OPP has been triggered. (Contents of Trig V: )

Setting syntax :OPP[:CHANnel]:TRIGger  
{<NR2>|MINimum|MAXimum}

Setting parameter <NR2> The trigger voltage level.

MINimum Minimum voltages trigger level.

	<b>MAXimum</b>	Maximum voltage triggers level.
Setting example	:OPP:TRIG 2	
		Set the trigger voltage level to 2V.
Query syntax	:OPP[:CHANnel]:TRIGger?	
Return parameter	<b>&lt;NR2&gt;</b>	Return the trigger voltage level.
Query example	:OPP:TRIG?	
	2.0	
		Returns the trigger level.

Set →  
 → Query

**:OPP[:CHANnel]:LAST**

Description	Sets and queries for the watt value of after the DUT OPP protection has been activated. (Contents of last W:)	
Setting syntax	:OPP[:CHANnel]:LAST {<NR2> MINimum MAXimum}	
Setting parameter	<b>&lt;NR2&gt;</b>	The watt value in Watts.
	<b>MINimum</b>	Minimum watt value.
	<b>MAXimum</b>	Maximum watt value.
Setting example	:OPP:LAST 2	
		Set the watt value to 2W.
Query syntax	:OPP[:CHANnel]:LAST?	
Return parameter	<b>&lt;NR2&gt;</b>	Returns the watt value in Watts.
Query example	:OPP:LAST?	
	0.1000	
		Returns the watt value.

**:OPP:CHANnel:STATus**

→ Query

Description	Queries the status of the OPP Test Automation function.
Query syntax	:OPP:CHANnel:STATus?
Return parameter	0 Test ended
	1 OPP test active
Query example	:OPP:CHAN:STAT? 0 The test has ended.

**:OPP:RESult**

→ Query

Description	Returns the OPP Test Automation results.
Query syntax	:OPP:RESult?
Return parameter	<NR2>,<NR2> Returns the OPP current, voltage.
Query example	:OCP:RES? 3.6750,0.10 OPP Current:3.675A, OPP Voltage:0.10V

**:OPP:RUN**

Set →

Description	Turns the load on for the OPP Test Automation function. Same as :INPUT ON command.
Setting syntax	:OPP:RUN



## BATT test Commands

To execute / stop the test, use: INPUT command.

:BATTery:STATe.....	167
:BATT:EDIT.....	168
:BATTery [:CHANnel]:NUMBer.....	169
:BATTery:MEMO.....	170
:BATTery:MODE.....	170
:BATTery:RANGe.....	171
:BATTery:VALue.....	171
:BATTery:RISE.....	172
:BATTery:FALL.....	172
:BATTery:STOP:VOLTage.....	173
:BATTery:STOP:TIME.....	174
:BATTery:STOP:AH.....	174
:BATTery:DATALog:TIMer.....	175
:BATT:CHANnel:STATus.....	175
:BATT:RESult.....	176
:BATT:RUN.....	176

### :BATTery:STATe

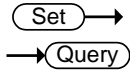

Description	Sets and queries for the state of the BATT function.	
Setting syntax	:BATTery:STATe {<Boolean> OFF ON}	
Setting parameter	OFF   0	Turns the BATT function off.
	ON   1	Turns the BATT function on.
Setting example	:BATT:STATe ON Turns the BATT function on.	
Query syntax	:BATTery:STATe?	
Return Parameter	Return the BATT function state.	
	ON, STOP   RUN   END	BATT function is on. “STOP” is BATT test stop, “RUN” is BATT test running, “END” is BATT test finished.

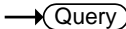
	OFF	BATT function is off.
Query example	:BATT:STATE?	
	OFF	
	Indicates that the BAtt function is turned off.	
		
		
<b>:BATT:EDIT</b>		
Description	Sets and queries for the settings of the selected BATT memory number. Parameters of “BATT Function”.	
Setting syntax	:BATTery:EDIT(1),(2),(3),(4),(5),(6),(7),(8),(9),(10)	
Setting parameter	(1) <NR1>	Memory Number (BATT.No:1~12).
	(2) <ASCII string>	Operation mode (Mode :). CC CR CP
	(3) <ASCII string>	I and V range (Range :) ILVL IMVL IHVL ILVH IMVH IHVH
	(4) <NR2>	Setting value of operation mode (Setting :).
	(5) <NR2>	Rising slew rate (Slew Rate↑ : unit mA/us).
	(6) <NR2>	Falling slew rate (Slew Rate↓ : unit mA/us).
	(7) <NR2>	Stop Voltage (Stop Volt: unit V).
	(8) <NR2>	Stop Time (Stop Time: unit s).
	(9) <NR2>	Stop AH (Stop AH: unit Ah)
	(10) <NR2>	The time interval for data capture (Datalog timer: unit s).
Setting example	:BATT:EDIT 1, CC, ILVL, 0.1, 8.4, 8.4, 5, 50, 1	
Query syntax	:BATTery:EDIT?	

**Return Parameter** In the following order, return all the settings for the selected BATT memory number.

(1) No:<NR1>	BATT.No:1~12.
(2) /sMemo:<string>	BATT note.
(3) /sMode:CC CR CP	Operation mode.
(4) /sRange: ILVL IMVL IHVL  ILVH IMVH IHVH	I and V range
(5) /sSet:<NR2>	Setting value.
(6) /sSRUP :<NR2>	Rising slew rate.
(7) /sSRDW:<NR2>	Falling slew rate.
(8) /sStop/sV:<NR2>	Stop Voltage.
(9) /sStop/sT:<NR2>	Stop Time.
(10) /sStop/sAH :<NR2>	Stop AH
(11) /sDatalog:<NR2>/n	The time interval for data capture.

**Query example** :BATT:EDIT?  
 No:01,/sMemo:./sMode:CC,/sRange:ILVL,/sSet:0.000  
 0,/sSRUP:250,/sSRDW:250,/sStop/sV:1.500,/sStop/s  
 T:0,/sStop/sAH:0.20,/sDatalog:1/n

**:BATTery [:CHANnel]:NUMBER** 



**Description** Sets and queries for the BATT memory number.  
 (Contents of BATT.No:)

**Setting syntax** :BATTery[:CHANnel]:NUMBer <NR1 >

**Setting parameter** <NR1> Sets the BATT memory number

**Setting example** :BATT:NUMB 1  
 Sets the BATT number is 1.

**Query syntax** :BATTery[:CHANnel]:NUMBER?

**Return parameter** <NR1> Returns the BATT memory number.

Query example :BATT:NUMB?  
 1  
 The BATT number is 1.

Set →

**:BATTery:MEMO**

→ Query

Description Sets and queries for user-created note of the currently selected BATT function.

Setting syntax :BATTery:MEMO <string>

Setting parameter <string> Set the BATT note.

Setting example :BATT:MEMO abc  
 Set the BATT note is “abc”.

Query syntax :BATTery:MEMO?

Return parameter <string> Return the BATT note.

Query example :BATT:MEMO?  
 abc  
 The BATT note is “abc”.

Set →

**:BATTery:MODE**

→ Query

Description Sets and queries for the operation mode.  
 (Contents of Mode: )

Setting syntax :BATTery:MODE {CC|CR|CP}

Setting parameter CC Set the CC mode.

CR Set the CR mode.

CP Set the CP mode.

Setting example :BATT:MODE CC  
 Set the operation mode to CC.

Query syntax :BATTery:MODE?

Return parameter CC | CR | CP Return the operation mode.

Query example : BATT:MODE?  
 CC  
 The operation mode is CC.

**:BATTery:RANGe**

Set →  
 → Query

Description Sets and queries for the channel range. (Contents of Range: )

Setting syntax :BATTery:RANGe  
 {ILVL|IMVL|IHVL|ILVH|IMVH|IHVH}

Setting parameter	ILVL	Set the I range is L, and V range is L.
	IMVL	Set the I range is M, and V range is L.
	IHVL	Set the I range is H, and V range is L.
	ILVH	Set the I range is L, and V range is H.
	IMVH	Set the I range is M, and V range is H.
	IHVH	Set the I range is H, and V range is H.

Setting example :BATT:RANG ILVL  
 Set the range are I range L, and V range L.

Query syntax :BATTery:RANGe?

Return parameter ILVL|IMVL|IHVL|ILVH|IMVH|IHVH Return the BATT test I and V range.

Query example :BATT:RANG?  
 ILVL  
 The setting range is I range L, and V range L.

**:BATTery:VALue**

Set →  
 → Query

Description Sets and queries for the setting value of the selected operation mode. (Contents of Setting: )

Setting syntax :BATTery:VALue {<NR2>|MINimum|MAXimum}

Setting parameter	<NR2>	The setting value
	MINimum	Minimum setting value.

**MAXimum** Maximum setting value.

Setting example :BATT:VAL 2  
Set the value to 2A.

Query syntax :BATTery:VALue?

Return parameter <NR2> Return the setting value.

Query example :BATT:VAL?  
2  
Returns the starting current as 2A.

**:BATTery:RISE**

Set →

→ Query

Description Sets and queries for the test rising slew rate in mA/us. (Contents of Slew Rate↑:)

Setting syntax :BATTery:RISE {<NR2>|MINimum|MAXimum}

Setting parameter <NR2> The test rising slew rate.

MINimum Minimum test rising slew rate.

MAXimum Maximum test rising slew rate.

Setting example :BATT:RISE 8.4  
Set the test rising slew to 8.4mA/us.

Query syntax :BATTery:RISE?

Return parameter <NR2> Return the test rising slew.

Query example :BATT:RISE?  
8.4  
Returns the test rising slew as 8.4mA/us.

Set →

→ Query

**:BATTery:FALL**

Description Sets and queries for the test falling slew rate in mA/us. (Contents of Slew Rate↓:)

Setting syntax :BATTery:FALL {<NR2>|MINimum|MAXimum}

Setting parameter <NR2> The test falling slew rate.

	MINimum	Minimum test falling slew rate.
	MAXimum	Maximum test falling slew rate.
Setting example	:BATT:FALL 8.4 Set the test falling slew to 8.4mA/us.	
Query syntax	:BATTery:FALL?	
Return parameter	<NR2>	Return the test falling slew.
Query example	:BATT:FALL? 8.4 Returns the test falling slew as 8.4mA/us.	

**:BATTery:STOP:VOLTage** 



Description	Sets and queries for the voltage at which the test should be interrupted. (Contents of Stop Volt: )	
Setting syntax	:BATTery:STOP:VOLTage {<NR2> MINimum MAXimum}	
Setting parameter	<NR2>	The stop voltage in V.
	MINimum	Minimum stop voltage.
	MAXimum	Maximum stop voltage.
Setting example	:BATT:STOP:VOLT 5 Set the stop voltage to 5V.	
Query syntax	:BATTery:STOP:VOLTage?	
Return parameter	<NR2>	Return the stop voltage in V.
Query example	:BATT:STOP:VOLT? 5 Returns the stop voltage as 5V.	

Set →

**:BATTery:STOP:TIME**

→ Query

**Description** Sets and queries for the time after which the test should be interrupted. (Contents of Stop Time: )

**Setting syntax** :BATTery:STOP:TIME  
{<NR1>|MINimum|MAXimum|OFF}

<b>Setting parameter</b> <NR1>	The stop time in seconds. (0~3599999)
MINimum	Minimum stop times.
MAXimum	Maximum stop times.
OFF	“OFF” is 0 second.

**Setting example** :BATT:STOP:TIME 2  
Set the stop time to 2second.

**Query syntax** :BATTery:STOP:TIME?

**Return parameter** <NR1> Return the stop time in seconds.

**Query example** :OPP:STOP:TIME?  
2  
Returns the step time as 2 seconds.

Set →

**:BATTery:STOP:AH**

→ Query

**Description** Sets and queries for the discharged energy rate at which the test should be interrupted. (Contents of Stop AH: )

**Setting syntax** :BATTery:STOP:AH  
{<NR2>|MINimum|MAXimum|OFF}

<b>Setting parameter</b> <NR2>	The stop AH in Ah. (0~9999.99)
MINimum	Minimum stop AH.
MAXimum	Maximum stop AH.
OFF	“OFF” is 0 AH.



Setting example :BATT:STOP:AH 2  
 Set the stop AH to 2 Ah.

---

Query syntax :BATTery:STOP:AH?

Return parameter <NR2> Return the stop AH in Ah.

Query example :OPP:STOP:AH?  
 2  
 Returns the step AH as 2 Ah.

Set →  
 → Query

**:BATTery:DATalog:TIMer**

Description Sets and queries for the time interval for data capture. (Contents of Datalog timer: )

---

Setting syntax :BATTery:DATalog:TIMer  
 {<NR1>|MINimum|MAXimum}

Setting parameter <NR1> The interval time in seconds.  
 (1 ~ 120)

MINimum	Minimum interval times.
MAXimum	Maximum interval times.

---

Setting example :BATT:DAT:TIM 2  
 Set the interval time to 2 seconds.

---

Query syntax :BATTery:DATalog:TIMer?

Return parameter <NR1> Return the interval time in seconds.

Query example :OPP:DAT:TIM?  
 2  
 Returns the interval time as 2 seconds.

**:BATT:CHANnel:STATus** → Query

Description Queries the status of the BATT Test Automation function.

---

Query syntax :BATT:CHANnel:STATus?

Return parameter 0 Test ended

1 BATT test active

Query example :BATT:CHAN:STAT?

0

The test has ended.

**:BATT:RESult**

→ Query

Description Returns the BATT Test Automation results.

Query syntax :BATT:RESult?

Return parameter <NR2>,<NR2> Returns the BATT current, voltage.

Query example :BATT:RES?

3.6750,0.10

BATT Current:3.675A, BATT Voltage:0.10V

**:BATT:RUN**

Set →

Description Turns the load on for the BATT Test Automation function.

Same as :INPUT ON command.

Setting syntax :BATT:RUN

## Utility Commands

:UTILity:SYSTem .....	177
:UTILity:LOAD .....	178
:UTILity:LOAD:MODE .....	178
:UTILity:LOAD:RANGe .....	179
:UTILity:TIME .....	179
:UTILity:KNOB .....	180
:UTILity:SPEAker .....	181
:UTILity:ALARm .....	181
:UTILity:UNReg .....	182
:UTILity:GNG .....	183
:UTILity:CONTRast .....	183
:UTILity:BRiGhtness .....	184
:UTILity:LANGuage .....	184
:UTILity:REMOte .....	185
:UTILity:REMOte:MODE .....	185

### :UTILity:SYSTem

→ **Query**

Description	Query for model number, serial number, and firmware version.	
Query Syntax	:UTILity:SYSTem?	
Return parameter	<ASCII string>	Return the model name.
	<NR1>	Return the serial number.
	<ASCII string>	Return the firmware version.
Query example	:UTIL:SYST? >PEL-3021H,12345678,V1.01.001  Return the model number, serial number, and firmware version.	

Set →

→ Query

**:UTILity:LOAD**

**Description**      Sets and queries for Auto Load and load function at power on. (Contents of Auto Load and Auto Load On )

Parameters of “Load Setting For Power On”

**Syntax**            :UTILity:LOAD {ON | OFF | LOAD | PROG | NSEQ | FSEQ}

**Query Syntax**    :UTILity:LOAD?

<b>Parameter</b>	ON	Turn on Auto Load.
	OFF	Turn off Auto Load.
	LOAD	Sets to manual operation.
	PROG	Sets to program function.
	NSEQ	Sets to normal sequence function.
	FSEQ	Sets to fast sequence function.

**Return parameter** <ASCII string> Return the Auto Load and load function at power on, by the “Load:{On | Off}, Load On:{Load | Prog | NSeq | FSeq}” string.

**Example 1**        :UTIL:LOAD ON  
Sets on the manual operation at power on.

**Example 2**        :UTIL:LOAD PROG  
Sets to the program function at power on.

**Query example**    :UTIL:LOAD?  
>Load:Off, Load On:Prog  
Return the Auto Load and load function at power on.

Set →

→ Query

**:UTILity:LOAD:MODE**

**Description**      Sets and queries for the Load Off (Mode) setting.  
Parameters of “Load Setting For Power On”

**Syntax**            :UTILity:LOAD:MODE {< Boolean > | ON | OFF}

Query Syntax	:UTILity:LOAD:MODE?	
Parameter	ON / 1	Sets Load Off (Mode) to ON.
	OFF / 0	Sets Load Off (Mode) to OFF.
Return parameter	Return the Load Off (Mode) setting.	
Example	:UTIL:LOAD:MODE ON Turns Load Off (Mode) to on.	
Query example	:UTIL:LOAD:MODE? >Off Load Off (Mode) is off.	

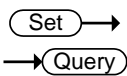

**:UTILity:LOAD:RANGe**

Description	Sets and queries for the Load Off (Range) setting. Parameters of "Load Setting For Power On"	
Syntax	:UTILity:LOAD:RANGe {<Boolean>   OFF   ON}	
Query Syntax	:UTILity:LOAD:RANGe?	
Parameter	ON / 1	Sets Load Off (Range) to OFF.
	OFF / 0	Sets Load Off (Range) to ON.
Return parameter	Return the Load Off (Range) setting.	
Example	:UTILity:LOAD:RANGe ON Turns Load Off (Range) to on.	
Query example	:UTILity:LOAD:RANGe? > Off Load Off (Range) is off.	

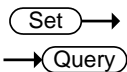

**:UTILity:TIME**

Description	Sets and queries for the date and time. Parameters of "Date/Time"	
Syntax	:UTILity:TIME (1),(2),(3),(4),(5)	
Query Syntax	:UTILity:TIME?	

Parameter	(1) <NR1>	Sets the month.
	(2) <NR1>	Sets the day.
	(3) <NR1>	Sets the year.
	(4) <NR1>	Sets the hour.
	(5) <NR1>	Sets the minutes.

Return parameter	(1) <NR1>	Return the month.
	(2) <NR1>	Return the day.
	(3) <NR1>	Return the year.
	(4) <NR1>	Return the hour.
	(5) <NR1>	Return the minutes.

Example :UTIL:TIME 9,1,2013,10,11  
Sets the date and time.

Query example :UTIL:TIME?  
>Month:9, Day:1, Year:2013, Hour:10, Minute:11  
Return the date and time.

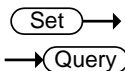

**:UTILity:KNOB**

Description Sets and queries for operational setting of the knob.  
Parameters of "Other Setting"

Syntax :UTILity:KNOB { UPDated | OLD }

Query Syntax :UTILity:KNOB?

Parameter	UPDated	Sets real-time updates.
	OLD	Sets update at the settlement after Enter.

Return parameter Return the operational settings of the knob, by the "{Updated | Old}" string.

Example :UTIL:KNOB UPD  
Sets the operation of the knob.

Query example :UTIL:KNOB?  
 >Updated  
 Return the operational settings of the knob.

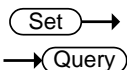

**:UTILity:SPEAker**

Description Sets and queries for the speakers sound during scrolling and key input.

Parameters of "Other Setting"

Syntax :UTILity:SPEAker {< Boolean > | ON | OFF}

Query Syntax :UTILity: SPEAker?

Parameter	ON or 1	Sets on the speakers sound during scrolling and key input.
	OFF or 0	Sets off the speakers sound during scrolling and key input.

Return parameter Return the setting value of speaker sound during scrolling and key input, by the "{On | Off}" string.

Example :UTIL:SPEA ON  
 Sets on the speakers sound during scrolling and key input.

Query example :UTIL:SPEA?  
 >On  
 Return the setting value of speaker sound during scrolling and key input.

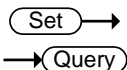

**:UTILity:ALARm**

Description Sets and queries for the speaker sound of the alarm.

Parameters of "Other Setting"

Syntax :UTILity:ALARm {< Boolean > | ON | OFF}

Query Syntax :UTILity:ALARm?

Parameter	ON or 1	Sets ON of the speaker sound of the alarm.
	OFF or 0	Sets OFF of the speaker sound of the alarm.
Return parameter	Return the speaker sound of the alarm, by the "{On   Off}" string.	
Example	:UTIL:ALAR ON Sets the speaker sound of the alarm.	
Query example	:UTIL:ALAR? >On Return the speaker sound of the alarm.	

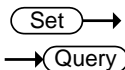

**:UTILity:UNReg**

Description	Sets and queries for the speaker sound of Anne-regulation. Parameters of "Other Setting"	
Syntax	:UTILity:UNReg {< Boolean >   ON   OFF}	
Query Syntax	:UTILity:UNReg?	
Parameter	ON or 1	Sets on the speaker sound of Anne-regulation.
	OFF or 0	Sets off the speaker sound of Anne-regulation.
Return parameter	Return the setting value of speaker sound of Anne-regulation, by the "{On   Off}" string.	
Example	:UTIL:UNR ON Sets on the speaker sound of Unregulation.	
Query example	:UTIL:UNR? >On Return the setting value of speaker sound of Unregulation.	



**:UTILity:GNG** 

  

Description	Sets and queries for the speaker sound of the "Go-NoGo" judgment time. Parameters of "Other Setting"	
Syntax	:UTILity:GNG {< Boolean >   ON   OFF}	
Query Syntax	:UTILity:GNG?	
Parameter	ON or 1	Sets ON of the speaker sound of the "Go-NoGo" judgment time.
	OFF or 0	Sets OFF of the speaker sound of the "Go-NoGo" judgment time.
Return parameter	Return the speaker sound of the "Go-NoGo" judgment time, by the "{On   Off}" string.	
Example	:UTIL:GNG ON  Sets the speaker sound of the "Go-NoGo" judgment time.	
Query example	:UTIL:GNG? >On  Return the setting of the speaker sound of the "Go-NoGo" judgment time.	

**:UTILity:CONTRast** 

  

Description	Sets and queries for the contrast of the LCD display. Parameters of "Other Setting"	
Syntax	:UTILity:CONTRast <NR1>	
Query Syntax	:UTILity:CONTRast?	
Parameter	<NR1>	Sets contrast of the LCD display. 3~13 (low ~ high)
Example	:UTIL:CONT 8  Sets the 8 at contrast of the LCD display.	

Query example :UTIL:CONT?  
 >8  
 Return contrast of the LCD display.

Set →

**:UTILity:BRIGhtness**

→ Query

Description Sets and queries for brightness of the LCD display.

Parameters of "Other Setting"

Syntax :UTILity:BRIGhtness <NR1>

Query Syntax :UTILity:BRIGhtness?

Parameter <NR1> Sets brightness of the LCD display.  
 50~90 (low ~ high)

Example :UTIL:BRI 70  
 Sets the 70 at brightness of the LCD display.

Query example :UTIL:BRI?  
 >70  
 Return brightness of the LCD display.

Set →

**:UTILity:LANGuage**

→ Query

Description Sets and queries for the language of the operation panel. Note: Language is English only.

Parameters of "Other Setting"

Syntax :UTILity:LANGuage ENGLISH

Query Syntax :UTILity:LANGuage?

Parameter ENGLISH Sets to English language.

Return parameter Return the language of the operation panel, by the "English" string.

Example :UTIL:LANG ENGL  
 Sets to English language.

Query example :UTIL:LANG?  
>English  
Return the language.

### :UTILity:REMOte



Description Turns the remote control on or off.

Syntax :UTILity:REMOte {OFF | 0 | ON | 1}

Parameter	OFF/0	Turns Remote control off
	ON/1	Turns remote control on

Example :UTIL:REM 1  
Turns remote control on.

### :UTILity:REMOte:MODE



Description Sets the remote mode to fast or normal.  
When in fast mode, the panel interface is deactivated with an interface time of no more than 10ms. Normal mode has an interface time of 30~130ms. In normal mode the display interface continues to update the screen in real-time.

Syntax :UTILity:REMOte:MODE {NORMAL | 0 | FAST | 1}

Parameter	FAST/1	FAST
	NORMAL/0	NORMAL

Example :UTIL:REM:MODE 1  
Turns remote mode to fast.

## Interface Commands

:UTILity:INTerface.....	186
:UTILity:BRATe.....	186
:UTILity:SBIT .....	187
:UTILity:PARity .....	187

### :UTILity:INTerface

Set →

→ Query

**Description** Sets and queries for the interface.

 **Note** Command is only valid for RS-232Control and USB.

**Syntax** :UTILity:INTerface {USB | RS232}

**Query Syntax** :UTILity:INTerface?

**Parameter** Sets after the transmission, but require power cycle to enable the feature.

USB Sets the USB interface.

RS232 Sets the RS-232C interface.

**Example** :UTIL:INT RS232  
Sets the RS-232C interface.

**Query example** :UTIL:INT?  
>RS232  
Return the interface setting value.

Set →

→ Query

### :UTILity:BRATe

**Description** Sets and queries for the baud rate of RS-232C.

 **Note** Command is only valid for interface setting of RS-232C

**Syntax** :UTILity:BRATe {2400 | 4800 | 9600 | 19200 | 38400}

**Query Syntax** :UTILity:BRATe?

**Parameter** <NR1> Sets the baud rate.

Return parameter	<NR1>	Return the baud rate.
Example	:UTIL:BRAT 38400	Sets the baud rate.
Query example	:UTIL:BRAT? >38400	Return the baud rate.

### :UTILity:SBIT

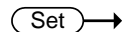
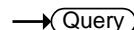

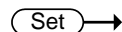

Description	Sets and queries for the stop bit of the RS-232C interface.	
 Note	Command is only valid for interface setting of RS232C	
Syntax	:UTILity:SBIT {1   2}	
Query Syntax	:UTILity:SBIT?	
Parameter	<NR1>	Sets the stop bit.
Example	:UTIL:SBIT 1	Sets the stop bit.
Query example	:UTIL:SBIT? >1	Return the stop bit.

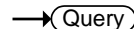

### :UTILity:PARity



Description	Sets and queries for the parity bit of RS-232C interface.	
 Note	Command is only valid for interface setting of RS-232C	
Syntax	:UTILity:PARity { NONE   ODD   EVEN }	
Query Syntax	:UTILity:PARity?	
Parameter	NONE	Sets no parity.
	ODD	Sets the odd parity.

**EVEN** Sets the even parity.

---

Return parameter Return the parity bit of RS-232C interface, by the "{None | Odd | Even}" string.

---

Example :UTIL:PAR NONE  
Sets no parity.

---

Query example :UTIL:PAR?  
>None  
Return the setting of parity.

## File Commands

:MEMory:SAVE.....	189
:MEMory:RECall.....	189
:PREset:SAVE.....	190
:PREset:RECall.....	190
:SETup:SAVE.....	190
:SETup:RECall.....	190
:FACTory[:RECall].....	191
:USER[:DEFault]:SAVE.....	191
:USER[:DEFault]:RECall.....	191

## :MEMory:SAVE



Description Save in the internal memory of the specified.

Syntax :MEMory:SAVE < NR1 >

Parameter <NR1> Specify the internal memory number.  
(1 to 256)

Example :MEM:SAVE 20  
Saves the current setting to internal memory 20.

Same function command \*SAV

## :MEMory:RECall



Description Recall settings from the internal memory.

Syntax :MEMory:RECall < NR1 >

Parameter <NR1> Specify the internal memory number.  
(1 to 256)

Example :MEM:REC 20  
Recall setting internal memory 20.

Same function command \*RCL

**:PREset:SAVE (Set) →**

Description	Save to the preset memory of the specified.	
Syntax	:PREset:SAVE < NR1>	
Parameter	<NR1>	Specify the preset memory number. (0 to 9)
Example	:PRE:SAVE 1 Saves the setting value to preset memory 1.	

**:PREset:RECall (Set) →**

Description	Recall settings from the preset memory.	
Syntax	:PREset:RECall <NR1>	
Parameter	<NR1>	Specify the preset memory number. (0 to 9)
Example	:PRE:REC 1 Recall setting preset memory 1.	

**:SETup:SAVE (Set) →**

Description	Save to the setup data of the specified.	
Syntax	:SETup:SAVE < NR1>	
Parameter	<NR1>	Specify the setup data number. (1 to 100)
Example	:SET:SAVE 1 Saves the setting value to setup data 1.	

**:SETup:RECall (Set) →**

Description	Recall settings from the setup data.	
Syntax	:SETup:RECall <NR1>	
Parameter	<NR1>	Specify the setup data number. (1 to 100)



Example           :SET:REC 1  
                   Recall setting setup data 1.

**:FACTory[:RECall]** (Set) →

---

Description      Sets factory defaults.

 Note           Interface will switch to as follows. Interface:RS-232C,  
                   Baud rate:38400, Stop bit:1, parity :None

Syntax           :FACTory[:RECall]

Example           :FACT  
                   Sets factory defaults.

**:USER[:DEFault]:SAVE** (Set) →

---

Description      Save to the default settings for the user.

Syntax           :USER[:DEFault]:SAVE

Example           :USER:SAVE  
                   Save as user default settings the current settings  
                   value.

**:USER[:DEFault]:RECall** (Set) →

---

Description      Recall the default settings for the user.

Syntax           :USER[:DEFault]:RECall

Example           :USER:REC  
                   Recall the default settings for the user.

## SCPI Status Commands

:SYSTem:ERRor.....	192
:STATus:PRESet .....	192

### :SYSTem:ERRor → Query

**Description**      Queries the error queue. The last error message is return. A maximum of 32 errors are stored in the error queue.

**Query Syntax**      :SYSTem:ERRor?

**Return parameter** Returns the error queue, by the "<NR1>,<string>" string.

**Query example**    :SYST:ERR?  
                          >-113, "Undefined header"

### :STATus:PRESet Set →

**Description**      Is the setting of the initial value for the Csummary status and the Questionable status and the Operation status. PTR (positive transition) filter is set, enable register and (negative transition) NTR filter is reset.

Initial value of Register / Filter	Setting
Csummary status enable	0x0000
Csummary status PTR (positive transition)	0x7FFF
Csummary status NTR (negative transition)	0x0000
Operation status enable	0x0000
Operation status PTR (positive transition)	0x7FFF
Operation status NTR (negative transition)	0x0000
Questionable status enable	0x0000

---

	Questionable status PTR (positive transition)	0x7FFF
	Questionable status NTR (negative transition)	0x0000
Syntax	:STATus:PRESet	
Example	:STAT:PRES	

It set the initial value for the Csummary status and the Questionable status and the Operation status.

## Csummary Status Commands

:STATus:CSUMmary:CONDition .....	194
:STATus:CSUMmary:ENABle .....	194
:STATus:CSUMmary[:EVENT] .....	195
:STATus:CSUMmary:NTRansition.....	195
:STATus:CSUMmary:PTRansition.....	195

### :STATus:CSUMmary:CONDition → Query

Description	Query the Csummary Status Condition register.
Query Syntax	:STATus:CSUMmary:CONDition?
Return parameter	Return the Csummary Status Condition register, by the "<NR1>" string.
Query example	:STAT:CSUM:COND? >1  Return the Csummary Status Condition register

Set →

### :STATus:CSUMmary:ENABle → Query

Description	Sets and queries for the Event Enable register of Csummary.
Syntax	:STATus:CSUMmary:ENABle <NR1>
Query Syntax	:STATus:CSUMmary:ENABle?
Parameter	<NR1> Sets the Event Enable register of Csummary.
Example	:STAT:CSUM:ENAB 1  Sets the Event Enable register of Csummary.
Query example	:STAT:CSUM:ENAB? >1  Return the Event Enable register of Csummary.

### :STATus:CSUMmary[:EVENT]

Description	Query and setting for the Event register of Csummary.
Query Syntax	:STATus:CSUMmary[:EVENT]?
Return parameter	Return the Event register of Csummary, by the "<NR1>" string.
Query example	:STAT:CSUM? >1 Return the Event register of Csummary.

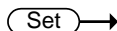

### :STATus:CSUMmary:NTRansition

Description	Sets and queries for detection bit of Csummary status of changes of from positive to negative.
Syntax	:STATus:CSUMmary:NTRansition <NR1>
Query Syntax	:STATus:CSUMmary:NTRansition?
Parameter	<NR1> Sets the detection bit of Csummary status of changes from positive to negative.
Example	:STAT:CSUM:NTR 1 Sets the detection bit of Csummary status of changes from positive to negative.
Query example	:STAT:CSUM:NTR? >1 Return the detection bit of Csummary status of changes from positive to negative.

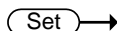

### :STATus:CSUMmary:PTRansition

Description	Sets and queries for detection bit of Csummary status of changes of from negative to positive.
Syntax	:STATus:CSUMmary:PTRansition <NR1>

Query Syntax	:STATus:CSUMmary:PTRansition?	
Parameter	<NR1>	Sets the detection bit of Csummary status of changes from negative to positive.
Example	:STAT:CSUM:PTR 1 Sets the detection bit of Csummary status of changes from negative to positive.	
Query example	:STAT:CSUM:PTR? >1 Return the detection bit of Csummary status of changes from negative to positive.	

## Operation Status Commands

:STATus:OPERation:CONDition .....	197
:STATus:OPERation:ENABle .....	197
:STATus:OPERation[:EVENT] .....	198
:STATus:OPERation:NTRansition .....	198
:STATus:OPERation:PTRansition .....	198

### :STATus:OPERation:CONDition → **Query**

Description	Query the Operation Status Condition register.
Query Syntax	:STATus:OPERation:CONDition?
Return parameter	Return the Operation Status Condition register, by the "<NR1>" string.
Query example	:STAT:OPER:COND? >1  Return the Operation Status Condition register.

→ **Set**

### :STATus:OPERation:ENABle → **Query**

Description	Sets and queries for the Event Enable register of Operation.
Syntax	:STATus:OPERation:ENABle <NR1>
Query Syntax	:STATus:OPERation:ENABle?
Parameter	<NR1>      Sets the Event Enable register of Operation.
Example	:STAT:OPER:ENAB 1  Sets the Event Enable register of Operation.
Query example	:STAT:OPER:ENAB? >1  Return the Event Enable register of Operation.

**:STATus:OPERation[:EVENT]** → Query

Description	Query for the Event register of Operation.
Query Syntax	:STATus:OPERation[:EVENT]?
Return parameter	Return the Event register of Operation, by the "<NR1>" string.
Query example	:STAT:OPER? >1  Return the Event register of Operation.

Set →

**:STATus:OPERation:NTRansition** → Query

Description	Sets and queries for detection bit of Operation status of changes of from positive to negative.
Syntax	:STATus OPERation:NTRansition <NR1>
Query Syntax	:STATus:OPERation:NTRansition?
Parameter	<NR1> Sets the detection bit of Operation status of changes from positive to negative.
Example	:STAT:OPER:NTR 1  Sets the detection bit of Operation status of changes from positive to negative.
Query example	:STAT:OPER:NTR? >1  Return the detection bit of Operation status of changes from positive to negative.

Set →

**:STATus:OPERation:PTRansition** → Query

Description	Sets and queries for detection bit of Operation status of changes of from negative to positive.
Syntax	:STATus:OPERation:PTRansition <NR1>
Query Syntax	:STATus OPERation:PTRansition?



---

Parameter	<NR1>	Sets the detection bit of Operation status of changes from negative to positive.
Example	:STAT:OPER:PTR 1	Sets the detection bit of Operation status of changes from negative to positive.
Query example	:STAT:OPER:PTR? >1	Return the detection bit of Operation status of changes from negative to positive.

---

## Questionable Status Commands

:STATus:QUEStionable:CONDition .....	200
:STATus:QUEStionable:ENABle .....	200
:STATus:QUEStionable[:EVENT] .....	201
:STATus:QUEStionable:NTRansition .....	201
:STATus:QUEStionable:PTRansition .....	201

### :STATus:QUEStionable:CONDition → Query

**Description**      Query the Questionable Status Condition register.

**Query Syntax**      :STATus:QUEStionable:CONDition?

**Return parameter** Return the Questionable Status Condition register, by the "<NR1>" string.

**Query example**    :STAT: QUES:COND?  
>1

Return the Questionable Status Condition register.

Set →

### :STATus:QUEStionable:ENABle → Query

**Description**      Sets and queries for the Event Enable register of Questionable.

**Syntax**            :STATus:QUEStionable:ENABle <NR1>

**Query Syntax**    :STATus:QUEStionable:ENABle?

<b>Parameter</b>	<b>&lt;NR1&gt;</b>	Sets the Event Enable register of Questionable.
------------------	--------------------	---

**Example**            :STAT:QUES:ENAB 1  
Sets the Event Enable register of Questionable.

**Query example**    :STAT:QUES:ENAB?  
>1  
Return the Event Enable register of Questionable.

**:STATus:QUEStionable[:EVENT]** → Query

Description	Query for the Event register of Questionable.
Query Syntax	:STATus:QUEStionable[:EVENT]?
Return parameter	Return the Event register of Questionable, by the "<NR1>" string.
Query example	:STAT:QUES? >1 Return the Event register of Questionable.

**:STATus:QUEStionable:NTRansition** Set →  
→ Query

Description	Sets and queries for detection bit of Questionable status of changes of from positive to negative.
Syntax	:STATus:QUEStionable:NTRansition <NR1>
Query Syntax	:STATus:QUEStionable:NTRansition?
Parameter	<NR1> Sets the detection bit of Questionable status of changes from positive to negative.
Example	:STAT:QUES:NTR 1 Sets the detection bit of Questionable status of changes from positive to negative.
Query example	:STAT:QUES:NTR? >1 Return the detection bit of Questionable status of changes from positive to negative.

**:STATus:QUEStionable:PTRansition** Set →  
→ Query

Description	Sets and queries for detection bit of Questionable status of changes of from negative to positive.
Syntax	:STATus:QUEStionable:PTRansition <NR1>
Query Syntax	:STATus:QUEStionable:PTRansition?

Parameter	<NR1>	Sets the detection bit of Questionable status of changes from negative to positive.
Example	:STAT:QUES:PTR 1 Sets the detection bit of Questionable status of changes from negative to positive.	
Query example	:STAT:QUES:PTR? >1 Return the detection bit of Questionable status of changes from negative to positive.	

## Status Register Overview

This section explains in detail how the Status registers are used and how to configure them.

It will also be able to create an effective program by understand the Status register.

### Introduction to the Status Registers

---

Overview	<p>The status registers are used to determine the status of the electronic load. The status registers maintain the status of the protection conditions, load conditions and channel conditions of the load modules.</p> <p>The PEL-3000H series have a number of register groups:</p> <ul style="list-style-type: none"><li>● CSummary Registers</li><li>● Operation Status Register Group</li><li>● Questionable Status Register Group</li><li>● Standard Event Status Register Group</li><li>● Status Byte Register Group</li></ul>
----------	---

---

## Configuration in the Status register

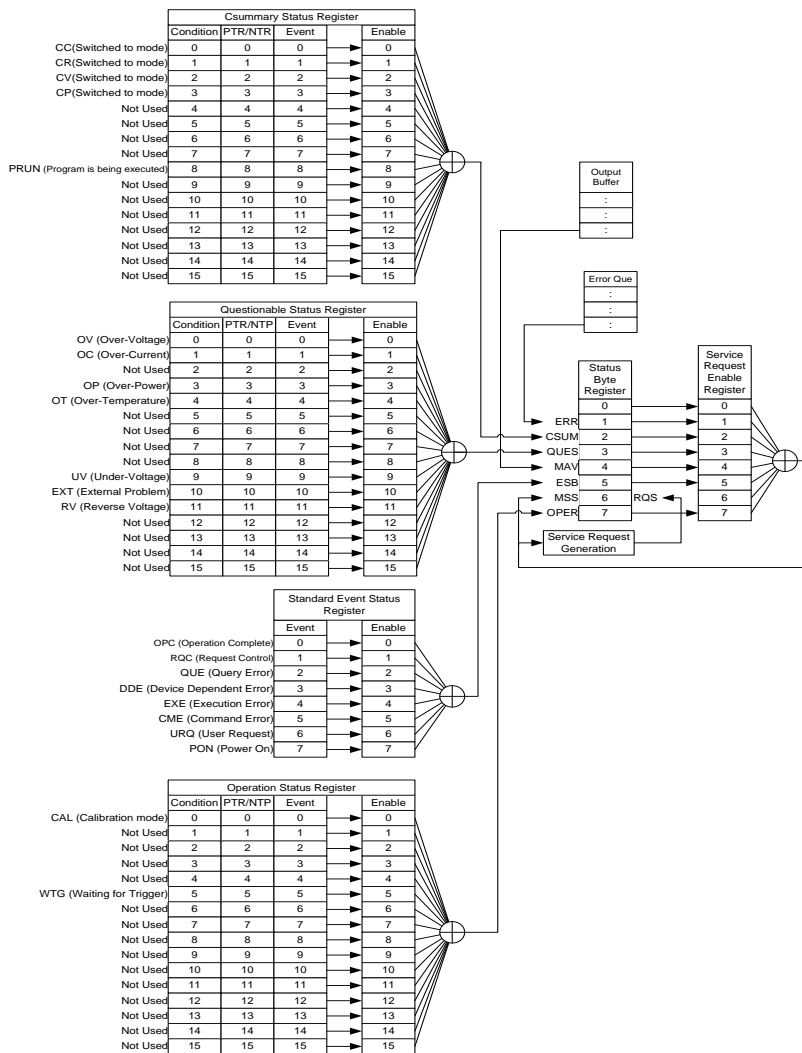

## Csummary Status Register Group

### Overview

Csummary Status register group, you can check the operating status of the load mode and sequence or program mode.

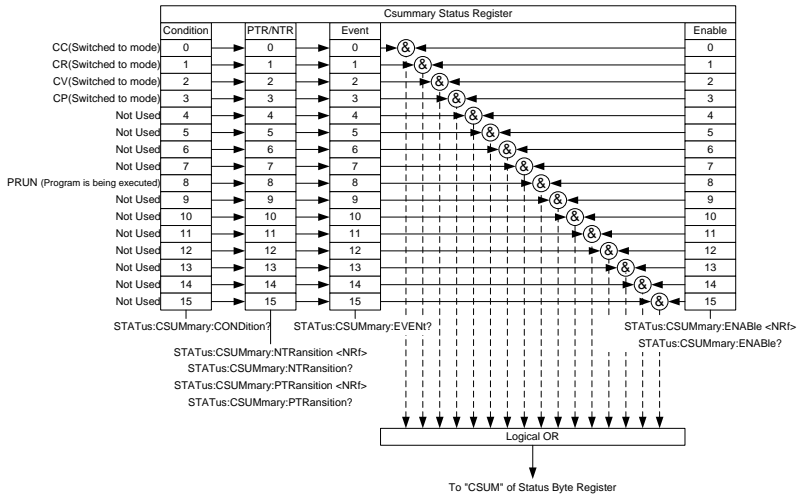

Bit name	Event	Bit #	Bit Weight
CC	Indicate the Constant Current mode setting.	0	1
CR	Indicate the Constant Resistance mode setting.	1	2
CV	Indicate the Constant Voltage mode setting.	2	4
CP	Indicate the Constant Power mode setting.	3	8
PRUN	Indicate the operation mode of Sequence or Program.	8	256

Condition Register	Csummary Status Condition register can be read the current state of the load mode and program mode or sequence operation mode.				
PTR/NTR Filter	The PTR/NTR (Positive/Negative transition) register determines the type of transition conditions that will set the corresponding bit in the Event Registers. Use the Positive transition filter to view events that change from false to positive, and use the negative transition filter to view events that change from positive to negative.				
	<table> <tr> <td>Positive Transition</td> <td>0→1</td> </tr> <tr> <td>Negative Transition</td> <td>1→0</td> </tr> </table>	Positive Transition	0→1	Negative Transition	1→0
Positive Transition	0→1				
Negative Transition	1→0				
Event Register	The PTR/NTR Register will dictate the type of transition conditions will set the corresponding bits in the Event Register. If the Event Register is read, it will be cleared to 0.				
Enable Register	The Enable register determines which Events in the Event Register will be used to set the CSUM bit in the Status Byte Register.				



## Operation Byte Register Group

**Overview**      Operation Status register group, you can check the operating status of the Trigger wait or the Calibration mode.

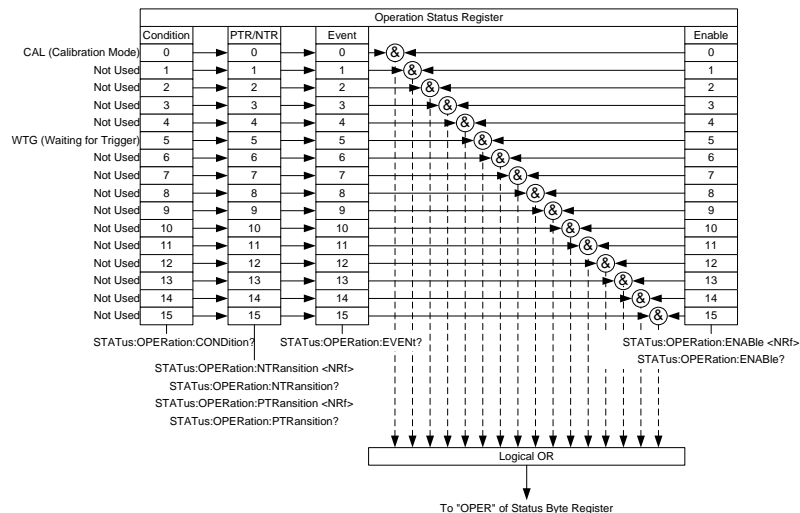

Bit name	Event	Bit #	Bit Weight
CAL	Indicate the Calibration mode.	0	1
WTG	Indicate the Trigger wait.	5	32

**Condition Register**      Operation Status Condition register can be read by the current state of the Trigger waiting and Calibration mode.

**PTR/NTR Filter**      The PTR/NTR (Positive/Negative transition) register determines the type of transition conditions that will set the corresponding bit in the Event Registers. Use the Positive transition filter to view events that change from false to positive, and use the negative transition filter to view events that change from positive to negative.

Positive Transition            0→1  
 Negative Transition          1→0

**Event Register**            The PTR/NTR Register will dictate the type of transition conditions will set the corresponding bits in the Event Register. If the Event Register is read, it will be cleared to 0.

**Enable Register**          The Enable register determines which Events in the Event Register will be used to set the OPER bit in the Status Byte Register.

## Questionable Status Register Group

**Overview**                    Questionable Status register group, you can check the operating status of the protection function.

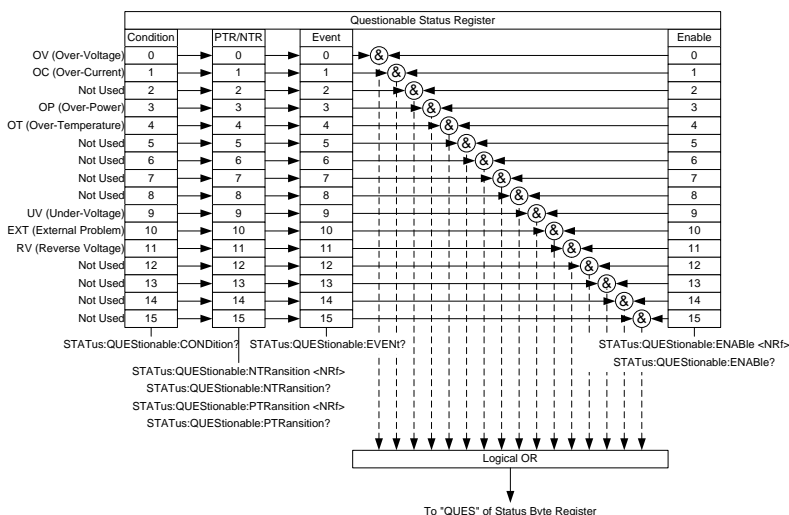

Bit Summary	Bit name	Event	Bit #	Bit Weight
	OV	Indicate the Over-Voltage condition.	0	1
	OC	Indicate the Over-Current condition.	1	2

OP	Indicate the Over-Power condition.	3	8
OT	Indicate the Over-Temperature condition.	4	16
PRUN	Indicate the operation mode of Sequence or Program.	8	256
UV	Indicate the Under-Voltage condition.	9	512
EXT	Indicate the abnormality state of the external control.	10	1024
RV	Indicate the reverse connection state.	11	2048
Condition Register	Questionable Status Condition register can be read the current state of the protection function.		
PTR/NTR Filter	The PTR/NTR (Positive/Negative transition) register determines the type of transition conditions that will set the corresponding bit in the Event Registers. Use the Positive transition filter to view events that change from false to positive, and use the negative transition filter to view events that change from positive to negative.		
	Positive Transition	0→1	
	Negative Transition	1→0	
Event Register	The PTR/NTR Register will dictate the type of transition conditions will set the corresponding bits in the Event Register. If the Event Register is read, it will be cleared to 0.		
Enable Register	The Enable register determines which Events in the Event Register will be used to set the QUES bit in the Status Byte Register.		



	DDE	Device Dependent Error Device specific error.	3	8
	EXE	Execution Error The EXE bit indicates an execution error due to one of the following: illegal command parameter, parameter out of range, invalid parameter, the command didn't execute due to an overriding operation condition.	4	16
	CME	Command Error The CME bit is set when a syntax error has occurred. The CME bit can also be set when a <GET> command is received within a program message.	5	32
	URQ	User Request	6	64
	PON	Power On Indicates the power is turned on.	7	128
Event Register	Any bits set in the event register indicate that an error has occurred. Reading the Event register will reset the register to 0.			
Enable Register	The Enable register determines which Events in the Event Register will be used to set the ESB bit in the Status Byte Register.			

## Status Byte Register Group

### Overview

The Status Byte register groups, you can check the status of the event in the status register of all. You can read the status byte register in "`*STB?`" Query command.

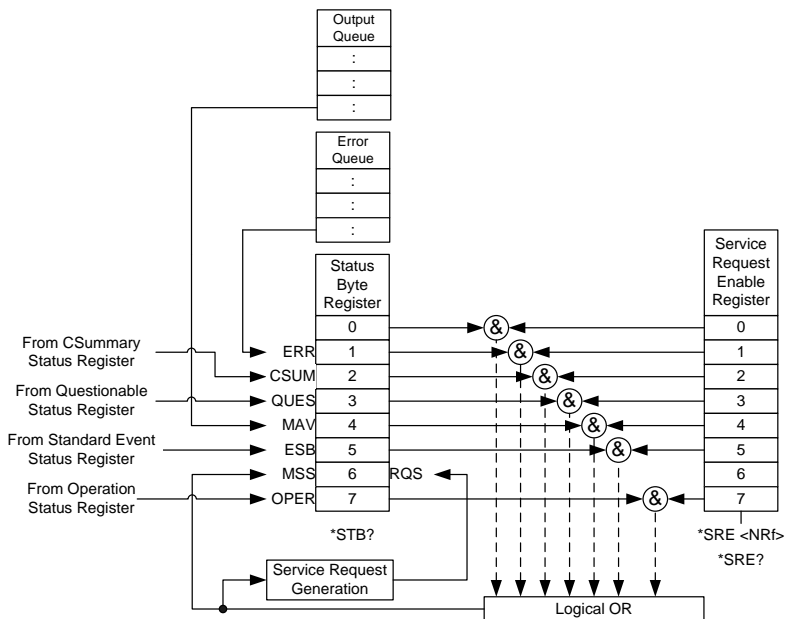

Bit name	Event	Bit #	Bit Weight
ERR	Error Event/Queue If data is present in the Error queue, the ERR bit will be set.	1	2
CSUM	Csummary Status Register The summary bit for the Csummary Status Register group.	2	4

QUES	Questionable Status Register The summary bit for the Questionable Status Register group.	3	8
MAV	Message Available This is set when there is data in the Output Queue waiting to be read.	4	16
ESB	Event Summary Bit. The ESB is the summary bit for the Standard Event Status Register group.	5	32
MSS /RQS	The MSS Bit is the summary of the Status Byte Register and Service Request register (bits 1-5, 7). This will be set to 1.	6	64
OPER	Operation Status Register OPER bit is the summary bit for the Operation Status Register Group.	7	128
Status Byte Register	Any bits set in the Status byte register acts as a summary register for all the four other status registers and indicates if there is a service request, an error in the Error Queue or data in the Output Queue. Reading the Status Byte register will reset the register to 0.		
Status Byte Register	Any bits set in the Status byte register acts as a summary register for all the four other status registers and indicates if there is a service request, an error in the Error Queue or data in the Output Queue. Reading the Status Byte register will reset the register to 0.		

Service Request Enable Register    Service Request Enable register specifies the bits in the Status Byte register for setting the MSS / RQS bit in the Status Byte register.

Also, MSS bit, can see in the "\*STB?" Query command.

RQS bit is used to RQS bit of the GP-IB interface managed by the service request generator a bit of MSS. RQS bit is initialized after reading.



## Error Messages

The following error messages may be encountered when reading the error queue.

Error Code and string	Description
Command Errors	
0 NoError	No error
-100 Command Error	This is the generic syntax error for devices that cannot detect more specific errors.
-101 Invalid character	A syntactic element contains a character which is invalid for that type.
-102 Syntax error	An unrecognized command or data type was encountered.
-103 Invalid separator	The parser was expecting a separator and encountered an illegal character.
-104 Data type error	The parser recognized a data element different than the one allowed.
-105 GET not allowed	A Group Execute Trigger was received within a program message.
-108 Parameter not allowed	More parameters were received than expected for the header.
-109 Missing parameter	Fewer parameters were received than required for the header.
-110 Command header error	An error was detected in the header.
-111 Header separator error	A character which is not a legal header separator was encountered while parsing the header.
-112 Program mnemonic too long	The header contains more than twelve characters.
-113 Undefined header	The header is syntactically correct, but it is undefined for this specific device.

-114 Header suffix out of range	The value of a numeric suffix attached to a program mnemonic.
-115 Unexpected number of parameters	The number of parameters received does not correspond to the number of parameters expected.
-120 Numeric data error	This error is generated when parsing a data element which appears to be numeric, including the nondecimal numeric types.
-121 Invalid character in number	An invalid character for the data type being parsed was encountered.
-123 Exponent too large	The magnitude of the exponent was larger than 32000.
-124 Too many digits	The mantissa of a decimal numeric data element contained more than 255 digits excluding leading zeros.
-128 Numeric data not allowed	A legal numeric data element was received, but the device does not accept one in this position for the header
-130 Suffix error	This error, as well as errors -131 through -139, are generated when parsing a suffix.
-131 Invalid suffix	The suffix does not follow the syntax described in IEEE 488.2 or the suffix is inappropriate for this device.
-134 Suffix too long	The suffix contained more than 12 characters.
-138 Suffix not allowed	A suffix was encountered after a numeric element which does not allow suffixes.
-140 Character data error	This error is generated when parsing a character data element.
-141 Invalid character data	Either the character data element contains an invalid character or the particular element received is not valid for the header.
-144 Character data too long	The character data element contains more than twelve characters

---

-148 Character data not allowed	A legal character data element was encountered where prohibited by the device.
-150 String data error	This error is generated when parsing a string data element.
-151 Invalid string data	A string data element was expected, but was invalid for some reason.
-158 String data not allowed	A string data element was encountered but was not allowed by the device at this point in parsing.
-160 Block data error	This error is generated when parsing a block data element.
-161 Invalid block data	A block data element was expected, but was invalid for some reason.
-168 Block data not allowed	A legal block data element was encountered but was not allowed by the device at this point in parsing.
-170 Expression error	This error is generated when parsing an expression data element.
-171 Invalid expression	The expression data element was invalid.
-178 Expression data not allowed	A legal expression data was encountered but was not allowed by the device at this point in parsing.
-180 Macro error	This error is generated when defining a macro or executing a macro.
-181 Invalid outside macro definition	Indicates that a macro parameter placeholder (\$<number>) was encountered outside of a macro definition.
-183 Invalid inside macro definition	Indicates that the program message unit sequence, sent with a *DDT or *DMC command, is syntactically invalid.
-184 Macro parameter error	Indicates that a command inside the macro definition had the wrong number or type of parameters.

## Execution Errors

-200 Execution error	This is the generic syntax error for devices that cannot detect more specific errors. This code indicates only that an Execution Error as defined in IEEE 488.2 has occurred.
-201 Invalid while in local	Indicates that a command is not executable while the device is in local due to a hard local control
-202 Settings lost due to rtl	Indicates that a setting associated with a hard local control was lost when the device changed to LOCS from REMS or to LWLS from RWLS.
-203 Command protected	Indicates that a legal password-protected program command or query could not be executed because the command was disabled.
-210 Trigger error	
-211 Trigger ignored	Indicates that a GET, *TRG, or triggering signal was received and recognized by the device but was ignored because of device timing considerations.
-212 Arm ignored	Indicates that an arming signal was received and recognized by the device but was ignored.
-213 Init ignored	Indicates that a request for a measurement initiation was ignored as another measurement was already in progress.
-214 Trigger deadlock	Indicates that the trigger source for the initiation of a measurement is set to GET and subsequent measurement query is received. The measurement cannot be started until a GET is received, but the GET would cause an INTERRUPTED error.

---

-215 Arm deadlock	Indicates that the arm source for the initiation of a measurement is set to GET and subsequent measurement query is received. The measurement cannot be started until a GET is received, but the GET would cause an INTERRUPTED error.
-220 Parameter error	Indicates that a program data element related error occurred.
-221 Settings conflict	Indicates that a legal program data element was parsed but could not be executed due to the current device state.
-222 Data out of range	Indicates that a legal program data element was parsed but could not be executed because the interpreted value was outside the legal range as defined by the device.
-223 Too much data	Indicates that a legal program data element of block, expression, or string type was received that contained more data than the device could handle due to memory or related device-specific requirements.
-224 Illegal parameter value	Used where an exact value, from a list of possibilities, was expected.
-225 Out of memory.	The device has insufficient memory to perform the requested operation.
-226 Lists not same length.	Attempted to use LIST structure having individual LIST's of unequal lengths.
-230 Data corrupt or stale	Possibly invalid data; new reading started but not completed since last access.
-231 Data questionable	Indicates that measurement accuracy is suspect.
-232 Invalid format	Indicates that a legal program data element was parsed but could not be executed because the data format or structure is inappropriate.

-233 Invalid version	Indicates that a legal program data element was parsed but could not be executed because the version of the data is incorrect to the device.
-240 Hardware error	Indicates that a legal program command or query could not be executed because of a hardware problem in the device.
-241 Hardware missing	Indicates that a legal program command or query could not be executed because of missing device hardware.
-250 Mass storage error	Indicates that a mass storage error occurred.
-251 Missing mass storage	Indicates that a legal program command or query could not be executed because of missing mass storage.
-252 Missing media	Indicates that a legal program command or query could not be executed because of a missing media.
-253 Corrupt media	Indicates that a legal program command or query could not be executed because of corrupt media.
-254 Media full	Indicates that a legal program command or query could not be executed because the media was full.
-255 Directory full	Indicates that a legal program command or query could not be executed because the media directory was full.
-256 File name not found	Indicates that a legal program command or query could not be executed because the file name on the device media was not found.
-257 File name error	Indicates that a legal program command or query could not be executed because the file name on the device media was in error.

---

-258 Media protected	Indicates that a legal program command or query could not be executed because the media was protected.
-260 Expression error	Indicates that a expression program data element related error occurred.
-261 Math error in expression	Indicates that a syntactically legal expression program data element could not be executed due to a math error.
-270 Macro error	Indicates that a macro-related execution error occurred.
-271 Macro syntax error	Indicates that that a syntactically legal macro program data sequence, according to IEEE 488.2 could not be executed due to a syntax error within the macro definition.
-272 Macro execution error	Indicates that a syntactically legal macro program data sequence could not be executed due to some error in the macro definition.
-273 Illegal macro label	Indicates that the macro label defined in the *DMC command was a legal string syntax, but could not be accepted by the device.
-274 Macro parameter error	Indicates that the macro definition improperly used a macro parameter placeholder.
-275 Macro definition too long	Indicates that a syntactically legal macro program data sequence could not be executed because the string or block contents were too long for the device to handle.
-276 Macro recursion error	Indicates that a syntactically legal macro program data sequence could not be executed because the device found it to be recursive.

-277 Macro redefinition not allowed	Indicates that a syntactically legal macro label in the *DMC command could not be executed because the macro label was already defined.
-278 Macro header not found	Indicates that a syntactically legal macro label in the *GMC? query could not be executed because the header was not previously defined.
-280 Program error	Indicates that a downloaded program-related execution error occurred.
-281 Cannot create program	Indicates that an attempt to create a program was unsuccessful. A reason for the failure might include not enough memory.
-282 Illegal program name	The name used to reference a program was invalid.
-283 Illegal variable name	An attempt was made to reference a nonexistent variable in a program.
-284 Program currently running	Certain operations dealing with programs may be illegal while the program is running.
-285 Program syntax error	Indicates that a syntax error appears in a downloaded program.
-286 Program runtime error	
-290 Memory use error	Indicates that a user request has directly or indirectly caused an error related to memory or <data_handle>s, this is not the same as "bad" memory.
-291 Out of memory	
-292 Referenced name does not exist	
-293 Referenced name already exists	



-294 Incompatible type Indicates that the type or structure of a memory item is inadequate.

#### Device Specific Errors

-300 Device-specific error This is the generic device-dependent error for devices that cannot detect more specific errors.

-310 System error Indicates that some error, termed "system error" by the device, has occurred.

-311 Memory error Indicates some physical fault in the device's memory, such as parity error.

-312 PUD memory lost Indicates that the protected user data saved by the \*PUD command has been lost.

-313 Calibration memory lost Indicates that nonvolatile calibration data used by the \*CAL? command has been lost.

-314 Save/recall memory lost Indicates that the nonvolatile data saved by the \*SAV? command has been lost.

-315 Configuration memory lost Indicates that nonvolatile configuration data saved by the device has been lost.

-320 Storage fault [Indicates that the firmware detected a fault when using data storage. This error is not an indication of physical damage or failure of any mass storage element.

-321 Out of memory An internal operation needed more memory than was available.

-330 Self-test failed Fail of Self Test.

-340 Calibration failed Fail of Calibration.

-350 Queue overflow A specific code entered into the queue in lieu of the code that caused the error. This code indicates that there is no room in the queue and an error occurred but was not recorded.

-360 Communication error	This is the generic communication error.
-361 Parity error in program message	Parity bit not correct when data received.
-362 Framing error in program message	A stop bit was not detected when data was received.
-363 Input buffer overrun	Software or hardware input buffer on serial port overflows with data caused by improper or nonexistent pacing.
-365 Time out error	This is a generic device-dependent error.

#### Query Errors

-400 Query error	This is the generic query error.
-410 Query INTERRUPTED	Indicates that a condition causing an INTERRUPTED Query error occurred.
-420 Query UNTERMINATED	Indicates that a condition causing an UNTERMINATED Query error occurred.
-430 Query DEADLOCKED	Indicates that a condition causing an DEADLOCKED Query error occurred.
-440 Query UNTERMINATED after indefinite response	Indicates that a query was received in the same program message after a query requesting an indefinite response was executed

#### Power On Event Commands

-500 Power on	The instrument has detected an off to on transition in its power supply.
---------------	--

#### User Request Event

-600 User request	The instrument has detected the activation of a user request local control.
-------------------	---

**Request Control Event**

-700 Request control      The instrument requested to become the active IEEE 488.1 controller-in-charge.

**Operation Complete Event**

-800 Operation complete      The instrument has completed all selected pending operations in accordance with the IEEE 488.2 synchronization protocol.