

# Multi-phase Programmable AC/DC Power Source

ASR-6000 Series

---

## USER MANUAL

Rev. C



ISO-9001 CERTIFIED MANUFACTURER

**GW INSTEK**

This manual contains proprietary information, which is protected by copyright. All rights are reserved. No part of this manual may be photocopied, reproduced or translated to another language without prior written consent of Good Will company.

The information in this manual was correct at the time of printing. However, Good Will continues to improve products and reserves the rights to change specification, equipment, and maintenance procedures at any time without notice.

**Good Will Instrument Co., Ltd.**  
**No. 7-1, Jhongsing Rd., Tucheng Dist., New Taipei City 236, Taiwan.**

# Table of Contents

<b>SAFETY INSTRUCTIONS .....</b>	<b>5</b>
<b>GETTING STARTED.....</b>	<b>9</b>
ASR-6000 Series Overview .....	10
Appearance.....	17
Theory of Operation .....	27
<b>OPERATION .....</b>	<b>38</b>
Set Up .....	40
Menu Tree .....	74
Basic Operation.....	78
Advanced Settings .....	119
<b>EXTERNAL CONTROL .....</b>	<b>150</b>
External I/O Connector.....	151
External Signal Input Function.....	152
<b>MISCELLANEOUS .....</b>	<b>158</b>
T peak, hold.....	159
Phase Mode.....	161
Peak CLR .....	163
Power ON .....	165
Buzzer .....	167
Remote Sense.....	168
V Response.....	170
Output Relay .....	171
THD Format .....	172
External Control.....	174
V Unit.....	175
Set Change Phase .....	176
Monitor Output 1 and 2.....	177
Monitor Output Amplitude .....	179

Trigger Out Width .....	180
Trigger Out Source.....	182
Re-lock.....	184
Data Average Count .....	186
Data Update Rate .....	187
<b>TEST MODE FUNCTION .....</b>	<b>188</b>
Sequence Mode .....	189
Simulate Mode .....	207
<b>COMMUNICATION INTERFACE .....</b>	<b>219</b>
Interface Configuration .....	220
<b>FAQ.....</b>	<b>242</b>
<b>APPENDIX.....</b>	<b>243</b>
Firmware Update .....	243
Factory Default Settings .....	245
Error Messages & Messages .....	249
Specifications .....	254
Information of Name Order .....	264
ASR-6000 Dimensions .....	265
Declaration of Conformity.....	266
Maintenance & Regular Inspection .....	267
<b>INDEX.....</b>	<b>269</b>

# S SAFETY INSTRUCTIONS

This chapter contains important safety instructions that you must follow during operation and storage. Read the following before any operation to ensure your safety and to keep the instrument in the best possible condition.

## Safety Symbols

These safety symbols may appear in this manual or on the instrument.

---



WARNING

Warning: Identifies conditions or practices that could result in injury or loss of life.



CAUTION

Caution: Identifies conditions or practices that could result in damage to the ASR-6000 or to other properties.



DANGER High Voltage



Attention Refer to the Manual



Protective Conductor Terminal



Earth (ground) Terminal



Do not dispose electronic equipment as unsorted municipal waste. Please use a separate collection facility or contact the supplier from which this instrument was purchased.

## Safety Guidelines

---

### General Guideline



### CAUTION

- Do not place any heavy object on the ASR-6000.
- Avoid severe impact or rough handling that leads to damaging the ASR-6000.
- Do not discharge static electricity to the ASR-6000.
- Use only mating connectors, not bare wires, for the terminals.
- Do not block the cooling fan opening.
- Do not disassemble the ASR-6000 unless you are qualified.
- If the equipment is used in a manner not specified by the manufacturer, the protection provided by the equipment may be impaired.
- Due to the fact that ASR-6000 unit weights greater than 18kg, please resort to the standard kit GRA-451-E for transport or remove the unit by at least two persons in case of danger occurred.

## Power Supply



## WARNING

- AC Input voltage range:  
200 Vac to 240 Vac  $\pm 10\%$   
phase voltage (Delta: L-L, Y: L-N)
- Frequency: 47 ~ 63 Hz
- To avoid electrical shock connect the protective grounding conductor of the AC power cord to an earth ground.
- The power switch that is included in the instrument is not considered a disconnecting device.
- The permanently connected power input is used as the disconnecting device and shall remain readily operable.
  - a. A switch or circuit-breaker must be included in the installation
  - b. It must be suitably located and easily reached
  - c. It must be marked as the disconnecting device for the equipment.
  - d. It shall be located near the equipment
- Do not position the equipment so that it is difficult to operate the disconnecting device.
- Ask for professional technician for installation.
- It requires 200Vac input condition and the maximum input current [30A (ASR-6450), 40A (ASR-6600)], which conforms to cord diameter by local regulations.
- Breaker, of which the specification is required to larger than 30A (ASR-6450), 40A (ASR-6600) individually, should be in the near proximity of unit.
- The ASR-6000 model shall be employed in rack-based applications and it shall not be connected to external cord directly. In addition, installation shall be done by a qualified person in accordance with local regulations. The ASR-6000 model is not to be used in standalone scenario.

- 
- Cleaning the ASR-6000
- Disconnect the circuit-breaker or permanently connected power input before cleaning.
  - Use a soft cloth dampened in a solution of mild detergent and water. Do not spray any liquid.
  - Do not use chemicals containing harsh material such as benzene, toluene, xylene, and acetone.
- 

Operation Environment

- Location: Indoor, no direct sunlight, dust free, almost non-conductive pollution (Note below)
- Relative Humidity: 20%~ 80%, no condensation
- Altitude: < 2000m
- Temperature: 0°C to 40°C

(Pollution Degree) EN 61010-1:2010 specifies the pollution degrees and their requirements as follows. The ASR-6000 falls under degree 2.

Pollution refers to “addition of foreign matter, solid, liquid, or gaseous (ionized gases), that may produce a reduction of dielectric strength or surface resistivity”.

- Pollution degree 1: No pollution or only dry, non-conductive pollution occurs. The pollution has no influence.
  - Pollution degree 2: Normally only non-conductive pollution occurs. Occasionally, however, a temporary conductivity caused by condensation must be expected.
  - Pollution degree 3: Conductive pollution occurs, or dry, non-conductive pollution occurs which becomes conductive due to condensation which is expected. In such conditions, equipment is normally protected against exposure to direct sunlight, precipitation, and full wind pressure, but neither temperature nor humidity is controlled.
- 

Storage environment

- Location: Indoor
  - Temperature: -10°C to 70°C
  - Relative Humidity: ≤90%, no condensation
- 

Disposal



Do not dispose this instrument as unsorted municipal waste. Please use a separate collection facility or contact the supplier from which this instrument was purchased. Please make sure discarded electrical waste is properly recycled to reduce environmental impact.



# G E T T I N G S T A R T E D

This chapter describes the ASR-6000 power supply in a nutshell, including its main features and front / rear panel introduction.

## ASR-6000 series



<b>ASR-6000 Series Overview .....</b>	<b>10</b>
Series lineup .....	10
Operating Area .....	11
Main Features .....	13
Accessories .....	15
<b>Appearance .....</b>	<b>17</b>
Front Panel .....	17
Rear Panel .....	22
Status Bar Icons .....	25
<b>Theory of Operation .....</b>	<b>27</b>
Description of ASR-6000 System .....	27
Glossary .....	28
Alarms .....	32
Grounding for 1P2W Output .....	35
Considerations .....	36

## ASR-6000 Series Overview

### Series lineup

The ASR-6000 series consists of 2 models, the ASR-6450 and ASR-6600, differing in capacity. Note that throughout the user manual, the term “ASR-6000” refers to any of the models, unless stated otherwise.

#### 1P Output Condition

Model Name	Power Rating	Max. Output Current	Max. Output Voltage
ASR-6450	4500 VA	45 / 22.5 A	350 Vrms / 500 Vdc
ASR-6600	6000 VA	60 / 30 A	350 Vrms / 500 Vdc

#### 1P3W Output Condition

Model Name	Power Rating	Max. Output Current	Max. Output Voltage
ASR-6450	3000 VA	15 / 7.5 A	700 Vrms / 1000 Vdc
ASR-6600	4000 VA	20 / 10 A	700 Vrms / 1000 Vdc

#### 3P Output Condition (Pre phase)

Model Name	Power Rating	Max. Output Current	Max. Output Voltage
ASR-6450	1500 VA	15 / 7.5 A	350 Vrms / 500 Vdc
ASR-6600	2000 VA	20 / 10 A	350 Vrms / 500 Vdc

## Operating Area

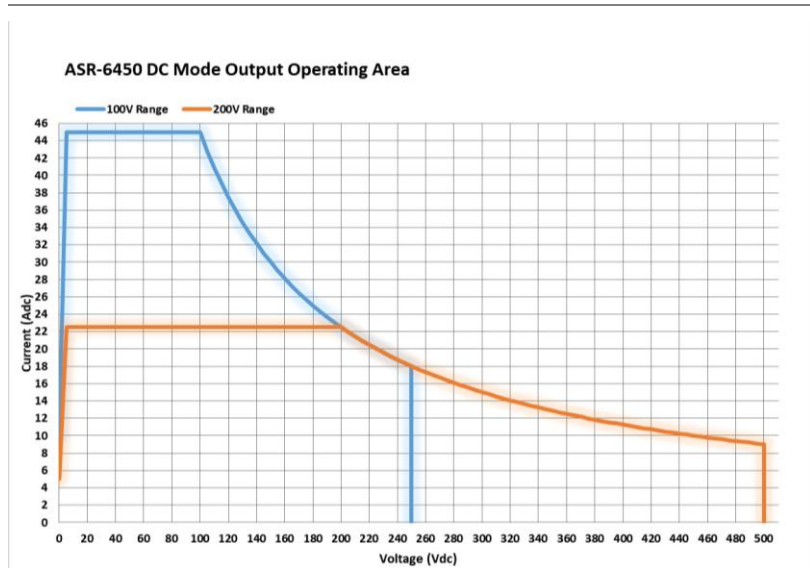
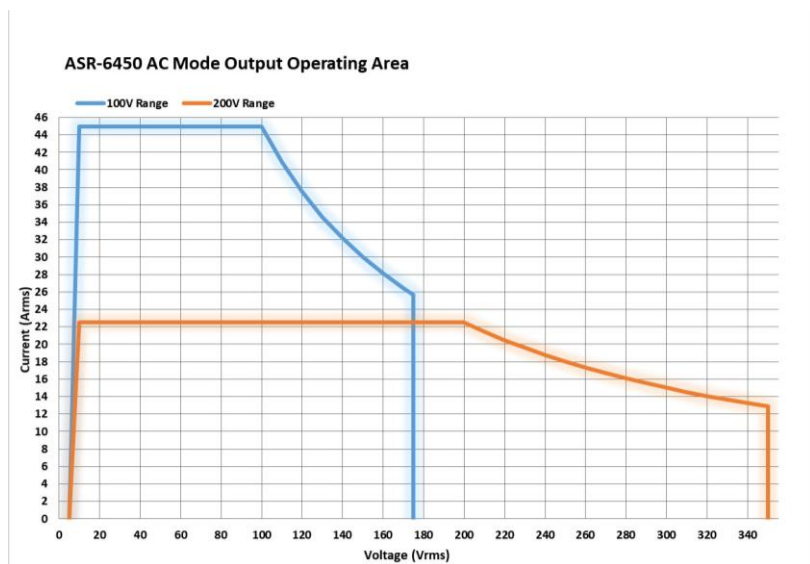

**ASR-6600 AC Mode Output Operating Area**

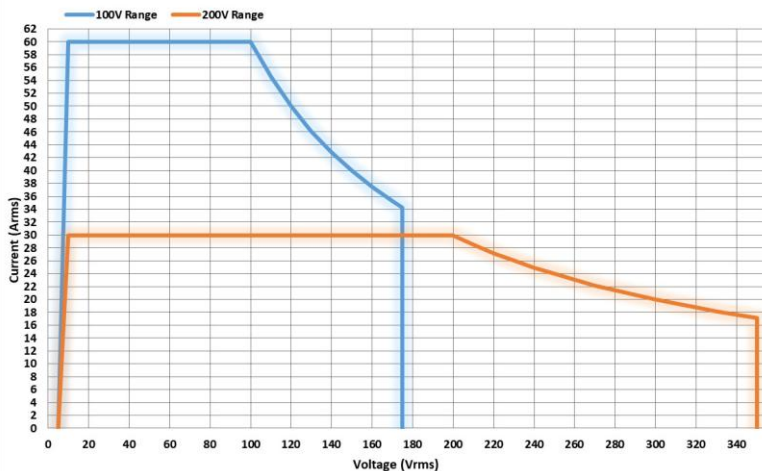

**ASR-6600 DC Mode Output Operating Area**

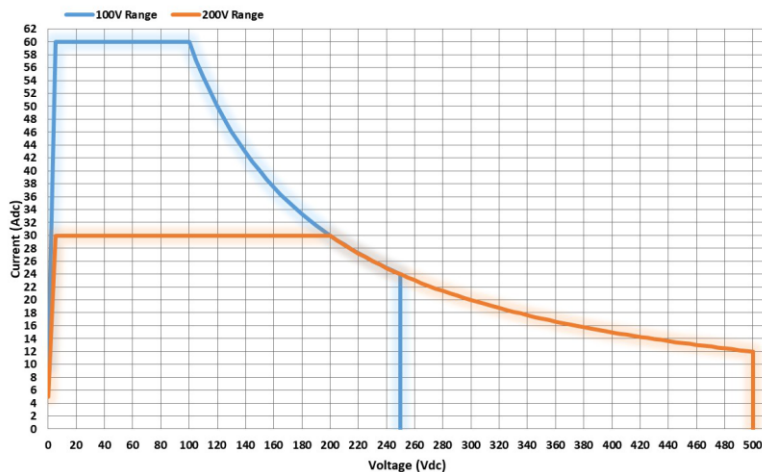

## Main Features

---

- |             |   |
|-------------|---|
| Performance | <ul style="list-style-type: none"><li>• Maximum phase voltage is 350 Vrms, line voltage is 700 Vrms</li><li>• Maximum DC output voltage is 1000 Vdc</li><li>• Maximum output frequency is 2000 Hz</li><li>• Adjustable Voltage rising time</li><li>• DC full capacity output ability</li><li>• Output voltage total harmonic distortion is less than 0.3% at 50 and 60 Hz</li><li>• Maximum crest factor reached 4 times</li></ul>  |
| Features    | <ul style="list-style-type: none"><li>• Include sine, square, triangle, arbitrary and DC output waveforms</li><li>• Variable voltage, frequency and current limiter</li><li>• 100 steps Harmonic voltage and current analysis ability</li><li>• Supported three phase unbalanced output mode</li><li>• Sequence, simulate and preset memory functions</li><li>• AC line frequency synchronized output</li><li>• USB memory save and recall</li><li>• Remote sense compensator</li><li>• Supported 1P, 1P3W and 3P output phase</li><li>• External control I/O and signal input applications</li><li>• Voltage and current monitor output</li><li>• Voltage control amplifier output</li><li>• PC software, web control and data log functions</li></ul> |
-

- Interface
- Built-in LAN, USB host, USB device and RS232 interface
  - Optional GPIB, DeviceNet and CAN BUS interface

## Accessories

Before using the ASR-6000 power source unit, check the package contents to make sure all the standard accessories are included.

Standard Accessories	Part number	Description
		Quick Start Guide
	82GW1SAFE0M*1	Safety guide
	62SR-6K0SC401	Input terminal cover
	62SR-6K0SC301	Output terminal cover
	62SR-6K0CP101	Copper plate for delta connection input (Mark 1)
	62SR-6K0CP201	Copper plate for single phase and Y connection input (Mark 2)
	62SR-6K0CP301	Copper plate for delta connection input (Mark 3)
	62SR-6K0CP401	Copper plate for 1P output (Mark 4)
	GRA-451-E	Rack mount adapter (EIA)
	GTL-246	USB cable (USB 2.0 Type A - Type B cable, approx. 1.2M)
Optional Accessories	Part number	Description
	GRA-451-J	Rack mount adapter (JIS)
	GPW-008	Power Cord SJT 10AWG/3C, 3m Max Length, 105oC, RV5-5*3P, RV5-5*3P UL TYPE
	GPW-012	Power Cord H05VV-F 2.5mm <sup>2</sup> /5C, 3m Max Length, 105oC, RVS3-5*5P, RVS3-5*5P VDE TYPE

GPW-013	Power Cord VCTF 2.0mm <sup>2</sup> /5C, 3m Max Length, 105oC, , RVS2-5*5P, RVS2-5*5P PSE TYPE
GPW-014	Power Cord SJT 10AWG/4C, 3m Max Length, 105oC, RV5-5*4P, RV5-5*4P UL TYPE
GPW-015	Power Cord H05VV-F 2.5mm <sup>2</sup> /4C, 3m Max Length, 105oC, RVS3-5*4P, RVS3-5*4P VDE TYPE
GTL-232	RS232C cable, approx. 2M
GTL-248	GPIB cable, approx. 2M
ASR-003	GPIB interface card
ASR-004	DeviceNet interface card
ASR-005	CAN BUS interface card
ASR-006	External parallel cable



Note

- GPW-008 is for single phase input only.
- GPW-012 and 013 are for Y connection input only.
- GPW-014 and 015 are for Delta connection input only.



# Appearance

## Front Panel

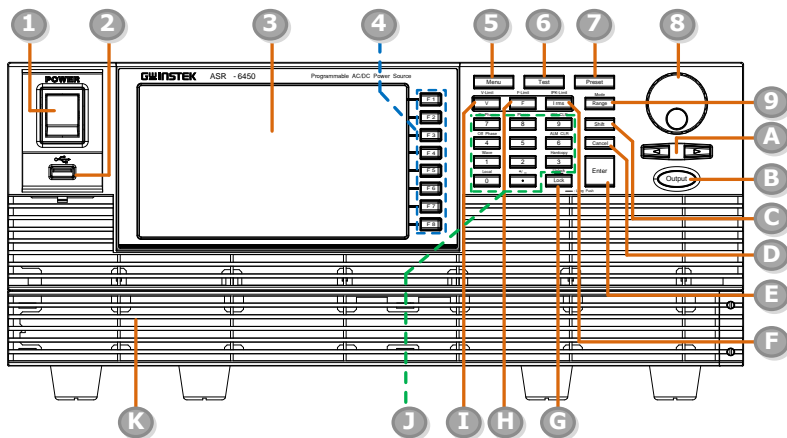



Item Index	Description
1	Power switch button
2	USB interface connector (A Type)
3	LCD screen
4	Function keys (blue zone)
5	Menu key
6	Test key
7	Preset key
8	Scroll wheel
9	Range key/Output mode key
A	Arrow keys
B	Output key
C	Shift key

D	Cancel key
E	Enter key
F	Irms/IPK-Limit button
G	Lock/Unlock button
H	F/F-Limit button
I	V/V-Limit button
J	Numerical Keypad with additional “Shift + key” shortcut functions (green zone)
K	Air inlet

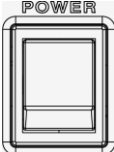







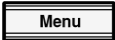

Item	Description
------	-------------

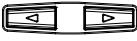
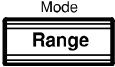

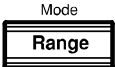

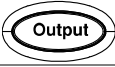



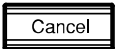



Power Switch		Turn on the mains power
--------------	---	-------------------------





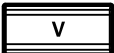

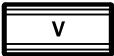





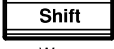
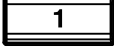

USB A Port		<p>The USB port is used for data transfers and upgrading software. Also, it is available for screenshot hardcopy.</p> <p> It supports FAT32 format with maximum 32G storage.</p>
------------	---	---

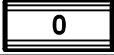
LCD Screen	Displays the setting and measured values or menu system
------------	---

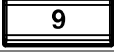
Function Keys		Assigned to the functions displayed on the right side of the screen.
---------------	---	--

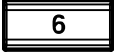
Menu Key		Enters the Main menu or goes back to one of the display modes.
Test Key		Puts the instrument into the Sequence and Simulation control mode.
Preset Key		Puts the instrument into Preset mode.
Arrow Keys		The arrow keys are used to select the digit power of a value that is being edited.
Range Key		Switches between the 100V, 200V and AUTO ranges
Output Mode	 + 	Selects between the AC+DC-INT, AC-INT, DC-INT, AC+DC-EXT, AC-EXT, AC+DC-ADD, AC-ADD, AC+DC-Sync, AC-Sync and AC-VCA modes.
Scroll Wheel		Used to navigate menu items or for increment/decrement values one step at a time.
Output Key		Turns the output on or off.
Shift Key		Turns on the shift state, which enables shortcut operations with an icon  indicated on the top status bar. The shift state, which allows continuous shortcut operations, is kept until another press on shift key again.
		When performing shortcut operations, press shift key followed by another shortcut function key. Do Not press both shift key and shortcut function key simultaneously.
Cancel Key		Used to cancel function setting menus or dialogs.

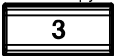

Enter Key		Confirms selections and settings.
Irms	<p style="text-align: center;">IPK-Limit</p> 	Used for setting the maximum output current.
IPK-Limit	<p style="text-align: center;">Shift</p> <p style="text-align: center;">+ IPK-Limit</p>  <p style="text-align: center;">Irms</p> 	Used to set the peak output current limit value.
Lock/Unlock Key	<p style="text-align: center;">Unlock</p>  <p style="text-align: center;">Lock</p> <p style="text-align: center;">— : Long Push</p>	Used to lock or unlock the front panel keys except output key. Simply press to lock, whilst long press to unlock.
F	<p style="text-align: center;">F-Limit</p> 	Used for setting the output frequency (DC mode N/A).
F-Limit	<p style="text-align: center;">Shift</p> <p style="text-align: center;">+ F-Limit</p>  <p style="text-align: center;">F</p> 	Used for setting the output frequency limit value (DC mode N/A).
V	<p style="text-align: center;">V-Limit</p> 	Used for setting the output voltage.
V-Limit	<p style="text-align: center;">Shift</p> <p style="text-align: center;">+ V-Limit</p>  <p style="text-align: center;">V</p> 	Used for setting the output voltage limit value.
Keypad		Used to input power of a value directly. The  key is used to input decimal / plus or minus.

On Phase	 <small>On Phase</small> 	+ Sets the on phase for the output voltage.
Off Phase	 <small>Off Phase</small> 	+ Sets the off phase for the output voltage.
Output Waveform	 <small>Wave</small> 	+ Selects between the Sine, Square, Triangle and ARB 1~253 waveforms (not available for DC-INT, AC+DC-EXT and AC-EXT).
Local Mode	 <small>Local</small> 	+ Switches operation back to local mode from remote mode.
IPK CLR	 <small>IPK CLR</small> 	+ Used to clear peak output current value.
ALM CLR	 <small>ALM CLR</small> 	+ Clears alarms.
Hardcopy Key	 <small>Hardcopy</small> 	+ Used to take a screenshot. Make sure an USB flash disk is well inserted before the action.
Output Phase	 <small>Phase</small> 	+ Used to prompt the output phase window where 1P2W, 1P3W and 3P4W modes are available for selection.

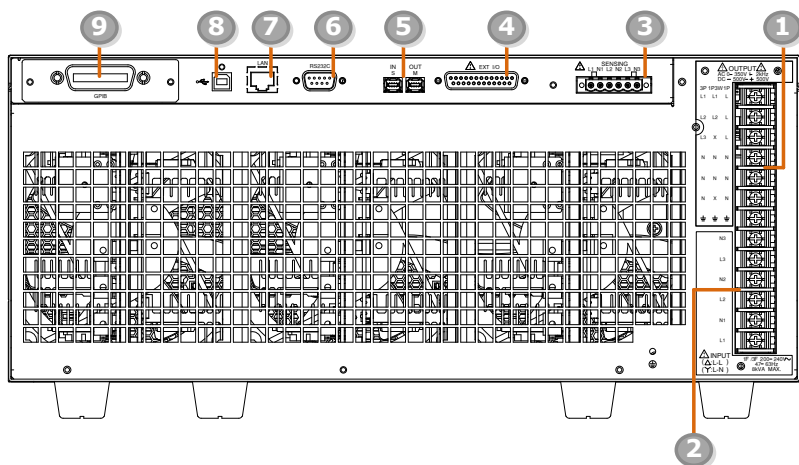
**Rear Panel**

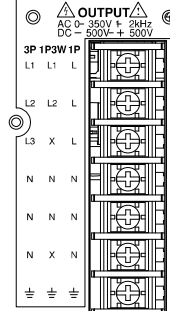
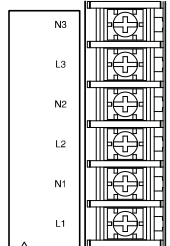
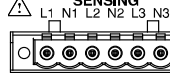

Item Index	Description
1	Output terminal
2	AC power input terminal
3	Remote sensing input terminal
4	External I/O connector
5	External IN/OUT connection in parallel function
6	RS232 connector
7	Ethernet (LAN) connector
8	USB interface connector (B Type)
9	Optional interface Slot <ul style="list-style-type: none"> <li>▪ GPIB card (ASR-003)</li> <li>▪ DeviceNet card (ASR-004)</li> <li>▪ CAN BUS card (ASR-005)</li> </ul>

Item	Description
Output Terminal	<div style="display: flex; align-items: center;"> <div style="border: 1px solid black; padding: 5px; margin-right: 10px;"> <p style="text-align: center;">⚠ <b>OUTPUT</b> ⚠</p> <p style="text-align: center;">AC 0-350V ± 20Hz DC 0-500V ± 500V</p> </div>  <div style="margin-left: 10px;"> <p>Output terminal (M4 screw type, 8 ~ 18 AWG) (Screw torque value:18kgf-cm)</p> </div> </div>
AC Power Input Terminal	<div style="display: flex; align-items: center;">  <div style="margin-left: 10px;"> <p>AC inlet (M4 screw type, 8 ~ 18 AWG) (Screw torque value:18kgf-cm)</p> </div> </div> <div style="margin-top: 10px; font-size: small;"> <p>⚠ <b>INPUT</b> ⚠ (Δ:L-L) 1Φ/3Φ 200-240V~ (Y:L-N) 47-63Hz 8kVA MAX.</p> </div>
Remote Sensing Input Terminal	<div style="display: flex; align-items: center;"> <div style="margin-right: 10px;"> <p style="text-align: center;">⚠ <b>SENSING</b> ⚠</p>  </div> <div> <p>Remote sensing input terminal is for compensation of load wire voltage drop. (M2.5 screw type, 12 ~ 30 AWG) (Screw torque value: 0.5N*m) (Strip length: 7 ~ 8mm)</p> </div> </div>
External Control I/O Connector	<div style="display: flex; align-items: center;"> <div style="margin-right: 10px;"> <p style="text-align: center;">⚠ EXT I/O ⚠</p>  </div> <div> <p>Used to control ASR-6000 externally by using the logic signal and monitor Sequence function status.</p> </div> </div>
External IN/OUT Connection in Parallel Function	<div style="display: flex; align-items: center;"> <div style="margin-right: 10px;"> <p style="text-align: center;">IN S      OUT M</p>  </div> <div> <p>The IN (Slave) and OUT (Master) ports are used for connection with external unit in parallel function.</p> </div> </div>

RS232C  
Connector

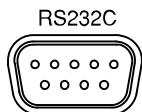

The RS232C connector for controlling the ASR-6000 remotely.

Ethernet LAN  
Port

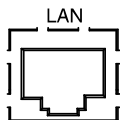

The Ethernet port is used for remote control.

USB B-type Port



USB port for controlling the ASR-6000 remotely.

Optional GPIB  
Connector



The optional GPIB connector for controlling the ASR-6000 remotely.

Optional CAN  
BUS Connector

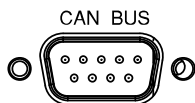

The optional CAN BUS connector for controlling the ASR-6000 remotely.

Optional  
DeviceNet  
Connector

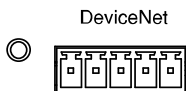

The optional DeviceNet connector for controlling the ASR-6000 remotely.



Status Bar Icons

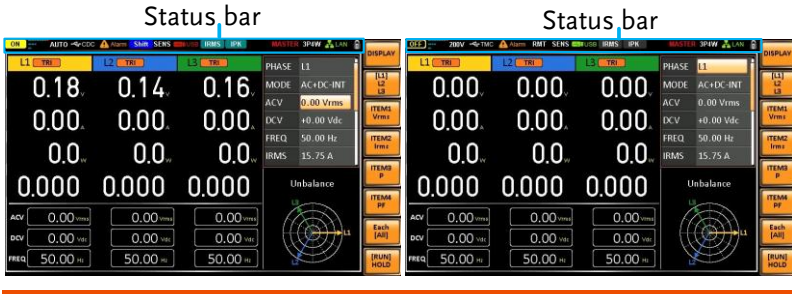

Indicates if the output is ON or OFF.



Indicates the output power percentage of pre output phase. When it is under 1P2W, the icon appears with 1 line (single phase). And it will be 2 lines (two phase) for 1P3W, and 3 lines (three phase) for 3P4W. The 1 line corresponding to 1P2W represents the full power of single phase, whereas the 2 lines corresponding to 1P3W or 3 lines corresponding to 3P4W stand for the maximum power of each phase.



Indicates that the rear panel USB is TMC or CDC type.



**100V**

**200V**

Indicates if the output range is 100V, 200V or AUTO.

**Alarm**

The alarm icon will appear on the status bar when one of the protection functions is tripped.

---

**Shift**

Indicates the shift key is pressed which enables shortcut operations with each key.

---

**RMT**

Indicates that the ASR-6000 is under remotely control mode.

---

**SENS**

Indicates that the Remote Sensing function is active.

---

**USB**

Indicates that a USB flash drive is detected and in normal connection.

---

**USB**

Indicates that a USB flash drive is detected and in abnormal connection.

---

**IRMS**

Indicates that the RMS current limit function is activated.

---

**IPK**

Indicates that the peak current limit function is activated.

---

**MASTER**

Indicates that the power unit is set to Master under external parallel mode.

---

**3P4W**

Indicates that the output phase is 1P2W, 1P3W or 3P4W status.

---

**LAN**

Indicates that the LAN interface is activated.

---



Indicates that the front panel lock is active.

---

## Theory of Operation

The theory of operation chapter describes the basic principles of operation, protection modes and important considerations that must be taken into account before use.

### Description of ASR-6000 System

System block are composed of the parts described below.

---

- **Input EMI Filter and PFC Circuit**      A two stage  $\pi$  filter and a passive PFC circuit that convert AC power to DC power.
- **Main and Module Auxiliary Power**      It converts AC power line input to +24Vdc power for the isolated flyback dc to dc converters, fans, digital control systems, among other devices.
- **Isolation DC to DC Converter**      The isolation DC to DC converter is able to convert high DC level to lower that not only offers inverter a stable DC source but separates primary and secondary side efficiently.
- **Output Power Stage (inverter)**      Two inverter power stages are in parallel or in series that provide, in addition to AC and DC output, sinusoid, square as well as triangle output waveforms.
- **Digital Processor and Close Loop Control Circuit**      Composition of the FPGA device and the closed-loop control circuit that execute inverter action, output measurement and all of the relevant protection functions.
- **Communication Interface and Data Transmission**      DSP and LCD controller that are collectively responsible for interface communication, data transmission, LED panel control as well as remote control.
- **Keypad and Display**      CPLD that controls keys action and communicates with DSP for data transmission.

## Glossary

---

### Rate Output Maximum Power Capacity

The maximum value of the output power capacity will be provided consecutively when the following situations exist:

Output voltage is 100 to 175 V within the 100 V range.

Output voltage is 200 to 350 V within the 200 V range.

Output frequency is 15 to 2000 Hz in AC mode.

Output frequency is 1 to 2000 Hz in AC+DC mode.

Output voltage is 100 to 250 V within the 100 V range in DC mode.

Output voltage is 200 to 500 V within the 200 V range in DC mode.

### Rate Maximum Current

The maximum value of the output current (rms value) will be provided consecutively when the following situations exist:

Output voltage is 100 V within the 100 V range.

Output voltage is 200 V within the 200 V range.

Output frequency is 15 to 2000 Hz in AC mode.

Output frequency is 1 to 2000 Hz in AC+DC mode.

Output voltage is 100 V within the 100 V range in DC mode.

Output voltage is 200 V within the 200 V range in DC mode.



Note

The maximum capacity and current in DC mode is equal to AC+ DC and AC mode.

Equation:

$$\text{Rated Max. current} = \frac{\text{Rate power capacity}(VA, W)}{\text{Output voltage}}$$

Maximum Peak Current (AC-INT mode only)

The maximum value of the output current (peak value) will be provided consecutively to a capacitor input-type rectifying load when the following situations exist:

Output voltage is 100 to 175 V within the 100 V range.

Output voltage is 200 to 350 V within the 200 V range.

Output frequency is 15 to 2000 Hz in AC mode, and 1 to 2000 Hz in AC+DC mode.



Note

Rated maximum current (rms value) x 4 is equal to maximum peak current

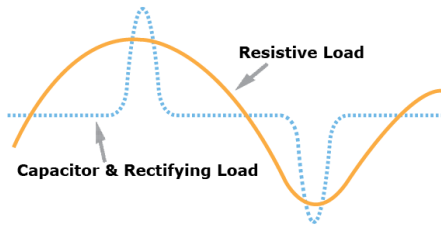

Power Factor (PF)

The power factor, which stands for a ratio of the active power correlated to the apparent power, indicates degradation level within efficiency that results from the phase difference between AC current and AC voltage.

Equation:

$$\text{Power factor} = \frac{\text{Active Power}}{\text{Apparent Power}}$$

Crest Factor (CF)      The crest factor stands for a ratio of the rms value correlated to the peak value (crest value) of the waveform.

Equation:

$$\text{Crest factor} = \frac{\text{Peak value}}{\text{RMS value}}$$



Note

The crest factor is 1.41 of sine wave, 1 of square wave, 1.717 of triangle wave.

Inrush Current Capacity

It indicates the current, which is able to be supplied to a load, exceeds the rating for a short period and the duration.

Output Power Ratio

It indicates the output power of a percentage where the rated maximum output power is 100%.

Y Connection

Three-phase "Y" connection has three voltage sources connected to a common point. In a Y connection system, there may not be a neutral wire so that we call 3-phase, 3-wire system.

Delta Connection

Three-phase "delta" connection seems as though three voltage sources that can create a short circuit. A delta connection is a three-wire circuit which three elements resemble a triangular arrangement of electrical three-phase windings.

Output Phase

1P	Single phase output
1P3W	Single phase three wire or two phase output
3P	Three phase output include delta or Y connection that depend on user's application

### Three Phase Unbalance

Phase unbalance of a three-phase system exists when one or more of the line-to-line voltages in a three-phase system are mismatched. Three-phase power systems and equipment are intended to operate with phases (Lines) balanced.

Line-to-line voltages in a three-phase circuit typically vary by a few volts, but a difference that exceeds 1% can damage motors and equipment.

### Phase Voltage and Line Voltage

In three-phase AC power output, when the phase difference between L1, L2 and L3 is 120 degrees, the output voltage are equal as below.  
Line voltage =  $\sqrt{3}$  x Phase voltage.

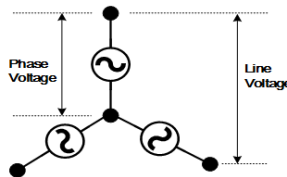

## Alarms

The ASR-6000 series have a number of protection features. When one of the protection alarms is tripped, the ALM icon on the display will be lit and the type of alarm that has been tripped will be shown on the display. When an alarm has been tripped the output will be automatically turned off. Also, the countermeasures to alarms will be shown as well on the display. For details on how to clear an alarm or to set the protection modes, please see page 249.

Over Ipeak+ Current	Positive output current peak value is excessive, press "Shift + 6" will clear this alarm.
Over Ipeak- Current	Negative output current peak value is excessive, press "Shift + 6" will clear this alarm.
Over RMS Current	Output current RMS value is excessive, press "Irms" to check allowance set range.
Over Voltage(1)/ Over Voltage(2)	Over internal maximum voltage (110% of rating voltage) , press "Shift + 6" will clear this alarm.
Over Power Protect	Over internal power stage maximum power (110% of rating power), press "Shift + 6" will clear this alarm.
Output Short(1)/ Output Short(2)	Call attention to output terminal short status.
Over Temperature Protect(1)/ PFC_OTP/Over Temperature Protect(2)	Over Temperature Protect, Output after cooling down.
Fan Failure	Fan failure. Contact service center.
PFC Power Unit Error	Internal PFC power unit function error. Contact local distributor.
Power Input Anomaly	The power input voltage is insufficient or turning off main power switch. Check input power before rebooting the unit.



Startup_Alarm/ HW Model Startup Error (Bit: #)	Abnormal startup procedure.Bit(0~19) Contact service center.
Module Error	Module Error. Contact service center.
Sensing Voltage Error	Remote sense connection wire is abnormal or over maximum compensation voltage. Press "Shift + 6" to clear this alarm.
Calibration data Error	The calibration data is abnormal or out of allowance range. Contact service center.
DCDC ERR	Internal DCDC power unit function error. Contact local distributor.
Local Communication Error	Internal Communication Abnormality.
SCPI Error	Communication with the SCPI command error.
External Sync Frequency Error	The external synchronization signal input frequency is out of the allowance range.
Power ON Fail	Power ON Function Fail In Error Mode or Range.
IRMS Limit Operations	The RMS current limiter is activated. Press "Irms" to check allowance set range.
IPK Limit Operations	The peak current limiter is activated. Press " Shift + Irms" to check allowance set range.
Remote Sensing L(#)\Voltage Out of Range	The Sensing L(1~3) voltage limiter is activated.
System Error (#)	System Error (1~15). Contact service center.
Power Limit Operations	The Power limiter is activated.
Web Data Error!	This Cmessage will only be shown when texio update file is used and firmware is selected gw.
Preset Data Error	Preset data error (data beyond range or data lost).
ARB Data Error	ARB data error (data lost).

Parallel Version or Model Mismatch.  
Parallel Version or Model Mismatch.

Parallel Error/Parallel Communication Error(#)	Parallel Communication Error(0~5).
---	------------------------------------



Note

- If alarm state still exists after executing clear or reboot, contact your local maintenance center.
  - The system would be locked or automatically output off before error state is clear.
-

## Grounding for 1P2W Output

The output terminals of the ASR-6000 series are isolated with respect to the protective grounding terminal. The insulation capacity of the load, the load cables and other connected devices must be taken into consideration when connected to the protective ground or when floating.

Grounded Neutral Output	Basically, grounded return on the neutral output is allowed for ASR-6000 series and electric shock may occur if not following the grounding procedure based on the local electrical safety codes. In some cases, 0 V is specifically required between ground and neutral, which can substantially moderate ground loops, thus keeping sensitive equipment from effects of ground loops and reducing ground noise.
-------------------------	---

### Ground & Neutral Shortcut Illustration

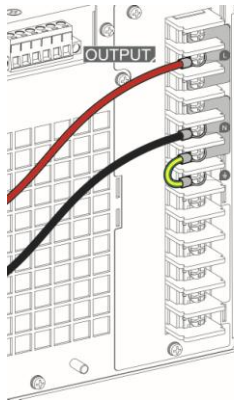

### CAUTION

- Owing to the fact that the neutral has been shortcut with the ground which is referenced to the chassis ground, few electric shocks may still take place from time to time, for which we sincerely ask your additional attention.
- In case of damage to unit, grounding is available for 1P output only, whilst neither 1P3W output nor 3P output is available for grounding.

## Considerations

The following situations should be taken into consideration when using the power supply.

**Inrush Current**      When the power supply switch is first turned on, an inrush current is generated. Ensure there is enough power available for the power supply when first turned on, especially if a number of units are turned on at the same time.

**Capacitive Load**      When the power supply connects to a capacitive load, e.g., capacitor, the load is being charged consecutively and the larger the voltage change, the more the current grow. Also, the overshoot will be possibly generated within the currents output, therefore leading to output turned off thanks to overcurrent protection from the power supply.

It is suggested to lower down the set voltage output from power supply so that the voltage of capacitive load decreases per certain unit time. In addition, a block diode is necessary to keep current from flowing back to the output terminal of power supply. Refer to the figure below where a block diode connects with the capacitive load in series to efficiently prevent current from flowing back to the power supply.

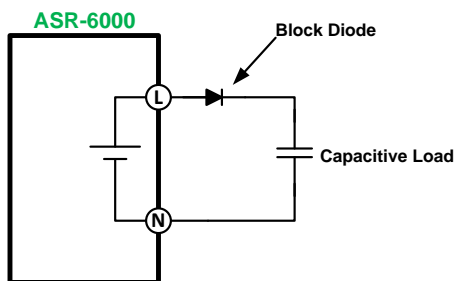

**Inductive Load**

When the power supply connects to an inductive load, e.g., inductor, which generates a back EMF (Electromotive Force) when output current is accidentally turned off, a backflow diode is necessary for absorbing the back EMF, which may cause irreversible damage to the power supply. Refer to the following figure where a backflow diode connects with the inductive load in parallel to effectively absorb the possible back EMF.

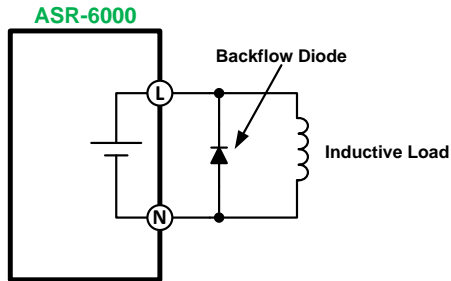
 **CAUTION**

Ensure the connected diode meets the following specifications between the load, either capacitor or inductor, and the ASR-6000 series power supplies.

- ✓ Maximum reverse voltage: 600V or higher depend on the output phase voltage
- ✓ Maximum forward current:
  - ASR-6450: 45 A or more for 100V range, and 22.5 A or more for 200V range
  - ASR-6600: 60 A or more for 100V range, and 30 A or more for 200V range

# OPERATION

---

<b>Set Up</b> .....	<b>40</b>
Power Up and Procedure .....	40
How to Use the Instrument .....	42
Input Terminal Connection .....	45
Output Terminal Connection.....	52
Remote Sensing Connection .....	57
Using the Rack Mount Kit .....	64
Optional Interface Installation .....	65
Reset to Factory Default Settings .....	67
View Firmware Version and Serial Number .....	68
USB Driver Installation .....	69
Air Inlet Cleaning and Installation .....	71
Wire Gauge Considerations .....	73
<b>Menu Tree</b> .....	<b>74</b>
Main – 1P2W .....	75
Main – 1P3W & 3P4W .....	76
Menu .....	77
<b>Basic Operation</b> .....	<b>78</b>
Select the Output Mode.....	79
Select the Output Phase .....	82
Select the Voltage Range.....	83
Select the Output Waveform .....	84
Setting the Frequency Limit .....	90
Setting the Output Frequency & Signal .....	93
Setting the Peak Current Limit.....	95
Setting the Output Current Level .....	97
Setting the Output On and Off Phase .....	99
Setting the SRC.....	101

---

Setting the Sync Phase .....	102
Switch the Display Modes.....	105
Using the Measurement Function .....	109
Setting the Phase and Line Voltage.....	112
Select the Each and All Setting Method .....	113
Switch the Measurement Format .....	114
Panel Lock .....	115
Alarm Clear.....	116
Turning the Output On/Off.....	117
Hardcopy.....	118
Local.....	118
<b>Advanced Settings.....</b>	<b>119</b>
Using the Remote Sense Function .....	119
Square Wave Signal Duty Ratio Adjustable.....	120
Preset Settings .....	121
Edit Arbitrary Waveform.....	128
External Keypad Operation .....	145
USB Keypad .....	145
Output Impedance Setting.....	146
External Parallel Operation .....	148

## Set Up

We take the illustration of Single Phase Input for example here. Please refer to page 45 of the chapter of Input Terminal Connection for detailed information of the 3 different connection methods.

### Power Up and Procedure

#### Steps

Assemble the two copper plates specific for Single phase input connection with the AC input terminals. The first plate is for L1, L2 and L3 terminals, while the other plate is for N1, N2 and N3 terminals.

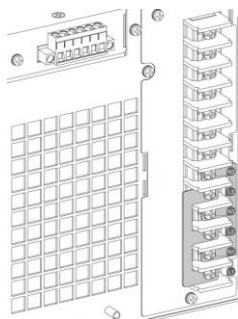

#### Note

In terms of the specific copper plates for Single Phase input connection, refer to page 46 for more details.

Connect the AC power cords to the AC input terminals.

- Red → Line (L)
- Black → Neutral (N)

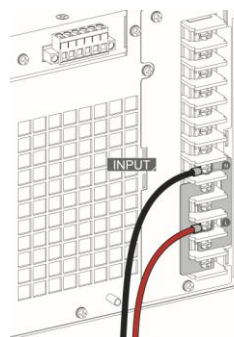

#### Note

- Power input cords are not included in this product.
- The input & output terminals necessitate connectivity through ring-type connectors.



Install the protective lid of power input terminals (main box x1 and side plate x1) followed by fastening the three screws to fix the lid firmly into place.

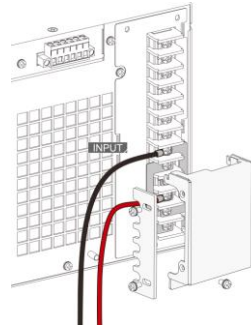

The AC power cords of Single phase input are connected with the AC input terminals equipped with protective lid completely.

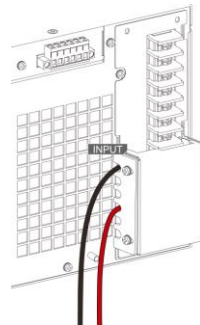

Press the *POWER* key. The welcome screen of GW Instek will be displayed followed by self-checking procedure before the continuous mode screen appears with the settings loaded.

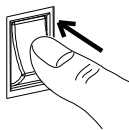

**! CAUTION**

- The power supply takes around 35 seconds to fully turn on and shutdown.
- Do not turn the power on and off quickly, otherwise the unit will be damaged due to insufficient time for self-checking procedure. It is recommended to observe an interval of at least 10 seconds between power on and off.

## How to Use the Instrument

### Background

The ASR-6000 AC power supplies generally use the *scroll wheel*, *Arrow keys*, *Numerical Keypad* and *Enter* keys to edit numerical values or to select menu options.

Menu navigation is performed using the menu keys and function keys on the front panel.

The following section will explain some of these concepts in detail.

### Selecting Menu Items

1. Turn the scroll wheel to select parameters in menus and lists. The selected parameter will be highlighted in orange. The scroll wheel is also used to increase/decrease setting values.

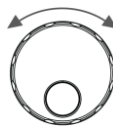

Press the *Enter* key to edit the parameter or to enter the selected menu.



### Example

The following is an example of the menu list that appears when the Menu key is pressed.

### Selected parameter

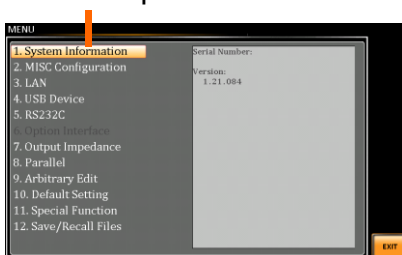

Using the Arrow Keys and Scroll Wheel to Edit Parameter Values

Use the *Arrow* keys to select a digit power and then use the scroll wheel to edit the value by that power.

1. Use the *Arrow* keys to move the cursor to the digit of the desired value.



Turn the scroll wheel to edit the value by the resolution of the selected digit.

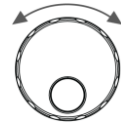

Repeat the steps above for all the relevant digits.

Press the *Enter* key to confirm the edit.



Note

By default the cursor starts at the lowest digit of value.

Using the Function Keys

The function keys are quick settings keys, the function of which depends on the current menu or operation.

1. Press the *Function* key that corresponds to the setting directly to its left side.

The setting or parameter is immediately executed.

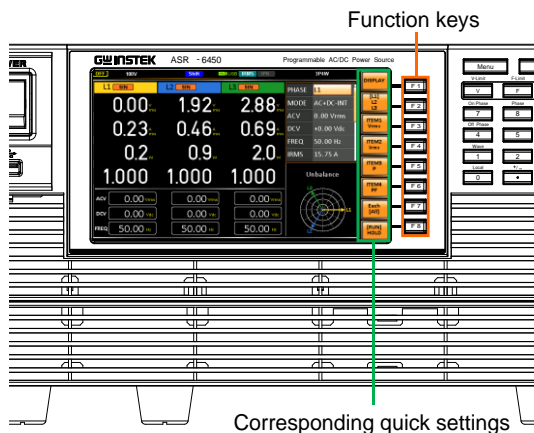

Repeat the steps above for all the relevant digits.

Numerical Keypad to Edit Parameter Values

Use the *Arrow* keys to select a digit power and the *Numerical keypad* to define a power value.

Use the *Arrow* keys to move the cursor to the digit of desired value.



Press the *Numerical keys* to input the value by the resolution of the selected digit.



Repeat the steps above for all the relevant digits.

Press the *Enter* key to confirm the edit.



**Note**

By default the cursor starts at the lowest digit of value.

## Input Terminal Connection

**Background** Basically, the input terminal, which is located in the rear panel of unit, can be connected through 3 methods: Single Phase, Delta and Y Connection. Depending on varied input connections, use the corresponding cooper plates and power cords for connection. Refer to the following chapters for details of each connection.

### Input Power Cord Cross Section Recommendation

Input Type	L1		L2		L3		N		PE
	$\phi$	I <sub>max</sub>	$\phi$	I <sub>max</sub>	$\phi$	I <sub>max</sub>	$\phi$	I <sub>max</sub>	$\phi$
<b>Single Phase</b>	$\geq 5.0$ mm <sup>2</sup> (10 AWG)	40 A	---	---	---	---	$\geq 5.0$ mm <sup>2</sup> (10 AWG)	40 A	$\geq 5.0$ mm <sup>2</sup> (10 AWG)
<b>Three-phase Y</b>	$\geq 2.0$ mm <sup>2</sup> (14 AWG)	13 A	$\geq 2.0$ mm <sup>2</sup> (14 AWG)	13 A	$\geq 2.0$ mm <sup>2</sup> (14 AWG)	13 A	$\geq 2.0$ mm <sup>2</sup> (14 AWG)	13 A	$\geq 2.0$ mm <sup>2</sup> (14 AWG)
<b>Three-phase Delta</b>	$\geq 3.0$ mm <sup>2</sup> (12 AWG)	22.5 A	$\geq 3.0$ mm <sup>2</sup> (12 AWG)	22.5 A	$\geq 3.0$ mm <sup>2</sup> (12 AWG)	22.5 A	---	---	$\geq 3.0$ mm <sup>2</sup> (12 AWG)

### Copper Plate Introduce

Voltage Range of Input Connections	Input Connection	Voltage Range
	Single	Single Phase 200 - 240V: L, N and G
	Delta	Three Phase 200 - 240V: L1, L2, L3 and G
	Y	Three Phase 200 - 240V: L1, L2, L3, N and G

Copper Plate Description	Copper Plate	Description
	62SR-6K0CP101	Copper plate for delta connection input
	62SR-6K0CP201	Copper plate for single phase and Y connection input
	62SR-6K0CP301	Copper plate for delta connection input

Copper Plate Quantity of Input Connections	Input Connection	Quantity of Copper Plate
	Single	62SR-6K0CP201*2pcs
	Delta	62SR-6K0CP101*1pcs, 62SR-6K0CP301*2pcs
	Y	62SR-6K0CP201*1pcs

Single Phase Connection

Steps

Assemble the two copper plates specific for Single phase input connection with the AC input terminals. The first plate is for L1, L2 and L3 terminals, while the other plate is for N1, N2 and N3 terminals.

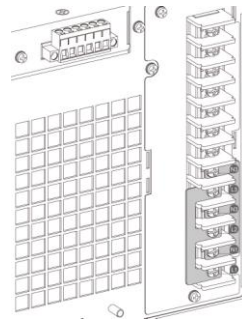

Note

In terms of the specific copper plates for Single Phase input connection, refer to page 46 for more details.

Connect the AC power cords to the AC input terminals.

- Red → Line (L)
- Black → Neutral (N)

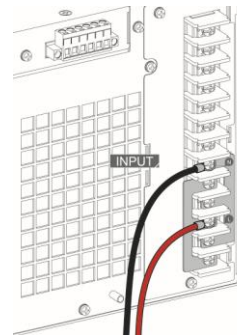

Install the protective lid of power input terminals (main box x1 and side plate x1) followed by fastening the three screws to fix the lid firmly into place.

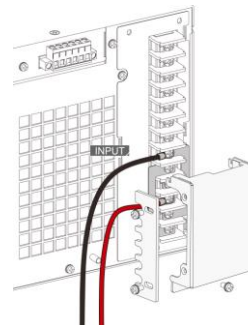

The AC power cords of Single phase input are connected with the AC input terminals equipped with protective lid completely.

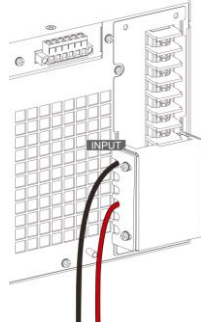

Note

- Power input cords are not included in this product.
- The input & output terminals necessitate connectivity through ring-type connectors.

### Delta Connection

Steps

1. Assemble the three copper plates specific for Delta input connection with the AC input terminals. The 1<sup>st</sup> plate is for N3 and L1 terminals. The 2<sup>nd</sup> second plate is for L3 and N2 terminals, while the 3<sup>rd</sup> plate is for L2 and N1 terminals.

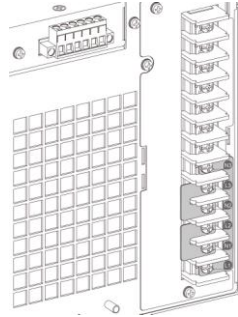

Note

In terms of the specific copper plates for Delta input connection, refer to page 46 for more details.



Connect the AC power cords to the AC input terminals.

- Red → Line (N2)
- Green → Neutral (N1)
- Yellow → Neutral (N3)

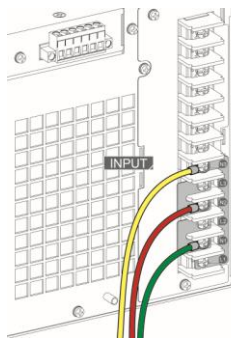

Install the protective lid of power input terminals (main box x1 and side plate x1) followed by fastening the three screws to fix the lid firmly into place.

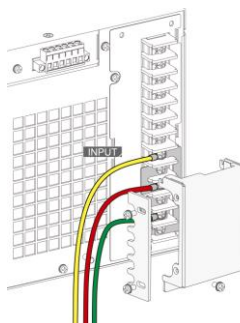

The AC power cords of Delta input are connected with the AC input terminals equipped with protective lid completely.

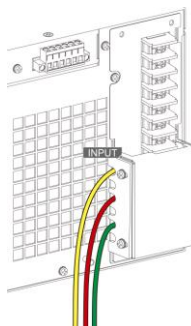

- Power input cords are not included in this product.
- The input & output terminals necessitate connectivity through ring-type connectors.

## Y Connection

### Steps

1. Assemble the copper plate specific for Y input connection with the AC input terminals. The copper plate is for N1, N2 and N3 terminals.

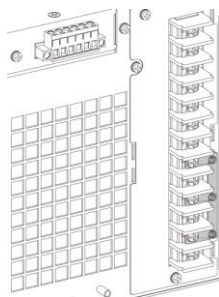

### Note

In terms of the specific copper plates for Y input connection, refer to page 46 for more details.

Connect the AC power cords to the AC input terminals.

- Red → L3
- Green → L2
- Yellow → L1
- Blue → Neutral

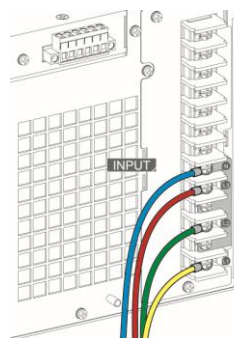

Install the protective lid of power input terminals (main box x1 and side plate x1) followed by fastening the three screws to fix the lid firmly into place.

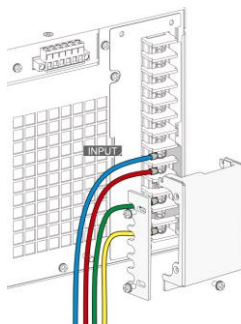

The AC power cords of Y input are connected with the AC input terminals equipped with protective lid completely.

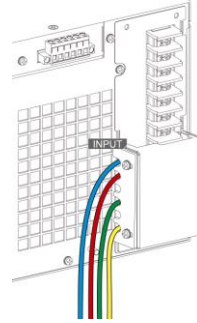

---

 Note

- Power input cords are not included in this product.
- The input & output terminals necessitate connectivity through ring-type connectors.

---

 WARNING

The diagram is only for reference on wiring method. Please proceed to wiring in accordance with the color definitions in your local country.

---

## Output Terminal Connection

**Background** The output terminal can output power in three mode: 1P2W, 1P3W and 3P4W. Select applicable output mode, via panel configurations, in accordance with varied applications.



**WARNING**

Be aware of dangerous voltages. Ensure that the power to the instrument is disabled before handling the power supply output terminals. Failing to do so may lead to electric shock.



**CAUTION**

After configuring phase settings via the front panel, please make sure the cords connection on the rear panel is corresponding to the set configuration.

## 1P2W Output Connection

- Steps**
1. Disconnect the unit from the mains power socket and turn the power switch off.
  2. Assemble the two copper plates specific for 1P2W output connection with the AC output terminals. The first plate is for N\*3 terminals, while the other plate is for L\*3 terminals.

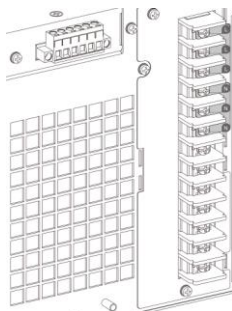

Connect the output wires to the AC output terminals as follows:

- Red → Line (L)
- Black → Neutral (N)

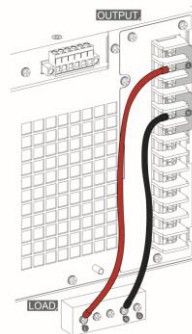

Install the protective lid of power output terminals (main box x1 and side plate x1) followed by fastening the 4 screws to fix the lid firmly into place.

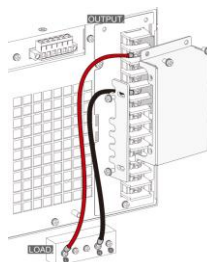

The AC power cords of 1P2W output are connected with the AC output terminals equipped with protective lid completely.

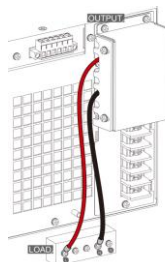

 Note

- The input & output terminals necessitate connectivity through ring-type connectors.
- Grounded Neutral Output for 1P2W output only: ASR-6000 allows for a grounded return on the neutral output. It is suit for the medical industry that required between ground with neutral is 0 V essentially. And possible to mitigate ground loops that is ideal for reduce ground noise and isolate sensitive equipment from the effects of ground loops.

**WARNING**

Because the neutral has been referenced to the chassis ground, be careful electric shock by yourself.

## 1P3W Output Connection

### Steps

1. Disconnect the unit from the mains power socket and turn the power switch off.

Connect the output wires to the AC output terminals as follows:

- Yellow → Line (L1)
- Green → Line (L2)
- Blue → Neutral (N)

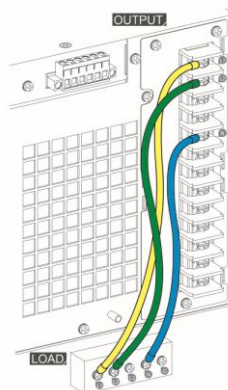

Install the protective lid of power output terminals (main box x1 and side plate x1) followed by fastening the 4 screws to fix the lid firmly into place.

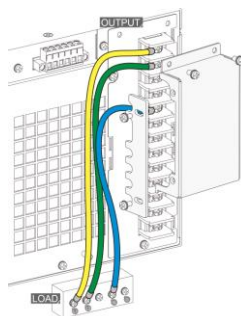

The AC power cords of 1P3W output are connected with the AC output terminals equipped with protective lid completely.

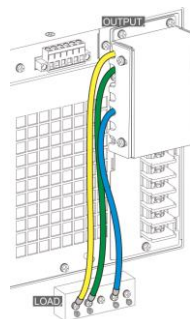

Note

- The input & output terminals necessitate connectivity through ring-type connectors.

### 3P4W Output Connection

#### Steps

1. Disconnect the unit from the mains power socket and turn the power switch off.

Connect the output wires to the AC output terminals as follows:

- Yellow → Line (L1)
- Green → Line (L2)
- Red → Line (L3)
- Blue → Neutral (N)

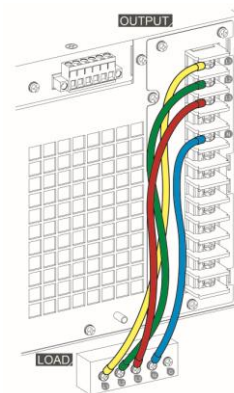

Install the protective lid of power output terminals (main box x1 and side plate x1) followed by fastening the 4 screws to fix the lid firmly into place.

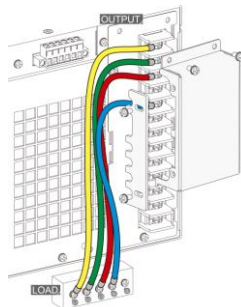

The AC power cords of 3P4W output are connected with the AC output terminals equipped with protective lid completely.

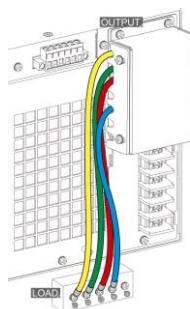

 Note

- The input & output terminals necessitate connectivity through ring-type connectors.

 WARNING

The diagram is only for reference on wiring method. Please proceed to wiring in accordance with the color definitions in your local country.



## Remote Sensing Connection

---

### Background

Remote sense is used to compensate for the voltage drop seen across load cables due to resistance inherent in the load cables. The remote sense function can compensate a maximum of 5% of the output voltage and all of output frequency. Based on different 3 output methods, the connections of remote sense vary accordingly. Refer to the following chapters of remote sense connections for each power output method.



### WARNING

Dangerous voltages. Ensure that the power to the instrument is disabled before handling the power supply output terminals. Failing to do so may lead to electric shock.



### Note

To minimize noise pickup or radiation, the load wires and remote sense wires should be twisted-pairs of the shortest possible length. Shielding of the sense leads may be necessary in high noise environments. Where shielding is used, connect the shield to the chassis via the rear panel ground screw. Even if noise is not a concern, the load and remote sense wires should be twisted-pairs to reduce coupling, which might impact the stability of the power supply. The sense leads should be separated from the power leads.

## 1P2W Output Remote Sensing Connection

---

Steps of 1P2W  
Output Remote  
Sensing  
Connection

1. Configure the setting of remote sense to ON (page 168).
  2. Connect the L1 terminal of the remote sense terminal block to the L terminal of the load.
  3. Connect the N1 terminal of the remote sense terminal block to the N terminal of the load.
- 

Remote Sense  
Connection  
Diagram for  
1P2W Output

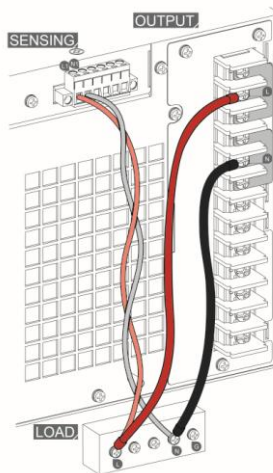

Install the  
Protective lid

4. After connection, cover the protective lid onto the remote sensing terminal block followed by fastening the screws as figure shown.

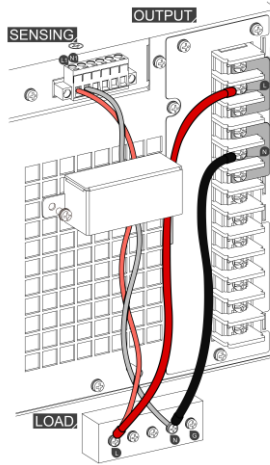

5. The remote sense connection and the protective lid installation are completed accordingly.

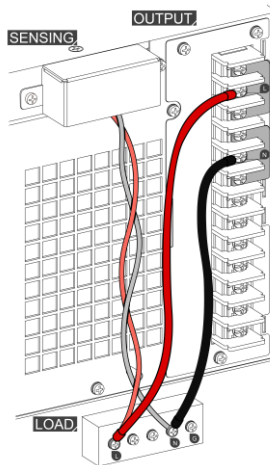

## 1P3W Output Remote Sensing Connection

Steps of 1P3W  
Output Remote  
Sensing  
Connection

1. Configure the setting of remote sense to ON (page 168).
2. Connect the L1 terminal of the remote sense terminal block to the L1 terminal of the load.
3. Connect the L2 terminal of the remote sense terminal block to the L2 terminal of the load.
4. Connect the N2 terminal of the remote sense terminal block to the N terminal of the load.
5. Short-circuit the N1 terminal and the N2 terminal of the remote sense terminal block.

Remote Sense  
Connection  
Diagram for  
1P3W Output

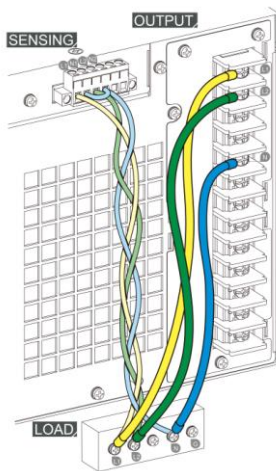

Install the  
Protective lid

6. After connection, cover the protective lid onto the remote sensing terminal block followed by fastening the screws as figure shown.

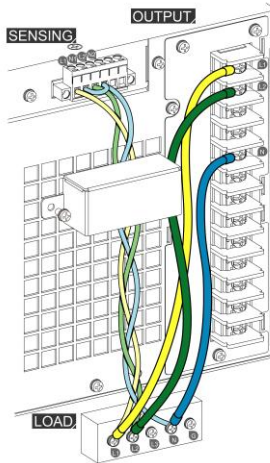

7. The remote sense connection and the protective lid installation are completed accordingly.

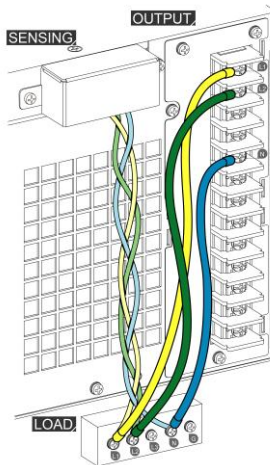

### 3P4W Output Remote Sensing Connection

---

Steps of 3P4W Output Remote Sensing Connection

1. Configure the setting of remote sense to ON (page 168).
2. Connect the L1 terminal of the remote sense terminal block to the L1 terminal of the load.
3. Connect the L2 terminal of the remote sense terminal block to the L2 terminal of the load.
4. Connect the L3 terminal of the remote sense terminal block to the L3 terminal of the load.
5. Connect the N3 terminal of the remote sense terminal block to the N terminal of the load.
6. Short-circuit the N1 terminal and the N2 terminal of the remote sense terminal block.
7. Short-circuit the N2 terminal and the N3 terminal of the remote sense terminal block.

Remote Sense Connection Diagram for 3P4W Output

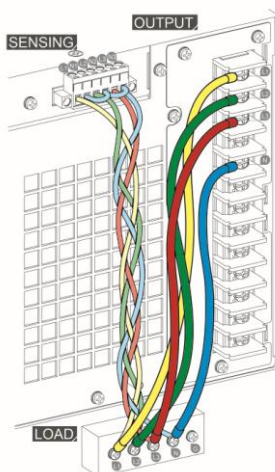

Install the  
Protective lid

- After connection, cover the protective lid onto the remote sensing terminal block followed by fastening the screws as figure shown.

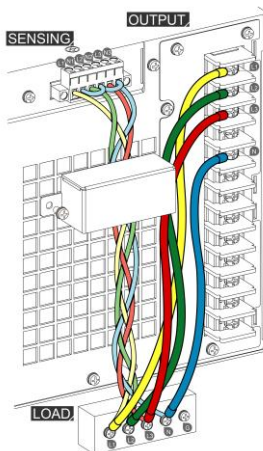

- The remote sense connection and the protective lid installation are completed accordingly.

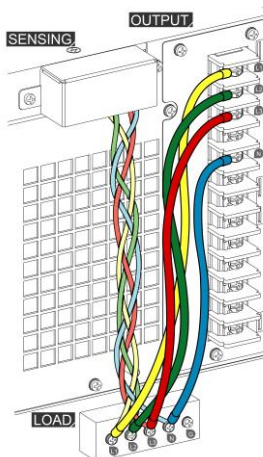

The diagram is only for reference on wiring method. Please proceed to wiring in accordance with the color definitions in your local country.

## Using the Rack Mount Kit

**Background** The ASR-6000 has the following optional Rack Mount kits, respectively.

Unit Model	Rack Mount kit part number
------------	----------------------------

ASR-6450	
----------	--

	GRA-451
--	---------

ASR-6600	
----------	--

The GRA-451-E is designed to fit into an EIA rack of 4U-height, while the GRA-451-J is designed to fit into a JIS rack of 4U-height. Please see your distributor for further rack mount details.

### GRA-451-E Series

GRA-451-E Rack Mount with ASR-6000 Diagram

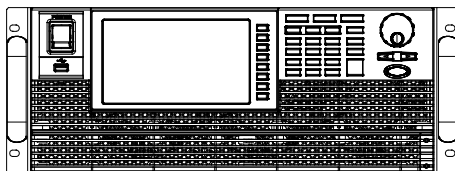

### GRA-451-J Series

GRA-451-J Rack Mount with ASR-6000 Diagram

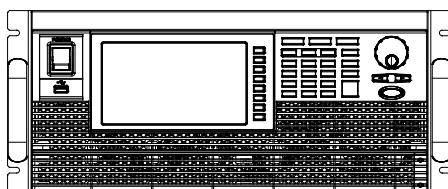

 **CAUTION**

Ensure adequate ventilation is provided when using the rack mount. Ensure that a gap is given for air intakes. Failure to do so may cause the instrument to overheat.



## Optional Interface Installation

**Background** There are up to 3 kinds of optional interface cards (DeviceNet, CAN BUS, GPIB) available to allow user to control ASR-6000 series remotely. Refer to the following steps for instructions of how to install interface cards into the slot from rear panel of the unit.

**Installation steps** 1. Before installation, power off the unit by pressing the *Power Switch*.

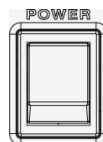

2. Discharge static electricity, if any, from body via contacting a metal parts, the grounded metal object, in the rear panel.
3. Loosen the screws of the blank card in the rear panel and remove the blank card along with the screws from the rear panel.

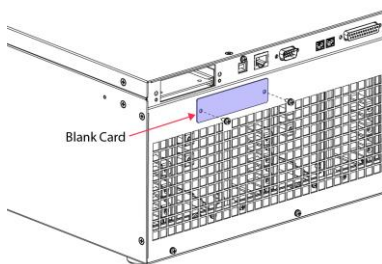

4. Insert an optional interface card (DeviceNet, CAN BUS, GPIB) into the slot of rear panel and click it all the way into place.

GPIB

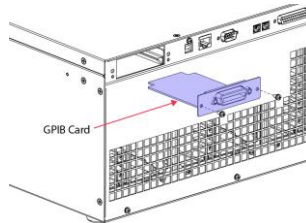

CAN BUS

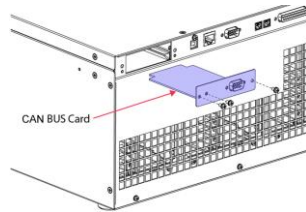

DeviceNet

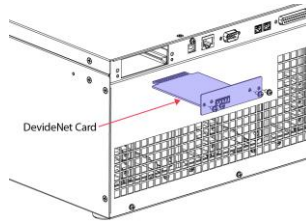

5. Fasten the screws to fix the optional interface card onto the rear panel of unit. The screws number varies per different interface card.

## Reset to Factory Default Settings

---

**Background** The default settings can be restored from the Menu key settings. See page 245 for the default factory settings.

---

**Steps**

1. Press the *Menu* key. The Menu settings will appear on the display.

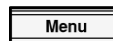

Use the scroll wheel to go to item 10, *Default Setting*.

Press *Enter* for 2 times to restore the unit back to the default settings.

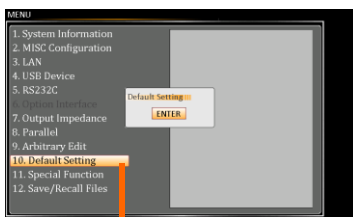

Default settings

## View Firmware Version and Serial Number

**Background** The Menu>System Information setting displays the serial number and firmware version.

**Steps** 1. Press the *Menu* key. The Menu setting will appear on the display.

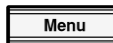

The system information should now be listed in the item 1, System Information, on the display

**Exit** Press *Exit*[F8] to exit from the Menu settings.



### System Information

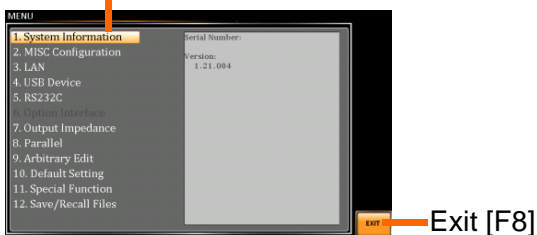

## USB Driver Installation

**Background** If the USB Type B interface is to be used for remote control, the USB driver needs to be installed.

 **Note** The USB driver, both gw\_asr.inf and gw\_asr.cat can be downloaded from the GW Instek website.

For information on the USB interface, see page 221.

**Steps** 1. Connect the rear panel USB-B port on the ASR-6000 to the PC using a USB Type A to B cable.

Go to the Windows Device Manager.

For Windows 10:  
**Start > Control Panel > Hardware and Sound > Device Manager**

 **Note** It is available for Windows 7 and Windows 10 and Windows 11.

The ASR-6000 will be located under *Other Devices* in the hardware tree. Right-click the ASR-6XXX and choose *Update Driver Software*.

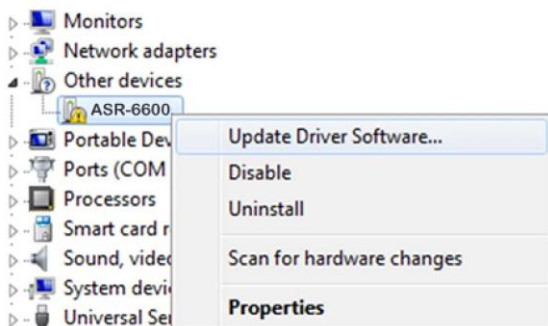

From the hardware wizard choose *Browse my computer driver software*.

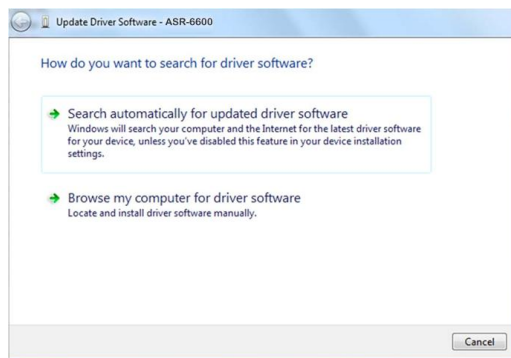

Set the file path to the location of the USB driver, click Next and finish the driver installation.



ASR-6000 will now be located in the *Ports* node of the hardware tree in the Windows Device Manager if the driver installation was successful.

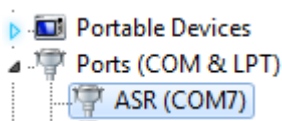

## Air Inlet Cleaning and Installation

**Background** The ASR-6000 is equipped with a cellular-like metal filter to prevent dust from infiltrating into the unit. In case of vent blockage, please clean the filter periodically by vacuum cleaner.

- Steps**
1. Loosen the 2 screws followed by removing the lid of air inlet in the lower-right corner of ASR-6000 unit.

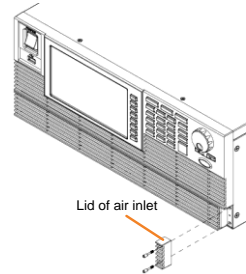

- Gently slide the cover of air inlet rightward.

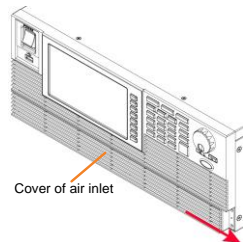

- Remove the cover of air inlet via pulling it out of ASR-6000 unit outward.

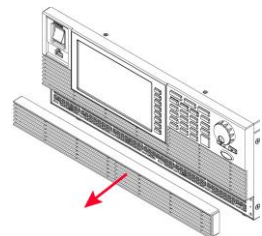

Use a vacuum cleaner to absorb and remove dust off from the air inlet.

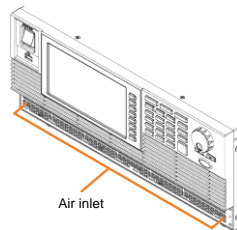

Follow the steps 1-3 in reversed order to reassemble the lid and the cover of air inlet with ASR-6000 unit.

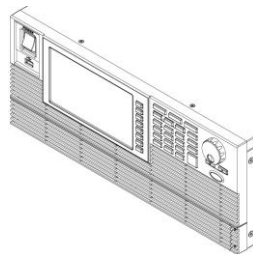

Note

Please clean regularly to avoid damaging the internal components of the machine

---



Warning

The above procedure should only be attempted by competent persons. Ensure the AC power cord is not connected to power before cleaning.



## Wire Gauge Considerations

**Background** Before connecting the output terminals to a load, the wire gauge of the cables should be considered.

It is essential that the current capacity of the load cables is adequate. The rating of the cables must equal or exceed the maximum current rated output of the instrument.

Recommended Wire Gauge	Wire Gauge	Nominal Cross Section	Maximum Current
	20	0.5	9
	18	0.75	11
	18	1	13
	16	1.5	18
	14	2.5	24
	12	4	34
	10	6	45
	8	10	64
	6	16	88
	4	25	120
	2	32	145
	1	50	190
	00	70	240
	000	95	290
	0000	120	340

The maximum temperature rise can only be 60 degrees above the ambient temperature. The ambient temperature must be less than 30 degrees.

## Menu Tree

**Convention** Use the menu trees as a handy reference for the power supply functions and properties. The ASR-6450 / ASR-6600 menu system is arranged in a hierarchical tree. Each hierarchical level, which is coated in varied colors, can be navigated through the orders within the diagrams below.

For example: To set the DHCP to OFF mode;

- ① Press the *Menu* key.
- ② Navigate to the LAN Configuration option.
- ③ Enter the DHCP option.
- ④ Select OFF.

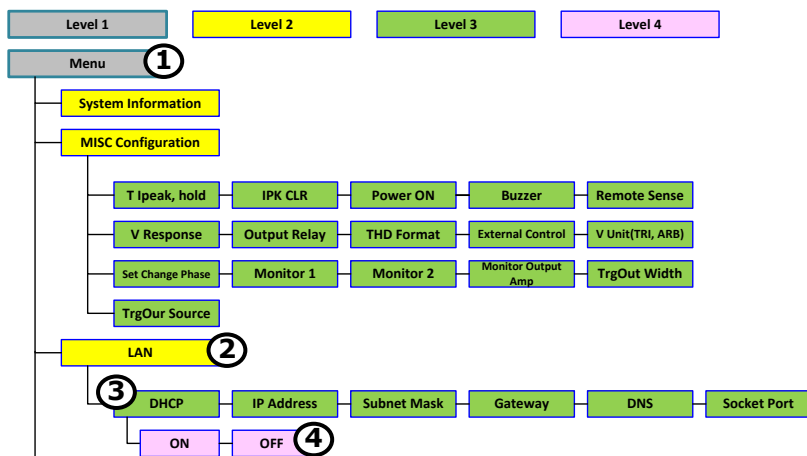

# Main – 1P2W

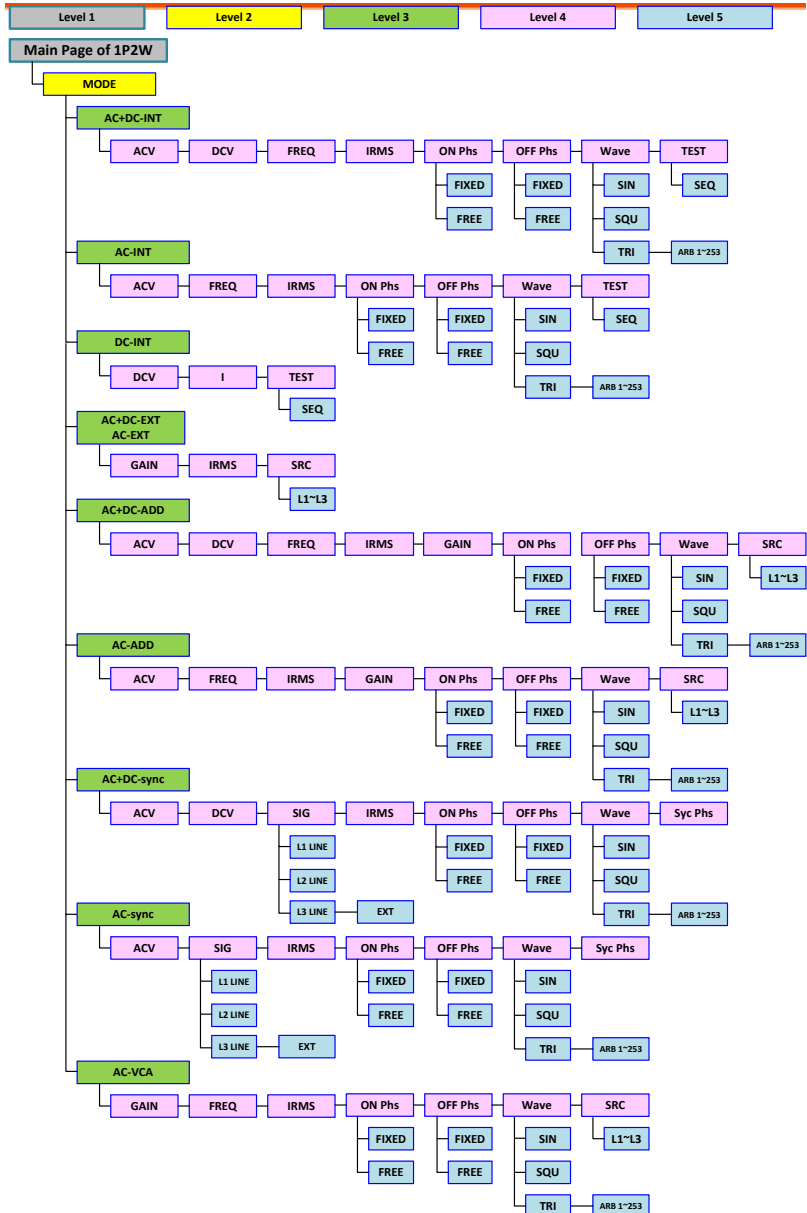

**Main – 1P3W & 3P4W**

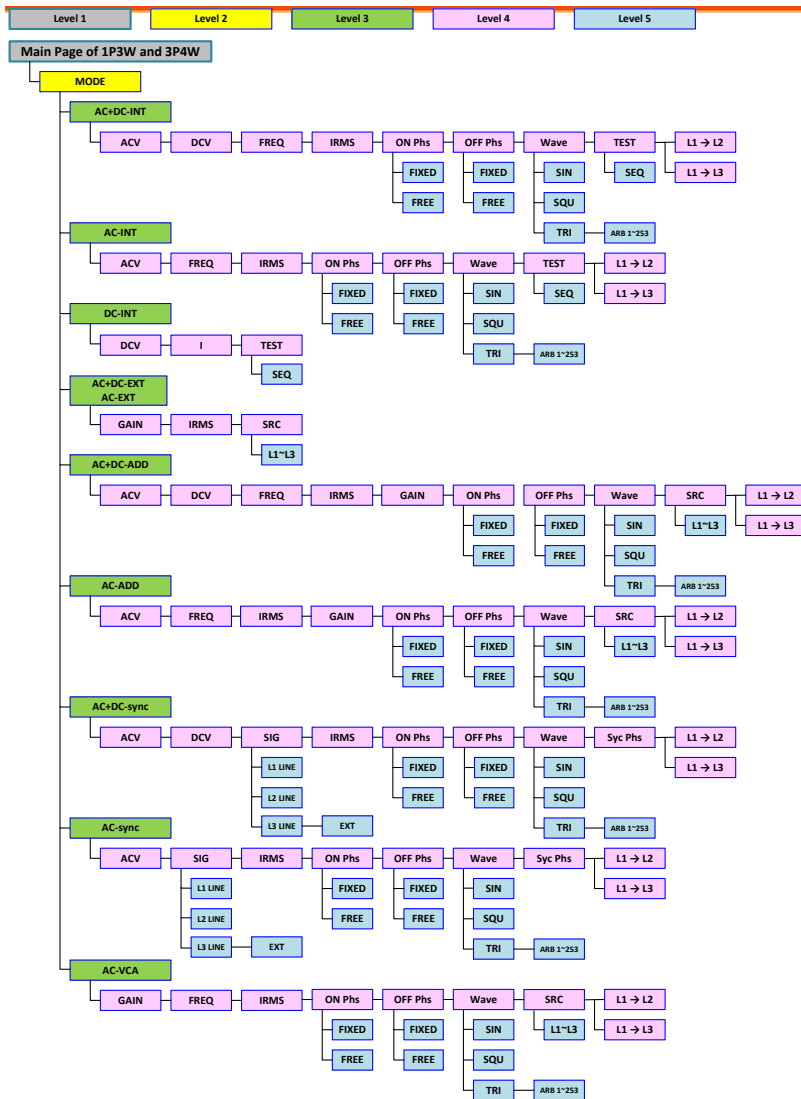

# Menu

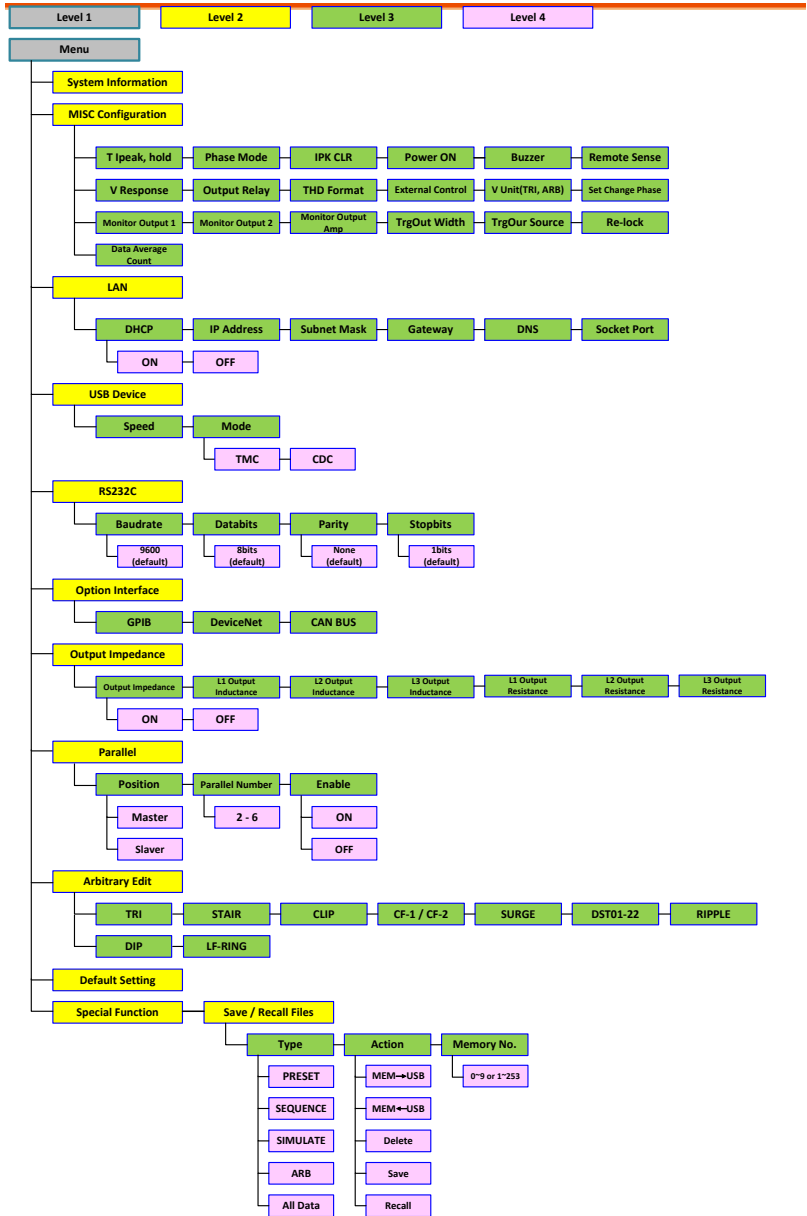

## Basic Operation

This section describes the basic operations required to operate the power supply.

- Select the Output Mode → from page 79
- Select the Output Phase → from page 82
- Select the Voltage Range → from page 82
- Select the Output Waveform → from page 84
- Setting the Output Voltage Limit → from page 86
- Setting the Output AC/DC Voltage & Gain → from page 88
- Setting the Frequency Limit → from page 90
- Setting the Output Frequency & Signal → from page 93
- Setting the Peak Current Limit → from page 95
- Setting the Output Current Level → from page 97
- Setting the Output On and Off Phase → page 99
- Setting the SRC → page 101
- Setting the Sync Phase → page 102
- Switch the Display Modes → from page 105
- Using the Measurement Function → from page 109
- Switch the Measurement Format → from page 112
- Panel Lock → from page 115
- Alarm Clear → from page 116
- Turning the Output On/Off → from page 117
- Hardcopy Function → from page 118
- Back to Local → from page 118

Before operating the power supply, please see the Getting Started chapter, page 9.

## Select the Output Mode

### Background

The ASR-6000 has up to 10 modes to output, which empower user to have multiple applications for different scenarios.

### List of the Selectable Combinations of the AC or DC Output Mode and the Signal Source

Output Phase	Output Mode	Signal Source				
		INT	EXT	ADD	Sync	VCA
1P	AC+DC C	AC+DC -INT	AC+DC -EXT	AC+DC -ADD	AC+DC -Sync	---
	AC	AC-INT	AC-EXT	AC- ADD	AC- Sync	AC- VCA
	DC	DC-INT	---	---	---	---
1P3W	AC+DC C	AC+DC -INT	AC+DC -EXT	AC+DC -ADD	AC+DC -Sync	---
	AC	AC-INT	AC-EXT	AC- ADD	AC- Sync	AC- VCA
	DC	DC-INT	---	---	---	---
3P	AC+DC C	AC+DC -INT	AC+DC -EXT	AC+DC -ADD	AC+DC -Sync	---
	AC	AC-INT	AC-EXT	AC- ADD	AC- Sync	AC- VCA
	DC	DC-INT	---	---	---	---

### List of the Output Mode

Mode	Description
AC+DC-INT	AC & DC Internal Output
AC-INT	AC Internal Output
DC-INT	DC Internal Output
AC+DC-EXT	AC & DC External Output
AC-EXT	AC External Output
AC+DC-ADD	AC & DC Additional Output
AC-ADD	AC Additional Output
AC+DC-Sync	AC & DC Synchronal Output
AC-Sync	AC Synchronal Output
AC-VCA	AC Voltage Control Amplifier Output

---

---

INT	The signal source is from internal. Set the output voltage, waveform, frequency, on phase and off phase through the control panel or the remote control.
EXT	The signal source is from external. Amplifies and outputs the external input signal. Set the voltage gain through the control panel or the remote control.
ADD	The signals are the total of the external and internal signal source. Set the voltage gain for the external input signal, the output voltage for the internal signal source, the output waveform, frequency, on phase and off phase through the control panel or the remote control.
Sync	The signal source is from internal. The output frequency is synchronized with the external TTL input signal or the power line. This frequency setting can't be set through the control panel or the remote control. All of setting conditions except for output frequency are as same as INT mode.
VCA	The output voltage can be controlled with the external DC 0~2.5V input signal via EXT I/O terminal. The output voltage setting can't be set through the panel or remote control. All conditions except for output voltage setting is same as INT mode.

---



Operation steps

1. Press *Shift + Range* to access the MODE selection menu.

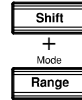

Alternatively, it is available to use scroll wheel followed by the Enter key to enter the MODE menu.



Choose an output mode with scroll wheel.

Press *Enter* to confirm the mode selection.

Example

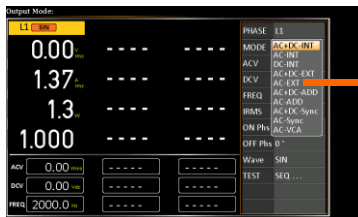

Mode menu

## Select the Output Phase

**Background** There are up to 3 Output Phase of ASR-6000 for user to utilize in different applications.

Output Phase	Description
1P2W (1P)	Single phase two wire output
1P3W	Single phase three wire output
3P4W (3P)	Three phase four wire output (default setting)

### Steps

1. Press **Shift + 8** keys or select from the MENU -> MISC Configuration -> Output Phase.
2. The prompt window appears. Use scroll wheel followed by the Enter key to confirm selection.

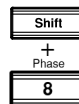

### Example - Shift + 8

Output Phase will be changed to selectable

Click Yes to confirm Output Phase change

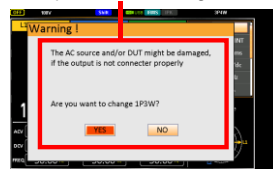

### Example - MISC Configuration

Output Phase selection under MISC Configuration

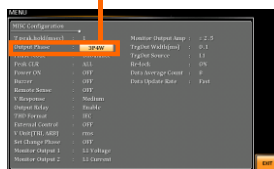

## Select the Voltage Range

**Background** The Range setting determines the general outlet voltage range. The ranges available correspond to common mains output voltage standards.

**Steps** 1. Press *Range* to access the Range menu. 

Set the voltage range with the F1, F3 and F4 soft-keys.

- |           |          |
|-----------|----------|
|           | F1: AUTO |
| Soft-keys | F3: 200V |
|           | F4: 100V |

Press *Enter* to confirm the Range setting.

**Example**

**Range setting**





Note

The output voltage values set by user can be divided into 2 manual settings, both of which have close relation with voltage range that contains high range (200V, AUTO) and low range (100V). For instance, when setting 5 Vrms under 200V range and 3 Vrms under 100V range, the Vrms setting will change from 5 Vrms to 3 Vrms directly after switching the voltage range from 200V to 100V.

Also, if the voltage range is changed when the output is on, the output will be automatically turned off.

## Select the Output Waveform

Background

The ASR-6000 is capable of outputting sine, square, triangle and ARB wave shapes while connecting with external signals.

List of the output waveforms

Waveform	Description
SIN	Sinusoid wave
SQU	Square wave
TRI	Triangle wave
ARB 1 ~ 253	Arbitrary wave 1 ~ 253



Note

For more details about Arbitrary waveforms, refer to the page 128

Steps

Press *Shift* + 1 to access the Wave menu.

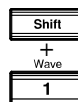

Alternatively, it is available to use scroll wheel followed by the Enter key to enter the Wave menu.



Press *Enter* to confirm the waveform setting.

Example

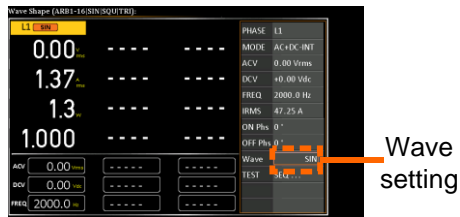

Note

- Waveform selection is Not available under DC-INT, AC+DC-EXT and AC-EXT output modes.
- When changing to a waveform with setting higher than the upper limit of other waveform, the setting of other waveform will be adjusted to zero forcibly.

## Setting the Output Voltage Limit

**Background**                      Setting the voltage limit allows the output voltage to be set to any level within the voltage limit range.

List of the Voltage Limit Value of the Output Modes	Output Mode	Limit Value		
		$V_{rms}$	$V_{pk+}$	$V_{pk-}$
	AC-INT	10% ~ 100%		
	AC-ADD	full range	---	---
	AC-Sync	voltage		
	AC+DC-INT			
	DC-INT	---	+ (4% ~ 100% full range	- (4% ~ 100% full range
	AC+DC-ADD		peak voltage)	peak voltage)
	AC+DC-Sync			

- Steps**
1. Press *Shift* + *V* to access the Volt Limit menu.
  2. Use the scroll wheel or the numerical keypad to set value of  $V_{rms}$ ,  $V_{PK+}$  and  $V_{PK-}$  limit directly or use the F3 (MAX) and F4 (MIN) soft-keys to set the limit to the maximum or minimum value.
  3. Press *Enter* to confirm the voltage limit setting.

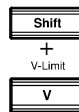

Example -  
Vrms Setting

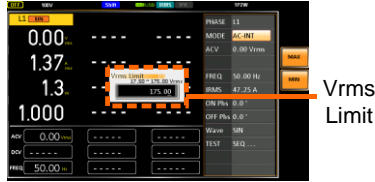

Example -  
VPK+ Setting

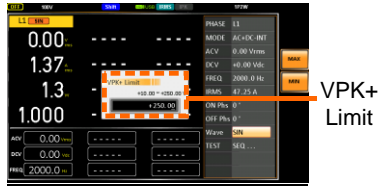

Example -  
VPK- Setting

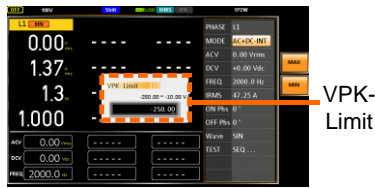

 Note

- Voltage limit setting is Not available for both AC+DC-EXT, AC-EXT and AC-VCA output modes.
- The Vrms Limit value defined by user will be generally applied to AC-INT, AC-ADD and AC-Sync modes under the same voltage range, which divides into 2 levels, high range including AUTO and 200V and low range covering 100V.
- Both the VPK+ and VPK- Limit values defined by user will be generally applied to AC+DC-INT, DC-INT, AC+DC-ADD and AC+DC-Sync modes under the same voltage range, which divides into 2 levels, high range including AUTO and 200V and low range covering 100V.
- The minimum voltage limit has relative connection with the voltage setting. That is, the voltage setting is never beyond the voltage limit.
- The range of voltage limit will be limited within the certain minimum value in accordance with the output voltage setting.

## Setting the Output AC/DC Voltage & Gain

**Background**                    The ACV, DCV and Gain settings set the output voltage level. Before setting the power supply voltage level, set the voltage range and voltage limit beforehand.

**List of the Voltage Range and Gain of the Output Modes**

Output Mode	Range		
	ACV	DCV	GAIN
AC+DC-INT AC+DC-Sync	0 volts ~ full range	0 volts ~ full range	---
AC-INT AC-Sync	0 volts ~ full range	---	---
DC-INT	---	0 volts ~ full range	---
AC+DC-ADD	0 volts ~ full range	0 volts ~ full range	0 times ~ full range
AC-ADD	0 volts ~ full range	---	0 times ~ full range
AC+DC-EXT AC-EXT AC-VCA	---	---	0 times ~ full range

**Steps**

1. Press the V key. The ACV, DCV and GAIN parameters will be selectable.



Also, it is available to use the scroll wheel followed by the Enter key to make the parameter selectable as well.





Use the scroll wheel or the numerical keypad to set value of ACV/DCV/GAIN value directly or use the define value, *F3 (MAX)* and *F4 (MIN)* soft-keys to set the limit to the maximum or minimum value.

Press *Enter* to confirm voltage or gain setting.

---

#### Defined Settings

The DEF1 and DEF2 settings are user-defined settings. By default they are set to 0.0 and 100.0 volts (100V range), 200.0 volts (200V and AUTO range), respectively and 100 and 200 times for gain. The MAX and MIN soft-keys set voltage or gain parameters to the maximum or minimum value, respectively.

Repeat the previous steps 1 ~ 2 to set AC/DC voltage and gain value with the scroll wheel.

Press and hold either the *DEF1* or *DEF2* soft-key until "Saved to DEF1/2" is displayed, which indicates the voltage and gain settings are saved to the DEF1 or DEF2 soft-key individually.

---



#### Note

- When under DC-INT, Vkey is to enter to make DCV parameter selectable directly.
  - When under AC-ADD, Vkey is to enter to make GAIN parameter selectable directly.
  - Trying to set the voltage outside of the voltage limit/range will result in a voltage setting error being displayed on the screen.
  - ACV, DCV and GAIN settings under each output mode and range have their own DEF1 and DEF2 saved values, respectively.
-

ACV setting    Defined setting

Example of ACV Setting in the AC+DC-INT

DCV setting    Defined setting

Example of DCV Setting in the DC-INT

GAIN setting    Defined setting

Example of GAIN Setting in the AC+DC-EXT

- Note

1. Vrms can only be set up to 144.3 Vrms / 288.6 Vrms for triangular waveform.
  2. Go to Menu -> MISC -> V Unit to select the voltage set value unit.

## Setting the Frequency Limit

### Background

Setting the frequency limit allows the frequency output to be set to any level within the limit range.

List of the Frequency Limit Value of the Output Modes

Output Mode	Range	
	Freq Hi Limit	Freq Lo Limit
AC+DC-INT AC+DC-ADD	1.00 ~ 2000.0 Hz	1.00 ~ 2000.0 Hz
AC-INT AC-ADD AC-VCA	15.00 ~ 2000.0 Hz	15.00 ~ 2000.0 Hz



Note

Frequency limit setting is Not available under DC-INT, AC+DC-EXT, AC-EXT, AC+DC-Sync and AC-Sync output modes.

Steps

1. Press *Shift* + *F* to access the Freq Limit menu.

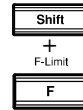

Use the scroll wheel to toggle between Freq Hi (upper) and Freq Lo (lower) settings followed by pressing *Enter* to get into the parameter.

Set the frequency limit with the scroll wheel or the numerical keypad or with the F3 ~ F4 soft-keys. The MAX and MIN soft-keys set the frequency limit to the maximum and minimum, respectively.

Press *Enter* to confirm the limit setting.

Example -  
Freq Hi Setting in  
AC+DC-INT



Example -  
Freq Lo Setting in  
AC+DC-INT



Note

- Before change freq limit setting, if FREQ setting value is bigger than desire freq limit value, the freq limit value cannot be change accordingly.
- The range of frequency limit will be limited within the certain minimum value in accordance with the output frequency setting.

## Setting the Output Frequency & Signal

**Background**                      The **FREQ** and **SIG** settings set the frequency of the output. Before setting the frequency, set the frequency limit.

**List of the Frequency Range and Signal of the Output Modes**

Output Mode	Range	Option
	FREQ	SIG
AC+DC-INT AC+DC-ADD	1.00 ~ 2000.0 Hz	---
AC-INT AC-ADD AC-VCA	15.00 ~ 2000.0 Hz	---
AC+DC-Sync AC-Sync	---	L1 LINE / L2 LINE L3 LINE / EXT

**Steps**

1. Press the *F* key to access the **FREQ** or **SIG** parameter depending on varied modes.



Also, it is available to use the scroll wheel followed by the **Enter** key to make the **FREQ** or **SIG** parameter selectable as well.



2. Set the frequency or signal with the scroll wheel, the numerical keypad or with the **F1 ~ F4** soft-keys.
3. Press *Enter* key to confirm the frequency or signal setting.

**Defined Settings**

The **DEF1** and **DEF2** settings are user defined settings. By default they are set to 50.00 Hz and 60.00 Hz, respectively. The **MAX** and **MIN** soft-keys set the frequency to the maximum and minimum, respectively.

4. Repeat the previous steps 1 ~ 2 to set frequency with the scroll wheel.
5. Press and hold the *DEF1* or *DEF2* soft-key until "Saved to DEF1/2" is displayed. This will save the frequency setting to the DEF1 or DEF2 soft-key individually.

Example -  
Frequency Setting  
in the AC+DC-  
INT

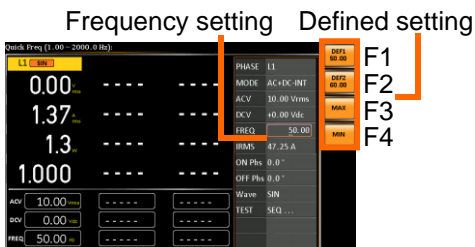

Example -  
Signal Setting  
in the AC+DC-Sync

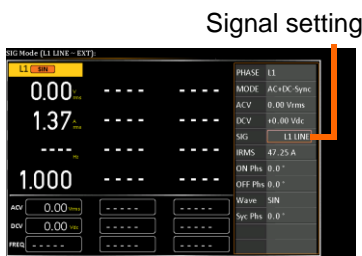

**Note**

- Trying to set the frequency outside of the frequency limit will result in a frequency setting error being displayed on the screen.
- FREQ setting under each output mode has its own DEF1 and DEF2 saved values, respectively.
- Frequency setting is Not available under DC-INT, AC+DC-EXT and AC-EXT output modes.
- When SIG is set LINE, this function is used for adjusting sync phase of output waveform and phase of power grid.
- When SIG is set EXT, this function is used for adjusting sync phase of output waveform and phase of external input signal.

## Setting the Peak Current Limit

**Background**                      Setting the peak current limit sets a limit on the current that can be sourced by the power supply. Once the output current over the setting, the output will set to off.

 **Note**                      When the peak current limit is tripped, an alarm will sound. Press *Shift + 9* to clear the IpK alarm.

**List of the Peak Current Limit Value of the Output Modes**

Output Mode	Range	
	IPK+	IPK-
AC+DC-INT		
AC-INT		
DC-INT		
AC+DC-EXT		
AC-EXT	50 ~ 105% of rate peak current	-105 ~ -50% of rate peak current
AC+DC-ADD		
AC-ADD		
AC+DC-Sync		
AC-Sync		
AC-VCA		

**IPK Limit On/Off**                      In theory, It is the function which keeps the IPK limits (+ & -) within the certain range when the predefined values are reached. If, however, this function is turned off, the output will be disabled instantly when either IPK+ or IPK- limit is reached.

**Steps**

1. Press *Shift + Irms* to access the IPK Limit menu.

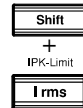

2. Use the scroll wheel to toggle between IPK+ (upper) and IPK- (lower) settings followed by pressing *Enter* to get into parameter, respectively.

3. Set the peak current (IPK+ & IPK-) with the scroll wheel, the numerical keypad or with the F3 (MAX) and F4 (MIN) soft-keys to set the current limit to the maximum and minimum values, respectively.
4. Press Enter to confirm the peak current setting.

Example -  
IPK+ Limit  
Setting in the  
AC+DC-INT

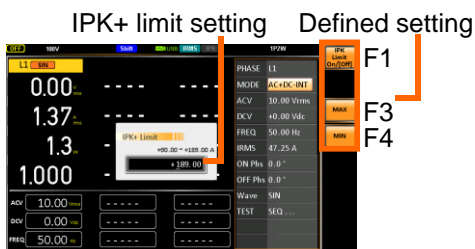

Example -  
IPK- Limit Setting  
in the AC+DC-  
INT

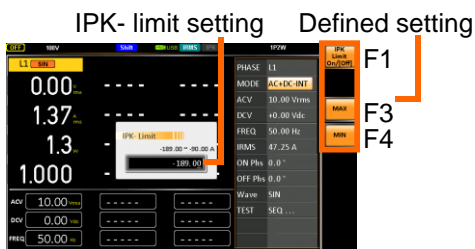

Note

IPK Limit is set ON by default.



## Setting the Output Current Level

**Background**                      The IRMS and I settings set the current of the output. Setting the RMS or AVG current sets a limit on the current that can be sourced by the power supply. Once the output current is over the setting, the output will set to off.

**List of the Current Level of the Output Modes**

Output Mode	Range	
	Irms	I
AC+DC-INT		
AC-INT		
AC+DC-EXT		
AC-EXT		
AC+DC-ADD	5 ~ 105% of rate current	---
AC-ADD		
AC+DC-Sync		
AC-Sync		
AC-VCA		
DC-INT	---	5 ~ 105% of rate current

**IRMS & I Limit On/Off**

Almost identical with the concept of previous IPK Limit function, the IRMS/I Limit function keeps the IRMS/I value within the certain limit when the predefined value is reached. If, on the other hand, this function is turned off, the output will be disabled instantly when IRMS/I Limit off level is reached.

**Steps**

1. Press *Irms* to access the IRMS or I menu depending on varied modes.



Also, it is available to use the scroll wheel followed by the Enter key to make the IRMS or I parameter selectable as well.



2. Set the IRMS/I level with the scroll wheel, the numerical keypad or with the F3 ~ F4 soft-keys. The MAX and MIN soft-keys set the IRMS or I level to the maximum and minimum, respectively.
3. Press *Enter* to confirm the current setting.

Example -  
IRMS Setting in  
the AC+DC-INT

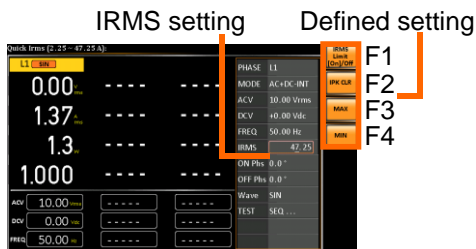

Example -  
I Setting in the  
DC-INT



 **Note**

IRMS Limit is set ON by default. The IRMS minimum value will not be less than 2.25A (ASR-6450) and 3A (ASR-6600).

## Setting the Output On and Off Phase

**Background** The on and off phase setting sets the starting and ending phase of the voltage output.

**List of the ON Phase and OFF Phase Range of the Output Modes**

Output Mode	Range	
	ON Phs	OFF Phs
AC+DC-INT		
AC-INT		
AC+DC-ADD		
AC-ADD	0.0° ~ 359.9°	0.0° ~ 359.9°
AC+DC-Sync		
AC-Sync		
AC-VCA		

**FIXED & FREE Modes** Pressing the F1 key to toggle between modes of **FIXED**, which indicates the user-defined on-phase degree, or **FREE**, which represents the degree of on-phase is freely determined by the unit itself. When **FREE** is selected, the both F3-MAX and F4-MIN keys are grayed out, signaling the unavailability by user.

**Steps**

1. Press *Shift* + 7 and *Shift* + 4 individually to make the ON and OFF Phs parameter selectable.

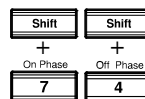

Also, it is available to use the scroll wheel followed by the Enter key to make the parameter selectable as well.



2. Set the *ON* and *OFF Phs* setting with the scroll wheel or the numerical keypad or with the F3 (MAX) and F4 (MIN) soft-keys to set the maximum and minimum values, respectively.

3. Press *Enter* to confirm the setting.

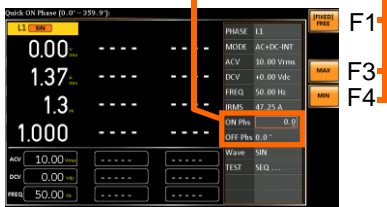

Example -  
Phase Setting in  
the AC+DC-INT

On and Off Phase Setting    Soft-keys setting



## Setting the SRC

**Background** The acronym SRC stands for Source, which corresponds to pins 20, 21, and 22 of the System I/O on the back panel, allowing user to choose the signal source from which pin.

- Steps**
1. Use the scroll wheel followed by the *Enter* key to make the SRC parameter selectable.   

  2. Set the SRC setting with the scroll wheel to set the values. 
  3. Press *Enter* to confirm the setting.

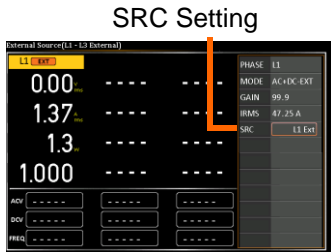
**Example - SRC Setting in the AC+DC-EXT**





 **Note**

SRC setting is Not available under AC+DC-INT, AC-INT, DC-INT, AC+DC-Sync and AC-Sync output modes.

## Setting the Sync Phase

	Output Mode	Range
List of the Syn Phs setting	AC+DC-Sync AC-Sync	0.0° ~ 359.9°

### Steps

1. Use the scroll wheel followed by the Enter key to make the Syn Phs parameter selectable.  
2. Set the *Syn Phs* setting with the scroll wheel or with the F3 (MAX) and F4 (MIN) soft-keys to set the Sync Phase to the maximum and minimum values, respectively.
3. Press *Enter* to confirm the Sync Phase setting.

Example -  
Sync Phase  
Setting in the  
AC+DC-Sync

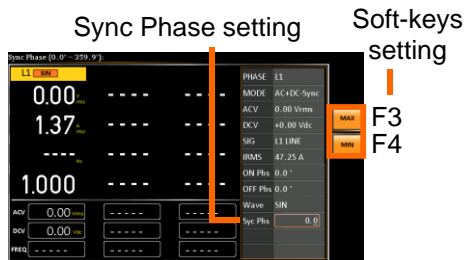

The actual waveform -  
 ACV: 100 Vrms,  
 DCV: 100Vdc,  
 Syn Phs: 0°,  
 Output On

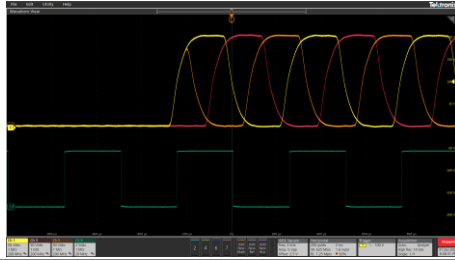

The actual waveform -  
 ACV: 100 Vrms,  
 DCV: 100Vdc,  
 Syn Phs: 0°,  
 Steady State

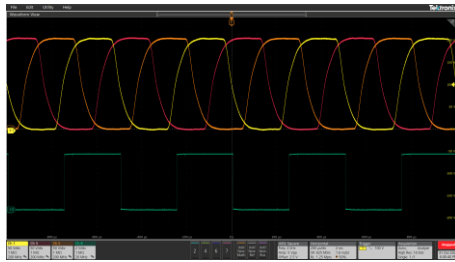

The actual waveform -  
 ACV: 100 Vrms,  
 DCV: 100Vdc,  
 Syn Phs: 0°,  
 Output Off

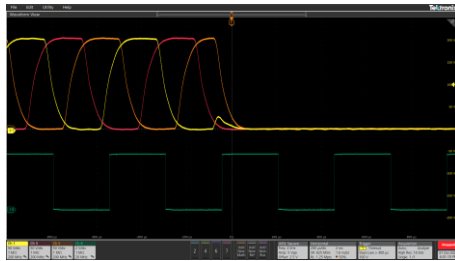

The actual waveform -  
ACV: 100 Vrms,  
DCV: 100Vdc,  
Syn Phs: 120°,  
Output On

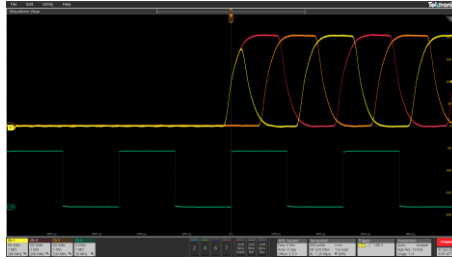

The actual waveform -  
ACV: 100 Vrms,  
DCV: 100Vdc,  
Syn Phs: 120°,  
Steady State

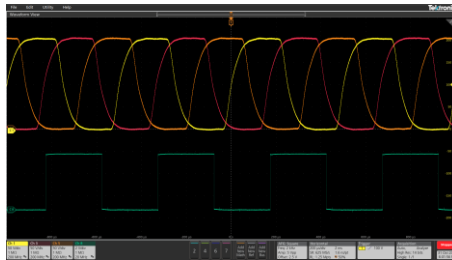

The actual waveform -  
ACV: 100 Vrms,  
DCV: 100Vdc,  
Syn Phs: 120°,  
Output Off

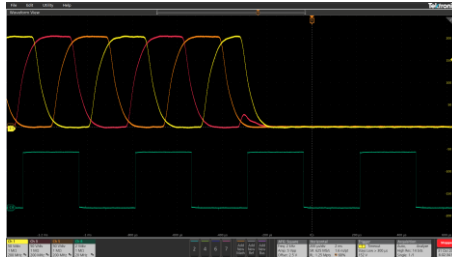

Note

It is available for AC+DC-Sync and AC-Sync Mode output modes only.



## Switch the Display Modes

The ASR-6000 power supply has three display modes: standard, simple and harmonic modes.

The standard display mode shows the power supply setup in the Setting section and the 4 configurable measurements in the Configurable section that corresponds to the left side real-time Measurement section. In addition, when it's under 1P3W or 3P4W output, the phase degree is editable (L1-L2 for 1P3W, L1-L2 and L1-L3 for 3P4W). The simple display mode shows all measurement items available on the ASR-6000 with 3 measurement formats switchable at any time. The harmonic display mode shows both harmonic voltage and harmonic current relevant measurements for user.

### Steps

1. Press the *F1(DISPLAY)* key, which corresponds to display functions.
2. The display mode will toggle each time when the key is pressed besides locked mode.



### Standard Mode - 1P2W

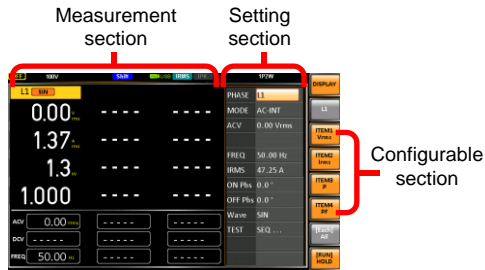

### Standard Mode - 1P3W

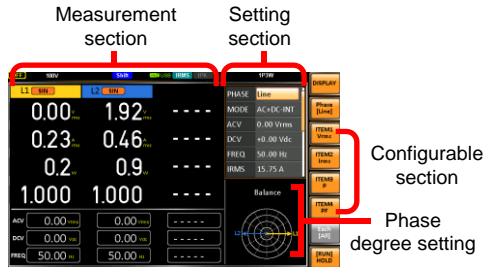

Standard Mode - 3P4W

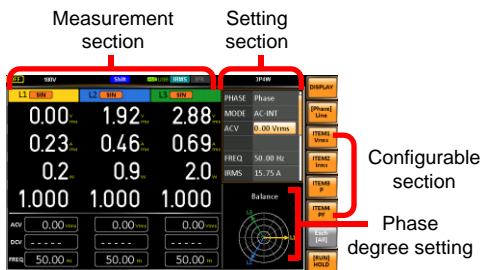

Configuring the Standard mode measurements

1. Press the *F3*(ITEM1), *F4*(ITEM2), *F5*(ITEM3) or *F6*(ITEM4) soft-key to enter each menu.



2. Use the scroll wheel to select a measurement item and press *Enter* to confirm. Refer to page 109 for more details of measurement parameters.

 Note

When pressing the *F1*(DISPLAY) key under 1P3W and 3P4W output modes, it will switch to the display of total measurement value message within the lower-left corner first. It is required to press the *F7* key twice to switch from the standard mode to simple mode under 1P3W or 3P4W output.

Simple Mode

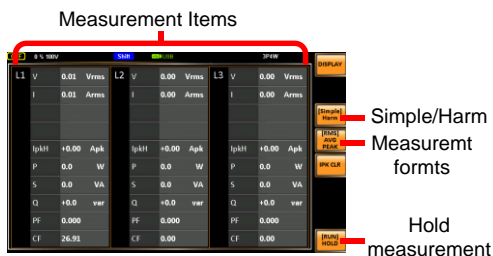

Configuring the Simple mode measurements

1. Press the *F4* (RMS/AVG/PEAK) soft-key to toggle among each mode of format.



2. The display will show parameters of measurement for each format. Refer to the page 112 for details.

Harmonic Mode

Measurement Items

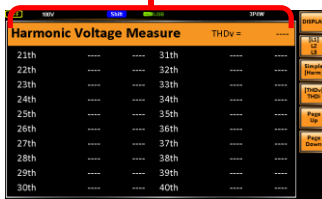

- Phase switch
- Simple/Harm
- THDv/THDi
- Page Up
- Page Down

Configuring the Harmonic mode measurements

1. First switch to the Simple mode followed by pressing the *F3* (Simple/Harm) soft-key to enter the Harm display mode.



2. Pressing the *F2* (L1/L2/L3) soft-key to select phase of output measurement.



- 1P2W - L1
- 1P3W - L1/L2
- 3P4W - L1/L2/L3

3. Pressing the *F4* (THDv/THDi) soft-key to toggle between Total Harmonic Distortion Volt (THDv) and Total Harmonic Distortion Current (THDi) measurements.



 Note

Harmonic mode is available for AC-INT mode and 50/60Hz output frequency. SIN, SQU, TRI and ARB 1 - 253 waveforms are also available.

- 
4. When the measurements are beyond one page, which consists of up to 20 items, press the *F5* (Page Up) and *F6* (Page Down) soft-keys to flip through pages.
- 

A rectangular orange button with a black border containing the text "Page Up" in black.A rectangular orange button with a black border containing the text "Page Down" in black.

Hold  
Measurement

Press the soft-key *F8* to toggle hold on or off. This function will “hold” the current measurements on the display, which means the measurements won’t be updated until the function is released.

---

A rectangular orange button with a black border containing the text "[RUN] HOLD" in black.

Note

Hold measurement is available for the Standard and Simple display modes only.

---

## Using the Measurement Function

The 4 configurable measurements, which indicate the live-time measurement in varied units, on the far-right side within the standard display mode can be switched by user anytime in the process of power output, thus providing an instantaneous analysis.

List of the Measurement Available Items of the Output Modes

Items	Output Modes			
	AC+DC-INT AC+DC-EXT AC-EXT AC+DC-ADD AC-ADD AC-VCA	AC-INT	DC-INT	AC+DC-Sync AC-Sync
$V_{rms} / V_{avg} /$ $V_{max} / V_{min} /$ VLL rms/ VLL avg/ VLL max/ VLL min	✓	✓	✓	✓
$I_{rms} / I_{avg} /$ $I_{max} / I_{min}$	✓	✓	✓	✓
$V_{pkH} / I_{pkH}$	✓	✓	✓	✓
P	✓	✓	✓	✓
S/Q	✓	✓	X	✓
PF/CF	✓	✓	X	✓
THD <sub>v</sub> / THD <sub>i</sub>	X	✓	X	X
Freq	X	X	X	✓

List of the Measurement Items

Item	Description
Vrms	Root Mean Square Voltage
Vavg	Average Voltage
Vmax	Maximum Peak Value of Output Voltage

---

Vmin	Minimum Peak Value of Output Voltage
VLL rms	Root Mean Square Line to Line Voltage
VLL avg	Average Line to Line Voltage
VLL max	Maximum Peak Value of Output Line to Line Voltage
VLL min	Minimum Peak Value of Output Line to Line Voltage
VpkH	Peak Voltage Hold
Irms	Root Mean Square Current
Iavg	Average Current
Imax	Maximum Peak Value of Output Current
Imin	Minimum Peak Value of Output Current
IpkH	Peak Current Hold
P	Real Power
S	Apparent Power
Q	Reactive Power
PF	Power Factor
CF	Crest Factor
THDv	Total Harmonic Distortion Voltage
THDi	Total Harmonic Distortion Current
Freq	Frequency

---

Steps

1. Under the standard display mode, press the *F3(ITEM1)*, *F4(ITEM2)*, *F5(ITEM3)* or *F6(ITEM4)* soft-key to enter each menu.

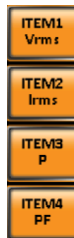

2. Use the scroll wheel to select a measurement item and press *Enter* to confirm.

---

3. Press *Enter* to confirm the measurement item setting.

---

Example of  
ITEM1 in AC-INT



ITEM1  
options









Each output mode has varied measurement functions display.

---

## Setting the Phase and Line Voltage

The phase and line voltage settings are available for either 1P3W and 3P4W output modes, and also the Balance phase mode enabled only.

- |       |  |  |
|-------|--|--|
| Steps | <ol style="list-style-type: none"> <li>1. Press the <i>Menu</i> key to enter the MISC section, and select “Balance” for Phase Mode.</li> <li>2. Press the <i>F8 (EXIT)</i> soft-key to exit from Menu.</li> <li>3. Use the scroll wheel followed by the Enter key to make the PHASE parameter selectable.</li> <li>4. Select the Phase or the Line voltage setting with the scroll wheel.</li> <li>5. Press Enter to confirm the setting.</li> </ol> | <br><br><br><br><br><br><br><br><br> |
|-------|--|--|

 **Note**

- Before utilizing this configuration feature, it is essential to switch the Phase Mode in the MISC section to Balance.
- With the Balance mode enabled, the Line Voltage setting is available for SIN waveform output only, whereas the Phase Voltage setting is available for all waveforms output.

**Example**







**Phase and Line Voltage**

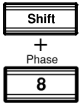

### Select the Each and All Setting Method

This function is exclusively applicable to the condition when 3P4W output mode, Unbalance setting and DC-INT, AC+DC-Ext, AC-EXT, AC+DC-Add, AC-ADD modes under balance are activated. When “Each” is adopted, user can swiftly configure values of L1, L2 and L3 individually. On the other hand, while “All” is selected, user concurrently configure values of L1/L2/L3, thus changing the L1, L2 and L3 values in unison at the same time.

- |       |   |   |
|-------|---|---|
| Steps | <ol style="list-style-type: none"> <li>1. Press <i>Shift</i> + 8 keys.</li> </ol>   |    |
|       | <ol style="list-style-type: none"> <li>2. The prompt window appears. Select 3P4W output mode followed by pressing <i>Enter</i> to confirm setting.</li> </ol> |    |
|       | <ol style="list-style-type: none"> <li>3. Press the <i>Menu</i> key to enter the MISC section, and select “Unbalance” for Phase Mode.</li> </ol>              |    |
|       | <ol style="list-style-type: none"> <li>4. Press the <i>F8</i> (EXIT) soft-key to exit from Menu.</li> </ol>   |   |
|       | <ol style="list-style-type: none"> <li>5. Press the <i>F7</i>(<i>Each, All</i>) soft-key to toggle between Each and All setting.</li> </ol>                   |  |

### Example



Each and All setting

## Switch the Measurement Format

The 3 measuring formats, RMS, AVG as well as PEAK, on the far-right side within the simple display mode can be switched by user anytime in the process of power output, thus offering an instant readout of diversified calculations.

### Steps

1. Press the *F1(DISPLAY)* key to switch to the Simple display mode.
2. Press the *F4 (RMS/AVG/PEAK)* soft-key to toggle among each mode of format.



Option	Description
RMS	Root Mean Square Voltage
AVG	Average Voltage
PEAK	Peak Value

### Example of F4 key in Simple mode

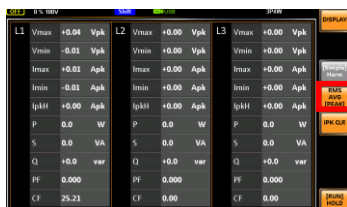

F4 key options



### Note

The selected measurement format will be merely shown in the Simple display mode, for which refer to page 106 for further details.

### Panel Lock

The panel lock feature prevents settings from being changed accidentally. When activated, all keys and knobs except the Lock/Unlock key and the Output key (if active) will be disabled.

If the instrument is remotely controlled via the USB/LAN/RS-232/GPIN/CAN BUS/DeviceNet interface, the panel lock is automatically enabled. See page 219 for remote control details.

Activate the Panel Lock

Press the *Lock* key to activate the panel lock. The “Keys Locked” message appears on the display.

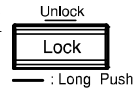

A lock icon will appear in the upper-right corner when the panel keys are locked.



Disable the Panel Lock

Hold the *Lock* key for 5 seconds to disable the panel lock. “Keys Unlocked” will appear on the display and the lock icon will disappear.

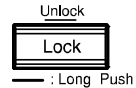

Example

Message Lock icon



## Alarm Clear

**Background** The ALM CLR (Alarm Clear) function will clear alarms like Over Current, Over Peak Current, Over Power Protect, Output Short, Sensing Voltage Error, among others. Refer to page 249 for more details.

- Steps**
1. Press *Shift* + 6 to clear any alarms.
- 

**Example**

**ALM indicator**



Alarm message

## Turning the Output On/Off

---

**WARNING**

Please ensure that the wiring method of the output terminals on the rear panel matches the phase setting before proceeding with the output execution. See page 45 for details about using the output terminals.

---

**WARNING**

When the unit is under the condition of output Off, it Does Not indicate the ASR unit not pose risk of electrical shock. The output terminal still poses risky voltage and thus may cause damage to personnel. Hence, Do Not judge if operation voltage is safe or not simply by status of Output On or Off.

---

**Turn Output On**

Press the *Output* key. The Output key will light up in orange and ON will be displayed in the status bar to indicate that the output is on.

**Turn Output Off**

Press the *Output* key. The Output key light will go out and OFF will be displayed in the status bar to indicate that the output is off.



## Hardcopy



Note

Please confirm the detection of the USB disk before utilizing this function. If the USB disk is not detected, an error message will be displayed accordingly.

Steps

1. Press *Shift* + 3 to hardcopy the screen.

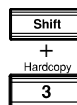

Example



Hardcopy message

## Local

Background

When utilizing interfaces such as USB Device, RS232, LAN, GPIB, DeviceNet, and CAN BUS, the system will automatically enter the connection mode. To restore back to the standard mode during the connection mode status, please adhere to the following actions.

Steps

1. Press *Shift* + 0 to back to the local mode.

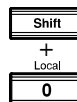

## Advanced Settings

- Using the Remote Sense Function → from page 119
- Square Wave Signal Duty Ratio Adjustable → from page 120
- Preset Settings → from page 121
- Edit Arbitrary Waveform → from page 128
- External Keypad Operation → from page 145
- Output Impedance Setting → from page 146
- External Parallel Operation → from page 148

### Using the Remote Sense Function

---

The ASR-6000 can be operated using local or remote voltage sense. By default, the power supply is configured for local sense.

---



#### WARNING

- Ensure the output is off before handling the remote sense connectors.
  - Use sense cables with a voltage rating exceeding the isolation voltage of the power supply.
  - Never connect sensing cables when the output is on. Electric shock or damage to the power supply could result.
- 

### Local Sense

---

#### Local Sense Operation

When using local sense, the remote sensing input terminal is not used. No compensation of any possible voltage drop seen on the load cables is performed. Local sense is only recommended when the voltage drop is of no consequence. By default, the power supply is configured for local sense.

1. Check that the remote sense setting is disabled (page 168).

## Remote Sense

**Remote Sense Operation** Remote sense is used to compensate for the voltage drop seen across load cables due to resistance inherent in the load cables. The remote sense function can compensate a maximum of 5% of the output voltage and all of output frequency.

1. Configure the remote sense setting to ON (page 168).

## Square Wave Signal Duty Ratio Adjustable

**Background** Using the Duty Ratio setting to set the square wave duty ratio. User can specify the ratio when the output waveform is set to SQU.

**Setting Range of the Duty Ratio**

Frequency	Range	Resolution	Default Value
$f < 100 \text{ Hz}$	0.1 ~ 99.9 %	0.1%	
$100 \text{ Hz} \leq f < 1 \text{ kHz}$	1 ~ 99 %	1%	50%
$1 \text{ kHz} \leq f < 2 \text{ kHz}$	10 ~ 90 %	10%	

**Diagram**

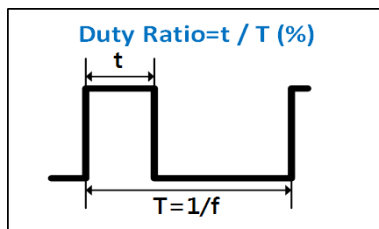



## Preset Settings

### Save Preset Settings to Local Memory

Up to 10 preset settings (M0 – M9) can be saved to the internal memory shared by both output mode and output phase.

For example, when saving preset setting to M0 for 3P4W mode, and also saving the other preset setting to M1 for 1P2W mode, user loads the M0 preset setting under the 1P2W mode, the output mode will be switched to 3P4W automatically.

#### Steps

1. Press *Preset* key followed by clicking with holding on the F1 ~ F8 soft-keys individually to save the present settings to the corresponding memory number.



Presets M0 ~ M7

Also, it is viable to press and hold the numerical keypad for the corresponding memory number.

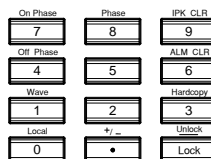

Numerical Keypad 0 ~ 9 (M0 ~ M9)

In addition, it is available to press the Menu key followed by selecting M0 ~ M9 from the Save/Recall Files page.

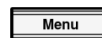

Memory No. 0 ~ 9 (M0 ~ M9)

2. Press the *Preset* key again to exit from the preset mode.

Example                      For example, pressing *Preset* & holding *F1* will save the present settings to memory slot 0 (saved to M0).

---



Note

- There are overall 10 groups of memory number for preset setting (M0 ~ M9). Only M0 ~ M7 are available in soft-keys, whereas the rest groups M8 ~ M9 can be saved from either the *Save/Recall Files* utility under Menu system or press and hold the numerical keypad. Refer to page 125 for more details.
  - The preset key will be lit green when active. A beep will be heard (Buzzer is set to ON) and a message will displayed when the settings are saved.
-

## Load Preset Settings to Local Memory

Any of the 10 preset settings can be recalled from internal memory.

### Steps

1. Press *Preset* followed by clicking on the F1 ~ F8 soft-keys individually to load the corresponding memory number.



Presets M0 ~ M7

Also, it is viable to press and hold the numerical keypad for the corresponding memory number.



Numerical Keypad 0 ~ 9 (M0 ~ M9)

In addition, it is available to press the Menu key followed by selecting M0 ~ M9 from the Save/Recall Files page.

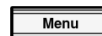

Memory No. 0 ~ 9 (M0 ~ M9)

2. Press the *Preset* key again to exit from the preset mode.

### Example

For example, pressing *Preset* + F1 will recall the saved settings from memory slot 1 (recalled from M0).



## Note

- There are overall 10 groups of memory number for preset setting (M0 ~ M9). Only M0 ~ M7 are available in soft-keys, whereas the rest groups M8 ~ M9 can be recalled from either the *Save/Recall Files* utility under Menu system or press and hold the numerical keypad. Refer to page 125 for more details.
  - The preset key will be lit green when active. A beep will be heard (Buzzer is set to ON) and a message will displayed when the settings are recalled.
-

## Manage Preset Settings

Preset settings can be easily saved to or recalled from a USB flash drive using the Save/Recall Files utility in the Menu system. Settings can also be deleted (Recalled Default) from local memory using the utility.

---

File Format	<p>When files are saved to USB they are saved in the following format: PresetX.Set, where X is the memory number M0 ~ M9. The files are saved to USB:/gw.</p> <p>When files are recalled from USB, files must be recalled from the same memory number. For example, the file Preset0.set can only be recalled to memory number M0. The files can only be recalled from the USB:/gw directory.</p>
-------------	---

---

Steps	<ol style="list-style-type: none"> <li>1. Press the <i>Menu</i> key. The Menu settings will appear on the display. </li> <li>2. Use the scroll wheel to go to item 12, <i>Save/Recall Files</i> and press <i>Enter</i>.</li> <li>3. Go to the <i>Type</i> setting using the scroll wheel and press <i>Enter</i>. Select <i>Preset</i> and press <i>Enter</i> to confirm.</li> <li>4. Go to the <i>Action</i> setting and choose the file operation and then press <i>Enter</i>.</li> </ol>
-------	---

---

MEM→USB	Saves the selected preset memory from the local memory to a USB flash drive.
---------	--

---

MEM←USB	Loads a preset memory from a USB flash drive to the selected local memory.
---------	--

---

Delete	Deleted (Recalled Default) the selected preset memory from local memory.
--------	--

---

Save	Saves the selected preset memory to local memory.
Recall	Recalls the selected preset memory from local memory.

- Go to the *Memory No.* setting and select the preset memory number to perform the operation on. Press *Enter* to confirm.

Memory No.	0 ~ 9 (M0 ~ M9)
------------	-----------------

Execute File Operation

- Press *EXE[F1]* to perform the selected file operation.



Exit

- Press *EXIT[F8]* to exit from the *Save/Recall Files* settings.



Example

Load file from USB to Local memory

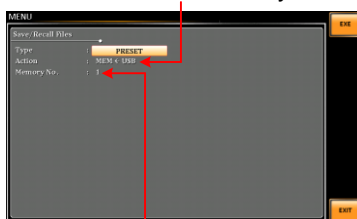

Memory No. 1 selected

All Data Operation

- Go back to the *Type* setting using the scroll wheel and press *Enter*. Select *All Data* and press *Enter* to confirm.
- Go to the *Action* setting and choose the file operation and then press *Enter*.

MEM→USB	Saves all the files including Preset, Sequence, Simulate and ARB from the local memory to a USB flash drive.
---------	--

---

MEM←USB	Loads all the files including Preset, Sequence, Simulate and ARB from a USB flash drive to the local memory.
Delete	Deletes all the files including Preset, Sequence, Simulate and ARB from local memory.

---

Example

All Data option selected



Save all data from  
Local memory to USB

---

## Edit Arbitrary Waveform

**Background**      The arbitrary waveform editing function is to select built-in arbitrary waveforms. There are a number of built-in waveform shapes to choose from, each of which can be customized with varied attributes. Finally, choose an ARB NO. (1~253) to output the selected built-in waveform.

- Steps**
1. Press the *Menu* key. The Menu setting will appear on the display. 
  2. Use the scroll wheel to go to item 9, *Arbitrary Edit* and press *Enter* to enter the Arbitrary Edit page.

Built-in Waveform	TRI, STAIR, CLIP, CF-1, CF-2, SURGE, DST01-22, RIPPLE, DIP, LF-RING
-------------------	---

3. Use the scroll wheel and *Enter* key to select waveform along with pertaining attributes and press *Save* to confirm settings.

### Setting Screen Overview



Visual representation of the waveform shape and its attributes

Attributes for the selected waveform

### ARB Waveform Overview

The following describes each of the built-in waveforms.



TRI The triangle waveform has a settable number of percentage.

Attributes:

Sym: 0 ~ 100%

ARB NO: 1 ~ 253

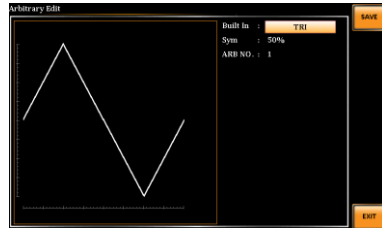

STAIR The staircase waveform has a settable number of step levels.

Attributes:

Stairs: 1 ~ 100

ARB NO: 1 ~ 253

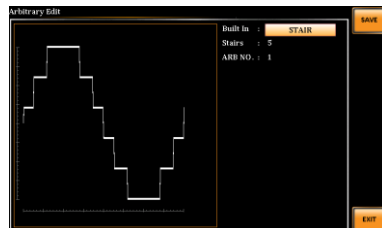

**CLIP** Outputs a clipped sinewave. The degree to which the sine wave is clipped is settable.

Attributes:  
Ratio: 0.00 ~ 1.00  
ARB NO: 1 ~ 253



**CF-1** Crest factor (CF-1) waveform. The crest factor is settable.

Attributes:  
CF: 1.1 ~ 10.0  
ARB NO: 1 ~ 253

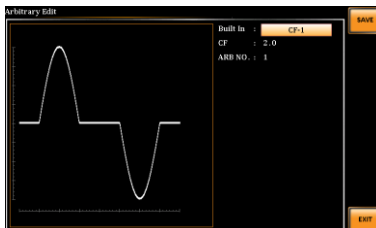

CF-2 Crest factor (CF-2) waveform. The crest factor is settable.

Attributes:

CF: 1.5 ~ 2.0

ARB NO: 1 ~ 253

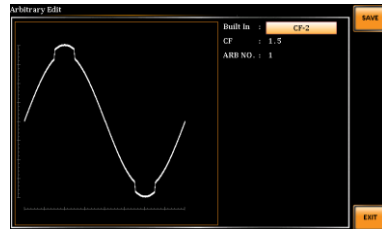

SURGE The surge waveform has a settable ACV base level, site size and site shape.

Attributes:

Type: SQU, SIN (site waveform type)

ACV: 0 ~ 100% (base waveform ampl.)

Site: 0 ~ 100% (site waveform width)

ARB NO: 1 ~ 253



**DST01-22** The DST01-22 waveform shape function simply adds a number Fourier series terms to create an arbitrary waveform.

Attributes:

Type: 1 ~ 22 (Number of selectable ARB waveforms)

ARB NO: 1 ~ 253

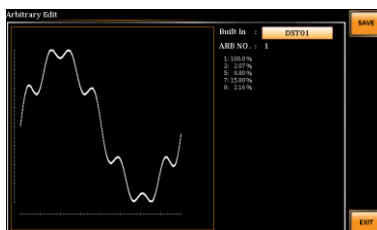

**RIPPLE** The RIPPLE waveform shape function has a settable DC ripple attributes.

Attributes:

Times: 1/2/3/6

VDC: 1~100

Level: 1%~30%

ARB NO: 1 ~ 253



DIP The DIP waveform refers to a transient reduction in RMS voltage, also known as Voltage Dip or “Drop In Point”. Refer to following for the suggested range.

Attributes:

ST Phs:0.1~53.9

SP Phs:45.1~171.9

End Phs: 54.1~359.9

ARB NO: 1~253

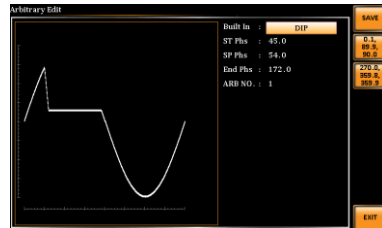

**LF-RING** The LF-RING waveform shape function is used to simulate a low-frequency and sinusoidal waveform, which is smooth, continuous and resembles a shape of ring.

Attributes:

ACV: 0.0~350.0Vrms

Amp: 140~200%

Base\_Freq: 50.0~200.0Hz

Ring\_Freq: 200.0~5000.0Hz

Decay: -0.100~0.100

ST Phs: 0.1~120.1

End Phs: 60.1~359.9

Ring Phs: 0.1~359.9

ARB NO: 1~253

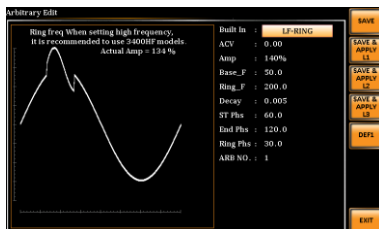

Save

4. Press *Save*[F1] to save the Arbitrary Edit settings.



Exit

5. Press *Exit*[F4] to exit from the Arbitrary Edit settings.



## Compiling Arbitrary Waveform Input

---

Output Arbitrary  
Waveform on  
ASR-6000

1. Press *Shift* + *1* to access the Wave menu.

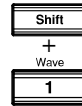

Alternatively, it is available to use scroll wheel followed by the *Enter* key to enter the Wave menu.



2. Choose one of the ARB waveforms (ARB 1 to ARB 253) with scroll wheel.

Default Waveform Setting

ARB 1 Ramp (rising)

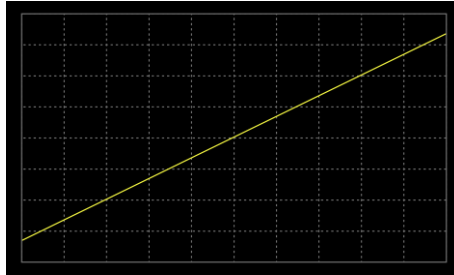

ARB 2 Ramp (falling)

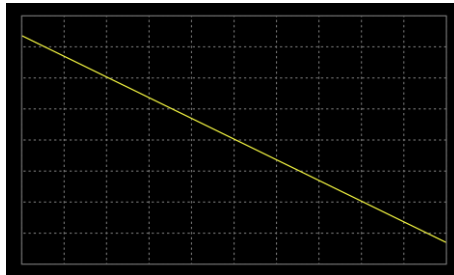

ARB 3 Sine wave, half-cycle(positive pole)

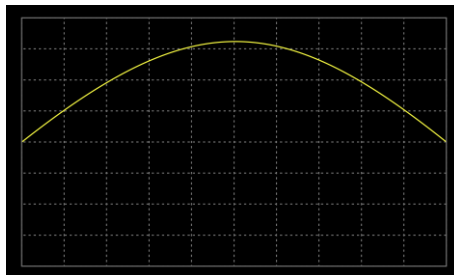



ARB 4 Sine wave, half-cycle(negative pole)

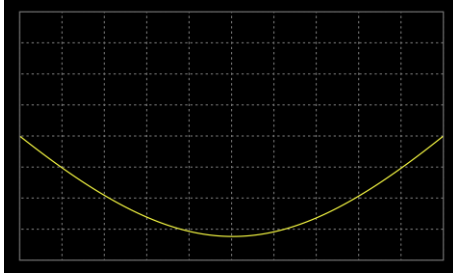

ARB 5 Sine wave, half-wave rectification(positive polarity)

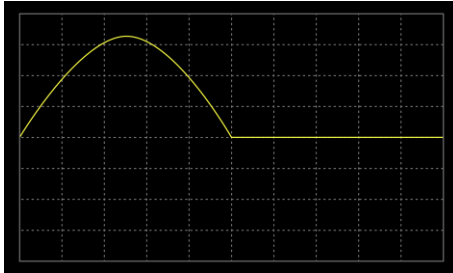

ARB 6 Sine wave, half-wave rectification(negative polarity)

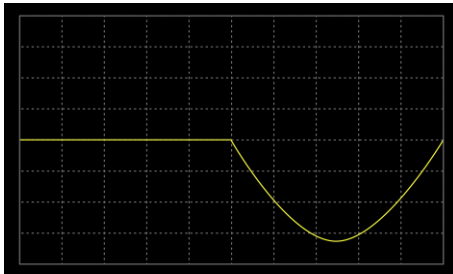

ARB 7 Sine wave, full-wave  
rectification(positive polarity)

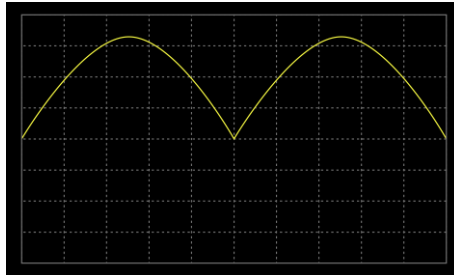

ARB 8 Sine wave, full-wave  
rectification(negative polarity)

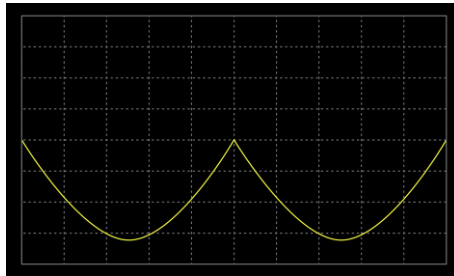

ARB 9 Second order step response(damping  
coefficient 0.1)

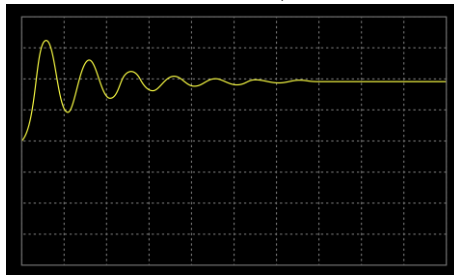

ARB 10 Second order step response(damping coefficient 0.2)

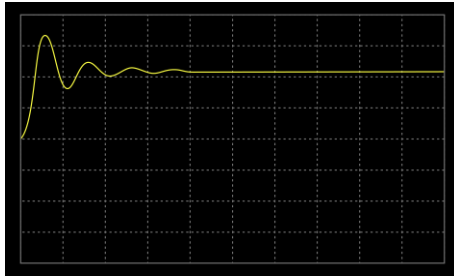

ARB 11 Second order step response(damping coefficient 0.7)

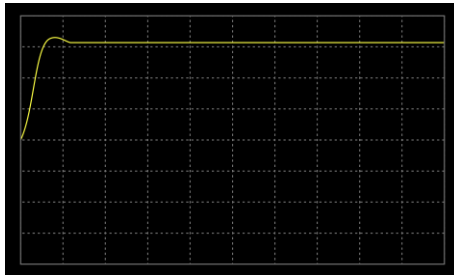

ARB 12 Second order impulse response(damping coefficient 0.1)

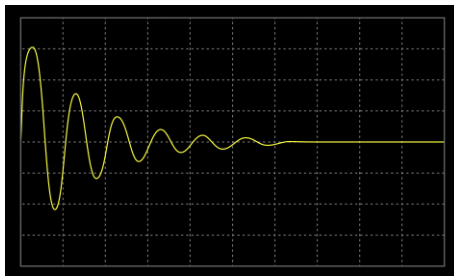

ARB 13 Second order impulse  
response(damping coefficient 0.2)

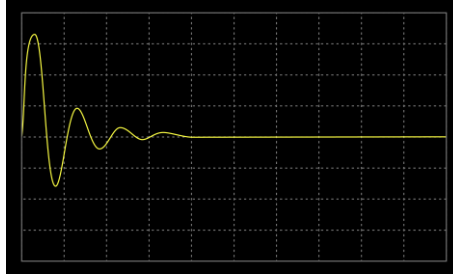

ARB 14 Second order impulse  
response(damping coefficient 0.7)

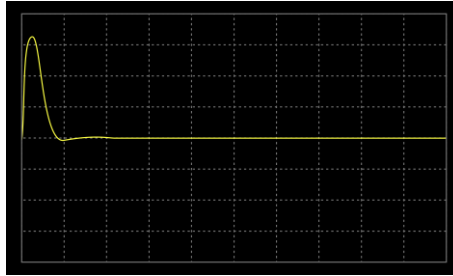

ARB 15 Exponential (rising)

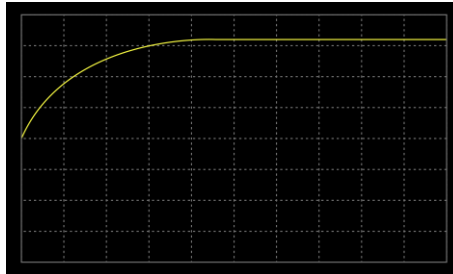

ARB 16 Exponential (falling)

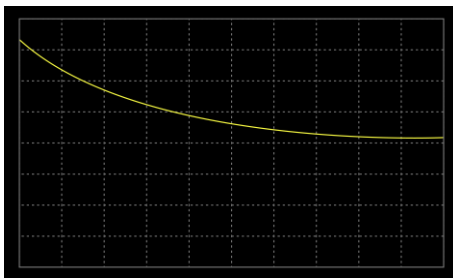

Note

Del ARB1~253 restores back to Default for ARB1~253 (page 142~143). Del All Data restores back to Default ARB1~16 is restored back to ARB, ARB17~253 is restored back to sin wave. (page 143~144).

3. Press *Enter* to confirm the waveform setting.

Example

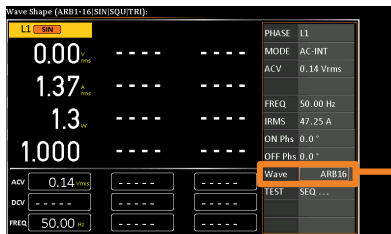

ARB 16 selected

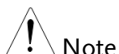

Note

When the input peak value of ARB waveform is not in the full scale 32767, the ratio of maximum value of voltage output by ARB waveform will decrease accordingly.

## Manage Arbitrary Waveform Settings

Arbitrary waveform settings can be easily saved to or from a USB flash drive using the Save/Recall Files utility in the Menu system. Files can also be deleted from local memory using the utility.

---

File Format	<p>When files are saved to USB they are saved in the following format:          ARBX.ARB, where X is the memory number 1 ~ 253 (ARB1 ~ ARB253). The files are saved to USB:/gw.</p> <p>When files are recalled from USB, files must be recalled from the same memory number. For example, the file ARB1.SEQ can only be recalled to memory number ARB1. The files can only be recalled from the USB:/gw directory.</p>										
Steps	<ol style="list-style-type: none"> <li>1. Press the <i>Menu</i> key. The Menu settings will appear on the display. </li> <li>2. Use the scroll wheel to go to item 12, <i>Save/Recall Files</i> and press <i>Enter</i>.</li> <li>3. Go to the <i>Type</i> setting using the scroll wheel and press <i>Enter</i>. Select <i>ARB</i> and press <i>Enter</i> to confirm.</li> <li>4. Go to the <i>Action</i> setting and choose the file operation and then press <i>Enter</i>.</li> </ol> <hr/> <table border="0" style="width: 100%;"> <tr> <td style="padding-right: 20px;">MEM→USB</td> <td>Saves the selected ARB memory from the local memory to a USB flash drive.</td> </tr> <tr> <td colspan="2"><hr/></td> </tr> <tr> <td style="padding-right: 20px;">MEM←USB</td> <td>Loads the ARB memory from a USB flash drive to the selected local memory.</td> </tr> <tr> <td colspan="2"><hr/></td> </tr> <tr> <td style="padding-right: 20px;">Delete</td> <td>Deletes the selected ARB memory from local memory.</td> </tr> </table> <hr/>	MEM→USB	Saves the selected ARB memory from the local memory to a USB flash drive.	<hr/>		MEM←USB	Loads the ARB memory from a USB flash drive to the selected local memory.	<hr/>		Delete	Deletes the selected ARB memory from local memory.
MEM→USB	Saves the selected ARB memory from the local memory to a USB flash drive.										
<hr/>											
MEM←USB	Loads the ARB memory from a USB flash drive to the selected local memory.										
<hr/>											
Delete	Deletes the selected ARB memory from local memory.										

- Go to the *Memory No.* setting and select the sequence memory number to perform the operation on. Press *Enter* to confirm.

---

Memory No.    1 ~ 253 (ARB1 ~ ARB253)

---

Execute File  
Operation

- Press *EXE[F1]* key to perform the file operation.



Exit

- Press *EXIT[F8]* key to exit from the *Save/Recall Files* settings.



Example

Load file from USB  
to Local memory

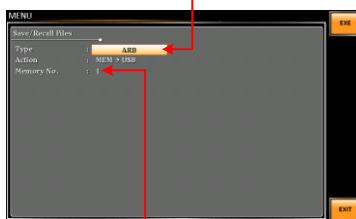

Memory No. 1 selected

All Data  
Operation

- Go back to the *Type* setting using the scroll wheel and press *Enter*. Select *All Data* and press *Enter* to confirm.
- Go to the *Action* setting and choose the file operation and then press *Enter*.

---

**MEM→USB**    Saves all the files including Preset, Sequence, Simulate and ARB from the local memory to a USB flash drive.

---

**MEM←USB**    Loads all the files including Preset, Sequence, Simulate and ARB from a USB flash drive to the local memory.

---

Delete	Deletes (Recall Default) all the files including Preset, Sequence, Simulate and ARB from local memory.
--------	--

**Example**

All Data option selected

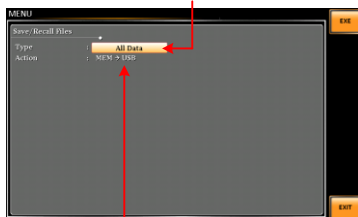

Save all data from  
Local memory to USB

Single Arbitrary Wave Default	From the previous step 4, execute the “Delete” action to restore the selected ARB memory back to the default setting.
----------------------------------	---

All Arbitrary Waves Default	From the previous step 9, execute the “Delete” action to restore the entire ARB memory back to the default setting.
--------------------------------	---



**Note**

For default ARB waveform setting, please refer to page 136 through 143.



## External Keypad Operation

### USB Keypad

ASR series supports external keypad, via Front panel USB connector, to execute operations including setting and output. Refer to the table below for functions of each key from external keypad.

Key	Function
TAB	Scale -->
/	Set Voltage
*	Set Frequency
0 ~ 9,00, .	Value input
+	Stepping increase Voltage (or Frequency)
-	Stepping decrease Voltage (or Frequency)
Enter	Enter
Back Space	Output On/Off

## Output Impedance Setting

**Background**                      This function makes sure that high impedance is set for ASR-6000 when output is ON. Also, it is to make output voltage nearly zero volt when output is OFF. In addition, it offers the specific test for battery or relevant devices in order to avoid minor current flow back to ASR-6000, that is to say, no discharge from battery to ASR-6000.

- Steps**
1. Press the *Menu* key. The Menu setting will appear on the display. 
  2. Use the scroll wheel to go to item 7, *Output Impedance* and press *Enter* to enter the Output Impedance Configuration page.
  3. Go to the *Output Impedance* setting using the scroll wheel and press *Enter* to turn On or OFF the function followed by setting *Output Inductance* and *Output Resistance* of each phase (L1, L2 & L3), respectively.

Output Impedance	ON, OFF
------------------	---------

L1, L2, L3 Output Inductance	0.0 - 2000μH
------------------------------	--------------

L1, L2, L3 Output Resistance	0.0 - 1Ω
------------------------------	----------

4. Press *Exit*[F8] to exit from the MENU settings. 

## Example

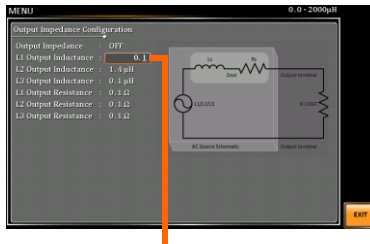

## L1 Output Inductance setting



## Note

This function supports the application of single unit only. As the figure below shown, it is Not available for application of connection with external parallel units.

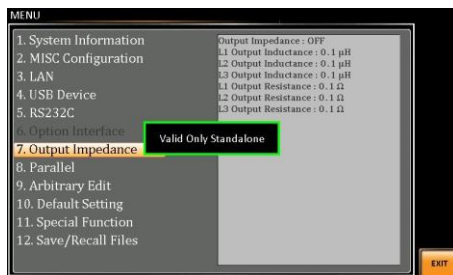

If there is any fluctuation in the output voltage when this function is initiated in conjunction with the DUT, the utilization of this function becomes impracticable.

## External Parallel Operation

**Background** This function is to provide larger rated power supply by which up to six ASR-6000 series units, which consist of both units of Master and Slave, are connected in parallel. See the following illustration for an example of 1 Master & 2 Slave units in parallel connection.

### Parallel Connection Diagram

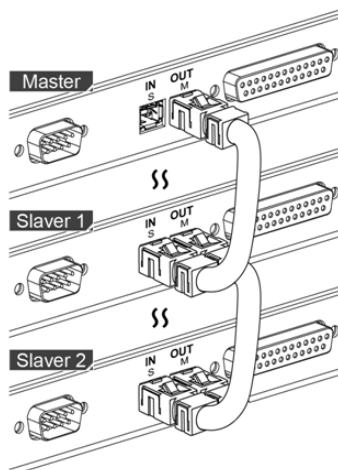

### Steps

1. Press the *Menu* key. The Menu setting will appear on the display. Menu
2. Use the scroll wheel to go to item 8, *Parallel* and press *Enter* to enter the Parallel Configuration page.
3. Set the Parallel-relevant configurations, respectively as following.

Position	Master, Slave
Parallel Number	2 - 3
Enable	OFF, ON

- Exit
4. Press *Exit*[F8] to exit from the MENU settings.



### Example

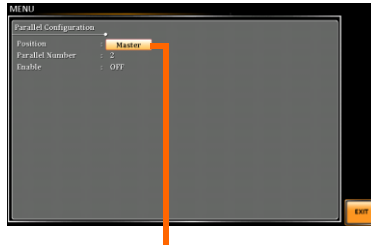

Parallel Master setting



### Note

- When “Slave” is selected from the Position field, the other settings including Parallel Number and Enable are Not available accordingly.
- It is available to connect in parallel on your own, or purchase ASR-6000 units in parallel connection by default from GW INSTEK. Refer to page 264 for details of the models in parallel connection.
- The V Response will be configured in Medium forcibly under the condition of parallel output.
- The standard accessory does Not include parallel cable. Please purchase the additional ASR-006 which will meet your need for external parallel connection.
- When external parallel is activated, the output frequency is limited to a maximum of 1kHz. The output specifications listed are not applicable when the external parallel function is activated.
- In the event of an inability to detect Slave unit, repeat the previous steps 1 through 4 again to reestablish the connection.



### WARNING

The length of output load cords are required to be exactly consistent; otherwise, it will cause abnormality in either operation or output. Contact your dealer of GW INSTEK if any issue occurs.

# EXTERNAL CONTROL

The rear panel has a connector that include signal input and output. This connector is used for external control from the menu of this product by using the external signal that includes amplified external voltage, amplified external signal, synchronization frequency and voltage and current monitor output.

Note that prior to operation, it is required to implement insulation process for external circuit. For example, while connecting to I/O signals of ASR-6000, be sure to have double insulation process for live parts in advance.

Turn on EXT Output by going to Menu -> MISC when necessary. The following chapter will give a brief overview for each of these connectors.

---

<b>External I/O Connector .....</b>	<b>151</b>
<b>External Signal Input Function .....</b>	<b>152</b>
EXT GAIN - AC+DC-EXT and AC-EXT mode.....	153
EXT ADD - AC+DC-ADD and AC-ADD mode.....	154
EXT Sync - AC+DC-Sync and AC-Sync mode.....	154
EXT Voltage - AC-VCA mode.....	156
Voltage and Current Monitor Output .....	157

## External I/O Connector

Overview	<p>The External I/O Connector is primarily used to control ASR-6000 externally by using the logic signal. More than that, it is able to monitor Sequence function status, voltage and current output level remotely with ease. In addition, the External I/O Connector is able to work with AC+DC-EXT, AC-EXT, AC+DC-ADD, AC-ADD, AC+DC-Sync, AC-Sync and AC-VCA modes.</p>
Specification	<p>Control input</p> <ul style="list-style-type: none"> <li>• High level: +2.2 V or higher</li> <li>• Low level: +1.0 V or lower</li> <li>• Non-destructive maximum input: <math>\pm 12</math> V</li> <li>• Input Impedance: Pulled up to +5 V with 47 k<math>\Omega</math></li> </ul> <hr/> <p>Status output</p> <ul style="list-style-type: none"> <li>• Output TTL level: 0 / +5 V</li> <li>• Output monitor: <math>\pm 2.5</math> V and <math>\pm 10</math> V selectable</li> <li>• Output Impedance: 100 <math>\Omega</math></li> </ul>

### Pin Assignment

Pin No.	I/O	Function	Remark
1	Output	Power source on/off status	0: OFF, 1: On
2	Output	The Output on/off status	0: OFF, 1: On
3	Output	Limiter operation status	0: OFF, 1: On
4	Output	Software busy status	0: Normal, 1: Busy
5	Output	Sequence sync output 0	
6	Output	Sequence sync output 1	
7	Output	Sequence sync output 2	
8	Output	Trigger output	
9	GND_D	Digital ground	
10	Input	Undefined input 0	
11	Input	Output off	Falling edge detection
12	Input	Output on	Falling edge detection
13	Input	Sequence start	Falling edge detection
14	Input	Sequence stop	Falling edge detection

15	Input	Sequence hold	Falling edge detection
16	Input	Sequence branch 1	Falling edge detection
17	Input	Sequence branch 2	Falling edge detection
18	GND_D	Digital ground	
19	Output	+5V	50mA or less
20	Input	External signal input 1	
21	Input	External signal input 2	
22	Input	External signal input 3	
23	Output	Monitor output 1	
24	Output	Monitor output 2	
25	GND_A	Analog ground	Using for external signal input and monitor output



Note

The limiter operation is recognized as On when the following conditions exist.

- Output peak current limiter (positive) is operated.
- Output peak current limiter (negative) is operated.
- Output average current limiter is operated.
- Output power limiter is operated.
- When output peak current limiter (positive), output peak current limiter (negative), output average current limiter, or output power limiter is operated, it is recognized as limiter operation on.

## External Signal Input Function

Overview	The External Signal Input port is particularly used for several output modes including AC+DC-EXT, AC-EXT, AC+DC-ADD, AC-ADD, AC+DC-Sync, AC-Sync and AC-VCA
External Signal Input port	Refer to the list above on page 151 for the definition of each pin.



## EXT GAIN - AC+DC-EXT and AC-EXT mode

**Overview** Select AC+DC-EXT or AC-EXT mode to use ASR-6000 as an amplifier specifically for signal input from the external signal input port on the rear panel. The impedance of input is  $1M\Omega$ , whilst the frequency range of input is from DC to 2000 Hz.

External Input Gain Range	External Input Gain	
	Setting	100V Range
Setting Range	0.0 to 250.0	0.0 to 500.0
Resolution	0.1	0.1
Initial Value	100.0	200.0

**Equation** Output voltage (V) =  
External input signal (V)  $\times$  Gain (V/V)

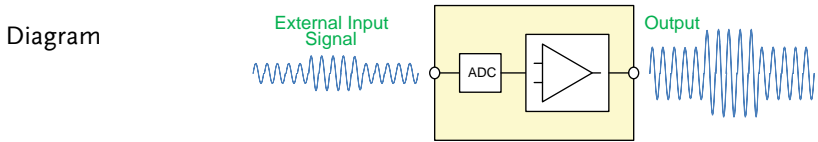

 **Note**

- It is suggested to use an input voltage of  $\pm 10V$  or less to prevent from clipping of the output voltage.
- In addition, never allow an input voltage to pass  $\pm 12V$  to avoid issues from the input block.
- If output frequency is higher, the output voltage will be attenuated accordingly.
- L1, L2 and L3 outputs correspond to the external signal input 1, 2 and 3 respectively. Refer to the chapter of SRC (Source) on page 101 for details.

## EXT ADD - AC+DC-ADD and AC-ADD mode

### Overview & Concept

Select AC+DC-ADD or AC-ADD mode to add the external signal source signal that includes magnification to the internal signal then power output on the rear panel. The impedance of input is  $1M\Omega$ , whilst the frequency range of input is from DC to 2000 Hz.

## EXT Sync - AC+DC-Sync and AC-Sync mode

### Overview

When AC+DC-Sync or AC-Sync mode is selected, the externally synchronized oscillation function embedded in the ASR-6000 synchronizes the output frequency, specifically, to the frequency of external synchronization TTL signal. It is not allowed to set the synchronization phase difference and the output frequency is able to be synchronized to frequency from 15 to 2000 Hz.

### Diagram & Concept

For SIG option, choose either EXT (signal sync) or LINE (line sync) for external sync signal source. It is noted that synchronous is with power source frequency when LINE is opted. See page 93 for operation steps.

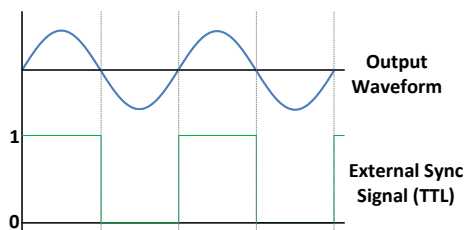



Note

- The limit frequency range of synchronous TTL signal is 15Hz ~ 2kHz. If TTL signal is greater than 2kHz, output will be disabled automatically.
  - L1, L2 and L3 outputs correspond to the external signal input 1, 2 and 3 respectively. Refer to the chapter of SRC (Source) on page 101 for details.
-

## EXT Voltage - AC-VCA mode

### Overview

Select AC-VCA mode to use ASR-6000 as an amplifier specifically for DC input from the external signal input port on the rear panel. The input voltage range of input is from DC -2.5V to +2.5V. The impedance of input is 1M $\Omega$ .

### Diagram

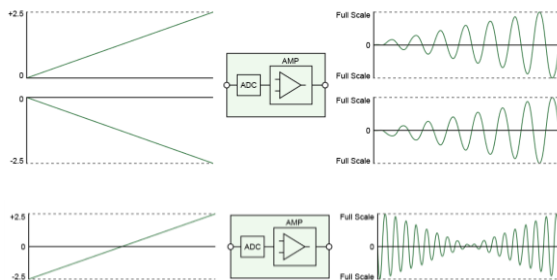

After magnification, if exceeds the maximum DC voltage value of the range that output waveform will be clamped.

## Voltage and Current Monitor Output

**Overview** Utilize the function of Monitor Output with External I/O pins 23 and 24 in conjunction with the Monitor Output Amp function found under MENU->MISC to empower user to arbitrarily select phase, voltage, current and amplitude of monitor outpCut.

Model		ASR-6450							
Phase mode		3P4W				1P2W			
R100/R200 Range		R100		R200		R100		R200	
H/L Level		H	L	H	L	H	L	H	L
Voltage(V/V)		4/125	1/125	4/250	1/250	4/125	1/125	4/250	1/250
Current(V/A)		2/(1 5*N)	1/(3 0*N)	4/(1 5*N)	1/(1 5*N)	2/(5* N)	1/(1 0*N)	4/(5* N)	1/(5* N)
Model		ASR-6600							
Phase mode		3P4W				1P2W			
R100/R200 Range		R100		R200		R100		R200	
H/L Level		H	L	H	L	H	L	H	L
Voltage(V/V)		4/125	1/125	4/250	1/250	4/125	1/125	4/250	1/250
Current(V/A)		1/(1 0*N)	1/(4 0*N)	1/(5* N)	1/(2 0*N)	3/(1 0*N)	3/(4 0*N)	3/(5* N)	3/(20 *N)
Accuracy		±5% of full scale							
Output Impedance		600 Ω							

 **Note**

- The H Level corresponds to output ±10V, whereas the L Level corresponds to output ±2.5V.
- N is corresponding to external parallel unit number

# MISCELLANEOUS

The Miscellaneous menu contains miscellaneous parameter settings.

---

T peak, hold .....	159
Phase Mode .....	161
Peak CLR .....	163
Power ON .....	165
Buzzer .....	167
Remote Sense .....	168
V Response .....	170
Output Relay .....	171
THD Format .....	172
External Control .....	174
V Unit .....	175
Set Change Phase .....	176
Monitor Output 1 and 2 .....	177
Monitor Output Amplitude .....	179
Trigger Out Width .....	180
Trigger Out Source .....	182
Re-lock .....	184
Data Average Count .....	186
Data Update Rate .....	187

## T peak, hold

The T peak, hold function sets the hold time for the peak voltage and current measurement. After the output is turned on, the ASR-6000 will delay starting the peak measurement by this hold time.

Concept in diagram

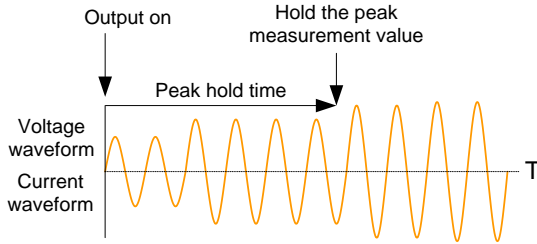

 Note

- The hold peak voltage and current value will be updated when new measurement is greater than the previous value. By contrast, it will not update when new measurement is less than the hold peak voltage and current value.
- Peak hold time begins counting only when the output function is turned on. Peak measurement is not executed during the set lpeak hold time.

Steps

1. Press the *Menu* key. The Menu setting will appear on the display. 
2. Use the scroll wheel to go to item 2, *MISC Configuration* and press *Enter*.
3. Go to the *T peak, hold(msec)* setting using the scroll wheel and press *Enter*. Set the time and press *Enter* again to confirm.

T peak      1 ~ 60,000 ms

Exit

4. Press *Exit[F8]* to exit from the MISC Configuration settings.



Example

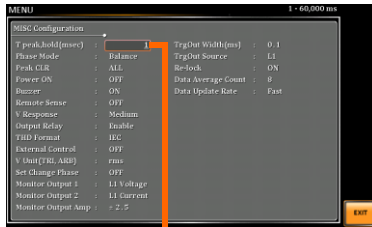

T Peak, Hold setting



## Phase Mode

The Phase Mode function allows user to select either Unbalance or Balance setting. When the Balance setting is selected under the 1P3W output, each phase degree is fixed 180°, whereas when it's in Balance setting under the 3P4W output, each phase degree is fixed 120°. On the other hand, when the Unbalance setting is opted, it is available to configure, per operation requirements, from the main setting page.



Note

The Unbalance setting is Not available for 1P2W and 1P3W output modes.

Steps

1. Press the *Menu* key. The Menu setting will appear on the display. 
2. Use the scroll wheel to go to item 2, *MISC Configuration* and press *Enter*.
3. Go to the *Phase Mode* setting using the scroll wheel and press *Enter*. Set the phase mode and press *Enter* again to confirm.

---

Unbalance	Phase degrees of L1 - L2 and L1 - L3 can be configured, separately.
-----------	---

---

Balance	Phase degree is fixed in 180° for 1P3W mode and 120° for 3P4W mode.
---------	---

---

Exit

4. Press *Exit[F8]* to exit from the MISC Configuration settings.



Example

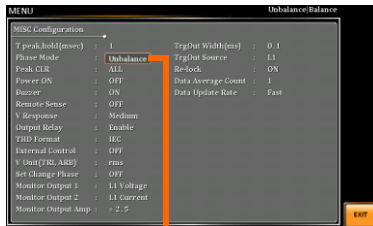

Phase Mode setting

L1 - L2 phase degree setting of Unbalance mode for 3P4W output



L1 -> L2 Phase degree setting

L1 - L3 phase degree setting of Unbalance mode for 3P4W output



L1 -> L3 Phase degree setting

## Peak CLR

The peak measured during output process can be easily cleared out via this function. It is applicable for user to restart measuring the peak value when necessity emerges.

### Steps

1. Press the *Menu* key. The Menu setting will appear on the display. 
2. Use the scroll wheel to go to item 2, *MISC Configuration* and press *Enter*.
3. Go to the *Peak CLR* setting using the scroll wheel and press *Enter* button. The measured hold peak value will be zeroed immediately.

Peak CLR ALL, L1, L2, L3



### Note

- When confirming selection, press Enter button to execute clear action immediately.
- The available options vary in accordance with different output modes.

### Exit

4. Press *Exit[F8]* to exit from the MISC Configuration settings. 

### Example

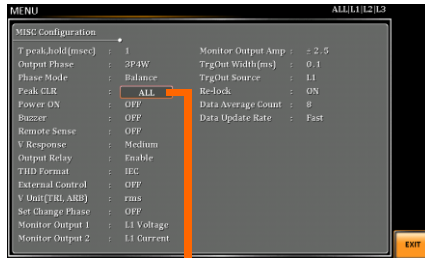

Peak CLR setting

**Note**

Although the hold peak current will be zeroing at once right after the execution of Peak CLR action, the zeroing value, however, will be soon updated when new measurement greater than 0 occurs during output process.

---

## Power ON

The Power ON setting allows you to have the power-on output or other operation functions on automatically after startup. The settings that are loaded are the last settings that were present in the standard mode before the unit was turned off last.

### Steps

1. Press the *Menu* key. The Menu setting will appear on the display. 
2. Use the scroll wheel to go to item 2, *MISC Configuration* and press *Enter*.
3. Go to the *Power ON* setting using the scroll wheel and press *Enter*. Select a setting and press *Enter* to confirm.

ON	Set power-on output ON with the setting that was loaded before the unit was last turned off.
OFF	Disable this function active.
SEQ	Execute the sequence that was loaded before the unit was last turned off. (It can be execute under AC-INT, AC+DC-INT and DC-INT mode only.)
SIM	Execute the simulation that was loaded before the unit was last turned off. (It can be execute under Sine wave and AC+DC_INT mode only.)

### Exit

4. Press *Exit[F8]* to exit from the MISC Configuration settings. 

Example

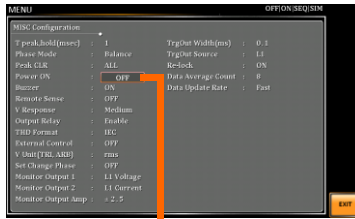

Power ON setting

## Buzzer

The Buzzer setting turns the buzzer sound on or off for key presses.

### Steps

1. Press the *Menu* key. The Menu setting will appear on the display. 
2. Use the scroll wheel to go to item 2, *MISC Configuration* and press *Enter*.
3. Go to the *Buzzer* setting using the scroll wheel and press *Enter*. Turn the setting on or off and press *Enter* again to confirm.

Buzzer      ON, OFF

### Exit

4. Press *Exit[F8]* to exit from the MISC Configuration settings. 

### Example

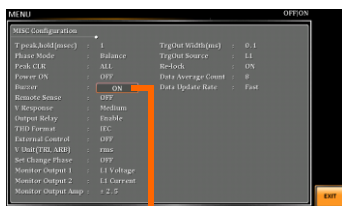

Buzzer setting

## Remote Sense

The remote sense function detects the output voltage at the sensing input terminal. This function compensates for voltage drops across the load cables when the load is connected to the ASR-6000 over a long distance.



Note

The remote sense function can compensate a maximum of 5% of the output voltage. The maximum output voltage when compensation is used is limited by the rated voltage.

Steps

1. Press the *Menu* key. The Menu setting will appear on the display. 
2. Use the scroll wheel to go to item 2, *MISC Configuration* and press *Enter*.
3. Go to the *Remote Sense* setting using the scroll wheel and press *Enter*. Turn the setting on or off and press *Enter* again to confirm.

Remote Sense                      ON, OFF

Exit

4. Press *Exit[F8]* to exit from the MISC Configuration settings. 

Example

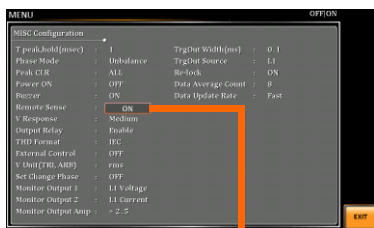

Remote Sense setting





Note

Remote sense function is available as follows:

1. Only (AC-INT/AC-SYNC and Sinewave ) or DC-INT
2. Output Impedance is Turned off
3. When the Output is ON, it will forcibly turn OFF the Output and delay for 100 ms before switching the setting.
4. Only R100 or R200 Range



WARNING

The Remote Sense function is applicable to the 1P2W, 1P3W, and 3P4W output modes simultaneously. Please be mindful of the status of Remote Sense function when switching between output modes to avoid damage to the DUT.

Display

When the remote sense function is on, the displayed voltage value is the voltage measured at the sense terminal and the symbol "SENS" is displayed on the status bar.

## SENS displayed



WARNING

- Before connecting the remote sense cables, turn off the output and peripherals. Please see page 57 for more information of the remote sense cabling instructions.
- If the remote sense wires are loose or falling (specifically the remote sense terminal + and the load terminal + & -) or in reverse polarity, the display would show a warning message.

## V Response

The voltage response, which is described as the fluctuating change of voltage rising time when output on moment, can be customized by user in the 3 speeds containing Fast, Medium(default) and Slow elaborated below for ASR-6000 models.

### Steps

1. Press the *Menu* key. The Menu setting will appear on the display. 
2. Use the scroll wheel to go to item 2, *MISC Configuration* and press *Enter*.
3. Go to the *V Response* setting using the scroll wheel and press *Enter*. Choose the slew rate mode and press *Enter* again to confirm.

V Response Slow, Medium (default), Fast

### Exit

4. Press *Exit*[F8] to exit from the MISC Configuration settings. 



### Note

Fast response setting is not suitable for the 1P2W output mode, output impedance setting as on status and external parallel operation.

### Example

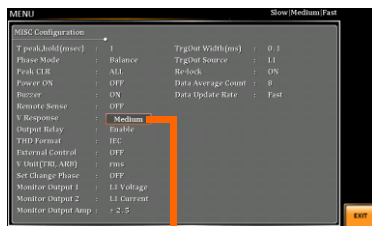

V Response setting

## Output Relay

The internally built-in output relay function has close relation with the power output function by default. That is to say, when output is on, the output relay will be activated if output relay is enabled; by contrast, the output relay will be deactivated when output is off. On the other hand, output relay function disabled means output terminal is under the condition of high impedance and output relay retains the state of conducting for good, which is suitable for the condition of turning output on/off rapidly.

### Steps

1. Press the *Menu* key. The Menu setting will appear on the display. 
2. Use the scroll wheel to go to item 2, *MISC Configuration* and press *Enter*.
3. Go to the *Output Relay* setting using the scroll wheel and press *Enter*. Enable or disable output relay mode and press *Enter* again to confirm.

Output Relay      Enable, Disable

### Exit

4. Press *Exit*[F8] to exit from the MISC Configuration settings. 

### Example

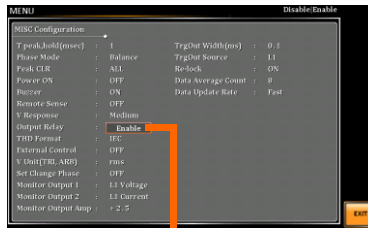

Output Relay setting

## THD Format

Choose one of the THD (Total Harmonic Distortion) equations. The equations of 2 varied modes (IEC by default) of Harmonic Format below are for, specifically, by the time the upper limit of measured harmonic order is 100.

### Steps

1. Press the *Menu* key. The Menu setting will appear on the display. 
2. Use the scroll wheel to go to item 2, *MISC Configuration* and press *Enter*.
3. Go to the *THD Format* setting using the scroll wheel and press *Enter*. Choose the harmonic mode and press *Enter* again to confirm.

IEC & Equation      The ratio of rms value of the second to the 100th harmonic component is computed to that of the fundamental.

$$\frac{\sqrt{\sum_{O=2}^N (F_o)^2}}{F_1} \times 100$$

CSA & Equation      The ratio of rms value of the second to the 100th harmonic component is computed to that of the rms value of the first to 100th component.

$$\left[ \frac{\sqrt{\sum_{O=2}^N (F_o)^2}}{\sqrt{\sum_{O=1}^N (F_o)^2}} \right] \times 100$$

- Parameter
- F<sub>1</sub>: Fundamental (1st harmonic) component
  - F<sub>O</sub>: Fundamental or harmonic component
  - O: Measured harmonic order
  - N: Always 100

Exit

4. Press *Exit*[F8] to exit from the MISC Configuration settings.



Example

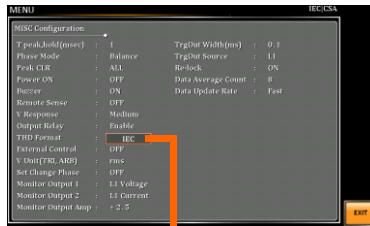

THD Format setting

## External Control

User can enable or disable the External Control I/O input. When External Control I/O input is set as disabled, the ASR-6000 series status will remain output.

### Steps

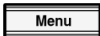
1. Press the *Menu* key. The Menu setting will appear on the display. 
2. Use the scroll wheel to go to item 2, *MISC Configuration* and press *Enter*.
3. Go to the *External Control* setting using the scroll wheel and press *Enter*. Enable or disable External Control I/O and press *Enter* again to confirm selection. Refer to the chapter of External I/O connection on page 151 for details.

**ON** ASR-6000 series is able to receive external input signal and execute control action.

**OFF** ASR-6000 series is Not able to receive external input signal.

### Exit

4. Press *Exit*[F8] to exit from the MISC Configuration settings. 

### Example

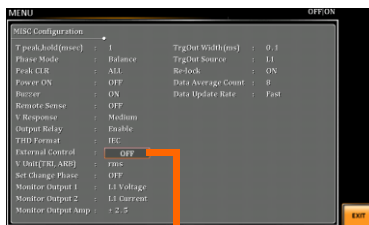

**External Control setting**

## V Unit

User can freely select voltage set value unit as either RMS or PEAK only when output waveform is selected TRI or ARB.

Steps

1. Press the *Menu* key. The Menu setting will appear on the display. 
2. Use the scroll wheel to go to item 2, *MISC Configuration* and press *Enter*.
3. Go to the *V Unit* setting using the scroll wheel and press *Enter*. Choose the setting voltage unit and press *Enter* again to confirm selection.

rms            Set the setting voltage unit to rms for all of output waveform.

p-p            Set the setting voltage unit to peak for TRI and ARB output waveform only.

Exit

4. Press *Exit[F8]* to exit from the MISC Configuration settings. 

Example

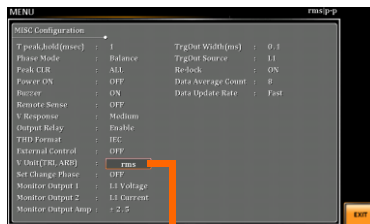

V unit setting

## Set Change Phase

This function allows users to choose to output at a fixed angle or a random angle when the configuration setting change is executed.



Note

- The settings contain Voltage, Gain, Waveform, Output Phase, Frequency and Duty.
- This function is Not available for the DC-INT, AC+DC-EXT, AC-EXT and AC-VCA MODE.

Steps

1. Press the *Menu* key. The Menu setting will appear on the display. 
2. Use the scroll wheel to go to item 2, *MISC Configuration* and press *Enter*.
3. Go to the *Set Change Phase* setting using the scroll wheel and press *Enter*. Set the time and press *Enter* again to confirm.

**ON** When setting is changed, it will remain fixed until the waveform reaches 0 degree before the change takes effect.

**OFF** When setting is changed, it will change instantly upon the execution being confirmed.

Exit

4. Press *Exit[F8]* to exit from the MISC Configuration settings. 

Example

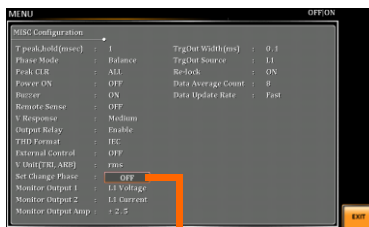

Set Change Phase setting



## Monitor Output 1 and 2

This function, which is paired with External Control I/O pin, is specifically for 2 monitor output. User can customize own phase, voltage and current for monitor output.

---

### Steps

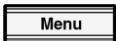
1. Press the *Menu* key. The Menu setting will appear on the display. 
2. Use the scroll wheel to go to item 2, *MISC Configuration* and press *Enter*.
3. Go to the *Monitor Output 1 / 2* setting using the scroll wheel and press *Enter*. Set the time and press *Enter* again to confirm.

---

L1 Voltage, L2 Voltage,  
Monitor Output 1 / 2 L3 Voltage, L1 Current,  
L2 Current, L3 Current

---

### Exit

4. Press *Exit[F8]* to exit from the MISC Configuration settings. 



### Note

The available options vary in accordance with different output modes.

---

Example –  
Monitor Output 1

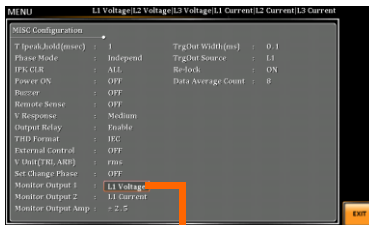

Monitor Output 1 setting

Example –  
Monitor Output 2

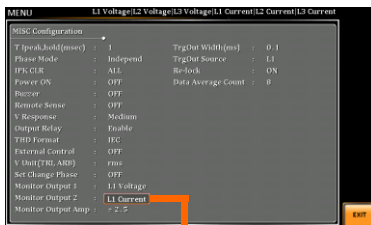

Monitor Output 2 setting

## Monitor Output Amplitude

This function, which is paired with External Control I/O pin, provides either  $\pm 2.5V$  or  $\pm 10V$  voltage amplitude for selection to correspond to L1/L2/L3 voltage or current output ratio.

In terms of conversion ratio of different models, please refer to the chapter Voltage and Current Monitor Output on page 157.

### Steps

1. Press the *Menu* key. The Menu setting will appear on the display. 
2. Use the scroll wheel to go to item 2, *MISC Configuration* and press *Enter*.
3. Go to the *Monitor Output Amp* setting using the scroll wheel and press *Enter*. Set the time and press *Enter* again to confirm.

Monitor Output Amp  $\pm 2.5V / \pm 10V$

### Exit

4. Press *Exit[F8]* to exit from the MISC Configuration settings. 

### Example

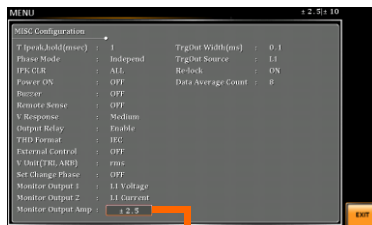

Monitor Output Amp setting

## Trigger Out Width

This function, which is paired with External Control I/O pin and Trigger Out Source, generates a TTL pulse signal output synchronously with output waveform.



Note

- When the set time of Pulse Width is greater than a period time of output frequency, output Pulse maintains High Level.
- The Trigger signal generates in 0 degrees only.
- This function can be executed under AC+DC mode, even DC Offset is configured.
- This function is Not available for DC-INT, AC+DC-EXT and AC-EXT modes.

Steps

1. Press the *Menu* key. The Menu setting will appear on the display. 
2. Use the scroll wheel to go to item 2, *MISC Configuration* and press *Enter*.
3. Go to the *TrgOut Width(ms)* setting using the scroll wheel and press *Enter*. Set the time and press *Enter* again to confirm.

TrgOut Width 0.1 ~ 60.0 ms

Exit

4. Press *Exit[F8]* to exit from the MISC Configuration settings. 

Example

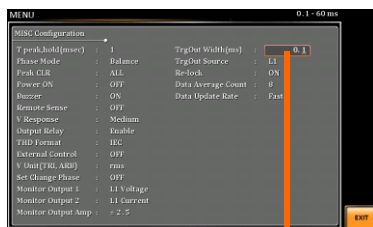

Trigger Out Width setting

The actual waveform –  
 AC-INT Mode,  
 Frequency 900  
 Hz, TrgOut Width  
 0.1 ms

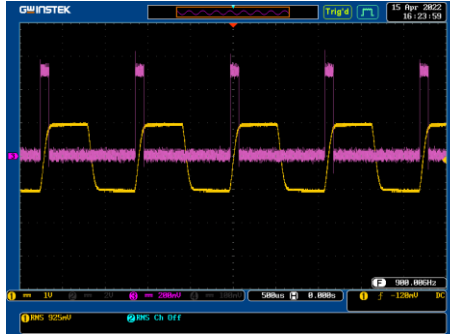

The actual waveform –  
 AC-INT Mode,  
 Frequency 900  
 Hz, TrgOut Width  
 1 ms

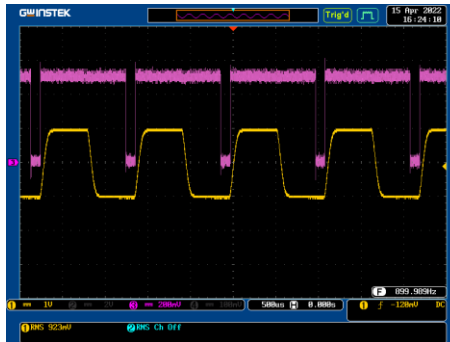

The actual waveform –  
 AC-INT Mode,  
 Frequency 900  
 Hz, TrgOut Width  
 1.1 ms

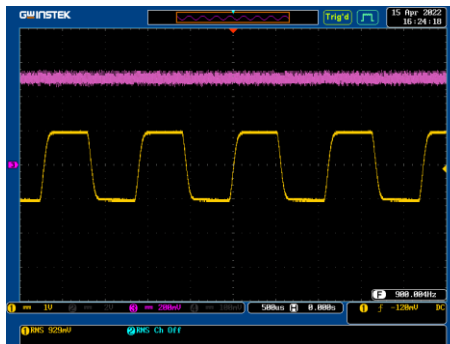

## Trigger Out Source

This function, which is paired with Trigger Out Width, allows user to select which output phase for synchronous output by Trigger out.

### Steps

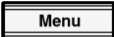
1. Press the *Menu* key. The Menu setting will appear on the display. 
2. Use the scroll wheel to go to item 2, *MISC Configuration* and press *Enter*.
3. Go to the *TrgOut Source* setting using the scroll wheel and press *Enter*. Set the time and press *Enter* again to confirm.

TrgOut Source L1, L2, L3

### Exit

4. Press *Exit*[F8] to exit from the MISC Configuration settings. 



### Note

The available options vary in accordance with different output modes.

### Example

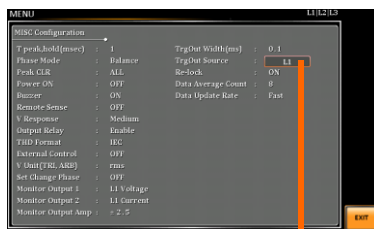

TrgOut Source setting

**Actual Waveform**

When user selects the 3P4W output mode and the Trigger output width is set to 2.5ms and L1, the Actual Waveform will be as the following diagram.

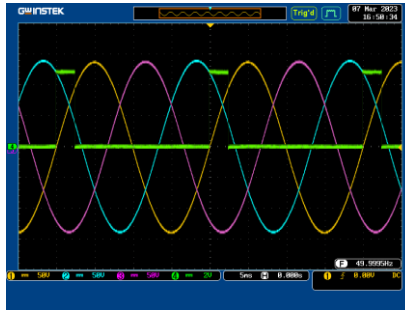

## Re-lock

This function is used to lock the phase degree again since the output voltage and frequency are set separately in either the 1P3W or the 3P4W output mode. For example, when re-lock is disabled, the output phase difference does not return to the default setting. Instead, when re-lock is enabled, the output phase difference will return to the default setting.



Note

This function support 1P3W and 3P4W modes only.

Steps

1. Press the *Menu* key. The Menu setting will appear on the display. 
2. Use the scroll wheel to go to item 2, *MISC Configuration* and press *Enter*.
3. Go to the *Re-lock* setting using the scroll wheel and press *Enter*. Set the time and press *Enter* again to confirm.

Re-lock                      ON, OFF

Exit

4. Press *Exit*[F8] to exit from the MISC Configuration settings. 

Example

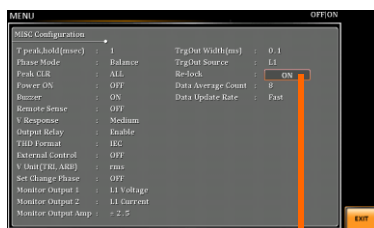

Re-lock setting



Re-lock Disable  
illustration

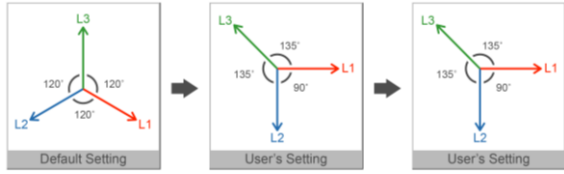

Re-lock Enable  
illustration

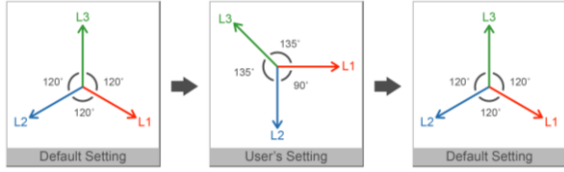

## Data Average Count

This function allows user to designate an exact count number to average the measured data. It is particularly practical for large changes in load or power of low input signal frequency.

Steps

1. Press the *Menu* key. The Menu setting will appear on the display.
2. Use the scroll wheel to go to item 2, *MISC Configuration* and press *Enter*.
3. Go to the *Data Average Count* setting using the scroll wheel and press *Enter*. Set the time and press *Enter* again to confirm.



Data Average Count 1 - 128

Exit

4. Press *Exit[F8]* to exit from the MISC Configuration settings.



Example

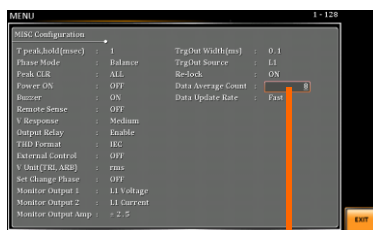

Data Average Count setting



Note

- The available parameters for Data Update Rate: Vrms, Vmax, Vmin, Irms, Imax, Imin, PF, CF, P, S, Q, Vavg, Iavg, IpkH.
- The Unavailable parameters for Data Update Rate: Freq, THDv, THDi.

## Data Update Rate

This function allows user to define update rate (time period) for the measured data. Take the 5s for example, the measured data updates in an interval of every 5 second.

### Steps

1. Press the *Menu* key. The Menu setting will appear on the display. 
2. Use the scroll wheel to go to item 2, *MISC Configuration* and press *Enter*.
3. Go to the *Data Update Rate* setting using the scroll wheel and press *Enter*. Set the time and press *Enter* again to confirm.

Data Update Rate	Fast/0.1s/0.25s/0.5s/1s /2s/5s/10s/20s
------------------	---



### Note

The option “Fast” indicates 0.005s equal to 5ms.

### Exit

4. Press *Exit*[F8] to exit from the MISC Configuration settings. 

### Example

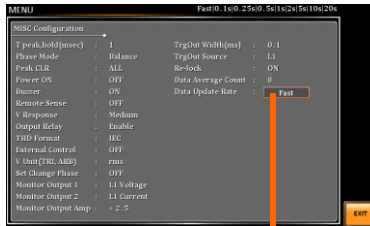

Data Update Rate setting



### Note

- The available parameters for Data Update Rate: Vrms, Vmax, Vmin, Irms, Imax, Imin, PF, CF, P, S, Q, Vavg, Iavg, IpkH.
- The Unavailable parameters for Data Update Rate: Freq, THDv, THDi.

# T EST MODE FUNCTION

There are two test modes, Sequence Mode and Simulate Mode respectively, available for user to execute. Refer to the following chapters for details in necessity.

---

<b>Sequence Mode .....</b>	<b>189</b>
Sequence Mode Overview .....	189
Sequence Settings .....	195
Save a Sequence to Local Memory .....	200
Recall a Sequence from Local Memory.....	200
Manage Sequence Settings .....	201
Running a Sequence .....	205
<b>Simulate Mode .....</b>	<b>207</b>
Simulate Mode Overview .....	207
Simulate Settings.....	210
Save a Simulation to Local Memory .....	213
Recall a Simulation from Local Memory.....	213
Manage Simulation Settings .....	214
Running a Simulation .....	217

# Sequence Mode

## Sequence Mode Overview

### Background

The Sequence function works with DC-INT, AC-INT and AC+DC-INT modes with full AC waveforms containing sine, square, triangle as well as arbitrary. The available parameters, which will be introduced in later sectors, vary depending on selected output modes.

A Sequence function is comprised of up to the maximum 999 steps.

### Setting Screen Overview

AC Voltage Item

Step termination

Branch 1

Jump To

Step Number

Step Time

Jump Count

Branch 2

Sync Code

Test Mode

Recall Mode

Save Mode

Run Mode

Phase

Off Phase

On Phase

Waveform

Frequency

ACV	Item	Wave	On Phase	Off Phase	Waveform	Frequency
0.00 Vrms CT	L1	0.00 CT	0.00 CT	0.00 CT	0.00 CT	0.00 CT
0.00 Vrms CT	L2	0.00 CT	0.00 CT	0.00 CT	0.00 CT	0.00 CT
0.00 Vrms CT	L3	0.00 CT	0.00 CT	0.00 CT	0.00 CT	0.00 CT
0.00 Vrms CT	L4	0.00 CT	0.00 CT	0.00 CT	0.00 CT	0.00 CT
0.00 Vrms CT	L5	0.00 CT	0.00 CT	0.00 CT	0.00 CT	0.00 CT
0.00 Vrms CT	L6	0.00 CT	0.00 CT	0.00 CT	0.00 CT	0.00 CT
0.00 Vrms CT	L7	0.00 CT	0.00 CT	0.00 CT	0.00 CT	0.00 CT
0.00 Vrms CT	L8	0.00 CT	0.00 CT	0.00 CT	0.00 CT	0.00 CT
0.00 Vrms CT	L9	0.00 CT	0.00 CT	0.00 CT	0.00 CT	0.00 CT
0.00 Vrms CT	L10	0.00 CT	0.00 CT	0.00 CT	0.00 CT	0.00 CT

### Sequence Parameter Overview

The Sequence function is comprised of a minimum of 2 steps that are executed in user defined sequences.

Each step can have different step time, voltage level, on & off phase, frequency and wave.



Note

Step 0 is assigned as a “Standby” step. At the end of the test the unit will shift to the standby step.

Voltage range settings follow up main page set up, there are two ranges

HI and LO, which result in varied ranges of ACV and DCV values, respectively.

List of the Sequence Setting Items of the Output Modes

Items	Mode		
	AC+DC-INT	AC-INT	DC-INT
Step	✓	✓	✓
Time	✓	✓	✓
Jump to	✓	✓	✓
Jump Cnt	✓	✓	✓
Branch 1 / 2	✓	✓	✓
Term	✓	✓	✓
Sync Code	✓	✓	✓
ACV	✓	✓	X
DCV	✓	X	✓
Fset	✓	✓	X
Wave	✓	✓	X
ON / OFF Phase	✓	✓	X
Phase	✓	✓	X

Step	Assigns the step number.
Time	Sets the step duration time. This step time is exclusive of any transition time needed to match on phases and off phase. See the diagram on page 193 for details.

Jump To	The Jump To setting determines which step to jump to at the end of the step. If Jump To is turned off, the unit will follow the Term (Step termination) setting for the step.
Jump Cnt	Determines the number of times to loop the jump step.
Branch1/ Branch2	The Branch settings allow you to make a selectable branch within the sequence when the sequence is running or on hold. The branch1 or branch2 actions are enabled by pressing the <i>F3</i> or <i>F4</i> function keys, or by using the :TRIG:SEQ:SEL:EXEC remote control command. After the branch step(s) have completed the unit will return back to the step from which the branch was executed and continue to run the step from where it left off.
Term (Termination)	<p>Determines the step termination settings at end of the step.</p> <p>The CONTI setting tells the sequence to go to the next step.</p> <p>The HOLD setting will pause the output at the end of the step and will only continue to the next step when CONTI [F2] is pressed.</p> <p>The END setting will end the sequence and go to Step 0(standby step).</p>
Sync Code	Sets the synchronous code including LL, LH, HL and HH for each step.

---

ACV	<p>Sets the AC voltage level. There are 3 secondary voltage settings that determine how the voltage is output.</p> <p>CT: Sets the voltage level of the step immediately to ACV values.</p> <p>KP: Sets the voltage level to “keep” the voltage of the previous step.</p> <p>SP: Linearly increases or decreases the values from the end of the previous step to the end of the current step.</p>
DCV	<p>Sets the DC voltage level. There are 3 secondary voltage settings that determine how the voltage is output.</p> <p>CT: Sets the voltage level of the step immediately to DCV values.</p> <p>KP: Sets the voltage level to “keep” the voltage of the previous step.</p> <p>SP: Linearly increases or decreases the values from the end of the previous step to the end of the current step.</p>
Fset (Frequency)	<p>Sets the frequency of the step. There are 3 secondary frequency settings that determine how the frequency is output.</p> <p>CT: Sets the frequency level of the step immediately to Fset values.</p> <p>KP: Sets the frequency level to “keep” the frequency of the previous step.</p> <p>SP: Linearly increases or decreases the frequency from the end of the previous step to the end of the current step.</p>

---



Wave	Sets the outputting waveform of the step. Up to 4 waves including sine, square, triangle and arbitrary (1-253) wave shapes are available.
ON/OFF Phs	Sets the start and stop phase of the AC waveform for each step. The ON Phs setting sets the starting phase <i>of the step</i> .  OFF Phs sets the off phase <i>for the output</i> when the output is turned off.
Phase	Sets output phase. It is applicable to 3P4W output modes only.

Sequence Example

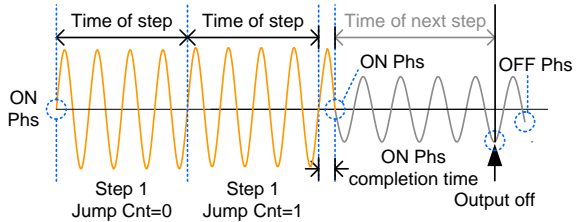

Process Flow in Sequence Step

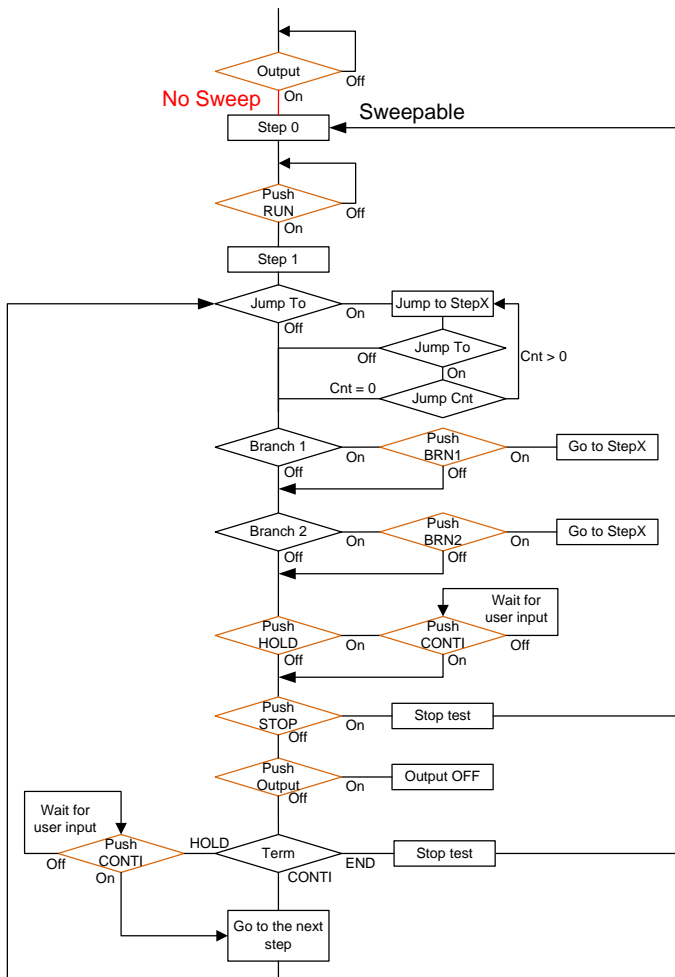

**Note**

The Remote Sense will be forcibly set OFF after entering the SEQ Mode. It will automatically return to the previous setting after exiting from the SEQ Mode.

## Sequence Settings

Entering the  
Sequence Menu

1. Press *Test* key.



Alternatively, it is available to navigate, with scroll wheel, to the *TEST SEQ...* option followed by pressing the *Enter* key to enter the *SEQUENCE* menu.



2. Press *Seq/Sim[F1]* key to toggle to the *SEQUENCE* Mode.
3. Use the scroll wheel to go to the *Step* setting and press *Enter*.
4. Use the scroll wheel to select the step number. 0 is always the starting step for the sequence.

---

Step	0 ~ 999
------	---------

---

5. Go to the *Time setting* and set the duration of the step.

---

Time	0.0001 ~ 9999.9999s
------	---------------------

---

6. Go to the *ACV setting* and set the output voltage for the step. If you input an ACV value that is not within the voltage range, the warning message below will be shown.

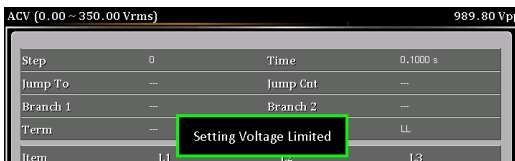

Next set the secondary voltage settings to determine characteristics of the voltage output.

ACV	0.00 ~ 175.00 (Range 100V) 0.00 ~ 350.00 (Range 200V)
Secondary settings	CT (Constant), KP (Keep), SP (Sweep)  Note: Step 0 can only be set to either CT or SP.

- Go to the *DCV* setting and set the output voltage for the step. If you input a DCV value that is not within the voltage range, the warning message below will be shown.

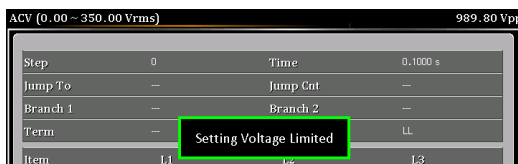

Next set the secondary voltage settings to determine characteristics of the voltage output.

DCV	-250.0 ~ +250.0V (Range 100V) -500.0 ~ +500.0V (Range 200V)
Secondary settings	CT (Constant), KP (Keep), SP (Sweep)

Note

Step 0 can only be set to either CT or SP.

Note

ACV setting range varies when Wave is TRI or ARB1~253. The setting range is 0.00~500.00 Vpp or 0.00 ~ 1000.0 Vpp when V Unit is set p-p.

- Go to the *Fset* setting and set the frequency of the step. If you input a frequency value that is not within the range, the warning message below will be shown.



Fset	1.00~2000.0 (AC+DC-INT mode) 15.00~2000.0 (AC-INT mode)
------	--

Secondary settings	CT (Constant), KP (Keep), SP (Sweep)  Note: Step 0 can only be set to either CT or SP.
--------------------	--

9. Go to the *Wave* setting and choose which waveform to output.

Wave	SIN, SQU, TRI, ARB1 - 253
------	---------------------------

10. Go to the *Jump To* setting and choose which step to jump to, or turn the setting off.

Step	ON, OFF, 0 ~ 999
------	------------------

11. Go to the *Jump Cnt* setting and set the number of times the current step will loop.

Jump Cnt	1 ~ 9999, 0  Note: A setting of 0 will set the number of jump step to be infinite.
----------	--

12. Go to the *Branch 1/2* setting and set a step to branch to.

Branch 1, 2	ON, OFF, 0 ~ 999
-------------	------------------

13. Go to the *Term* setting and set the step termination setting. CONTI will automatically go to the next step at the end of the step. END will return to step 0. HOLD will stay at the current step until you allow the sequence to continue to the next step.

Term	CONTI, END, HOLD
------	------------------

14. Go to the *Sync Code* setting and set the synchronous code when the step has started.

Sync Code	LL, LH, HL, HH
-----------	----------------

15. Go to the *ON Phs* setting and set the starting phase of the step. The *Fixed* indicates user-defined degree.

ON Phase	Free, Fixed
----------	-------------

ON Phase	0.0 ~ 359.9°
----------	--------------

Resolution	0.1°
------------	------

16. Go to the *OFF Phs* setting and set the end phase of the step. The *Fixed* indicates user-defined degree.

OFF Phase	Free, Fixed
-----------	-------------

OFF Phase	0.0 ~ 359.9°
-----------	--------------

Resolution	0.1°
------------	------

17. Go to the *Phase* setting and set the phase degree.

Phase	L2	0.0 ~ 359.9°
-------	----	--------------

	L3	0.0 ~ 359.9°
--	----	--------------

Resolution	0.1°
------------	------

Note: This step is for 3P4W output Mode only and the L1 is always fixed to 0°.

Example of Using Sequence Function

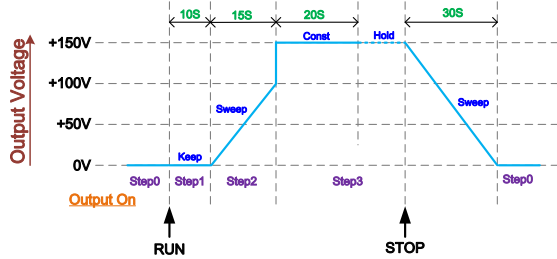

The example above shows how to generate a test procedure in DC-INT mode by each step.

Step No.	0	1	2	3
Step Time	30 S	10 S	15 S	20 S
DCV	0 V	50 V	100 V	150 V
2 <sup>nd</sup> Setting	SP	KP	SP	CT
Term	---	CONTI	CONTI	HOLD

## Save a Sequence to Local Memory

---

**Saving a Sequence**                      Sequence settings can be saved to one of 10 memory slots (SEQ0 ~ SEQ9).

- Steps**
1. Press *Save*[F3] key firstly.
  2. A list of memory slots prompts where it is available to use scroll wheel followed by pressing *Enter* to execute save action.
  3. A prompt message will appear when the save action is successful.

---

Save                      SEQ0 ~ SEQ9

## Recall a Sequence from Local Memory

---

**Recall a Sequence**                      Sequence settings can be recalled from one of 10 memory slots (SEQ0 ~ SEQ9).

- Steps**
1. Press *Recall*[F2] key firstly.
  2. A list of memory slots prompts where it is available to use scroll wheel followed by pressing *Enter* to execute recall action.
  3. A message will appear when the settings are recalled successfully.

---

Recall                      SEQ0 ~ SEQ9



## Manage Sequence Settings

Sequence settings can be easily saved to or from a USB flash drive using the Save/Recall Files utility in the Menu system. Files can also be deleted from local memory using the utility.

---

File Format	<p>When files are saved to USB they are saved in the following format: SEQX.SEQ, where X is the memory number 0 ~ 9 (SEQ0 ~ SEQ9). The files are saved to USB:/gw.</p> <p>When files are recalled from USB, files must be recalled from the same memory number. For example, the file SEQ0.SEQ can only be recalled to memory number SEQ0. The files can only be recalled from the USB:/gw directory.</p>
-------------	---

---

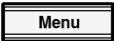
- |       |   |
|-------|---|
| Steps | <ol style="list-style-type: none"> <li>1. Press the <i>Menu</i> key. The Menu settings will appear on the display. </li> <li>2. Use the scroll wheel to go to item 12, <i>Save/Recall Files</i> and press <i>Enter</i>.</li> <li>3. Go to the <i>Type</i> setting using the scroll wheel and press <i>Enter</i>. Select <i>SEQUENCE</i> and press <i>Enter</i> to confirm.</li> <li>4. Go to the <i>Action</i> setting and choose the file operation and then press <i>Enter</i>.</li> </ol> |
|-------|---|
- 

MEM→USB	Saves the selected sequence memory from the local memory to a USB flash drive.
---------	--

---

MEM←USB	Loads the sequence memory from a USB flash drive to the selected local memory.
---------	--

---

Delete	Deletes (Recall Default) the selected sequence memory from local memory.
--------	--

5. Go to the *Memory No.* setting and select the sequence memory number to perform the operation on. Press *Enter* to confirm.

Memory No.    0 ~ 9 (SEQ0 ~ SEQ9)

Execute File Operation

6. Press *EXE[F1]* key to perform the file operation.



Exit

7. Press *EXIT[F8]* key to exit from the *Save/Recall Files* settings.



Example

Saves files from Local memory to USB

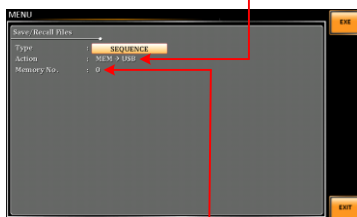

Memory No. 0 selected

All Data Operation

8. Go back to the *Type* setting using the scroll wheel and press *Enter*. Select *All Data* and press *Enter* to confirm.
9. Go to the *Action* setting and choose the file operation and then press *Enter*.

MEM→USB	Saves all the files including Preset, Sequence, Simulate and ARB from the local memory to a USB flash drive.
---------	--

MEM←USB	Loads all the files including Preset, Sequence, Simulate and ARB from a USB flash drive to the local memory.
Delete	Deletes (Recall Default) all the files including Preset, Sequence, Simulate and ARB from local memory.

Example

All Data option selected

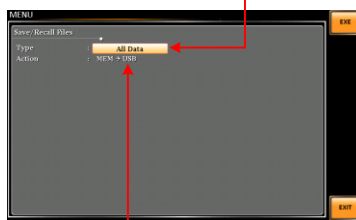

Save all data from  
Local memory to USB

### Default Sequence Setting

SEQ6 Momentary drop in supply voltage

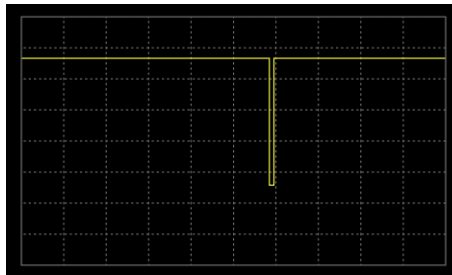

SEQ7     Reset test for Level1 systems with 12V

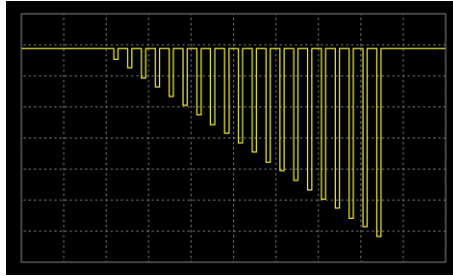

SEQ8     Starting Profile

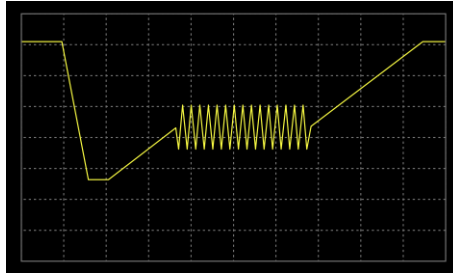

SEQ9     Test2 Tr: 10ms, Td: 40ms

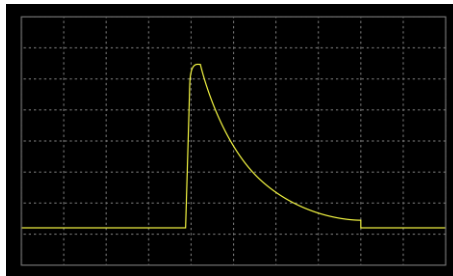

## Running a Sequence

**Background** When running a sequence, the display changes to the sequence run view.

**Run Screen Overview**

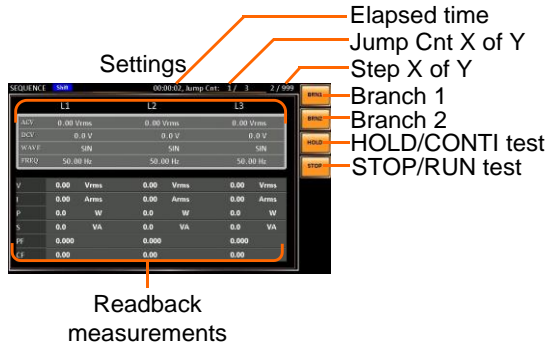

**Steps**

1. Press *Output*.



2. Press *RUN[F4]* key. The test will start to run.

The settings of current step will be shown at the top of the screen and the measurement readout will be shown on the bottom of the screen.

The top-right of the screen will display the current step number by the total number of steps (current step/total steps).

3. The test will continue to run until the last step has run, or *Stop[F4]* key is pressed. When the test has finished/stopped, the screen will return to the original settings screen.
4. If any of the steps have a conditional branch configured, the branch can be manually evoked during run time by pressing the *BRN1[F1]* soft-key (branch 1) or the *BRN2[F2]* soft-key (branch 2).

---

2). Alternatively the `:TRIG:SEQ:SEL:EXEC` command can also be used evoke a conditional branch.

---

Hold Test            5. To pause the test mid-way, press *HOLD*[F3] key.

---

Continue Test        6. To continue a paused test, press *CONTI*[F3] key.

---



Note

- The time of both Jump Cnt and Elapsed time will be normal when Step time is greater than 1 second.
- When Jump Cnt is set 0, it appears Inf in display.

# Simulate Mode

## Simulate Mode Overview

**Background** The Simulate function, which works in AC+DC-INT mode only, is used to test power supply fluctuation. This function is able to simulate common abnormalities in mains power such as fluctuations in voltage, phase and frequency. These simulations can be run as one-off anomalies or cyclic anomalies.

 **Note** Only one group of parameters setting can be configured under 1P2W, 1P3W and 3P4W output modes. That is to say, the output waveforms of L1, L2 and L3 will be symmetrically identical.

**Setting Screen Overview**

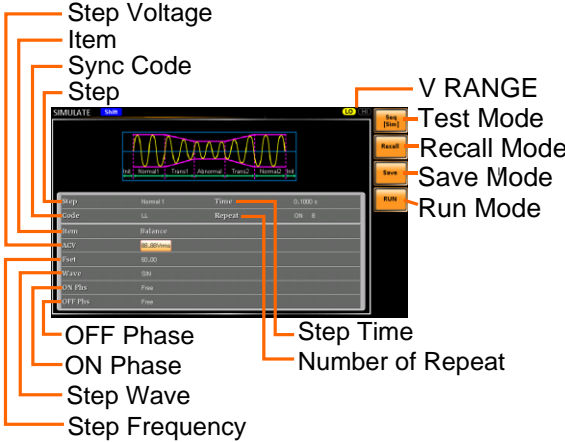

The screenshot shows the 'SIMULATE' screen with a waveform display at the top. Below the display is a table of settings:

Step	Normal 1	Time	0.1000 s
Code	LL	Repeat	ON 8
Item	Balance		
ACV	0.0000		
PHI	0.00		
FRQ	50.0		
ON PHA	Free		
OFF PHA	Free		

Control buttons on the right include: Run (with a 'Run' label), Recall, Save, and RUN. Labels with arrows point to various elements: Step Voltage Item, Sync Code, Step, V RANGE, Test Mode, Recall Mode, Save Mode, Run Mode, OFF Phase, ON Phase, Step Wave, Step Frequency, Step Time, and Number of Repeat.

**Step Overview** The Simulate function is comprised of 6 steps. Each step is run sequentially in the following order: Initial, Normal1, Trans1, Abnormal, Trans2, Normal2 and Initial.

Initial	The Initial step is used as the initial and final settings of the waveform simulation. This is the standby step before the test starts and the standby step after the test ends.
Normal1	This step configures the normal output conditions that precede the abnormal conditions.
Trans1	This step configures the transition from normal to abnormal conditions. This step will linearly interpolate the normal settings to the abnormal settings. This step can be skipped for abrupt state changes.
Abnormal	This step contains the abnormal conditions for the simulation.
Trans2	This step configures the transition from abnormal to normal conditions.
Normal2	This step configures the normal conditions that supersede the abnormal conditions.

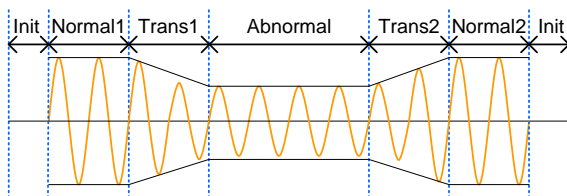

**Parameter Overview**

The following table shows which parameters are available for each step.

Step\Parameter	Initial	Normal1	Trans1	Abnormal	Trans2	Normal2
Time	X	✓	✓	✓	✓	✓
Code	✓	✓	✓	✓	✓	✓
Repeat	✓	✓	✓	✓	✓	✓
Item	✓	✓	✓	✓	✓	✓



ACV	✓	✓	X	✓	X	X
Fset	✓	✓	X	✓	X	X
Wave	✓	✓	X	✓	X	X
ON Phs	✓	✓	X	✓	X	✓
OFF Phs	✓	✓	X	✓	X	✓

**Time**      Sets the duration time of the step. When the ON Phs=ON, the total duration of the step is equal to the Time setting + ON Phs=ON duration.

**Code**      Sets the synchronous code including LL, LH, HL and HH for the duration of the step.

**Repeat**    Indicates the number of times the simulation will be run, from Normal1 to Normal2.  
  
A value of 0 indicates infinite repeats. The repeat setting is the same for each step.

**Item**      Sets the outputting phase of the step. It's fixed to balance.

**ACV**      Sets the voltage of the step.

**Fset**      Sets the frequency of the step.

**Wave**     Sets the outputting waveform of the step. It's fixed in SIN.

**ON Phs**    Sets the starting phase of the waveform for the step.

**OFF Phs**   Sets the off phase of the waveform after the output has been turned off.

The following diagram illustrates the relationship between each of the parameters in a step.

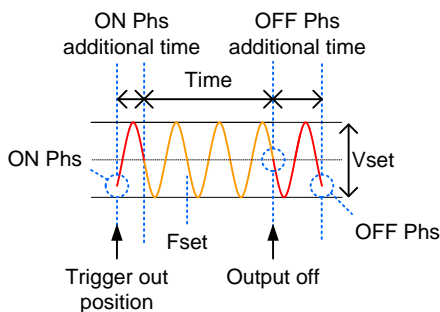

**Note** After entering the SIM Mode, It will forcibly set Remote Sense OFF.

## Simulate Settings

Entering the Simulate Menu

1. Press *Test* key.

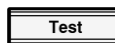

Alternatively, it is available to navigate, with scroll wheel, to the *TEST SIM...* option followed by pressing the *Enter* key to enter the *SIMULATE* menu.



2. Press *Seq/Sim[F1]* key to toggle to the *SIMULATE* Mode.

Steps

3. Use the scroll wheel to go to the *Step* setting and press *Enter*.
4. Use the scroll wheel to select one of the simulate steps and press *Enter*.

Steps	Initial, Normal1, Trans1, Abnormal, Trans2, Normal2
-------	---

- Go to the *Time* setting and set the duration of the step.

Time	0.0001 ~ 9999.9999s (Normal1, Normal2 and Abnormal)
	0.0000 ~ 9999.9999s (Trans1 and Trans2)

Note: For Trans1 and Trans2, it supports a value of 0, which will skip the step.

- Go to the *Code* setting and set the synchronous code of the step.

Code	LL, LH, HL, HH
------	----------------

- Go to the *Repeat* parameter select the number of times the simulation will repeat the Normal1-Trans1-Abnormal-Trans2-Normal2 sequence of steps. A value of 0 will set the number of repetitions to infinite.

Repeat	1 ~ 9999, 0(infinite)
--------	-----------------------

- Go to the *ACV* setting and set the Vrms level of the step. If you input an ACV value that is not within the voltage range, the warning message below will be shown. Not applicable for Trans1, Trans2 and Normal2.

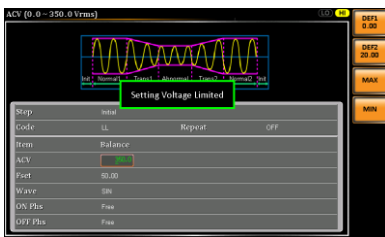

ACV	0.0 ~ 175.0 (Range 100V)
	0.0 ~ 350.0 (Range 200V)

9. Go to the *Fset* setting set the frequency of step. If you input a frequency value that is not within the range, the warning message below will be shown. Not applicable for Trans1, Trans2 and Normal2.

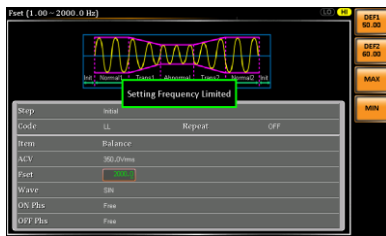

---

Fset            1.00 ~ 2000.0Hz

---

10. Go to the *ON Phs* setting and set the starting phase of the step. Not applicable for Trans1 and Trans2.

---

ON Phase      Free, Fixed

---

ON Phase      0.0 ~ 359.9°

---

Resolution     0.1°

---

11. Lastly, go to the *OFF Phs* setting and set the end phase of the step. Not applicable for Trans1 and Trans2.

---

OFF Phase     Free, Fixed

---

OFF Phase     0.0 ~ 359.9°

---

Resolution     0.1°

---

## Save a Simulation to Local Memory

---

Saving a Simulation      Simulation settings can be saved to one of 10 memory slots (SIM0 ~ SIM9).

- Steps
1. Press *Save*[F3] key firstly.
  2. A list of memory slots prompts where it is available to use scroll wheel followed by pressing *Enter* to execute save action.
  3. A prompt message will appear when the save action is successful.

---

Save                      SIM0 ~ SIM9

## Recall a Simulation from Local Memory

---

Recall a Simulation      Simulation settings can be recalled from one of 10 memory slots (SIM0 ~ SIM9).

- Steps
1. Press *Recall*[F2] key firstly.
  2. A list of memory slots prompts where it is available to use scroll wheel followed by pressing *Enter* to execute recall action.
  3. A message will appear when the settings are recalled successfully.

---

Recall                      SIM0 ~ SIM9

## Manage Simulation Settings

Simulation settings can be easily saved to or from a USB flash drive using the Save/Recall Files utility in the Menu system. Files can also be deleted from local memory using the utility.

---

File Format	<p>When files are saved to USB they are saved in the following format: SIMX. SIM, where X is the memory number 0 ~ 9 (SIM0 ~ SIM9). The files are saved to USB:/gw.</p> <p>When files are recalled from USB, files must be recalled from the same memory number. For example, the file sim0.sim can only be recalled to memory number SIM0. The files can only be recalled from the USB:/gw directory.</p>
-------------	--

---

- |       |   |
|-------|---|
| Steps | <ol style="list-style-type: none"> <li>1. Press the <i>Menu</i> key. The Menu settings will appear on the display. </li> <li>2. Use the scroll wheel to go to item 12, <i>Save/Recall Files</i> and press <i>Enter</i>.</li> <li>3. Go to the <i>Type</i> setting using the scroll wheel and press <i>Enter</i>. Select <i>SIMULATE</i> and press <i>Enter</i> to confirm.</li> <li>4. Go to the <i>Action</i> setting and choose the file operation and then press <i>Enter</i>.</li> </ol> |
|-------|---|
- 

MEM→USB	Saves the selected simulation memory from the local memory to a USB flash drive.
---------	--

---

MEM←USB	Loads the simulation memory from a USB flash drive to the selected local memory.
---------	--

---

Delete	Deletes (Recall Default) the selected simulation memory from local memory.
--------	--

- Go to the *Memory No.* setting and select the simulation memory number to perform the operation on. Press *Enter* to confirm.

Memory No.	0 ~ 9 (SIM0 ~ SIM9)
------------	---------------------

Execute File Operation

- Press *EXE[F1]* key to perform the file operation.



Exit

- Press *EXIT[F4]* key to exit from the *Save/Recall Files* settings.



Example

Saves files from Local memory to USB

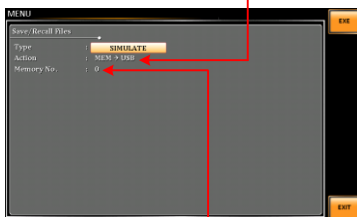

Memory No. 0 selected

All Data Operation

- Go back to the *Type* setting using the scroll wheel and press *Enter*. Select *All Data* and press *Enter* to confirm.
- Go to the *Action* setting and choose the file operation and then press *Enter*.

MEM→USB	Saves all the files including Preset, Sequence, Simulate and ARB from the local memory to a USB flash drive.
---------	--

---

MEM←USB	Loads all the files including Preset, Sequence, Simulate and ARB from a USB flash drive to the local memory.
Delete	Deletes (Recall Default) all the files including Preset, Sequence, Simulate and ARB from local memory.

---

Example

All Data option selected

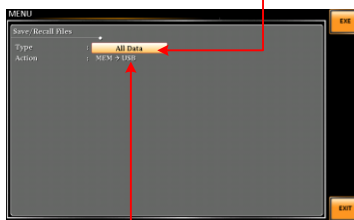

Save all data from  
Local memory to USB



## Running a Simulation

**Background** When running a simulation, the display changes to the simulate run view.

**Run Screen Overview**

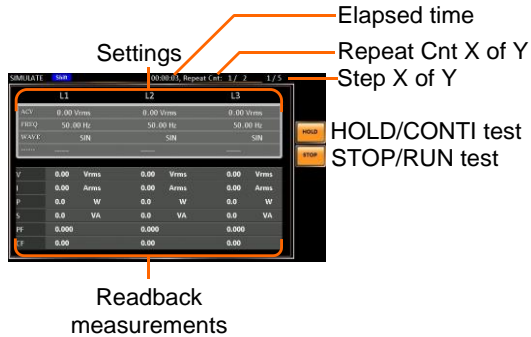

**Steps**

1. Press *Output* key.



2. Press *Run[F4]* key. The test will start to run.

The settings of current step will be shown at the top of the screen and the measurement readout will be shown on the bottom of the screen.

The top-right of the screen will display the current step number of the simulation.

1/5 = Normal1

2/5 = Trans1

3/5 = Abnormal

4/5 = Trans2

5/5 = Normal2

3. The test will continue to run until the last repeat step has run, or *Stop[F4]* key is pressed or the output is turned off\*. When the test has finished/stopped, the screen will return to the original settings screen.

\* If the OFF-phase has been set, the output will continue until the OFF-phase setting is satisfied.

Hold Test            4. To pause the test mid-way, press *HOLD[F3]* key.

Continue Test        5. To continue a paused test, press *CONTI[F3]* key.

---



Note

- The time of both Repeat Cnt and Elapsed time will be normal when Step time is greater than 1 second.
- When Repeat Cnt is set 0, it appears Inf in display.

# C

# COMMUNICATION

# INTERFACE

This chapter describes basic configuration of IEEE488.2 based remote control. For a command list, refer to the programming manual, downloadable from GW Instek website, [www.gwinstek.com](http://www.gwinstek.com)



Note

If the instrument is remotely controlled via the USB/LAN/RS232/GPIB/DeviceNet/CAN BUS interface, the panel lock is automatically enabled.

---

<b>Interface Configuration .....</b>	<b>220</b>
Ethernet Remote Interface .....	220
USB Remote Interface.....	221
USB Remote Control Function Check .....	222
RS-232 Remote Interface .....	223
RS232 Remote Control Function Check .....	226
Using Realterm to Establish a Remote Connection	227
GPIB Remote Interface (Optional) .....	230
GPIB Function Check .....	231
DeviceNet Remote Interface (Optional) .....	234
CAN BUS Remote Interface (Optional) .....	235
Web Server Remote Control Function Check .....	236
Socket Server Function Check .....	237

## Interface Configuration

### Ethernet Remote Interface

The Ethernet interface can be configured for a number of different applications. Ethernet can be configured for basic remote control or monitoring using a web server or it can be configured as a socket server.

The ASR-6000 supports both DHCP connections so the instrument can be automatically connected to an existing network or alternatively, network settings can be manually configured.

Ethernet Parameters	Connection Status(display only)	MAC (display only)
	DHCP	IP Address
	Subnet Mask	Gateway
	DNS	Socket Port (display only)
	Web Password	

#### Ethernet Configuration

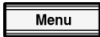
1. Connect a LAN cable from the PC to the Ethernet port on the rear panel. 
2. Press the *Menu* key. The Menu setting will appear on the display. 
3. Use the scroll wheel to go to item 3, *LAN* and press *Enter*.
4. If the LAN cable is installed correctly a connection is active, the *Connection Status* will show *Online*.
5. To automatically have the network assign an IP address, set DHCP to ON. Otherwise set DHCP to OFF to manually set the Ethernet settings.



Steps

1. Connect the Type A-Type B USB cable from the PC to the rear panel USB B port.



2. Press the *Menu* key. The Menu setting will appear on the display.



3. Use the scroll wheel to go to item 4, *USB Device*.
4. If the connection is successful *Connection Status* will change from Offline to Online.

### USB configuration



Exit

5. Press *Exit*[F8] to exit from the rear panel USB settings.



## USB Remote Control Function Check

Functionality  
Check

Invoke a terminal application such as Realterm.  
ASR-6000 will appear as a COM port on the PC.  
To check the COM settings in Windows, see the Device Manager. For example, in Win10 go to the Control panel → System → Hardware tab.



Note

If you are not familiar with using a terminal application to send/receive remote commands via a USB connection, please see page 227 for more information.

Run this query command via the terminal after the instrument has been configured for USB remote control (page 221).

\*IDN?

This should return the Manufacturer, Model number, Serial number, and Software version in the following format.

GW-INSTEK, ASR-6XXX, GXXXXXXXXX, XX.XX

Manufacturer: GW-INSTEK

Model number : ASR-6XXX

Serial number : GXXXXXXXXX

Software version : XX.XX



Note

For further details, please see the programming manual, available on the GW Instek web site @ [www.gwinstek.com](http://www.gwinstek.com).

### RS-232 Remote Interface

RS-232 Configuration	Connector	BD-9, male
	Parameters	Baud rate, data bits, parity, stop bits.

Pin Assignment		2: RxD (Receive data)
		3: TxD (Transmit data)
		5: GND
		4, 6 ~ 9: No connection

Pin Connection Use a Null Modem connection (RS-232 cable) as shown in the diagram below.

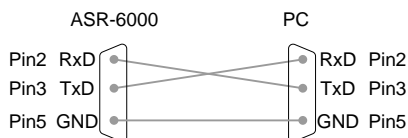

**Steps**

1. Connect the RS-232C cable from the PC to the rear panel RS-232 port.



2. Press the *Menu* key. The Menu setting will appear on the display.



3. Use the scroll wheel to go to item 5, RS232C and press *Enter*.

4. Set the RS232C relative settings.

Baud rate	1200, 2400, 4800, 9600(default), 19200, 38400, 57600, 115200,
-----------	--

Data bits	7 bits, 8 bits(default)
-----------	-------------------------

Parity	None(default), Odd, Even
--------	--------------------------

Stop bits	1 bit(default), 2 bits
-----------	------------------------

**RS232C Configuration**

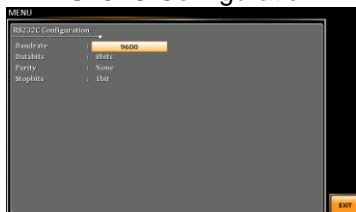

**Exit**

5. Press *Exit[F8]* to exit from the RS232C settings.







Note

The standard accessory does Not include RS232 data cable. Please purchase the additional GTL-232 which will meet your need for RS232 connection.

---

## RS232 Remote Control Function Check

---

Functionality Check	<p>Invoke a terminal application such as Realterm.</p> <p>For RS-232, set the COM port, baud rate, stop bit, data bit and parity accordingly.</p> <p>To check the COM settings in Windows, see the Device Manager. For example, in Win10 go to the Control panel → System → Hardware tab.</p>
---------------------	---

---



Note

If you are not familiar with using a terminal application to send/receive remote commands from the serial port, please see page 227 for more information.

---

Run this query command via the terminal after the instrument has been configured for RS-232 remote control (page 223).

\*IDN?

This should return the Manufacturer, Model number, Serial number, and Software version in the following format.

GW-INSTEK, ASR-6XXX, GXXXXXXXXX, XX.XX

Manufacturer: GW-INSTEK

Model number : ASR-6XXX

Serial number : GXXXXXXXXX

Software version : XX.XX

---



Note

For further details, please see the programming manual, available on the GW Instek web site @ [www.gwinstek.com](http://www.gwinstek.com).

---

## Using Realterm to Establish a Remote Connection

---

**Background** Realterm is a terminal program that can be used to communicate with a device attached to the serial port of a PC or via an emulated serial port via USB.

The following instructions apply to version 2.0.0.70. Even though Realterm is used as an example to establish a remote connection, any terminal program can be used that has similar functionality.

---



Note

Realterm can be downloaded on Sourceforge.net free of charge.

For more information please see <http://realterm.sourceforge.net/>

---

- Operation**
1. Download Realterm and install according to the instructions on the Realterm website.
  2. Connect the ASR-6000 via USB (page 220) or via RS-232 (page 222).
  3. If using RS-232, make note of the configured baud rate, stop bits and parity.
  4. Go to the Windows device manager and find the COM port number for the connection. For example, go to the Start menu > Control Panel > Device Manager.

Double click the *Ports* icon to reveal the connected serial port devices and the COM port for the each connected device.

If using USB, the baud rate, stop bit and parity settings can be viewed by right-clicking the

connected device and selecting the *Properties* option.

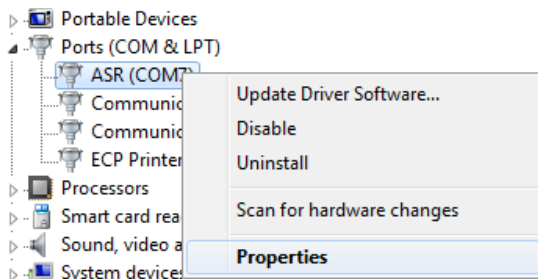

5. Start Realterm on the PC as an administrator.  
Click:  
Start menu>All Programs>RealTerm>realterm

Tip: to run as an administrator, you can right click the Realterm icon in the Windows Start menu and select the *Run as Administrator* option.

6. After Realterm has started, click on the *Port* tab.

Enter the *Baud*, *Parity*, *Data bits*, *Stop bits* and *Port* number configuration for the connection.

The *Hardware Flow Control*, *Software Flow Control* options can be left at the default settings.

Press *Open* to connect to the ASR-6000.

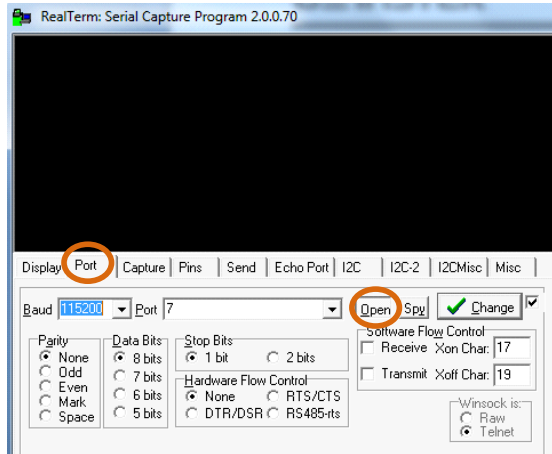

For USB, the baud rate should be fixed to 115,200.

7. Click on the *Send* tab.

In the *EOL* configuration, check on the *+LF* check boxes.

Enter the query:  
*\*idn?*

Click on *Send ASCII*.

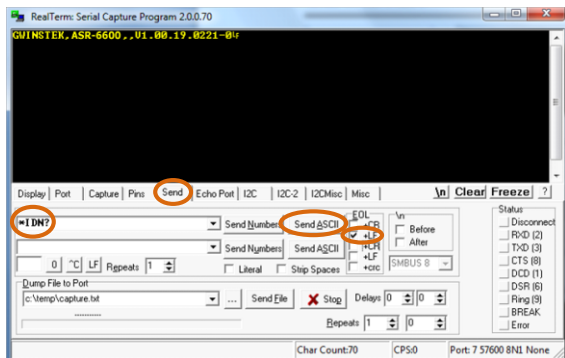

8. The terminal display will return the following:

GW-INSTEK, ASR-6XXX, GXXXXXXXXX, XX.XX  
 (manufacturer, model, serial number, software version)

9. If Realterm fails to connect to the ASR-6000, please check all the cables and settings and try again.

### GPIB Remote Interface (Optional)

#### GPIB Configuration

1. Connect a GPIB cable from the PC to the GPIB port on the rear panel.



2. Press the *Menu* key. The Menu setting will appear on the display.

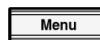

3. Use the scroll wheel to go to item 6, *Option Interface* and press *Enter*.

4. Set the GPIB address.

GPIB Address            0 ~ 30 (10 by default)

#### GPIB Configuration

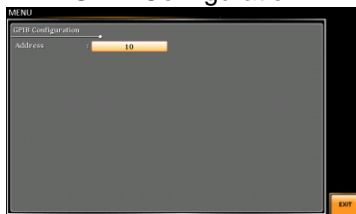

 **Note**

- Only one GPIB address can be used at a time.
- ASR-6000 series can detect optional interface card automatically and the corresponding option interface page will be displayed accordingly.

Exit	5. Press <i>Exit</i> [F8] to exit from the GPIB settings.	
------	---	---

- |                  |  |
|------------------|--|
| GPIB Constraints | <ul style="list-style-type: none"> <li>• Maximum 15 devices altogether, 20m cable length, 2m between each device</li> <li>• Unique address assigned to each device</li> <li>• At least 2/3 of the devices turned On</li> <li>• No loop or parallel connection</li> </ul> |
|------------------|--|

 Note	The standard accessory does Not include GPIB data cable. Please purchase the additional GTL-248 which will meet your need for GPIB connection.
--	--

### GPIB Function Check

---

Functionality Check	Please use the National Instruments Measurement & Automation Controller software to confirm GPIB/LAN functionality.
---------------------	---

See the National Instrument website, <http://www.ni.com> for details.

- |  |  |
|--|--|
|  Note | <ul style="list-style-type: none"> <li>• For further details, please see the programming manual, available on the GW Instek web site @ <a href="http://www.gwinstek.com">www.gwinstek.com</a></li> <li>• Operating System: Windows XP, 7, 8, 10</li> </ul> |
|--|--|

Operation	1. Start the NI Measurement and Automation Explorer (MAX) program. Using Windows, press:	
-----------	--	---

*Start>All Programs>NI MAX*



2. From the Configuration panel access;  
My System>Devices and Interfaces>GPIB0
3. Press the *Scan for Instruments* button.
4. In the *Connected Instruments* panel the ASR-6000 should be detected as *Instrument 0* with the address the same as that configured on the ASR-6000.
5. Double click the *Instrument 0* icon.

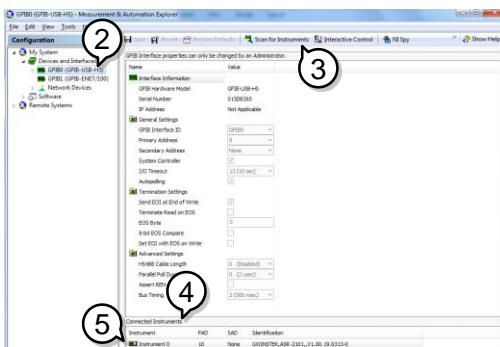



6. Click on *Communicate with Instrument*.
7. Under the Communicator tab, ensure *\*IDN?* is written in the *Send String* text box.
8. Click on the *Query* button to send the *\*IDN?* query to the instrument.
9. The instrument identification string will be returned to the buffer area:  
 GW-INSTEK, ASR-6XXX, GXXXXXXXXX, XX.XX  
 (manufacturer, model, serial number, software version)

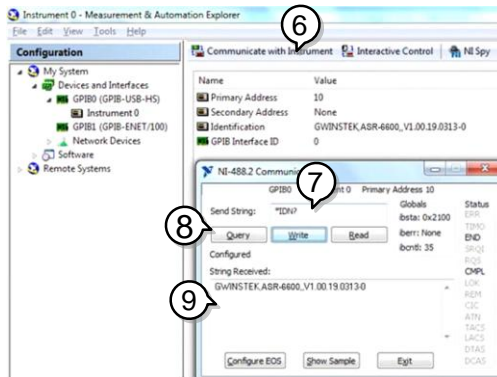

10. The function check is complete.





Note

- All product information related to NI-VISA belongs to NATIONAL INSTRUMENTS CORP.
- For using NI-VISA, please link to NATIONAL INSTRUMENTS CORP website to download and install it.
- When using NI-VISA, please be aware of the relevant license terms of NATIONAL INSTRUMENTS CORP.

## DeviceNet Remote Interface (Optional)

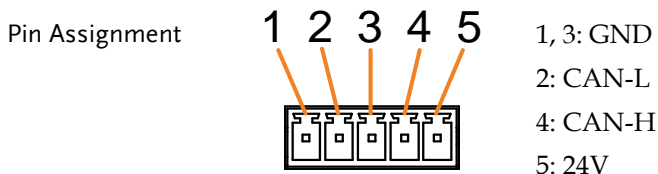
DeviceNet Configuration	Connector Parameters	Block terminal, 5 pins, male Baudrate, MAC ID.
-------------------------	----------------------	---



- Steps
1. Press the *Menu* key. The Menu setting will appear on the display. 
  2. Use the scroll wheel to go to item 6, *Option Interface* and press *Enter*.
  3. Set the DeviceNet relative settings.
 

Baudrate	125K(default), 250K, 500K, Auto
MAC ID	0 ~ 63 (63 is default value)

- Exit
4. Press *Exit[F8]* to exit from the DeviceNet settings. 

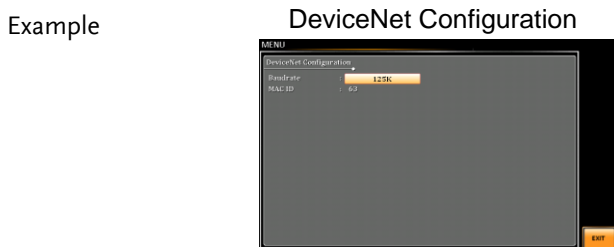



 **Note** For further details, please refer to the DeviceNet Programming Manual.

### CAN BUS Remote Interface (Optional)

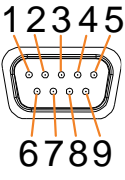
CAN BUS Configuration	Connector	BD-9, male
	Parameters	Protocol, Baudrate, Node ID

Pin Assignment		2: CAN-L 3, 5: GND 7: CAN-H 1, 4, 6, 8, 9: No connection
----------------	---	---

- Steps**
1. Press the *Menu* key. The Menu setting will appear on the display. 
  2. Use the scroll wheel to go to item 6, *Option Interface* and press *Enter*.
  3. Set the CAN BUS relative settings.
 

Protocol	Canopen
Baudrate	125K(default), 250K, 500K, 1M, Auto
MAC ID	1 ~ 127 (127 is default value)
- Exit**
4. Press *Exit[F8]* to exit from the CAN BUS settings. 

#### CAN BUS Configuration

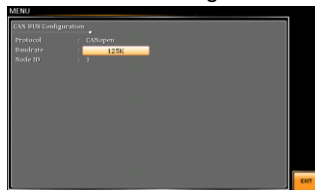

For further details, please refer to the CAN BUS Programming Manual.

## Web Server Remote Control Function Check

### Functionality Check

Enter the IP address of the power supply (for example: `http://XXX.XXX.XXX.XXX`) in a web browser after the instrument has been configured for LAN (page 220).

The web interface allows you to:

- View the system and information and the network configuration.

### Example:



## Socket Server Function Check

---

**Background** To test the socket server functionality, National Instruments Measurement and Automation Explorer can be used. This program is available on the NI website, [www.ni.com](http://www.ni.com), via a search for the VISA Run-time Engine page, or “downloads” at the following URL, <http://www.ni.com/visa/>

---

**Requirements** Operating System: Windows XP, 7, 8, 10

---

**Functionality Check** 1. Start the NI Measurement and Automation Explorer (MAX) program. Using Windows, press:

*Start>All Programs>NI MAX*



2. From the Configuration panel access;

*My System>Devices and Interfaces>Network Devices*

3. Press *Add New Network Device>Visa TCP/IP Resource...*

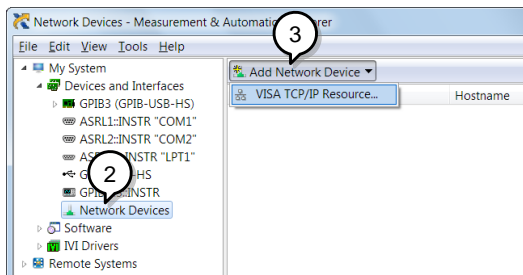

4. Select *Manual Entry of Raw Socket* from the popup window.

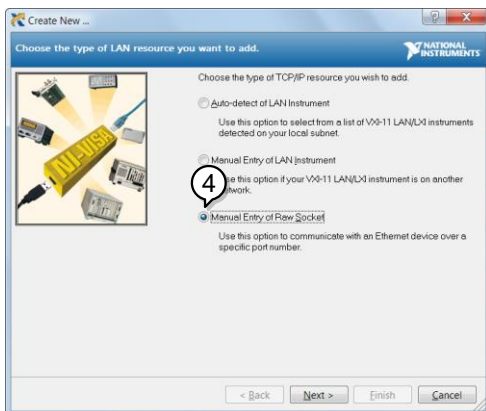

5. Enter the IP address and the port number of the ASR-6000. The port number is fixed at 5025.
6. Double click the Validate button and press *Next*.

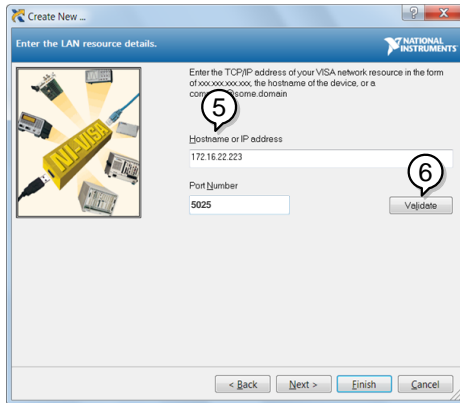

7. Next configure the Alias (name) of the ASR-6000 connection. In this example the Alias is: ASR
8. Click finish.

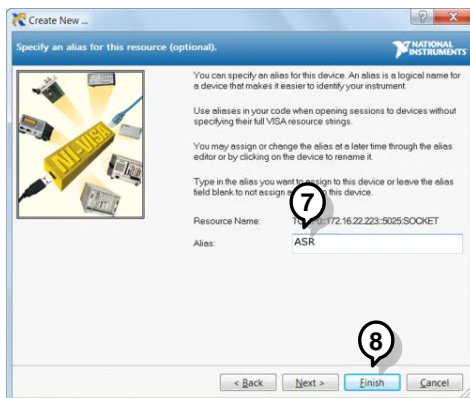

9. The IP address of the power supply will now appear under Network Devices in the configuration panel. Select this icon now.
10. Press *Open VISA Test Panel*.

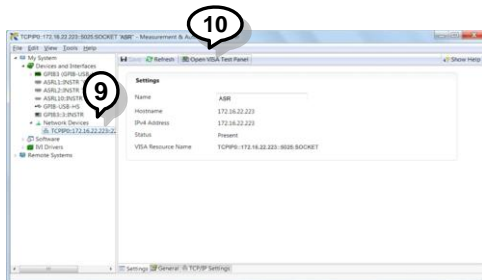

11. Click the *Configuration* Icon. Under the *IO Settings* tab check *Enable Termination Character*. The termination character should be set as *Line Feed - \n*.

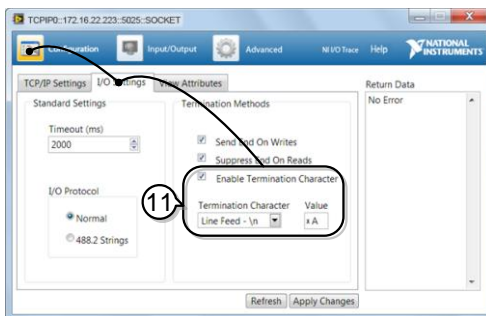

12. Click the *Input/Output* icon. Under the *Basic I/O* tab, make sure *\*IDN?\n* is entered in the *Select or Enter Command* drop box.
13. Click *Query*.

The ASR-6000 will return the machine identification string into the buffer area:

GW-INSTEK, ASR-6XXX, GXXXXXXXXX, XX.XX



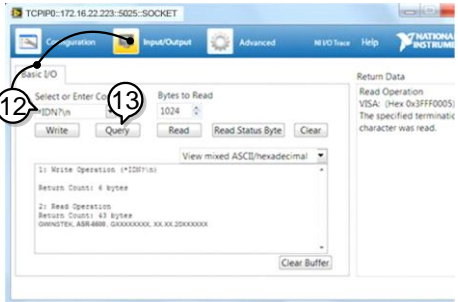

Note

For further details, please see the programming manual, available on the GW Instek web site @ [www.gwinstek.com](http://www.gwinstek.com).

# FAQ

---

- The accuracy does not match the specification.
- How frequently should the power source be calibrated?

The accuracy does not match the specification.

---

Make sure the device is powered On for at least 30 minutes, within +18°C~+28°C. This is necessary to stabilize the unit to match the specification.

How frequently should the power source be calibrated?

---

The ASR-6000 should be calibrated by an authorized service center at least every 2 years.

For details regarding calibration, contact your local dealer or GWInstek.

# APPENDIX

## Firmware Update

**Background** The ASR series firmware can be upgraded using the USB A port on the front panel. See your local distributor or the GW Instek website for the latest firmware information.



Note

- Ensure the DUT is not connected.
- Ensure the output is off.

### Steps

1. Insert a USB Flash Drive into the USB port on front panel of the ASR.  
The USB drive should include the **gw\_sb6.upg** file in a directory name “gw”(USB\gw:).
2. Press the *Menu* key. The Menu setting will appear on the display. 
3. Use the scroll wheel to go to item 11, *Special Function* and press *Enter*.

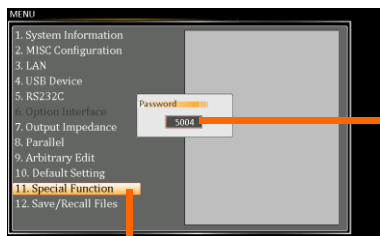

Enter  
Password

Special Function

4. Key in the password when prompted and then press *Enter*.  
The password is “5004”.
5. Go to Item 1, *Update Firmware* and press *Enter*.

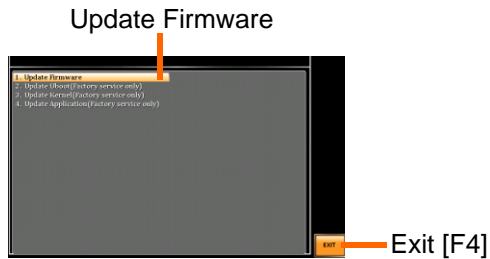

6. Wait for the unit to update. Upon completion the unit will automatically reboot.
-

## Factory Default Settings

The following default settings are the factory configuration settings for the ASR-6000 series. For details on how to return to the factory default settings, see page 65.

Continuous Mode	ASR-6450		ASR-6600	
	3P4W	1P2W	3P4W	1P2W
MODE	AC+DC-INT		AC+DC-INT	
Range	100V		100V	
ACV	0.00 Vrms		0.00 Vrms	
DCV	+0.00 Vdc		+0.00 Vdc	
FREQ	50.00Hz		50.00 Hz	
IRMS	15.75 A	47.25 A	21 A	63 A
ON Phs	Fixed 0.0°		Fixed 0.0°	
OFF Phs	Fixed 0.0°		Fixed 0.0°	
GAIN	100		100	
SIG	L1 LINE		L1 LINE	
Syc Phs	0.0		0.0	
SRC	L1 EXT		L1 EXT	
Wave	SIN		SIN	
Freq Limit	2000		2000	
Vrms Limit	175.0 Vrms		175.0 Vrms	
VPK+ Limit	+250 V		+250 V	
VPK- Limit	-250 V		-250 V	
IPK+ Limit	+63.00 A	+189.00 A	+84.00 A	+252.00 A
IPK- Limit	-63.00 A	-189.00 A	-84.00 A	-252.00 A

<b>MISC Configuration</b>	<b>ASR-6450</b>	<b>ASR-6600</b>
T peak , hold(msec)	1	1
Phase Mode	Unbalance	Unbalance
Peak CLR	ALL	ALL
Power ON	OFF	OFF
Buzzer	ON	ON
Remote Sense	OFF	OFF
V Response	Medium	Medium
Output Relay	Enable	Enable
THD Format	IEC	IEC
External Control	OFF	OFF
V Unit(TRI,ARB)	rms	rms
Set Change Phase	OFF	OFF
Monitor Output1	L1 Voltage	L1 Voltage
Monitor Output2	L1 Current	L1 Current
Monitor Output Amp	±2.5	±2.5
TrgOut Width(ms)	0.1	0.1
TrgOut Source	L1	L1
Re-Lock	ON	ON
Data Average Count	8	8
Data Update Rate	Fast	Fast

<b>LAN</b>	<b>ASR-6450</b>	<b>ASR-6600</b>
DHCP	ON	ON

<b>USB Device</b>	<b>ASR-6450</b>	<b>ASR-6600</b>
Speed	Full	Full
Mode	TMC	TMC

RS232C	ASR-6450	ASR-6600
Baudrate	9600	9600
Databits	8bits	8bits
Parity	None	None
Stopbits	1bit	1bit

GPIB	ASR-6450	ASR-6600
Address	10	10

CAN BUS	ASR-6450	ASR-6600
Baudrate	125K	125K
Node ID	127	127

DeviceNet	ASR-6450	ASR-6600
Baudrate	125K	125K
MAC ID	63	63

Output Impedance	ASR-6450	ASR-6600
Output Impedance	OFF	OFF
L1 Output Inductance	0.1 $\mu$ H	0.1 $\mu$ H
L2 Output Inductance	0.1 $\mu$ H	0.1 $\mu$ H
L3 Output Inductance	0.1 $\mu$ H	0.1 $\mu$ H
L1 Output Resistance	0.1 $\Omega$	0.1 $\Omega$
L2 Output Inductance	0.1 $\Omega$	0.1 $\Omega$
L3 Output Inductance	0.1 $\Omega$	0.1 $\Omega$

<b>Sequence Mode</b>	<b>ASR-6450</b>			<b>ASR-6600</b>		
Step	0			0		
Time	0.1000 s			0.1000 s		
Jump To	OFF			OFF		
Jump Cnt	1			1		
Branch 1	OFF			OFF		
Branch 2	OFF			OFF		
Term	CONTI			CONTI		
Sync Code	LL			LL		
Item	L1	L2	L3	L1	L2	L3
ACV	0.00, CT	0.00, CT	0.00, CT	0.00, CT	0.00, CT	0.00, CT
DCV	0.00, CT	0.00, CT	0.00, CT	0.00, CT	0.00, CT	0.00, CT
Fset	50.0 , CT	50.0 , CT	50.0 , CT	50.0 , CT	50.0 , CT	50.0 , CT
Wave	SIN	SIN	SIN	SIN	SIN	SIN
ON Phs	Free	Free	Free	Free	Free	Free
OFF Phs	Free	Free	Free	Free	Free	Free
Phase	Fixed (0)	120	240	Fixed (0)	120	240

<b>Simulate Mode</b>	<b>ASR-6450</b>			<b>ASR-6600</b>		
Step	Initial			Initial		
Repeat	OFF			OFF		
Time	0.1000 s			0.1000 s		
Term	Free			Free		
Code	LL			LL		
Item	L1	L2	L3	L1	L2	L3
ACV	0.00	0.00	0.00	0.00	0.00	0.00
Fset	50.00	50.00	50.00	50.00	50.00	50.00
Wave	SIN	SIN	SIN	SIN	SIN	SIN
ON Phs	Free	Free	Free	Free	Free	Free
OFF Phs	Free	Free	Free	Free	Free	Free



## Error Messages & Messages

The following error messages or messages may appear on the ASR-6000 screen display during varied operations.

Normal Messages	Description	Protection type
Keys Locked	All of keys are locked, except output key, long push "Lock" to disable Keys Locked	Display Message Only
Keys Unlocked	All of keys are unlocked	Display Message Only
Invalid with Remote Control	All of keys are locked, except Output and Shift and Local Key, press "Shift + 0" to disable Remote Control	Display Message Only
Invalid with Remote Lock Control	All of keys including Output and Local Keys are locked.	Display Message Only
Invalid in This Meter Frozen	Invalid Operation In This Meter Frozen, press "F8" to disable Meter Frozen	Display Message Only
Invalid in This Page	Invalid Operation In This Page. Valid main and simple page for preset mode.	Display Message Only
Recalled From M#	Recalled Preset From M0 ~ M9	Display Message Only
Saved To M#	Saved Preset To M0 ~ M9	Display Message Only
Setting Voltage Limited	Setting voltage be limited, press "shift + V" to check allowance set range	Display Message Only
Setting Frequency Limited	Setting frequency be limited, press "shift + F" to check allowance set range	Display Message Only
Setting Phase Limited	Setting ON/OFF Phase Limited	Display Message Only
Setting Duty Limited	Setting Duty be limited	Display Message Only
Invalid with Output ON	Invalid with Output ON	Display Message Only
Rear USB Port Connected To PC	Rear USB port connected to PC	Display Message Only

Rear USB Port Disconnected From PC	Rear USB port disconnected from PC	Display Message Only
Resetting...	Ready For Recall Factory Default	Display Message Only
Failed Factory Default	Recall Factory Default Failed	Display Message Only
Error Password	Input Error Password	Display Message Only
USB Memory Unconnected	Could not detect USB memory, please connect a USB memory.	Display Message Only
No File ([Filename]) in [directory]	Not find specific file in USB specific directory	Display Message Only
Saved to DEF1	Saved Setting to DEF1	Display Message Only
Saved to DEF2	Saved Setting to DEF2	Display Message Only
Preset Mode	Operation at preset mode	Display Message Only
Exit Preset Mode	Exit preset mode	Display Message Only
Meter Frozen	Operation at Meter Frozen mode, all measure value will stop update.	Display Message Only
Only AC-INT and 50/60Hz Active	Harmonic Page Limit Message	Display Message Only
Configure Phase Toggle, Please wait...	Configure Phase Toggle	Display Message Only
[Filename] Saved Success	Save file to USB success message. [Filename] ex Preset0.Set or SEQ0.SEQ or SIM0.SIM or ARB1.ARB	Display Message Only
[Filename] Saved Fail	Save file to USB fail message	Display Message Only
[Filename] Recalled Success	Recalled file success message	Display Message Only
[Filename] Recall Fail (No File in [directory])	Recall file fail message(not find specific file in USB specific directory)	Display Message Only
[Filename] Recall Fail (File Format Error)	Recall file fail message(file format error)	Display Message Only
[Filename] Recall Fail (File Data Error)	Recall file fail message(file Data error(Data out of Range) )	Display Message Only

Preset M# Deleted	Preset M0~M9 Deleted	Display Message Only
ARB# Deleted	ARB1~ARB253 Deleted	Display Message Only
Save All Data	Ready to save all data (Preset0~9 + SEQ0~9 + SIM0~9 + ARB1~253)	Display Message Only
All Data Saved Success	All data are saved successfully (Preset0~9 + SEQ0~9 + SIM0~9 + ARB1~253)	Display Message Only
Recall All Data	Ready to recall all data (Preset0~9 + SEQ0~9 + SIM0~9 + ARB1~253)	Display Message Only
All Data Recall Success	All data are recalled successfully (Preset0~9 + SEQ0~9 + SIM0~9 + ARB1~253)	Display Message Only
Delete All Data	Ready to delete all data (Preset0~9 + SEQ0~9 + SIM0~9 + ARB1~253)	Display Message Only
All Data Deleted	All data are deleted successfully (Preset0~9 + SEQ0~9 + SIM0~9 + ARB1~253)	Display Message Only
USB Memory Connected	Detect USB Memory connected	Display Message Only
USB Memory Access Error	Please check a FAT32-formatted USB memory, and Reinsert USB memory	Display Message Only
USB File Write Error!	Can not Save File to USB	Display Message Only
Screen Saved to USB:/GWDIMC###.bmp	Screenshot be saved to USB memory successful	Display Message Only
Hardcopy Fail!(Too Many Files in USB)	Hardcopy Fail !, Over 1000 files in USB	Display Message Only
Valid Only AC-INT, DC-INT and AC-Sync Mode		Display Message Only
Valid Only 100V and 200V Range	Remote Sense Setting Limit Message	Display Message Only
Valid Only SIN Wave Shape		Display Message Only
Saved To ARB#	Saved to ARB1 ~ ARB253	Display Message Only

Saved To ARB#,V-Limit Invalid	Saved to ARB1 ~ ARB253,V-Limit Invalid	Display Message Only
Saved To ARB#,V-Limit & Freq Invalid	Saved to ARB1 ~ ARB253,V-Limit and Freq Invalid	Display Message Only
Saved To ARB Fail	Failed to save ARB file, please check whether the file is correct	Display Message Only
Invalid in This Output Mode	This mode not support SEQ or SIM Valid Only AC+DC-INT, AC-INT and DC-INT Mode for SEQ Valid Only AC+DC-INT Mode for SIM	Display Message Only
Invalid For Auto Range	Auto range not allow SEQ/SIM, change the output range	Display Message Only
Invalid with Output OFF, Turn ON the Output First	The output offstate does not allow the execution, turn on the output first	Display Message Only
Invalid with Output ON, Turn OFF the Output First	The output onstate does not allow the execution, turn off the output first	Display Message Only
Invalid in This Sequence	Invalid Operation In This Sequence	Display Message Only
Invalid in This Simulate	Invalid Operation In This Simulate	Display Message Only
SEQ#Deleted	SEQ0~SEQ9 Deleted	Display Message Only
SIM#Deleted	SIM0~SIM9 Deleted	Display Message Only
Cleared SEQ#	Cleared SEQ0~SEQ9	Display Message Only
Cleared SIM#	Cleared SIM0~SIM9	Display Message Only
Recalled from SEQ#	Recalled fromSEQ0 ~ SEQ9	Display Message Only
Recalled from SIM#	Recalled fromSIM0 ~ SIM9	Display Message Only
Recall Fail!/Recall Data Fail!	SEQ0 ~ SEQ9or SIM0 ~ SIM9Recall Fail!	Display Message Only
Saved to SEQ#	Saved toSEQ0 ~ SEQ9	Display Message Only
Saved to SIM#	Saved toSIM0 ~ SIM9	Display Message Only

Save Fail!	SEQ0 ~ SEQ9 or SIM0 ~ SIM9 save fail!	Display Message Only
Sequence preparation...	Sequence preparation, please wait some time	Display Message Only
Sequence is ready.	Sequence is ready.	Display Message Only
Simulation preparation...	Simulation preparation, please wait some time	Display Message Only
Simulation is ready.	Simulation is ready.	Display Message Only
Alarm Clear Please Wait...	Alarm Clear Please Wait...	Display Message Only
Master Wait Connecting../Slave Wait Connecting..	Master or slave waits for parallel connection	Display Message Only
Valid Only Standalone	Output Impedance Valid Only Standalone	Display Message Only
CANopen Duplicate Node ID	CANopen Duplicate Node ID	Display Message Only
DeviceNet Duplicate Node ID	DeviceNet Duplicate Node ID	Display Message Only

# Specifications

The specifications apply when the ASR-6000 is powered on for at least 30 minutes.

## Electrical specifications

Model	ASR-6450	ASR-6600
<b>Input ratings</b>		
Power type	Single-phase Three-phase, Delta or Y connection selectable	
Voltage range <sup>*1</sup>	200 Vac to 240 Vac $\pm 10\%$ phase voltage (Delta: L-L, Y: L-N)	
Frequency range	47 Hz to 63 Hz	
Power factor <sup>*2</sup>	0.95 or higher (typ.)	
Efficiency <sup>*2</sup>	80 % or higher	
Maximum power consumption	6 kVA or lower	8 kVA or lower

Model	ASR-6450	ASR-6600		
<b>AC output</b>				
Multi-phase output	Single-phase output	Polyphase output	Single-phase output	Polyphase output
Output capacity	4.5 kVA	1P3W: 3 kVA 3P4W: 4.5 kVA	6 kVA	1P3W: 4 kVA 3P4W: 6 kVA
Mode	1P2W	1P3W 3P4W (Y-connection)	1P2W	1P3W 3P4W (Y-connection)
Setting mode <sup>*3</sup>	---	Unbalance, Balance	---	Unbalance, Balance
Phase voltage	Setting Range <sup>*4</sup>	0.00 V to 175.0 V / 0.0 V to 350.0 V (sine and square wave), Setting Resolution: 0.01 V / 0.1 V		
	Accuracy <sup>*5</sup>	0.00 Vpp to 500.0 Vpp / 0.00 Vpp to 1000 Vpp (triangle and arbitrary wave), Setting Resolution: 0.01 Vpp / 0.1 Vpp / 1 Vpp		
Line voltage setting range <sup>*6</sup>		1P3W: 0.00 V to 350.0 V / 0.00 V to 700.0 V		1P3W: 0.00 V to 350.0 V / 0.00 V to 700.0 V
		3P4W: 0.00 V to 303.1 V / 0.00 V to 606.2 V (sine and square wave) Setting		3P4W: 0.00 V to 303.1 V / 0.00 V to 606.2 V (sine and square wave) Setting

		Resolution: 0.01 V / 0.1 V		Resolution: 0.01 V / 0.1 V
		1P3W: 0.00 Vpp to 1000 Vpp / 0.00 Vpp to 2000 Vpp		1P3W: 0.00 Vpp to 1000 Vpp / 0.00 Vpp to 2000 Vpp
		3P4W: 0.00 Vpp to 866.0 Vpp / 0.00 Vpp to 1732 Vpp (triangle and arbitrary wave) Setting		3P4W: 0.00 Vpp to 866.0 Vpp / 0.00 Vpp to 1732 Vpp (triangle and arbitrary wave) Setting
		Resolution: 0.01 Vpp / 0.1 Vpp / 1 Vpp		Resolution: 0.01 Vpp / 0.1 Vpp / 1 Vpp
Maximum current <sup>*7</sup>	45 A / 22.5 A	15 A / 7.5 A	60 A / 30 A	20 A / 10 A
Maximum peak current <sup>*8</sup>	Four times of the maximum RMS current			
Load power factor <sup>*9</sup>	0 to 1 (leading phase or lagging phase, 45 Hz to 65Hz)			
Frequency	Setting range	AC Mode: 15.00 Hz to 2000.0 Hz, AC+DC Mode: 1.00 Hz to 2000.0 Hz, Setting resolution: 0.01 Hz / 0.1 Hz		
	Accuracy	± 0.01% of set		
	Stability <sup>*10</sup>	± 0.005%		
Output on phase setting range <sup>*11</sup>	0.0° to 359.9° variable (Free / Fix selectable), 0.1° (1 Hz to 500 Hz), 1° (500 Hz to 2000 Hz)			
Output off phase setting range <sup>*11</sup>	0.0° to 359.9° variable (Free / Fix selectable), 0.1° (1 Hz to 500 Hz), 1° (500 Hz to 2000 Hz)			
Setting range of the phase angle <sup>*12</sup>	---	3P4W: L2 phase: 0° to 359.9° L3 phase: 0° to 359.9° Setting Resolution: 0.1°	---	3P4W: L2 phase: 0° to 359.9° L3 phase: 0° to 359.9° Setting Resolution: 0.1°
		45 Hz to 65 Hz: ±1.0° 15 Hz to 2000 Hz: ±2.0°	---	45 Hz to 65 Hz: ±1.0° 15 Hz to 2000 Hz: ±2.0°
Phase angle accuracy <sup>*13</sup>				
DC offset <sup>*14</sup>	± 20 mV (typ.)			

Model	ASR-6450	ASR-6600
<b>DC output (only single phase output)</b>		
Output capacity	4.5 kW	6 kW
Mode	Floating output, the N terminal can be grounded	
Voltage	Setting	-250.0 V to +250.0 V / -500.0 V to +500.0 V, Setting
	Range	Resolution: 0.01 V / 0.1 V
	Accuracy <sup>*15</sup>	±(0.3 % of set) + 0.3 V / 0.6 V
Maximum current <sup>*16</sup>	45 A / 22.5 A	60 A / 30 A
Maximum peak current <sup>*17</sup>	Four times of the maximum current	

Model	ASR-6450	ASR-6600
<b>Output Stability, Total Harmonic Distortion, Output voltage rising time and Ripple noise</b>		
Line regulation	±0.1% or less (Phase voltage)	
Load regulation <sup>*18</sup>	±0.1 V / ±0.2 V, @DC (only single-phase output)	
	±0.1 V / ±0.2 V, @45 Hz to 65 Hz (phase voltage, 0 to 100%, via output terminal)	
	±0.5 V / ±1.0 V, @all other frequencies (phase voltage, 0 to 100%, via output terminal)	
Distortion of Output <sup>*19</sup>	<0.3 % @1Hz to 100Hz, <0.5 % @100.1 Hz to 500 Hz, <1 % @500.1 Hz to 2000 Hz	
Output voltage response time <sup>*20</sup>	Fast: 50 μs (typ.)	
	Middle: 100 μs (typ.)	
	Slow: 300 μs (typ.)	
Ripple noise <sup>*21</sup>	0.5 Vrms / 1 Vrms (TYP)	

- 1) Y connection is three-phase, five-wire, Delta connection is three-phase, four-wire. (Accessories will be provided)
- 2) In the case of AC-INT mode, the rate output voltage, resistance load at maximum output current, 45 Hz to 65 Hz and sine wave output only.
- 3) Can be only set in polyphase mode.
- 4) For phase voltage setting in polyphase output. In balance mode all phase are collectively set and in unbalance mode each phases are individually set.
- 5) For an output voltage of 10 V to 175 V / 20 V to 350 V, sine wave, an output frequency of 45 Hz to 65 Hz, no load, DC voltage setting 0V (AC+DC mode) and 23°C ± 5°C. For phase voltage setting in the polyphase output.
- 6) Line voltage only can be set in balance mode.
- 7) If the output voltage is higher than rated value, this is limited to satisfy the power capacity. If there is the DC superimposition, the active current of AC+DC satisfies the maximum current. In the case of 40 Hz or lower or 400 Hz or higher, and that the ambient temperature is 40 degree or higher, the maximum current may decrease.
- 8) With respect to the capacitor-input rectifying load. Limited by the maximum current.
- 9) External power injection or regeneration which is over short reverse power flow capacity is not available.
- 10) For 45 Hz to 65 Hz, the rated output voltage, no load and the resistance load for the maximum current, and the operating temperature range.
- 11) L1, L2 and L3 phase can be set unbalanced at unbalance mode in the polyphase



- output.
- 12) Can be set only with unbalance mode in polyphase output.
  - 13) For an output voltage of 50V or higher, sine wave, same load and voltage condition for all phase.
  - 14) In the case of the AC mode and output voltage setting to 0 V, 23°C ± 5°C
  - 15) For an output voltage of -250 V to -10 V, +10 V to +250 V / -500 V to -20 V, +20 V to +500 V, no load, AC voltage set to 0V (AC+DC mode) and 23°C ± 5°C
  - 16) If the output voltage is higher than rated value, this is limited to satisfy the power capacity. If there is the AC superimposition, the active current of AC+DC satisfies the maximum current. And the ambient temperature is 40 degree or higher, the maximum current may decrease.
  - 17) Instantaneous eithin 3 ms, limited by the maximum current at rated output voltage.
  - 18) For an output voltage of 75 V to 175 V / 150 V to 350 V, a load power factor of 1, stepwise change from an output current of 0 A to maximum current (or its reverse), using the output terminal on the rear panel.
  - 19) 50 % or higher of the rated output voltage, the maximum current or lower, AC and AC+DC modes, THD+N. For the polyphase output, it is a specification for phase voltage setting.
  - 20) For an output voltage of 100 V / 200 V, a load power factor of 1, with respect to stepwise change from an output current of 0 A to the maximum current (or its reverse). 10% ~ 90% of output voltage.
  - 21) For 5 Hz to 1 MHz components in DC mode using the output terminal on the rear panel.

Measured value display

(All accuracy of the measurement function is indicated for 23 °C±5 °C.)

	Single-phase output	Polyphase output*6	
Voltage*1*2	Resolution	0.01 V / 0.1 V	
	RMS value accuracy	45 Hz to 65 Hz and DC: ± (0.5 % of rdg + 0.5 V / 1 V)	45 Hz to 65 Hz: ± (0.5 % of rdg + 0.5 V / 1 V)
		15 Hz to 2000 Hz: ± (0.7 % of rdg + 1 V / 2 V)	15 Hz to 2000 Hz: ± (0.7 % of rdg + 1 V / 2 V)
	AVG value accuracy	DC: ± ( 0.5 % of rdg  + 0.5 V / 1 V)	DC: ± ( 0.5 % of rdg  + 0.5 V / 1 V)
	PEAK value accuracy*3	45 Hz to 65 Hz and DC: ±( 2 % of rdg  + 1 V / 2 V)	45 Hz to 65 Hz: ±( 2 % of rdg  + 1 V / 2 V)
Current*4	Resolution	0.01 A / 0.1 A	
	RMS value accuracy	45 Hz to 65 Hz and DC: ±(0.5 % of rdg + 0.1 A / 0.05 A)	45 Hz to 65 Hz: ±(0.5 % of rdg + 0.05 A / 0.03 A)
		15 Hz to 2000 Hz: ±(0.7 % of rdg + 0.2 A / 0.1 A)	15 Hz to 2000 Hz: ±(0.7 % of rdg + 0.1 A / 0.05 A)
	AVG value accuracy	DC: ± ( 0.5 % of rdg  + 0.2 A / 0.1 A)	DC: ± ( 0.5 % of rdg  + 0.1 A / 0.05 A)
	PEAK value accuracy*5	45 Hz to 65 Hz and DC: ±( 2 % of rdg  + 1 A / 0.5 A)	45 Hz to 65 Hz: ±( 2 % of rdg  + 0.5 A / 0.25 A)

Power <sup>*7*8</sup>	Active (W)	Resolution	0.1 W / 1 W	
		Accuracy <sup>*9</sup>	±(1 % of rdg + 3 W)	±(1 % of rdg + 1 W)
	Apparent (VA)	Resolution	0.1 VA / 1 VA	
		Accuracy	±(2 % of rdg + 6 VA)	±(2 % of rdg + 2 VA)
	Reactive (VAR)	Resolution	0.1 VAR / 1 VAR	
		Accuracy <sup>*10</sup>	±(2 % of rdg + 6 VAR)	±(2 % of rdg + 2 VAR)
Power factor	Range	0.000 to 1.000		
	Resolution	0.001		
Harmonic voltage	Range	Up to 100th order of the fundamental wave		
	Full Scale	200 V / 400 V, 100%		
Effective value (rms)	Resolution	0.01 V / 0.1 V, 0.1%		
	Percent (%) (AC-INT and 50/60 Hz only) <sup>*11</sup>	Accuracy <sup>*12</sup>	Up to 20th: ±(0.2 % of rdg + 0.5 V / 1 V) 20th to 100th: ±(0.3 % of rdg + 0.5 V / 1 V)	
Harmonic current	Range	Up to 100th order of the fundamental wave		
	Full Scale	63 A / 31.5 A, 100%	21 A / 10.5 A, 100%	
Effective value (rms)	Resolution	0.01 A / 0.1 A, 0.1%		
	Percent (%) (AC-INT and 50/60 Hz only) <sup>*11</sup>	Accuracy <sup>*13</sup>	Up to 20th: ±(1 % of rdg + 1.5 A / 0.75 A) 20th to 100th: ±(1.5 % of rdg + 1.5 A / 0.75 A)	Up to 20th: ±(1 % of rdg + 0.5 A / 0.25 A) 20th to 100th: ±(1.5 % of rdg + 0.5 A / 0.25 A)

- 1) In the polyphase output, the specification is for phase voltage, and the DC average value display cannot be selected.
- 2) Accuracy values are in the case that the output voltage is within voltage setting range.
- 3) The accuracy is for output waveform DC or sine wave only.
- 4) Accuracy values are in the case that the output current is 5% to 100% of the maximum current.
- 5) The accuracy is for output waveform DC or sine wave only.
- 6) In the polyphase output, these are the specifications for each phase.
- 7) For an output voltage of 50 V or greater, an output current in the range of 10 % to 100 % of the maximum current, DC or an output frequency of 45 Hz to 65 Hz.
- 8) The apparent and reactive powers are not displayed in the DC mode.
- 9) For the load with the power factor 0.5 or higher.
- 10) For the load with the power factor 0.5 or lower.
- 11) The measurement does not conform to the IEC or other standard. Phase Voltage and Phase Current.
- 12) For an output voltage of 10 V to 175 V / 20 V to 350 V.
- 13) An output current in the range of 5 % to 100 % of the maximum current.

Model	ASR-6450	ASR-6600
<b>Others</b>		
Protections	UVP, OVP, OCP, OTP, OPP, Fan Fail, Peak and RMS Current Limit	
Parallel function	Up to 3 units	
Display	TFT-LCD, 7 inch	
Memory function	Store and recall settings, Basic settings: 10	
Arbitrary Wave	Number of memories	253 (nonvolatile)
	Waveform length	4096 words
	Amplitude resolution	16 bits

## General Specifications

Model		ASR-6450	ASR-6600
Interface	Standard	USB	Type A: Host, Type B: Slave, Speed: 1.1/2.0, USB-CDC / USB-TMC
		LAN	MAC Address, DNS IP Address, User Password, Gateway IP Address, Instrument IP Address, Subnet Mask
		External	External Signal Input External Control I/O V/I Monitor Output
	Optional 1	RS-232C	Complies with the EIA-RS-232 specifications
	Optional 2	GPIB	SCPI-1993, IEEE 488.2 compliant interface
	Optional 3	CAN Bus	Complies with CAN 2.0A or 2.0B based protocol
		Device Net	Complies with CAN 2.0A or 2.0B based protocol
Insulation resistance	Between input and chassis, output and chassis, input and output	DC 500 V, 30 MΩ or more	
Withstand voltage	Between input and chassis, output and chassis, input and output	AC 1500 V or DC 2130 V , 1 minute	
EMC		EN 61326-1 (Class A) EN 61326-2-1/-2-2 (Class A) EN 61000-3-2/-3-12 (Class A, Group 1) EN 61000-3-3/-3-11 (Class A, Group 1) EN 61000-4-2/-4-3/-4-4/-4-5/-4-6/-4-8/-4-11/-4-34 (Class A, Group 1) EN 55011 (Class A, Group1)	
Safety		EN 61010-1	
Vibration, Shock and Transportation Integrity		ISTA 2A Test Procedure	
Environment	Operating environment	Indoor use, Overvoltage Category II	
	Operating temperature range	0 °C to 40 °C	
	Storage temperature range	-10 °C to 70 °C	
	Operating humidity range	20 %rh to 80 % RH (no condensation)	
	Storage humidity range	90 % RH or less (no condensation)	

	Altitude	Up to 2000 m
	Dimensions (mm)	430(W)×176(H)×590(D) (not including protrusions)
	Weight	Approx. 40 kg

- A value with the accuracy is the guaranteed value of the specification. However, an accuracy noted as reference value shows the supplemental data for reference when the product is used, and is not under the guarantee. A value without the accuracy is the nominal value or representative value (shown as typ.).
- Product specifications are subject to change without notice.

### External Signal Input (AC+DC-EXT, AC-EXT Mode)

	Specification	Factory Default
Gain setting range	100 V range: 0.0 to 250.0 times	100
	200 V range: 0.0 to 500.0 times	200
Input terminal	25 Pins D-SUB Connector (rear panel, female, M2.8 screw)	
Input impedance	1 MΩ	
Input voltage range	±2.5 V (A/D resolution 12 bit)	
Nondestructive maximum input voltage	±10 V	
Gain resolution	0.1 times	
Accuracy	±5 % (DC, or 45Hz ~ 65 Hz, gain is at initial value, with rate voltage output, no load)	

EXT: Output voltage (V) = External signal input (V) x Gain (V/V)

### External Signal Input (AC+DC-ADD, AC-ADD Mode)

	Specification	Factory Default
Gain setting range	100 V range: 0.0 to 250.0 times	100
	200 V range: 0.0 to 500.0 times	200
Input terminal	25 Pins D-SUB Connector (rear panel, female, M2.8 screw)	
Input impedance	1 MΩ	
Input voltage range	±2.5 V (A/D resolution 12 bit)	
Nondestructive maximum input voltage	±10 V	
Input frequency range	DC to 2000.0 Hz (sine wave)	
	DC to 100 Hz (other than sine wave)	
Gain resolution	0.1 times	
Accuracy	±5 % (DC, or 45Hz ~ 65 Hz, gain is at initial value, with rate voltage output, no load)	

## External Synchronous Signal or Line (AC+DC-SYNC, AC-SYNC Mode)

	Specification	Factory Default
Synchronization signal source	External synchronization signal (EXT) or Power input (LINE)	LINE
Synchronization frequency range		15 Hz to 2 kHz
Input terminal	25 Pins D-SUB Connector (rear panel, female, M2.8 screw)	
Input impedance		1 M $\Omega$
Threshold of input voltage		TTL level
Minimum pulse width		500 $\mu$ s
Nondestructive maximum input voltage		$\pm$ 10 V
Resolution		0.1 Hz
Accuracy		$\pm$ 0.2 Hz

## Voltage Setting Signal Input (AC-VCA Mode)

	Specification	Factory Default
Gain setting range	100 V range: 0.0 to 250.0 times	100
	200 V range: 0.0 to 500.0 times	200
Input terminal	25-pin D-sub multi-connector (rear panel, female, M2.6 screw)	
Input impedance		1 M $\Omega$
Input voltage range	$\pm$ 2.5 V (A/D resolution 12 bit)	
Nondestructive maximum input voltage		$\pm$ 10 V
Gain resolution		0.1 times
Accuracy	$\pm$ 5 % (DC, or 45Hz ~ 65 Hz, gain is at initial value, with rate voltage output, no load)	

## Voltage and Current Monitor Output

Model		ASR-6450							
Phase mode		3P4W				1P2W			
R100/R200 Range	R100		R200		R100		R200		
H/L Level	H	L	H	L	H	L	H	L	
Voltage(V/V)	1/25	1/100	1/50	1/200	1/25	1/100	1/50	1/200	
Current(V/A)	1/(6* N)	1/(24* N)	1/(3* N)	1/(12* N)	1/(18* N)	1/(72* N)	1/(9* N)	1/(36* N)	
Model		ASR-6600							
Phase mode		3P4W				1P2W			
R100/R200 Range	R100		R200		R100		R200		
H/L Level	H	L	H	L	H	L	H	L	
Voltage(V/V)	1/25	1/100	1/50	1/200	1/25	1/100	1/50	1/200	
Current(V/A)	1/(8* N)	1/(32* N)	1/(4* N)	1/(16* N)	1/(24* N)	1/(96* N)	1/(12* N)	1/(48* N)	
Accuracy				±5% of full scale					
Output Impedance				600 Ω					

- H Level mapping to +/- 10V
- L Level mapping to +/- 2.5V
- N mapping to external parallel unit number

## Voltage and Current Monitor Output

		ASR-6600	
		Single-phase output	Polyphase output
Monitored	Output phase voltage and current waveform (two terminals)		
Maximum monitor value	±2 V (D/A resolution 12 bit)		
Gain	Phase voltage (V/V)	1/125, 1/250	
	Phase current (V/A)	1/20, 1/60	1/40, 1/20
Input terminal	25 Pins D-SUB Connector (rear panel, female, M2.8 screw)		
Input impedance	1 MΩ		
Accuracy	±5 %		

## Information of Name Order

The name order of ASR-6000 series has its rules in definition for each character by order. Refer to the following contents for details.

**Background**      The definitions below describe the meanings behind each group of alphanumeric characters, in varied colors, of naming code for ASR series models.

<b>Naming Definition</b>	<b>ASR</b>	Switching Mode AC Power Source
	<b>6</b>	Series Name
	<b>XX</b>	Output Capacity 45: 4500VA 60: 6000VA
	<b>0</b>	Fixed number
	<b>-XX</b>	Maximum Output Capacity of Parallel Models

<b>Lineup of ASR Series Models</b>	<b>ASR-6450</b>	
	<b>ASR-6600</b>	
	<b>ASR-6450-09</b>	
	<b>ASR-6600-12</b>	
	<b>ASR-6450-13.5</b>	
	<b>ASR-6600-18</b>	
	<b>ASR-6600-24</b>	(release soon)
<b>ASR-6600-30</b>	(release soon)	
<b>ASR-6600-36</b>	(release soon)	



# ASR-6000 Dimensions

## ASR-6450/6600

Scale = mm

---

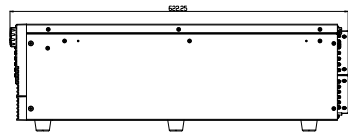
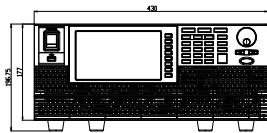
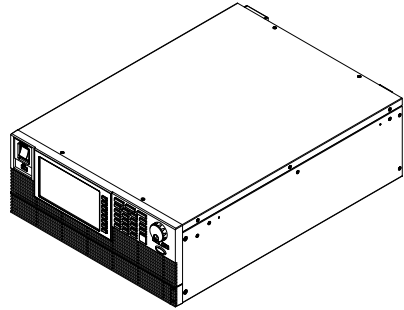
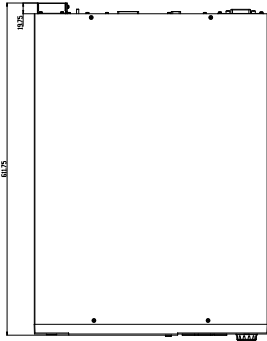

## Declaration of Conformity

We

**GOOD WILL INSTRUMENT CO., LTD.**

declare that the below mentioned product

satisfies all the technical relations application to the product within the scope of council:

Directive: EMC; LVD; WEEE; RoHS

The product is in conformity with the following standards or other normative documents:

<b>© EMC</b>	
EN 61326-1 :	Electrical equipment for measurement, control and laboratory use — EMC requirements
Conducted & Radiated Emission EN 55011 / EN 55032	Electrical Fast Transients EN 61000-4-4
Current Harmonics EN 61000-3-2 / EN 61000-3-12	Surge Immunity EN 61000-4-5
Voltage Fluctuations EN 61000-3-3 / EN 61000-3-11	Conducted Susceptibility EN 61000-4-6
Electrostatic Discharge EN 61000-4-2	Power Frequency Magnetic Field EN 61000-4-8
Radiated Immunity EN 61000-4-3	Voltage Dip/ Interruption EN 61000-4-11 / EN 61000-4-34
<b>© Safety</b>	
EN 61010-1 :	Safety requirements for electrical equipment for measurement, control, and laboratory use - Part 1: General requirements

**GOODWILL INSTRUMENT CO., LTD.**

No. 7-1, Jhongsing Road, Tucheng District, New Taipei City 236, Taiwan

Tel: [+886-2-2268-0389](tel:+886-2-2268-0389)

Fax: [+886-2-2268-0639](tel:+886-2-2268-0639)

Web: <http://www.gwinstek.com>

Email: [marketing@goodwill.com.tw](mailto:marketing@goodwill.com.tw)

**GOODWILL INSTRUMENT (SUZHOU) CO., LTD.**

No. 521, Zhujiang Road, Snd, Suzhou Jiangsu 215011, China

Tel: [+86-512-6661-7177](tel:+86-512-6661-7177)

Fax: [+86-512-6661-7277](tel:+86-512-6661-7277)

Web: <http://www.instek.com.cn>

Email: [marketing@instek.com.cn](mailto:marketing@instek.com.cn)

**GOODWILL INSTRUMENT EURO B.V.**

De Run 5427A, 5504DG Veldhoven, The Netherlands

Tel: [+31-\(0\)40-2557790](tel:+31-(0)40-2557790)

Fax: [+31-\(0\)40-2541194](tel:+31-(0)40-2541194)

Email: [sales@gw-instek.eu](mailto:sales@gw-instek.eu)

## Maintenance & Regular Inspection

**Background** The potential malfunctions and faults may occur on ASR-6000 due to scores of reasons like humidity, temperature, dust, vibration as well as aging and wear of components. Consequently, to conduct regular maintenance and inspection on ASR-6000 is highly suggested on daily basis.



Note

The maintenance and inspection can only be performed by qualified and authorized technician or personnel.

### Regular Inspection

**Background** To achieve a systematically regular inspection, the daily operating data, parameter-relevant records, among other critical information should be well taken down for the establishment of thorough application files for ASR-6000.

Object	Item	Method
Operating Environment Inspection	Temperature & Humidity	Use both thermometer and hygrometer to check if ambient temperature is lower than 40°C and if the requirement of humidity is well met at all times.
	Moisture, Dust & Leak	Observe and make sure no dust bunnies, nor water leak traces and condensation occur.
	Gas Leak	To sniff if there is any abnormal odor or color existed.

Equipment	Vibration	Check if the equipment is operating stably and free from any vibration.
	Heating & Cooling	From the wind hole check if the fan runs adequately and make sure both wind speed and wind volume are in normal status.
	Noise	Ensure that no abnormal noise does happen.

## Maintenance

Calibration	Before shipping, we confirm that the proper calibration procedure was implemented in each unit. Nevertheless, in order to maintain the highest performance, we strongly suggest that the periodic calibration is necessary. Contact your dealer or local distributor for calibration.
-------------	---

Cleaning	<p>Gently wipe the unit by a soft cloth dipped with neutral diluted detergent when the unit is in need of cleaning. Avoid using volatile chemicals, e.g., benzene, in that some irreversible results may occur as follows.</p> <p>Discolored surface</p> <p>Printed characters erased</p> <p>Clouded display</p>
----------	--



Note

Before maintenance jobs, it is imperative to turn Off the power switch and remove the power cord from the unit as possible electric shock, which leads to injury or death, may occur if not doing so.

# INDEX

- Accessories ..... 15
- Advanced settings
  - Buzzer .....168
  - Power output .....166
  - Program timer unit.....169
  - SCPI emulation171, 172, 173, 175, 176
- Alarm
  - description.....27, 28, 32
- Alarm clear ..... 117
- Analog control
  - overview ..... 151, 159, 190
- ARB
  - Overview ..... 129, 147, 149
- Buzzer ..... 168
- Caution symbol..... 5
- Cleaning the instrument ..... 8
- clear alarm ..... 117
- Conventions ..... 42
- Current RMS ..... 98
- Declaration of conformity..... 267
- Default settings ..... 246, 250
  - reset .....67
- Delete sequence memory 143, 203
- Delete simulation memory ..... 216
- Display mode
  - operation..... 106, 113, 114
- Disposal instructions..... 8
- EN61010
  - pollution degree ..... 8
- Environment
  - safety instruction .....8
- Ethernet
  - interface .....222
- Filter installation..... 72
- Firmware update ..... 244
- Frequency limit ..... 91
- Frequency output ..... 94
- Front panel diagram ..... 17
- Ground
  - symbol.....5
- I rms .....98
- Ipk-Limit ..... 96, 98
- J1 connector
  - pin assignment ..... 152
- List of features ..... 13
- Load preset to local memory .. 124
- Load preset to USB ..... 126
- Load sequence to USB ..... 143, 203
- Load simulation to USB ..... 216
- Menu Tree ..... 75
- Model differences ..... 10
- On/off phase ..... 100, 102
- Operation considerations..... 36
  - inrush current..... 36
- Output terminals..... 45, 52, 65
- Panel lock..... 110, 116
- Peak current limit..... 96, 98
- Power on output ..... 166
- Power on/off
  - safety instruction..... 7
- Power up40, 47, 48, 49, 50, 52, 53, 54, 55
- Program timer unit ..... 169
- Rack mount
  - description ..... 64
- Remote control ..... 221
  - Ethernet ..... 222
  - GPIB..... 231
  - LAN ..... 222
  - RS232 ..... 225, 235, 236
  - USB ..... 223
- Remote control function check
  - GPIB..... 232
  - Realterm..... 228
  - RS-232..... 224, 227
  - USB ..... 224, 227

Save preset to local memory ..	122	Recall.....	202
Save preset to USB.....	126	Run.....	207
Save sequence to USB .....	143, 203	Save.....	202
Save simulation to USB.....	216	Settings .....	197
SCPI emulation.....	171, 172, 173, 175, 176	Simulation	
Serial number		Overview .....	209
view .....	68	Recall.....	215
Service operation		Run.....	219
about disassembly .....	6	Save.....	215
Socket server function check..	238	Settings .....	212
Start/stop phase .....	100, 102	Updating the firmware .....	244
SYNC output		USB driver installation.....	69
pin assignment .....	154	Voltage limit .....	87
System version		Voltage output level ..	89, 268, 269
view .....	68	Voltage range ...	80, 83, 84, 85, 265
Test		Warning symbol .....	5
Sequence		Web server function check .....	237
Overview .....	191	Wire gauge chart.....	74