

CONTENTS	PAGE
1. INTRODUCTION.....	1
2. CONNECTING METER VIA GPIB INTERFACE.....	2
3. CONNECTING METER VIA RS232 INTERFACE.....	5
4. INPUT AND OUTPUT QUEUE.....	8
5. COMMANDS AND SYNTAX.....	8
6. DETAILS OF COMMAND REFERENCE.....	21
7. STATUS AND ERROR REPORTING.....	45

1. INTRODUCTION

In the modern automatic measurement system, communication between equipments and computers is essential. The measured procedures can be varied with user's testing programs, therefore, the Meter can be operated remotely from an instrument controller or computer across the RS232 interface (optional) or GPIB (optional).

Interface selection and setup

Press [SHIFT][GPIB/RS232] into Interface selection and Setup, the panel will display current setting status, and the negative symbol indicator will be lighted up. Select GPIB or RS232 interface by [◀] or [▶] while using [▲][▼] can adjust the baud rate (or GPIB address). Finally, press [ENTER] to store the setup or press [SHIFT] to cancel the setup.

2. CONNECTING THE METER VIA GPIB INTERFACE

The GPIB interface capabilities:

The GPIB interface of the Meter corresponds to the standard of IEEE488.1-1987, IEEE488.2-1992 and SCPI-1994. The GPIB interface functions are listed as follows:

SH1(Source Handshake)	: The Meter can transmit multilane messages across the GPIB.
AH1(Acceptor Handshake)	: The Meter can receive multilane messages across the GPIB.
T6(Talker)	: Talker interface function includes basic talker, serial poll, and unaddress if MLA capabilities, without talk only mode function.
L4 (Listener)	: The Meter becomes a listener when the controller sends its listen address with the ATN (attention) line asserted. The METER does not have listen only capability.
SR1 (Service Request)	: The Meter asserts the SRQ (Service request) line to notify the controller when it requires service.
RL1 (Remote/Local)	: The Meter responds to both the GTL(Go to Local) and LLO(Local Lock Out) interface messages.
PP0 (Parallel Poll)	: The Meter has no Parallel Poll interface function.
DC1 (Device Clear)	: The Meter has Device clear capability to return the device to power on status.
DT0 (Device Trigger)	: The Meter has no Device Trigger interface function.
C0 (Controller)	: The Meter can not control other devices.

Notes for GPIB installation

When the Meter is set up with a GPIB system, please check the following things:

- Only a maximum of 15 devices can be connected to a single GPIB bus.
- Do not use more than 20m of cable to connect devices to a bus.
- Connect one device for every 2m of cable used.
- Each device on the bus needs a unique device address. No two devices can share the same device address.
- Turn on at least two-thirds of the devices on the GPIB system while using the system.
- Do not use loop or parallel structure for the topology of GPIB system.

Computer's Connection

A personal computer with a GPIB card is the essential facilities in order to operate the Meter via GPIB interface.

The connections between Meter and computer are following:

- I. Connect one end of a GPIB cable to the computer.
- II. Connect the other end of the GPIB cable to the GPIB port on the Meter.
- III. Turn on the Meter.
- IV. Turn on the computer.

The GPIB connection testing

If you want to test whether the GPIB connection is working or not, you can send a GPIB command from computer. For instance, the query command

```
*idn?
```

should return the Manufacturer, model number, and firmware version in the following format:

```
GW.Inc,GOM-802,FW1.00
```

If you do not receive a proper response from the Meter, please check if the power is on, the GPIB address is correct, and all cable connections are active.

3. CONNECTING THE METER VIA RS232 INTERFACE**The RS232 interface capabilities:**

The RS232 interface provides a point-to-point connection between two items of equipment such as a computer and the Meter. There are some parameters you need to set on the both sides. Once you have set these parameters, you can control the Meter through the RS232 interface.

- Baud rate: You can set rates of 1200, 2400, 4800 or 9600 baud.
- Parity bit: none.
- Data bit: 8 bits.
- Stop bit: 1 stop bit.
- Data flow control: none.

Notes for RS232 installation

The Meter is a DTE device with a 9-pin D-type shell RS232 connector located on the rear panel. Figure 1 shows the equipment of 9-pin connector (male) with its pin number assignments. Figure 2 shows the wiring configuration for DB9 to DB9. When the Meter is set up with a RS232 interface, please check the following points:

- Do not connect the output line of one DTE device to the output line of the other.
- Many devices require a constant high signal on one or more input pins.
- Ensure that the signal ground of the equipment is connected to the signal ground of the external device.
- Ensure that the chassis ground of the equipment is connected to the chassis ground of the external device.
- Do not use more than 15m of cable to connect devices to a PC.

- Ensure the same baud rate is used on the device as the one used on PC terminal.
- Ensure the connector for the both side of cable and the internal connected line are met the demand of the instrument.

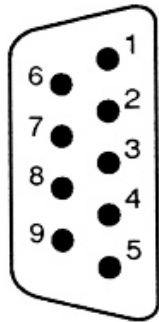

1. No connection
2. Receive Data(RxD) (input)
3. Transmit Data(TxD) (output)
4. No connection
5. Signal Ground(GND)
6. No connection
7. No connection
8. No connection
9. No connection

Figure 1 Pin assignments of the RS232 connector on the rear panel for DB-9-D

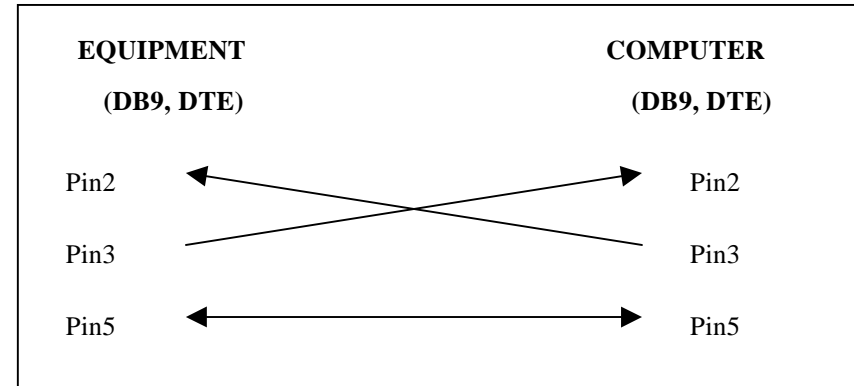

Figure 2 Wiring configuration for DB9 to DB9

Computer's Connection

A personal computer with a COM port is the essential facilities in order to operate the Meter via RS232 interface.

The connections between the Meter and computer are as follows:

- Connect one end of a RS232 cable to the computer.
- Connect the other end of the cable to the RS232 port on the Meter.
- Turn on the Meter.
- Turn on the computer.

The RS232 connection testing

If you want to test whether the RS232 connection is working or not, you can send a command from computer. For instance, using a terminal program send the query command

```
*idn?
```

should return the Manufacturer, model number, serial number and firmware version in the following format:

```
GW.Inc,GDM-802,FW1.00
```

If you do not receive a proper response from the Meter, please check if the power is on, the RS232 baud rate are the same on both sides, and all cable connections are active.

4. INPUT AND OUTPUT QUEUE

The design of 128 bytes input queue and 128 bytes output queue for storing the pending commands or return messages is to prevent the transmitted commands of remote control and return messages from missing. As the maximum stored capacity for Error/Event Queue is 20 groups of messages, it should be noted that input data exceeding the capacity by using these buffers will cause data missing.

5. COMMANDS AND SYNTAX

The GPIB commands of the Meter are compatible with IEEE-488.2 and SCPI standards

SCPI

SCPI (Standard Commands for Programmable Instruments) is a standard that created by an international consortium of the major test and measurement equipment manufacturers. The IEEE-488.2 syntax has been adopted by SCPI to provide common commands for the identical functions of different programmable instruments.

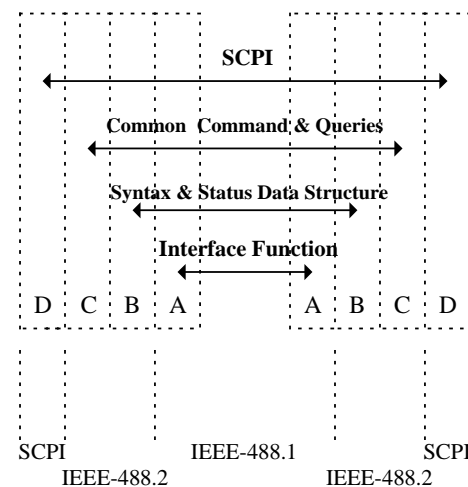

Figure 3 the relationship between IEEE-488.1, IEEE-488.2, and SCPI

As shown in the figure 3, the IEEE-488.1 standard locates at layer A, the layer A belongs to the protocol of interface function on the GPIB bus. The source handshake (SH), acceptor handshake (AH) and talker are included to this layer (10 interface functions totally).

At layer B, the syntax and data structure could be the essence of entire IEEE-488.2 standard. The syntax defines the function of message communication, which contain the <PROGRAM MESSAGE> (or simply “commands”) and <RESPONSE MESSAGE>. The two kinds of messages represent the syntax formation of device command and return value. The data structure is the constitution of status reporting, which IEEE-488.2 standard have been defined.

The common commands and queries are included to layer C. Commands and queries can be divided into two parts: mandatory and optional. Commands modify control settings or tell the instrument to perform a specific action. Queries cause the instrument to send data or status information back to the computer. A question mark at the end of a

command identifies it as a query.

Layer D is interrelated with device information. Different devices have different functions. SCPI command sets belong to this layer.

Command Syntax

If you want to transfer any instructions to an instrument, and comply with SCPI, there are three basic elements must be included.

- Command header
- Parameter (if required)
- Message terminator or separator

Command Header

The command header has a hierarchical structure that can be represented by a command tree (Figure 4).

The top level of the tree is the root level. A root node is located at the root level. A root node and one or more lower-level nodes form a header path to the last node called the leaf node.

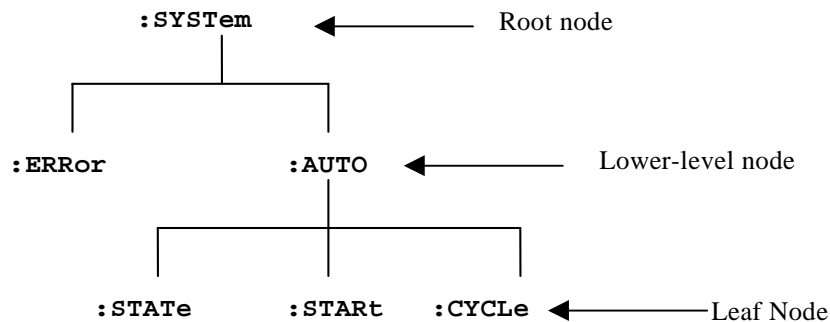

Figure 4: Tree hierarchy

The command header is configured by header path and leaf node. Figure 5 shows the command header for the leaf node indicated in Figure 4.

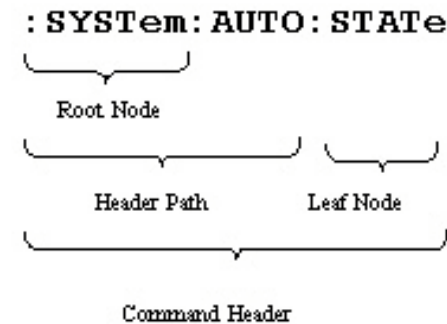

Figure 5 Command Header

Parameter

If the commands have parameters, the values have to be included. In this manual, when we expressed the syntax of the command, the < > symbols are used for enclosing the parameter type. For instance, the syntax of the command in Figure 6 includes the Boolean parameter type.

NOTE: Do not include the <, >, or | symbols when entering the actual value for a parameter.

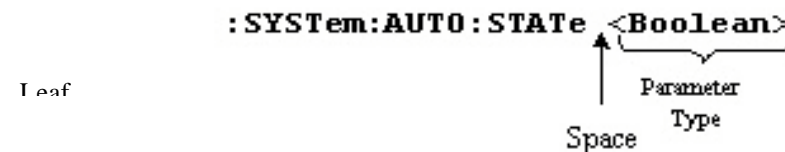

Figure 6 Command Header with Parameter

Table 1 defines the Boolean and other parameter types for the Meter.

Parameter Type	Description	Example
Boolean	Boolean numbers or values	0, 1
NR1	Integers	0, 1, 18
NR2	Decimal numbers	1.5, 3.141, 8.4
NR3	Floating point numbers	4.5E-1, 8.25E+1
String	Alphanumeric characters	“No error”

Table 1: Parameter Types for Syntax Descriptions

Message Terminator and Message Separator

I. GPIB message terminators

In accordance with IEEE 488.2 standard, any of the following message terminators are acceptable:

- LF^END Line feed code (hexadecimal 0A) with END message
- LF Line feed code
- <dab>^END Last data byte with END message

These terminators are compatible with most application programs. A semicolon separates one command from another when the commands appear on the same line.

II. RS232 message terminators

As there is no signal of end message on RS232 bus, therefore, use LF as message terminator. When a series of commands are sent to the instrument, it must add a LF to be a judgment for message terminator. As for query command, the return message of the instrument is also added a LF for PC to judge message terminator.

Entering Commands

The standards that govern the command set for the Meter allow for a certain amount of flexibility when you enter commands. For instance, you can abbreviate many commands or combine commands into one message that you send to the Meter. This flexibility, called friendly listening, saves programming time and makes the command set easier to remember and use.

Command Characters

The Meter is not sensitive to the case of command characters. You can enter commands in either uppercase or lowercase.

You can execute any command with white space characters. You must, however, use at least one space between the parameter and the command header

Abbreviating Commands

Most commands have a long form and a short form. The listing for each command in this section shows the abbreviations in uppercase. For instance, you can enter the query :CONFigure:RESistance 0 simply as :CONF:RES 0

Because the Meter hypothesis that a command starts from the root, you have the option of beginning the initial command header with a colon (:).

Combining Commands

You can use a semicolon (;) to combine commands. But continuously query command will cause message missing. For example:
:CONF:RANG?;:CONF:AUT?

If the command that follows the semicolon has a different header path from the root level, you must use a colon to force a return to the root level:

```
:CONF:RES 0;:CALC:REL:STAT 1
```

If the command that follows the semicolon has the same header path, you may omit the colon and the path and state only the new leaf node. For example:

```
: CONF:RES 0;:CONF:TEMP
```

is equal to

```
: CONF:RES 0;:TEMP
```

You can combine commands and queries into the same message. Note, for example, the following combination:

```
: CONF:RES 0;:READ?
```

Synopsis of Commands

The tables in this section summarize the command of the Meter. These tables divide the commands into four functional classifications:

- General Setting Commands
- Calculating Commands.
- Status Commands
- Miscellaneous Commands

The tables also provide a brief explanation of each command.

● General Setting Commands

Table 2 lists the general setting commands that control and query the settings of the Meter.

Table 2: General Setting Commands

Command	Explanation
:CONF:Figure:AUTO?	Returns Auto-range mode on or off.
:CONF:Figure:AUTO <Boolean>	Sets Auto-range mode on or off.
:CONF:Figure:RANGE?	Returns the range of the present function.
:CONF:Figure:FUNCTION?	Returns the present selected function.
:CONF:Figure:RESistance <NR2>	Sets ohm function and range.
:CONF:Figure:TEMPerature	Sets temperature function.
:CONF:Figure:TCOMPensate:RANGE <NR2>	Sets TC function and range.
:CONF:Figure: TCOMPensate: COEFFicient<NR1>	Sets temperature coefficient for TC function and range.
:CONF:Figure: TCOMPensate: COEFFicient?	Sets temperature coefficient for TC function.
:CONF:Figure: TCOMPensate: TEMPerature <NR2>	Sets require temperature for TC function.
:CONF:Figure: TCOMPensate: TEMPerature?	Returns require temperature for TC function.
:CONF:Figure:SPEED<Boolean>	Sets speed mode on or off.
:CONF:Figure:SPEED?	Returns speed mode on or off.

:CONFigure:SCAN:STATe<Boolean>	Sets scan mode on or off.
:CONFigure:SCAN:STATe?	Returns scan mode on or off.
:CONFigure:SCAN:CHANnel <NR1>	Sets the channel for scan mode.
:CONFigure:SCAN:CHANnel?	Returns the channel for scan mode.
:CONFigure:SCAN:DELay <NR1>	Sets the delay time for scan mode.
:CONFigure:SCAN:DELay?	Returns the delay time for scan mode.
:CONFigure:BUZZer <NR1>	Sets buzzer mode.
:CONFigure:BUZZer?	Returns buzzer setting.
:CONFigure:TRIGger:STATe <Boolean>	Set trigger mode on or off.
:CONFigure:TRIGger:STATe?	Returns trigger mode on or off.
:READ?	Returns the measured value.
:MEASure<X>?	Return the sweep result of the X group, including HI/LO/GO and reading value.
:SHOW?	Return the compare result of 100 groups.

- **Calculation Commands**

:CALCulation: LIMit:STATe?	Returns Compare mode on or off.
:CALCulation: LIMit:STATe <Boolean>	Sets Compare mode on or off.
:CALCulation: LIMit:LOWer?	Returns the value of the lower limit.
:CALCulation: LIMit:LOWer <NR2>	Sets the value of the lower limit.
:CALCulation: LIMit:UPPer?	Returns the value of the upper limit.
:CALCulation: LIMit:UPPer <NR2>	Sets the value of the upper limit.
:CALCulation: LIMit:NORMal?	Returns the normal value.
:CALCulation: LIMit: NORMal <NR2>	Sets the normal value.
:CALCulation: LIMit:FAIL?	Returns the limit result.
:CALCulation:PERCent:STATe?	Returns the percentage mode on or off.
:CALCulation: PERCent:STATe <Boolean>	Sets the percentage mode on or off.
:CALCulation: RELation: STATe <Boolean>	Sets REL mode on or off.
:CALCulation:RELation: STATe?	Returns REL mode on or off.
:CALCulation:RELation:DATa?	Returns the reference value of the REL mode.
:CALCulation:RELation:DATa <NR2>	Sets the reference value of the REL mode.

● Status Commands

Table 3 lists the status commands that set and query the various registers and queues that make up the status and event structure of the Meter.

Table 3: Status Commands

*CLS	Clears the status data structures.
*ESE <NR1>	Sets the Event Status Enable Register (ESER).
*ESE?	Returns contents of Event Status Enable Register (ESER).
*ESR?	Returns and clear the contents of Standard Event Status Register (SESR).
*SRE <NR1>	Sets contents of Service Request Enable Register (SRER).
*SRE?	Returns contents of Service Request Enable Register (SRER).
*STB?	Reads Status Byte Register (SBR).
:STATus:OPERation:CONDition?	Returns the contents of the OPERATION condition register. Returns NR1.
:STATus:OPERation:ENABLE <NR1>	Sets the contents of the enable mask for the OPERATION event register.
:STATus:OPERation:ENABLE?	Returns the contents of the enable mask for the OPERATION event register. Returns NR1.

:STATus:OPERation:EVENT?	Query the contents of the OPERATION Event register.
:STATus:PRESet	Presets the OPERATION and QUESTIONable status registers.
:STATus:QUESTIONable:CONDition?	Returns the contents of the OPERATION condition register. Returns NR1.
:STATus:QUESTIONable:ENABLE <NR1>	Sets the contents of the enable mask for the QUESTIONable enable register.
:STATus:QUESTIONable:ENABLE?	Query the contents of the Questionable Enable register.
:STATus:QUESTIONable:EVENT?	Query the contents of the QUESTIONable Event register.

● Miscellaneous Commands

Table 4 lists the miscellaneous commands that control general housekeeping functions of the Meter.

Table 4: Miscellaneous Commands

*IDN?	Returns instrument identification.
*OPC	Reports when the operation is completed by setting the Operation Complete bit in SESR.
*OPC?	Reports when operation is completed. Same as *OPC except returns a 1 to the output queue and does not set the SESR bit.
*RST	Resets states, sets ohm function.

*WAI	Wait to continue. This command forces sequential operation of commands. This command is required by IEEE-488.1-1987. The Meter, however, forces sequential operation of commands by design.
:SYSTem:ERRor?	Read the next item from the error/event queue.
:SYSTem:VERSion?	Returns the SCPI version level.
*RCL <NR1>	Recalls the setting data from the memory.
*SAV <NR1>	Saves the setting data to memory.

6. DETAILS OF COMMAND REFERENCE

Each command in this chapter will give a detailed description. The examples of each command will be provided and what query form might return.

*CLS (no query form)

Function:

Clear all event status data register. This includes the Output Queue, Operation Event Status Register, Questionable Event Status Register, and Standard Event Status Register.

Syntax:

*CLS

Examples:

*CLS clears all event registers.

*ESE

Function:

Set or return the bits in the Event Status Enable Register (ESER). The ESER enables the Standard Event Status Register (SESR) to be summarized on bit 5 (ESB) of the Status Byte Register (SBR).

Syntax:

*ESE <NR1>

*ESE?

<NR1> is in the range from 0 to 255.

Returns:

<NR1> is a number from 0 to 255 that indicates the decimal value of the binary bits of the ESER.

Examples:

*ESE 65 sets the ESER to binary 0100 0001.

If the ESER contains the binary value 1000 0010, the *ESE? will return the value of 130.

***ESR? (query only)**

Function:

Return and clear the contents of the Standard Event Status Register (SESR).

Syntax:

*ESR?

Returns:

<NR1> is a number from 0 to 255 that indicates the decimal value of the binary bits of the ESER.

Examples:

If the ESER contains the binary value 1100 0110, the *ESR? will return the value of 198.

***IDN? (query only)**

Function:

Return the unique identification code of the Meter.

Syntax:

*IDN?

Returns:

<String> includes Manufacturer, model number, serial number and firmware version.

Examples:

*IDN? Returns GW_Inc, GOM-802 , FW1.00

***OPC**

Function:

The command form (*OPC) sets the operation complete bit (bit 0) in the Standard Event Status Register (SESR) when all pending operations are finished.

The query form (*OPC?) tells the Meter to place an ASCII 1 in the Output Queue when the Meter completes all pending operations.

Syntax:

*OPC

*OPC?

Returns:

1

***RST (no query form)**

Function:

Set all control settings of Meter to ohm function auto range but does not purge stored setting. The equivalent panel control will be set as below:

***SRE**

Function:

Set the contents of the Service Request Enable Register (SRER). The query form returns the contents of the SRER. Bit 6 of the SRER is always zero. The bits on the SRER correspond to the bits on the SBR.

Syntax:

*SRE <NR1>

***SRE?**

Returns:

<NR1> is in the range from 0 through 255.

Examples

*SRE 7 sets bits of the SRER to 0000 0111.

If the *SRE? returns 3, the SRER is set to 0000 0011.

***STB? (query only)**

Function:

The query of the Status Byte register (SBR) with *STB? will return a decimal number representing the bits that are set (true) in the status register.

Syntax:

*STB?

Returns:

<NR1> is in the range from 0 through 255.

Examples:

*STB? returns 81, if SBR contains the binary value 0101 0001.

***WAI (no query form)**

Function:

WAI prevents the programming instrument from executing further commands or queries until all pending operations are finished.

Syntax:

*WAI

***SAV**

Function:

Save the limit setting data to a specific memory location.

Syntax:

*SAV <NR1>

<NR1> is in the range from 0 through 19.

Examples:

*SAV 1 saves the current setting data to memory location 1.

***RCL**

Function:

Recall the limit setting data from the memory saved previously.

Syntax:

*RCL <NR1>

<NR1> is in the range from 0 through 19.

Examples:

*RCL 12 recalls the limit setting data stored in memory location 12.

:CONFigure:AUTO

Function:

Set or query the auto-range mode on or off.

Syntax:

:CONFigure:AUTO <Boolean>

<Boolean> can be 0(off) or 1(on)

:CONFigure:AUTO?

Returns:

0/1

Examples:

:CONFigure:AUTO 1

Set to auto-range mode.

If it is in the auto-range mode, the command of :CONFigure:AUTO? Will return the value of 1.

:CONFigure:RANGe? (query only)

Function:

Query the range of the present function, total 10 letters.

Syntax:

:CONFigure:RANGe?

Returns:

<String>

Examples:

:CONFigure:RANGe? might return "+3.0000E+2" to indicate the 300Ω range, return unit is ohm.

:CONFigure:FUNCTION? (query only)

Function:

Return the present selected function.

Syntax:

:CONFigure:FUNCTION?

Returns:

<String>

Examples:

:CONFigure:FUNCTION? might return "OHM" to indicate the present ohm function.

Please refer to the returned message for every function as follows:

Table 6-2:

Function	Description
Temperature compensation	TC
Resistance	OHM
Temperature	TEMP

:CONFigure:RESistance (no query form)

Function:

Set ohm function and the range.

Syntax:

:CONFigure:RESistance <NR2>

Examples:

:CONFigure: RESistance 0 sets to ohm function and auto-range.

:CONFigure: RESistance 18 sets to ohm function and 30Ω range.

<NR2> is in ohm unit.

:CONFigure:TEMPerature(no query form)

Function:

Set the temperature function

Syntax:

:CONFigure:TEMPerature

Examples:

:CONFigure: TEMPerature sets the temperature function.

:CONFigure:TCOMPensate:RANGe <NR2> (no query form)

Function:

Set the TC function and range.

Syntax:

:CONFigure:TCOMPensate:RANGe <NR2>

Examples:

:CONFigure:TCOMPensate:RAMGe 0 sets the TC function and auto-range.

:CONFigure: TCOMPensate:RAMGe 0.2 sets the TC function and 300m ohm range.

<NR2> is in ohm unit.

:CONFigure:TCOMPensate:COEFFicient

Function:

Set or query temperature coefficient for TC function.

Syntax:

:CONFigure:TCOMPensate:COEFFicient<NR1>

<NR1> is in the range from -9999 to 9999.

:CONFigure:TCOMPensate:COEFFicient?

Returns:<String>

Examples:

:CONFigure: :TCOMPensate:COEFFicient 3930 sets the temperature coefficient to 3930ppm.

:CONFigure: :TCOMPensate:COEFFicient? Return “+3930 ” to indicate the temperature coefficient 3930ppm.

<NR2> is in ppm unit.

:CONFigure:TCOMPensate:TEMPerature

Function:

Set or query require temperature for the TC function.

Syntax:

:CONFigure:TCOMPensate:TEMPerature<NR2>

<NR2> is in the range from 0.00 to 100.0.

:CONFigure:TCOMPensate:TEMPerature?

Returns:<String>

Examples:

:CONFigure:TCOMpensate:TEMPerature 20 sets require temperature to 20.0°C.

:CONFigure: TCOMpensate:TEMPerature? return “+2.0000E+1” to indicate the 20.0°C.

The setting value and return values is in °C unit.

:CONFigure:SPEEd

Function:

Set or query speed mode on or off.

Syntax:

:CONFigure:SPEEd <Boolean>

<Boolean> can be 0 (off) or 1 (on).

:CONFigure:SPEEd?

Return:

0/1

Examples:

:CONFigure:SPEEd 1 sets speed mode, the conversation rate is 30 times/second.

:CONFigure:SPEEd? return “1” to indicate the conversation rate is 30 times/second.

:CONFigure:SCAN:STATE

Function:

Set or query scan mode on or off.

Syntax:

:CONFigure:SCAN:STATE <Boolean>

<Boolean> can be 0 (off) or 1 (on).

:CONFigure:SCAN:STATE?

Return:

0/1

Examples:

:CONFigure:SCAN:STATE 1 sets the scan mode on.

:CONFigure:SCAN:STATE? return “1” to indicate that the scan mode is on.

:CONFigure:SCAN:CHANnel

Function:

Set or query the channel for scan.

Syntax:

:CONFigure:SCAN:CHANnel <NR1>

<NR1> is in the range from 0 to 1 .

:CONFigure:SCAN:CHANnel?

Return:

0/1

Examples:

:CONFigure: :SCAN:CHANnel 8 sets the channel of scan.

:CONFigure:SCAN:CHANnel? Return 8 to indicate that there are 8 channels need to be swept.

:CONFigure:SCAN:DElay

Function:

Set or query the delay of scan.

Syntax:

:CONFigure:SCAN:DElay <NR1>

<NR1> is in the range from 30 to 30000. 16.2ms per unit.

:CONFigure:SCAN:DElay?

Return: <NR1> is in the range from 30 to 30000.

Examples:

:CONFigure:SCAN:DElay 300 sets delay to 300 units..

:CONFigure:SCAN:DElay? Return "00300", total 5 characters.

:CONFigure:BUZZer

Function:

Set or query the setting of the buzzer mode.

Syntax:

:CONFigure:BUZZer <NR1>

<NR1> can be 0 (on) 1(bp) or 2 (bf).

:CONFigure:BUZZer?

Return:

0/1/2

Examples:

:CONFigure:BUZZer 0 sets the buzzer mode to be not active

:CONFigure:BUZZer? Return "1" to indicate that the buzzer mode is at bp. (When the compare result comes out to be PASS, the buzzer will sound the alert.)

:CONFigure:TRIGger

Function:

Set or query trig mode on or off.

Syntax:

:CONFigure:TRIGger <Boolean>

<Boolean> can be 0 (off) or 1 (on).

:CONFigure:TRIGger?

Return:

0/1

Examples:

:CONFigure:TRIGger 1 sets the trig mode on.

:CONFigure:TRIGger? Might return "1" to set the trig mode on

:READ?(query only)

Function:

Returns the measurement value with 14 characters totally.

Syntax:

:READ?

Return: <String>

Examples:

:READ? Might return “ +2.2000E+4” when the current function is in the ohm and indicate the reading to 22000k Ω . The return value is in ohm unit. When the reading is overload, the meter will return to “+9.0000E+9”.

:MEASure <X>?(query only)

Function:

Returns the sweep results in scan mode, including HI/LO/GO and value with 12 characters totally.

Syntax:

:MEASure<X>?

Return:<String>

Examples:

:MEASure 5? might return “2,+3,1000E+2” indicates the measurement result of channel 5. The return value is in ohm unit. (The first number of return value is to indicate the compare result: 0=Low, 1=Pass, 2=High, - = no active, now the number is 2 which indicates the compare result is high.)

:SHOW?(query only)

Function:

In scan mode, returns 100 groups compare judgment of sweep result with 100 characters totally.

Syntax:

:SHOW?

Return:<String>

Examples:

: SHOW? might return “ 1201.... ” total 100 groups compare result.
(0: LOW, 1: PASS, 2: HIGH, -: not active)

:CALCulation:LIMit:STATe

Function:

Returns or sets the compare mode on or off.

Syntax:

:CALCulation:LIMit:STATe <Boolean>

<Boolean> can be o(off) or 1(on)

:CALCulation:LIMit:STATe?

Returns:

0/1

Examples:

:CALCulation:LIMit:STATe? might return 1 in the compare mode.

:CALCulation:LIMit:STATe 1 sets the compare mode.

:CALCulation:LIMit:LOWer

Function:

Returns or sets the value of the lower limit in the compare mode.

Syntax:

:CALCulation:LIMit:LOWer?

Returns: <NR2>

<NR2> is in the range from 0 to 99.9.

:CALCulation:LIMit:LOWer <NR2>

Examples:

:CALCulation:LIMit:LOWer? might return "+10.0 " in the COMP mode. It sets down limit percentage to 10%.

:CALCulation:LIMit:LOWer 20 sets 20% down limit percentage in the COMP mode.

:CALCulation:LIMit:UPPer

Function:

Returns or sets the value of the upper limit in the compare mode.

Syntax:

:CALCulation:LIMit:UPPer?

Returns: <NR2>

<NR2> is in the range from 0 to 99.9.

:CALCulation:LIMit:UPPer <NR2>

Examples:

:CALCulation:LIMit:UPPer? might return "+10.0 " in the COMP mode. It sets up limit percentage to 10%.

:CALCulation:LIMit:UPPer 20 sets 20% up limit percentage in the COMP mode.

:CALCulation:LIMit:FAIL?(query only)

Function:

Returns limit result.

Syntax:

:CALCulation:LIMit:FAIL?

Returns:

0 (Low)/1 (Pass)/2 (High)

Examples:

:CALCulation:LIMit:FAIL? might return "1" to indicate pass.

:CALCulation:LIMit:NORMal

Function:

Returns or sets the normal value.

Syntax:

:CALCulation:LIMit:NORMal?

Returns: <NR1>

<NR1> is in the range from 0 to 33000.

:CALCulation:LIMit:NORMal <NR1>

Examples:

:CALCulation:LIMit:NORMal? might return 10000 in the COMP mode.

:CALCulation:LIMit:NORMal 10000 sets the normal value at 10000.

:CALCulation:RELation:STATe

Function:

Returns or sets the REL mode on or off.

Syntax:

:CALCulation:RELation:STATe?

Return:

0/1

:CALCulation:RELation:STATe <Boolean>

<Boolean> can be 0(off) or 1(on).

Examples:

:CALCulation:RELation:STATe? might return 1 in the REL mode.

:CALCulation:RELation:STATe 1 sets the REL mode.

:CALCulation:RELation:DATA

Function:

Returns or sets the reference value in the REL mode.

Syntax:

:CALCulation:RELation:DATA?

Return: <String>

:CALCulation:RELation: DATA <NR2>

<NR2> is in ohm unit.

Examples:

:CALCulation:RELation:DATA? might return "+1.0000E+0" to indicate 1 ohm.

:CALCulation:RELation:DATA 1.0000 sets 1.0000 ohm at the reference standard value.

:CALCulation:PERCent:STATe

Function:

Returns or sets the percent mode on or off.

Syntax:

:CALCulation:PERCent?

Return:

0/1

:CALCulation: PERCent <Boolean>

<Boolean> can be 0 (off) or 1 (on).

Examples:

:CALCulation: PERCent? might return 1 in the percent mode.

:CALCulation: PERCent 1 sets the percent mode.

STATus:OPERation:CONDition? (query only)

Function:

Return the contents of the OPERation register. The METER, however, do not use the OPERation register to report any conditions.

Syntax:

STATus:OPERation:CONDition?

Returns:

<NR1>

Examples:

STATus:OPERation:CONDition? returns 0.

STATus:OPERation:ENABLE

Function:

Set or query the enable mask that allows the masked conditions in the event register to be reported in the summary bit. If a bit is 1 (true) in the enable register and its associated event bit changes to 1 (true), the associated summary bit will change to 1 (true). Even though this is a 16-bit register, only 15 bits (bit 0 through bit 14) are used. Bit 15 always reads 0.

Syntax

STATus:OPERation:ENABLE <NR1>

STATus:OPERation:ENABLE?

<NR1> is an integer from 0 to 32767.

Returns

<NR1>

Examples

STATus:OPERation:ENABLE 32767 sets all 15 bits of the register to 1.

If the STATus:OPERation:ENABLE? returns 0, all 15 bits of the register are 0.

STATus:OPERation:EVENT(query only)

Function:

Returns and clears the contents of the OPERation register.

Syntax:

STATus:OPERation:EVENT?

Returns:

<NR1>

Examples:

STATus:OPERation:EVENT? returns 0.

STATus:PRESet

Function:

Set the OPERation and QUESTIONable enable registers to zeros.

Syntax:

STATus:PRESet

STATus:QUESTIONable:CONDition? (query only)

Function:

Return the contents of the QUESTIONable register. Reading the condition register is non-destructive.

Syntax:

STATus:QUESTIONable:CONDition?

Returns:

<NR1>

Examples:

STATus:QUESTIONable:CONDition? returns 0.

STATus:QUESTIONable:ENABLE

Function:

Set or query the enable mask that allows the masked conditions in the event register to be reported in the summary bit. If a bit is 1 (true) in the enable register and its associated event bit changes to 1 (true), the associated summary bit will change to 1 (true). Even though this is a 16-bit register, only 15 bits (bit 0 through bit 14) are used. Bit 15 always reads 0.

Syntax:

STATus:QUESTIONable:ENABle <NR1>

STATus:QUESTIONable:ENABle?

<NR1> is an integer from 0 to 32767.

Returns:

<NR1>

Examples:

STATus:QUESTIONable:ENABle 32767 sets all 15 bits of the register to 1.

If the STATus:QUESTIONable:ENABle? returns 0, all 15 bits of the register are 0.

STATus:QUESTIONable:EVENT(query only)

Function:

Return and clear the contents of the QUESTIONable register. The response is a decimal value that summarizes the binary values of the set bits.

Syntax:

STATus:QUESTIONable:EVENT?

Returns:

<NR1>

Examples:

STATus:QUESTIONable:EVENT? returns 0.

SYSTEM:ERROR? (query only)

Function:

Query the next error message from the Error/Event queue. The result of the query is the error number followed by the error text.

Syntax:

SYSTEM:ERROR?

Returns:

<string>

Examples:

SYSTem:ERRor? returns 0, “No error”

SYSTem:VERSion? (query only)

Function:

Return the SCPI version of the device.

Syntax:

SYSTem:VERSion?

Returns:

1994.0

7. STATUS AND ERROR REPORTING

A set of status registers allows the user to quickly determine the Meter’s internal processing status. The status register, as well as the status and event reporting system, adhere to SCPI recommendations.

Structure of System

The sketch of the status and event reporting system is shown as figure 7. Each component of the sketch represents a set of registers and queues that can read, report, or enable the occurrence of certain events within the system.

If a specific event in the Meter sets a bit in a *status register*, reading which can tell you what types of events have occurred.

Each bit in the status register corresponds to a bit in an *enable register*; the enable bit must be high for the event to be reported to the Status Byte Register.

A Service Request (SRQ) is the last event to occur. The SRQ requests an interrupt on the GPIB to report events to the system controller.

Status Registers

There are two kinds of status registers included to the Meter.

- OPERATION Status Registers (CONDition, EVENT, and ENABLE)
- QUESTionable Status Registers (CONDition, EVENT, and ENABLE)

The lower level nodes: QUESTionable and OPERATION each have three 16 bits registers: CONDition, EVENT, and ENABLE. Figure 8 shows the sequential relationship between these three types of registers and the commands that relate to each register.

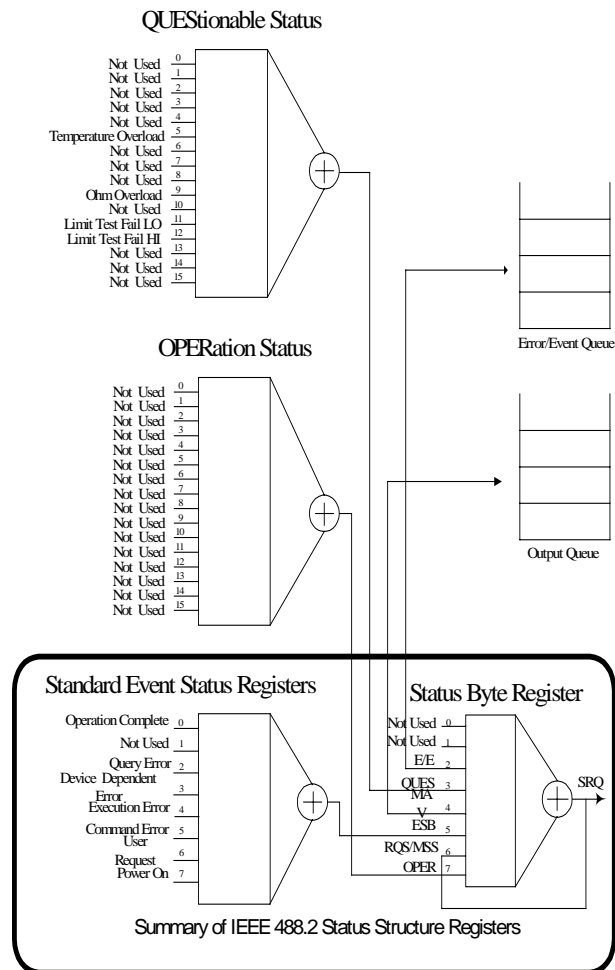

Figure 7. A graphic representation of the status registers and their connections.

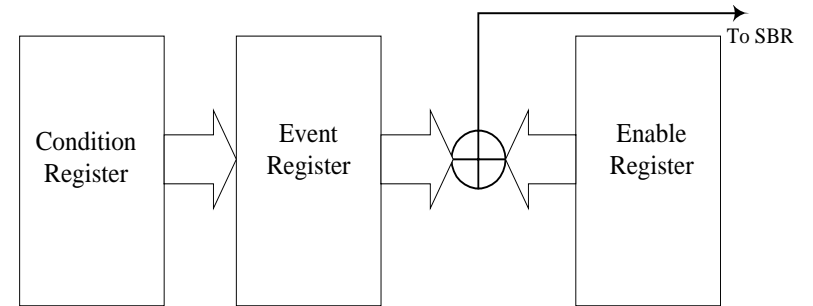

Figure 8: Status registers and related commands

The CONDition register is a read-only register which monitors the present state of the instrument. The CONDition register updates in real time and the inputs are not latched or buffered. When a condition monitored by the CONDition register becomes true, the bit for that condition also becomes true (1). When the condition is false, the bit is 0. The read-only EVENT register latches any false-to-true change in condition. Once the bit in the EVENT register is set, it is no longer affected by changes in the corresponding bit of the CONDition register. The bit remains set until the controller reads it. The command *CLS (Clear Status) clears the EVENT register.

QUESTIONable Status Registers.

Table 4 shows the bit designations of the 16 bit QUESTIONable Status Register.

Table 4: QUEStionable Status Register

Bit 15	Bit 14	Bit 13	Bit 12	Bit 11	Bit 10	Bit 9	Bit 8
	*NU	NU	Limit Test Fail HI	Limit Test Fail LO	NU	Ohm Overload	NU
Bit 7	Bit 6	Bit 5	Bit 4	Bit 3	Bit 2	Bit 1	Bit 0
NU	NU	Temperature Overload	NU	NU	NU	NU	NU

The command `STATus:QUEStionable:CONDition?` Reads the QUEStionable CONDition register but dose not clear it.

The command `STATus:QUEStionable:EVENT?` Reads the QUEStionable EVENT Status register and clears it.

OPERation Status Registers

Table 5 shows the bit designations of the 16 bit OPERation Status Register.

Table 5: OPERation Status Register

Bit 15	Bit 14	Bit 13	Bit 12	Bit 11	Bit 10	Bit 9	Bit 8
	NU	NU	NU	NU	NU	NU	NU
Bit 7	Bit 6	Bit 5	Bit 4	Bit 3	Bit 2	Bit 1	Bit 0
NU	NU	NU	NU	NU	NU	NU	NU

* NU: not used

Status Registers

There are two status registers are included to the Meter defined by IEEE-488.1 and IEEE-488.2 standards.

- Status Byte Register (SBR)
- Standard Event Status Register (SESR)

Status Byte Register (SBR): The SBR (Table 6) summarizes the status of all other registers and queues.

Table 6: Status Byte Register (SBR)

Bit 7	Bit 6	Bit 5	Bit 4	Bit 3	Bit 2	Bit 1	Bit 0
OPER	RQS/MSS	ESB	MAV	QUES	E/E	NU	NU

The bit 0 and 1 are not used, so these bits are always zero. The bit 2 (Error and Event) indicates an error code is waiting to be read in the Error Event Queue. The bit 3 (QUES, QUEStionable) is the summary bit for the QESR (QUEStionable Event Status Register). When the bit is high it indicates that status is enabled and present in the QUES. The bit 4 (MAV, Message Available) indicates that output is available in the output queue. The bit 5 (ESB, Event Status Bit) is the summary bit for the Standard Event Status Register (SESR). When the bit is high it indicates that status is enabled and present in the SESR. The bit 6 (RQS, Request Service) is obtained from a serial poll and shows that the METER requests service from the GPIB controller. The bit 7 (OPER, OPERation) is the summary bit for the OESR (OPERation EVENT STATus Register).

Use the serial poll or the *STB? Query to read the contents of the SBR. The bits in the SBR are set and cleared depending on the contents of the Standard Event Status Register (SESR), the Standard Event Status Register (SESR), and the Output Queue.

Standard Event Status Register (SESR): Table 7 shows the SESR

Table 7: Standard Event Status Register (SESR)

Bit 7	Bit 6	Bit 5	Bit 4	Bit 3	Bit 2	Bit 1	Bit 0
PON	URQ	CME	EXE	DDE	QYE	NU	OPC

The bit 0 (OPC, Operation Complete) shows that the operation is completed. This bit is active when all pending operations are completed following an *OPC command. The bit 1 is always zero. The bit 2 (QYE, Query Error) indicates a command or query protocol error. The bit 3 (DDE, Device Error) shows that a device error occurred. The bit 4 (EXE, Execution Error) shows that an error occurred while the METER was executing a command or query. The bit 5 (CME, Command Error) shows that an error occurred while the METER was parsing a command or query. The bit 6 (USR, User Request) indicates the LOCAL button was pushed. The bit 7 (PON, Power On) shows that the METER was powered on.

Use the *ESR? Query to read the SESR. Read the SESR and clear the bits of the registers so that the register can accumulate information about new events.

Enable Registers

The enable registers determine whether certain events are reported to the Status Byte Register and SRQ. The Meter has the following enable

registers.

- Event Status Enable Register (ESER)
- OPERation Enable Register
- QUEStionable Enable Register
- Service Request Enable Register (SRER)

When one of the bits of the enable registers is high and the corresponding bit in the status register is high, the enable registers will perform a logical OR function, the output that controls the set bit of the Status Byte Register is high.

Various commands set the bits in the enable registers. The following sections describe the enable registers and the commands that set them.

Event Status Enable Register (ESER): The ESER controls which types of events are summarized by the Event Status Bit (ESB) in the SBR. The bits of the ESER correspond to the bits of the SESR.

Use the *ESE command to set the bits in ESER. Use the *ESE? query to read it.

OPERation Enable Register: Even though the OPERation Enable Register is present in the METER, the OPERation registers do not report any conditions.

QUEStionable Enable Register: The QUEStionable Enable Register controls which types of events are summarized by the QUES status bit in the SBR. Use the STATUS:QUEStionable:ENABLE command to set the bits in the QUEStionable Enable register. Use the STATUS:QUEStionable:ENABLE? query to read it.

Service Request Enable Register (SRER): The SRER controls which bits in the SBR generate a service request.

Use the *SRE command to set the SRER. Use the *SRE? query to read it.

Queues

The output queue is included to power supplies.

Output Queue: The METER store query responses in the output queue by succeeding the IEEE 488.2 protocol. If the METER receives a new command or query message after a message terminator, the METER will clear and reset this queue each time. The computer must read a query response before it sends the next command (or query) or it loses response to earlier queries.

Error/Event Queues

When an error or event occurs, the output queue stores the message. The output queue stores and reports the messages on a FIFO (first in first out) state. The `SYSTEM:ERROR?` query reads the next item from the output queue. If output queue overflows, the error message is `-350, "Queue overflow"`; the queue can't store or report succeeding messages till it is read or cleared.

Error Message

Table 8 lists the SCPI error messages for the METER.

Table 8 The error messages for the METER:

SCPI Error Code and Description	SESR Bit
0, "No error"	
-100, "Command error"	5
-200, "Execution Error"	4
-221, "Settings conflict"	4
-222, "Data out of range"	4
-350, "Queue overflow"	3
-410, "Query INTERRUPTED"	2
-420, "Query UNTERMINATED"	2
-430, "Query DEADLOCKED"	2