

Mixed-Domain Oscilloscope

MDO-2000E series

PROGRAMMING MANUAL



ISO-9001 CERTIFIED MANUFACTURER

GW INSTEK

Jun 2018

This manual contains proprietary information which is protected by copyright. All rights are reserved. No part of this manual may be photocopied, reproduced or translated to another language without prior written consent of Good Will Corporation.

The information in this manual was correct at the time of printing. However, Good Will continues to improve products and reserves the right to change specifications, equipment, and maintenance procedures at any time without notice.

Windows is a registered trademark of Microsoft Corporation in the United States and other countries.

Good Will Instrument Co., Ltd.
No. 7-1, Jhongsing Rd., Tucheng Dist., New Taipei City 236, Taiwan.

Table of Contents

INTERFACE OVERVIEW	3
Interface Configuration	3
COMMAND OVERVIEW	13
Command Syntax	13
List of Commands in Functional Order	15
COMMAND DETAILS	31
Common Commands	33
Acquisition Commands	39
Autoscale Commands	47
Vertical Commands	48
Math Commands	54
Cursor Commands	63
Display Commands	73
Hardcopy Commands	78
Measure Commands	81
Measurement Commands	107
Reference Commands	114
Run Command	117
Stop Command	117
Single Command	117
Force Command	118
Timebase Commands	119
Trigger Commands	122
System Commands	164
Save/Recall Commands	165
Ethernet Command	170
Time Command	170
Bus Decode Commands	171
Mark Commands	186

Search Commands	188
Label Commands	221
Segment Commands	229
DVM Commands.....	238
Go_NoGo Commands	240
AWG Commands	246
Data Logging Commands	265
Remote Disk Commands	268
DMM Commands.....	271
Spectrum Analyzer Commands	276
Power Supply Commands.....	290
USB Delay Command	292
Digital Commands	293
APPENDIX.....	301
Error messages	301
INDEX.....	305

INTERFACE OVERVIEW

This manual describes how to use the MDO-2000E's remote command functionality and lists the command details. The Overview chapter describes how to configure the USB and Ethernet remote control interfaces.

Interface Configuration

Configure USB Interface

USB Configuration	PC side connector	Type A, host
	MDO-2000E side connector	Type B, device
	Speed	1.1/2.0
	USB Class	CDC (communications device class)

- Panel Operation
1. Press the Utility key.
 2. Press *I/O* from the bottom menu.
 3. Press *USB Device Port* from the side menu and select *Computer*.
 4. Connect the USB cable to the rear panel device port.

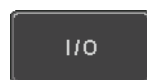

- When the PC asks for the USB driver, select the USB driver included on the accompanying User Manual CD or download the driver from the GW Instek website, www.gwinstek.com, in the MDO-2000E Download section. The driver automatically sets the MDO-2000E as a serial COM port (Shown as VPO in the PORTS node).

USB Functionality Check

Terminal Application

Invoke a terminal application such as RealTerm.

Set the COM port, baud rate, stop bit, data bit, and parity accordingly.

To check the COM port number and associated port settings, see the Device Manager in the PC. For Windows 7:

Control panel → Hardware and Sound → Device Manager

Example: Configuring RealTerm:

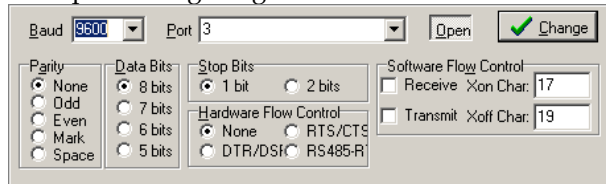

Functionality Check

Key in this query command via the terminal application.

`*idn?`



This should return the Manufacturer, Model number, Serial number, and Firmware version in the following format.

GW,MDO-2202E,PXXXXXX,V1.00

Configure the Ethernet Interface

Ethernet Configuration	MAC Address	Domain Name
	Instrument Name	DNS IP Address
	User Password	Gateway IP Address
	Instrument IP Address	Subnet Mask
		HTTP Port 80 (fixed)

Background The Ethernet interface is used for remote control using a socket server connection. For details, please see the Socket Server section on page 7.

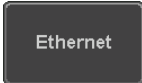
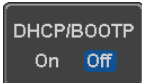
- Panel Operation**
1. Connect the Ethernet cable to the LAN port on the rear panel. 
 2. Press the *Utility* key. 
 3. Press *I/O* from the bottom menu. 
 4. Press *Ethernet* from the side menu. 
 5. Set *DHCP/BOOTP* to *On* or *Off* from the side menu. 



Note

IP addresses will automatically be assigned with DHCP/BOOTP set to on. For Static IP Addresses, DHCP/BOOTP should be set to off.

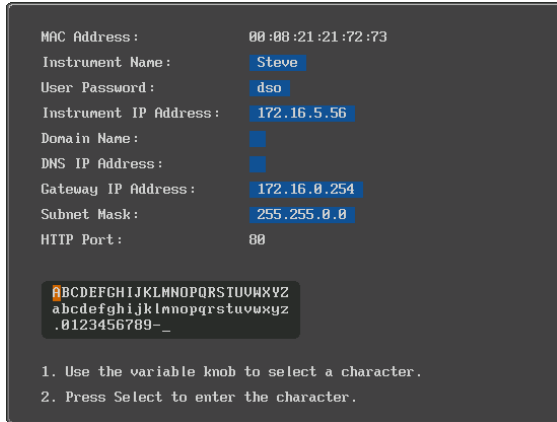

6. Use the *Up* and *Down* arrows on the side menu to navigate to each Ethernet configuration item.

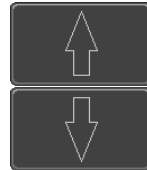

Items MAC Address, Instrument Name, User Password, Instrument IP Address, Domain Name, DNS IP Address, Gateway IP Address, Subnet Mask

Note: HTTP Port is fixed at 80.

7. Use the *Variable* knob to highlight a character and use the *Select* key to choose a character.

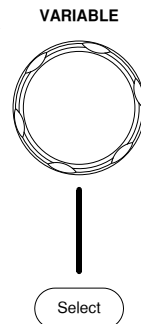

Press *Backspace* to delete a character.



Press *Save Now* to save the configuration. Complete will be displayed when successful.

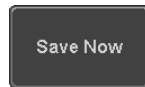

Configure Socket Server

The MDO-2000E supports socket server functionality for direct two-way communication with a client PC or device over LAN. By default, the Socket Server is off.

Configure Socket Server

1. Configure the IP address for the MDO-2000E.

Page 5

2. Press the *Utility* key.



3. Press *I/O* from the bottom menu.

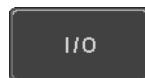

4. Press *Socket Server* from the side menu.

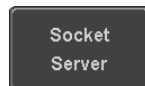

5. Press *Select Port* and choose the port number with the Variable knob.

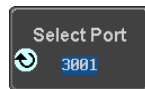

Range 1024~65535

6. Press *Set Port* to confirm the port number.

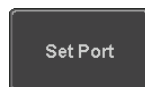

7. The Current Port icon will update to the new port number.



8. Press *Server* and turn the socket server On.

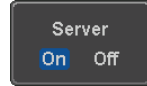

Socket Server Functionality Check

NI Measurement and Automation Explorer To test the socket server functionality, National Instruments Measurement and Automation Explorer can be used. This program is available on the NI website, www.ni.com.

- | | |
|-----------|---|
| Operation | <ol style="list-style-type: none"> 1. Configure the IP address for the MDO-2000E. Page 5 2. Configure the socket port. Page 7 3. Start the NI Measurement and Automation Explorer (MAX) program. Using Windows, press: |
|-----------|---|



Start>All Programs>National Instruments>Measurement & Automation



4. From the Configuration panel access;

My System>Devices and Interfaces>Network Devices

5. Right click *Network Devices* and select *Create New Visa TCP/IP Resource...*

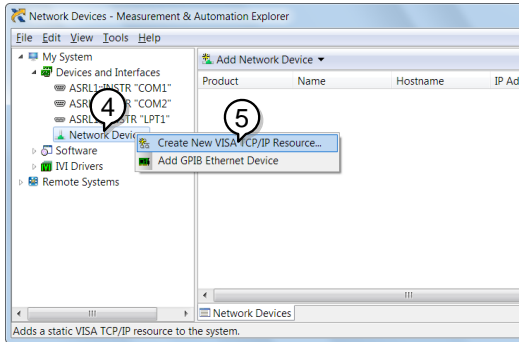

6. Select *Manual Entry of Raw Socket* from the popup window.
7. Click *Next*.

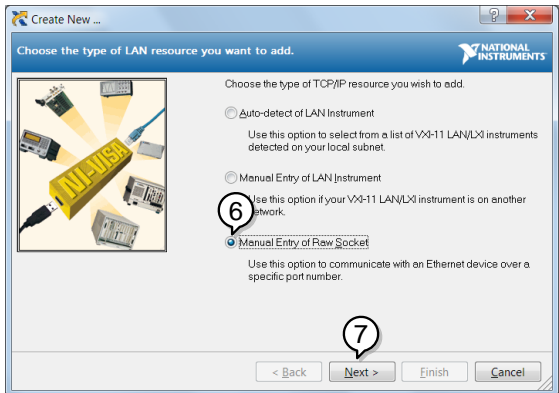

8. Enter the MDO-2000E's IP address and socket port number.
9. Click *Validate*.
10. A popup will appear to tell you if a VISA socket session was successfully created.
11. Click *Next*.

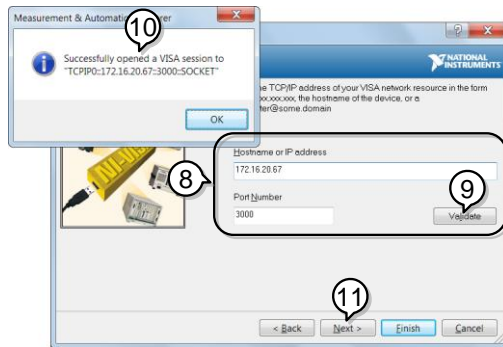

12. Choose an alias for the socket connection if you like.
13. Click *Finish* to finish the configuration.

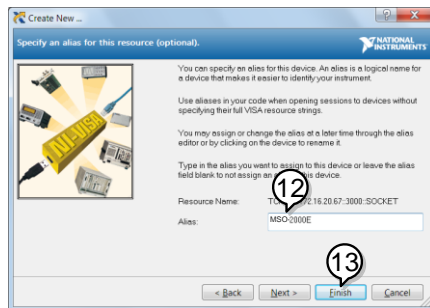

14. The MDO-2000E will now appear under Network Devices in the Configuration Panel.

Functionality
Check

- Click the *Open Visa Test Panel* to send a remote command to the MDO-2000E.

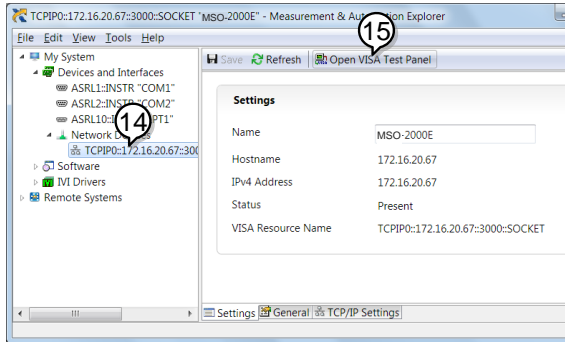

- Click on the *Configuration* icon.

- Select the *I/O Settings* tab.

- Mark the *Enable Termination Character* checkbox. Make sure the termination character is a line feed (/n, value: xA).

- Click *Apply Changes*.

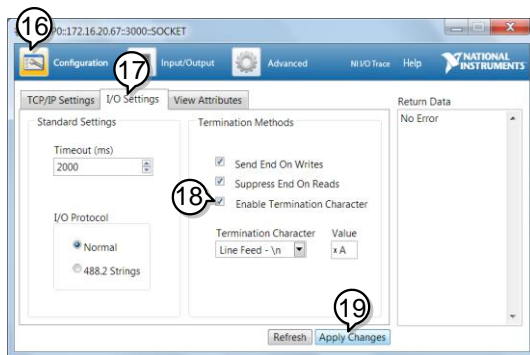

20. Click the *Input/Output* icon.
21. Make sure **IDN?* query is selected in the *Select or Enter Command* drop box.
22. Click on *Query*.
23. The manufacturer, model number, serial number and firmware version will be displayed in the buffer. For example:
GW,MDO-2202E,PXXXXXX,V1.00

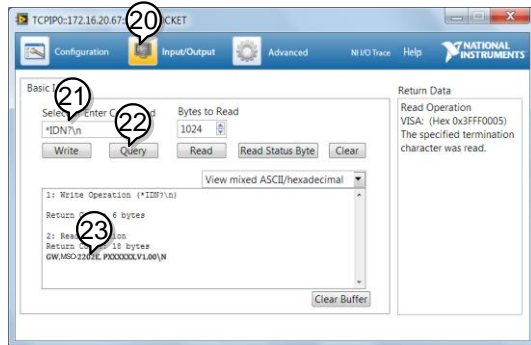

C COMMAND OVERVIEW

The Command overview chapter lists all MDO-2000E commands in functional order as well as alphabetical order. The command syntax section shows you the basic syntax rules you have to apply when using commands.

Command Syntax

Compatible standard

- USB CDC_ACM compatible
- SCPI, 1994 (partially compatible)

Command forms

Commands and queries have two different forms, long and short. The command syntax is written with the short form of the command in capitals and the remainder (long form) in lower case.

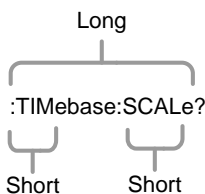

The commands can be written in capitals or lower-case, just so long as the short or long forms are complete. An incomplete command will not be recognized.

Below are examples of correctly written commands.

```

LONG :TIMEbase:SCALe? :TIMEBASE:SCALE?
      :timebase:scale?
  
```

SHORT :TIM:SCAL? :TIM:SCAL?

Command format :TIMbase:SCALE <NR3>LF

1: command header
 2: single space
 3: parameter
 4: message terminator

Parameter	Type	Description	Example
	<Boolean>	boolean logic	0, 1
	<NR1>	Integers	0, 1, 2, 3
	<NR2>	floating point	0.1, 3.14, 8.5
	<NR3>	floating point with an exponent	4.5e-1, 8.25e+1
	<NRf>	any of NR1, 2, 3	1, 1.5, 4.5e-1
Message terminator	LF	line feed code	

Note Commands are non-case sensitive.

List of Commands in Functional Order

Common	*IDN?	33
	*LRN?	33
	*SAV	34
	*RCL	34
	*RST	35
	*CLS	35
	*ESE	35
	*ESR	36
	*OPC	36
	*SRE	37
*STB	37	
Acquisition	:ACQuire:AVERage	39
	:ACQuire:MODE	40
	:ACQuire<X>:MEMory?	40
	:ACQuire:FILTer:SOURce	42
	:ACQuire:FILTer	43
	:ACQuire:FILTer:FREQuency	43
	:ACQuire:FILTer:TRACking	45
	:ACQuire<X>:STATe?	45
	:ACQuire:INTERpolation	45
	:ACQuire:RECOrdlength	46
:HEADer	46	
Autoscale	:AUTOSet	47
	:AUTORSET:MODE	47
Vertical Scale	:CHANnel<X>:BWLimit	48
	:CHANnel<X>:COUpling	49
	:CHANnel<X>:DESKew	49
	:CHANnel<X>:DISPlay	49
	:CHANnel<X>:EXPand	50
	:CHANnel<X>:IMPedance?	50

	:CHANnel<X>:INVert	51
	:CHANnel<X>:POSition	51
	:CHANnel<X>:PROBe:RATio	52
	:CHANnel<X>:PROBe:TYPe	52
	:CHANnel<X>:SCALe	52
<hr/>		
Math	:MATH:DISP	54
	:MATH:TYPe	55
	:MATH:DUAL:SOURce<X>	55
	:MATH:DUAL:OPERator	55
	:MATH:DUAL:POSition	56
	:MATH:DUAL:SCALe	56
	:MATH:FFT:SOURce	57
	:MATH:FFT:MAG	57
	:MATH:FFT:WINDow	57
	:MATH:FFT:POSition	58
	:MATH:FFT:SCALe	58
	:MATH:FFT:HORizontal:SCALe	59
	:MATH:FFT:HORizontal:POSition	59
	:MATH:DEFine	59
	:MATHVAR?	60
	:MATHVAR:VAR<X>	61
	:MATH:ADVanced:POSition	61
	:MATH:ADVanced:SCALe	61
<hr/>		
Cursor	:CURSor:MODE	64
	:CURSor:SOURce.....	64
	:CURSor:HUNI	65
	:CURSor:HUSE	65
	:CURSor:VUNI	66
	:CURSor:VUSE	66
	:CURSor:DDT.....	66
	:CURSor:H1Position	67
	:CURSor:H2Position.....	67
	:CURSor:HDELta	68
	:CURSor:V1Position.....	68

	:CURSor:V2Position.....	68
	:CURSor:VDELta	69
	:CURSor:XY:RECTangular:X:POSition<X>	69
	:CURSor:XY:RECTangular:X:DELta	69
	:CURSor:XY:RECTangular:Y:POSition<X>	70
	:CURSor:XY:RECTangular:Y:DELta	70
	:CURSor:XY:POLar:RADIUS:POSition<X>.....	70
	:CURSor:XY:POLar:RADIUS:DELta	71
	:CURSor:XY:POLar:THETA:POSition<X>	71
	:CURSor:XY:POLar:THETA:DELta.....	71
	:CURSor:XY:PRODuct:POSition<X>	72
	:CURSor:XY:PRODuct:DELta.....	72
	:CURSor:XY:RATio:POSition<X>	72
	:CURSor:XY:RATio:DELta	73
<hr/>		
Display	:DISPlay:INTensity:WAVEform.....	73
	:DISPlay:INTensity:GRATICule.....	74
	:DISPlay:INTensity:BACKLight	74
	:DISPlay:INTensity:BACKLight:AUTODim:ENABle	74
	:DISPlay:INTENSITY:BACKLight:AUTODim:TIME	75
	:DISPlay:PERSistence	75
	:DISPlay:GRATICule	76
	:DISPlay:WAVEform.....	76
	:DISPlay:OUTPut	76
<hr/>		
Hardcopy	:HARDcopy:START	78
	:HARDcopy:MODE	78
	:HARDcopy:PRINTINKSaver	79
	:HARDcopy:SAVEINKSaver	79
	:HARDcopy:SAVEFORMat	79
	:HARDcopy:ASSIGN.....	80
<hr/>		
Measure	:MEASure:GATing.....	82
	:MEASure:SOURce	82
	:MEASure:METHod	83
	:MEASUREMENT:REFLevel:PERCent:HIGH.....	83

:MEASUrement:REFLevel:PERCent:LOW	84
:MEASUrement:REFLevel:PERCent:MID	84
:MEASUrement:REFLevel:PERCent:MID2	84
:MEASure:FALL.....	85
:MEASure:FOVShoot.....	85
:MEASure:FPReshoot	86
:MEASure:FREQuency.....	86
:MEASure:NWIDth	87
:MEASure:PDUTy	87
:MEASure:PERiod	88
:MEASure:PWIDth	88
:MEASure:RISe	89
:MEASure:ROVShoot.....	89
:MEASure:RPReshoot.....	90
:MEASure:PPULSE.....	91
:MEASure:NPULSE.....	91
:MEASure:PEDGE	92
:MEASure:NEDGE	92
:MEASure:AMPlitude.....	93
:MEASure:MEAN	93
:MEASure:CMEan	94
:MEASure:HIGh	95
:MEASure:LOW.....	95
:MEASure:MAX.....	96
:MEASure:MIN	96
:MEASure:PK2PK.....	97
:MEASure:RMS	97
:MEASure:CRMS.....	98
:MEASure:AREa	99
:MEASure:CARea	99
:MEASure:FRRDelay	100
:MEASure:FRFDelay	100
:MEASure:FFRDelay	101
:MEASure:FFFDelay.....	102
:MEASure:LRRDelay	102

	:MEASure:LRFDelay.....	103
	:MEASure:LFRDelay.....	103
	:MEASure:LFFDelay.....	104
	:MEASure:PHase.....	105

Measurement	:MEASUrement:MEAS<X>:SOURCE<X>.....	107
	:MEASUrement:MEAS<X>:TYPe.....	108
	:MEASUrement:MEAS<X>:STATE.....	108
	:MEASUrement:MEAS<X>:VALue.....	109
	:MEASUrement:MEAS<X>:MAXimum.....	110
	:MEASUrement:MEAS<X>:MEAN.....	111
	:MEASUrement:MEAS<X>:MINimum.....	111
	:MEASUrement:MEAS<X>:STDdev.....	112
	:MEASUrement:STATIstics:MODE.....	113
	:MEASUrement:STATIstics:WEIghting.....	113
	:MEASUrement:STATIstics.....	113

Reference	:REF<X>:DISPlay.....	114
	:REF<X>:TIMEbase:POSition.....	114
	:REF<X>:TIMEbase:SCALE.....	115
	:REF<X>:OFFSet.....	115
	:REF<x>:SCALE.....	116

Run	:RUN.....	117
-----	-----------	-----

Stop	:STOP.....	117
------	------------	-----

Single	:SINGle.....	117
--------	--------------	-----

Force	:FORCe.....	118
-------	-------------	-----

Timebase	:TIMEbase:EXPand.....	119
	:TIMEbase:POSition.....	119
	:TIMEbase:SCALE.....	119
	:TIMEbase:MODE.....	120
	:TIMEbase:WINDow:POSition.....	120

	:TIMEbase:WINDow:SCALE	121
Trigger	:TRIGger:FREQuency.....	124
	:TRIGger:TYPe	124
	:TRIGger:SOURce	125
	:TRIGger:COUPlE.....	125
	:TRIGger:NREJ	126
	:TRIGger:MODe.....	126
	:TRIGger:HOLDoff.....	126
	:TRIGger:LEVel.....	127
	:TRIGger:HLEVel	127
	:TRIGger:LLEVel.....	128
	:TRIGger:EDGE:SLOP.....	128
	:TRIGger:DELaY:SLOP	128
	:TRIGger:DELaY:TYPe	129
	:TRIGger:DELaY:TIME.....	129
	:TRIGger:DELaY:EVENT.....	130
	:TRIGger:DELaY:LEVel	130
	:TRIGger:PULSEwidth:POLarity	130
	:TRIGger:RUNT:POLarity	131
	:TRIGger:RUNT:WHEn.....	131
	:TRIGger:RUNT:TIME.....	132
	:TRIGger:RISEFall:SLOP.....	132
	:TRIGger:RISEFall:WHEn	132
	:TRIGger:RISEFall:TIME	133
	:TRIGger:VIDeo:TYPe	134
	:TRIGger:VIDeo:FIELD	134
	:TRIGger:VIDeo:LINE	135
	:TRIGger:VIDeo:POLarity	135
	:TRIGger:PULSE:WHEn	135
	:TRIGger:PULSE:TIME	136
	:TRIGger:TIMEOut:WHEn.....	136
	:TRIGger:TIMEOut:TIMER	137
	:TRIGger:ALTErnate	137
	:TRIGger:STATE	138

:TRIGger:EXTERnal:PROBe:TYPe	138
:TRIGger:EXTERnal:PROBe:RATio	140
:TRIGger:BUS:TYPe	140
:TRIGger:BUS:THReshold:CH<x>	140
:TRIGger:BUS:B1:I2C:CONDition	141
:TRIGger:BUS:B1:I2C:ADDRes:MODE	142
:TRIGger:BUS:B1:I2C:ADDRes:TYPe	142
:TRIGger:BUS:B1:I2C:ADDRes:VALue	143
:TRIGger:BUS:B1:I2C:ADDRes:DIRection	143
:TRIGger:BUS:B1:I2C:DATA:SIZE	144
:TRIGger:BUS:B1:I2C:DATA:VALue	144
:TRIGger:BUS:B1:UART:CONDition	145
:TRIGger:BUS:B1:UART:RX:DATA:SIZE	146
:TRIGger:BUS:B1:UART:RX:DATA:VALue	146
:TRIGger:BUS:B1:UART:TX:DATA:SIZE	147
:TRIGger:BUS:B1:UART:TX:DATA:VALue	147
:TRIGger:BUS:B1:SPI:CONDition	148
:TRIGger:BUS:B1:SPI:DATA:SIZE	149
:TRIGger:BUS:B1:SPI:DATA:MISO:VALue	149
:TRIGger:BUS:B1:SPI:DATA:MOSI:VALue	150
:TRIGger:BUS:B1:CAN:CONDition	151
:TRIGger:BUS:B1:CAN:FRAMeType	151
:TRIGger:BUS:B1:CAN:IDentifier:MODE	152
:TRIGger:BUS:B1:CAN:IDentifier:VALue	152
:TRIGger:BUS:B1:CAN:IDentifier:DIRection	153
:TRIGger:BUS:B1:CAN:DATA:QUALifier	153
:TRIGger:BUS:B1:CAN:DATA:SIZE	154
:TRIGger:BUS:B1:CAN:DATA:VALue	155
:TRIGger:BUS:B1:LIN:CONDition	155
:TRIGger:BUS:B1:LIN:DATA:QUALifier	156
:TRIGger:BUS:B1:LIN:DATA:SIZE	157
:TRIGger:BUS:B1:LIN:DATA:VALue	157
:TRIGger:BUS:B1:LIN:ERRTYPE	158
:TRIGger:BUS:B1:LIN:IDentifier:VALue	159
:TRIGger:LOGic:INPut:CLOCK:SOURce	159

	:TRIGger:LOGic:INPut:CLOCK:EDGe.....	160
	:TRIGger:LOGic:FUNcTion	160
	:TRIGger:LOGic:PATtern	161
	:TRIGger:LOGic:PATtern:INPut:D<x>	161
	:TRIGger:LOGic:PATtern:DELtAtime.....	162
	:TRIGger:LOGic:PATtern:WHEn	162
<hr/>		
System	:SYSTem:LOCK	164
commands	:SYSTem:ERRor	164
<hr/>		
Save/Recall	:RECALL:SETUp	165
	:RECALL:WAVEform	165
	:SAVE:IMAGe	166
	:SAVE:IMAGe:FILEFormat.....	166
	:SAVE:IMAGe:INKSaver.....	167
	:SAVE:SETUp	167
	:SAVE:WAVEform.....	168
	:SAVE:WAVEform:FILEFormat	169
<hr/>		
Ethernet	:ETHERnet:DHCP	170
Command		
<hr/>		
Time Command	:DATE	170
<hr/>		
Bus Decode	:BUS1	172
Commands	:BUS1:STATE	172
	:BUS1:TYPe.....	172
	:BUS1:INPut	173
	:BUS1:I2C:ADDReSS:RWINClude	173
	:BUS1:I2C:SCLK:SOURce	174
	:BUS1:I2C:SDA:SOURce	174
	:BUS1:UART:BITRate.....	174
	:BUS1:UART:DATABits.....	175
	:BUS1:UART:PARItY.....	175
	:BUS1:UART:PACKEt	175
	:BUS1:UART:EOFPacket	176
	:BUS1:UART:TX:SOURce	176

	:BUS1:UART:RX:SOURce	177
	:BUS1:SPI:SCLK:POLARity	177
	:BUS1:SPI:SS:POLARity	177
	:BUS1:SPI:WORDSize	178
	:BUS1:SPI:BITORder	178
	:BUS1:SPI:SCLK:SOURce	178
	:BUS1:SPI:SS:SOURce	179
	:BUS1:SPI:MOSI:SOURce	179
	:BUS1:SPI:MISO:SOURce	179
	:BUS1:DISplay:FORMAt	180
	:LISTer:DATA	180
	:BUS1:CAN:SOURce	181
	:BUS1:CAN:PROBe	181
	:BUS1:CAN:SAMPLEpoint	181
	:BUS1:CAN:BITRate	182
	:BUS1:LIN:BITRate	183
	:BUS1:LIN:IDFORmat	183
	:BUS1:LIN:POLARity	183
	:BUS1:LIN:SAMPLEpoint	184
	:BUS1:LIN:SOURce	184
	:BUS1:LIN:STANDard	184
<hr/>		
Mark Commands	:MARK	186
	:MARK:CREATE	186
	:MARK:DELEte	187
<hr/>		
Search	:SEARCH:COPY	189
Commands	:SEARCH:STATE	190
	:SEARCH:TOTAL	190
	:SEARCH:TRIGger:TYPe	190
	:SEARCH:TRIGger:SOURce	191
	:SEARCH:TRIGger:EDGE:SLOP	191
	:SEARCH:TRIGger:LEVel	192
	:SEARCH:TRIGger:HLEVel	192
	:SEARCH:TRIGger:LLEVel	193

:SEARCH:TRIGger:PULSEWidth:POLarity	193
:SEARCH:TRIGger:RUNT:POLarity	194
:SEARCH:TRIGger:RISEFall:SLOP	194
:SEARCH:TRIGger:PULSE:WHEn	195
:SEARCH:TRIGger:PULSE:TIME	195
:SEARCH:TRIGger:RUNT:WHEn	196
:SEARCH:TRIGger:RUNT:TIME	196
:SEARCH:TRIGger:RISEFall:WHEn	197
:SEARCH:TRIGger:RISEFall:TIME	197
:SEARCH:TRIGger:BUS:TYPE	198
:SEARCH:TRIGger:BUS:B1:I2C:CONDition	198
:SEARCH:TRIGger:BUS:B1:I2C:ADDRes:MODE	199
:SEARCH:TRIGger:BUS:B1:I2C:ADDRes:TYPE	199
:SEARCH:TRIGger:BUS:B1:I2C:ADDRes:VALue	200
:SEARCH:TRIGger:BUS:B1:I2C:ADDRes:DIRectioN201	
:SEARCH:TRIGger:BUS:B1:I2C:DATA:SIZE	201
:SEARCH:TRIGger:BUS:B1:I2C:DATA:VALue	202
:SEARCH:TRIGger:BUS:B1:UART:CONDition	203
:SEARCH:TRIGger:BUS:B1:UART:RX:DATA:SIZE	204
:SEARCH:TRIGger:BUS:B1:UART:RX:DATA:VALue ..	204
:SEARCH:TRIGger:BUS:B1:UART:TX:DATA:SIZE	205
:SEARCH:TRIGger:BUS:B1:UART:TX:DATA:VALue ..	205
:SEARCH:TRIGger:BUS:B1:SPI:CONDition	206
:SEARCH:TRIGger:BUS:B1:SPI:DATA:SIZE	207
:SEARCH:TRIGger:BUS:B1:SPI:DATA:MISO:VALue ..	207
:SEARCH:TRIGger:BUS:B1:SPI:DATA:MOSI:VALue ..	208
:SEARCH:TRIGger:BUS:B1:CAN:CONDition	209
:SEARCH:TRIGger:BUS:B1:CAN:FRAMeType	210
SEARCH:TRIGger:BUS:B1:CAN:IDentifier:MODE ...	210
:SEARCH:TRIGger:BUS:B1:CAN:IDentifier:VALue ...	211
:SEARCH:TRIGger:BUS:B1:CAN:IDentifier:DIRectioN211	
:SEARCH:TRIGger:BUS:B1:CAN:DATA:QUALifier ...	212
:SEARCH:TRIGger:BUS:B1:CAN:DATA:SIZE	213
:SEARCH:TRIGger:BUS:B1:CAN:DATA:VALue	213
:SEARCH:TRIGger:BUS:B1:LIN:CONDition	214

	:SEARCH:TRIGger:BUS:B1:LIN:DATa:QUALifier	215
	:SEARCH:TRIGger:BUS:B1:LIN:DATa:SIZE	216
	:SEARCH:TRIGger:BUS:B1:LIN:DATa:VALue	216
	:SEARCH:TRIGger:BUS:B1:LIN:ERRTYPE	217
	:SEARCH:TRIGger:BUS:B1:LIN:IDentifier:VALue.....	218
	:SEARCH:FFTPeak:METHod	218
	:SEARCH:FFTPeak:METHod:MPEak.....	219
	:SEARCH:FFTPeak:SINFo.....	220
	:SEARCH:FFTPeak:LIST.....	220
<hr/>		
Label Commands	:CHANnel<X>:LABel.....	221
	:CHANnel<X>:LABel:DISPlay	222
	:REF<X>:LABel	222
	:REF<X>:LABel:DISPlay	223
	:BUS1:LABel	224
	:BUS1:LABel:DISPlay	224
	:D<x>:LABel	225
	:D<x>:LABel:DISPlay.....	226
	:DIGital:ANALog:A<x>:LABel	226
	:DIGital:ANALog:A<x>:LABel:DISPlay	227
	:SET<X>:LABel	228
<hr/>		
Segment	:SEGMENTS:STATE	229
Commands	:SEGMENTS:CURRent	230
	:SEGMENTS:TOTAlnum	230
	:SEGMENTS:TIme	231
	:SEGMENTS:DISPAll	231
	:SEGMENTS:MEASure:MODE	231
	:SEGMENTS:MEASure:PLOT:SOURce	232
	:SEGMENTS:MEASure:PLOT:DIVide	232
	:SEGMENTS:MEASure:PLOT:SElect	233
	:SEGMENTS:MEASure:PLOT:RESults.....	233
	:SEGMENTS:MEASure:TABLE:SOURce	234
	:SEGMENTS:MEASure:TABLE:SElect.....	234
	:SEGMENTS:MEASure:TABLE:LIST.....	235

	:SEGMENTS:MEASURE:TABLE:SAVE	235
	:SEGMENTS:SAVE	235
	:SEGMENTS:SAVE:SOURCEN	236
	:SEGMENTS:SAVE:SELECT:START	236
	:SEGMENTS:SAVE:SELECT:END	237

DVM Commands	:DVM:STATE	238
	:DVM:SOURCEN	238
	:DVM:MODE	239
	:DVM:VALUE	239

Go-NoGo	:GONOGO:CLEAR	240
Commands	:GONOGO:EXECUTE	240
	:GONOGO:FUNCTION	241
	:GONOGO:NGCOUNT	241
	:GONOGO:NGDEFINE	241
	:GONOGO:SOURCEN	242
	:GONOGO:VIOLATION	242
	:GONOGO:SCRIPT	242
	:TEMPLATE:MODE	243
	:TEMPLATE:MAXIMUM	243
	:TEMPLATE:MINIMUM	243
	:TEMPLATE:POSITION:MAXIMUM	244
	:TEMPLATE:POSITION:MINIMUM	244
	:TEMPLATE:SAVE:MAXIMUM	244
	:TEMPLATE:SAVE:MINIMUM	245
	:TEMPLATE:TOLERANCE	245
	:TEMPLATE:SAVE:AUTO	245

AWG Commands	:AWG<x>:AMPLITUDE	247
	:AWG<x>:FREQUENCY	247
	:AWG<x>:FUNCTION	248
	:AWG<x>:OFFSET	249
	:AWG<x>:OUTPUT:LOAD:IMPEDANCE	249
	:AWG<x>:OUTPUT:STATE	249

:AWG<x>:PHase.....	250
:AWG<x>:PULSe:DUTYcycle	250
:AWG<x>:RAMP:SYMmetry	250
:AWG<x>:MODulation:STATE	251
:AWG<x>:MODulation:TYPe.....	251
:AWG<x>:MODulation:AM:DEPth	251
:AWG<x>:MODulation:AM:FREQ	252
:AWG<x>:MODulation:AM:SHApe.....	252
:AWG<x>:MODulation:AM:PHase	252
:AWG<x>:MODulation:AM:DUTYcycle.....	253
:AWG<x>:MODulation:AM:SYMmetry	253
:AWG<x>:MODulation:AM:RATE	253
:AWG<x>:MODulation:FM:DEV	254
:AWG<x>:MODulation:FM:FREQ	254
:AWG<x>:MODulation:FM:SHApe	255
:AWG<x>:MODulation:FM:PHase	255
:AWG<x>:MODulation:FM:DUTYcycle.....	256
:AWG<x>:MODulation:FM:SYMmetry.....	256
:AWG<x>:MODulation:FM:RATE.....	256
:AWG<x>:MODulation:FSK:FREQ	257
:AWG<x>:MODulation:FSK:RATE.....	257
:AWG<x>:SWEep:STATE	258
:AWG<x>:SWEep:TYPe.....	258
:AWG<x>:SWEep:START	258
:AWG<x>:SWEep:STOP.....	259
:AWG<x>:SWEep:TIME.....	259
:AWG<x>:SWEep:SPAN.....	259
:AWG<x>:SWEep:CENTer	260
:AWG<x>:ARBitrary:EDIT:NUMPoint	260
:AWG<x>:ARBitrary:EDIT:FUNcTION.....	260
:AWG<x>:ARBitrary:SAVe:WAVEform	261
:AWG<x>:ARBitrary:LOAd:WAVEform	261
:AWG<x>:ARBitrary:EDIT:COpy.....	262
:AWG<x>:ARBitrary:EDIT:CLEar.....	262
:AWG<x>:ARBitrary:EDIT:LINE	263

	:AWG<x>:ARBitrary:EDIT:SCALE	263
	:AWG<x>:ARBitrary:EDIT:POINt.....	263
	:AWG<x>:ARBitrary:EDIT:POINt:ADD.....	264
	:AWG<x>:ARBitrary:EDIT:POINt:DELEte	264
<hr/>		
Data Logging	:DATALOG:STATE	265
Commands	:DATALOG:SOURce	265
	:DATALOG:SAVe	266
	:DATALOG:INTerval.....	266
	:DATALOG:DURation.....	267
<hr/>		
Remote Disk	:REMOTEDisk:IPADdress	268
Commands	:REMOTEDisk:PATHName	268
	:REMOTEDisk:USERName	269
	:REMOTEDisk:PASSWord	269
	:REMOTEDisk:MOUNT	269
	:REMOTEDisk:AUTOMount	270
<hr/>		
DMM	:DMM.....	271
Commands	:DMM:STATE.....	271
	:DMM:VALue	272
	:DMM:HOLD.....	272
	:DMM:MMIN	272
	:DMM:MODe	273
	:DMM:MODe:RANGe	273
	:DMM:TEMPerature:UNITs	274
	:DMM:TEMPerature:TYPe.....	274
	:DMM:TEMPerature:SIM	275
<hr/>		
Spectrum	:SA:MEMory?	277
Analyzer	:SA:MEMory:SOURce.....	280
Commands	:SA:SOURce	280
	:SA:SPECTRUMTrace	280
	:SElect:NORMal.....	281
	:SElect:MAXHold	281

	:SElect:MINHold.....	281
	:SElect:AVErage.....	282
	:SA:AVErage:NUMAVg	282
	:SA:DETECTIonmethod:MODE	282
	:SA:DETECTIonmethod:MAXHold	283
	:SA:DETECTIonmethod:MINHold	283
	:SA:DETECTIonmethod:NORMal.....	284
	:SA:DETECTIonmethod:AVErage	284
	:SA:FREQUency	285
	:SA:SPAN	285
	:SA:START	285
	:SA:STOP.....	286
	:SA:RBW:MODE.....	286
	:SA:RBW	286
	:SA:SPANRbwratio	287
	:SA:WINDow.....	288
	:SA:UNIts	288
	:SA:SCALE	289
	:SA:POSItion	289
<hr/>		
Power Supply	:POWERSupply:OUTPut<X>	290
Commands	:POWERSupply:OUTPut<X>:VOLTage	291
	:POWERSupply:OUTPut<X>:RECONFigure.....	291
	:POWERSupply:OUTPut<X>:OCP.....	291
<hr/>		
USB Delay	:USBDelay	292
Command		
<hr/>		
Digital	:D<x>:DISPlay	293
Commands	:D<x>:POSItion	293
	:DISPlay:DIGital:HEIght	294
	:DIGital:GROU<x>:THReshold	294
	:DIGital:ANALog:A<x>:DISPlay.....	295
	:DIGital:ANALog:A<x>:RATIo.....	295
	:DIGital:ANALog:A<x>:POSItion.....	296
	:D<x>:MEMory.....	296

:DIGital:MEMory298

C COMMAND DETAILS

The Command details chapter shows the detailed syntax, equivalent panel operation, and example for each command. For the list of all commands, see page 15.

Common Commands	33
Acquisition Commands	39
Autoscale Commands	47
Vertical Commands	48
Math Commands	54
Cursor Commands	63
Display Commands	73
Hardcopy Commands	78
Measure Commands	81
Measurement Commands	107
Reference Commands	114
Run Command	117
Stop Command	117
Single Command	117
Force Command	118
Timebase Commands	119
Trigger Commands	122
System Commands	159
Save/Recall Commands	165
Ethernet Command	170
Time Command	170
Bus Decode Commands	171
Mark Commands	186
Search Commands	188

Label Commands	221
Segment Commands	225
DVM Commands.....	238
Go_NoGo Commands	240
AWG Commands	246
Data Logging Commands	265
Remote Disk Commands	268
DMM Commands.....	271
Spectrum Analyzer Commands	276
Power Supply Commands.....	290
USB Delay Command	292
Digital Commands	293

Common Commands

*IDN?	33
*LRN?	33
*SAV	34
*RCL	34
*RST	35
*CLS	35
*ESE	35
*ESR	36
*OPC	36
*SRE	37
*STB	37

*IDN?



Description	Returns the manufacturer, model, serial number and version number of the unit.
-------------	--

Syntax	*IDN?
--------	-------

Example	*IDN? GW,MDO-2074E,PXXXXXX,V1.XX
---------	-------------------------------------

*LRN?

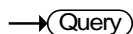

Description	Returns the oscilloscope settings as a data string.
-------------	---

Syntax	*LRN?
--------	-------

Example	*LRN? :DISPlay:WAVEform VECTOR;PERSistence 2.400E-01; INTensity:WAVEform 50;INTensity:GRATicule 50;GRATicule FULL;:CHANnel CH1:DISPlay ON;BWLimit FULL;COUPLing DC;INVert OFF;POSition -1.600E+00;PROBe:RATio
---------	--

```

1.000e+01;PROBe:TYPe VOLTAGE;SCALe 2.000E+
01;IMPedance 1E+6;EXPand GROUND::CHANnel
CH2:DISPlay ON;BWLimit FULL;COUPling DC;INVert
OFF;POSition 0.000E+00;PROBe:RATio
1.000e+01;PROBe:TYPe VOLTAGE;SCALe
2.000E+00;IMPedance 1E+6;EXPand
GROUND::CHANnel CH3:DISPlay OFF;BWLimit
FULL;COUPling DC;INVert OFF;POSition
0.000E+00;PROBe:RATio 1.000e+01;PROBe:TYPe
VOLTAGE;SCALe 1.000E+00;IMPedance 1E+6;EXPand
GROUND::CHANnel CH4:DISPlay OFF;BWLimit
FULL;COUPling DC;INVert OFF;POSition
0.000E+00;PROBe:RATio 1.000e+01;PROBe:TYPe
VOLTAGE;SCALe 1.000E+00;IMPedance 1E+6;EXPand
GROUND::MATH:TYPe FFT;DISP
OFF;DUAL:SOURce1 CH1;SOURce2 CH2;OPERator
MUL;POSition 0.000E+00;SCALe ?;FFT:SOURce
CH1;MAG DB;WINDow HANNING;POSition 2.800E-
01;SCALe 2.000E+01;MATH:ADVanced:OPERator
DIFF;ADVanced:SOURce CH1;ADVanced:EDIT:
SOURce1 CH1;ADVanced:EDIT:S
    
```

***SAV**



Description	Saves the current panel settings to the selected memory number(setup 1 ~ 20).
Syntax	*SAV {1 2 3 ... 20}
Example	*SAV 1 Saves the current panel settings to Set 1.

***RCL**



Description	Recalls a set of panel settings.
Syntax	*RCL {1 2 3 ... 20}
Example	*RCL 1 Recalls the selected setup from Set 1.

***RST**

Set →

Description Resets the MDO-2000E (recalls the default panel settings).

Syntax *RST

***CLS**

Set →

Description Clears the error queue.

Syntax *CLS

***ESE**

Set →

→ Query

Description Sets or queries the Standard Event Status Enable register.

Syntax *ESE <NR1>

Query Syntax *ESE?

Return parameter <NR1> 0~255

Bit Weight	Bit#	Weight	Event	Description
	0	1	OPC	Operation Complete Bit
	1	2	RQC	Not used
	2	4	QYE	Query Error
	3	8	DDE	Device Error
	4	16	EXE	Execution Error
	5	32	CME	Command Error
	6	64	URQ	User Request
	7	128	PON	Power On

Example *ESE?

>4

Indicates that there is a query error.

***ESR**

→(Query)

Description Queries the Standard Event Status (Event) register. The Event Status register is cleared after it is read.

Query Syntax *ESR?

Return parameter <NR1> 0~255

Bit Weight	Bit#	Weight	Event	Description
	0	1	OPC	Operation Complete Bit
	1	2	RQC	Not used
	2	4	QYE	Query Error
	3	8	DDE	Device Error
	4	16	EXE	Execution Error
	5	32	CME	Command Error
	6	64	URQ	User Request
	7	128	PON	Power On

Example *ESR?

>4

Indicates that there is a query error.

(Set) →

***OPC**

→(Query)

Description The *OPC command sets the OPC bit (bit0) of the Standard Event Status Register when all current commands have been processed.

The *OPC? Query returns 1 when all the outstanding commands have completed.

Syntax *OPC

Query Syntax *OPC?

Return parameter 1 Returns 1 when all the outstanding commands have completed.

*SRE



Description Sets or queries the Service Request Enable register. The Service Request Enable register determines which registers of the Status Byte register are able to generate service requests.

Syntax *SRE <NR1>

Query Syntax *SRE?

Parameter/Return parameter <NR1> 0~255

Bit Weight	Bit#	Weight	Event	Description
	0	1		Not used
	1	2		Not used
	2	4		Not used
	3	8		Not used
	4	16	MAV	Message Available Bit
	5	32	ESB	Event Status Bit
	6	64	MSS	Master Summary Bit
	6	64	RQS	Request Service Bit
	7	128		Not used

Example *SRE?
>48
Indicates that the MAVB and ESB bit are both set.

*STB 

Description Queries the bit sum of the Status Byte register with MSS (Master summary Status) replacing the RQS bit (bit 6).

Query Syntax *STB?

Return parameter <NR1> 0 ~ 255

Bit Weight	Bit#	Weight	Event	Description
	0	1		Not used
	1	2		Not used
	2	4		Not used
	3	8		Not used
	4	16	MAV	Message Available Bit
	5	32	ESB	Event Status Bit
	6	64	MSS	Master Summary Bit
	6	64	RQS	Request Service Bit
	7	128		Not used

Example *STB?
 >16
 Indicates that the MAV bit is set.

Acquisition Commands

:ACQuire:AVERage.....	39
:ACQuire:MODE	40
:ACQuire<X>:MEMory?	40
:ACQuire:FILTer:SOURce	42
:ACQuire:FILTer	43
:ACQuire:FILTer:FREQuency	43
:ACQuire:FILTer:FREQuency:UPPER	43
:ACQuire:FILTer:FREQuency:LOWER	44
:ACQuire:FILTer:TYPe.....	44
:ACQuire:FILTer:TRACking.....	45
:ACQuire<X>:STATe?.....	45
:ACQuire:INTERpolation	45
:ACQuire:RECOrdlength.....	46
:HEADer	46

:ACQuire:AVERage

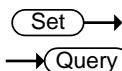

Description	Selects or returns the number of waveform acquisitions that are averaged in the average acquisition mode.
Syntax	:ACQuire:AVERage {<NR1> ?}
Related Commands	:ACQuire:MODE
Parameter	<NR1> 2, 4, 8, 16, 32, 64, 128, 256
Note	Before using this command, select the average acquisition mode. See the example below.
Example	:ACQuire:MODE AVERage :ACQuire:AVERage 2 Selects the average acquisition mode, and sets the average number to 2.

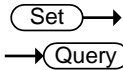

:ACquire:MODE

Description	Selects or returns the acquisition mode.	
Syntax	:ACquire:MODE {SAMPlE PDETECT AVERAge ?}	
Related Commands	:ACquire:AVERAge	
Parameter	SAMPlE	Sample mode sampling
	PDETECT	Peak detect sampling
	AVERAge	Average sampling mode
Example	:ACquire:MODE PDETECT Sets the sampling mode to peak detection.	

:ACquire<X>:MEMory?



Description	Returns the data in acquisition memory for the selected channel as a header + raw data.	
Syntax	:ACquire<X>:MEMory?	
Related Commands	:ACquire:RECOrdlength :HEADer	
Parameter	<X>	Channel number (1 to 4)
Return parameter	<string> <waveform block data>	Returns acquisition settings followed by raw waveform block data. <string> Returns the acquisition settings for the selected channel. Format: parameter(1),setting(1);parameter(2),setting(2)...parameter(n),setting(n);Waveform Data; <waveform block data> Header followed by the raw waveform data.

Format:

Header: The header (in ASCII) encodes the number of bytes for the header followed by the number of data points in bytes for the raw data.

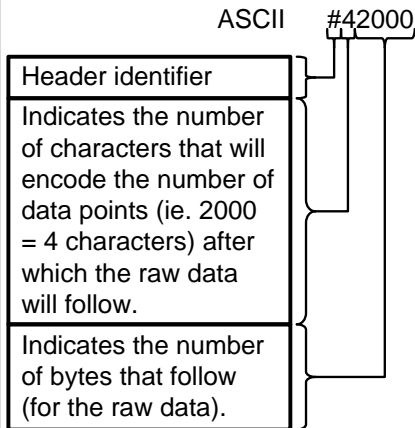

Raw Data:

Each two bytes (in hex) encodes the vertical data of a data point. The data is signed hex data (2's complement, -32768 ~ 32767).

Waveform Raw Data Example:

Header raw data.....

Hex:

23 34 32 30 30 30 00 1C 00 1B 00 1A 00
1A 00 1B

ASCII/Decimal:

#42000 28 27 26 26 27.....

The actual value of a data point can be calculated with the following formula:
(Decimal value of hex data/AD Factor) * vertical scale.

Note: AD Factor is fixed as 25. The vertical scale is returned with the

acquisition settings that precede the raw data.

For example if the raw data for a point is 001C (=28 decimal) then,
 $(28/25) \times 0.5 = 0.56V$

Example :ACquire1:MEMory?
 Format,2.0E;Memory Length,10000;IntpDistance,0;
 Trigger Address,4999;Trigger Level,1.160E+01;
 Source,CH1;Vertical Units,V;Vertical Units
 Div,0;Vertical Units Extend
 Div,15;Label,ACK ;Probe Type,0;Probe
 Ratio,1.000e+01;Vertical Scale,5.000e+00;Vertical
 Position,-1.100e+01;Horizontal Units,S;Horizontal
 Scale,5.000E-04;Horizontal Position,0.000E+00;
 Horizontal Mode,Main;SincET Mode,Real
 Time;Sampling Period,5.000e-07;Horizontal Old
 Scale,5.000E-04;Horizontal Old Position,0.000E+00;
 Firmware,V0.99b8;Time,02-Oct-14 17:00:43;
 Waveform Data;
 #520000.....follows waveform block
 data in hex.....

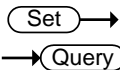

:ACquire:FILTer:SOURce

Description	Returns the source of the filter.
Syntax	:ACquire:FILTer:SOURce {CH1 CH2 CH3 CH4 ?}
Parameter/ Return parameter	CH1 ~ CH4 Source channel
Example	:ACquire:FILTer:SOURce? CH1 Sets the filter source to CH1.

Set →
→ Query

:ACquire:FILTer	
Description	Turns the filter on/off or queries its status.
Syntax	:ACquire:FILTer {ON OFF ?}
Parameter/ Return parameter	ON Filter on. OFF Filter off.
Example	:ACquire:FILTer? OFF Indicates that the filter is turned off.

Set →
→ Query

:ACquire:FILTer:FREquency	
Description	Sets or queries the filter frequency.
Syntax	:ACquire:FILTer:FREquency {DEfAult <NRf> ?}
Parameter/ Return parameter	DEfAult Sets the filter frequency to the default. <NRf> Manually sets the filter frequency. (1Hz ~ 500MHz)
Example	:ACquire:FILTer:FREquency 1 Sets the filter frequency to 1Hz.

Set →
→ Query

:ACquire:FILTer:FREquency:UPPER	
Description	Sets or returns the filter upper frequency.
Syntax	:ACquire:FILTer:FREquency:UPPER {DEfAult} :ACquire:FILTer:FREquency:UPPER <NRf> :ACquire:FILTer:FREquency:UPPER?
Parameter/ Return parameter	DEfAult Sets the frequency to default. <NRf> Sets the frequency to user. (Range:1Hz~500MHz)

Example :ACquire:FILTer:FREQuency:UPPER 4.95e+07
 :ACquire:FILTer:FREQuency:UPPER?
 4.950000e+07

Set →

:ACquire:FILTer:FREQuency:LOWER ← Query

Description Sets or returns the filter lower frequency.

Syntax :ACquire:FILTer:FREQuency:LOWER {Default}
 :ACquire:FILTer:FREQuency:LOWER <NRF>
 :ACquire:FILTer:FREQuency:LOWER?

Parameter/ Return parameter	Default	Sets the frequency to default.
	<NRF>	Sets the frequency to user. (Range:1Hz~500MHz)

Example :ACquire:FILTer:FREQuency:LOWER 1.25e+07
 :ACquire:FILTer:FREQuency:LOWER?
 1.250000e+07

Set →

:ACquire:FILTer:TYPe ← Query

Description Sets or returns the filter type.

Syntax :ACquire:FILTer:TRACking {LOWPass | HIGHPass|
 BANDPass}
 :ACquire:FILTer:TYPe?

Parameter/ Return parameter	LOWPass	Lowpass Type.
	HIGHPass	Highpass Type.
	BANDPass	bandpass Type.

Example :ACquire:FILTer:TYPe?
 >LOWPass
 Returns low pass type as present filter type

:ACQuire:FILTer:TRACking (Set) →
→ (Query)

Description Turns filter tracking on/off or queries its state.

Syntax :ACQuire:FILTer:TRACking {ON|OFF|?}

Parameter/ Return parameter	OFF	Tracking off
	ON	Tracking on

Example :ACQuire:FILTer:TRACking ON
Turns filter tracking on.

:ACQuire<X>:STATe? → (Query)

Description Returns the status of waveform data.

Syntax :ACQuire<X>:STATe?

Parameter	<X>	Channel number (1 to 4)
-----------	-----	-------------------------

Return parameter	0	Raw data is not ready
	1	Raw data is ready

Example :ACQuire1:STATe?
0
Returns 0. Channel 1's raw data is not ready.
Note: If the oscilloscope changes the acquisition status from STOP to RUN, the status will be reset as zero.

:ACQuire:INTERpolation (Set) →
→ (Query)

Description Selects or returns the interpolation mode.

Syntax :ACQuire:INTERpolation {ET | SINC | ?}

Parameter/Return parameter	ET	Equivalent Time interpolation. The MDO-2000E doesn't support ET.
	SINC	Sets to SIN(X)/X interpolation

Example :ACquire:INTERpolation?
 >SINC
 Returns SINC as the interpolation mode.

Set →

→ Query

:ACquire:RECOrdlength

Description Sets or queries the record length.

Syntax :ACquire:RECOrdlength {<NRf>| ?}

Parameter/Return <NRf> Record length. Settable record length:
 parameter (1e+3 | 1e+4 | 1e+5 | 1e+6 | 1e+7)

Example :ACquire:RECOrdlength 1e+3
 Sets the record length to 1000 points.

Set →

→ Query

:HEADer

Description Configures whether the returned data of the :ACquire:MEM query will contain header information or not. It is set to ON by default.

Syntax :HEADer {OFF | ON | ?}

Related :ACquire<X>:MEMory?
 Commands

Parameter ON Add header information.
 OFF Don't add header information.

Return parameter Returns the configuration (ON, OFF) for the selected channel.

Example :HEADer ON

Autoscale Commands

:AUTOSet	47
:AUTORSET:MODE	47

:AUTOSet

Set →

Description Runs the Autoset function to automatically configure the horizontal scale, vertical scale, and trigger according to the input signal.

Syntax :AUTOSet

Set →

:AUTORSET:MODE

→ Query

Description Sets the Autoset mode or queries its state.

Syntax :AUTORSET:MODE {FITScreen | ACPriority | ?}

Related Commands :AUTOSet

Parameter/Return parameter	FITScreen	Fit Screen mode
	ACPriority	AC priority mode

Example :AUTORSET?
FITSCREEN

Vertical Commands

:CHANnel<X>:BWLimit.....	48
:CHANnel<X>:COUPling	49
:CHANnel<X>:DESKew	49
:CHANnel<X>:DISPlay	49
:CHANnel<X>:EXPand	50
:CHANnel<X>:IMPedance?.....	50
:CHANnel<X>:INVert	51
:CHANnel<X>:POSition	51
:CHANnel<X>:PROBe:RATio	52
:CHANnel<X>:PROBe:TYPe.....	52
:CHANnel<X>:SCALE	52

:CHANnel<X>:BWLimit



Description	Sets or returns the bandwidth limit on/off.	
Syntax	:CHANnel<X>:BWLimit {FULL <NR3> ?}	
Parameter	<X>	Channel 1,2,3,4
	FULL	Full bandwidth
	<NR3>	Sets the bandwidth limit to a pre-defined bandwidth.
		100E+6: 100MHz 20E+6: 20MHz
Return Parameter	<NR3>	Returns the bandwidth.
	Full	Full bandwidth
Example	:CHANnel1:BWLimit 2.000E+07 Sets the channel 1 bandwidth to 20MHz.	

:CHANnel<X>:COUPling
 →
 →

Description	Selects or returns the coupling mode.	
Syntax	CHANnel<X>:COUPling {AC DC GND ?}	
Parameter	<X>	Channel 1,2,3,4
	AC	AC coupling
	DC	DC coupling
	GND	Ground coupling
Return parameter	Returns the coupling mode.	
Example	:CHANnel1:COUPling DC Sets the coupling to DC for Channel 1.	

:CHANnel<X>:DESKew
 →
 →

Description	Sets the deskew time in seconds.	
Syntax	:CHANnel<X>:DESKew { <NR3> ?}	
Parameter	<X>	Channel 1,2,3,4
	<NR3>	Deskew time: -5.00E -11 to 5.00E-11 -50ns to 50 ns. (10 ps /step)
Return parameter	<NR3>	Returns the deskew time.
Example	:CHANnel1:DESKew 1.300E-9 Sets the deskew time to 1.3 nano seconds.	

:CHANnel<X>:DISPlay
 →
 →

Description	Turns a channel on/off or returns its status.	
Syntax	:CHANnel<X>:DISPlay {OFF ON ?}	
Parameter	<X>	Channel 1,2,3,4
	OFF	Channel off
	ON	Channel on

Return Parameter	ON	Channel is on
	OFF	Channel is off

Example :CHANnel1:DISPlay ON
Turns on Channel 1

Set →

→ Query

:CHANnel<X>:EXPand

Description Sets Expand By Ground or Expand By Center for a channel or queries its status.

Syntax :CHANnel<X>:EXPand {GND | CENTER | ?}

Parameter	<X>	Channel 1,2,3,4
	GND	Ground
	CENTER	Center

Return parameter	GND	Expand By Ground
	CENTER	Expand By Center

Example :CHANnel1:EXPand GND
Sets Channel 1 to Expand By Ground.

:CHANnel<X>:IMPedance?

→ Query

Description Returns the impedance of the oscilloscope. (The impedance of the MDO-2000E is fixed at 1MΩ)

Syntax :CHANnel<X>:IMPedance?

Parameter	<x>	Channel
	1/2/3/4	CH1/2/3/4

Return parameter <NR3> Returns the impedance value.

Example :CHANnel1:IMPedance?
1.000000E+06
The impedance is 1M ohms.



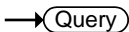

:CHANnel<X>:INVert

Description	Inverts a channel or returns its status.	
Syntax	:CHANnel<X>:INVert {OFF ON ?}	
Parameter	<X>	Channel 1, 2, 3, 4
	OFF	Invert off
	ON	Invert on
Return parameter	ON	Invert on
	OFF	Invert off
Example	:CHANnel1:INVert ON Inverts Channel 1	



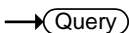

:CHANnel<X>:POSition

Description	Sets or returns the position level for a channel.	
Note	<p>The vertical position will only be set to closest allowed value. The position level range depends on the vertical scale.</p> <p>The scale must first be set before the position can be set.</p>	
Syntax	:CHANnel<X>:POSition { <NRf> ?}	
Parameter	<X>	Channel 1, 2, 3, 4
	<NRf>	Position. Range depends on the vertical scale.
Return parameter	<NR3>	Returns the position value.
Example 1	:CHANnel1:POSition 2.4E-3 Sets the Channel 1 position to 2.4mV/mA	
Example 2	:CHANnel1:POSition? 2.4E-3 Returns 2.4mV as the vertical position.	

		(Set) →
		→ (Query)
:CHANnel<X>:PROBe:RATio		
Description	Sets or returns the probe attenuation factor.	
Syntax	:CHANnel<X>:PROBe:RATio { <NRf> ?}	
Related Commands	:CHANnel<X>:PROBe:TYPE	
Parameter	<X>	Channel 1, 2, 3, 4
	<NRf>	Probe attenuation factor
Return parameter	<NR3>	Returns the probe factor
Example	:CHANnel1:PROBe:RATio 1.00E+0 Sets the Channel 1 probe attenuation factor to 1x	

		(Set) →
		→ (Query)
:CHANnel<X>:PROBe:TYPE		
Description	Sets or returns the probe type (voltage/current).	
Syntax	:CHANnel<X>:PROBe:TYPE { VOLTage CURRent ?}	
Related Commands	:CHANnel<X>:PROBe:RATio	
Parameter	<X>	Channel 1, 2, 3, 4
	VOLTage	Voltage
	CURRent	Current
Return parameter	Returns the probe type.	
Example	:CHANnel1:PROBe:TYPE VOLTage Sets the Channel 1 probe type to voltage.	

		(Set) →
		→ (Query)
:CHANnel<X>:SCALE		
Description	Sets or returns the vertical scale. The scale depends on the probe attenuation factor. Note the probe attenuation factor should be set before the scale.	

Syntax	:CHANnel<X>:SCALE { <NRf> ?}	
Parameter	<X>	Channel 1, 2, 3, 4
	<NRf>	Vertical scale: 2e-3 to 1e+1 2mV to 10V (Probe x1)
Return parameter	<NR3>	Returns the vertical scale in volts or amps.
Example	:CHANnel1:SCALE 2.00E-2	
	Sets the Channel 1 vertical scale to 20mV/div	

Math Commands

:MATH:DISP	54
:MATH:TYPe	55
:MATH:DUAL:SOURce<X>	55
:MATH:DUAL:OPERator	55
:MATH:DUAL:POSition	56
:MATH:DUAL:SCALe	56
:MATH:FFT:SOURce	57
:MATH:FFT:MAG	57
:MATH:FFT:WINDow	57
:MATH:FFT:POSition	58
:MATH:FFT:SCALe	58
:MATH:FFT:HORIZontal:SCALe	59
:MATH:FFT:HORIZontal:POSition	59
:MATH:DEFine	59
:MATHVAR?	60
:MATHVAR:VAR<X>	61
:MATH:ADVanced:POSition	61
:MATH:ADVanced:SCALe	61

:MATH:DISP

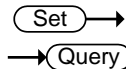

Description	Turns the math display on or off on the screen.	
Syntax	:MATH:DISP {OFF ON ?}	
Parameter/ Return parameter	OFF	Math is not displayed on screen
	ON	Math is displayed on screen
Example	:MATH:DISP OFF Math is off.	

Set →
→ Query

:MATH:TYPE

Description	Queries or sets the Math type to FFT, Advanced Math or to dual channel math operations	
Syntax	:MATH:TYPE { DUAL ADVanced FFT ? }	
Related Commands	:MATH:DISP	
Parameter	DUAL	Dual channel operations
	ADVanced	Advanced math operations
	FFT	FFT operations
Return parameter	Returns the math type.	
Example	:MATH:TYPE DUAL Sets the Math type to dual channel math operation.	

Set →
→ Query

:MATH:DUAL:SOURce<X>

Description	Sets the dual math source for source 1 or 2.	
Syntax	:MATH:DUAL:SOURce<X> { CH1 CH2 CH3 CH4 REF1 REF2 REF3 REF4 ? }	
Parameter	<X>	Source number 1 or 2
	CH1~4	Channel 1 to 4
	REF1~4	Reference waveforms 1 to 4
Return parameter	Returns the source for the source 1 or 2.	
Example	:MATH:DUAL:SOURce1 CH1 Sets source1 as channel 1.	

Set →
→ Query

:MATH:DUAL:OPERator

Description	Sets the math operator for dual math operations.	
-------------	--	--

Syntax	:MATH:DUAL:OPERator {PLUS MINUS MUL DIV ?}	
Parameter	PLUS	+ operator
	MINUS	- operator
	MUL	× operator
	DIV	÷ operator
Return parameter	Returns operator type.	
Example	:MATH:DUAL:OPERator PLUS Sets the math operator as plus (+).	

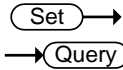

:MATH:DUAL:POSition

Description	Sets the vertical position of the displayed math result expressed by unit/division.	
Syntax	:MATH:DUAL:POSition {<NRf> ? }	
Parameter	<NRf>	Vertical position Depends on the vertical scale (Unit/Div)
Return parameter	<NR3>	Returns the vertical position.
Example	:MATH:DUAL:POSition 1.0E+0 Sets the vertical position to 1.00 unit/div.	

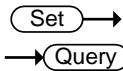

:MATH:DUAL:SCALE

Description	Sets the vertical scale of the displayed math result.	
Syntax	:MATH:DUAL:SCALE {<NRf> ? }	
Parameter	<NRf>	Vertical scale
Return parameter	<NR3>	Returns the scale.
Example	:MATH:DUAL:SCALE 2.0E-3 Sets the vertical scale to 2mV/2mA.	

:MATH:FFT:SOURce



Description	Sets and queries the FFT math source.	
Syntax	:MATH:FFT:SOURce { CH1 CH2 CH3 CH4 REF1 REF2 REF3 REF4 ? }	
Related commands	:MATH:ADVanced:EDIT:SOURce<X> :MATH:ADVanced:EDIT:OPERator	
Parameter	CH1~4	Channel 1 to 4
	REF1~4	Reference waveform 1 to 4
Return parameter	Returns the FFT source.	
Example	:MATH:FFT:SOURce CH1 Sets the FFT math source as channel 1.	

:MATH:FFT:MAG



Description	Sets FFT vertical units as linear or decibels.	
Syntax	:MATH:FFT:MAG {LINEAR DB ?}	
Parameter	LINEAR	Linear units (Vrms)
	DB	Logarithmic units (dB)
Return parameter	Returns the FFT vertical units.	
Example	:MATH:FFT:MAG DB Sets FFT vertical units to dB.	

:MATH:FFT:WINDow



Description	Sets the windowing filter used for the FFT function.	
Syntax	:MATH:FFT:WINDow {RECTangular HAMming HANning BLAckman ?}	
Parameter	RECTangular	Rectangular window

HAMming	Hamming window
HANning	Hanning window
BLAckman	Blackman window

Return parameter Returns the FFT window.

Example :MATH:FFT:WINDow HAMming
Sets the FFT window filter to hamming.

Set →

→ Query

:MATH:FFT:POSition

Description Sets the vertical position of the displayed FFT result.

Syntax MATH:FFT:POSition { <NRf> | ? }

Parameter <NRf> Vertical position: -12e+0 to +12e+0 (12 units/division to +12 units/division.)

Return parameter <NR3> Returns the vertical position.

Example :MATH:FFT:POSition -2e-1
Sets the FFT position to -0.2 divisions.

Set →

→ Query

:MATH:FFT:SCALE

Description Sets the vertical scale of the displayed FFT result.

Syntax :MATH:FFT:SCALE {<NRf> | ?}

Parameter <NRf> Vertical scale:
Linear: 2e-3 to 1e+3 (2mV~1kV)
dB: 1e+0 to 2e+1 (1~20dB)

Return parameter <NR3> Returns vertical scale.

Example :MATH:FFT:SCALE 1.0e+0
Sets the scale to 1dB.

Set →
 → Query

:MATH:FFT:HORizontal:SCALe

Description Sets or queries the zoom scale for FFT math.

Syntax :MATH:FFT:HORizonatal:SCALe {<NRf> | ?}

Parameter <NRf> Zoom scale: 1 to 20 times

Return parameter <NR3> Returns zoom scale.

Example :MATH:FFT:HORizontal:SCALe 5
 Sets the zoom scale to 5X.

Set →
 → Query

:MATH:FFT:HORizontal:POSition

Description Sets the horizontal position of the displayed FFT result.

Syntax MATH:FFT:HORizontal:POSition { <NRf> | ? }

Parameter <NRf> Horizontal position: 0Hz ~ 999.9kHz

Return parameter <NR3> Returns the vertical position.

Example :MATH:FFT:HORizontal:POSition 6.0e5
 Sets the FFT horizontal position to 600kHz.

Set →
 → Query

:MATH:DEFine

Description Sets or queries the advanced math expression as a string.

Syntax :MATH:DEFine {<string> | ?}

Related :MATH:DISP
 :MATH:TYPE

Parameter <string> An expression enclosed in double quotes. Note, ensure parentheses are used correctly in the expression. The expression can contain the following parts:

Source	CH1~CH4, Ref1~Ref4
Function	Intg(, Diff(, log(, ln(, Exp(, Sqrt(, Abs(, Rad(, Deg(, sin(, cos(, tan(, asin(, acos(, atan(
Variable	VAR1, VAR2
Operator	+, -, *, /, (,), !(, <, >, <=, >=, ==, !=, , &&
Figure	0, 1, 2, 3, 4, 5, 6, 7, 8, 9, ., E
Measurement	Pk-Pk(, Max(, Min(, Amp(, High(, Low(, Mean(, CycleMean(, RMS(, CycleRMS(, Area(, CycleArea(, ROVShoot(, FOVShoot(, Freq(, Period(, Rise(, Fall(, PosWidth(, NegWidth(, Dutycycle(, FRR(, FRF(, FFR(, FFF(, LRR(, LRF(, LFR(, LFF(, Phase(

Return parameter Returns the expression as a string.

Example :MATH:DISP ON
 :MATH:TYPe ADVanced
 MATH:DEFine "CH1-CH2"
 Sets the math expression to CH1-CH2.

:MATHVAR?



Description	Returns the value of the VAR1 and VAR2 variables.
Syntax	MATHVAR?
Related Commands	MATHVAR:VAR<X> MATH:DEFine
Return parameter	<string> VAR1 <NR3>; VAR2 <NR3>

Example MATHVAR?
 VAR1 1.000000E+06; VAR2 1.0E+1
 Returns the value of both variables.

Set →

→ Query

:MATHVAR:VAR<X>

Description Sets or returns the VAR1 or VAR2 variables.

Syntax MATHVAR:VAR<x> {<NRf> | ?}

Related
 Commands MATH:DEFine

Parameter	<X>	1, 2 (VAR1 or VAR2)
	<NRf>	Value of VAR1/VAR2

Return parameter	<NR3>	Returns the value of VAR1/VAR2
------------------	-------	--------------------------------

Example :MATH:VAR1 6.0e4
 Sets VAR1 to 60000.

Set →

→ Query

:MATH:ADVanced:POSition

Description Sets the vertical position of the advanced math result, expressed in unit/div.

Syntax MATH:ADVanced:POSition { <NRf> | ? }

Parameter	<NRf>	Vertical position: -12e+0 to +12e+0 (12 units/division to +12 units/division.)
-----------	-------	--

Return parameter	<NR3>	Returns the vertical position.
------------------	-------	--------------------------------

Example :MATH:ADVanced:POSition 1.0e+0
 Sets the position as 1.00 unit/div.

Set →

→ Query

:MATH:ADVanced:SCALE

Description Sets or queries the vertical scale the advanced math result.

Syntax :MATH:ADVanced:SCALE {<NRf> | ?}

Parameter	<NRf>	Vertical scale
Return parameter	<NR3>	Returns the vertical scale.
Example	:MATH:ADVanced:SCALE 2.0E-3 Sets the vertical scale to 2mV/Div.	

Cursor Commands

:CURSor:MODE	64
:CURSor:SOURce.....	64
:CURSor:HUNI	65
:CURSor:HUSE	65
:CURSor:VUNI	66
:CURSor:VUSE	66
:CURSor:DDT	66
:CURSor:H1Position	67
:CURSor:H2Position	67
:CURSor:HDELta	68
:CURSor:V1Position.....	68
:CURSor:V2Position.....	68
:CURSor:VDELta	69
:CURSor:XY:RECTangular:X:POSition<X>	69
:CURSor:XY:RECTangular:X:DELta	69
:CURSor:XY:RECTangular:Y:POSition<X>	70
:CURSor:XY:RECTangular:Y:DELta	70
:CURSor:XY:POLar:RADIUS:POSition<X>.....	70
:CURSor:XY:POLar:RADIUS:DELta	71
:CURSor:XY:POLar:THETA:POSition<X>	71
:CURSor:XY:POLar:THETA:DELta	71
:CURSor:XY:PRODuct:POSition<X>	72
:CURSor:XY:PRODuct:DELta.....	72
:CURSor:XY:RATio:POSition<X>	72
:CURSor:XY:RATio:DELta	73

:CURSor:MODE

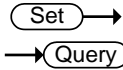

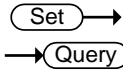

Description	Sets cursor mode to horizontal (H) or horizontal and vertical (HV). Note: When the cursor source is set to bus, then only the horizontal cursor is available.	
Syntax	:CURSor:MODE {OFF H HV ? }	
Parameter	OFF	Turns the cursors off.
	H	Turns the horizontal cursors on.
	HV	Turns horizontal and vertical cursors on.
Return parameter	Returns the state of the cursors (H, HV, OFF).	
Example	:CURSor:MODE OFF Turns the cursors off.	

:CURSor:SOURce



Description	Sets or queries the cursor source.	
Syntax	:CURSor:SOURce {CH1 CH2 CH3 CH4 REF1 REF2 REF3 REF4 MATH LOGic BUS1 ? }	
Parameter	CH1~CH4	Channel 1 to 4
	REF1~4	Reference waveform 1 to 4
	MATH	Math source
	LOGic	Logic source
	BUS1	Bus source
Return parameter	Returns the cursor source.	
Example	:CURSor:SOURce CH1 Turns the cursor source as channel 1.	

		 
:CURSor:HUNI		
Description	Sets or queries the units for the horizontal bar cursors.	
Syntax	:CURSor:HUNI {SEConds HERTz DEGrees PERcent ?}	
Related Commands	:CURSor:MODe	
Parameter	SEConds	Sets the cursor units to time in seconds.
	HERtz	Sets the cursor units to frequency.
	DEGrees	Sets the cursor units to degrees.
	PERcent	Sets the cursor units to percent.
Return parameter	Returns the unit type.	
Example	:CURSor:HUNI SEConds Sets the units to time in seconds.	

		
:CURSor:HUSE		
Description	Sets the current cursor position as the phase or ratio reference for the Percent or Degrees (horizontal) cursors.	
Note	This command can only be used when :CURSor:HUNI is set to DEGrees or PERcent.	
Syntax	:CURSor:HUSE {CURRent}	
Related Commands	:CURSor:MODe :CURSor:HUNI	
Parameter	CURRent	Uses the current horizontal position
Example	:CURSor:HUSE CURRent.	

Set →
 → Query

:CURSor:VUNI

Description	Sets or queries the units for the vertical bar cursors.	
Syntax	:CURSor:VUNI {BASE PERcent ?}	
Related Commands	:CURSor:MODE	
Parameter	BASE	Sets the vertical cursor units the same as the scope units (V or A).
	PERcent	Sets the displayed units to percent.
Return parameter	Returns the unit type.	
Example	:CURSor:VUNI BASE Sets the units to the base units.	

Set →

:CURSor:VUSE

Description	Sets the current cursor position as the ratio reference for the Percent (vertical) cursors.	
Note	This command can only be used when :CURSor:VUNI is set to PERcent.	
Syntax	:CURSor:VUSE {CURRent}	
Related Commands	:CURSor:MODE :CURSor:VUNI	
Parameter	CURRent	Uses the current vertical position
Example	:CURSor:VUSE CURRent.	

→ Query

:CURSor:DDT

Description	Returns the deltaY/deltaT (dy/dT) readout. This function is only supported if the source channels are CH1~4, Ref1~4 or Math.	
Syntax	:CURSor:DDT{?}	

Related Commands :CURSor:MODE

Return Parameter <NR3> Returns the readout in <NR3> format.

Example :CURSor:DDT?
4.00E-05

:CURSor:H1Position

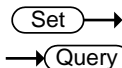

Description Sets or returns the first horizontal cursor (H1) position.

Syntax :CURSor:H1Position {<NRf> | ?}

Related Commands :CURSor:H2Position

Parameter <NRf> Horizontal position

Return parameter Returns the cursor position.

Example :CURSor:H1Position?
-1.34E-3
Returns the H1 cursor position as -1.34ms.

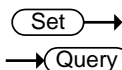

:CURSor:H2Position

Description Sets or returns the second horizontal cursor (H2) position.

Syntax :CURSor:H2Position {<NRf> | ?}

Related Commands :CURSor:H1Position

Parameter <NRf> Horizontal Position

Return parameter Returns the cursor position.

Example :CURSor:H2Position 1.5E-3
Sets the H2 cursor position to 1.5ms.

:CURSor:HDELta

→ **Query**

Description	Returns the delta of H1 and H2.
Syntax	:CURSor:HDELta{?}
Return Parameter	<NR3> Returns the distance between two horizontal cursors.
Example	:CURSor:HDELta? 5.0E-9 Returns the horizontal delta as 5ns.

:CURSor:V1Position

Set →

→ **Query**

Description	Sets the first vertical cursor (V1) position.
Syntax	:CURSor:V1Position {<NRf> ?}
Parameter	<NRf> Vertical position. Depends on the vertical scale.
Return parameter	<NR3> Returns the cursor position.
Example	:CURSor:V1Position 1.6E -1 Sets the V1 cursor position to 160mA.

Set →

:CURSor:V2Position

→ **Query**

Description	Sets the first vertical cursor (V2) position.
Syntax	:CURSor:V2Position {<NRf> ?}
Parameter	<NRf> Vertical position. Depends on the vertical scale.
Return parameter	<NR3> Returns the cursor position.
Example	:CURSor:V2Position 1.1E-1 Sets the V2 cursor position to 110mA.

:CURSor:VDELta → Query

Description	Returns the delta of V1 and V2.	
Syntax	:CURSor:VDELta{?}	
Return Parameter	<NR3>	Returns the difference between two vertical cursors.
Example	:CURSor:VDELta? 4.00E+0 Returns the vertical delta as 4 volts.	

:CURSor:XY:RECTangular:X:POSition<X> Set →
→ Query

Description	Sets or queries the horizontal position in XY mode for the X rectangular coordinates for cursor 1 or 2.	
Syntax	:CURSor:XY:RECTangular:X:POSition<X> {<NRf> ?}	
Parameter	<X>	Cursor 1, 2
	<NRf>	Horizontal position co-ordinates
Return parameter	<NR3>	Returns the cursor position.
Example	:CURSor:XY:RECTangular:X:POSition1 4.0E-3 Sets the X-coordinate cursor 1 position to 40mV/mV.	

:CURSor:XY:RECTangular:X:DELta → Query

Description	Returns the delta value of cursor 1 and 2 on the X coordinate.	
Syntax	:CURSor:XY:RECTangular:X:DELta{?}	
Return Parameter	<NR3>	Returns the delta value of cursor 1 and 2 as <NR3>.

Example :CURSOR:XY:RECTangular:X:DELta?
 80.0E-3
 Returns the horizontal delta as 80mV.

Set →

:CURSOR:XY:RECTangular:Y:POSition<X> → Query

Description Sets or queries the vertical position in XY mode for the Y rectangular coordinates for cursor 1 or 2.

Syntax :CURSOR:XY:RECTangular:Y:POSition<X> {<NRf>|?}

Parameter <X> Cursor 1, 2
 <NRf> Vertical position co-ordinates

Return parameter <NR3> Returns the cursor position.

Example :CURSOR:XY:RECTangular:Y:POSition1 4.0E-3
 Sets the Y-coordinate cursor 1 position to 40mV/mV.

:CURSOR:XY:RECTangular:Y:DELta → Query

Description Returns the delta value of cursor 1 and 2 on the Y coordinate.

Syntax :CURSOR:XY:RECTangular:Y:DELta{?}

Return Parameter <NR3> Returns the delta value of cursor 1 and 2 as <NR3>.

Example :CURSOR:XY:RECTangular:Y:DELta?
 80.0E-3
 Returns the horizontal delta as 80mV.

:CURSOR:XY:POLar:RADIUS:POSition<X> → Query

Description Queries the polar radius position for the specified cursor in XY mode, where X can be either cursor 1 or 2.

Syntax	:CURSor:XY:POLar:RADIUS:POSition<X>{?}
Parameter	<X> 1, 2 (cursor 1, cursor 2)
Return Parameter	<NR3> Returns the polar radius position.
Example	:CURSor:XY:POLar:RADIUS:POSition1? 80.0E-3 Returns the polar radius position as 80.0mV.

:CURSor:XY:POLar:RADIUS:DELta → Query

Description	Returns the radius delta value of cursor 1 and 2.
Syntax	:CURSor:XY:POLar:RADIUS:DELta{?}
Return Parameter	<NR3> Returns the radius delta.
Example	:CURSor:XY:POLar:RADIUS:DELta? 31.4E-3 Returns the radius delta as 31.4mV.

:CURSor:XY:POLar:THETA:POSITION<X> → Query

Description	Queries the polar angle for the specified cursor in XY mode, where X can be either 1 or 2.
Syntax	:CURSor:XY:POLar:THETA:POSITION<X>{?}
Parameter	<X> 1, 2 (Cursor 1, Cursor 2)
Return parameter	<NR3> Returns the polar angle.
Example	:CURSor:XY:POLar:RADIUS:POSition1? 8.91E+1 Returns the polar angle for cursor1 as 89.1°.

:CURSor:XY:POLar:THETA:DELta → Query

Description	Queries the polar angle delta between cursor1 and cursor2.
-------------	--

Syntax	:CURSor:XY:POLar:THETA:DELta{?}	
Return parameter	<NR3>	Returns the theta delta between cursor1 and cursor2.
Example	:CURSor:XY:POLar:THETA:DELta? 9.10E+0 Returns the delta as 9.1°.	

:CURSor:XY:PRODUct:POSItion<X> → Query

Description	Queries the product in XY mode for the specified cursor, where x can be either 1 or 2.	
Syntax	:CURSor:XY:PRODUct:POSItion<X>{?}	
Parameter	<X>	1, 2 (Cursor 1, Cursor 2)
Return parameter	<NR3>	Returns the product value of the Cursor1 or Cursor2.
Example	:CURSor:XY:PRODUct:POSItion1? 9.44E-5 Returns the product of cursor1 as 94.4uVV.	

:CURSor:XY:PRODUct:DELta → Query

Description	Queries the product delta in XY mode.	
Syntax	:CURSor:XY:PRODUct:DELta{?}	
Return parameter	<NR3>	Returns the product delta.
Example	:CURSor:XY:PRODUct:DELta? 1.22E-5 Returns the product delta as 12.2uVV.	

:CURSor:XY:RATIo:POSItion<X> → Query

Description	Queries the ratio in XY mode for the specified cursor, where x can be either cursor 1 or 2.	
-------------	---	--

Syntax	:CURSor:XY:RATio:POSition<X>{?}
Parameter	<X> 1, 2 (Cursor 1, Cursor 2)
Return parameter	<NR3> Returns the ratio.
Example	:CURSor:XY:RATio:POSition? 6.717E+1 Returns the ratio value as 6.717V/V.

:CURSor:XY:RATio:DELta → Query

Description	Queries the ratio delta in XY mode.
Syntax	:CURSor:XY:RATio:DELta{?}
Return parameter	<NR3> Returns the ratio delta.
Example	:CURSor:XY:RATio:DELta? 5.39E+1 Returns the ratio delta as 53.9V/V.

Display Commands

:DISPlay:INTensity:WAVEform.....	73
:DISPlay:INTensity:GRATICule.....	74
:DISPlay:INTensity:BACKLight	74
:DISPlay:INTensity:BACKLight:AUTODim:ENABLE	74
:DISPlay:INTENSITY:BACKLight:AUTODim:TIME	75
:DISPlay:PERSiStence	75
:DISPlay:GRATICule	76
:DISPlay:WAVEform.....	76
:DISPlay:OUTPut	76

:DISPlay:INTensity:WAVEform Set →
→ Query

Description	Sets or queries the waveform intensity level.
-------------	---

Syntax	:DISPlay:INTensity:WAVEform {<NRf> ?}
Parameter	<NRf> 0.0E+0 to 1.0E+2 (0% to 100%)
Return Parameter	<NR3> Returns the intensity.
Example	:DISPlay:INTensity:WAVEform 5.0E+1 Sets the waveform intensity to 50%.

Set →

→ Query

:DISPlay:INTensity:GRATicule

Description	Sets or queries the graticule intensity level.
Syntax	:DISPlay:INTensity:GRATicule {<NRf> ?}
Parameter	<NRf> 1.0E+0 to 1.0E+2 (10% to 100%)
Return Parameter	<NR3> Returns the graticule intensity.
Example	:DISPlay:INTensity:GRATicule 5.0E+1 Sets the graticule intensity to 50%.

Set →

→ Query

:DISPlay:INTensity:BACKLight

Description	Sets or queries the intensity of the backlight display.
Syntax	:DISPlay:INTensity:BACKLight {<NRf> ?}
Parameter	<NRf> 1.0E+0 to 1.0E+2 (10% to 100%)
Return Parameter	<NR3> Returns the backlight intensity.
Example	:DISPlay:INTensity:BACKLight 5.0E+1 Sets the backlight intensity to 50%.

Set →

→ Query

**:DISPlay:INTensity:BACKLight:AUTODim
:ENABLE**

Description	Sets or queries the display auto-dim function.
Syntax	:DISPlay:INTensity:BACKLight:AUTODim:ENABLE {OFF ON ?}

Parameter/	OFF	Turn auto-dim on.
Return parameter	ON	Turn auto-dim off.

Example :DISPlay:INTensity:BACKLight:AUTODim:ENABLE ON
Turns the auto-dim function on.

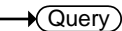
:DISPlay:INTENSITY:BACKLight:AUTODim 
:TIME 

Description Sets or queries the display auto-dim time.

Syntax :DISPlay:INTensity:BACKLight:AUTODim:TIME
{ <NR1> | ? }

Parameter/	<NR1>	1 ~ 180 minutes. Time in minutes.
Return parameter		

Example :DISPlay:INTensity:BACKLight:AUTODim:TIME 10
Sets the auto-dim time to 10 minutes.

:DISPlay:PERSistence 

Description Sets or queries the waveform persistence level.

Syntax :DISPlay:PERSistence { INFInite | OFF | <NRf> | ? }





Parameter	<NRf>	1.6E-2 ~ 4.0E+0. (16mS to 10S) Range(1.6E-2, 30E-3, 60E-3, 120E-2, 240E-3, 500E-3, 750E-3, 1, 1.5,2,...,9.5,10
	INFInite	Infinite persistence
	OFF	No persistence

Return Parameter	<NR3>	Returns the persistence time.
	INFInite	Infinite persistence
	OFF	No persistence

Example :DISPlay:PERSistence 2.0E+0
Sets the persistence to 2 seconds.

:DISPlay:GRATicule

Set →
→ Query

Description	Sets or queries graticule display type.			
Syntax	:DISPlay:GRATicule {FULL GRID CROsS FRAMe ?}			
Parameter	FULL		CROsS	
	FRAMe		GRID	

Return parameter Returns the graticule type.

Example :DISPlay:GRATicule FULL
Sets the graticule to .

Set →
→ Query

:DISPlay:WAVEform

Description Sets or queries whether the waveforms are drawn as vectors or dots.

Syntax :DISPlay:WAVEform {VECTor | DOT | ?}

Parameter	VECTor	Vectors
	DOT	Dots

Return parameter Returns VECTOR or DOT.

Example :DISPlay:WAVEform VECTor
Sets the waveform to vectors.

:DISPlay:OUTPut

→ Query

Description Returns the screen image as a 16 bit RGB run length encoded image.

Syntax :DISPlay:OUTPut{?}

Return parameter Format: header+data+LF

For example assuming the image data size is 60072 bytes then the following would be returned:

#560072<[count] [color] [count] [color]..... ><LF>

Where #560072 is the header, each [count] and [color] data are 2 bytes and <LF> is a line feed character.

Hardcopy Commands

:HARDcopy:START	78
:HARDcopy:MODE	78
:HARDcopy:PRINTINKSaver	79
:HARDcopy:SAVEINKSaver	79
:HARDcopy:SAVEFORMat	79
:HARDcopy:ASSIGN	80

:HARDcopy:START



Description	Executing the HARDcopy:START command is the equivalent of pressing the Hardcopy key on the front panel.
-------------	---

Syntax	:HARDcopy:START
--------	-----------------

Related Commands	:HARDcopy:MODE
	:HARDcopy:PRINTINKSaver
	:HARDcopy:SAVEINKSaver
	:HARDcopy:SAVEFORMat
	:HARDcopy:ASSIGN

:HARDcopy:MODE

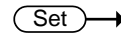

Description	Sets or queries whether hardcopy is set to print or save.
-------------	---

Syntax	:HARDcopy:MODE { PRINT SAVE ? }
--------	-------------------------------------

Related Commands	:HARDcopy:START
------------------	-----------------

Parameter	PRINT	Print mode
	SAVE	Save mode

Return parameter	Returns the mode. (PRINT/SAVE)
------------------	--------------------------------

Example :HARDcopy:MODE PRINT
Sets hardcopy to print.

:HARDcopy:PRINTINKSaver (Set) →
→ (Query)

Description Sets Inksaver On or Off for printing.

Syntax :HARDcopy:PRINTINKSaver { OFF | ON | ? }

Related Commands :HARDcopy:START
:HARDcopy:MODE

Parameter	ON	Inksaver ON
	OFF	Inksaver OFF

Return parameter Returns the print Ink Saver mode.(ON/OFF)

Example :HARDcopy:PRINTINKSaver ON
Sets Ink Saver to ON for printing.

:HARDcopy:SAVEINKSaver (Set) →
→ (Query)

Description Sets Inksaver On or Off for saving screen images.

Syntax :HARDcopy:SAVEINKSaver { OFF | ON | ? }

Related Commands :HARDcopy:START
:HARDcopy:MODE

Parameter	ON	Inksaver ON
	OFF	Inksaver OFF

Return parameter Returns the screen image Ink Saver mode (ON/OFF).

Example :HARDcopy:SAVEINKSaver ON
Sets Inksaver to ON for saving screen images.

:HARDcopy:SAVEFORMat (Set) →
→ (Query)

Description Sets or queries the image save file type.

Syntax :HARDcopy:SAVEFORMat { PNG | BMP | ? }

Related Commands	:HARDcopy:START :HARDcopy:MODE	
Parameter	PNG	PNG file format
	BMP	BMP file format
Return parameter	Returns the image file format (PNG/BMP).	
Example	:HARDcopy:SAVEFORMat PNG Sets the file format to PNG.	

:HARDcopy:ASSIGN

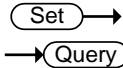

Description	Sets or queries what file type the hardcopy key has been assigned to save.	
Syntax	:HARDcopy:ASSIGN {IMAGe WAVEform SETUp ALL ?}	
Related Commands	:HARDcopy:START :HARDcopy:MODE	
Parameter	IMAGe	Save image files.
	WAVEform	Save waveforms.
	SETUp	Save the panel setup.
	ALL	Save All (image, waveform,setup)
Return parameter	Returns the file type. (IMAGE/WAVEFORM/SETUP/ALL)	
Example	:HARDcopy:ASSIGN IMAGE. Set the hardcopy key to save image files.	

Measure Commands

:MEASure:GATing.....	82
:MEASure:SOURce	82
:MEASure:METHod	83
:MEASUrement:REFLevel:PERCent:HIGH.....	83
:MEASUrement:REFLevel:PERCent:LOW	84
:MEASUrement:REFLevel:PERCent:MID	84
:MEASUrement:REFLevel:PERCent:MID2	84
:MEASure:FALL.....	85
:MEASure:FOVShoot	85
:MEASure:FPReshoot	86
:MEASure:FREQuency	86
:MEASure:NWIDth	87
:MEASure:PDUTy.....	87
:MEASure:PERiod	88
:MEASure:PWIDth	88
:MEASure:RISe.....	89
:MEASure:ROVShoot.....	89
:MEASure:RPReshoot	90
:MEASure:PPULSE.....	91
:MEASure:NPULSE	91
:MEASure:PEDGE	92
:MEASure:NEDGE	92
:MEASure:AMPlitude.....	93
:MEASure:MEAN	93
:MEASure:CMEan	94
:MEASure:HIGH	95
:MEASure:LOW	95
:MEASure:MAX.....	96
:MEASure:MIN	96
:MEASure:PK2PK	97
:MEASure:RMS	97
:MEASure:CRMS.....	98

:MEASure:AREa	99
:MEASure:CARea	99
:MEASure:FRRDelay	100
:MEASure:FRFDelay	100
:MEASure:FFRDelay	101
:MEASure:FFFDelay.....	102
:MEASure:LRRDelay	102
:MEASure:LRFDelay.....	103
:MEASure:LFRDelay.....	103
:MEASure:LFFDelay.....	104
:MEASure:PHase.....	105
:MEASure:PFLI.....	105
:MEASure:FLI.....	106

:MEASure:GATing

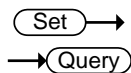

Description	Sets or queries the measurement gating.	
Syntax	:MEASure:GATing { OFF SCREEn CURSor ? }	
Parameter	OFF	Full record
	SCREEn	Gating set to screen width
	CURSor	Gating between cursors
Return parameter	Returns the gating. (OFF, SCREEN, CURSOR)	
Example	:MEASure:GATing OFF Turns gating off (full record).	

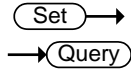

:MEASure:SOURce

Description	Sets or queries the measurement source for source1 or source2.	
Syntax	:MEASure:SOURce<X> { CH1 CH2 CH3 CH4 MATH ? }	
Parameter	<X>	Source1 or source2

CH1~CH4	Channel 1 to 4
MATH	Math

Return parameter Returns the source (CH1, CH2, CH3, CH4, MATH)

Example :MEASure:SOURce1 CH1
Sets source1 to channel 1.

:MEASure:METHOD

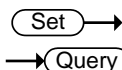

Description Sets or queries the method used to determine the High-Low measurement values.

Syntax :MEASure:METHOD { AUTO | HISTogram | MINMax | ? }

Parameter	AUTO	Set to auto.
	HISTogram	Set to the Histogram method.
	MINMax	Set to the Min-Max method.

Return parameter Returns the measurement method (AUTO, HISTOGRAM, MINMAX)

Example :MEASure:METHOD: AUTO
Set the measurement method to auto.

:MEASUrement:REFLevel:PERCent:HIGH

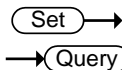

Description Sets or queries the high reference level as a percentage.

Syntax :MEASUrement:REFLevel:PERCent:HIGH {<NRf> | ?}

Parameter <NRf> 0 - 100%

Return parameter Returns the high reference level

Example :MEASUrement:REFLevel:PERCent:HIGH 50.1
Set the high reference level to 50.1%.

:MEASUrement:REFLevel:PERCent:LOW (Set) →
→ (Query)

Description	Sets or queries the low reference level as a percentage.
Syntax	:MEASUrement:REFLevel:PERCent:LOW {<Nrf> ?}
Parameter	<Nrf> 0 - 100%
Return parameter	Returns the low reference level.
Example	:MEASUrement:REFLevel:PERCent:LOW 40.1 Set the low reference level to 40.1%.

:MEASUrement:REFLevel:PERCent:MID (Set) →
→ (Query)

Description	Sets or queries the first mid reference level as a percentage.
Syntax	:MEASUrement:REFLevel:PERCent:MID {<Nrf> ?}
Parameter	<Nrf> 0 - 100%
Return parameter	Returns the mid reference level.
Example	:MEASUrement:REFLevel:PERCent:MID 50 Set the mid reference level to 50%.

:MEASUrement:REFLevel:PERCent:MID2 (Set) →
→ (Query)

Description	Sets or queries the second mid reference level as a percentage.
Syntax	:MEASUrement:REFLevel:PERCent:MID2 {<Nrf> ?}
Parameter	<Nrf> 0 - 100%
Return parameter	Returns the mid reference level of the second source.
Example	:MEASUrement:REFLevel:PERCent:MID2 50 Set the mid reference level to 50%.

:MEASure:FALL

→ Query

Description	Returns the fall time measurement result.	
Syntax	:MEASure:FALL{?}	
Related Commands	:MEASure:SOURce<X>	
Return parameter	<NR3> Chan Off	Indicates the source channel is not activated.
Note	Before using this command, select the measurement channel. See the example below.	
Example	:MEASure:SOURce1 CH1 :MEASure:FALL? Selects Channel 1 as the source, and then measures the fall time.	

:MEASure:FOVShoot

→ Query

Description	Returns the fall overshoot amplitude.	
Syntax	:MEASure:FOVShoot{?}	
Related Commands	:MEASure:SOURce<X>	
Return parameter	<NR3> Chan Off	Returns the fall overshoot as a percentage Indicates the source channel is not activated.
Note	Before using this command, select the measurement channel. See the example below.	

Example :MEASure:SOURce1 CH1
 :MEASure:FOVShoot?
 1.27E+0
 Selects Channel 1, and then measures the fall overshoot.

:MEASure:FPreShoot → Query

Description	Returns fall preshoot amplitude.	
Syntax	:MEASure:FPreShoot{?}	
Related Commands	:MEASure:SOURce<X>	
Returns	Returns the fall preshoot as <NR3>.	
Return parameter	<NR3>	Returns the fall preshoot as a percentage.
	Chan Off	Indicates the source channel is not activated.
Note	Before using this command, select the measurement channel. See the example below.	
Example	:MEASure:SOURce1 CH1 :MEASure:FPreShoot? Selects Channel 1, and then measures the fall preshoot.	

:MEASure:FREQuency → Query

Description	Returns the frequency value.	
Syntax	:MEASure:FREQuency{?}	
Related Commands	:MEASure:SOURce<X>	
Return parameter	<NR3>	Returns the frequency in Hz.
	Chan Off	Indicates the source channel is not activated.

Note Before using this command, select the measurement channel. See the example below.

Example :MEASure:SOURce1 CH1
 :MEASure:FREQuency?
 >1.0E+3
 Selects Channel 1, and then measures the frequency.

:MEASure:NWIDth → Query

Description Returns the first negative pulse width timing.

Syntax :MEASure:NWIDth{?}

Related Commands :MEASure:SOURce<X>

Return parameter	<NR3>	Returns the negative pulse width in seconds.
	Chan Off	Indicates the source channel is not activated.

Note Before using this command, select the measurement channel. See the example below.

Example :MEASure:SOURce1 CH1
 :MEASure:NWIDth?
 4.995E-04
 Selects Channel 1, and then measures the negative pulse width.

:MEASure:PDUTy → Query

Description Returns the positive duty cycle ratio as percentage.

Syntax :MEASure:PDUTy{?}

Related commands :MEASure:SOURce<X>

Return parameter **<NR3>** Returns the positive duty ratio.

Chan Off	Indicates the source channel is not activated.
----------	--

Note	Before using this command, select the measurement channel. See the example below.
Example	<pre>:MEASure:SOURce1 CH1 :MEASure:PDUTy? 5.000E+01</pre> <p>Selects Channel 1, and then measures the positive duty cycle.</p>

:MEASure:PERiod → Query

Description	Returns the period.				
Syntax	:MEASure:PERiod{?}				
Related Commands	:MEASure:SOURce<X>				
Return parameter	<table border="0"> <tr> <td style="padding-right: 10px;"><NR3></td> <td>Returns the period.</td> </tr> <tr> <td style="background-color: #cccccc; padding: 2px;">Chan Off</td> <td style="padding: 2px;">Indicates the source channel is not activated.</td> </tr> </table>	<NR3>	Returns the period.	Chan Off	Indicates the source channel is not activated.
<NR3>	Returns the period.				
Chan Off	Indicates the source channel is not activated.				

Note	Before using this command, select the measurement channel. See the example below.
Example	<pre>:MEASure:SOURce1 CH1 :MEASure:PERiod? 1.0E-3</pre> <p>Selects Channel 1, and then measures the period.</p>

:MEASure:PWIDth → Query

Description	Returns the first positive pulse width.
Syntax	:MEASure:PWIDth{?}
Related Commands	:MEASure:SOURce<X>

Return parameter	<NR3>	Returns the positive pulse width.
	Chan Off	Indicates the source channel is not activated.

Note Before using this command, select the measurement channel. See the example below.

Example :MEASure:SOURce1 CH1
 :MEASure:PWIDth?
 5.0E-6
 Selects Channel 1, and then measures the positive pulse width.

:MEASure:RISe → Query

Description	Returns the first pulse rise time.
Syntax	:MEASure:RISe{?}
Related Commands	:MEASure:SOURce<X>

Return parameter	<NR3>	Returns the rise time.
	Chan Off	Indicates the source channel is not activated.

Note Before using this command, select the measurement channel. See the example below.

Example :MEASure:SOURce1 CH1
 :MEASure:RISe?
 8.5E-6
 Selects Channel 1, and then measures the rise time.

:MEASure:ROVShoot → Query

Description	Returns the rising overshoot over the entire waveform in percentage.
Syntax	:MEASure:ROVShoot{?}

Related Commands :MEASure:SOURce<X>

Return parameter	<NR3>	Returns the overshoot.
	Chan Off	Indicates the source channel is not activated.

Note Before using this command, select the measurement channel. See the example below.

Example :MEASure:SOURce1 CH1
 :MEASure:ROVShoot?
 5.00E+00
 Selects Channel 1, and then measures the rise overshoot.

:MEASure:RPReshoot → Query

Description Returns rising preshoot over the entire waveform in percentage.

Syntax :MEASure:RPReshoot{?}

Related Commands :MEASure:SOURce<X>

Return parameter	<NR3>	Returns the rising preshoot.
	Chan Off	Indicates the source channel is not activated.

Note Before using this command, select the measurement channel. See the example below.

Example :MEASure:SOURce1 CH1
 :MEASure:RPReshoot?
 2.13E-2
 Selects Channel 1, and then measures the rise preshoot.

:MEASure:PPULSE

→ **Query**

Description	Returns the number of positive pulses.	
Syntax	:MEASure:PPULSE{?}	
Related Commands	:MEASure:SOURce<X>	
Return parameter	<NR3>	Returns the number of positive pulses.
	Chan Off	Indicates the source channel is not activated.
Note	Before using this command, select the measurement channel. See the example below.	
Example	<pre>:MEASure:SOURce1 CH1 :MEASure:PPULSE? 6.000E+00</pre> <p>Selects Channel 1, and then measures the number of positive pulses.</p>	

:MEASure:NPULSE

→ **Query**

Description	Returns the number of negative pulses.	
Syntax	:MEASure:NPULSE{?}	
Related Commands	:MEASure:SOURce<X>	
Return parameter	<NR3>	Returns the number of negative pulses.
	Chan Off	Indicates the source channel is not activated.

Note Before using this command, select the measurement channel. See the example below.

Example :MEASure:SOURce1 CH1
 :MEASure:NPULSE?
 4.000E+00
 Selects Channel 1, and then measures the number of negative pulses.

:MEASure:PEDGE → Query

Description Returns the number of positive edges.

Syntax :MEASure:PEDGE{?}

Related Commands :MEASure:SOURce<X>

Return parameter	<NR3>	Returns the number of positive edges.
	Chan Off	Indicates the source channel is not activated.

Note Before using this command, select the measurement channel. See the example below.

Example :MEASure:SOURce1 CH1
 :MEASure:PEDGE?
 1.100E+01
 Selects Channel 1, and then measures the number of positive edges.

:MEASure:NEDGE → Query

Description Returns the number of negative edges.

Syntax :MEASure:NEDGE{?}

Related Commands :MEASure:SOURce<X>

Return parameter	<NR3>	Returns the number of negative edges.
------------------	--------------------	---------------------------------------

	Chan Off	Indicates the source channel is not activated.
Note	Before using this command, select the measurement channel. See the example below.	
Example	<pre>:MEASure:SOURce1 CH1 :MEASure:NEDGE? 1.100E+01</pre> <p>Selects Channel 1, and then measures the number of negative edges.</p>	

:MEASure:AMPLitude → Query

Description	Returns the amplitude difference between the Vhigh-Vlow.	
Syntax	:MEASure:AMPLitude{?}	
Related Commands	:MEASure:SOURce<X>	
Return parameter	<NR3>	Returns the amplitude.
	Chan Off	Indicates the source channel is not activated.
Note	Before using this command, select the measurement channel. See the example below.	
Example	<pre>:MEASure:SOURce1 CH1 :MEASure:AMPLitude? 3.76E-3</pre> <p>Selects Channel 1, and then measures the amplitude.</p>	

:MEASure:MEAN → Query

Description	Returns the mean voltage/current of one or more full periods.	
Syntax	:MEASure:MEAN{?}	

Related Commands	:MEASure:SOURce<X>	
Return parameter	<NR3>	Returns the mean.
	Chan Off	Indicates the source channel is not activated.
Note	Before using this command, select the measurement channel. See the example below.	
Example	:MEASure:SOURce1 CH1 :MEASure:MEAN? 1.82E-3 Selects Channel 1, and then measures the mean value.	

:MEASure:CMEan

→ **Query**

Description	Returns the mean voltage/current of one full period.	
Syntax	:MEASure:CMEan{?}	
Related Commands	:MEASure:SOURce<X>	
Return parameter	<NR3>	Returns the cyclic mean.
	Chan Off	Indicates the source channel is not activated.
Note	Before using this command, select the measurement channel. See the example below.	
Example	:MEASure:SOURce1 CH1 :MEASure:CMEan? 9.480E-01 Selects Channel 1, and then measures the mean value of the first period.	

:MEASure:HIGH

→ Query

Description	Returns the global high voltage/current.	
Syntax	:MEASure:HIGH{?}	
Related Commands	:MEASure:SOURce<X>	
Return parameter	<NR3>	Returns the high value.
	Chan Off	Indicates the source channel is not activated.
Note	Before using this command, select the measurement channel. See the example below.	
Example	<pre>:MEASure:SOURce1 CH1 :MEASure:HIGH? 3.68E-3</pre> Selects Channel 1, and then measures the high voltage/current.	

:MEASure:LOW

→ Query

Description	Returns the global low voltage/current.	
Syntax	:MEASure:LOW{?}	
Related Commands	:MEASure:SOURce<X>	
Return parameter	<NR3>	Returns the global low value.
	Chan Off	Indicates the source channel is not activated.
Note	Before using this command, select the measurement channel. See the example below.	

Example :MEASure:SOURce1 CH1
 :MEASure:LOW?
 1.00E-0
 Selects Channel 1, and then measures the low current/voltage.

:MEASure:MAX → Query

Description Returns the maximum amplitude.

Syntax :MEASure:MAX{?}

Related Commands :MEASure:SOURce<X>

Return parameter	<NR3>	Returns the maximum amplitude.
	Chan Off	Indicates the source channel is not activated.

Note Before using this command, select the measurement channel. See the example below.

Example :MEASure:SOURce1 CH1
 :MEASure:MAX?
 1.90E-3
 Selects Channel 1, and then measures the maximum amplitude.

:MEASure:MIN → Query

Description Returns the minimum amplitude.

Syntax :MEASure:MIN{?}

Related Commands :MEASure:SOURce<X>

Return parameter	<NR3>	Returns the minimum amplitude.
	Chan Off	Indicates the source channel is not activated.

Note Before using this command, select the measurement channel. See the example below.

Example :MEASure:SOURce1 CH1
:MEASure:MIN?
-8.00E-3
Selects Channel 1, and then measures the minimum amplitude.

:MEASure:PK2PK → Query

Description Returns the peak-to-peak amplitude (difference between maximum and minimum amplitude).

Syntax :MEASure:PK2Pk{?}

Related Commands :MEASure:SOURce<X>

Return parameter	<NR3>	Returns the voltage or current peak to peak measurement.
	Chan Off	Indicates the source channel is not activated.

Note Before using this command, select the measurement channel. See the example below.

Example :MEASure:SOURce1 CH1
:MEASure:PK2Pk?
2.04E-1
Selects Channel 1, and then measures the peak-to-peak amplitude.

:MEASure:RMS → Query

Description Returns the root-mean-square voltage/current of one or more full periods.

Syntax :MEASure:RMS{?}

Related Commands	:MEASure:SOURce<X>	
Return parameter	<NR3>	Returns the RMS value.
	Chan Off	Indicates the source channel is not activated.
Note	Before using this command, select the measurement channel. See the example below.	
Example	:MEASure:SOURce1 CH1 :MEASure:RMS? 1.31E-3 Selects Channel 1, and then measures the RMS voltage/current.	

:MEASure:CRMS

→ **Query**

Description	Returns the root-mean-square voltage/current of one full periods.	
Syntax	:MEASure:CRMS{?}	
Related Commands	:MEASure:SOURce<X>	
Return parameter	<NR3>	Returns the CRMS value.
	Chan Off	Indicates the source channel is not activated.
Note	Before using this command, select the measurement channel. See the example below.	
Example	:MEASure:SOURce1 CH1 :MEASure:CRMS? 1.31E-3 Selects Channel 1, and then measures the CRMS voltage/current.	

:MEASure:AREa

→ Query

Description	Returns the voltage/current area over one or more full periods.	
Syntax	:MEASure:AREa{?}	
Related Commands	:MEASure:SOURce<X>	
Return parameter	<NR3>	Returns the area value.
	Chan Off	Indicates the source channel is not activated.
Note	Before using this command, select the measurement channel. See the example below.	
Example	:MEASure:SOURce1 CH1 :MEASure:AREa? 1.958E-03 Selects Channel 1, and then measures the area.	

:MEASure:CARea

→ Query

Description	Returns the voltage/current area over one full period.	
Syntax	:MEASure:CARea{?}	
Related Commands	:MEASure:SOURce<X>	
Return parameter	<NR3>	Returns the area value.
	Chan Off	Indicates the source channel is not activated.
Note	Before using this command, select the measurement channel. See the example below.	

Example :MEASure:SOURce1 CH1
 :MEASure:CARea?
 1.958E-03
 Selects Channel 1, and then measures the area.

:MEASure:FRRDelay → Query

Description Returns the delay between the first rising edge of source1 and the first rising edge of source2.

Syntax :MEASure:FRRDelay{?}

Related Commands :MEASure:SOURce<X>

Return parameter	<NR3>	Returns the delay.
	Chan Off	Indicates the source channel is not activated.

Note Select the two source channels before entering this command.

Example :MEASure:SOURce1 CH1
 :MEASure:SOURce2 CH2
 :MEASure:FRRDelay?
 -4.68E-6
 Select channel 1 and 2 as source1/2, and then measure FRR.

:MEASure:FRFDelay → Query

Description Returns the delay between the first rising edge of source1 and the first falling edge of source2.

Syntax :MEASure:FRFDelay{?}

Related Commands :MEASure:SOURce<X>

Return parameter	<NR3>	Returns the delay.
------------------	-------	--------------------

Chan Off	Indicates the source channel is not activated.
----------	--

Note Select the two source channels before entering this command.

Example :MEASure:SOURce1 CH1
 :MEASure:SOURce2 CH2
 :MEASure:FRFDelay?
 3.43E-6
 Select channel 1 and 2 as source1/2, and then measures FRF.

:MEASure:FFRDelay → Query

Description Returns the delay between the first falling edge of source1 and the first rising edge of source2.

Syntax :MEASure:FRRDelay{?}

Related Commands :MEASure:SOURce<X>

Return parameter	<NR3>	Returns the delay.
	Chan Off	Indicates the source channel is not activated.

Note Select the two source channels before entering this command.

Example :MEASure:SOURce1 CH1
 :MEASure:SOURce2 CH2
 :MEASure:FRRDelay?
 -8.56E-6
 Select channel 1 and 2 as delay source1/2, and then measure FFR.

:MEASure:FFFDelay

→ Query

Description	Returns the delay between the first falling edge of source1 and the first falling edge of source2.	
Syntax	:MEASure:FFFDelay{?}	
Related Commands	:MEASure:SOURce<X>	
Return parameter	<NR3>	Returns the delay.
	Chan Off	Indicates the source channel is not activated.
Note	Select the two source channels before entering this command.	
Example	:MEASure:SOURce1 CH1 :MEASure:SOURce2 CH2 :MEASure:FFFDelay? -8.89E-6 Select channel 1 and 2 as delay source1/2, and then measure FFF.	

:MEASure:LRRDelay

→ Query

Description	Returns the delay between the first rising edge of source1 and the last rising edge of source2.	
Syntax	:MEASure:LRRDelay{?}	
Related Commands	:MEASure:SOURce<X>	
Return parameter	<NR3>	Returns the delay.
	Chan Off	Indicates the source channel is not activated.
Note	Select the two source channels before entering this command.	

Example :MEASure:SOURce1 CH1
 :MEASure:SOURce2 CH2
 :MEASure:LRRDelay?
 -8.89E-6
 Select channel 1 and 2 as delay source1/2, and then measure LRR.

:MEASure:LRFDelay → Query

Description Returns the delay between the first rising edge of source1 and the last rising edge of source2.

Syntax :MEASure:LRFDelay{?}

Related Commands :MEASure:SOURce<X>

Return parameter	<NR3>	Returns the delay.
	Chan Off	Indicates the source channel is not activated.

Note Select the two source channels before entering this command.

Example :MEASure:SOURce1 CH1
 :MEASure:SOURce2 CH2
 :MEASure:LRFDelay?
 -4.99E-6
 Select channel 1 and 2 as delay source1/2, and then measure LRF.

:MEASure:LFRDelay → Query

Description Returns the delay between the first falling edge of source1 and the last rising edge of source2.

Syntax :MEASure:LFRDelay{?}

Related Commands :MEASure:SOURce<X>

Return parameter	<NR3>	Returns the delay.
	Chan Off	Indicates the source channel is not activated.

Note Select the two source channels before entering this command.

Example

```
:MEASure:SOURce1 CH1
:MEASure:SOURce2 CH2
:MEASure:LFRDelay?
-9.99E-6
```

Select channel 1 and 2 as delay source1/2, and then measure LFR.

:MEASure:LFFDelay → Query

Description Returns the delay between the first falling edge of source1 and the last falling edge of source2.

Syntax :MEASure:LFFDelay{?}

Related Commands :MEASure:SOURce<X>

Return parameter	<NR3>	Returns the delay.
	Chan Off	Indicates the source channel is not activated.

Note Select the two source channels before entering this command.

Example

```
:MEASure:SOURce1 CH1
:MEASure:SOURce2 CH2
:MEASure:LFFDelay?
-9.99E-6
```

Select channel 1 and 2 as delay source1/2, and then measure LFF.

:MEASure:PHAsE

→ Query

Description	Returns the phase between source 1 and source 2.	
Syntax	:MEASure:PHAsE{?}	
Related Commands	:MEASure:SOURce<X>	
Return parameter	<NR3>	Returns the phase difference.
	Chan Off	Indicates the source channel is not activated.
Note	Select the two source channels before entering this command.	
Example	<pre>:MEASure:SOURce1 CH1 :MEASure:SOURce2 CH2 :MEASure:PHAsE? 4.50E+01</pre> <p>Select channel 1 and 2 as phase source1/2, and then measure the phase in degrees.</p>	

:MEASure:PFLI

→ Query

Description	Returns the % flicker of times.	
Syntax	:MEASure:PFLI?	
Related Commands	:MEASure:SOURce<x>	
Return parameter	<NR3>	
	Chan Off	Indicates the source channel is not activated.
Note	Before using this command, select the measurement channel. See the example below.	

Example :MEASure:SOURce1 CH1
 :MEASure:PFLI ?
 5.950E+01
 Selects Channel 1 as the source, and then measures the % flicker of times.

:MEASure:FLI → Query

Description Returns the flicker idx of times.

Syntax :MEASure:FLI?

Related Commands :MEASure:SOURce<x>

Return parameter <NR3>
 Chan Off Indicates the source channel is not activated.

Note Before using this command, select the measurement channel. See the example below.

Example :MEASure:SOURce1 CH1
 :MEASure:FLI ?
 2.870E-01
 Selects Channel 1 as the source, and then measures the flicker idx of times.

Measurement Commands

:MEASUrement:MEAS<X>:SOURCE<X>107
 :MEASUrement:MEAS<X>:TYPe108
 :MEASUrement:MEAS<X>:STATE108
 :MEASUrement:MEAS<X>:VALue109
 :MEASUrement:MEAS<X>:MAXimum110
 :MEASUrement:MEAS<X>:MEAN111
 :MEASUrement:MEAS<X>:MINimum111
 :MEASUrement:MEAS<X>:STDdev112
 :MEASUrement:STATIstics:MODE113
 :MEASUrement:STATIstics:WEIghting113
 :MEASUrement:STATIstics113

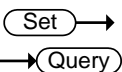
:MEASUrement:MEAS<X>:SOURCE<X> 

Description	Sets or queries the measurement source for a selected automatic measurement. This is a statistics related command.	
Syntax	:MEASUrement:MEAS<X>:SOURCE<X> { CH1 CH2 CH3 CH4 MATH D0 D1 D2 D3 D4 D5 D6 D7 D8 D9 D10 D11 D12 D13 D14 D15 ? }	
Related commands	:MEASUrement:MEAS<X>:TYPe	
Parameter	MEAS<X>	The automatic measurement number from 1 to 8.
	SOURCE<X>	SOURCE1: the source for all single channel measurements.
	SOURCE<X>	SOURCE2: the source for all delay or phase measurements.
	CH1 to CH4	Channel 1, 2, 3, 4
	MATH	Math source

	D0~D15	Digital source D0~D15
Return parameter	CH1 to CH4	Channel 1, 2, 3, 4
	MATH	Math source

Example :MEASUrement:MEAS1:SOURCE1?
>CH1
Returns the (first) source for measurement 1.

Set →

→ Query

:MEASUrement:MEAS<X>:TYPE

Description Sets or queries the measurement type for a selected automatic measurement. This is a statistics related command.

Syntax :MEASUrement:MEAS<X>:TYPE
{PK2pk | MAXimum | MINImum | AMPlitude | HIGH | LOW | MEAN | CMean | RMS | CRM | AREa | CAREa | ROVShoot | FOVShoot | RPReshoot | FPReshoot | FREQuency | PERIod | RISE | FALL | PWidth | NWidth | PDUty | PPULSE | NPULSE | PEDGE | NEDGE | PFLIcker | FLIcker | FRRDelay | FRFDelay | FFRDelay | FFFDelay | LRRDelay | LRFDelay | LFRDelay | LFFDelay | PHAse | ?}

Related commands :MEASUrement:MEAS<X>:SOURCE<X>

Parameter	MEAS<X>	The automatic measurement number from 1 to 8.
-----------	---------	---

Return parameter Returns the measurement type

Example :MEASUrement:MEAS1:TYPE RMS
Sets measurement 1 to RMS measurement.

Set →

→ Query

:MEASUrement:MEAS<X>:STATE

Description Sets or queries the state of a selected measurement. This is a statistics related command.

Syntax :MEASUrement:MEAS<X>:STATE { ON | OFF | 1 | 0 | ? }

Related commands	:MEASUrement:MEAS<X>:SOURce<X> :MEASUrement:MEAS<X>:TYPE	
Parameter	MEAS<X>	The automatic measurement number from 1 to 8.
	ON/1	Turn the measurement on.
	OFF/0	Turn the measurement off.
Return parameter	0	Measurement is off.
	1	Measurement is on.
Example	:MEASUrement:MEAS1:STATE 1 Turns measurement 1 on.	

:MEASUrement:MEAS<X>:VALue → Query

Description	Returns the measurement results for the selected measurement. This is a statistics related command.	
Syntax	:MEASUrement:MEAS<X>:VALue?	
Related Commands	:MEASure:SOURce<X>	
Parameter	MEAS<X>	The automatic measurement number from 1 to 8.
Return parameter	<NR3>	Returns the measurement for the selected measurement number.
Note	The measurement source(s), measurement number, measurement type and measurement state must first be set before a measurement result can be returned.	

Example :MEASUrement:MEAS1:SOUrce1 CH1
 :MEASUrement:MEAS1:TYPe PK2PK
 :MEASUrement:MEAS1:STATE ON
 :MEASUrement:MEAS1:VALue?
 5.000E+0

Selects channel 1 as the source for measurement 1, sets measurement 1 to peak to peak measurement and then turns on the measurement. The result returns the peak to peak measurement.

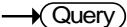
:MEASUrement:MEAS<X>:MAXimum 

Description Returns the maximum measurement results for the selected measurement from the last time the statistics were reset. This is a statistics related command.

Syntax :MEASUrement:MEAS<X>:MAXimum?

Related Commands :MEASUrement:STATIstics:MODE

Parameter	MEAS<X>	The automatic measurement number from 1 to 8.
-----------	---------	---

Return parameter	<NR3>	Returns the measurement for the selected measurement number.
------------------	-------	--

Example :MEASUrement:MEAS3:SOUrce1 CH1
 :MEASUrement:MEAS3:TYPe PK2PK
 :MEASUrement:MEAS3:STATE ON
 :MEASUrement:STATIstics:MODE ON
 :MEASUrement:MEAS3:MAXimum?
 2.800E-02

Returns the maximum measurement result for measurement number 3.

:MEASUrement:MEAS<X>:MEAN → Query

Description Returns the mean measurement results for the selected measurement from the last time the statistics were reset. This is a statistics related command.

Syntax :MEASUrement:MEAS<X>:MEAN?

Related Commands :MEASUrement:STATIstics:MODE

Parameter MEAS<X> The automatic measurement number from 1 to 8.

Return parameter <NR3> Returns the measurement for the selected measurement number.

Example

```
:MEASUrement:MEAS3:SOUrce1 CH1
:MEASUrement:MEAS3:TYPe PK2PK
:MEASUrement:MEAS3:STATE ON
:MEASUrement:STATIstics:MODE ON
:MEASUrement:MEAS3:MEAN?
2.090E-02
```

Returns the mean measurement result for measurement number 3.

:MEASUrement:MEAS<X>:MINIum → Query

Description Returns the minimum measurement results for the selected measurement from the last time the statistics were reset. This is a statistics related command.

Syntax :MEASUrement:MEAS<X>:MINIum?

Related Commands :MEASUrement:STATIstics:MODE

Parameter MEAS<X> The automatic measurement number from 1 to 8.

Return parameter	<NR3>	Returns the measurement for the selected measurement number.
------------------	-------	--

Example

```
:MEASUrement:MEAS3:SOUrce1 CH1
:MEASUrement:MEAS3:TYPe PK2PK
:MEASUrement:MEAS3:STATE ON
:MEASUrement:STATIstics:MODE ON
:MEASUrement:MEAS3:MINIum?
1.600E-02
```

Returns the minimum measurement result for measurement number 3.

:MEASUrement:MEAS<X>:STDdev → Query

Description

Returns the standard deviation for the selected measurement from the last time the statistics were reset. This is a statistics related command.

Syntax

```
:MEASUrement:MEAS<X>:STDdev?
```

Related Commands

```
:MEASUrement:STATIstics:MODE
```

Parameter	MEAS<X>	The automatic measurement number from 1 to 8.
-----------	---------	---

Return parameter	<NR3>	Returns the measurement for the selected measurement number.
------------------	-------	--

Example

```
:MEASUrement:MEAS3:SOUrce1 CH1
:MEASUrement:MEAS3:TYPe PK2PK
:MEASUrement:MEAS3:STATE ON
:MEASUrement:STATIstics:MODE ON
:MEASUrement:MEAS3:STDdev?
1.530E-03
```

Returns the standard deviation for measurement number 3.

:MEASUREMENT:STATISTICS:MODE (Set) →
→ (Query)

Description	Puts the statics measurement results on the display or queries whether the statistics are displayed.	
Syntax	:MEASUREMENT:STATISTICS:MODE {OFF ON ?}	
Related commands	:MEASUREMENT:STATISTICS	
Parameter/ Return parameter	ON	Display the statistics on the screen.
	OFF	Remove the statistics from the screen
Example	:MEASUREMENT:STATISTICS:MODE ON Displays statistics on the screen.	

:MEASUREMENT:STATISTICS:WEIGHTING (Set) →
→ (Query)

Description	Sets and queries the number of samples (weighting) used for the statistics calculations.	
Syntax	:MEASUREMENT:STATISTICS:WEIGHTING { <NR1> ? }	
Parameter/ Return parameter	<NR1>	Number of samples (2~1000)
Example	:MEASUREMENT:STATISTICS:WEIGHTING 5 Sets the number of samples to 5.	

:MEASUREMENT:STATISTICS (Set) →

Description	Resets the statics calculations. This command will clear all the currently accumulated measurements.
Syntax	:MEASUREMENT:STATISTICS {RESET}

Reference Commands

:REF<X>:DISPlay	114
:REF<X>:TIMebase:POSition	114
:REF<X>:TIMebase:SCALe	115
:REF<X>:OFFSet	115
:REF<x>:SCALe	116

:REF<X>:DISPlay





Description Sets or queries whether a reference waveform will be shown on the display. A reference waveform must first be saved before this command can be used.

Syntax :REF<x>:DISPlay { OFF| ON| ? }

Parameter	<X>	Reference waveform 1, 2, 3, 4.
	OFF	Turns the selected reference waveform off
	ON	Turns the selected reference waveform on

Return parameter Returns the status of the selected reference waveform. (OFF, ON).

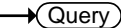
Example :REF1:DISPlay ON
Turns on reference1 (REF 1) on the display.

:REF<X>:TIMebase:POSition



Description Sets or returns the selected reference waveform time base position.

Syntax :REF<X>:TIMebase:POSition { <NRf> | ? }

Related commands :REF<X>:DISPlay

Parameter	<X>	Reference waveform 1, 2, 3, 4.
	<NRf>	Horizontal co-ordinates

Return parameter	<NR3>	Returns the reference waveform position
------------------	-------	---

Example :REF1:TIMEbase:POSition -5.000E-5
 Selects reference 1, and then sets the horizontal position to -50us.

Set →

→ Query

:REF<X>:TIMEbase:SCALE

Description Sets or returns the selected reference waveform time base scale.

Syntax :REF<X>:TIMEbase:SCALE { <NRf> | ?}

Related commands :REF<X>:DISPlay

Parameter	<X>	Reference waveform 1, 2, 3, 4.
	<NRf>	Horizontal scale

Return parameter	<NR3>	Returns the reference waveform scale.
------------------	-------	---------------------------------------

Example :REF1:TIMEbase:SCALE 5.00E-4
 Selects reference 1, and then sets the horizontal scale to 500us/div.

Set →

→ Query

:REF<X>:OFFSet

Description Sets or returns the selected reference waveform vertical position (offset).

Syntax :REF<X>:OFFSet { <NRf> | ?}

Related commands :REF<X>:DISPlay

Parameter	<X>	Reference waveform 1, 2, 3, 4.
	<NRf>	Vertical offset

Return parameter <NR3> Returns the reference waveform vertical position.

Example :REF1:OFFSet -5.000E-2
 Selects reference 1, and then sets the vertical position to -50mV/mA.

:REF<x>:SCALE

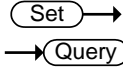

Description Sets or returns the selected reference waveform vertical scale.

Syntax :REF<X>:SCALE { <NRf> | ? }

Related commands :REF<X>:DISPlay

Parameter <X> Reference waveform 1, 2, 3, 4.
 <NRf> Vertical scale

Return parameter <NR3> Returns the reference waveform vertical scale.

Example :REF1:SCALE 5.000E-2
 Selects reference 1, and then sets the vertical scale to 50mV | mA/div.

Run Command

:RUN



Description	The run command allows the oscilloscope to continuously make acquisitions (equivalent to pressing the Run key on the front panel).
-------------	--

Syntax	:RUN
--------	------

Stop Command

:STOP



Description	The stop command stops the oscilloscope making further acquisitions (equivalent to pressing the Stop key on the front panel).
-------------	---

Syntax	:STOP
--------	-------

Single Command

:SINGle



Description	The single command allows the oscilloscope to capture a single acquisition when trigger conditions have been fulfilled (equivalent to pressing the Single key on the front panel).
-------------	--

Syntax	:SINGle
--------	---------

Force Command

:FORCe



Description	The Force command forces an acquisition (equivalent to pressing the Force-Trig key on the front panel).
-------------	---

Syntax	:FORCe
--------	--------

Timebase Commands

:TIMebase:EXPand	119
:TIMebase:POSition	119
:TIMebase:SCALe.....	119
:TIMebase:MODE	120
:TIMebase:WINDow:POSition	120
:TIMebase:WINDow:SCALe	121

:TIMebase:EXPand

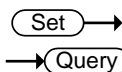

Description Sets or queries the horizontal expansion mode.

Syntax :TIMebase:EXPand {CENTer|TRIGger|?}

Parameter/Return parameter	CENTer	Expand from the center of the display.
	TRIGger	Expand from the trigger point.

Example :TIMebase:EXPand TRIGger
 Sets the expansion point to the trigger point.

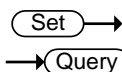

:TIMebase:POSition

Description Sets or queries the horizontal position.

Syntax :TIMebase:POSition {<NRf> | ?}

Parameter	<NRf>	Horizontal position
Return parameter	<NR3>	Returns the horizontal position

Example :TIMebase:POSition 5.00E-4
 Sets the horizontal position as 500us.

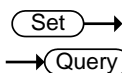

:TIMebase:SCALe

Description Sets or queries the horizontal scale.

Syntax	:TIMebase:SCALe {<NRf> ?}	
Parameter	<NRf>	Horizontal scale
Return parameter	<NR3>	Returns the horizontal scale.
Example	:TIMebase:SCALe 5.00E-2 Sets the horizontal scale to 50ms/div.	

Set →

:TIMebase:MODE

→ Query

Description	Sets or queries the time base mode. The time base mode determines the display view window on the scope.	
Syntax	:TIMebase:MODE {MAIN WINDow XY ?}	
Parameter	MAIN	Sets the time base mode to the main screen.
	WINDow	Sets the time base mode to the zoom window.
	XY	Sets the time base mode to the XY display.
Return parameter	Returns the time base mode (MAIN, WINDOW, XY)	
Example	:TIMebase:MODE MAIN Sets the time base mode to the main mode.	

Set →

:TIMebase:WINDow:POSition

→ Query

Description	Sets or queries the zoom horizontal position.	
Syntax	:TIMebase:WINDow:POSition {<NRf> ?}	
Related commands	:TIMebase:MODE	
Parameter	<NRf>	Horizontal position for zoom window
Return parameter	<NR3>	Returns the zoom horizontal position.

Example :TIMebase:WINDow:POSition 2.0E-3
 Sets the zoom horizontal position as 20ms.

:TIMebase:WINDow:SCALE 

Description Sets or queries the zoom horizontal scale.

Note If the oscilloscope is under “ZOOM” mode, the main timebase function will be disabled and cannot be modified.

Syntax :TIMebase:WINDow:SCALE {<NRf> | ?}

Related commands :TIMebase:MODE

Parameter	<NRf>	Zoom horizontal scale. The range will depend on the time base.
-----------	-------	--

Return parameter	<NR3>	Returns the zoom horizontal scale.
------------------	-------	------------------------------------

Example :TIMebase:WINDow:SCALE 2.0E-3
 Sets the zoom horizontal scale to 2ms.

Trigger Commands

:TRIGger:FREQuency.....	124
:TRIGger:TYPe	124
:TRIGger:SOURce	125
:TRIGger:COUPle.....	125
:TRIGger:NREJ	126
:TRIGger:MODe.....	126
:TRIGger:HOLDoff.....	126
:TRIGger:LEVel.....	127
:TRIGger:HLEVel	127
:TRIGger:LLEVel.....	128
:TRIGger:EDGE:SLOP.....	128
:TRIGger:DElay:SLOP	128
:TRIGger:DElay:TYPe.....	129
:TRIGger:DElay:TIme.....	129
:TRIGger:DElay:EVENt.....	130
:TRIGger:DElay:LEVel	130
:TRIGger:PULSEWidth:POLarity	130
:TRIGger:RUNT:POLarity	131
:TRIGger:RUNT:WHEn.....	131
:TRIGger:RUNT:TIme.....	132
:TRIGger:RISEFall:SLOP.....	132
:TRIGger:RISEFall:WHEn	132
:TRIGger:RISEFall:TIme	133
:TRIGger:VIDeo:TYPe	134
:TRIGger:VIDeo:FIELd	134
:TRIGger:VIDeo:LINE	135
:TRIGger:VIDeo:POLarity	135
:TRIGger:PULSe:WHEn	135
:TRIGger:PULSe:TIme	136
:TRIGger:TIMEOut:WHEn.....	136
:TRIGger:TIMEOut:TImER	137
:TRIGger:ALTErnate	137

:TRIGger:STATe	138
:TRIGger:EXTERnal:PROBe:TYPe	138
:TRIGger:EXTERnal:PROBe:RATio	140
:TRIGger:BUS:TYPe	140
:TRIGger:BUS:THReshold:CH<x>	140
:TRIGger:BUS:B1:I2C:CONDition	141
:TRIGger:BUS:B1:I2C:ADDReSS:MODE	142
:TRIGger:BUS:B1:I2C:ADDReSS:TYPe	142
:TRIGger:BUS:B1:I2C:ADDReSS:VALue	143
:TRIGger:BUS:B1:I2C:ADDReSS:DIRection	143
:TRIGger:BUS:B1:I2C:DATA:SIZE	144
:TRIGger:BUS:B1:I2C:DATA:VALue	144
:TRIGger:BUS:B1:UART:CONDition	145
:TRIGger:BUS:B1:UART:RX:DATA:SIZE	146
:TRIGger:BUS:B1:UART:RX:DATA:VALue	146
:TRIGger:BUS:B1:UART:TX:DATA:SIZE	147
:TRIGger:BUS:B1:UART:TX:DATA:VALue	147
:TRIGger:BUS:B1:SPI:CONDition	148
:TRIGger:BUS:B1:SPI:DATA:SIZE	149
:TRIGger:BUS:B1:SPI:DATA:MISO:VALue	149
:TRIGger:BUS:B1:SPI:DATA:MOSI:VALue	150
:TRIGger:BUS:B1:CAN:CONDition	151
:TRIGger:BUS:B1:CAN:FRAMeType	151
:TRIGger:BUS:B1:CAN:IDentifier:MODE	152
:TRIGger:BUS:B1:CAN:IDentifier:VALue	152
:TRIGger:BUS:B1:CAN:IDentifier:DIRection	153
:TRIGger:BUS:B1:CAN:DATA:QUALifier	153
:TRIGger:BUS:B1:CAN:DATA:SIZE	154
:TRIGger:BUS:B1:CAN:DATA:VALue	155
:TRIGger:BUS:B1:LIN:CONDition	155
:TRIGger:BUS:B1:LIN:DATA:QUALifier	156
:TRIGger:BUS:B1:LIN:DATA:SIZE	157
:TRIGger:BUS:B1:LIN:DATA:VALue	157
:TRIGger:BUS:B1:LIN:ERRTYPe	158
:TRIGger:BUS:B1:LIN:IDentifier:VALue	159

:TRIGger:LOGic:INPut:CLOCK:SOURce..... 159
 :TRIGger:LOGic:INPut:CLOCK:EDGe..... 160
 :TRIGger:LOGic:FUNcTion 160
 :TRIGger:LOGic:PATtern 161
 :TRIGger:LOGic:PATtern:INPut:D<x> 161
 :TRIGger:LOGic:PATtern:DELtAtime..... 162
 :TRIGger:LOGic:PATtern:WHEn 162

:TRIGger:FREQUency → Query

Description	Queries the trigger frequency.
Syntax	:TRIGger:FREQUency{?}
Return parameter	<NR3> Returns the trigger frequency.
Example	:TRIGger:FREQUency? 1.032E+3 Returns the trigger frequency.

:TRIGger:TYPE Set →
→ Query

Description	Sets or queries the trigger type.
Syntax	:TRIGger:TYPE {EDGE DELay PULSEwidth VIDEo RUNT RISEFall LOGic BUS TIMEOut ? }
Parameter	EDGE Edge trigger DELay Delay trigger PULSEwidth Pulse width trigger VIDEo Video trigger RUNT Runt trigger RISEFall Rise and fall trigger LOGic Logic trigger BUS Bus trigger

TIMEOut Timeout trigger

Return parameter Returns the trigger type.

Example :TRIGger:TYPe EDGE
Sets the trigger type to edge.

Set →

→ Query

:TRIGger:SOURce

Description Sets or queries the trigger source.

Syntax :TRIGger:SOURce
{ CH1 | CH2 | CH3 | CH4 | EXT | LINe | D0 | D1 | D2 | D3 | D4 | D5 | D6 | D7 | D8 | D9 | D10 | D11 | D12 | D13 | D14 | D15 | ? }

Parameter	CH1 to CH4	Channel 1 to channel 4
	EXT	External source
	LINe	AC Line
	D0~D15	Digital channels D0~D15

Return parameter Returns the trigger source.

Example :TRIGger:SOURce CH1
Sets the trigger source to channel 1.

Set →

→ Query

:TRIGger:COUPlE

Description Sets or queries the trigger coupling.

Note Applicable for edge and delay triggers only.

Syntax :TRIGger:COUPlE {AC | DC | HF | LF | ?}

Parameter	AC	AC mode
	DC	DC mode
	HF	High frequency rejection
	LF	Low frequency rejection

Return parameter Returns the trigger coupling.

Example :TRIGger:COUPle AC
Sets the trigger coupling to AC.

Set →

:TRIGger:NREJ

→ Query

Description Sets or queries noise rejection status.

Syntax :TRIGger:NREJ {OFF| ON| ?}

Parameter	OFF	Turns noise rejection off
	ON	Turns noise rejection on

Return parameter Returns the noise rejection status (ON, OFF).

Example :TRIGger:NREJ ON
Turns noise rejection on.

Set →

:TRIGger:MODE

→ Query

Description Sets or queries the trigger mode.

Syntax :TRIGger:MODE {AUto | NORMal | ?}

Parameter	AUto	Auto trigger (Untriggered roll)
	NORMal	Normal trigger

Return parameter Returns the trigger mode.

Example :TRIGger:MODE NORMal
Sets the trigger mode to normal.

Set →

:TRIGger:HOLDoff

→ Query

Description Sets or queries the holdoff time.

Syntax :TRIGger:HOLDoff {<NRf> | ?}

Parameter	<NRf>	Holdoff time
-----------	-------	--------------

Return parameter <NR3> Returns the trigger holdoff time.

Example :TRIGger:HOLDoff 1.00E-8
Sets the trigger holdoff time to 10ns.

:TRIGger:LEVel

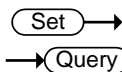

Description	Sets or queries the level.	
Note	Not applicable to Pulse Runt and Rise & Fall triggers.	
Syntax	:TRIGger:LEVel {TTL ECL SETTO50 <NRf> ?}	
Related commands	:TRIGger:TYPe	
Parameter	<NRf>	Trigger level value.
	TTL	Sets the trigger level to TTL.
	ECL	Sets the trigger level to ECL.
	SETTO50	Sets the trigger level to the User level (50% by default).
Return parameter	<NR3>	Returns the trigger level.
Example1	:TRIGger:LEVel TTL Sets the trigger to TTL.	
Example2	:TRIGger:LEVel 3.30E-1 Sets the trigger level to 330mV/mA.	

:TRIGger:HLEVel

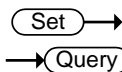

Description	Sets or queries the high trigger level.	
Note	Applicable for Rise and Fall/Pulse Runt triggers.	
Syntax	:TRIGger:HLEVel {<NRf> ?}	
Related commands	:TRIGger:TYPe	
Parameter	<NRf>	High level value.
Return parameter	<NR3>	Returns the trigger high level.

Example :TRIGger:HLEVel 3.30E-1
Sets the trigger high level to 330mV/mA.

Set →

:TRIGger:LLEVel

→ Query

Description Sets or queries the low trigger level.

Note Applicable for Rise and Fall/Pulse Runt triggers.

Syntax :TRIGger:LLEVel {<NRf> | ?}

Related commands :TRIGger:TYPe

Parameter	<NRf>	Low level value.
Return parameter	<NR3>	Returns the trigger low level.

Example :TRIGger:LLEVel -3.30E-3
Sets the trigger low level to -330mV/mA.

Set →

:TRIGger:EDGE:SLOP

→ Query

Description Sets or queries the trigger slope.

Syntax :TRIGger:EDGE:SLOP {RISe | FALL | EITheR | ?}

Related commands :TRIGger:TYPe

Parameter	RISe	Rising slope
	FALL	Falling slope
	EITheR	Either rising or falling slope

Return parameter Returns the trigger slope.

Example :TRIGger:EDGE:SLOP FALL
Sets the trigger slope to falling.

Set →

:TRIGger:DElay:SLOP

→ Query

Description Sets or queries the trigger slope for the delay trigger.

Syntax :TRIGger:DElay:SLOP {RISe | FALL | EITHer | ? }

Related commands :TRIGger:TYPE

Parameter	RISe	Rising slope
	FALL	Falling slope
	EITHer	Either rising or falling slope

Return parameter Returns the trigger slope.

Example :TRIGger:DElay:SLOP FALL
Sets the trigger slope to falling.

Set →

→ Query

:TRIGger:DElay:TYPE

Description Sets or queries the trigger delay type.

Syntax :TRIGger:DElay:TYPE {TIME | EVENT | ? }

Related commands :TRIGger:TYPE

Parameter	TIME	Sets the delay type to time.
	EVENT	Sets the delay type to event.

Return parameter Returns the trigger delay type.

Example :TRIGger:DElay:TYPE TIME
Sets the delay type to time delay.

Set →

→ Query

:TRIGger:DElay:TIME

Description Sets or queries the delay time value.

Syntax :TRIGger:DElay:TIME {<NRf> | ? }

Related commands :TRIGger:DElay:TYPE

Parameter	<NRf>	Delay time (1.00E-8~1.00E+1)
-----------	-------	------------------------------

Return parameter <NR3> Returns the delay time.

Example :TRIGger:DElay:TIME 1.00E-6
Sets the delay time to 1us.

Set →
→ Query

:TRIGger:DElay:EVENT

Description Sets or queries the number of events for the event delay trigger.

Syntax :TRIGger:DElay:EVENT {<NR1> | ?}

Related commands :TRIGger:DElay:TYPE

Parameter <NR1> 1~65535 events

Return parameter <NR1> Returns the number of events.

Example :TRIGger:DElay:EVENT 2
Sets the number of events to 2.

Set →
→ Query

:TRIGger:DElay:LEVel

Description Sets or queries the trigger delay level.

Syntax :TRIGger:DElay:LEVel {<NRf> | ?}

Parameter <NRf> Delay trigger level

Return parameter <NR3> Returns the delay trigger.

Example :TRIGger:DElay:LEVel 5.00E-3
Sets the delay trigger level to 5mV/mA.

Set →
→ Query

:TRIGger:PULSEWidth:POLarity

Description Sets or queries the pulse width trigger polarity.

Syntax :TRIGger:PULSEWidth:POLarity
{POSitive | NEGative | ?}

Related commands :TRIGger:TYPe

Parameter	POSitive	Positive polarity
	NEGative	Negative polarity

Return parameter Returns the pulse width polarity.

Example :TRIGger:PULSEWidth:POLarity POSitive
Sets the pulse width polarity to positive.

Set →

→ Query

:TRIGger:RUNT:POLarity

Description Sets or queries the Pulse Runt trigger polarity.

Syntax :TRIGger:RUNT:POLarity { POSitive | NEGative | EITher | ? }

Related commands :TRIGger:TYPe

Parameter	POSitive	Positive polarity
	NEGative	Negative polarity
	EITher	Positive or negative polarity

Return parameter Returns the pulse runt trigger polarity.

Example :TRIGger:RUNT:POLarity POSitive
Sets the Pulse Runt trigger polarity to positive.

Set →

→ Query

:TRIGger:RUNT:WHEn

Description Sets or queries the Pulse Runt trigger conditions.

Syntax :TRIGger:RUNT:WHEn { MOREthan | LESSthan | Equal | UNEQual | ? }

Related commands :TRIGger:TYPe
:TRIGger:RUNT:TIME

Parameter	MOREthan	>
	LESSthan	<

Equal =
 UNEQual ≠

Return parameter Returns the pulse runt trigger condition.

Example :TRIGger:RUNT:WHEn UNEQual
 Sets the Pulse Runt trigger condition to unequal (≠).

:TRIGger:RUNT:TIME (Set) →
 → (Query)

Description Sets or queries the Pulse Runt trigger time.

Syntax :TRIGger:RUNT:TIME {<NRf> | ? }

Related commands :TRIGger:TYPe
 :TRIGger:RUNT:WHEn

Parameter <NRf> Pulse runt time (4nS to 10S)

Return Parameter <NR3> Returns the runt time in seconds.

Example :TRIGger:RUNT:TIME 4.00E-5
 Sets the runt time to 40.0uS.

:TRIGger:RISEFall:SLOP (Set) →
 → (Query)

Description Sets or queries the Rise & Fall slope.

Syntax :TRIGger:RISEFall:SLOP {RISe | FALL | EITHer | ? }

Parameter RISe Rising slope
 FALL Falling slope
 EITHer Either rising or falling slope

Return parameter Returns the rise & fall slope.

Example :TRIGger:RISEFall:SLOP RISe
 Sets the Rise & Fall slope to rising.

:TRIGger:RISEFall:WHEn (Set) →
 → (Query)

Description	Sets or queries the rise/fall trigger conditions.
Syntax	:TRIGger:RISEFall:WHEn {MOREthan LESSthan EQual UNEQual ? }
Related commands	:TRIGger:TYPE :TRIGger:RISEFall:TIME
Parameter	MOREthan > LESSthan < Equal = UNEQual ≠
Return parameter	Returns the rise/fall trigger condition.
Example	:TRIGger:RISEFall:WHEn UNEQual Sets the Rise and Fall trigger condition to unequal (≠).

:TRIGger:RISEFall:TIME

Description	Sets or queries the Rise and Fall time.
Syntax	:TRIGger:RISEFall:TIME {<NRf> ? }
Related commands	:TRIGger:TYPE :TRIGger:RISEFall:WHEn
Parameter	<NRf> Rise and Fall time (4nS to 10S)
Return Parameter	<NR3> Returns the rise and fall time in seconds.
Example	:TRIGger:RISEFall:TIME 4.00E-5 Sets the trigger rise & fall to 40.0us.

Set →

→ Query

:TRIGger:VIDeo:TYPe

Description	Sets or queries the video trigger type.	
Syntax	:TRIGger:VIDeo:TYPe {NTSC PAL SECam EDTV480P EDTV576P HDTV720P HDTV1080I HDTV1080P ? }	
Related commands	:TRIGger:TYPe	
Parameter	NTSC	NTSC
	PAL	PAL
	SECam	SECAM
	EDTV480P	Extra definition TV 480P
	EDTV576P	Extra definition TV 576P
	HDTV720P	High definition TV 720P
	HDTV1080I	High definition TV 1080i
	HDTV1080P	High definition TV 1080P

Return parameter Returns the video trigger type.

Example :TRIGger:VIDeo:TYPe NTSC
Sets the video trigger to NTSC.

Set →

→ Query

:TRIGger:VIDeo:FIELD

Description	Sets or queries the video trigger field.	
Syntax	:TRIGger:VIDeo:FIELD { FIELD1 FIELD2 ALLFields ALLLines ? }	
Related commands	:TRIGger:TYPe	
Parameter	FIELD1	Trigger on field 1
	FIELD2	Trigger on field 2
	ALLFields	Trigger on all fields

ALLLines Trigger on all lines

Return parameter Returns the video trigger field.

Example :TRIGger:VIDeo:FIEld ALLFields
Sets the video trigger to trigger on all fields.

:TRIGger:VIDeo:LIne

Set →

→ Query

Description Sets or queries the video trigger line.

Syntax :TRIGger:VIDeo:LIne {<NR1> | ?}

Related commands :TRIGger:TYPe

Parameter <NR1> Video line

Return parameter <NR3> Returns the video trigger line.

Example :TRIGger:VIDeo:LIne 1
Sets the video trigger to line 1.

Set →

→ Query

:TRIGger:VIDeo:POLarity

Description Sets or queries the video trigger polarity.

Syntax :TRIGger:VIDeo:POLarity { POSitive | NEGative | ? }

Related commands :TRIGger:TYPe

Parameter POSitive Positive polarity

NEGative Negative polarity

Return parameter Returns the video trigger polarity.

Example :TRIGger:VIDeo:POLarity POSitive
Sets the video trigger polarity to positive.

Set →

→ Query

:TRIGger:PULSe:WHEn

Description Sets or queries the pulse width trigger conditions.

Syntax	:TRIGger:PULSe:WHEn { MOREthan LESSthan EQual UNEQual ? }
Related commands	:TRIGger:TYPe :TRIGger:PULSe:TIME
Parameter	MORE than > LESSthan < EQual = UNEQual ≠
Return parameter	Returns the pulse width trigger conditions.

Example :TRIGger:PULSe:WHEn UNEQual
Sets the trigger pulse width conditions to not equal to (≠).

:TRIGger:PULSe:TIME



Description	Sets or queries the pulse width time.
Syntax	:TRIGger:PULSe:TIME {<NRf> ?}
Related commands	:TRIGger:TYPe :TRIGger:PULSe:WHEn
Parameter	<NRf> Pulse width time (4ns~10s)
Return parameter	<NR3> Returns the pulse width time in seconds.

Example :TRIGger:PULSe:TIME 4.00E-5
Sets the trigger pulse width to 40.0us.

:TRIGger:TIMEOut:WHEn



Description	Sets or queries the timeout trigger condition.
Syntax	:TRIGger:TIMEOut:WHEn {HIGH LOW EITHer ?}

Related commands	:TRIGger:TIMEOut:TIMER	
Parameter	HIGH	Signal is high.
	LOW	Signal is low.
	EITHer	Signal is high or low.
Return parameter	Returns the timeout condition (HIGH, LOW, EITHER).	
Example1	:TRIGger:TIMEOut:WHEn LOW Sets the timeout condition to low.	

:TRIGger:TIMEOut:TIMER

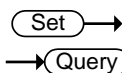

Description	Sets or returns timeout trigger time.	
Syntax	:TRIGger:TIMEOut:TIMER {<NRf> ? }	
Related commands	:TRIGger:TIMEOut:WHEn	
Parameter	<NRf>	Timeout time. (4nS to 10S).
Return parameter	Returns the timeout time as <NR3>.	
Example	:TRIGger:TIMEOut:TIMER? 8.960e-05	

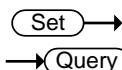

:TRIGger:ALTErnate

Description	Sets alternating between source triggers on or off or queries its state.	
Syntax	:TRIGger:ALTErnate {OFF ON ? }	
Parameter	OFF	Alternate off
	ON	Alternate on
Return parameter	Returns the Alternate trigger status (ON, OFF).	
Example	:TRIGger:ALTErnate ON Turns on alternating between source triggers.	

:TRIGger:STATe

→ Query

Description	Returns the current state of the triggering system.	
Syntax	:TRIGger:STATe?	
Return parameter	*ARMED	Indicates that the oscilloscope is acquiring pretrigger information.
	*AUTO	Indicates that the oscilloscope is in the automatic mode and acquires data even in the absence of a trigger.
	*READY	Indicates that all pretrigger information has been acquired and that the oscilloscope is ready to accept a trigger.
	*SAVE	Indicates that the oscilloscope is in save mode and is not acquiring data.
	*TRIGGER	Indicates that the oscilloscope triggered and is acquiring the post trigger information.

Example :TRIGger:STATe?
 AUTO
 The trigger is in auto mode.

Set →

:TRIGger:EXTERnal:PROBE:TYPE

→ Query

Description	Sets or queries the external probe type.	
Syntax	:TRIGger:EXTERnal:PROBE:TYPE { VOLTage CURRent ? }	
Related commands	:TRIGger:EXTERnal:PROBE:RATio	
Parameter	VOLTage	Voltage
	CURRent	Current

Return parameter Returns the probe type.

Example :TRIGger:EXTERnal:PROBe:TYPe?
CURRENT

:TRIGger:EXTERnal:PROBe:RATio

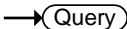

Description	Sets or queries the external probe ratio (attenuation).	
Syntax	:TRIGger:EXTERnal:PROBe:RATio {<NRf> ?}	
Related commands	:TRIGger:EXTERnal:PROBe:TYPE	
Parameter	<NRf>	External probe attenuation factor.
Return parameter	<NR3>	Returns the probe attenuation factor.
Example	:TRIGger:EXTERnal:PROBe:RATio? 5.000000e+01	

:TRIGger:BUS:TYPE 

Description	Returns the current bus type.	
Syntax	:TRIGger:BUS:TYPE?	
Return parameter	12C	I ² C mode
	SPI	SPI mode
	UART	UART mode
	CAN	CAN mode
	LIN	LIN mode
Example	:TRIGger:BUS:TYPE? UART	

:TRIGger:BUS:THReshold:CH<x>



Description	Sets or queries the threshold level for the selected channel.	
Syntax	:TRIGger:BUS:THReshold:CH<X> {<NR3> ?}	
	<X>	CH1 ~ CH4

	<NR3>	Threshold level
Return Parameter	<NR3>	Returns the threshold level

Example :TRIGger:BUS:THReshold:CH1 1
Sets the CH1 threshold to 1V.

:TRIGger:BUS:B1:I2C:CONDition



Description Sets or queries the I²C trigger conditions.

Syntax :TRIGger:BUS:B1:I2C:CONDition
{START | STOP | REPEATstart | ACKMISS | ADDRess | DATA | ADDRANDDATA | ? }

Parameter	START	Set Start as the I ² C trigger condition.
	STOP	Set Stop as the I ² C trigger condition.
	REPEATstart	Set Repeat of Start as the I ² C trigger condition.
	ACKMISS	Set Missing Acknowledgement as the I ² C trigger condition.
	ADDRess	Set Address as the I ² C trigger condition.
	DATA	Set Data as the I ² C trigger condition.
	ADDRANDDATA	Set Address and Data as the I ² C trigger condition.

Return parameter Returns the I²C bus trigger condition.

Example :TRIGger:BUS:B1:I2C:CONDition ADDRess
Set Address as the I2C trigger condition.

Set →
 → Query

:TRIGger:BUS:B1:I2C:ADDRess:MODE

Description	Sets or queries the I ² C addressing mode (7 or 10 bits).	
Syntax	:TRIGger:BUS:B1:I2C:ADDRess:MODE {ADDR7 ADDR10 ? }	
Related commands	:TRIGger:BUS:B1:I2C:CONDition	
Parameter	ADDR7	7 bit addressing
	ADDR10	10 bit addressing
Return Parameter	0	7 bit addressing
	1	10 bit addressing
Example	:TRIGger:BUS:B1:I2C:ADDRess:MODE? 0 The addressing mode is currenty set to 7 bits.	

Set →
 → Query

:TRIGger:BUS:B1:I2C:ADDRess:TYPE

Description	Sets the I ² C bus address type, or queries what the setting is.	
Syntax	:TRIGger:BUS:B1:I2C:ADDRess:TYPe {GENeralcall STARTbyte HSmode EEPROM CBUS ?}	
Related commands	:TRIGger:BUS:B1:I2C:CONDition	
Parameter	GENeralcall	Set a general call address (0000 000 0).
	STARTbyte	Set a start byte address. (0000 000 1)
	HSmode	Set a high-speed mode address. (0000 1xx x)
	EEPROM	Set an EEPROM address. (1010 xxx x)
	CBUS	Set a CBUS address. (0000 001 x)

Return Parameter Returns the address type

Example :TRIGger:BUS:B1:I2C:ADDRess:TYPE? CBUS

:TRIGger:BUS:B1:I2C:ADDRess:VALue  

Description Sets or queries the I²C bus address value when the I²C bus is set to trigger on Address or Address/Data.

Syntax :TRIGger:BUS:B1:I2C:ADDRess:VALue {<string> | ? }

Related commands :TRIGger:BUS:B1:I2C:ADDRess:MODE

Parameter	<sting>	7/10 characters, must be enclosed in double quotes, "string". x = don't care 1 = binary 1 0 = binary 0
-----------	---------	---

Return Parameter Returns the address value.

Example1 :TRIGger:BUS:B1:I2C:ADDRess:MODE ADDR7
:TRIGger:BUS:B1:I2C:ADDRess:VALue "xxx0101"
Sets the address to XXX0101

Example 2 :TRIGger:BUS:B1:I2C:ADDRess:VALue? XXX0101

:TRIGger:BUS:B1:I2C:ADDRess:DIRectioN  

Description Sets or queries the address bit as read write or don't care.

Note This setting only applies when the I²C trigger is set to trigger on Address or Address/Data

Syntax :TRIGger:BUS:B1:I2C:ADDRess:DIRectioN { READ | WRITE | NOCARE | ? }

Related commands	:TRIGger:BUS:B1:I2C:CONDition	
Parameter	READ	Set read as the data direction.
	WRITE	Set write as the data direction.
	NOCARE	Set either as the data direction.
Return Parameter	Returns the direction (READ, WRITE, NOCARE).	
Example	:TRIGger:BUS:B1:I2C:ADDRes:DIRection READ Sets the direction to READ.	

:TRIGger:BUS:B1:I2C:DATA:SIZE



Description	Sets or queries the data size in bytes for the I ² C bus.	
Note	This setting only applies when the I ² C trigger is set to trigger on Data or Address/Data	
Syntax	:TRIGger:BUS:B1:I2C:DATA:SIZE {<NR1> ? }	
Related commands	:TRIGger:BUS:B1:I2C:CONDition	
Parameter	<NR1>	Number of data bytes (1 to 5).
Return parameter	<NR1>	Returns the number of bytes.
Example	:TRIGger:BUS:B1:I2C:DATA:SIZE 3 Sets the number of bytes to 3.	

:TRIGger:BUS:B1:I2C:DATA:VALue



Description	Sets or queries the triggering data value for the I ² C bus when the I ² C bus is set to trigger on Data or Address/Data.	
Syntax	:TRIGger:BUS:B1:I2C:DATA:VALue {<string> ? }	
Related commands	:TRIGger:BUS:B1:I2C:DATA:SIZE	

Parameter	<string>	The number of characters in the string depends on the data size setting. The string must be enclosed in double quotes, "string". x = don't care 1 = binary 1 0 = binary 0
-----------	----------	--

Return Parameter Returns the data value.

Example1 :TRIGger:BUS:B1:I2C:DATA:SIZE 1
:TRIGger:BUS:B1:I2C:DATA:VALue "1x1x0101"
Sets the value to XXX0101

Example 2 :TRIGger:BUS:B1:I2C:DATA:VALue?
1X1X0101

:TRIGger:BUS:B1:UART:CONDition 

Description Sets or queries the UART triggering condition.

Syntax :TRIGger:BUS:B1:UART:CONDition { RXSTArt | RXDATA | RXENDPacket | TXSTArt | TXDATA | TXENDPacket | TXPARIttyerr | RXPARIttyerr | ? }

Parameter	RXSTArt	Set trigger on the RX Start Bit.
	RXDATA	Set trigger on RX Data.
	RXENDPacket	Set trigger on the RX End of Packet condition.
	RXPARIttyerr	Set trigger on RX Parity error condition.
	TXSTArt	Set trigger on the TX Start Bit.
	TXDATA	Set trigger on TX Data.
	TXENDPacket	Set trigger on the TX End of Packet condition.
	TXPARIttyerr	Set trigger on TX Parity error condition.

Return Parameter Returns the triggering condition.

Example :TRIGger:BUS:B1:UART:CONDition TXDATA
Sets the UART bus to trigger on Tx Data.

:TRIGger:BUS:B1:UART:RX:DATA:SIZE (Set) →
→ (Query)

Description Sets or queries the number of bytes for UART data.

Note This setting only applies when the UART trigger is set to trigger on Rx Data

Syntax :TRIGger:BUS:B1:UART:RX:DATA:SIZE {<NR1> | ?}

Related commands :TRIGger:BUS:B1:UART:CONDition

Parameter <NR1> Number of bytes (1 to 10).

Return parameter <NR1> Returns the number of bytes.

Example :TRIGger:BUS:B1:UART:RX:DATA:SIZE 5
Sets the number of bytes to 5.

:TRIGger:BUS:B1:UART:RX:DATA:VALue (Set) →
→ (Query)

Description Sets or queries the triggering data value for the UART bus when the bus is set to trigger on Rx Data.

Syntax :TRIGger:BUS:B1:UART:RX:DATA:VALue {<string> | ?}

Related commands :TRIGger:BUS:B1:UART:RX:DATA:SIZE

Parameter <sting> The number of characters in the string depends on the data size setting. The string must be enclosed in double quotes, "string".

x = don't care

1 = binary 1

0 = binary 0

Return Parameter Returns the data value.

Example1 :TRIGger:BUS:B1:UART:CONDition RXDATA
 :TRIGger:BUS:B1:UART:RX:DATA:SIZE 1
 :TRIGger:BUS:B1:UART:RX:DATA:VALue "1x1x0101"
 Sets the value to 1x1x0101

Example 2 :TRIGger:BUS:B1:UART:RX:DATA:VALue?
 1X1X0101

:TRIGger:BUS:B1:UART:TX:DATA:SIZE  

Description Sets or queries the number of bytes for UART data.

Note This setting only applies when the UART trigger is set to trigger on Tx Data

Syntax :TRIGger:BUS:B1:UART:TX:DATA:SIZE {<NR1> | ?}

Related commands :TRIGger:BUS:B1:UART:CONDition

Parameter <NR1> Number of bytes (1 to 10).

Return parameter <NR1> Returns the number of bytes.

Example :TRIGger:BUS:B1:UART:TX:DATA:SIZE 5
 Sets the number of bytes to 5.

:TRIGger:BUS:B1:UART:TX:DATA:VALue  

Description Sets or queries the triggering data value for the UART bus when the bus is set to trigger on Tx Data.

Syntax :TRIGger:BUS:B1:UART:TX:DATA:VALue {<string> | ?}

Related commands :TRIGger:BUS:B1:UART:TX:DATA:SIZE

Parameter	<sting>	The number of characters in the string depends on the data size setting. The string must be enclosed in double quotes, "string". x = don't care 1 = binary 1 0 = binary 0
-----------	---------	--

Return Parameter Returns the data value.

Example 1 :TRIGger:BUS:B1:UART:CONDition TXDATA
:TRIGger:BUS:B1:UART:TX:DATA:SIZE 1
:TRIGger:BUS:B1:UART:TX:DATA:VALue "1x1x0101"
Sets the value to 1x1x0101

Example 2 :TRIGger:BUS:B1:UART:TX:DATA:VALue?
1X1X0101

:TRIGger:BUS:B1:SPI:CONDition  

Description	Sets or queries the SPI triggering condition.	
Syntax	:TRIGger:BUS:B1:SPI:CONDition {SS MISO MOSI MISOMOSI ? }	
Parameter	SS	Set to trigger on the Slave Selection condition.
	MISO	Set to trigger on the Master-In Slave-Out condition.
	MOSI	Set to trigger on the Master-Out Slave-In condition.
	MISOMOSI	Set to trigger on the Master-In Slave-Out and Master-Out Slave-In conditions.

Return Parameter Returns the triggering condition.

Example :TRIGger:BUS:B1:SPI:CONDition MISO
Sets the SPI bus to trigger on MISO.

Set →
 → Query

:TRIGger:BUS:B1:SPI:DATa:SIZE

Description	Sets or queries the number of words for SPI data.	
Note	This setting only applies when the SPI trigger is set to trigger on MISO, MOSI or MISO/MOSI	
Syntax	:TRIGger:BUS:B1:SPI:DATa:SIZE {<NR1> ?}	
Related commands	:TRIGger:BUS:B1:SPI:CONDition	
Parameter	<NR1>	Number of words (1 to 32).
Return parameter	<NR1>	Returns the number of words.
Example	:TRIGger:BUS:B1:SPI:DATa:SIZE 10 Sets the number of words to 10.	

Set →
 → Query

:TRIGger:BUS:B1:SPI:DATa:MISO:VALue

Description	Sets or queries the triggering data value for the SPI bus when the bus is set to trigger on MISO or MISO/MOSI.	
Syntax	:TRIGger:BUS:B1:SPI:DATa:MISO:VALue {<string> ?}	
Related commands	:TRIGger:BUS:B1:SPI:DATa:SIZE	
Parameter	<sting>	The number of characters in the string depends on the data size setting. The string must be enclosed in double quotes, "string". x = don't care 1 = binary 1 0 = binary 0
Return Parameter	Returns the data value.	

Example1 :TRIGger:BUS:B1:SPI:CONDition MISO
 :TRIGger:BUS:B1:SPI:DATA:SIZE 2
 :TRIGger:BUS:B1:SPI:DATA:MISO:VALue "1x1x0101"
 Sets the value to 1x1x0101

Example 2 :TRIGger:BUS:B1:SPI:DATA:MISO:VALue?
 1X1X0101

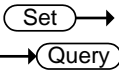
:TRIGger:BUS:B1:SPI:DATA:MOSI:VALue 

Description Sets or queries the triggering data value for the SPI bus when the bus is set to trigger on MOSI or MISO/MOSI.

Syntax :TRIGger:BUS:B1:SPI:DATA:MOSI:VALue {<string> | ? }

Related commands :TRIGger:BUS:B1:SPI:DATA:SIZE

Parameter	<sting>	The number of characters in the string depends on the data size setting. The string must be enclosed in double quotes, "string". x = don't care 1 = binary 1 0 = binary 0
------------------	---------	--

Return Parameter Returns the data value.

Example1 :TRIGger:BUS:B1:SPI:CONDition MOSI
 :TRIGger:BUS:B1:SPI:DATA:SIZE 2
 :TRIGger:BUS:B1:SPI:DATA:MOSI:VALue "1x1x0101"
 Sets the value to 1x1x0101

Example2 :TRIGger:BUS:B1:SPI:DATA:MOSI:VALue?
 1X1X0101

:TRIGger:BUS:B1:CAN:CONDition



Description	Sets or returns the CAN trigger condition.	
Syntax	:TRIGger:BUS:B1:CAN:CONDition {SOF FRAMeType IDentifier DATA IDANDDATA EOF ACKMISS STUFFERR ?}	
Parameter/ Return parameter	SOF	Triggers on a start of frame
	FRAMeType	Triggers on the type of frame
	IDentifier	Triggers on a matching identifier
	DATA	Triggers on matching data
	IDANDDATA	Triggers on matching identifier and data field
	EOF	Triggers on the end of frame
	ACKMISS	Triggers on a missing acknowledge
	STUFFERR	Triggers on a bit stuffing error

Example1 :TRIGger:BUS:B1:CAN:CONDition SOF
Triggers on a start of frame.

Example2 :TRIGger:BUS:B1:CAN:CONDition?
>SOF

:TRIGger:BUS:B1:CAN:FRAMeType



Description	Sets or returns the frame type for a CAN FRAMeType trigger.	
Syntax	:TRIGger:BUS:B1:CAN:FRAMeType {DATA REMOte ERRor OVERLoad ?}	
Parameter/ Return parameter	DATA	Sets the frame type to data frame
	REMOte	Sets the frame type to remote frame
	ERRor	Sets the frame type to error frame
	OVERLoad	Sets the frame type to overload

Example :TRIGger:BUS:B1:CAN:FRAMeType DATA
Sets the frame type to DATA.

:TRIGger:BUS:B1:CAN:IDentifier:MODE (Set) →
→ (Query)

Description Sets or returns the CAN identifier mode for the bus.

Syntax :TRIGger:BUS:B1:CAN:IDentifier:MODE {STANDard|EXTended|?}

Parameter/ Return parameter	STANDard	Standard addressing mode
	EXTended	Extended addressing mode

Example :TRIGger:BUS:B1:CAN:IDentifier:MODE?>STANDARD
Returns the addressing mode.

:TRIGger:BUS:B1:CAN:IDentifier:VALue (Set) →
→ (Query)

Description Sets or returns the identifier string used for the CAN trigger.

Note: Only applicable when the trigger condition is set to ID or IDANDDATA.

Syntax :TRIGger:BUS:B1:CAN:IDentifier:VALue {<string>|?}

Related Commands :TRIGger:BUS:B1:CAN:IDentifier:MODE

Parameter/ Return parameter	<string>	<p>The size of the string depends on the data size setting. The string must be enclosed in double quotes, "string".</p> <p>String contents:</p> <p>x = don't care</p> <p>1 = binary 1</p> <p>0 = binary 0</p>
--------------------------------	----------	---

```
Example      :TRIGger:BUS:B1:CAN:CONDition ID
              :TRIGger:BUS:B1:CAN:IDentifier:MODE STANDARD
              :TRIGger:BUS:B1:CAN:IDentifier:VALue
              "01100X1X01X"
              :TRIGger:BUS:B1:CAN:IDentifier:VALue?
              >01100X1X01X
```

(Set) →

```
:TRIGger:BUS:B1:CAN:IDentifier:DIRection → (Query)
```

Description Sets or queries the address bit as read, write or don't care.

Syntax :TRIGger:BUS:B1:CAN:IDentifier:DIRection
{READ|WRITE|NOCARE|?}

Parameter/ Return parameter	READ	Sets read as the data direction
	WRITE	Sets write as the data direction
	NOCARE	Sets either as the data direction

Example1 :TRIGger:BUS:B1:CAN:IDentifier:DIRection?
>WRITE

Example2 :TRIGger:BUS:B1:CAN:IDentifier:DIRection READ
:TRIGger:BUS:B1:CAN:IDentifier:DIRection?
> READ

(Set) →

```
:TRIGger:BUS:B1:CAN:DATA:QUALifier → (Query)
```

Description Sets or returns the CAN data qualifier.
Note: Only applicable when the triggering condition is set to DATA or IDANDDATA.

Syntax :TRIGger:BUS:B1:CAN:DATA:QUALifier
{LESSthan|MOREthan|EQUAL|UNEQUAL|LESSEQUAL|M
OREEQUAL|?}

Parameter/ Return parameter	LESSthan	Triggers when the data is less than the qualifier value.
--	----------	--

MOREthan	Triggers when the data is greater than the qualifier value.
EQual	Triggers when the data is equal to the qualifier value.
UNEQual	Triggers when the data is not equal to the qualifier value.
LESSEQual	Triggers when the data is less than or equal to the qualifier value.
MOREEQual	Triggers when the data is more than or equal to the qualifier value.

Example :TRIGger:BUS:B1:CAN:DATA:QUALifier?
>EQUAL
:TRIGger:BUS:B1:CAN:DATA:QUALifier MOREthan
:TRIGger:BUS:B1:CAN:DATA:QUALifier?
>MOREthan

Set →

:TRIGger:BUS:B1:CAN:DATA:SIZE

← Query

Description Sets or returns the length of the data string in bytes for a CAN trigger.
Note: Only applicable when the condition is set to DATA or IDANDDATA.

Syntax :TRIGger:BUS:B1:CAN:DATA:SIZE {<NR1>|?}

Parameter/ Return parameter <NR1> 1~8 (bytes)

Example :TRIGger:BUS:B1:CAN:DATA:SIZE?
>1
:TRIGger:BUS:B1:CAN:DATA:SIZE 2
:TRIGger:BUS:B1:CAN:DATA:SIZE?
>2

		Set →
		→ Query
:TRIGger:BUS:B1:CAN:DATA:VALue		
Description	Sets or returns the binary data string to be used for a CAN trigger. Note: Only applicable when the condition is set to DATA or IDANDDATA.	
Related Commands	:TRIGger:BUS:B1:CAN:DATA:SIZE	
Syntax	:TRIGger:BUS:B1:CAN:DATA:VALue {<string> ?}	
Parameter/ Return parameter	<string>	The size of the string depends on the data size setting. The string must be enclosed in double quotes, "string". String contents: x = don't care 1 = binary 1 0 = binary 0
Example	:TRIGger:BUS:B1:CAN:DATA:SIZE 1 :TRIGger:BUS:B1:CAN:DATA:VALue "01010X1X" :TRIGger:BUS:B1:CAN:DATA:VALue? >01010X1X	

		Set →
		→ Query
:TRIGger:BUS:B1:LIN:CONDition		
Description	Sets or returns the LIN trigger condition.	
Syntax	:TRIGger:BUS:B1:LIN:CONDition {SYNCField IDentifier DATA IDANDDATA WAKEup SLEEP ERRor ?}	
Parameter/ Return parameter	SYNCField	Sets the LIN trigger condition to the sync field.
	IDentifier	Sets the LIN trigger condition to identifier field.

DATA	Sets the LIN trigger condition to the data field.
IDANDDATA	Sets the LIN trigger condition to identifier and data field
WAKEup	Sets the LIN trigger condition to wake up.
SLEEP	Sets the LIN trigger condition to sleep.
ERRor	Sets the LIN trigger condition to error.

Example

```
:TRIGger:BUS:B1:LIN:CONDition?
>IDANDDATA

:TRIGger:BUS:B1:LIN:CONDition DATA
:TRIGger:BUS:B1:LIN:CONDition?
>DATA
```

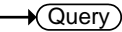
:TRIGger:BUS:B1:LIN:DATA:QUALifier  

Description Sets or returns the LIN data qualifier.
 Note: Only applicable when the trigger condition is set to DATA or IDANDDATA.

Syntax :TRIGger:BUS:B1:LIN:DATA:QUALifier
 {LESSthan|MOREthan|EQUAL|UNEQUAL|LESSEQUAL|MOREEQUAL|?}

Parameter/ Return parameter	LESSthan	Triggers when the data is less than the qualifier value.
	MOREthan	Triggers when the data is greater than the qualifier value.
	EQUAL	Triggers when the data is equal to the qualifier value.
	UNEQUAL	Triggers when the data is not equal to the qualifier value.
	LESSEQUAL	Triggers when the data is less than or equal to the qualifier value.

MOREEqual Triggers when the data is more than or equal to the qualifier value.

Example :TRIGger:BUS:B1:LIN:DATA:QUALifier?
 >EQUAL
 :TRIGger:BUS:B1:LIN:DATA:QUALifier MOREthan
 :TRIGger:BUS:B1:LIN:DATA:QUALifier?
 >MORETHAN

Set →
 → Query

:TRIGger:BUS:B1:LIN:DATA:SIZE

Description Sets or returns the length of the data string in bytes for the LIN trigger.
 Note: Only applicable when the condition is set to DATA or IDANDDATA.

Syntax :TRIGger:BUS:B1:LIN:DATA:SIZE {<NR1>|?}

Parameter/Return parameter **<NR1>** 1~8 (bytes)

Example :TRIGger:BUS:B1:LIN:DATA:SIZE?
 >1
 :TRIGger:BUS:B1:LIN:DATA:SIZE 2
 :TRIGger:BUS:B1:LIN:DATA:SIZE?
 >2

Set →
 → Query

:TRIGger:BUS:B1:LIN:DATA:VALue

Description Sets or returns the binary data string to be used for the LIN trigger.
 Note: Only applicable when the condition is set to DATA or IDANDDATA.

Related Commands :TRIGger:BUS:B1:LIN:DATA:SIZE

Syntax :TRIGger:BUS:B1:LIN:DATA:VALue {<string>|?}

Parameter/ Return parameter	<string>	The size of the string depends on the data size setting. The string must be enclosed in double quotes, "string". String contents: x = don't care 1 = binary 1 0 = binary 0
--------------------------------	----------	--

Example :TRIGger:BUS:B1:LIN:DATA:SIZE 1
 :TRIGger:BUS:B1:LIN:DATA:VALue "01010X1X"
 :TRIGger:BUS:B1:LIN:DATA:VALue?
 >01010X1X

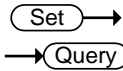

:TRIGger:BUS:B1:LIN:ERRTYPE

Description Sets or returns the error type be used for the LIN trigger.

Syntax :TRIGger:BUS:B1:LIN:ERRTYPE
 {SYNC|PARity|CHECKsum|?}

Parameter/ Return parameter	SYNC	Sets the LIN error type to SYNC.
	PARity	Sets the LIN error type to parity.
	CHECKsum	Sets the LIN error type to checksum.

Example :TRIGger:BUS:B1:LIN:ERRTYPE?
 >SYNC
 :TRIGger:BUS:B1:LIN:ERRTYPE CHECKSUM
 :TRIGger:BUS:B1:LIN:ERRTYPE?
 >CHECKSUM

Set →
→ Query

:TRIGger:BUS:B1:LIN:IDentifier:VALue

Description	Sets or returns the identifier string to be used for the LIN trigger.	
	Note: Only applicable when the condition is set to ID or IDANDDATA.	
Syntax	:TRIGger:BUS:B1:LIN:IDentifier:VALue {<string> ?}	
Parameter/ Return parameter	<string>	The size of the string depends on the data size setting. The string must be enclosed in double quotes, "string". String contents: x = don't care 1 = binary 1 0 = binary 0
Example	:TRIGger:BUS:B1:LIN:CONDition ID :TRIGger:BUS:B1:LIN:IDentifier:VALue "00X1X01X" :TRIGger:BUS:B1:LIN:IDentifier:VALue? >01100X1X01X :TRIGger:LOGic:INPut:CLOCK:SOURce	

Set →
→ Query

:TRIGger:LOGic:INPut:CLOCK:SOURce

Description	Sets or returns which digital channel is used as the clock source for the logic trigger. If none are selected, a pattern trigger will have to be used.	
Syntax	:TRIGger:LOGic:INPut:CLOCK:SOURce {NONE D0 D1 D2 D3 D4 D5 D6 D7 D8 D9 D10 D11 D12 D13 D14 D15 ?}	
Parameter/ Return parameter	None	No clock source selected. A pattern trigger will have to be set.
	D0–D15	Sets one of the digital channels as the clock source.

Example :TRIG:LOG:INP:CLOCK:SOUR D0
 :TRIG:LOG:INP:CLOCK:SOUR?
 >D0

:TRIGger:LOGic:INPut:CLOCK:EDGe Set →

Description Sets the polarity of the clock source.

Syntax :TRIGger:LOGic:INPut:CLOCK:EDGe {RISe | FALL | EITher}

Related Commands :TRIGger:LOGic:INPut:CLOCK:SOURce

Parameter	RISe	Sets the clock source on the rising edge.
	FALL	Sets the clock source on the falling edge.
	EITher	Sets the clock source to either rising or falling edge.

Example :TRIG:LOG:INP:CLOCK:EDG RIS

:TRIGger:LOGic:FUNCTion Set →
 → Query

Description Sets or queries the logical combination of the digital channels for the logic trigger.

Syntax :TRIGger:LOGic:FUNCTion{AND | NAND | NOR | OR | ?}

Related Commands :TRIGger:LOGic:PATtern:INPut:D<x>

Parameter/ Return parameter	AND	Sets the logic combination to AND.
	NAND	Sets the logic combination to NAND.
	NOR	Sets the logic combination to NOR.
	OR	Sets the logic combination to OR.

Example :TRIGger:LOGic:FUNcTION?
 >AND
 :TRIGger:LOGic:FUNcTION NAND
 Sets the logic combination of the digital channels to NAND.

:TRIGger:LOGic:PATtern → Query

Description Queries the conditions used for generating a logic pattern trigger in terms of input pattern, pattern trigger time and conditions.

Syntax :TRIGger:LOGic:PATtern?

Example :TIGger:LOGic:PATtern?
 >:TRIGGER:LOGIC:PATTERN:INPUT:D0 HIGH; D1 X;
 D2 X; D3 X; D4 X; D5 X; D6 X; D7 X; D8 X; D9 X; D10
 X; D11 X; D12 X; D13 X; D14 X; D15 X;
 :TRIGGER:LOGIC:PATTERN:WHEN TRUE;
 :TRIGGER:LOGIC:PATTERN:DELTATIME 1.000e-08;

:TRIGger:LOGic:PATtern:INPut:D<x> Set →
→ Query

Description Sets or returns the logic level for the selected digital channel.

Syntax :TRIGger:LOGic:PATtern:INPut:D<x> {HIGH | LOW | X | ?}

Related Commands :TRIGger:LOGic:FUNcTION

Parameter/ Return parameter	<x>	Digital channel number 0~15.
	HIGH	Sets to logical high state.
	LOW	Sets to logical low state.
	X	Sets to "don't care" state.

Example :TRIGger:LOGic:PATtern:INPut:D0?
 >HIGH

Set →
 → Query

:TRIGger:LOGic:PATtern:DELTatime

Description	Sets or returns the pattern trigger delta time value.	
Syntax	:TRIGger:LOGic:PATtern:DELTatime {<NR3> ?}	
Related Commands	:TRIGger:LOGic:PATtern:WHEn	
Parameter/ Return parameter	<NR3>	Pattern trigger time value in seconds 1e-9 (1 ns) to 10.0e0 (10 s).
Example	:TRIG:LOG:PAT:DELT 8.960e-05 :TRIG:LOG:PAT:DELT? >8.960e-05	

Set →
 → Query

:TRIGger:LOGic:PATtern:WHEn

Description	Sets or returns the pattern logic condition on which to trigger the oscilloscope.	
Syntax	:TRIGger:LOGic:PATtern:WHEn {TRUE FALSE LESSthan MOREthan EQUAL UNEQual ?}	
Related Commands	:TRIGger:LOGic:PATtern:DELTatime	
Parameter/ Return parameter	TRUE	Triggers when the defined input pattern is met.
	FALSE	Triggers when the defined input pattern is not met.
	LESSthan	Triggers when the defined input pattern is met during a time lower than the defined delta time.
	MOREthan	Triggers when the defined input pattern is met during a time greater than the defined delta time.

EQUAL	Triggers when the defined input pattern is met during a time equal to the defined delta time.
UNEQUAL	Triggers when the defined input pattern is met during a time other than the defined delta time.

Example :TRIG:LOG:PAT:DELT FALSE
 :TRIG:LOG:PAT:DELT?
 >FALSE

System Commands

:SYSTem:LOCK	164
:SYSTem:ERRor	164

:SYSTem:LOCK

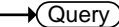

Description	Turns the panel lock on off.	
Syntax	:SYSTem:LOCK {OFF ON ? }	
Parameter	OFF	System lock off
	ON	System lock on
Return parameter	Returns the status of the panel lock (ON, OFF).	
Example	:SYSTem:LOCK ON Turns the panel lock on.	

:SYSTem:ERRor



Description	Queries the error queue. See the appendix on page 301 for details.	
Syntax	:SYSTem:ERRor?	
Return parameter	Returns the last message in the error queue.	
Example	:SYSTem:ERRor? +0, "No error."	

Save/Recall Commands

:RECALL:SETUp	165
:RECALL:WAVEform	165
:SAVe:IMAGe	166
:SAVe:IMAGe:FILEFormat	166
:SAVe:IMAGe:INKSaver	167
:SAVe:SETUp	167
:SAVe:WAVEform	168
:SAVe:WAVEform:FILEFormat	169

:RECALL:SETUp

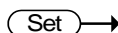

Description	Recalls setup settings from memory or USB.	
Syntax	:RECALL:SETUp {S1~S20 <file path>("Disk:/xxx.SET", "USB:/xxx.SET")}	
Parameter	S1~S20	Recall Set1~Set20
	<file path>	Recall a file from the DSO internal files system or from a USB flash drive.
Example	:RECALL:SETUp S1 Recalls setup setting S1 from memory. :RECALL:SETUp "Disk:/DS0001.SET" Recall the setup setting DS0001.SET from the internal memory.	

:RECALL:WAVEform



Description	Recalls a waveform from wave1~wave20 or from file to REF1~4.
Note	Detail CSV files cannot be recalled.
Syntax	:RECALL:WAVEform {W<n> <file path> ("Disk:/xxx.LSF", "USB:/xxx.LSF")}, REF<X>

Parameter	n	1~20 (Wave1~wave20)
	<file page>	Filename in file path. Example: “Disk:/xxx.LSF”, “USB:/xxx.LSF”, “Disk:/xxx.CSV”, “USB:/xxx.CSV”
	<X>	1,2,3,4 (REF1, REF2, REF3, REF4)

Example :RECALL:WAVEform W1, REF1
 Recalls the waveform stored in Wave1 to reference 1.

:SAVE:IMAGe



Description	Saves a screen image to the assigned file path with a specified filename.	
Syntax	:SAVE:IMAGe {<file path> (“Disk:/xxx.PNG”, “USB:/xxx.BMP”)}	
Related commands	:SAVE:IMAGe:FILEFormat :SAVE:IMAGe:INKSaver	
Parameter	xxx.PNG or xxx.BMP	File name (8 characters max)

Example :SAVE:IMAGe “Disk:/pic1.PNG”
 Saves a screen image named pic1.png to the root directory (Disk:/) of the scope.
 :SAVE:IMAGe “USB:/pic1.BMP”
 Saves a screen image named pic1.bmp to the root directory of the external USB flash disk.

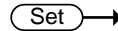

:SAVE:IMAGe:FILEFormat



Description	Sets the file format for image.	
Syntax	:SAVE:IMAGe:FILEFormat {PNG BMP ?}	
Related commands	:SAVE:IMAGe :SAVE:IMAGe:INKSaver	

Parameter	PNG	Sets the file format to PNG
	BMP	Sets the file format to BMP

Return parameter Returns the file format (PNG, BMP).

Example :SAVE:IMAGE:FILEFormat PNG
Sets the image file format to PNG.

:SAVe:IMAGe:INKSaver

Set →

→ Query

Description	Turns Ink Saver on or off.	
Syntax	:SAVe:IMAGe:INKSaver {OFF ON ?}	
Related commands	:SAVe:IMAGe :SAVe:IMAGe:FILEFormat	

Parameter	OFF	Turns Inksaver off.
	ON	Turns Inksaver on.

Return parameter Returns Ink Saver status (ON, OFF).

Example :SAVe:IMAGe:INKSaver ON
Turns Ink Saver on.

:SAVe:SETUp

Set →

Description	Saves the current setup to internal memory (Set1~Set20) or the designated file path.	
Syntax	:SAVe:SETUp {<file path> ("Disk:/xxx.SET", "USB:/xxx.SET) S1~S20}	
Parameter	S1~S20	Saves the setup to Set1~Set20
	File path	Saves the setup to disk to the specified file path.

Example :SAVE:SETUp S1
 Saves the current setup to Set1 in internal memory.
 :SAVE:SETUp "Disk:/DS0001.SET"
 Saves the current setup to DS0001.SET in the root directory of the internal memory.

:SAVE:WAVEform



Description	Saves a waveform to internal memory or to a designated file path.	
Related commands	:SAVE:WAVEform:FILEFormat	
Syntax	:SAVE:WAVEform {CH1~REF4, REF<X> } {CH1~REF4, W1~W20} {CH1~ALL, file path}	
Parameter	CH1~REF4, <X> W1~W20 ALL File path	CH1~CH4, Math, D0~D15, REF1~4 1,2,3,4 (REF1, REF2, REF3, REF4) Wave1~Wave20 All the displayed waveforms on screen. Saves the waveform(s) to disk or USB to the specified file path. (LSF or CSV, but note that detail CSV can't be recalled to the scope.)
Example 1	:SAVE:WAVEform CH1, REF2 Saves the channel1 waveform to REF2.	
Example 2	:SAVE:WAVEform:FILEFormat LSF :SAVE:WAVEform ALL, "Disk:/ALL001" Sets the file format to LSF. A folder named "ALL001" is created and saves all displayed waveforms to the "ALL001" directory in the LSF format.	

Example 3 :SAVe:WAVEform:FILEFormat FCSV
 :SAVe:WAVEform ALL, "Disk:/ALL002"
 Sets the file format to FCSV (fast CSV format). It then saves the all channel's waveforms to the root directory (Disk:/) of the internal flash disk in the CSV format (with the filename ALL002.CSV).

Example 4 :SAVe:WAVEform:FILEFormat LSF
 :SAVe:WAVEform CH2, "Disk:/DS0003.LSF"
 Save the channel 2's waveform to the root directory (Disk:/) of the internal flash disk in the LSF format with DS0003.LSF as the filename.

:SAVe:WAVEform:FILEFormat



Description	Sets the waveform savefile format.	
Syntax	:SAVe:WAVEform:FILEFormat {LSF DCSV FCSV ?}	
Parameter	LSF	Sets the file format to the MDO-2000E/2000EX's internal file format, LSF. (xxx.LSF) (no support LA)
	DCSV	Sets the file format to detail CSV. (xxx.CSV)
	FCSV	Sets the file format to fast CSV. (xxx.CSV)

Return parameter Returns the file format (LSF , DCSV, FCSV).

Example :SAVe:WAVEform:FILEFormat LSF
 Sets the file format to LSF.

Ethernet Command

:ETHERnet:DHCP Set →
→ Query

Description	Sets or queries the DHCP settings.	
Syntax	:ETHERnet:DHCP { OFF ON ? }	
Parameter	ON	Turns DHCP on.
	OFF	Turns DHCP off.
Example	:ETHERnet:DHCP ON Turns DHCP on.	

Time Command

:DATE Set →

Description	Sets the system date and time.	
Syntax	:DATE {<string>}	
Parameter	<string>	“YYYYMMDDhhmmss” Where: YYYY: year MM: month DD: day hh: hour mm: minute ss: second
Example	:DATE “20140802142830” Sets the time and date as: Year: 2014, Month: 08, Day: 02, Hour: 14 (2PM), Minute: 28, Second: 30.	

Bus Decode Commands

:BUS1	172
:BUS1:STATE	172
:BUS1:TYPe	172
:BUS1:INPut.....	173
:BUS1:I2C:ADDRes:RWINClude.....	173
:BUS1:I2C:SCLK:SOURce	174
:BUS1:I2C:SDA:SOURce.....	174
:BUS1:UART:BITRate.....	174
:BUS1:UART:DATABits	175
:BUS1:UART:PARItY.....	175
:BUS1:UART:PACKEt	175
:BUS1:UART:EOFPacket	176
:BUS1:UART:TX:SOURce	176
:BUS1:UART:RX:SOURce	177
:BUS1:SPI:SCLK:POLARity	177
:BUS1:SPI:SS:POLARity.....	177
:BUS1:SPI:WORDSize	178
:BUS1:SPI:BITORder	178
:BUS1:SPI:SCLK:SOURce	178
:BUS1:SPI:SS:SOURce.....	179
:BUS1:SPI:MOSI:SOURce	179
:BUS1:SPI:MISO:SOURce	179
:BUS1:DISPlay:FORMAt	180
:LISTer:DATA	180
:BUS1:CAN:SOURce.....	181
:BUS1:CAN:PROBe.....	181
:BUS1:CAN:SAMPLEpoint.....	181
:BUS1:CAN:BITRate.....	182
:BUS1:LIN:BITRate	183
:BUS1:LIN:IDFORmat	183
:BUS1:LIN:POLARity.....	183
:BUS1:LIN:SAMPLEpoint	184

:BUS1:LIN:SOURce184
 :BUS1:LIN:STANDard184

:BUS1 → Query

Description	Returns the supported BUS types.
Syntax	:BUS1?
Return Parameter	Returns the supported bus types.
Example	BUS1? I2C,SPI,UART,CAN,LIN

Set →
→ Query

:BUS1:STATE

Description	Sets or queries the state of the bus.	
Syntax	:BUS1:STATE { OFF ON ? }	
Related commands	:BUS1:TYPE	
Parameter/Return parameter	OFF	Turns the bus off.
	ON	Turns the bus on.
Example	:BUS1:STATE ON Turns the bus on.	

Set →
→ Query

:BUS1:TYPE

Description	Sets or queries the type of bus.	
Syntax	:BUS1:TYPE { UART I2C SPI PARAllel CAN LIN ? }	
Related commands	:BUS1:STATE	
Parameter/Return parameter	UART	Sets the bus to UART mode.
	I2C	Sets the bus to I ² C mode.

SPI	Sets the bus to SPI mode.
PARAllel	Sets the bus to parallel mode.
CAN	Sets the bus to CAN mode.
LIN	Sets the bus to LIN mode.

Example :BUS1:TYPe SPI
Sets the bus to SPI mode.

:BUS1:INPut

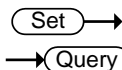

Description	Sets or returns the bus source.	
Syntax	:BUS1:INPut {ANALog DIGital ?}	
Parameter/Return parameter	ANALog	Sets the bus source as analog inputs.
	DIGital	Sets the bus source as digital inputs.

Example1 :BUS1:INPut?
>ANALOG

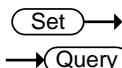

:BUS1:I2C:ADDRes:RWINClude

Description	Sets or queries whether the read/write bit is included in the I ² C address.	
Syntax	:BUS1:I2C:ADDRes:RWINClude { OFF ON ? }	
Related commands	:BUS1:STATE	
Parameter	OFF	The R/W bit is not included.
	ON	The R/W bit is included.
Return parameter	0	The R/W bit is not included.
	1	The R/W bit is included.

Example :BUS1:I2C:ADDRes:RWINClude ON
Includes the R/W bit in the I²C address.

:BUS1:I2C:SCLK:SOURce (Set) →
→ (Query)

Description	Sets or queries which channel is used for the I ² C SCLK source.
Syntax	:BUS1:I2C:SCLK:SOURce { CH1 CH2 CH3 CH4 D0 D1 D2 D3 D4 D5 D6 D7 D8 D9 D10 D11 D12 D13 D14 D15 ? }
Parameter/Return parameter	CH1 to CH4 Analog channels 1 ~ 4. D0 to D15 Digital channels D0~D15
Example	:BUS1:I2C:SCLK:SOURce CH1 Sets channel 1 as the SCLK source.

:BUS1:I2C:SDA:SOURce (Set) →
→ (Query)

Description	Sets or queries which channel is used for the I ² C SDA source.
Syntax	:BUS1:I2C:SDA:SOURce { CH1 CH2 CH3 CH4 D0 D1 D2 D3 D4 D5 D6 D7 D8 D9 D10 D11 D12 D13 D14 D15 ? }
Parameter/Return parameter	CH1 to CH4 Analog channels 1 ~ 4. D0 to D15 Digital channels D0~D15
Example	:BUS1:I2C:SDA:SOURce CH1 Sets channel 1 as the SDA source.

:BUS1:UART:BITRate (Set) →
→ (Query)

Description	Sets or queries the UART bit rate.
Syntax	:BUS1:UART:BITRate { <NR1> ? }
Parameter/Return parameter	<NR1> UART bit rate in bps

Example :BUS1:UART:BITRate?
>2400
:BUS1:UART:BITRate 50
:BUS1:UART:BITRate?
>50

:BUS1:UART:DATABits

Set →

← Query

Description Sets or queries the number UART data for bus 1.

Syntax :BUS1:UART:DATABits { 5 | 6 | 7 | 8 | 9 | ? }

Parameter/Return parameter	5	5 data bits in the UART frame.
	6	6 data bits in the UART frame.
	7	7 data bits in the UART frame.
	8	8 data bits in the UART frame.

Example :BUS1:UART:DATABits 7
Sets the UART frame to 7 bits.

Set →

← Query

:BUS1:UART:PARITY

Description Sets or queries the UART bus parity.

Syntax :BUS1:UART:PARITY { <NR1> | ? }

Parameter/Return parameter	<NR1>	0: None
		1: Odd parity
		2: Even parity

Example :BUS1:UART:PARITY 1
Sets the parity to odd.

Set →

← Query

:BUS1:UART:PACKET

Description Sets or queries the UART packet setting.

Syntax :BUS1:UART:PACKET {<NR1> | ? }

Parameter/Return parameter	<NR1>	0: Off 1: On
----------------------------	-------	-----------------

Example :BUS1:UART:PACKet 1
Turns UART packets on.

Set →

:BUS1:UART:EOFPacket

→ Query

Description	Sets or queries the EOF character for the UART packet setting.
-------------	--

Syntax	:BUS1:UART:EOFPacket <NR1>
--------	----------------------------

Parameter/Return parameter	<NR1>	0: NULL 1: LF (line feed) 2: CR (carriage return) 3: SP (space character) 4: FF
----------------------------	-------	---

Example :BUS1:UART:EOFPacket 2
Sets the OEF character to CR.

Set →

:BUS1:UART:TX:SOURce

→ Query

Description	Sets or queries which channel is used for the UART Tx source.
-------------	---

Syntax	:BUS1:UART:TX:SOURce { OFF CH1 CH2 CH3 CH4 D0 D1 D2 D3 D4 D5 D6 D7 D8 D9 D10 D11 D12 D13 D14 D15 ? }
--------	--

Parameter/Return parameter	OFF	Off, no Tx source
	CH1 to CH4	Analog channels CH1 to CH4
	D0 to D15	Digital channels D0 to D15

Example :BUS1:UART:TX:SOURce CH1
Sets channel 1 as the Tx source.

Set →
→ Query

:BUS1:UART:RX:SOURce

Description	Sets or queries which channel is used for the UART Rx source.	
Syntax	:BUS1:UART:RX:SOURce { OFF CH1 CH2 CH3 CH4 D0 D1 D2 D3 D4 D5 D6 D7 D8 D9 D10 D11 D12 D13 D14 D15 ? }	
Parameter/Return parameter	OFF	Off, no Rx source
	CH1 to CH4	Analog channels CH1 to CH4
	D0 to D15	Digital channels D0 to D15
Example	:BUS1:UART:RX:SOURce CH1 Sets channel 1 as the Rx source.	

Set →
→ Query

:BUS1:SPI:SCLK:POLARity

Description	Sets or queries the polarity of the SCLK line for the SPI bus.	
Syntax	:BUS1:SPI:SCLK:POLARity { FALL RISE ? }	
Parameter/Return parameter	FALL	Sets the polarity to falling edge.
	RISE	Sets the polarity to rising edge.
Example	:BUS1:SPI:SCLK:POLARity FALL Sets the polarity to falling edge.	

Set →
→ Query

:BUS1:SPI:SS:POLARity

Description	Sets or queries the polarity of the SS line for the SPI bus.	
Syntax	:BUS1:SPI:SS:POLARity { LOW HIGH ? }	
Parameter/Return parameter	LOW	Active low polarity
	HIGH	Active high polarity

Example :BUS1:SPI:SS:POLARity LOW
Sets the SS line to active low.

Set →

:BUS1:SPI:WORDSize

→ Query

Description Sets the number of bits per word for the SPI bus.

Syntax :BUS1:SPI:WORDSize {<NR1> | ? }

Parameter/Return parameter <NR1> Bits per word (4–32)

Example :BUS1:SPI:WORDSize 4
Sets the word size to 4 bits per word.

Set →

:BUS1:SPI:BITORder

→ Query

Description Sets or queries the bit order for the SPI bus.

Syntax :BUS1:SPI:BITORder {<NR1> | ? }

Parameter/Return parameter <NR1> 0: MSB bit first
1: LSB bit first

Example :BUS1:SPI:BITORder?
0
The bit order is currently set as MSB bit first.

Set →

:BUS1:SPI:SCLK:SOURce

→ Query

Description Sets or queries which channel is used for the SPI SCLK source.

Syntax :BUS1:SPI:SCLK:SOURce { CH1 | CH2 | CH3 | CH4 | D0 | D1 | D2 | D3 | D4 | D5 | D6 | D7 | D8 | D9 | D10 | D11 | D12 | D13 | D14 | D15 | ? }

Parameter/Return parameter CH1 to CH4 Analog channels CH1 to CH4
D0 to D15 Digital channels D0 to D15

Example :BUS1:SPI:SCLK:SOURce CH1
Sets channel 1 as the SPI SCLK source.

:BUS1:SPI:SS:SOURce  

Description Sets or queries which channel is used for the SPI SS source.

Syntax :BUS1:SPI:SS:SOURce { CH1 | CH2 | CH3 | CH4 | D0 | D1 | D2 | D3 | D4 | D5 | D6 | D7 | D8 | D9 | D10 | D11 | D12 | D13 | D14 | D15 | ? }

Parameter/Return parameter CH1 to CH4 Analog channels CH1 to CH4
D0 to D15 Digital channels D0 to D15

Example :BUS1:SPI:SS:SOURce CH1
Sets channel 1 as the SPI SS source.

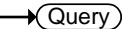
:BUS1:SPI:MOSI:SOURce  

Description Sets or queries which channel is used for the SPI MOSI source.

Syntax :BUS1:SPI:MOSI:SOURce { OFF | CH1 | CH2 | CH3 | CH4 | D0 | D1 | D2 | D3 | D4 | D5 | D6 | D7 | D8 | D9 | D10 | D11 | D12 | D13 | D14 | D15 | ? }

Parameter/Return parameter CH1 to CH4 Analog channels CH1 to CH4
D0 to D15 Digital channels D0 to D15
OFF No MOSI source.

Example :BUS1:SPI:MOSI:SOURce CH1
Sets channel 1 as the SPI MOSI source.

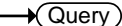
:BUS1:SPI:MISO:SOURce  

Description Sets or queries which channel is used for the SPI MISO source.

Syntax :BUS1:SPI:MISO:SOURce { OFF | CH1 | CH2 | CH3 | CH4 | D0 | D1 | D2 | D3 | D4 | D5 | D6 | D7 | D8 | D9 | D10 | D11 | D12 | D13 | D14 | D15 | ? }

Parameter/Return parameter	CH1 to CH4	Analog channels CH1 to CH4
	D0 to D15	Digital channels D0 to D15
	OFF	No MISO source.

Example :BUS1:SPI:MISO:SOURce CH1
Sets channel CH1 as the SPI MISO source.

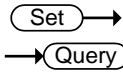

:BUS1:DISplay:FORMAT

Description Sets or queries the display format for the bus, either binary or hexadecimal.

Syntax :BUS1:DISplay:FORMAT { BINary | HEXadecimal | ASCII | ? }

Parameter/Return parameter	BINary	Binary format
	HEXadecimal	Hexadecimal format

Example : BUS1:DISplay:FORMAT BINary
Sets the display format to binary.



:LISTer:DATA

Description Returns the Event Table data as a binary block data.

Syntax :LISTer:DATA?

Return Parameter Returns the event table as binary block data. The binary block data contains comma separated data with new lines at the end of each row.

:BUS1:CAN:SOURce (Set) →
→ (Query)

Description	Sets or returns the CAN input source.	
Syntax	:BUS1:CAN:SOURce { CH1 CH2 CH3 CH4 D0 D1 D2 D3 D4 D5 D6 D7 D8 D9 D10 D11 D12 D13 D14 D15 ? }	
Parameter/Return parameter	CH1 ~ CH4	Analog channel source
	D0 to D15	Digital channels D0 to D15
Example	:BUS1:CAN:SOURce? >CH1 Returns the CAN source.	

:BUS1:CAN:PROBe (Set) →
→ (Query)

Description	Sets or returns the signal type of the CAN bus.	
Syntax	:BUS1:CAN:PROBe {CANH CANL TX RX ? }	
Parameter/Return parameter	CANH	CAN-High
	CANL	CAN-Low
	TX	Transmit
	RX	Receive
Example	:BUS1:CAN:PROBe? >CANH :BUS1:CAN:PROBe CANL :BUS1:CAN:PROBe? >CANL	

:BUS1:CAN:SAMPLEpoint → (Query)

Description	Returns the sample point of the CAN bus.
Syntax	:BUS1:CAN:SAMPLEpoint?

Return Parameter Returns the sample point of the CAN bus as a percentage of the bit time.

Example :BUS1:CAN:SAMPLEpoint?
50

Returns the sample point as a percentage.

Set →

→ Query

:BUS1:CAN:BITRate

Description Sets or returns the bit rate of the CAN bus.

Syntax :BUS1:CAN:BITRate
{RATE10K|RATE20K|RATE50K|RATE125K|RATE250K|
RATE500K|RATE800K|RATE1M | <NR1> | ?}

Parameter/Return parameter	RATE10K	10 kbps
	RATE20K	20 kbps
	RATE50K	50 kbps
	RATE125K	125 kbps
	RATE250K	250 kbps
	RATE500K	500 kbps
	RATE800K	800 kbps
	RATE1M	1 Mbps
	<NR1>	CAN bit rate in bps

Example :BUS1:CAN:BITRate?
>1000000

:BUS1:CAN:BITRate rate800k
:BUS1:CAN:BITRate?
>800000

:BUS1:CAN:BITRate 25000
:BUS1:CAN:BITRate?
>25000

 →
 → 

:BUS1:LIN:BITRate

Description	Sets or returns the bit rate of the LIN bus.	
Syntax	:BUS1:LIN:BITRate {<NR1> ?}	
Parameter/Return parameter	<NR1>	LIN bit rate in bps.
Example	:BUS1:LIN:BITRate 9600 Sets the LIN bit rate to 9600bps.	

 →
 → 

:BUS1:LIN:IDFormat

Description	Sets or returns the LIN ID format.	
Syntax	:BUS1:LIN:IDFormat {NOPARity PARity ?}	
Parameter/Return parameter	NOPARity	Don't include parity bits with Id.
	PARity	Include parity bits with Id.
Example	:BUS1:LIN:IDFormat? NOPARITY Returns the ID format.	

 →
 → 

:BUS1:LIN:POLARity

Description	Sets or returns the LIN polarity.	
Syntax	:BUS1:LIN:POLARity {NORMAL INVerted ?}	
Parameter/Return parameter	NORMAL	Normal LIN polarity
	INVerted	Inverted LIN polarity
Example	:BUS1:LIN:POLARity? NORMAL Returns the LIN polarity.	

:BUS1:LIN:SAMPLEpoint → Query

Description	Returns the sample point.
Syntax	:BUS1:LIN:SAMPLEpoint?
Return Parameter	Returns the sample point of the LIN bus as a percentage.
Example	:BUS1:LIN:SAMPLEpoint? 50 Returns the sample point as a percentage.

:BUS1:LIN:SOURce Set →
→ Query

Description	Sets or returns the LIN data source.
Syntax	:BUS1:LIN:SOURce {CH1 CH2 CH3 CH4 D0 D1 D2 D3 D4 D5 D6 D7 D8 D9 D10 D11 D12 D13 D14 D15 ? }
Parameter/Return parameter	CH1 ~ CH4 Analog channel source D0 to D15 Digital channels D0 to D15
Example	:BUS1:LIN:SOURCE? >CH1 Returns the LIN source.

:BUS1:LIN:STANDARD Set →
→ Query

Description	Sets or returns the LIN standard.
Syntax	:BUS1:LIN:STANDARD {V1X V2X BOTH ?}
Parameter/Return parameter	V1X Lin standard version 1.x V2X Lin standard version 2.x BOTH Both standards

Example :BUS1:LIN:STANDard?
 >BOTH
 Returns the LIN standard.

Mark Commands

:MARK.....	186
:MARK:CREATE.....	186
:MARK:DELEte.....	187

:MARK (Set) →

Description	Move to next or previous event mark.	
Syntax	:MARK { NEXT PREVIOUS }	
Related commands	:MARK:CREATE	
	:MARK:DELEte	
Parameter	NEXT	Move to next mark
	PREVIOUS	Move to previous mark
Example	:MARK NEXT Moves to the next event mark.	

:MARK:CREATE (Set) →

Description	Creates a mark on the waveform at the current position or creates a mark for all the events for the current waveform.	
Syntax	:MARK:CREATE { CURRENT ALL }	
Related commands	:MARK	
	:MARK:DELEte	
Parameter	CURRENT	Creates a mark at the current position
	ALL	Creates a mark for all the events.
Example	:MARK:CREATE CURRENT Creates a mark at the current position.	

:MARK:DELEte

Set →

Description Deletes the current mark or all the marks on a waveform.

Syntax :MARK:DELEte { CURRent | ALL }

Related commands :MARK
:MARK:CREATE

Parameter	CURRent	Deletes the current mark
	ALL	Deletes all the marks

Example :MARK:DELEte CURRent
Deletes the current mark.

Search Commands

:SEARCH:COPIY	189
:SEARCH:STATE	190
:SEARCH:TOTAL	190
:SEARCH:TRIGger:TYPe	190
:SEARCH:TRIGger:SOURce.....	191
:SEARCH:TRIGger:EDGE:SLOP	191
:SEARCH:TRIGger:LEVel	192
:SEARCH:TRIGger:HLEVel	192
:SEARCH:TRIGger:LLEVel	193
:SEARCH:TRIGger:PULSEWidth:POLarity	193
:SEARCH:TRIGger:RUNT:POLarity	194
:SEARCH:TRIGger:RISEFall:SLOP	194
:SEARCH:TRIGger:PULSE:WHEn.....	195
:SEARCH:TRIGger:PULSE:TIME.....	195
:SEARCH:TRIGger:RUNT:WHEn	196
:SEARCH:TRIGger:RUNT:TIME	196
:SEARCH:TRIGger:RISEFall:WHEn	197
:SEARCH:TRIGger:RISEFall:TIME	197
:SEARCH:TRIGger:BUS:TYPe.....	198
:SEARCH:TRIGger:BUS:B1:I2C:CONDition	198
:SEARCH:TRIGger:BUS:B1:I2C:ADDRes:MODE	199
:SEARCH:TRIGger:BUS:B1:I2C:ADDRes:TYPe	199
:SEARCH:TRIGger:BUS:B1:I2C:ADDRes:VALue.....	200
:SEARCH:TRIGger:BUS:B1:I2C:ADDRes:DIRrection	201
:SEARCH:TRIGger:BUS:B1:I2C:DATA:SIZE	201
:SEARCH:TRIGger:BUS:B1:I2C:DATA:VALue	202
:SEARCH:TRIGger:BUS:B1:UART:CONDition.....	203
:SEARCH:TRIGger:BUS:B1:UART:RX:DATA:SIZE.....	204
:SEARCH:TRIGger:BUS:B1:UART:RX:DATA:VALue ..	204
:SEARCH:TRIGger:BUS:B1:UART:TX:DATA:SIZE	205
:SEARCH:TRIGger:BUS:B1:UART:TX:DATA:VALue ..	205
:SEARCH:TRIGger:BUS:B1:SPI:CONDition.....	206

:SEARCH:TRIGger:BUS:B1:SPI:DATa:SIZE.....207
 :SEARCH:TRIGger:BUS:B1:SPI:DATa:MISO:VALue.207
 :SEARCH:TRIGger:BUS:B1:SPI:DATa:MOSI:VALue.208
 :SEARCH:TRIGger:BUS:B1:CAN:CONDition209
 :SEARCH:TRIGger:BUS:B1:CAN:FRAMeType210
 SEARCH:TRIGger:BUS:B1:CAN:IDentifier:MODE ...210
 :SEARCH:TRIGger:BUS:B1:CAN:IDentifier:VALue ...211
 :SEARCH:TRIGger:BUS:B1:CAN:IDentifier:DIRectioN211
 :SEARCH:TRIGger:BUS:B1:CAN:DATa:QUALifier....212
 :SEARCH:TRIGger:BUS:B1:CAN:DATa:SIZE213
 :SEARCH:TRIGger:BUS:B1:CAN:DATa:VALue213
 :SEARCH:TRIGger:BUS:B1:LIN:CONDition214
 :SEARCH:TRIGger:BUS:B1:LIN:DATa:QUALifier215
 :SEARCH:TRIGger:BUS:B1:LIN:DATa:SIZE216
 :SEARCH:TRIGger:BUS:B1:LIN:DATa:VALue216
 :SEARCH:TRIGger:BUS:B1:LIN:ERRTYpe217
 :SEARCH:TRIGger:BUS:B1:LIN:IDentifier:VALue....218
 :SEARCH:FFTPeak:METhod218
 :SEARCH:FFTPeak:METhod:MPEak.....219
 :SEARCH:FFTPeak:SINFo.....220
 :SEARCH:FFTPeak:LIST.....220

:SEARCH:COPY



Description	Copies the search settings to the trigger settings or copies the trigger settings to the search settings.	
Syntax	:SEARCH:COPY {SEARCHtotrigger TRIGgertosearch}	
Parameter	SEARCHtotrigger	Copy the search setting to the trigger settings.
	TRIGgertosearch	Copy the trigger settings to the search settings.
Example	:SEARCH:COPY SEARCHtotrigger Copies the search settings to the trigger settings.	

Set →
→ Query

:SEARCH:STATE

Description	Sets or queries whether the Search function is on or off.	
Syntax	:SEARCH:STATE { OFF ON ? }	
Parameter/Return parameter	OFF	Turn the Search function on.
	ON	Turn the Search function off.
Example	:SEARCH:STATE ON Turn Search on.	

→ Query

:SEARCH:TOTAL

Description	Returns the total number of events found from the search function.	
Syntax	:SEARCH:TOTAL?	
Return parameter	<NR1>	Number of events.
Example	:SEARCH:TOTAL? 5	

Set →
→ Query

:SEARCH:TRIGger:TYPe

Description	Sets or queries the search trigger type.	
Syntax	:SEARCH:TRIGger:TYPe { EDGe PULSEWidth RUNT RISEFall FFTPeak LOGic BUS ? }	
Parameter/Return parameter	EDGe	Edge trigger
	PULSEWidth	Pulse width trigger
	RUNT	Runt trigger
	RISEFall	Rise and Fall trigger
	FFTPeak	FFT Peak trigger
	LOGic	Logic trigger

	BUS	Bus trigger
--	------------	-------------

Example :SEARCH:TRIGger:TYPE EDGE
Sets the search trigger to the edge type.

:SEARCH:TRIGger:SOURce
 Set →
 Query

Description Sets or queries the search trigger source.

Syntax :SEARCH:TRIGger:SOURce {CH1 | CH2 | CH3 | CH4 | D0 | D1 | D2 | D3 | D4 | D5 | D6 | D7 | D8 | D9 | D10 | D11 | D12 | D13 | D14 | D15 | ? }

Parameter/Return parameter	CH1 to CH4	Channel 1 to Channel 4
	D0 to D15	Digital channels D0 to D15

Example :SEARCH:TRIGger:SOURce CH1
Sets the search trigger source as CH1.

:SEARCH:TRIGger:EDGE:SLOP
 Set →
 Query

Description Sets or queries the search trigger slope.

Syntax :SEARCH:TRIGger:EDGE:SLOP { RISE | FALL | EITHER | ? }

Related commands :SEARCH:TRIGger:TYPE

Parameter	RISe	Rising slope
	FALL	Falling slope
	EITHer	Either rising or falling slope

Return parameter Returns the trigger slope.

Example :SEARCH:TRIGger:EDGE:SLOP FALL
Sets the search trigger slope to falling.

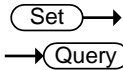

:SEARCH:TRIGger:LEVel

Description	Sets or queries the search trigger level.	
Syntax	:SEARCH:TRIGger:LEVel {TTL ECL SETTO50 <NRf> ?}	
Related commands	:SEARCH:TRIGger:TYPE	
Parameter	<NRf>	Trigger level value
	TTL	Sets the search trigger level to TTL.
	ECL	Sets the search trigger level to ECL.
	SETTO50	Sets the search trigger level to the User level (50% by default).
Return parameter	<NR3>	Returns the trigger.
Example1	:SEARCH:TRIGger:LEVel TTL Sets the search trigger level to TTL.	
Example2	:SEARCH:TRIGger:LEVel 3.30E-1 Sets the search trigger level to 330mV/mA.	

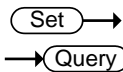

:SEARCH:TRIGger:HLEVel

Description	Sets or queries the high level search trigger.	
Note	Applicable for Rise and Fall/Pulse Runt search triggers.	
Syntax	:SEARCH:TRIGger:HLEVel { <NRf> ?}	
Related commands	:SEARCH:TRIGger:TYPE	
Parameter	<NRf>	High level value.
Return parameter	<NR3>	Returns the high level search trigger.
Example	:SEARCH:TRIGger:HLEVel 3.30E-1 Sets the high level search trigger to 330mV/mA.	

:SEARCH:TRIGger:LLEVel (Set) →
→ (Query)

Description	Sets or queries the low level search trigger.	
Note	Applicable for Rise and Fall/Pulse Runt triggers.	
Syntax	:SEARCH:TRIGger:LLEVel { <NRf> ?}	
Related commands	:SEARCH:TRIGger:TYPe	
Parameter	<NRf>	Low level value.
Return parameter	<NR3>	Returns the low level.
Example	:SEARCH:TRIGger:LLEVel -3.30E-3 Sets the low level search trigger to 330mV/mA.	

:SEARCH:TRIGger:PULSEWidth:POLarity (Set) →
→ (Query)

Description	Sets or queries the pulse width search trigger polarity.	
Syntax	:SEARCH:TRIGger:PULSEWidth:POLarity {POSitive NEGative ?}	
Related commands	:SEARCH:TRIGger:TYPe	
Parameter	POSitive	Positive polarity
	NEGative	Negative polarity
Return parameter	Returns the pulse width polarity.	
Example	:SEARCH:TRIGger:PULSEWidth:POLarity POSitive Sets the pulse width polarity to positive.	

:SEARCH:TRIGger:RUNT:POLarity





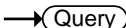

Description	Sets or queries the Pulse Runt search trigger polarity.	
Syntax	:SEARCH:TRIGger:RUNT:POLarity {POSitive NEGative EITHer ?}	
Related commands	:SEARCH:TRIGger:TYPE	
Parameter	POSitive	Positive polarity
	NEGative	Negative polarity
	EITHer	Positive or negative polarity
Return parameter	Returns the pulse runt search trigger polarity.	
Example	:SEARCH:TRIGger:RUNT:POLarity POSitive Sets the Pulse Runt search trigger polarity to positive.	

:SEARCH:TRIGger:RISEFall:SLOP

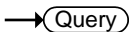

Description	Sets or queries the slope of the Rise and Fall search trigger.	
Syntax	:SEARCH:TRIGger:RISEFall:SLOP { RISE FALL EITHer ? }	
Related commands	:SEARCH:TRIGger:TYPE	
Parameter	RISe	Rising slope
	FALL	Falling slope
	EITHer	Either rising or falling slope
Return parameter	Returns the rise & fall slope.	
Example	:SEARCH:TRIGger:RISEFall :SLOP RISE Sets the Rise & Fall search trigger slope to rising.	

		 								
:SEARCH:TRIGger:PULSe:WHEn		→ Query								
Description	Sets or queries the pulse width search trigger conditions.									
Syntax	:SEARCH:TRIGger:PULSe:WHEn {MOREthan LESSthan EQual UNEQual ?}									
Related commands	:SEARCH:TRIGger:TYPE :SEARCH:TRIGger:PULSe:TIME									
Parameter	<table border="0"> <tr><td>MOREthan</td><td>></td></tr> <tr><td>LESSthan</td><td><</td></tr> <tr><td>EQual</td><td>=</td></tr> <tr><td>UNEQual</td><td>≠</td></tr> </table>		MOREthan	>	LESSthan	<	EQual	=	UNEQual	≠
MOREthan	>									
LESSthan	<									
EQual	=									
UNEQual	≠									
Return parameter	Returns the pulse width search trigger conditions.									
Example	:SEARCH:TRIGger:PULSe:WHEn UNEQual Sets the pulse width search trigger conditions to not equal to (≠).									

		 
:SEARCH:TRIGger:PULSe:TIME		→ Query
Description	Sets or queries the pulse width search trigger time.	
Syntax	:SEARCH:TRIGger:PULSe:TIME {<NRf> ?}	
Related commands	:SEARCH:TRIGger:TYPE :SEARCH:TRIGger:PULSe:WHEn	
Parameter	<NRf>	Pulse width time (4ns~10s)
Return parameter	<NR3>	Returns the pulse width time in seconds.
Example	:SEARCH:TRIGger:PULSe:TIME 4.00E-5 Sets the pulse width search trigger to 40.0us.	

Set →
 → Query

:SEARCH:TRIGger:RUNT:WHEn

Description	Sets or queries the pulse runt search trigger conditions.
Syntax	:SEARCH:TRIGger:RUNT:WHEn {MOREthan LESSthan EQUAL UNEQUAL ? }
Related commands	:SEARCH:TRIGger:TYPE :SEARCH:TRIGger:RUNT:TIME
Parameter	MOREthan > LESSthan < Equal = UNEQUAL ≠
Return parameter	Returns the pulse runt search trigger conditions.
Example	:SEARCH:TRIGger:RUNT:WHEn UNEQUAL Sets the pulse runt search trigger condition to unequal (≠).

Set →
 → Query

:SEARCH:TRIGger:RUNT:TIME

Description	Sets or queries the pulse runt search trigger time.
Syntax	:SEARCH:TRIGger:RUNT:TIME {<NRf> ? }
Related commands	:SEARCH:TRIGger:TYPE :SEARCH:TRIGger:RUNT:WHEn
Parameter	<NRf> Pulse runt time (4nS to 10S)
Return Parameter	<NR3> Returns the runt time in seconds.
Example	:SEARCH:TRIGger:RUNT:TIME 4.00E-5 Sets the pulse runt time to 40.0uS.

Set →
 → Query

:SEARCH:TRIGger:RISEFall:WHEn

Description	Sets or queries the rise and fall search trigger conditions.												
Syntax	:SEARCH:TRIGger:RISEFall:WHEn {MOREthan LESSthan EQual UNEQual ? }												
Related commands	:SEARCH:TRIGger:TYPE :SEARCH:TRIGger:RISEFall:TIME												
Parameter	<table style="width: 100%; border-collapse: collapse;"> <tr><td style="width: 60%;">MOREthan</td><td style="width: 10%; text-align: center;">></td><td style="width: 30%;"></td></tr> <tr><td>LESSthan</td><td style="text-align: center;"><</td><td></td></tr> <tr><td>EQual</td><td style="text-align: center;">=</td><td></td></tr> <tr><td>UNEQual</td><td style="text-align: center;">≠</td><td></td></tr> </table>	MOREthan	>		LESSthan	<		EQual	=		UNEQual	≠	
MOREthan	>												
LESSthan	<												
EQual	=												
UNEQual	≠												
Return parameter	Returns the rise and fall search trigger condition.												
Example	:SEARCH:TRIGger:RISEFall:WHEn UNEQual Sets the rise and fall search trigger condition to unequal (≠).												

Set →
 → Query

:SEARCH:TRIGger:RISEFall:TIME

Description	Sets or queries the rise and fall time.
Syntax	:SEARCH:TRIGger:RISEFall:TIME {<NRf> ? }
Related commands	:SEARCH:TRIGger:TYPE :SEARCH:TRIGger:RISEFall:WHEn
Parameter	<NRf> Rise and Fall time (4nS to 10S)
Return Parameter	<NR3> Returns the rise and fall time in seconds.
Example	:SEARCH:TRIGger:RISEFall:TIME 4.00E-5 Sets the trigger rise and fall time to 40.0us.

:SEARCH:TRIGger:BUS:TYPE → Query

Description	Returns the current bus type.	
Syntax	:SEARCH:TRIGger:BUS:TYPE?	
Return parameter	I2C	I2C mode
	SPI	SPI mode
	UART	UART mode
	CAN	CAN mode
	LIN	LIN mode
	PARAllel	Parallel mode
Example	:SEARCH:TRIGger:BUS:TYPE? UART	

:SEARCH:TRIGger:BUS:B1:I2C:CONDition Set →
→ Query

Description	Sets or queries the I ² C search trigger conditions.	
Syntax	:SEARCH:TRIGger:BUS:B1:I2C:CONDition {START STOP REPEATstart ACKMISS ADDRess DATA ADDRANDDATA ? }	
Parameter	START	Set Start as the I ² C search trigger condition.
	STOP	Set Stop as the I ² C search trigger condition.
	REPEATstart	Set Repeat of Start as the I ² C search trigger condition.
	ACKMISS	Set Missing Acknowledgement as the I ² C search trigger condition.
	ADDRess	Set Address as the I ² C search trigger condition.

DATA	Set Data as the I ² C search trigger condition.
ADDRANDDATA	Set Address and Data as the I ² C search trigger condition.

Return parameter Returns the I²C bus search trigger condition.

Example :SEARCH:TRIGger:BUS:B1:I2C:CONDition ADDRess
Set Address as the I²C search trigger condition.

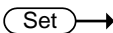
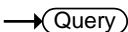
:SEARCH:TRIGger:BUS:B1:I2C:ADDRess 
:MODE 

Description Sets or queries the I²C addressing mode (7 or 10 bits) for the search trigger.

Syntax :SEARCH:TRIGger:BUS:B1:I2C:ADDRess:MODE
{ADDR7 | ADDR10 | ? }

Related commands :SEARCH:TRIGger:BUS:B1:I2C:CONDition

Parameter	ADDR7	7 bit addressing
	ADDR10	10 bit addressing

Return Parameter	0	7 bit addressing
	1	10 bit addressing

Example :SEARCH:TRIGger:BUS:B1:I2C:ADDRess:MODE?
0
The addressing mode is current set to 7 bits.

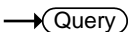
:SEARCH:TRIGger:BUS:B1:I2C:ADDRess 
:TYPE 

Description Sets the I²C bus address type, or queries what the setting is for the search trigger.

Syntax :SEARCH:TRIGger:BUS:B1:I2C:ADDRess:TYPE
{GENeralcall | STARtbyte | HSmode | EEPROM | CBUS
| ? }

Related commands	:SEARCH:TRIGger:BUS:B1:I2C:CONDition	
Parameter	GENeralcall	Set a general call address (0000 000 0).
	STARtbyte	Set a start byte address. (0000 000 1)
	HSmode	Set a high-speed mode address. (0000 1xx x)
	EEPROM	Set an EEPROM address. (1010 xxx x)
	CBUS	Set a CBUS address. (0000 001 x)
Return Parameter	Returns the address type	
Example	:SEARCH:TRIGger:BUS:B1:I2C:ADDRes:TYPe? CBUS	

:SEARCH:TRIGger:BUS:B1:I2C:ADDRes VALue (Set) →
→ (Query)

Description	Sets or queries the I ² C bus address value when the I ² C search trigger is set to trigger on Address or Address/Data.	
Syntax	:SEARCH:TRIGger:BUS:B1:I2C:ADDRes:VALue {<string> ? }	
Related commands	:SEARCH:TRIGger:BUS:B1:I2C:ADDRes:MODE	
Parameter	<sting>	7/10 characters, must be enclosed in double quotes "string". x = don't care 1 = binary 1 0 = binary 0
Return Parameter	Returns the address value in binary.	

Example 1 :SEARCH:TRIGger:BUS:B1:I2C:ADDRess:MODE
 ADDR7
 :SEARCH:TRIGger:BUS:B1:I2C:ADDRess:VALue
 "xxx0101"
 Sets the address to XXX0101

Example 2 :SEARCH:TRIGger:BUS:B1:I2C:ADDRess:VALue?
 XXX0101

:SEARCH:TRIGger:BUS:B1:I2C:ADDRess (Set) →
 :DIRection → (Query)

Description Sets or queries the address bit as read write or
 don't care for the search function.

Note This setting only applies when the I²C search
 trigger is set to trigger on Address or
 Address/Data

Syntax :SEARCH:TRIGger:BUS:B1:I2C:ADDRess:DIRection
 { READ | WRITE | NOCARE | ? }

Related commands :SEARCH:TRIGger:BUS:B1:I2C:CONDition

Parameter	READ	Set read as the data direction.
	WRITE	Set write as the data direction.
	NOCARE	Set either as the data direction.

Return Parameter Returns the direction (READ, WRITE, NOCARE).

Example :SEARCH:TRIGger:BUS:B1:I2C:ADDRess:DIRection
 READ
 Sets the direction to READ.

:SEARCH:TRIGger:BUS:B1:I2C:DATA:SIZE (Set) →
 → (Query)

Description Sets or queries the data size in bytes for the I²C
 bus.

Note	This setting only applies when the I ² C search trigger is set to trigger on Data or Address/Data	
Syntax	:SEARCH:TRIGger:BUS:B1:I2C:DATA:SIZE {<NR1> ? }	
Related commands	:SEARCH:TRIGger:BUS:B1:I2C:CONDition	
Parameter	<NR1>	Number of data bytes (1 to 5).
Return parameter	<NR1>	Returns the number of bytes.
Example	:SEARCH:TRIGger:BUS:B1:I2C:DATA:SIZE 3 Sets the number of bytes to 3.	

Set →

:SEARCH:TRIGger:BUS:B1:I2C:DATA:VALue → Query

Description	Sets or queries the triggering data value for the I ² C bus when the I ² C search trigger is set to trigger on Data or Address/Data.	
Syntax	:SEARCH:TRIGger:BUS:B1:I2C:DATA:VALue {<string> ? }	
Related commands	:SEARCH:TRIGger:BUS:B1:I2C:DATA:SIZE	
Parameter	<string>	The number of characters in the string depends on the data size setting. The string must be enclosed in double quotes, "string". x = don't care 1 = binary 1 0 = binary 0
Return Parameter	Returns the data value.	
Example 1	:SEARCH:TRIGger:BUS:B1:I2C:DATA:SIZE 1 :SEARCH:TRIGger:BUS:B1:I2C:DATA:VALue "1x1x0101" Sets the value to XXX0101	

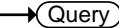
:SEARCH:TRIGger:BUS:B1:UART:RX:DATA:  →
 SIZE 

Description	Sets or queries the number of bytes for UART data.	
Note	This setting only applies when the UART search trigger is set to trigger on Rx Data	
Syntax	:SEARCH:TRIGger:BUS:B1:UART:RX:DATA:SIZE {<NR1> ?}	
Related commands	:SEARCH:TRIGger:BUS:B1:UART:CONDition	
Parameter	<NR1>	Number of bytes (1 to 10).
Return parameter	<NR1>	Returns the number of bytes.
Example	:SEARCH:TRIGger:BUS:B1:UART:RX:DATA:SIZE 5 Sets the number of bytes to 5.	

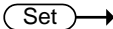
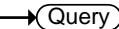

:SEARCH:TRIGger:BUS:B1:UART:RX:DATA:  →
 VALue 

Description	Sets or queries the search triggering data value for the UART bus when the bus is set to trigger on Rx Data.	
Syntax	:SEARCH:TRIGger:BUS:B1:UART:RX:DATA:VALue {<string> ?}	
Related commands	:SEARCH:TRIGger:BUS:B1:UART:RX:DATA:SIZE	
Parameter	<string>	The number of characters in the string depends on the data size setting. The string must be enclosed in double quotes, "string". x = don't care 1 = binary 1 0 = binary 0

Return Parameter Returns the data value.

Example1 :SEARCH:TRIGger:BUS:B1:UART:CONDition RXDATA
 :SEARCH:TRIGger:BUS:B1:UART:RX:DATA:SIZE 1
 :SEARCH:TRIGger:BUS:B1:UART:RX:DATA:VALue
 "1x1x0101"
 Sets the value to 1x1x0101

Example 2 :SEARCH:TRIGger:BUS:B1:UART:RX:DATA:VALue?
 1X1X0101

:SEARCH:TRIGger:BUS:B1:UART:TX:DATA 
 :SIze 

Description Sets or queries the number of bytes for UART data.

Note This setting only applies when the UART search trigger is set to trigger on Tx Data

Syntax :SEARCH:TRIGger:BUS:B1:UART:TX:DATA:SIZE
 {<NR1> | ?}

Related commands :SEARCH:TRIGger:BUS:B1:UART:CONDition

Parameter <NR1> Number of bytes (1 to 10).

Return parameter <NR1> Returns the number of bytes.

Example :SEARCH:TRIGger:BUS:B1:UART:TX:DATA:SIZE 5
 Sets the number of bytes to 5.

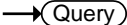
:SEARCH:TRIGger:BUS:B1:UART:TX:DATA: VALue 

Description Sets or queries the search triggering data value for the UART bus when the bus is set to trigger on Tx Data.

Syntax :SEARCH:TRIGger:BUS:B1:UART:TX:DATA:VALue
 {<string> | ?}

Related commands	:SEARCH:TRIGger:BUS:B1:UART:TX:DATA:SIZE	
Parameter	<string>	<p>The number of characters in the string depends on the data size setting. The string must be enclosed in double quotes, "string".</p> <p>x = don't care</p> <p>1 = binary 1</p> <p>0 = binary 0</p>

Return Parameter Returns the data value.

Example 1 :SEARCH:TRIGger:BUS:B1:UART:CONDition TXDATA
 :SEARCH:TRIGger:BUS:B1:UART:TX:DATA:SIZE 1
 :SEARCH:TRIGger:BUS:B1:UART:TX:DATA:VALue
 "1x1x0101"
 Sets the value to 1x1x0101

Example 2 :SEARCH:TRIGger:BUS:B1:UART:TX:DATA:VALue?
 1X1X0101

Set →
 → Query

Description Sets or queries the SPI search triggering condition.

Syntax :SEARCH:TRIGger:BUS:B1:SPI:CONDition {SS | MISO | MOSI | MISOMOSI | ? }

Parameter	SS	Set to trigger on the Slave Selection condition.
	MISO	Set to trigger on the Master-In Slave-Out condition.
	MOSI	Set to trigger on the Master-Out Slave-In condition.
	MISOMOSI	Set to trigger on the Master-In Slave-Out and Master-Out Slave-In conditions.

Return Parameter Returns the triggering condition.

Example :SEARCH:TRIGger:BUS:B1:SPI:CONDition MISO
Sets the SPI bus to trigger on MISO.

:SEARCH:TRIGger:BUS:B1:SPI:DATA:SIZE  

Description Sets or queries the number of words for SPI data for the search function.

Note This setting only applies when the SPI search trigger is set to trigger on MISO, MOSI or MISO/MOSI

Syntax :SEARCH:TRIGger:BUS:B1:SPI:DATA:SIZE {<NR1> | ?}

Related commands :SEARCH:TRIGger:BUS:B1:SPI:CONDition

Parameter <NR1> Number of words (1 to 32).

Return parameter <NR1> Returns the number of words.

Example :SEARCH:TRIGger:BUS:B1:SPI:DATA:SIZE 10
Sets the number of words to 10.

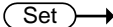
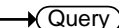
:SEARCH:TRIGger:BUS:B1:SPI:DATA:MISO:  

Description Sets or queries the search triggering data value for the SPI bus when the bus is set to trigger on MISO or MISO/MOSI.

Syntax :SEARCH:TRIGger:BUS:B1:SPI:DATA:MISO:VALue {<string> | ?}

Related commands :SEARCH:TRIGger:BUS:B1:SPI:DATA:SIZE

Parameter <sting> The number of characters in the string depends on the data size setting. The string must be enclosed in double quotes, "string".

Example1 :SEARCH:TRIGger:BUS:B1:SPI:CONDition MOSI
 :SEARCH:TRIGger:BUS:B1:SPI:DATA:SIZE 2
 :SEARCH:TRIGger:BUS:B1:SPI:DATA:MOSI:VALue
 "1x1x0101"
 Sets the value to 1x1x0101

Example2 :SEARCH:TRIGger:BUS:B1:SPI:DATA:MOSI:VALue?
 1X1X0101

Set →

:SEARCH:TRIGger:BUS:B1:CAN:CONDition → Query

Description Sets or returns the CAN search trigger condition.

Syntax :SEARCH:TRIGger:BUS:B1:CAN:CONDition
 {SOF|FRAMeType|Identifier|DATA|IDANDDATA|EOF|
 ACKMISS|STUFFERR|?}

Parameter/ Return parameter	SOF	Sets search to trigger on a start of frame
	FRAMeType	Sets search to trigger on the type of frame
	Identifier	Sets search to trigger on a matching identifier
	DATA	Sets search to trigger on matching data
	IDANDDATA	Sets search to trigger on matching identifier and data field
	EOF	Sets search to trigger on the end of frame
	ACKMISS	Sets search to trigger on a missing acknowledge
	STUFFERR	Sets search to trigger on a bit stuffing error

Example1 :SEARCH:TRIGger:BUS:B1:CAN:CONDition SOF
 Triggers search on a start of frame.

Example2 :SEARCH:TRIGger:BUS:B1:CAN:CONDition?
>SOF

Set →

:SEARCH:TRIGger:BUS:B1:CAN:FRAMEType → Query

Description Sets or returns the frame type for the CAN FRAMEType search trigger.

Syntax :SEARCH:TRIGger:BUS:B1:CAN:FRAMEType {DATA|REMOte|ERRor|OVERLoad|?}

Parameter/ Return parameter	DATA	Sets the frame type to data frame
	REMOte	Sets the frame type to remote frame
	ERRor	Sets the frame type to error frame
	OVERLoad	Sets the frame type to overload

Example :SEARCH:TRIGger:BUS:B1:CAN:FRAMEType DATA
Sets the frame type to DATA.

SEARCH:TRIGger:BUS:B1:CAN:IDentifier: MODE Set →
→ Query

Description Sets or returns the CAN identifier mode for the bus.

Syntax :SEARCH:TRIGger:BUS:B1:CAN:IDentifier:MODE {STANDard|EXTended|?}

Parameter/ Return parameter	STANDard	Standard addressing mode
	EXTended	Extended addressing mode

Example :SEARCH:TRIGger:BUS:B1:CAN:IDentifier:MODE?
>STANDARD

:SEARCH:TRIGger:BUS:B1:CAN:IDentifier:MODE
EXTENDED

:SEARCH:TRIGger:BUS:B1:CAN:IDentifier:MODE?
>EXTENDED

:SEARCH:TRIGger:BUS:B1:CAN:IDentifier: VALue (Set) →
→ (Query)

Description Sets or returns the identifier string used for the CAN search trigger.

Note: Only applicable when the search trigger condition is set to ID or IDANDDATA.

Syntax :SEARCH:TRIGger:BUS:B1:CAN:IDentifier:VALue {<string>|?}

Related Commands :SEARCH:TRIGger:BUS:B1:CAN:IDentifier:MODE

Parameter/ Return parameter	<code><string></code>	The size of the string depends on the data size setting. The string must be enclosed in double quotes, "string". String contents: x = don't care 1 = binary 1 0 = binary 0
--	-----------------------------	--

Example :SEARCH:TRIGger:BUS:B1:CAN:CONDition ID
:SEARCH:TRIGger:BUS:B1:CAN:IDentifier:MODE STANDARD
:SEARCH:TRIGger:BUS:B1:CAN:IDentifier:VALue "01100X1X01X"
:SEARCH:TRIGger:BUS:B1:CAN:IDentifier:VALue? >01100X1X01X

:SEARCH:TRIGger:BUS:B1:CAN:IDentifier: DIRection (Set) →
→ (Query)

Description Sets or queries the address bit as read, write or don't care.

Syntax :SEARCH:TRIGger:BUS:B1:CAN:IDentifier:DIRection {READ|WRITE|NOCARE?}

Parameter/ Return parameter	READ	Sets read as the data direction
	WRITE	Sets write as the data direction
	NO CARE	Sets either as the data direction

```
Example2 :SEARCH:TRIGger:BUS:B1:CAN:IDentifier:DIRection?
>WRITE

:SEARCH:TRIGger:BUS:B1:CAN:IDentifier:DIRection
READ

:SEARCH:TRIGger:BUS:B1:CAN:IDentifier:DIRection?
>READ
```

```
:SEARCH:TRIGger:BUS:B1:CAN:DATA:
QUALifier
```

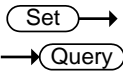

Description Sets or returns the CAN data qualifier.
 Note: Only applicable when the search triggering condition is set to DATA or IDANDDATA.

Syntax :SEARCH:TRIGger:BUS:B1:CAN:DATA:QUALifier
 {LESSthan|MOREthan|EQUAL|UNEQUAL|LESSEQUAL|M
 OREEQUAL|?}

Parameter/ Return parameter	LESSthan	Sets search to trigger when the data is less than the qualifier value.
	MOREthan	Sets search to trigger when the data is greater than the qualifier value.
	EQUAL	Sets search to trigger when the data is equal to the qualifier value.
	UNEQUAL	Sets search to trigger when the data is not equal to the qualifier value.
	LESSEQUAL	Sets search to trigger when the data is less than or equal to the qualifier value.
	MOREEQUAL	Sets search to trigger when the data is more than or equal to the qualifier value.

Example :SEARCH:TRIGger:BUS:B1:CAN:DATA:QUALifier?
>EQUAL
:SEARCH:TRIGger:BUS:B1:CAN:DATA:QUALifier
MOREthan
:SEARCH:TRIGger:BUS:B1:CAN:DATA:QUALifier?
>MORETHAN

Set →

:SEARCH:TRIGger:BUS:B1:CAN:DATA:SIZE → Query

Description Sets or returns the length of the data string in bytes for the CAN search trigger.
Note: Only applicable when the condition is set to DATA or IDANDDATA.

Syntax :SEARCH:TRIGger:BUS:B1:CAN:DATA:SIZE {<NR1>|?}

Parameter/ Return parameter <NR1> 1~8 (bytes)

Example :SEARCH:TRIGger:BUS:B1:CAN:DATA:SIZE?
>1
:SEARCH:TRIGger:BUS:B1:CAN:DATA:SIZE 2
:SEARCH:TRIGger:BUS:B1:CAN:DATA:SIZE?
>2

:SEARCH:TRIGger:BUS:B1:CAN:DATA: VALue Set →
→ Query

Description Sets or returns the binary data string to be used for the CAN search trigger.

Related Commands :SEARCH:TRIGger:BUS:B1:CAN:DATA:SIZE

Syntax :SEARCH:TRIGger:BUS:B1:CAN:DATA:VALue {<string>|?}

Parameter/ Return parameter <string> The size of the string depends on the data size setting. The string must be enclosed in double quotes, "string".

String contents:
 x = don't care
 1 = binary 1
 0 = binary 0

Example :SEARCH:TRIGger:BUS:B1:CAN:DATA:SIZE 1
 :SEARCH:TRIGger:BUS:B1:CAN:DATA:VALue
 "01010X1X"
 :SEARCH:TRIGger:BUS:B1:CAN:DATA:VALue?
 >01010X1X

Set →

:SEARCH:TRIGger:BUS:B1:LIN:CONDition → Query

Description Sets or returns the LIN search trigger condition.

Syntax :SEARCH:TRIGger:BUS:B1:LIN:CONDition
 {SYNCFieLd|IDentifier|DATA|IDANDDATA|WAKEup|SLEEPEE|ERRor|?}

Parameter/ Return parameter	SYNCFieLd	Sets the LIN search trigger condition to the sync field.
	IDentifier	Sets the LIN search trigger condition to identifier field.
	DATA	Sets the LIN search trigger condition to the data field.
	IDANDDATA	Sets the LIN search trigger condition to identifier and data field
	WAKEup	Sets the LIN search trigger condition to wake up.
	SLEEPEE	Sets the LIN search trigger condition to sleep.
	ERRor	Sets the LIN search trigger condition to error.

```
Example      :SEARCH:TRIGger:BUS:B1:LIN:CONDition?
              >IDANDDATA
              :SEARCH:TRIGger:BUS:B1:LIN:CONDition DATA
              :SEARCH:TRIGger:BUS:B1:LIN:CONDition?
              >DATA
```

```
:SEARCH:TRIGger:BUS:B1:LIN:DATA:          (Set) →
QUALifier                                  → (Query)
```

Description Sets or returns the LIN data qualifier.
 Note: Only applicable when the search trigger condition is set to DATA or IDANDDATA.

Syntax :SEARCH:TRIGger:BUS:B1:LIN:DATA:QUALifier
 {LESSthan|MOREthan|EQual|UNEQual|LESSEQual|M
 OREEQual|?}

Parameter/ Return parameter	LESSthan	Sets search to trigger when the data is less than the qualifier value.
	MOREthan	Sets search to trigger when the data is greater than the qualifier value.
	EQual	Sets search to trigger when the data is equal to the qualifier value.
	UNEQual	Sets search to trigger when the data is not equal to the qualifier value.
	LESSEQual	Sets search to trigger when the data is less than or equal to the qualifier value.
	MOREEQual	Sets search to trigger when the data is more than or equal to the qualifier value.

Example :SEARCH:TRIGger:BUS:B1:LIN:DATA:QUALifier?
 >EQUAL
 :SEARCH:TRIGger:BUS:B1:LIN:DATA:QUALifier
 MOREthan
 :SEARCH:TRIGger:BUS:B1:LIN:DATA:QUALifier?
 >MORETHAN

Set →

:SEARCH:TRIGger:BUS:B1:LIN:DATA:SIZE → Query

Description Sets or returns the length of the data string in bytes for the LIN search trigger.
 Note: Only applicable when the condition is set to DATA or IDANDDATA.

Syntax :SEARCH:TRIGger:BUS:B1:LIN:DATA:SIZE {<NR1>|?}

Parameter/ Return parameter	<NR1>	1~8 (bytes)
--------------------------------	-------	-------------

Example :SEARCH:TRIGger:BUS:B1:LIN:DATA:SIZE?
 >1
 :SEARCH:TRIGger:BUS:B1:LIN:DATA:SIZE 2
 :SEARCH:TRIGger:BUS:B1:LIN:DATA:SIZE?
 >2

:SEARCH:TRIGger:BUS:B1:LIN:DATA: VALue Set →
 → Query

Description Sets or returns the binary data string to be used for the LIN search trigger.
 Note: Only applicable when the condition is set to DATA or IDANDDATA.

Related Commands :SEARCH:TRIGger:BUS:B1:LIN:DATA:SIZE

Syntax :SEARCH:TRIGger:BUS:B1:LIN:DATA:VALue {<string>|?}

Parameter/ Return parameter	<string>	The size of the string depends on the data size setting. The string must be enclosed in double quotes, "string". String contents: x = don't care 1 = binary 1 0 = binary 0
--------------------------------	----------	--

Example

```
:SEARCH:TRIGger:BUS:B1:LIN:DATa:SIZE 1
:SEARCH:TRIGger:BUS:B1:LIN:DATa:VALue
"01010X1X"
:SEARCH:TRIGger:BUS:B1:LIN:DATa:VALue?
>01010X1X
```

:SEARCH:TRIGger:BUS:B1:LIN:ERRTYPE (Set) →
→ (Query)

Description

Sets or returns the error type to be used for the LIN search trigger.

Syntax

```
:SEARCH:TRIGger:BUS:B1:LIN:ERRTYPE
{SYNC|PARItY|CHecksum|?}
```

Parameter/ Return parameter	SYNC	Sets the LIN error type to SYNC.
	PARItY	Sets the LIN error type to parity.
	CHecksum	Sets the LIN error type to checksum.

Example

```
:SEARCH:TRIGger:BUS:B1:LIN:ERRTYPE?
>SYNC
:SEARCH:TRIGger:BUS:B1:LIN:ERRTYPE CHECKSUM
:SEARCH:TRIGger:BUS:B1:LIN:ERRTYPE?
>CHECKSUM
```

:SEARCH:TRIGger:BUS:B1:LIN:IDentifier: VALue (Set) →
→ (Query)

Description Sets or returns the identifier string to be used for the LIN search trigger.

Note: Only applicable when the condition is set to ID or IDANDDATA.

Syntax :SEARCH:TRIGger:BUS:B1:LIN:IDentifier:VALue {<string>|?}

Parameter/ Return parameter	<string>	The size of the string depends on the data size setting. The string must be enclosed in double quotes, "string". String contents: x = don't care 1 = binary 1 0 = binary 0
--	----------	--

Example :SEARCH:TRIGger:BUS:B1:LIN:CONDition ID
:SEARCH:TRIGger:BUS:B1:LIN:IDentifier:VALue "00X1X01X"
:SEARCH:TRIGger:BUS:B1:LIN:IDentifier:VALue? >01100X1X01X

:SEARCH:FFTPeak:METHod (Set) →
→ (Query)

Description Sets or returns the FFT peak method type.

Related Commands :SEARCH:TRIGger:TYPE
:SEARCH:FFTPeak:METHod:MPEak
:SEARCH:TRIGger:LEVel

Syntax :SEARCH:FFTPeak:METHod {MPEak | LEVel | ?}

Parameter/ Return parameter	MPEak	Sets the peak method to the Max Peak type.
	LEVel	Sets the peak methods to the Level type.

Example

```
:SEARCH:FFTPeak:METhod LEVel
:SEARCH:FFTPeak:METhod?
>LEVEL
:SEARCH:TRIGger:LEVel?
>1.000E+00
:SEARCH:TRIGger:LEVel 2
:SEARCH:TRIGger:LEVel?
>2.000E+00
```

:SEARCH:FFTPeak:METhod:MPEak
 →
 →

Description Sets the active peak number (1 ~ 10) or return the frequency of the active peak number.

Related Commands :SEARCH:TRIGger:TYPE
:SEARCH:FFTPeak:METhod

Syntax :SEARCH:FFTPeak:METhod:MPEak {<NR1> | ?}

Parameter <NR1> Active peak number.

Return parameter <NR3> Frequency of the active peak.

Example

```
:SEARCH:FFTPeak:METhod MPEak
:SEARCH:FFTPeak:METhod?
>MPEAK
:SEARCH:FFTPeak:METhod:MPEak?
>1.000E+00
:SEARCH:FFTPeak:METhod:MPEak 2
:SEARCH:FFTPeak:METhod:MPEak?
>2.000E+00
```

		(Set) →
:SEARCH:FFTPeak:SINFo		→ (Query)
Description	Sets or returns the State Info to “Mark” or “Peak”.	
Related Commands	:SEARCH:TRIGger:TYPe	
Syntax	:SEARCH:FFTPeak:SINFo {MARK PEAK ?}	
Parameter/ Return parameter	MARK	Sets the State Info to Mark.
	PEAK	Sets the State Info to Peak.
Example	<pre>:SEARCH:FFTPeak:SINFo? >PEAK :SEARCH:FFTPeak:SINFo mark :SEARCH:FFTPeak:SINFo? >MARK</pre>	

:SEARCH:FFTPeak:LIST		→ (Query)
Description	Returns the data of the search event table.	
Syntax	:SEARCH:FFTPeak:LIST?	
Example	<pre>:SEARCH:FFTPeak:LIST? No.,Frequency,Value; 1,1.000E+04,-6.400E+00; 2,2.750E+06,-7.360E+01; 3,2.830E+06,-7.280E+01; 4,2.910E+06,-7.200E+01; 5,3.020E+06,-7.120E+01; 6,3.170E+06,-7.040E+01; 7,5.550E+06,-8.240E+01; 8,5.640E+06,-8.160E+01; 9,5.740E+06,-8.080E+01; 10,5.900E+06,-8.000E+01;</pre>	

Label Commands

:CHANnel<X>:LABel.....	221
:CHANnel<X>:LABel:DISPlay	222
:REF<X>:LABel	222
:REF<X>:LABel:DISPlay	223
:BUS1:LABel.....	224
:BUS1:LABel:DISPlay	224
:D<x>:LABel	225
:D<x>:LABel:DISPlay.....	226
:DIGital:ANALog:A<x>:LABel	226
:DIGital:ANALog:A<x>:LABel:DISPlay	227
:SET<X>:LABel	228

:CHANnel<X>:LABel



Description	Sets or returns the file label for the selected channel.	
Syntax	:CHANnel<X>:LABel {<string> ?}	
Related commands	:CHANnel<X>:LABel:DISPlay	
Parameter	<X>	Channel 1, 2, 3, 4
	<string>	The string must be no more than 8 characters and only contain alphanumeric characters in addition to period, dash and underscore characters. The string must be enclosed in double quotes, "string".
Return parameter	<string>	Returns the label for the selected channel. No return indicates that there has not been a file label assigned for the selected channel.

Example1 :CHANnel1:LABel "CH1_lab"
 Sets the channel 1 label as "CH1_lab".

Example2 :CHANnel1:LABel?
 CH1_lab

:CHANnel<X>:LABel:DISPlay Set →
← Query

Description Turns the label on/off for the selected channel or returns its status.

Syntax :CHANnel<X>:LABel:DISPlay { OFF | ON | ? }

Related commands :CHANnel<X>:LABel

Parameter	<X>	Channel 1, 2, 3, 4
	OFF	Turns the file label off for the selected channel.
	ON	Turns the file label on for the selected channel.

Return parameter Returns the status of the file label for the selected channel (ON, OFF).

Example :CHANnel1:LABel "CH1"
 :CHANnel1:LABel:DISPlay ON
 :CHANnel1:LABel:DISPlay?
 ON
 Sets the channel 1 label to "CH1" and then turns the label display on. The query return shows that the label is on.

:REF<X>:LABel Set →
← Query

Description Sets or returns the file label for the selected reference waveform.

Syntax :REF<X>:LABel {<string> | ?}

Related commands	:REF<X>:LABel:DISPlay	
Parameter	<X>	REF 1, 2, 3, 4
	<string>	The string must be no more than 8 characters and only contain alphanumeric characters in addition to period, dash and underscore characters. The string must be enclosed in double quotes, "string".
Return parameter	<string>	Returns the label for the selected reference waveform. No return indicates that there has not been a file label assigned for the selected reference waveform.

Example1 :REF1:LABel "REF1_lab"
Sets the REF1 label as "REF1_lab".

Example2 :REF1:LABel?
REF1_lab



Description	Turns the label on/off for the selected reference waveform or returns its status.	
Syntax	:REF<X>:LABel:DISPlay { OFF ON ? }	
Related commands	:REF<X>:LABel	
Parameter	<X>	Reference waveform 1, 2, 3, 4
	OFF	Turns the file label off for the selected reference waveform.
	ON	Turns the file label on for the selected reference waveform.
Return parameter	Returns the status of the file label for the selected reference waveform (ON, OFF).	

Example :REF1:LABel "REF1"
 :REF1:LABel:DISPlay ON
 :REF1:LABel:DISPlay?
 ON

Sets the label for reference waveform 1 to "REF1" and then turns the label display on. The query return shows that the label is on.

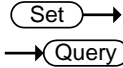

:BUS1:LABel

Description	Sets or returns the file label for the bus.	
Syntax	:BUS1:LABel {<string> ?}	
Related commands	:BUS1:LABel:DISPlay	
Parameter	<string>	The string must be no more than 8 characters and only contain alphanumeric characters in addition to period, dash and underscore characters. The string must be enclosed in double quotes, "string".
Return parameter	<string>	Returns the label for the bus. No return indicates that there has not been a file label assigned for bus.

Example1 :BUS1:LABel "Bus"
 Sets the bus label as "Bus".

Example2 :BUS1:LABel?
 Bus

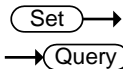

:BUS1:LABel:DISPlay

Description	Turns the label on/off for the bus or returns its status.	
Syntax	:BUS1:LABel:DISPlay { OFF ON ? }	

Related commands :BUS1:LABel
 :D<x>:LABel
 :D<x>:LABel:DISPlay
 :DIGital:ANALog:A<x>:LABel
 :DIGital:ANALog:A<x>:LABel:DISPlay

Parameter OFF Turns the file label off for the bus.
 ON Turns the file label on for the bus.

Return parameter Returns the status of the file label for the bus (ON, OFF).

Example :BUS1:LABel "Bus"
 :BUS1:LABel:DISPlay ON
 :BUS1:LABel:DISPlay?
 ON
 Sets the label for the bus to "Bus" and then turns the label display on. The query return shows that the label is on.



Description Sets or returns the waveform label for digital channels.

Syntax :D<x>:LABel {<string> | ?}

Related commands :D<x>:LABel:DISPlay

Parameter <x> Digital channel number D0~D15
 <string> The string must be no more than 8 characters and only contain alphanumeric characters in addition to period, dash and underscore characters. The string must be enclosed in double quotes, "string".

Return parameter	<code><string></code>	Returns the label for the bus. No return indicates that there has not been a file label assigned for bus.
------------------	-----------------------------	---

Example	<pre>:D1:LABel "D1" Sets the digital channel 1 label as "D1".</pre>
---------	---

<code>:D<x>:LABel:DISPlay</code>	 
--	--

Description	Turns the label on/off for the selected digital channel or returns its status.
-------------	--

Syntax	<code>:D<x>:LABel:DISPlay { OFF ON ? }</code>
--------	---

Related commands	<code>:D<x>:LABel</code>
------------------	--------------------------------

Parameter	<table border="0"> <tr> <td style="background-color: #e0e0e0;">OFF</td> <td>Turns the file label off for the selected digital channel.</td> </tr> <tr> <td style="background-color: #e0e0e0;">ON</td> <td>Turns the file label on for the selected digital channel.</td> </tr> </table>	OFF	Turns the file label off for the selected digital channel.	ON	Turns the file label on for the selected digital channel.
OFF	Turns the file label off for the selected digital channel.				
ON	Turns the file label on for the selected digital channel.				

Return parameter	Returns the status of the file label for the digital channel (ON, OFF).
------------------	---

Example	<pre>:D1:LABel "D1" :D1:LABel? >D1 :D1:LABel:DISPlay ON D1:LABel:DISPlay? ON Sets the label for the D1 channel to "D1" and then turns the label display on. The query return shows that the label is on.</pre>
---------	---

<code>:DIGital:ANALog:A<x>:LABel</code>	 
---	--

Description	Sets or returns the label for analog waveforms.
-------------	---

Syntax	<code>:DIGital:ANALog:A<x>:LABel {<string> ?}</code>
--------	--

Related commands :DIGital:ANALog:A<x>:LABel:DISPlay

Parameter	<x>	Analog waveform number (1~2).
	<string>	The string must be no more than 8 characters and only contain alphanumeric characters in addition to period, dash and underscore characters. The string must be enclosed in double quotes, "string".
Return parameter	<string>	Returns the label for the bus. No return indicates that there has not been a file label assigned for bus.

Example :DIG:ANA:A1:LAB "A1"
Sets the analog waveform 1 label as "A1".

:DIGital:ANALog:A<x>:LABel:DISPlay



Description Turns the label on/off for the analog waveform or returns its status.

Syntax :DIGital:ANALog:A<x>:LABel:DISPlay { OFF | ON | ? }

Related commands :DIGital:ANALog:A<x>:LABel

Parameter	OFF	Turns the file label off for the analog waveform.
	ON	Turns the file label on for the analog waveform.

Return parameter Returns the status of the file label for the analog waveform (ON, OFF).

Example :DIGital:ANALog:A1:LABel "A1"
 :DIGital:ANALog:A1:LABel:DISPlay ON
 :DIGital:ANALog:A1:LABel:DISPlay?
 ON

Sets the label for the analog waveform to "A1" and then turns the label display on. The query return shows that the label is on.

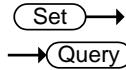

:SET<X>:LABel

Description Sets or returns the file label for the selected setup.

Syntax :SET<X>:LABel {<string> | ?}

Related commands :SET<X>:LABel:DISPlay

Parameter	<X>	Setup number 1 to 20
	<string>	The string must be no more than 8 characters and only contain alphanumeric characters in addition to period, dash and underscore characters. The string must be enclosed in double quotes, "string".
Return parameter	<string>	Returns the label for the selected setup. No return indicates that there has not been a file label assigned for the selected setup.

Example1 :SET1:LABel "SET1_lab"
 Sets the label for setup 1 as "SET1_lab".

Example2 :SET1:LABel?
 SET1_lab

Segment Commands

:SEGMENTS:STATE	229
:SEGMENTS:CURRENT	230
:SEGMENTS:TOTALNUM	230
:SEGMENTS:TIME	231
:SEGMENTS:DISPALL	231
:SEGMENTS:MEASURE:MODE	231
:SEGMENTS:MEASURE:PLOT:SOURCE	232
:SEGMENTS:MEASURE:PLOT:DIVIDE	232
:SEGMENTS:MEASURE:PLOT:SELECT	233
:SEGMENTS:MEASURE:PLOT:RESULTS	233
:SEGMENTS:MEASURE:TABLE:SOURCE	234
:SEGMENTS:MEASURE:TABLE:SELECT	234
:SEGMENTS:MEASURE:TABLE:LIST	235
:SEGMENTS:MEASURE:TABLE:SAVE	235
:SEGMENTS:SAVE	235
:SEGMENTS:SAVE:SOURCE	236
:SEGMENTS:SAVE:SELECT:START	236
:SEGMENTS:SAVE:SELECT:END	237

:SEGMENTS:STATE

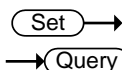

Description Turns the segmented memory function on/off or queries its state.

Syntax :SEGMENTS:STATE { OFF | ON | ? }

Related commands :RUN
:STOP

Parameter/ Return parameter	OFF	Turns the segmented memory off.
	ON	Turns the segmented memory on.

Example1 :SEGMENTS:STATE ON
Turns segmented memory on.

Set →
 → Query

:SEGMents:CURRent							
Description	Sets or queries the current segment. The total number of segments depends on the record length.						
Syntax	:SEGMents:CURRent {SETTOMIN SETTOMAX <NR1> ?}						
Related commands	:SEGMents:STATE :SEGMents:TOTAlnum						
Parameter/ Return parameter	<table style="width: 100%; border-collapse: collapse;"> <tr> <td style="width: 15%; border-right: 1px solid black;">SETTOMIN</td> <td>Current segment = min segment</td> </tr> <tr> <td style="border-right: 1px solid black;">SETTOMAX</td> <td>Current segment = max segment</td> </tr> <tr> <td style="border-right: 1px solid black;"><NR1></td> <td>1~29000</td> </tr> </table>	SETTOMIN	Current segment = min segment	SETTOMAX	Current segment = max segment	<NR1>	1~29000
SETTOMIN	Current segment = min segment						
SETTOMAX	Current segment = max segment						
<NR1>	1~29000						
Example1	:SEGMents:CURRent 10 Sets the current segment to segment number 10.						

Set →
 → Query

:SEGMents:TOTAlnum							
Description	Sets or queries the total number of segments for the segmented memory function. The total number of segments depends on the record length.						
Syntax	:SEGMents:TOTAlnum {SETTOMIN SETTOMAX <NR1> ?}						
Related commands	:SEGMents:STATE :SEGMents:CURRent						
Parameter/ Return parameter	<table style="width: 100%; border-collapse: collapse;"> <tr> <td style="width: 15%; border-right: 1px solid black;">SETTOMIN</td> <td>Sets to the minimum number</td> </tr> <tr> <td style="border-right: 1px solid black;">SETTOMAX</td> <td>Sets to the maximum number</td> </tr> <tr> <td style="border-right: 1px solid black;"><NR1></td> <td>1~29000</td> </tr> </table>	SETTOMIN	Sets to the minimum number	SETTOMAX	Sets to the maximum number	<NR1>	1~29000
SETTOMIN	Sets to the minimum number						
SETTOMAX	Sets to the maximum number						
<NR1>	1~29000						
Example1	:SEGMents:TOTAlnum SETTOMAX Sets the number of segments to max number (29000).						

:SEGMents:TIME

→ Query

Description	Returns the time of the current segment in relation to the first segment.
Syntax	:SEGMents:TIME?
Related commands	:SEGMents:STATE :SEGMents:CURRent
Return parameter	The segment time as <NR3>.
Example	:SEGMents:TIME? >8.040E-03 Returns the segment time.

:SEGMents:DISPALL

Set →

→ Query

Description	Sets or queries whether all the segments are displayed on the screen.
Syntax	:SEGMents:DISPALL {OFF ON ?}
Related commands	:SEGMents:STATE :SEGMents:CURRent
Parameter/ Return parameter	OFF Turns the display all function off. ON Turns the display all function on.
Example1	:SEGMents:DISPALL ON Turns the display all function on.

:SEGMents:MEASure:MODE

Set →

→ Query

Description	Sets or queries the measurement mode.
Syntax	:SEGMents:MEASure:MODE {OFF PLOT TABLE ?}
Related commands	:MEASurement:MEAS<x>

Parameter/ Return parameter	OFF	Disables the automatic measurement function for the segments measurement.
	PLOT	Sets the measurement mode to Statistics.
	TABLE	Sets the measurement mode to a measurement list.

Example :SEGMents:MEASure:MODE?>PLOT
Returns the measurement mode as Statistics.

:SEGMents:MEASure:PLOT:SOURce Set →
→ Query

Description	Sets or queries the statistics source.	
Syntax	:SEGMents:MEASure:PLOT:SOURce {<NR1> ? }	
Related commands	:SEGMents:MEASure:MODE :SEGMents:MEASure:PLOT:DIVide :SEGMents:MEASure:PLOT:SElect :SEGMents:MEASure:PLOT:RESults	

Parameter/ Return parameter	<NR1>	1~8 (Automatic measurement item 1~8)
--------------------------------	-------	--------------------------------------

Example1 :SEGMents:MEASure:PLOT:SOURce 1
Sets the source as auto measurement item 1.

:SEGMents:MEASure:PLOT:DIVide Set →
→ Query

Description	Sets or queries the number of bins for the statistics function.	
Syntax	:SEGMents:MEASure:PLOT:DIVide {<NR1> ? }	
Related commands	:SEGMents:MEASure:PLOT:SOURce :SEGMents:MEASure:PLOT:SElect	

Parameter/ Return parameter	<NR1>	1~20
--------------------------------	-------	------

Example1 :SEGMents:MEASure:PLOT:DIVide 5
Sets the number of bins to 5 for the statistics function.

:SEGMents:MEASure:PLOT:SElect (Set) →
← (Query)

Description Sets or queries which bin to view the statics of.

Syntax :SEGMents:MEASure:PLOT:SElect {<NR1> | ? }

Related commands :SEGMents:MEASure:PLOT:SOURce
:SEGMents:MEASure:PLOT:DIVide

Parameter	<NR1>	1~20 (cannot exceed the number of bins)
-----------	-------	--

Return parameter Return the bin number as <NR3>.

Example1 :SEGMents:MEASure:PLOT:SElect 5
Set to bin number 5.

:SEGMents:MEASure:PLOT:RESults ← (Query)

Description Returns the results of the currently selected bin for the statistics measurement.

Note At least one automatic measurement must be turned on.

Syntax :SEGMents:MEASure:PLOT:RESults?

Related commands :SEGMents:STATE
:SEGMents:MEASure:MODE PLOT
:SEGMents:MEASure:PLOT:SOURce
:SEGMents:MEASure:PLOT:DIVide
:SEGMents:MEASure:PLOT:SElect

Return parameter Returns the statistics measurements as a string.

Example :SEGMents:STATE ON
 STOP
 :SEGMents:MEASure:MODE PLOT
 :SEGMents:MEASure:PLOT:SOURce 1
 :SEGMents:MEASure:PLOT:DIVide 10
 :SEGMents:MEASure:PLOT:SElect 1
 :SEGMents:MEASure:PLOT:RESults?
 > MAX,1.000kHz;MIN,1.000kHz;MEAN,1.000kHz;
 Bin Statistics,1 of 10;Percent,10.00%;Count,1;
 Measured,10;Unmeasured,0;Bin Range,
 1.000kHz~1.000kHz;
 Plots the results for automatic measurement #1,
 bin 1 of 10.

:SEGMents:MEASure:TABLE:SOURce Set →
→ Query

Description Sets or queries the source of the measurement list.

Syntax :SEGMents:MEASure:TABLE:SOURce {CH1 | CH2 | CH3 | CH4 | ? }

Related commands :SEGMents:MEASure:MODE
 :SEGMents:MEASure:TABLE:SElect
 :SEGMents:MEASure:TABLE:LIST

Parameter/ Return parameter CH1~CH4 Channel 1 to 4

Example1 :SEGMents:MEASure:TABLE:SOURce CH1
 Sets the source to CH1.

:SEGMents:MEASure:TABLE:SElect Set →
→ Query

Description Sets or queries a segment to view in the measurement table.

Syntax :SEGMents:MEASure:TABLE:SElect {<NR1> | ? }

Related commands :SEGMents:TOTAlnum

Parameter <NR1> 1~29000

Return parameter Returns the number of segments as <NR3>.

Example1 :SEGMents:MEASure:TABLE:SElect 10
Select segment number 10.

:SEGMents:MEASure:TABLE:LIST → Query

Description Returns the measurement results of each segment in the list.

Syntax :SEGMents:MEASure:TABLE:LIST?

Return parameter Returns the measurements results as a string for each segment.

Example :SEGMents:MEASure:TABLE:LIST?
>"GW MDO-2074E, serial number PXXXXXX,
version V1.11",Segment Summary : CH1, Seg.,Pk-
Pk (V),Pk-Pk (V),1,8.00m,8.00m.....etc

:SEGMents:MEASure:TABLE:SAVE Set →

Description Saves the list of segment automatic measurement results.

Syntax :SEGMents:MEASure:TABLE:SAVE

:SEGMents:SAVE Set →

Description Saves the segments.

Syntax :SEGMents:SAVE

Related Commands :SEGMents:SAVE:SOURce
:SEGMents:SAVE:SElect:START
:SEGMents:SAVE:SElect:END

```
Example      :SEGMents:SAVe:SOURce CH1
              :SEGMents:SAVe:SElect:STARt 1
              :SEGMents:SAVe:SElect:END 10
              :SEGMents:SAVe
```

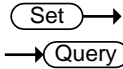

:SEGMents:SAVe:SOURce

Description Sets or queries the source segment waveform to save.

Syntax :SEGMents:SAVe:SOURce {CH1 | CH2 | CH3 | CH4 | D0 | D1 | D2 | D3 | D4 | D5 | D6 | D7 | D8 | D9 | D10 | D11 | D12 | D13 | D14 | D15 | ? }

Parameter/ Return parameter	CH1~CH4	Channel 1 to 4.
	D0~D15	Digital channels D0~D15

```
Example      :SEGMents:SAVe:SOURce CH1
              >Sets the source to CH1.
```

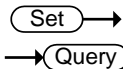

:SEGMents:SAVe:SElect:STARt

Description Sets or queries the starting segment to save from. The number of possible segments depends on the record length.

Syntax :SEGMents:SAVe:SElect:STARt {SETTOMIN | SETTOMAX | <NR1> | ? }

Related commands :SEGMents:TOTAlnum

Parameter/ Return parameter	SETTOMIN	Sets the starting segment to min segment.
	SETTOMAX	Sets the starting segment to the max segment.
	<NR1>	Sets the segment to 1~29000

Example :SEGMents:SAVe:SElect:STARt 2
 Sets the starting segment to segment number 2.

:SEGMents:SAVe:SElect:END

Description Sets or queries the ending segment to save from. The number of possible segments depends on the record length.

Syntax :SEGMents:SAVe:SElect:END
 {SETTOMIN | SETTOMAX | <NR1> | ? }

Related commands :SEGMents:TOTAlnum

Parameter/ Return parameter	SETTOMIN	Sets the starting segment to min segment.
	SETTOMAX	Sets the starting segment to the max segment.
	<NR1>	Sets the segment to 1~29000.
Return parameter	<NR3>	Returns the ending segment as NR3.

Example :SEGMents:SAVe:SElect:END 10
 Sets the ending segment to segment number 10.

DVM Commands

The DVM commands are only available when the optional DVM software is installed.

:DVM:STATE	238
:DVM:SOURce	238
:DVM:MODE	239
:DVM:VALue	239

:DVM:STATE

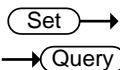

Description	Sets or queries the DVM state to on or off.	
Syntax	:DVM:STATE {OFF ON ? }	
Related commands	:DVM:SOURce :DVM:MODE	
Parameter/ Return parameter	OFF	Turns the DVM off.
	ON	Turns the DVM on.
Example	:DVM:STATE ON Turns the DVM state on.	

:DVM:SOURce

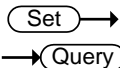

Description	Sets or queries the source of the DVM.	
Syntax	:DVM:SOURce {CH1 CH2 CH3 CH4 ?}	
Related commands	:DVM:STATE :DVM:MODE	
Parameter/ Return parameter	CH1~CH4	Channel 1 to 4.
Example	:DVM:SOURce CH1 Sets the DVM source to channel 1.	

Set → → Query											
:DVM:MODE											
Description	Sets or queries the DVM mode.										
Syntax	:DVM:MODE {ACRMS DC DCRMS DUTY FREQUENCY ?}										
Related commands	:DVM:SOURce :DVM:STATE										
Parameter/ Return parameter	<table border="0"> <tr> <td style="background-color: #e0e0e0;">ACRMS</td> <td>Sets the mode to AC RMS</td> </tr> <tr> <td style="background-color: #e0e0e0;">DC</td> <td>Sets the mode to DC</td> </tr> <tr> <td style="background-color: #e0e0e0;">DCRMS</td> <td>Sets the mode to DC RMS</td> </tr> <tr> <td style="background-color: #e0e0e0;">DUTY</td> <td>Sets the mode to AC Duty</td> </tr> <tr> <td style="background-color: #e0e0e0;">FREQUENCY</td> <td>Sets the mode to AC frequency</td> </tr> </table>	ACRMS	Sets the mode to AC RMS	DC	Sets the mode to DC	DCRMS	Sets the mode to DC RMS	DUTY	Sets the mode to AC Duty	FREQUENCY	Sets the mode to AC frequency
ACRMS	Sets the mode to AC RMS										
DC	Sets the mode to DC										
DCRMS	Sets the mode to DC RMS										
DUTY	Sets the mode to AC Duty										
FREQUENCY	Sets the mode to AC frequency										
Example	:DVM:MODE DUTY Sets the DVM mode to DUTY.										

→ Query	
:DVM:VALue	
Description	Returns the measurement value of the selected mode.
Syntax	:DVM:VALue?
Related commands	:DVM:SOURce :DVM:STATE :DVD:MODE
Return parameter	Returns the measurement value as <NR3>.
Example	:DVM:VALue? >8.410E-04 Returns the measurement.

Go_NoGo Commands

The GoNoGo APP must first be launched (or use the command, “:GONogo:SCRipt”) before any of the Go_NoGo or Template commands can be used.

:GONogo:CLear.....	240
:GONogo:EXECute	240
:GONogo:FUNCTion.....	241
:GONogo:NGCount	241
:GONogo:NGDefine.....	241
:GONogo:SOURce	242
:GONogo:VIOLation	242
:GONogo:SCRipt	242
:TEMPlate:MODE	243
:TEMPlate:MAXimum.....	243
:TEMPlate:MINimum.....	243
:TEMPlate:POSition:MAXimum.....	244
:TEMPlate:POSition:MINimum	244
:TEMPlate:SAVe:MAXimum	244
:TEMPlate:SAVe:MINimum	245
:TEMPlate:TOLerance.....	245
:TEMPlate:SAVe:AUTo	245

:GONogo:CLear

Set →

Description Clears the Go/NoGo counter.

Syntax :GONogo:CLear

:GONogo:EXECute

Set →
→ Query

Description Enables or disables the Go/NoGo function or queries its state.

Syntax :GONogo:EXECute {OFF|ON|?}

Parameter/	OFF	Disabled
Return Parameter	ON	Enabled

Example :GONogo:EXECute OFF
Turns Go/NoGo off.

:GONogo:FUNction (Set) →

Description Initializes the Go/NoGo APP. This must be run after the Go/NoGo APP has been started.

Syntax :GONogo:FUNCTION

:GONogo:NGCount → (Query)

Description Returns the Go/NoGo counter.

Syntax :GONogo:NGCount{?}

Return parameter Returns a string in the following format “number of violations,total tests”

Example :GONogo:NGCount?
> 3,25
Indicates that 3 violations occurred over 25 tests.

:GONogo:NGDefine (Set) →
→ (Query)

Description Sets the Go/NoGo “When” conditions.

Syntax :GONogo:NGDefine {EXITs|ENTers{?}}

Parameter/	EXITs	Sets the NoGo condition to when the input signal exceeds the limit boundary.
Return Parameter	ENTers	Sets the NoGo condition to when the input signal stays within the limit boundary.

Example :GONogo:NGDefine EXITs
Sets the Go/NoGo condition to EXITs.

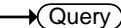
 →
 → 

:GONogo:SOURce	
Description	Sets the source for the Go/NoGo signal.
Syntax	:GONogo:SOURce {CH1 CH2 CH3 CH4 ?}
Parameter/ Return Parameter	CH1~CH4
Example	:GONogo:SOURce CH1 Sets the source to CH1.

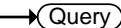
 →
 → 

:GONogo:VIOLation	
Description	Sets or returns actions for the Go/NoGo violations.
Syntax	:GONogo:VIOLation {STOP CONTInue ?}
Parameter/ Return Parameter	STOP The waveform will be frozen. CONTInue Ignore the violation.
Example	:GONogo:VIOLation STOP Sets violation action to STOP.

 →

:GONogo:SCRipt	
Description	Activates/Deactivates the Go/NoGo APP or queries its state.
Syntax	:GONogo:SCRipt {OFF ON ?}
Parameter/ Return Parameter	ON Turns Go/NoGo APP on. OFF Turns the Go/NoGo APP off.
Example	:GONogo:SCRipt? >ON The Go/NoGo script is on.

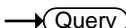
		
		
<hr/>		
:TEMPlate:MODE		
Description	Sets or returns the Go/NoGo template mode.	
Syntax	:TEMPlate:MODE {MAXimum MINimum AUTO ?}	
Parameter/ Return Parameter	MAXimum	Maximum template
	MINimum	Minimum template
	AUTO	Auto template
Example	:TEMPlate:MODE AUTO Sets the template mode to AUTO.	

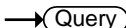
		
		
<hr/>		
:TEMPlate:MAXimum		
Description	Defines or queries which waveform memory (REF1 or W1~W20) is set to the maximum template.	
Syntax	:TEMPlate:MAXimum {REF1 W1~W20 ?}	
Parameter/ Return Parameter	REF1	Reference one
	W1~W20	Waveform memory 1 to 20
Example	:TEMPlate:MAXimum REF1 Saves the maximum template to REF1.	

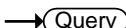
		
		
<hr/>		
:TEMPlate:MINimum		
Description	Defines or queries which waveform memory (REF1 or W1~W20) is set to the minimum template.	
Syntax	:TEMPlate:MINimum {REF2 W1~W20 ?}	
Parameter/ Return Parameter	REF2	Reference one
	W1~W20	Waveform memory 1 to 20
Example	:TEMPlate:MINimum REF2 Saves the minimum template to REF2.	

:TEMPlate:POSition:MAXimum



Description	Sets or queries the position of the maximum template.	
Syntax	:TEMPlate:POSition:MAXimum {<NR2> ?}	
Parameter	<NR2>	Desired template position (-12.0 ~ +12.0 divisions)
Return parameter	Returns the position in the following format: “<NR2>Div”	
Example	:TEMPlate:POSition:MAXimum 3.00 Sets the maximum template position to 3.00 divisions.	

:TEMPlate:POSition:MINimum



Description	Sets or queries the position of the minimum template.	
Syntax	:TEMPlate:POSition:MINimum {<NR2> ?}	
Parameter	<NR2>	Desired template position (-12.0 ~ +12.0 divisions)
Return parameter	Returns the position in the following format: “<NR2>Div”	
Example	:TEMPlate:POSition:MINimum 3.00 Sets the minimum template position to 3.00 divisions.	

:TEMPlate:SAVE:MAXimum 

Description	Saves the maximum template.	
Syntax	:TEMPlate:SAVE:MAXimum	

:TEMPlate:SAVe:MINimum (Set) →

Description Saves the maximum template.

Syntax :TEMPlate:SAVe:MINimum

(Set) →

:TEMPlate:TOLerance

→ (Query)

Description Sets or queries the tolerance as a percentage.

Syntax :TEMPlate:TOLerance {<NR2>|?}

Parameter/ Return Parameter	<NR2>	The auto tolerance range (0.4% ~ 40%)
--------------------------------	-------	---------------------------------------

Example :TEMPlate:TOLerance 10
 Sets the tolerance to 10%.

:TEMPlate:SAVe:AUTO (Set) →

Description Saves the AUTO template (maximum and minimum templates).

Syntax :TEMPlate:SAVe:AUTO

AWG Commands

The Arbitrary Wave Generator is available on the MDO-2000EX only.

:AWG<x>:AMPlitude.....	247
:AWG<x>:FREQUency.....	247
:AWG<x>:FUNCTion	248
:AWG<x>:OFFSet	249
:AWG<x>:OUTPut:LOAd:IMPEDance	249
:AWG<x>:OUTPut:STATE	249
:AWG<x>:PHAsE.....	250
:AWG<x>:PULSe:DUTYcycle	250
:AWG<x>:RAMP:SYMmetry	250
:AWG<x>:MODulation:STATE	251
:AWG<x>:MODulation:TYPe.....	251
:AWG<x>:MODulation:AM:DEPth	251
:AWG<x>:MODulation:AM:FREQ.....	252
:AWG<x>:MODulation:AM:SHApe.....	252
:AWG<x>:MODulation:AM:PHAsE	252
:AWG<x>:MODulation:AM:DUTYcycle	253
:AWG<x>:MODulation:AM:SYMmetry	253
:AWG<x>:MODulation:AM:RATE	253
:AWG<x>:MODulation:FM:DEV	254
:AWG<x>:MODulation:FM:FREQ	254
:AWG<x>:MODulation:FM:SHApe	255
:AWG<x>:MODulation:FM:PHAsE	255
:AWG<x>:MODulation:FM:DUTYcycle.....	256
:AWG<x>:MODulation:FM:SYMmetry	256
:AWG<x>:MODulation:FM:RATE.....	256
:AWG<x>:MODulation:FSK:FREQ	257
:AWG<x>:MODulation:FSK:RATE.....	257
:AWG<x>:SWEep:STATE	258
:AWG<x>:SWEep:TYPe	258
:AWG<x>:SWEep:START	258
:AWG<x>:SWEep:STOP.....	259

:AWG<x>:SWEep:TIme.....259
 :AWG<x>:SWEep:SPAN.....259
 :AWG<x>:SWEep:CENTer260
 :AWG<x>:ARBitrary:EDIT:NUMPoint260
 :AWG<x>:ARBitrary:EDIT:FUNCTion.....260
 :AWG<x>:ARBitrary:SAVe:WAVEform261
 :AWG<x>:ARBitrary:LOAd:WAVEform261
 :AWG<x>:ARBitrary:EDIT:COpy.....262
 :AWG<x>:ARBitrary:EDIT:CLEar.....262
 :AWG<x>:ARBitrary:EDIT:LINE263
 :AWG<x>:ARBitrary:EDIT:SCALE.....263
 :AWG<x>:ARBitrary:EDIT:POINt.....263
 :AWG<x>:ARBitrary:EDIT:POINt:ADD.....264
 :AWG<x>:ARBitrary:EDIT:POINt:DELEte.....264

:AWG<x>:AMPlitude

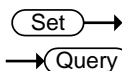

Description	Sets or returns the waveform amplitude.	
Syntax	:AWG<x>:AMPlitude {<NRf> ?}	
Related command	:AWG<x>:OUTPut:LOAd:IMPEDance	
Parameter/ Return parameter	<x> <NRf>	Channel number 1~2. Amplitude in Volts. (50Ω impedance 0.1~2.5V) (High Z impedance 0.2~5V)
Example	:AWG1:AMP 1	

:AWG<x>:FREQuency

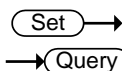

Description	Sets or returns the waveform frequency.	
Syntax	:AWG<x>:FREQuency {<NRf> ?}	

Parameter/	<x>	Channel number 1~2.
Return parameter	<NRf>	Frequency in Hertz.

Example :AWG1:FREQ 2000

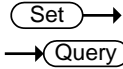

:AWG<x>:FUNCTion

Description Sets or returns the type of waveform.

Syntax :AWG<x>:FUNCTion {ARBitrary | SINE | SQUAre | PULSe | RAMP | DC | NOISe | SINC | GAUSSian | LORENTz | EXPRise | EXPFall | HAVERSINe | CARDIac | ?}

Parameter/	<x>	Channel number 1~2.
Return parameter	ARBitrary	Arbitrary waveform
	SINE	Sine waveform
	SQUAre	Square waveform
	PULSe	Pulse waveform
	RAMP	Ramp waveform
	DC	DC waveform
	NOISe	Noise waveform
	SINC	Sinc waveform
	GAUSSian	Gaussian waveform
	LORENTz	Lorentz waveform
	EXPRise	Exponential rise waveform
	EXPFall	Exponential fall waveform
	HAVERSINe	Haversine waveform
	CARDIac	Cardiac waveform

Example :AWG1:FUNC?
>SINE

 →
 → 

:AWG<x>:OFFSet

Description	Sets or returns the waveform offset.	
Syntax	:AWG<x>:OFFSet {<NRf> ?}	
Parameter/ Return parameter	<x>	Channel number 1~2.
	<NRf>	Offset in Volts.
Example	:AWG1:OFFS	

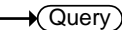
 →
 → 

:AWG<x>:OUTPut:LOAD:IMPEDance

Description	Sets or returns the output termination	
Syntax	:AWG<x>:OUTPut:LOAD:IMPEDance {FIFTy HIGHZ ?}	
Parameter/ Return parameter	<x>	Channel number 1~2
	FIFTy	50 Ohm output termination
	HIGHZ	High Z output termination
Example	:AWG1:OUTP:LOA:IMPED HIGHZ Sets the output termination of channel 1 to high impedance.	

 →
 → 

:AWG<x>:OUTPut:STATE

Description	Sets or returns the channel output state.	
Syntax	:AWG<x>:OUTPut:STATE {OFF ON ?}	
Parameter/ Return parameter	<x>	Channel number 1~2
	OFF	Turns the channel output off
	ON	Turns the channel output on
Example	:AWG1:OUTP:STATE OFF Turns the channel 1 output off.	

:AWG<x>:PHAsE (Set) →
→ (Query)

Description	Sets or returns the channel phase.	
Syntax	:AWG<x>:PHAsE {<NRf> ?}	
Parameter/ Return parameter	<x> <NRf>	Channel number 1~2. Phase in degree -180~180°
Example	:AWG1:PHA 45 Sets the channel 1 phase to 45°.	

:AWG<x>:PULSe:DUTYcycle (Set) →
→ (Query)

Description	Sets or returns the pulse duty cycle.	
Syntax	:AWG<x>:PULSe:DUTYcycle {<NRf> ?}	
Parameter/ Return parameter	<x> <NRf>	Channel number 1~2. Duty cycle in percentage 0.2~99.8%
Example	:AWG1:PULS:DUTY 50 Sets the channel 1 pulse duty cycle to 50%.	

:AWG<x>:RAMP:SYMmetry (Set) →
→ (Query)

Description	Sets or returns the ramp symmetry.	
Syntax	:AWG<x>:RAMP:SYMmetry {<NRf> ?}	
Parameter/ Return parameter	<x> <NRf>	Channel number 1~2. Symmetry of the ramp waveform 0~100%
Example	:AWG1:RAMP:SYM 15 Sets the channel 1 ramp symmetry to 15%.	

Set →
 → Query

:AWG<x>:MODulation:STATE

Description	Sets or returns the modulation state.	
Syntax	:AWG<x>:MODulation:STATE {OFF ON ?}	
Parameter/ Return parameter	<x>	Channel number 1~2.
	OFF	Sets the modulation to off.
	ON	Sets the modulation to on.
Example	:AWG1:MOD:STATE ON Turns the modulation on for channel 1.	

Set →
 → Query

:AWG<x>:MODulation:TYPE

Description	Sets or returns the type of modulation.	
Syntax	:AWG<x>MODulation:TYPE {AM FM FSK ?}	
Parameter/ Return parameter	<x>	Channel number 1~2.
	AM	Sets a AM modulation.
	FM	Sets a FM modulation.
	FSK	Sets a FSK modulation.
Example	:AWG1:MOD:TYPE AM Sets a AM modulation for channel 1.	

Set →
 → Query

:AWG<x>:MODulation:AM:DEPth

Description	Sets or returns the AM modulation depth.	
Syntax	:AWG<x>:MODulation:AM:DEPth {<NRf> ?}	
Parameter/ Return parameter	<x>	Channel number 1~2.
	<NRf>	AM depth in percentage 0~120%.
Example	:AWG1:MOD:AM:DEP? >1.20000e+02	

:AWG<x>:MODulation:AM:FREQ (Set) →
→ (Query)

Description	Sets or returns the AM modulation frequency.	
Syntax	:AWG<x>:MODulation:AM:FREQ {<NRF> ?}	
Parameter/ Return parameter	<x>	Channel number 1~2.
	<NRF>	AM frequency in Hertz.
Example	:AWG1:MOD:AM:FREQ 1000 Sets the AM frequency to 1kHz.	

:AWG<x>:MODulation:AM:SHApe (Set) →
→ (Query)

Description	Sets or returns the shape of the AM modulation.	
Syntax	:AWG<x>:MODulation:AM:SHApe {SINE SQUare PULSe RAMP NOISe ?}	
Parameter/ Return parameter	<x>	Channel number 1~2.
	SINE	Sine wave shape.
	SQUare	Square wave shape.
	PULSe	Pulse wave shape.
	RAMP	Ramp wave shape.
	NOISe	Noise wave shape.
Example	:AWG1:MOD:AM:SHA RAMP Sets a ramp shape to the AM modulating waveform.	

:AWG<x>:MODulation:AM:PHase (Set) →
→ (Query)

Description	Sets or returns the phase of the AM modulation (sine wave shape only).	
Syntax	:AWG<x>:MODulation:AM:PHase {<NRF> ?}	
Parameter/	<x>	Channel number 1~2.

Return parameter <NRf> Phase in degree -180~180°.

Example :AWG1:MOD:AM:PHA?
>-1.80000e+02

:AWG<x>:MODulation:AM:DUTYcycle Set →
→ Query

Description Sets or returns the duty cycle of the AM modulation (pulse wave shape only).

Syntax :AWG<x>:MODulation:AM:DUTYcycle {<NRf> | ?}

Parameter/
Return parameter <x> Channel number 1~2.
<NRf> Duty cycle in percentage 2~98%.

Example :AWG1:MOD:AM:DUTY 50
Sets the duty cycle of the AM modulating waveform to 50%.

:AWG<x>:MODulation:AM:SYMMetry Set →
→ Query

Description Sets or returns the symmetry of the AM modulation (ramp wave shape only).

Syntax :AWG<x>:MODulation:AM:SYMMetry {<NRf> | ?}

Parameter/
Return parameter <x> Channel number 1~2.
<NRf> Symmetry in percentage 0~100%.

Example :AWG1:MOD:AM:SYM 50
Sets the symmetry of the AM modulating waveform to 50%.

:AWG<x>:MODulation:AM:RATE Set →
→ Query

Description Sets or returns the rate of the AM modulation (noise wave shape only).

Syntax :AWG<x>:MODulation:AM:RATE {RATE10M | RATE5M | RATE1M | RATE500K | RATE100K | RATE50K | RATE10K | RATE5K | RATE1K | ?}

Parameter/	<x>	Channel number 1~2.
Return parameter	RATE10M	10MHz noise rate.
	RATE5M	5MHz noise rate.
	RATE1M	1MHz noise rate.
	RATE500K	500kHz noise rate.
	RATE100K	100kHz noise rate.
	RATE50K	50kHz noise rate.
	RATE10K	10kHz noise rate.
	RATE5K	5kHz noise rate.
	RATE1K	1kHz noise rate.

Example :AWG1:MOD:AM:RATE RATE5K
 Sets the noise rate of the AM modulating waveform to 5kHz.

Set →
 → Query

Description Sets or returns the deviation of the FM modulation.

Syntax :AWG<x>:MODulation:FM:DEV {<NRf> | ?}

Parameter/	<x>	Channel number 1~2.
Return parameter	<NRf>	Frequency deviation in Hertz.

Example :AWG1:MOD:FM:DEV?
 >2.000000000e+02

Set →
 → Query

Description Sets or returns the frequency of the FM modulation.

Syntax :AWG<x>:MODulation:FM:FREQ {<NRf> | ?}

Parameter/	<x>	Channel number 1~2.
Return parameter	<NRf>	Frequency in Hertz.

Example :AWG1:MOD:FM:FREQ 1000
 Sets the frequency of the FM modulating waveform to 1kHz.

Set →

:AWG<x>:MODulation:FM:SHApe

→ Query

Description Sets or returns the shape of the FM modulation.

Syntax :AWG<x>:MODulation:FM:SHApe {SINE | SQUare | PULSe | RAMP | NOISe | ?}

Parameter/ Return parameter	<x>	Channel number 1~2.
	SINE	Sine wave shape.
	SQUare	Square wave shape.
	PULSe	Pulse wave shape.
	RAMP	Ramp wave shape.
	NOISe	Noise wave shape.

Example :AWG1:MOD:FM:SHA SINE
 Sets a sine shape to the FM modulation.

Set →

:AWG<x>:MODulation:FM:PHAsE

→ Query

Description Sets or returns the phase of the FM modulation (sine wave shape only).

Syntax :AWG<x>:MODulation:FM:PHAsE {<NRf> | ?}

Parameter/ Return parameter	<x>	Channel number 1~2.
	<NRf>	Phase in degree -180~180°.

Example :AWG1:MOD:FM:PHA 90
 Sets a 90° phase to the FM modulating waveform.

:AWG<x>:MODulation:FM:DUTYcycle (Set) →
→ (Query)

Description	Sets or returns the duty cycle of the FM modulation (pulse shape wave only).	
Syntax	:AWG<x>:MODulation:FM:DUTYcycle {<NRf> ?}	
Parameter/ Return parameter	<x>	Channel number 1~2.
	<NRf>	Duty cycle in percentage 1~99%.
Example	:AWG1:MOD:FM:DUTY 50 Sets the duty cycle of the FM modulating waveform to 50%.	

:AWG<x>:MODulation:FM:SYMmetry (Set) →
→ (Query)

Description	Sets or returns the symmetry of the FM modulation (ramp shape wave only).	
Syntax	:AWG<x>:MODulation:FM:SYMmetry {<NRf> ?}	
Parameter/ Return parameter	<x>	Channel number 1~2.
	<NRf>	Symmetry in percentage 0~100%.
Example	:AWG1:MOD:FM:SYM 50 Sets the symmetry of the FM modulating waveform to 50%.	

:AWG<x>:MODulation:FM:RATE (Set) →
→ (Query)

Description	Sets or returns the noise rate of the FM modulation (noise shape wave only).	
Syntax	:AWG<x>:MODulation:FM:RATE {RATE10M RATE5M RATE1M RATE500K RATE100K RATE50K RATE10K RATE5K RATE1K ?}	
Parameter/ Return parameter	<x>	Channel number 1~2.
	RATE10M	10MHz noise rate.

RATE5M	5MHz noise rate.
RATE1M	1MHz noise rate.
RATE500K	500kHz noise rate.
RATE100K	100kHz noise rate.
RATE50K	50kHz noise rate.
RATE10K	10kHz noise rate.
RATE5K	5kHz noise rate.
RATE1K	1kHz noise rate.

Example :AWG1:MOD:FM:RATE RATE5K
 Sets the noise rate of the FM modulating waveform to 5kHz.

:AWG<x>:MODulation:FSK:FREQ Set →
→ Query

Description Sets or returns the hop frequency of the FSK modulation.

Syntax :AWG<x>:MODulation:FSK:FREQ {<NRF> | ?}

Parameter/	<x>	Channel number 1~2.
Return parameter	<NRF>	Frequency in Hertz.

Example :AWG1:MOD:FSK:FREQ 2000000
 Sets the FSK hop frequency to 2MHz.

:AWG<x>:MODulation:FSK:RATE Set →
→ Query

Description Sets or returns the FSK modulation rate.

Syntax :AWG<x>:MODulation:FSK:RATE {<NRF> | ?}

Parameter/	<x>	Channel number 1~2.
Return parameter	<NRF>	Frequency in Hertz.

Example :AWG1:MOD:FSK:RATE 100000
 Sets the FSK rate to 100kHz.

Set →
 → Query

:AWG<x>:SWEep:STATE

Description	Sets or returns the Sweep mode state.	
Syntax	:AWG<x>:SWEep:STATE {OFF ON ?}	
Parameter/ Return parameter	<x>	Channel number 1~2.
	OFF	Sets the sweep mode to off.
	ON	Sets the sweep mode to on.
Example	:AWG1:SWE:STATE ON Turns the sweep mode to on for channel 1.	

Set →
 → Query

:AWG<x>:SWEep:TYPe

Description	Sets or returns the sweep mode type.	
Syntax	:AWG<x>:SWEep:TYPe {LINEAR LOG ?}	
Parameter/ Return parameter	<x>	Channel number 1~2.
	LINEAR	Sets the sweep mode to linear.
	LOG	Sets the sweep mode to logarithmic.
Example	:AWG1:SWE:TYP LIN Sets the sweep mode to linear for channel 1.	

Set →
 → Query

:AWG<x>:SWEep:START

Description	Sets or returns the start frequency of the sweep mode.	
Syntax	:AWG<x>:SWEep:START {<NRf> ?}	
Parameter/ Return parameter	<x>	Channel number 1~2.
	<NRf>	Start frequency in Hertz.
Example	:AWG1:SWE:START 1000 Sets the sweep mode start frequency to 1kHz.	

:AWG<x>:SWEep:STOP

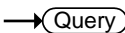
Description Sets or returns the stop frequency of the sweep mode.

Syntax :AWG<x>:SWEep:STOP {<NRf> | ?}

Parameter/ Return parameter	<x>	Channel number 1~2.
	<NRf>	Stop frequency in Hertz.

Example :AWG1:SWE:STOP 500000
Sets the sweep mode stop frequency to 500kHz.

:AWG<x>:SWEep:TIME





Description Sets or returns the sweep time.

Syntax :AWG<x>:SWEep:TIME {<NRf> | ?}

Parameter/ Return parameter	<x>	Channel number 1~2.
	<NRf>	Sweep time in seconds.

Example :AWG1:SWE:TIM 6.500e-01
Sets the sweep time to 650ms.

:AWG<x>:SWEep:SPAN

Description Alternatively to setting the start and stop frequencies, the span and center frequency can be set.

Syntax :AWG<x>:SWEep:SPAN {<NRf> | ?}

Parameter/ Return parameter	<x>	Channel number 1~2.
	<NRf>	Span of the sweep in Hertz.

Example :AWG1:SWE:SPAN 1100
Sets the span of the sweep to 1.1kHz.

Set →
 → Query

:AWG<x>:SWEep:CENTer

Description Alternatively to setting the start and stop frequencies, the span and center frequency can be set.

Syntax :AWG<x>:SWEep:CENTer {<NRF> | ?}

Parameter/	<x>	Channel number 1~2.
Return parameter	<NRF>	Center frequency of the sweep in Hertz.

Example :AWG1:SWE:CENT 550
 Sets the center frequency of the sweep to 550Hz.

Set →
 → Query

:AWG<x>:ARBitrary:EDIT:NUMPoint

Description Sets or returns the number of points of an arbitrary waveform.

Syntax :AWG<x>:ARBitrary:EDIT:NUMPoint { <NR1> | ?}

Parameter/	<x>	Channel number 1~2.
Return parameter	<NR1>	Number of points

Example :AWG1:ARB:EDIT:NUMP 1500
 Sets 1500 points for the arbitrary waveform.

Set →

:AWG<x>:ARBitrary:EDIT:FUNction

Description Sets the inbuilt waveform of the arbitrary waveform.

Syntax :AWG<x>:ARBitrary:EDIT:FUNction { SINE | SQUARE | PULSE | RAMP | NOISE }

Parameter	<x>	Channel number 1~2.
	SINE	Sine wave shape.
	SQUARE	Square wave shape.
	PULSE	Pulse wave shape.

RAMP	Ramp wave shape.
NOISE	Noise wave shape.

Example :AWG1:ARB:EDIT:FUNCT RAMP
Sets a ramp shape to the arbitrary waveform.

:AWG<x>:ARbitrary:SAVe:WAVEform Set →

Description	Saves an arbitrary waveform.	
Syntax	:AWG<x>:ARbitrary:SAVe:WAVEform {ARB1 ARB2 ARB3 ARB4 <file path>}	
Parameter	<x>	Channel number 1~2.
	ARB1~4	Saves the arbitrary waveform to one of the internal memory slots.
	<file path>	Saves the arbitrary waveform to disk or USB to the specified file path. Example: "Disk:/xxx.UAW" "USB:/xxx.UAW"

Example :AWG1:ARB:SAVE:WAVE ARB2
Saves the arbitrary waveform to ARB2.

:AWG<x>:ARbitrary:LOAd:WAVEform Set →

Description	Loads an arbitrary waveform.	
Syntax	:AWG<x>:ARbitrary:LOAd:WAVEform {ARB1 ARB2 ARB3 ARB4 <file path>}	
Parameter	<x>	Channel number 1~2.
	ARB1~4	Loads the arbitrary waveform from one of the internal memory slots.
	<file path>	Loads the arbitrary waveform from disk or USB at the specified file path. Example: "Disk:/xxx.UAW" "USB:/xxx.UAW"

Example :AWG1:ARB:LOA:WAVE ARB2
 Loads the arbitrary waveform from ARB2.

:AWG<x>:ARBitrary:EDIT:COpy (Set) →

Description Copies a segment of an arbitrary waveform to a specific point.

Syntax :AWG<x>:ARBitrary:EDIT:COpy {<START> , <LENGth> , <PASTe>}

Parameter	<x>	Channel number 1~2.
	<START>	NR1, point at which the segment to copy starts.
	<LENGth>	NR1, length of the segment to copy.
	<PASTe>	NR1, point at which the segment is to be copied.

Example :AWG1:ARB:EDIT:COpy 5,100,106
 Copies a segment of 100 points starting from point 5 of an arbitrary waveform and paste it to point 106 of this arbitrary waveform.

:AWG<x>:ARBitrary:EDIT:CLEar (Set) →

Description Deletes a segment of an arbitrary waveform

Syntax :AWG<x>:ARBitrary:EDIT:CLEar { ALL | <START> , <LENGth>}

Parameter	<x>	Channel number 1~2.
	ALL	Deletes the entire arbitrary waveform.
	<START>	NR1, point at which the segment to delete starts.
	<LENGth>	NR1, length of the segment to delete.

Example :AWG1:ARB:EDIT:CLE ALL

:AWG<x>:ARbitrary:EDIT:LINE (Set) →

Description	Creates a line on an arbitrary waveform.	
Syntax	:AWG<x>:ARbitrary:EDIT:LINE {<address1> , <data1> , address2> , <data2>}	
Parameter	<x>	Channel number 1~2.
	<address1>	NR1, the point at which the line starts.
	<data1>	NRf, the value at the starting point.
	<address2>	NR1, the point at which the line ends.
	<data2>	NRf, the value at the ending point.
Example	:AWG1:ARB:EDIT:LIN 40,0.05,100,0.1 Creates a line between point 40 at value 0.05 and point 100 at value 0.01.	

:AWG<x>:ARbitrary:EDIT:SCALE (Set) →

Description	Sets the vertical scale of the arbitrary waveform.	
Syntax	:AWG<x>:ARbitrary:EDIT:SCALE {<NRf>}	
Parameter	<x>	Channel number 1~2.
	<NRf>	Scale 0.1~ 10
Example	:AWG1:ARB:EDIT:SCAL 5.5	

:AWG<x>:ARbitrary:EDIT:POINT (Set) →

Description	Edits a single point on an arbitrary waveform.	
Syntax	:AWG<x>:ARbitrary:EDIT:POINT {<address1> , <data1>}	
Parameter	<x>	Channel number 1~2.
	<address1>	NR1, the point to be edited.
	<data1>	NRf, the value of that point.

Example :AWG1:ARB:EDIT:POIN 20,0.2

:AWG<x>:ARBitrary:EDIT:POINt:ADD 

Description Adds the edited point to the arbitrary waveform.

Syntax :AWG<x>:ARBitrary:EDIT:POINt:ADD {<NR1>}

Parameter	<x>	Channel number 1~2.
	<NR1>	The point to be added.

Example :AWG1:ARB:EDIT:POIN:ADD 20

:AWG<x>:ARBitrary:EDIT:POINt:DELEte 

Description Adds the edited point to the arbitrary waveform.

Syntax :AWG<x>:ARBitrary:EDIT:POINt:DELEte {<NR1>}

Parameter	<x>	Channel number 1~2.
	<NR1>	The point to be deleted.

Example :AWG1:ARB:EDIT:POIN:DELE 20

Data Logging Commands

:DATALOG:STATE	265
:DATALOG:SOURce	265
:DATALOG:SAVe	266
:DATALOG:INTerval	266
:DATALOG:DURation	267

:DATALOG:STATE



Description Sets or queries the state of the data logging app.

Syntax :DATALOG:STATE {OFF|ON|?}

Related commands

- :DATALOG:SOURce
- :DATALOG:SAVe
- :DATALOG:INTerval
- :DATALOG:DURation

Parameter/Return parameter	OFF	Turns the data logging off.
	ON	Turns the data logging on.

Example :DATALOG:STATE ON
Turns the data logging app on.

:DATALOG:SOURce



Description Sets or queries the data logging source channel.

Syntax :DATALOG:SOURce { CH1~CH4 | D0~D15 | all | ? }

Related commands

- :DATALOG:STATE
- :DATALOG:SAVe
- :DATALOG:INTerval
- :DATALOG:DURation

Parameter/Return CH1 ~CH4 Channel 1, 2, 3 or 4

parameter	D0~D15	Digital channels D0~D15
	all	All displayed channels.

Example :DATALOG:SOURce CH1
Sets the source to CH1.

Set →

→ Query

:DATALOG:SAVE

Description Sets or queries the save format as image or waveform.

Syntax :DATALOG:SAVE {IMAGE|WAVEform|?}

Related commands :DATALOG:STATE
:DATALOG:SOURce
:DATALOG:INTerval
:DATALOG:DURation

Parameter/Return parameter	IMAGE	Save as images.
	WAVEform	Save as waveforms.

Example :DATALOG:SAVE WAVEform
Sets the save format to waveform.

Set →

→ Query

:DATALOG:INTerval

Description Sets or queries the interval time between each recording.

Syntax :DATALOG:INTerval <NRf>
:DATALOG:INTerval?

Related commands :DATALOG:STATE
:DATALOG:SOURce
:DATALOG:SAVE
:DATALOG:DURation

Parameter/Return parameter <NRF> Discrete time intervals in seconds:

Example :DATALOG:INT 2
Sets the interval time to 2 seconds.

:DATALOG:DURation

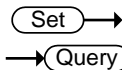

Description Sets or queries the duration time of each recording.

Syntax :DATALOG:DURation <NRF>
:DATALOG:DURation?

Related commands :DATALOG:STATE
:DATALOG:SOURce
:DATALOG:SAVe
:DATALOG:INTerval

Parameter/Return parameter <NRF> Discrete recording time in seconds.

Example :DATALOG:DUR 5
Sets the recording time to 5 seconds.

Remote Disk Commands

:REMOTEDisk:IPADdress	268
:REMOTEDisk:PATHName	268
:REMOTEDisk:USERName	269
:REMOTEDisk:PASSWord	269
:REMOTEDisk:MOUNT	269
:REMOTEDisk:AUTOMount	270

:REMOTEDisk:IPADdress
 Set →
 → Query

Description	Sets or returns the IP address of remote disk.	
Syntax	:REMOTEDisk:IPADdress {<string> ?}	
Parameter/ Return parameter	<string>	IP address enclosed in double quotes. Eg., 172.16.20.255
Example	:REMOTEDisk:IPADdress "172.16.20.255" Sets the remote disk IP address as 172.16.20.255.	

:REMOTEDisk:PATHName
 Set →
 → Query

Description	Sets or returns the file path of the remote disk.	
Syntax	:REMOTEDisk:PATHName {<string> ?}	
Parameter/ Return parameter	<string>	File path in enclosed in double quotes eg., "remote_disk"
Example	:REMOTEDisk:PATHName "remote_disk" Sets the file path to c:/remote_disk.	

Set →
 → Query

:REMOTEDisk:USERName

Description Sets or queries the account username for the remote disk.

Syntax :REMOTEDisk:USERName {<string> | ? }

Parameter/Return parameter <string> User name enclosed in double quotes eg., "User_Name".

Example :REMOTEDisk:USERName "User_Name"
 Sets the account name as User_Name.

Set →
 → Query

:REMOTEDisk:PASSWORD

Description Sets or queries the account password for the remote disk.

Syntax :REMOTEDisk:PASSWORD {<string> | ? }

Parameter/Return parameter <string> Username password enclosed in double quotes eg., "Password".

Example :REMOTEDisk:PASSWORD "Password"
 Sets the account password as Password.

Set →
 → Query

:REMOTEDisk:MOUNT

Description Turns remote disk on/off or queries its state.

Syntax :REMOTEDisk:MOUNT { OFF | ON | ? }

Parameter/Return parameter OFF Unmount remote disk
 ON Mount remote disk

Example :REMOTEDisk:IPADdress "172.16.5.154"
 :REMOTEDisk:PATHName "remote_disk"
 :REMOTEDisk:USERName "guest"
 :REMOTEDisk:PASSWord "password"
 :REMOTEDisk:MOUNT ON
 Sets the remote disk parameters and mounts the remote disk.

Set →

:REMOTEDisk:AUTOMount

→ Query

Description Turns automount on/off or queries its state. The remote disk must be configured beforehand.

Syntax :REMOTEDisk:AUTOMount { OFF | ON | ? }

Parameter/Return parameter	OFF	Don't mount the remote disk at start up.
	ON	Automatically mount the remote disk on start up.

Example :REMOTEDisk:AUTOMount ON
 Turns the automount function on.

DMM Commands

:DMM.....	271
:DMM:STATE.....	271
:DMM:VALue.....	272
:DMM:HOLD.....	272
:DMM:MMIN.....	272
:DMM:MODE.....	273
:DMM:MODE:RANGe.....	273
:DMM:TEMPerature:UNITs.....	274
:DMM:TEMPerature:TYPe.....	274
:DMM:TEMPerature:SIM.....	275

:DMM → Query

Description	Returns the DMM status.	
Syntax	:DMM?	
Related commands	:MEASUrement:DISPlay	
Parameter/Return parameter	<string>	Returns the mode, current measurement, max measurement, minimum measurement, Hold state.
Example	:DMM? Mode:ACV,Value:0.000,Max Value:0.000,Min Value:0.000,Hold:OFF	

:DMM:STATE Set →
→ Query

Description	Sets or queries the DMM function .	
Syntax	:DMM: STATE { ON OFF ?}	
Parameter/Return	ON	Turns the DMM function on.

parameter OFF Turns the DMM function off.

Example :DMM:STATE ON
 Turns the DMM function on.

:DMM:VALue → Query

Description Returns the measurement value.

Syntax :DMM:VALue?

Related commands :MEASUrement:DISPlay

Return parameter <string> Returns the measurement or value on the display as a string.

Example :DMM:VALue?
 0.000
 Returns the value on the DMM display.

:DMM:HOLD Set →
→ Query

Description Sets or queries the Hold function status.

Syntax :DMM:HOLD { ON | OFF | ?}

Parameter/Return parameter ON Turns the Hold function on.
 OFF Turns the Hold function off.

Example :DMM:HOLD ON
 Turns the Hold function on.

:DMM:MMIN Set →
→ Query

Description Sets or queries the maximum and minimum status.

Syntax :DMM: MMIN { ON | OFF | ?}

Parameter/Return parameter ON Turns the maximum and minimum function on.

OFF Turns the maximum and minimum function off.

Example :DMM:MMIN ON
Turns the maximum and minimum function on.

:DMM:MODE (Set) →
→ (Query)

Description Sets or queries the DMM mode.

Syntax :DMM:MODE
{ DCV | DCMV | ACV | ACMV | DCA | DCMA | ACA | ACMA | OHM | DIODE | BEEP | TEMPerature | ?}

Parameter/Return parameter	DCV	DCV mode
	DCMV	DCMV mode
	ACV	ACV mode
	ACMV	ACMV mode
	DCA	DCA mode
	DCMA	DCMA mode
	ACA	ACA mode
	ACMA	ACMA mode
	OHM	Resistance measurement mode
	DIODE	Diode tester
	BEEP	Continuity tester
	TEMPerature	Temperature measurement mode

Example :DMM:MODE DCV
Sets the measurement mode to DCV.

:DMM:MODE:RANGe (Set) →
→ (Query)

Description Sets or queries the DMM measurement range.

Syntax :DMM:MODE:RANGe (AUTo|<NRf>)
:DMM:MODE:RANGe?

Related commands :DMM:MODE

Parameter/Return parameter	AUTO <NRF>	Auto range ACV: 5,50,750 DCV: 5,50,500,1000 ACmV: 0.5,0.05 DCmV: 0.5,0.05 ACmA: 0.5,0.05 DCmA: 0.5,0.05 ACA: 10 DCA: 10
----------------------------	---------------	---

Example :DMM:MODE ACV
:DMM:MODE:RANGe AUTO
Sets the ACV measurement to auto range.

Set →

:DMM:TEMPerature:UNITs

→ Query

Description Sets the units for the temperature measurement function.

Syntax :DMM:TEMPerature:UNITs { Celsius | Fahrenheit | ? }

Parameter/Return parameter	Celsius	Degrees Celsius
	Fahrenheit	Degrees Fahrenheit

Example :DMM:TEMPerature:TYPE Celsius
Sets the temperature measurement to °C.

Set →

:DMM:TEMPerature:TYPE

→ Query

Description Sets the type of thermocouple used for the temperature measurement function.

Syntax :DMM:TEMPerature:TYPE { TYPEB | TYPEE | TYPEJ | TYPEK | TYPEN | TYPER | TYPES | TYPET | ? }

Parameter/Return parameter	TYPEB	B
	TYPEE	E
	TYPEJ	J
	TYPEK	K
	TYPEN	N
	TYPER	R
	TYPES	S
	TYPET	T

Example :DMM:TEMPerature:TYPE K
 Sets the temperature measurement function to use the K type thermocouple.

Set →

:DMM:TEMPerature:SIM

→ Query

Description Set or returns the environment temperature when temperature measurement selected.

Syntax :DMM:TEMPerature:SIM {<NRf>}
 :DMM:TEMPerature:SIM?

Related commands :DMM:MODE
 :DMM:TEMPerature:UNITs

Parameter/Return parameter <NRf> 0.0~50.0 for Celsius degrees;
 32~ 122.0 for Fahrenheit degrees

Example :DMM:MODE TEMPerature
 :DMM:TEMPerature:UNITs Celsius
 :DMM:TEMPerature:SIM 23.5

Sets the environment temperature to 23.5 Celsius degrees.

Spectrum Analyzer Commands

:SA:STATE	276
:SA:MEMory?	277
:SA:MEMory:SOURce	280
:SA:SOURce	280
:SA:SPECTRUMTrace	280
:SElect:NORMal	281
:SElect:MAXHold	281
:SElect:MINHold	281
:SElect:AVErage	282
:SA:AVErage:NUMAVg	282
:SA:DETECTIonmethod:MODE	282
:SA:DETECTIonmethod:MAXHold	283
:SA:DETECTIonmethod:MINHold	283
:SA:DETECTIonmethod:NORMal	284
:SA:DETECTIonmethod:AVErage	284
:SA:FREQUency	285
:SA:SPAN	285
:SA:START	285
:SA:STOP	286
:SA:RBW:MODE	286
:SA:RBW	286
:SA:SPANRbwratio	287
:SA:WINDow	288
:SA:UNIts	288
:SA:SCAle	289
:SA:POSition	289

:SA:STATE

→ Query

Description	Sets or returns the state of the spectrum analyzer.
-------------	---

Syntax	:SA:STATE {OFF ON} :SA:STATE?	
Parameter	OFF	Disable this function.
	ON	Enable this function.
Example	SA:STATE ON SA:STATE? ON	

:SA:MEMory? → Query

Description	Returns the data in acquisition memory for the spectrum analyzer function as a header + raw data.	
Syntax	:SA:MEMory?	
Related Commands	:SA:MEMory:SOURce	
Return parameter	<string> <waveform block data>	<p>Returns acquisition settings followed by raw waveform block data.</p> <p><string> Returns the spectrum analyzer settings .</p> <p>Format: parameter(1),setting(1);parameter(2),setting(2)...parameter(n),setting(n);Waveform Data;</p> <p><waveform block data> Header followed by the raw waveform data.</p> <p>Format: Header: The header (in ASCII) encodes the number of bytes for the header followed by the number of data points in bytes for the raw data.</p>

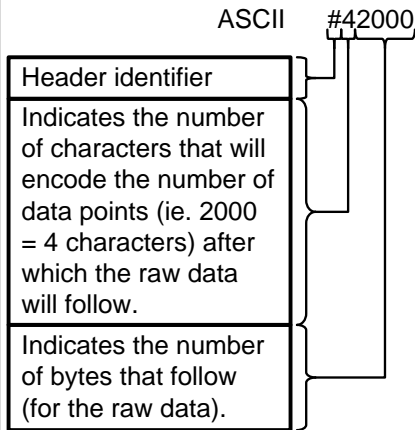

Raw Data:

Each two bytes (in hex) encodes the vertical data of a data point. The data is signed hex data (2's complement, -32768 ~ 32767).

Waveform Raw Data Example:

Header raw data.....

Hex:

23 34 32 30 30 30 00 1C 00 1B 00 1A 00
1A 00 1B

ASCII/Decimal:

#42000 28 27 26 26 27.....

The actual value of a data point can be calculated with the following formula:
(Decimal value of hex data/AD Factor) * vertical scale.

Note: AD Factor is fixed as 25. The vertical scale is returned with the acquisition settings that precede the raw data.

For example if the raw data for a point is 001C (=28 decimal) then,
 $(28/25) \times 0.5 = 0.56V$

Example :SA:MEMory?
Format,2.0E;Firmware,V1.28;Time,24-Apr-17
15:54:49;Memory
Length,1.000E+03;Source,CH1;Probe
Ratio,1.000E+00;Vertical Unit,dB;Vertical
Position,3.000E+00;Vertical
Scale,2.000E+01;Horizontal Unit,Hz;Horizontal
Scale,1.000E+04;Sampling Period,1.000E+02;Center
Frequency,2.300E+03;Span,1.000E+05;FREQUENC
Y,NORM,Waveform Data;
#42000 follows waveform block
data in hex

Set →
 → Query

:SA:MEMory:SOURce

Description	Sets or returns the source of the waveform data	
Syntax	:SA:MEMory:SOURce {NORMal AVErage MAXHold MINHold} :SA:MEMory:SOURce?	
Parameter/Return parameter	NORMal	Normal data
	AVErage	Average data
	MAXHold	Maxhold data
	MINHold	Minhold data
Example	:SA:MEMory:SOURce AVE Sets the memory source to average data	

Set →
 → Query

:SA:SOURce

Description	Sets or returns the source of the spectrum analyzer	
Syntax	:SA:SOURce {CH1 CH2 CH3 CH4} :SA:SOURce?	
Parameter/Return parameter	CH1	Channel one
	CH2e	Chnanel two
	CH3	Channel three
	CH4	Channel four
Example	:SA:SOURce CH2 Sets the source of spectrum analyzer to channel two	

Set →

:SA:SPECTRUMTrace

Description	Resets all spectrum traces.	
Syntax	SA:SPECTRUMTrace {RESET}	
Parameter	RESET	Reset the trace

Example :SA:SPECTRUMTrace RESET
Reset all the trace of spectrum analyzer

Set →

:SElect:NORMal → Query

Description Sets or returns the frequency domain Normal trace display on or off in the frequency domain graticule.

Syntax :SElect:NORMal {ON | OFF}
:SElect:NORMal?

Parameter/Return parameter ON Turns the normal trace display on.
OFF Turns the normal trace display off.

Example :SElect:NORMal ON
Sets the normal trace display on

Set →

:SElect:MAXHold → Query

Description Sets or returns the frequency domain Max Hold trace display on or off in the frequency domain graticule.

Syntax :SElect:MAXHold {ON | OFF}
:SElect:MAXHold?

Parameter/Return parameter ON Turns the Max Hold trace display on.
OFF Turns the Max Hold trace display off.

Example :SElect:MAXHold OFF
Sets the Max Hold trace display off

Set →

:SElect:MINHold → Query

Description Sets or returns the frequency domain Min Hold trace display on or off in the frequency domain graticule.

Syntax :SElect:MINHold {ON | OFF}
:SElect:MINHold?

Parameter/Return parameter ON Turns the Min Hold trace display on.

parameter	OFF	Turns the Min Hold trace display off.
-----------	-----	---------------------------------------

Example :SElect:MINHold OFF
Sets the Min Hold trace display off

(Set) →
→ (Query)

:SElect:AVERage

Description	Sets or returns the frequency domain Average trace display on or off in the frequency domain graticule.	
-------------	---	--

Syntax	:SElect:AVERage {ON OFF} :SElect: AVERage?	
--------	---	--

Parameter/Return parameter	ON	Turns the Average trace display on.
	OFF	Turns the Average trace display off.

Example :SElect: AVERage ON
Sets the Average trace display on

(Set) →
→ (Query)

:SA:AVERage:NUMAVg

Description	Sets or returns the number of acquisitions to be used when creating the Average frequency domain trace.	
-------------	---	--

Syntax	:SA:AVERage:NUMAVg {<NR1>} :SA:AVERage:NUMAVg?	
--------	---	--

Parameter/Return parameter	<NR1>	The range is 2 - 256, in exponential increments.
----------------------------	-------	--

Example :SA:AVERage:NUMAVg 128
Sets the Average number to 128

(Set) →
→ (Query)

:SA:DETECTionmethod:MODE

Description	Sets or returns the detection within the oscilloscope occurs automatically or manually.	
-------------	---	--

Syntax	:SA:DETECTionmethod:MODE {AUTO MANual} :SA:DETECTionmethod:MODE?	
--------	---	--

Related commands :SA:DETECTIonmethod:MAXHold,:SA:DETECTIonmethod:MINHold
:SA:DETECTIonmethod:NORMAl,:SA:DETECTIonmethod:AVErage

Parameter/Return parameter	AUTo	Automatically mode
	MANual	Manually mode

Example :SA:DETECTIonmethod:MODE AUTO
Sets the detection mode to automatic.

Set →
 → Query

Description Sets or returns the detection method of max Hold frequency domain trace.

Syntax :SA:DETECTIonmethod:MAXHold
{PLUSpeak | MINUSpeak | SAMPlE | AVErage}
:SA:DETECTIonmethod:MAXHold?

Parameter/Return parameter	PLUSpeak	Sets the detection method to plus peak.
	MINUpeak	Sets the detection method to minus peak
	SAMple	Sets the detection method to sample.
	AVErage	Sets the detection method to average.

Example :SA:DETECTIonmethod:MAXHold AVErage
Sets the detection method to average.

Set →
 → Query

Description Sets or returns the detection method of min Hold frequency domain trace.

Syntax :SA:DETECTIonmethod:MINHold
{PLUSpeak | MINUSpeak | SAMPlE | AVErage}
:SA:DETECTIonmethod:MINHold?

Parameter/Return parameter	PLUSpeak	Sets the detection method to plus peak.
	MINUpeak	Sets the detection method to minus peak
	SAMple	Sets the detection method to sample.
	AVErage	Sets the detection method to average.

Example :SA:DETECTIonmethod:MINHold AVErage
Sets the detection method to average.

Set →

:SA:DETECTIonmethod:NORMal

→ Query

Description	Sets or returns the detection method of normal frequency domain trace.	
Syntax	:SA:DETECTIonmethod:NORMal {PLUSpeak MINUSpeak SAMple AVErage} :SA:DETECTIonmethod:NORMal?	

Parameter/Return parameter	PLUSpeak	Sets the detection method to plus peak.
	MINUpeak	Sets the detection method to minus peak
	SAMple	Sets the detection method to sample.
	AVErage	Sets the detection method to average.

Example :SA:DETECTIonmethod:NORMal AVErage
Sets the detection method to average.

Set →

:SA:DETECTIonmethod:AVErage

→ Query

Description	Sets or returns the detection method of average frequency domain trace.	
Syntax	:SA:DETECTIonmethod:AVErage {PLUSpeak MINUSpeak SAMple AVErage} :SA:DETECTIonmethod:AVErage?	

Parameter/Return parameter	PLUSpeak	Sets the detection method to plus peak.
	MINUpeak	Sets the detection method to minus peak
	SAMple	Sets the detection method to sample.
	AVERage	Sets the detection method to average.

Example :SA:DETECTIonmethod:AVERage AVERage
Sets the detection method to average.

Set →

:SA:FREQUency

→ Query

Description Sets or returns the frequency (or center frequency) of the acquisition system.

Syntax :SA:FREQUency {<NRf> | CENTER}
:SA:FREQUency?

Parameter/Return parameter	<NRf>	Sets the frequency by user.
	CENTER	Sets the frequency to center.

Example SA:FREQUency 3.0E+06
sets the center frequency to 3 MHz.

Set →

:SA:SPAN

→ Query

Description Sets or returns the span frequency setting.

Syntax :SA:SPAN <NRf>
:SA:SPAN?

Parameter/Return parameter	<NRf>	Sets the span frequency by user.
----------------------------	-------	----------------------------------

Example SA:SPAN 25E+06
sets the span frequency to 25 MH

Set →

:SA:START

→ Query

Description Sets or returns the start frequency setting.

Syntax :SA:START <NRf>
:SA:START?

Parameter/Return parameter	<code><NRf></code>	Sets the start frequency by user.
----------------------------	--------------------------	-----------------------------------

Example	<code>SA:START -9.5E+06</code> sets the start frequency to -9.5 MHz.
---------	---

(Set) →

→ (Query)

:SA:STOP

Description	Sets or returns the stop frequency setting.
-------------	---

Syntax	<code>:SA:STOP <NRf></code> <code>:SA:STOP?</code>
--------	---

Parameter/Return parameter	<code><NRf></code>	Sets the stop frequency by user.
----------------------------	--------------------------	----------------------------------

Example	<code>SA:START 100E+06</code> sets the stop frequency to 100MHz.
---------	---

(Set) →

→ (Query)

:SA:RBW:MODE

Description	Sets or returns the resolution bandwidth (RBW) mode, either automatic or manual.
-------------	--

Syntax	<code>:SA:RBW:MODE {AUTO MANual}</code> <code>:SA:RBW:MODE?</code>
--------	---

Parameter/Return parameter	<code>AUTO</code> <code>MANual</code>	Automatically mode. Manually mode.
----------------------------	--	---------------------------------------

Example	<code>SA:RBW:MODE AUTO</code> sets the mode to automatic.
---------	--

(Set) →

→ (Query)

:SA:RBW

Description	Sets or returns the resolution bandwidth (RBW) when the RBW mode has been set to MANUAL (using the command <code>SA:RBW:MODE</code>).
-------------	--

Syntax	<code>:SA:RBW <NRf></code> <code>:SA:RBW?</code>
--------	---

Related commands	<code>SA:RBW:MODE</code>
------------------	--------------------------

Parameter/Return parameter	<NRf>	Sets the RBW by user.
----------------------------	-------	-----------------------

Example	Sets SA:RBW 2.0E+04 Query SA:RBW? Return 1.825017e+04
---------	---

If the RBW set to 20kHz, the query will return the nearestvalue (1.825017e+04).

Set →

→ Query

:SA:SPANRbwratio

Description	Sets or returns the resolution bandwidth (RBW) when the RBW mode has been set to AUTO (using the command SA:RBW:MODE).
-------------	--

Syntax	:SA:SPANRbwratio {RATIO1K RATIO2K RATIO5K RATIO10K RATIO20K RATIO50K RATIO100K RATIO200K <NRf>} :SA:SPANRbwratio?
--------	---

Related commands	SA:RBW:MODE
------------------	-------------

Parameter/Return parameter	<NRf>	Sets the RBW by user.
	RATIO1K	1000 : 1
	RATIO2K	2000 : 1
	RATIO5K	5000 : 1
	RATIO10K	10000 : 1
	RATIO20K	20000 : 1
	RATIO50K	50000 : 1
	RATIO100K	100000 : 1
	RATIO200K	200000 : 1

Example :SA:SPANRbwratio RATIO2K
 Sets the ratio to 2000:1.

Sets :SA:SPANRbwratio 2000
 Query :SA:SPANRbwratio?
 Return RATIO2K

Set →

→ Query

:SA:WINDow

Description Sets or returns the windowing function, which is only used for traces.

Syntax :SA:WINDow
 {RECTangular | HAMming | HANning | BLAckman};SA:WINDow?

Parameter/ Return parameter	RECTangular	Sets to Rectangular window
	HAMming	Sets to Hamming window
	HANning	Sets to Hanning window
	BLAckman	Sets to Blackman window

Example :SA:WINDow HANning
 Sets to the hanning window.

Set →

→ Query

:SA:UNIts

Description Sets or returns the vertical units.

Syntax :SA:UNIts {DBV | LINEAR | DBM}
 :SA:UNIts?

Parameter/ Return parameter	DBV	Sets to DBV unit
	LINEAR	Sets to Linear unit
	DBM	Sets to DBM unit

Example :SA:UNIts DBM
 Sets the unit to DBM unit.

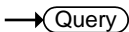
:SA:SCALE

Description	Sets or returns the overall vertical scale.	
Syntax	:SA:SCALE <NRf> :SA:SCALE?	
Related commands	:SA:UNIts	
Parameter/ Return parameter	<NRf>	Vertical scale, the value may vary which depends on the unit selected. dBm and dBV : 1, 2, 5, 10, 20 (dB) Linear: 2m, 5m, 10m, 20m, 50m, 100m, 200m, 500m, 1, 2, 5, 10, 20, 50, 100, 200, 500, 1k (V)
Example	:SA:SCALE 2 Sets the scale to 2.	

:SA:POSition

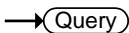
Description	Sets or returns the overall vertical position.	
Syntax	:SA:POSition <NRf> :SA:POSition?	
Parameter/ Return parameter	<NRf>	Vertical position range: +/-12
Example	:SA:POSition 3 Sets the vertical position to 3.	

Power Supply Commands

:POWERSupply:OUTPut<X> 290
 :POWERSupply:CONFigure 290
 :POWERSupply:OUTPut<X>:VOLTage 291
 :POWERSupply:OUTPut<X>:RECONFigure 291
 :POWERSupply:OUTPut<X>:OCP 291
 s

:POWERSupply:OUTPut<X> (Set) →
→ (Query)

Description	Sets or returns the power supply output.	
Syntax	:POWERSupply:OUTPut<X> {ON OFF} :POWERSupply:OUTPut<X>?	
Parameter/ Return parameter	OFF	Turns off the power supply output
	ON	Turns on the power supply output
	<X>	Range 1~2, Select the output 1 or output 2
Example	:POWERSupply:OUTPut1 ON Turn on output 1.	

:POWERSupply:CONFigure (Set) →
→ (Query)

Description	Configure the power supply. *It is must delay about 6 sec after power supply config.	
Syntax	:POWERSupply:CONFigure {ON ?}	
Parameter	ON	Configure the power supply.
Example	:POWERSupply:CONFigure ON	

:POWERSupply:OUTPut<X>:VOLTage (Set) →
→ (Query)

Description	Sets or returns the power supply voltage.	
Syntax	:POWERSupply:OUTPut<X>:VOLTage <NR3> :POWERSupply:OUTPut<X>:VOLTage?	
Parameter/ Return parameter	<NR3> <X>	Range 1.0~5.0, sets the voltage Range 1~2, Select the output 1 or output 2
Example	:POWERSupply:OUTPut1:VOLTage 3.3 Sets the power supply output 1 to 3.3V.	

:POWERSupply:OUTPut<X>:RECONFigure (Set) →

Description	Reconfigure the power supply when OCP occurred.	
Syntax	:POWERSupply:OUTPut<X>:RECONFigure {ON}	
Parameter/ Return parameter	ON <X>	Reconfigure the power supply Range 1~2, Select the output 1 or output 2
Example	:POWERSupply:OUTPut1:RECONFigure ON Reconfigure the power supply output 1.	

:POWERSupply:OUTPut<X>:OCP → (Query)

Description	Returns the power supply OCP.	
Syntax	:POWERSupply:OUTPut<X>:OCP?	
Parameter/ Return parameter	<X>	Range 1~2, Select the output 1 or output 2
Example	:POWERSupply:OUTPut1:OCP? Return the OCP status for output 1.	

USB Delay Command

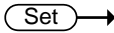
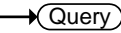
		
:USBDelay		
Description	Sets or returns the USB delay function for the PC connection which Windows 10 installed	
Syntax	:USBDelay {OFF ON} :USBDelay?	
Parameter/ Return parameter	<ON>	Turns on the USB delay function
	<OFF>	Turns off the USB delay function
Example	:USBDelay ON Turns on the USB delay function when the scope connected with window 10 installed PC..	

Digital Commands

:D<x>:DISPlay	293
:D<x>:POSition	293
:DISPlay:DIGital:HEIght	294
:DIGital:GROU<x>:THReshold	294
:DIGital:ANALog:A<x>:DISPlay	295
:DIGital:ANALog:A<x>:RATio	295
:DIGital:ANALog:A<x>:POSition	296
:D<x>:MEMory	296
:DIGital:MEMory	298

:D<x>:DISPlay (Set) →
→ (Query)

Description Turns a digital channel <x> on/off or returns its status.

Syntax :D<x>:DISPlay {OFF | ON | ?}

Parameter / Return parameter	OFF	Turns off a digital channel
	ON	Turns on a digital channel
	D<x>	Digital channel number D0 ~ D15

Example :D0:DISP OFF

:D<x>:POSition (Set) →
→ (Query)

Description Sets or returns the position level for digital channel <x>.

Syntax :D<x>:POSition {<NRf> | ?}

Parameter / Return parameter	D<x>	Digital channel number D0 ~ D15
	<NRf>	Vertical scale position

Example :D0:POS ?
 >1.87 DIV
 :D0:POS 0

Set →

→ Query

:DISPlay:DIGital:HEIght

Description Sets or returns the number of available digital waveform position slots.

Syntax :DISPlay:DIGital:HEIght {SMALL | MEDium | LARge | ?}

Parameter / Return parameter	SMALL	Sets the height to small mode (digital channels: 16 max)
	MEDium	Sets the height to medium mode (digital channels: 16 max)
	LARge	Sets the height to large mode (digital channels: 8 max)

Example :DIS:DIG:HEI ?
 >LARGE
 :DIS:DIG:HEI SMA

Set →

→ Query

:DIGital:GROUP<x>:THReshold

Description Sets or returns the digital threshold for a group.

Syntax :DIGital:GROUP<x> {ECL | TTL | PECL | CMOS5 | CMOS3 | CMOS2 | <NR3> | ?}

Parameter / Return parameter	ECL	Sets the threshold to a preset ECL high level (-1.3V)
	TTL	Sets the threshold to a preset TTL high level (1.4V)
	PECL	Sets the threshold to a preset PECL high level (3.7V)
	CMOS5	Sets the threshold to a preset CMOS5 (5.0V) high level (2.5V)

CMOS3	Sets the threshold to a preset CMOS3 (3.3V) high level (1.65V)
CMOS2	Sets the threshold to a preset CMOS2 (2.5V) high level (1.25V)
<NR3>	Sets the threshold to a preset ECL high level (-1.3V)
GROUP<x>	Group number 1~4 (16 channels) or 1~2 (8 channels) GROUP1: digital channels D0~D3 GROUP2: digital channels D4~D7 GROUP3: digital channels D8~D11 GROUP4: digital channels D12~D15

Example :DIG:GROUP1:THR ?
>-1.300e+00
:DIG:GROUP1:THR TTL

:DIGital:ANALog:A<x>:DISPlay  

Description Turns the analog waveform <x> on/off or returns its status.

Syntax :DIGital:ANALog:A<x>:DISPlay {OFF | ON | ?}

Parameter / Return parameter	OFF	Turns off the analog waveform
	ON	Turns on the analog waveform
	A<x>	Analog waveform number 1~2

Example :DIG:ANA:A1:DISP OFF

:DIGital:ANALog:A<x>:RATio  

Description Sets or returns the analog waveform vertical scale ratio.

Syntax :DIGital:ANALog:A<x>:RATio {<NRf> | ?}

Parameter /	<NRf>	Vertical scale ratio (0.1, 0.2, ...1).
Return parameter	A<x>	Analog waveform number 1~2

Example :DIG:ANA:A1:RAT 0.1

:DIGital:ANALog:A<x>:POSition

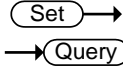

Description	Sets or returns the analog waveform vertical scale position.	
-------------	--	--

Syntax :DIGital:ANALog:A<x>:POSition {<NRf> | ?}

Parameter /	<NRf>	Vertical scale position (0, 0.1, 0.2, ...8).
Return parameter	A<x>	Analog waveform number 1~2

Example :DIG:ANA:A1:POS 4.5

:D<x>:MEMory



Description	Returns the data in acquisition memory for the selected digital channel.	
-------------	--	--

Syntax :D<x>:MEMory?

Related commands	:ACQuire:RECOrdlength :HEADer	
------------------	----------------------------------	--

Parameter	D<x>	Digital channel number D0 ~ D15
-----------	------	---------------------------------

Return parameter

<string>

Returns acquisition settings followed by raw waveform block data.

<string>

Returns the acquisition settings for the selected digital channel.

Format:

parameter(1),setting(1);parameter(2),setting(2)...parameter(n),setting(n);Waveform Data;

<waveform block data>

<waveform block data>

Header followed by the raw waveform data.

Format:

Header: The header (in ASCII) encodes the number of bytes for the header followed by the number of data points in bytes for the raw data.

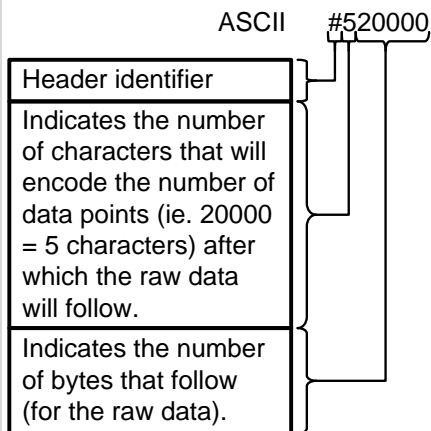

Raw Data:

Each two bytes (in hex) encodes the logical level (0 or 1) of a data point of the digital channel, i.e. logical 0 is 0x0000 and logical 1 is 0x0001.

Waveform Raw Data Example:

Header raw data.....

Hex:

35 32 30 30 30 30 30 00 00 00 00 00 00
00 01 00 01

ASCII/Decimal:

#520000 0000000101

The raw data contains 20000 bytes (=10000 points); point 1 is logical 0, point 2 is logical 0, point 3 is logical 0, point 4 is logical 1, point 5 is logical 1, etc...

Example :D1:MEM?
 FORMAT,2.0A;Display,1;Memory
 Length,10000;IntpDistance,0; Trigger Address,0;
 Threshold Used,1.400E+00;Source,D1;Vertical
 Units,V; Label1,;Firmware,V1.25b10; Horizontal
 Units,S;Horizontal Scale,1.000E-04; Horizontal
 Position,0.000E+00;Horizontal Mode,Main;SincET
 Mode,Real Time; Sampling Period,1.000E-07;Time,22-
 Sep-16 19:42:28;
 Waveform Data;
 #520000.....follows waveform block
 data.....

:DIGital:MEMory

→ Query

Description	Returns the data in acquisition memory for all the digital channels.
Syntax	:DIGital:MEMory?
Related commands	:ACQuire:RECOrdlength :HEADer

Return parameter

Returns acquisition settings followed by raw waveform block data.

<string>

<string>

Returns the acquisition settings for all the digital channels.

Format:

parameter(1),setting(1);parameter(2),setting(2)...parameter(n),setting(n);Waveform Data;

<waveform block data>

<waveform block data>

Header followed by the raw waveform data.

Format:

Header: The header (in ASCII) encodes the number of bytes for the header followed by the number of data points in bytes for the raw data.

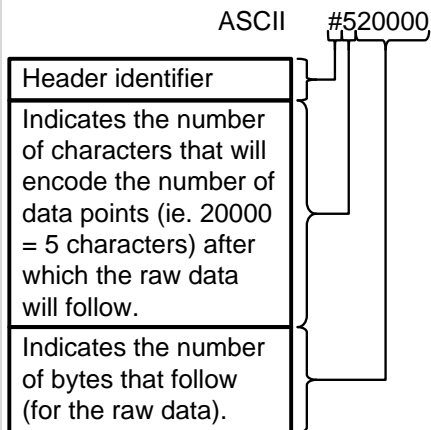

Raw Data:

The sixteen bits composing each consecutive two bytes encode the logical level (0 or 1) of all the digital channels for one data point. For a given two bytes, the least significant

bit is channel 0 and the most significant bit is channel 15.

Waveform Raw Data Example:

Header raw data.....

Hex:

35 32 30 30 30 30 00 15 00 14 00 11
00 10

ASCII/Decimal:

#520000 raw data

The raw data contains 20000 bytes (=10000 points) with the following logical level for each channels per data point:

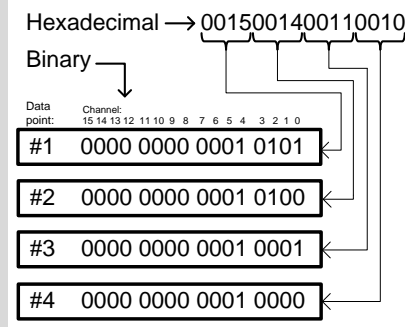

Example

```
:DIG:MEM?
Format,2.0E;Display,1111111111111111;Memory
Length,10000;IntpDistance,0;Trigger
Address,0;Threshold12_15,1.40V;Threshold8_11,1.40
V;Threshold4_7,1.40V;Threshold0_3,1.40V;Vertical
Units,V;Label15,;Label14,;Label13,;Label12,;Label11,;L
abel10,;Label9,;Label8,;Label7,;Label6,;Label5,;Label4,;
Label3,;Label2,;Label1,;Label0,;Firmware,V1.25b10;Ho
rizontal Units,S;Horizontal Scale,1.000E-
04;Horizontal Position,0.000E+00;Horizontal
Mode,Main;SincET Mode,Real Time;Sampling
Period,1.000E-07;Time,22-Sep-16 10:44:28;
Waveform Data;
#520000.....follows waveform block
data.....
```

APPENDIX

Error messages

Description The following error messages may be returned from the :SYSTem:ERRor? query. For details see page 164.

List of error messages

Error number, "Error Description"

+0, "No error."
 -100, "Command error"
 -101, "Invalid character"
 -102, "Syntax error"
 -103, "Invalid separator"
 -104, "Data type error"
 -105, "GET not allowed"
 -108, "Parameter not allowed"
 -109, "Missing parameter"
 -110, "Command header error"
 -111, "Header separator error"
 -112, "Program mnemonic too long"
 -113, "Undefined header"
 -114, "Header suffix out of range"
 -115, "Unexpected number of parameters"
 -120, "Numeric data error"
 -121, "Invalid character in number"
 -123, "Exponent too large"
 -124, "Too many digits"
 -128, "Numeric data not allowed"
 -130, "Suffix error"
 -131, "Invalid suffix"
 -134, "Suffix too long"
 -138, "Suffix not allowed"

- 140, "Character data error"
- 141, "Invalid character data"
- 144, "Character data too long"
- 148, "Character data not allowed"
- 150, "String data error"
- 151, "Invalid string data"
- 158, "String data not allowed"
- 160, "Block data error"
- 161, "Invalid block data"
- 168, "Block data not allowed"
- 170, "Expression error"
- 171, "Invalid expression"
- 178, "Expression data not allowed"
- 180, "Macro error"
- 181, "Invalid outside macro definition"
- 183, "Invalid inside macro definition"
- 184, "Macro parameter error"

- 200, "Execution error"
- 201, "Invalid while in local"
- 202, "Settings lost due to rtl"
- 203, "Command protected"
- 210, "Trigger error"
- 211, "Trigger ignored"
- 212, "Arm ignored"
- 213, "Init ignored"
- 214, "Trigger deadlock"
- 215, "Arm deadlock"
- 220, "Parameter error"
- 221, "Settings conflict"
- 222, "Data out of range"
- 223, "Too much data"
- 224, "Illegal parameter value"
- 225, "Out of memory"
- 226, "Lists not same length"
- 230, "Data corrupt or stale"
- 231, "Data questionable"
- 232, "Invalid format"
- 233, "Invalid version"
- 240, "Hardware error"

- 241, "Hardware missing"
- 250, "Mass storage error"
- 251, "Missing mass storage"
- 252, "Missing media"
- 253, "Corrupt media"
- 254, "Media full"
- 255, "Directory full"
- 256, "File name not found"
- 257, "File name error"
- 258, "Media protected"
- 260, "Expression error"
- 261, "Math error in expression"
- 270, "Macro error"
- 271, "Macro syntax error"
- 272, "Macro execution error"
- 273, "Illegal macro label"
- 274, "Macro parameter error"
- 275, "Macro definition too long"
- 276, "Macro recursion error"
- 277, "Macro redefinition not allowed"
- 278, "Macro header not found"
- 280, "Program error"
- 281, "Cannot create program"
- 282, "Illegal program name"
- 283, "Illegal variable name"
- 284, "Program currently running"
- 285, "Program syntax error"
- 286, "Program runtime error"
- 290, "Memory use error"
- 291, "Out of memory"
- 292, "Referenced name does not exist"
- 293, "Referenced name already exists"
- 294, "Incompatible type"

- 300, "Device-specific error"
- 310, "System error"
- 311, "Memory error"
- 312, "PUD memory lost"
- 313, "Calibration memory lost"
- 314, "Save/recall memory lost"

- 315, "Configuration memory lost"
- 320, "Storage fault"
- 321, "Out of memory"
- 330, "Self-test failed"
- 340, "Calibration failed"
- 350, "Queue overflow"
- 360, "Communication error"
- 361, "Parity error in program message"
- 362, "Framing error in program message"
- 363, "Input buffer overrun"
- 365, "Time out error"

- 400, "Query error"
- 410, "Query INTERRUPTED"
- 420, "Query UNTERMINATED"
- 430, "Query DEADLOCKED"
- 440, "Query UNTERMINATED after indefinite response"

INDEX

ACQUIRE	
FILTER	
TRACKING	45
ACQUIRE	
AVERAGE	39
FILTER	
FREQUENCY	43
FILTER.....	43
SOURCE	42
MEMORY.....	40
MODE.....	40
ACQUIRE	
STATE	45
ACQUIRE	
INTERPOLATION.....	45
ACQUIRE	
RECORDLENGTH	46
ACQUIRE	
HEADER	46
AUTORSET	
MODE.....	47
AUTOSet.....	47
BUS1	172
CAN	
BITRate.....	182
PROBE	181
SAMPLEpoint.....	181
SOURCE	181
DISplay	
FORMAT.....	180
I2C	
ADDRESS	
RWINCLUDE.....	173
SCLK	
SOURCE.....	174
SDA	
SOURCE	174
INPUT	173
LABEL.....	224, 295
DISPlay	224, 225, 226, 227, 295, 298
LIN	
BITRate	183
IDFORMAT	183
POLARity	183
SAMPLEpoint.....	184
SOURCE	184
STANDARD	184
SPI	
BITORDER	178
MISO	
SOURCE	179
MOSI	
SOURCE	179
SCLK	
POLARity	177
SOURCE	178
SS	
POLARity	177
SOURCE	179
WORDSize	178
STATE	172
TYPE	172
UART	
BITRate	174
DATABits	175
EOFPACKET.....	176
PACKET	175
PARity	175
RX	
SOURCE	177
TX	
SOURCE	176
CHANNEL	
BWLIMIT.....	48
COUPLING.....	49
DESKew	49
DISPlay.....	49
EXPAND.....	50
IMPedance	50
INVERT.....	51

LAbel	221, 293	DATE	170
DISPlay	222, 293	DISPlay	
POStion	51	INTENSITY	
PROBe		BACKLight	
TYPE	52	AUTODim	
PROBe		Time	75
RATio	52	DISPlay	
SCALe	52	GRATicule	76
CLS	35	INTensity	
CURSor		BACKLight	74
DDT	66	BACKLight	
H1Position	67	AUTODim	
H2Position	67	ENABle	74
HDELta	68	GRATicule	74
HUNI	65	WAVEform	73
HUSE	65	OUTPut	76
MODE	64	PERSistence	75
SOURce	64	WAVEform	76
V1Position	68	DMM	
VDELta	69	HOLD	271, 272
VUNI	66	MOD	273
VUSE	66	TEMPerature	
XY		TYPe	274, 275, 280, 281, 282
POLar		UNITs	274
RADIUS		VALue	272, 273
DELta	71	DVM	
POStion	70	MODE	239
THETA		SOURce	238
DELta	71	STATE	238
POStion	71	VALue	239
PRODuct		Error list	301
DELta	72	Ethernet	
POStion	72	interface	5
RATio		ETHERnet	
DELta	73	DHCP	170
RATio		FORCe	118
POStion	72	GONogo	
RECTangular		CLEar	240
X		EXECute	240, 247
DELta	69	FUNCTION	241, 247
POStion	69	NGCount ...	241, 248, 249, 250, 251,
Y		252, 253, 254, 255, 256, 257, 258,	
DELta	70	259, 260, 261, 262, 263, 287, 288,	
POStion	70	289, 290, 291, 292	
DATALOG			
DURation ...	267, 282, 283, 284, 285,		
286			
INTERval	266		
SAVE	266		
SOURce	265		
STATE	265		

LOW.....	84	TOTAL.....	190
MID.....	84	TRIGger	
MID2.....	84	BUS	
STATistics.....	113	B1	
MODE.....	113	CAN	
WEIghting.....	113	CONDition.....	209
RCL.....	34	DATA	
RECALL		QUALifier.....	212
SETUp.....	165	SIZE.....	213
WAVEform.....	165	VALue.....	213
REF		FRAMeType.....	210
DISPlay.....	114	IDentifier	
LABel.....	222, 294	DIRection.....	211
DISPlay.....	223, 294, 296	MODE.....	210
OFFSet.....	115	VALue.....	211
SCALe.....	116	I2C	
TIMebase		ADDRESS	
POSition.....	114	DIRection.....	201
SCALe.....	115	MODE.....	199
Remote control		TYPe.....	199
interface configuration.....	3	VALue.....	200
REMOTEDisk		CONDition.....	198
AUTOMount.....	270	DATA	
IPADDRESS.....	268	QUALifier.....	215
MOUNT.....	269	SIZE.....	216
PASSWOrd.....	269	VALue.....	216
PATHName.....	268	ERRTYPE.....	217
USERName.....	269	IDentifier	
RST.....	35	VALue.....	218
RUN.....	117	SPI	
SAV.....	34	CONDition.....	206
SAVe		DATA	
IMAGe.....	166	MISO.....	207
FILEFormat.....	166	MOSI.....	208
INKSaver.....	167	SIZE.....	207
SETUp.....	167	UART	
WAVEform.....	168	CONDition.....	203
FILEFormat.....	169	RX	
SEARCH		DATA.....	204
COPY.....	189	TX	
FFTPeak		DATA.....	205
METHod.....	218	TYPe.....	198
MPEak.....	219	EDGE	
SINFo.....	220	SLOP.....	191
STATE.....	190	HLEVel.....	192
		LEVel.....	192
		LLEVel.....	193
		PULSe	
		TIME.....	195
		WHEn.....	195
		PULSEWidth	
		POLarity.....	193

RISEFall		MODE 243
SLOP 194	POSition	
TIME 197	MAXimum 244
WHEn 197	MINimum 244
RUNT		SAVe	
POLarity 194	AUto 245
TIME 196	MAXimum 244
WHEn 196	MINimum 245
SOURce 191	TOLerance 245
TYPe 190		
SEGMENTS		TIMEbase	
CURRent 230	EXPand 119
DISPALL 231	MODE 120
MEASure		POSition 119
MODE 231	SCALe 119
PLOT		WINDow	
DIVide 232	POSition 120
RESults 233	SCALe 121
SELect 233	TRIGger	
SOURce 232	ALternate 137
TABLE		BUS	
LIST 235	B1	
SAVe 235	CAN	
SELect 234	CONDition 151
SOURce 234	DATA	
SAVe 235	QUALifier 153
SELect		SIZE 154
END 237	VALue 155
START 236	FRAMeType 151
SOURce 236	IdentifiEr	
STATE 229	DIRection 153
TIME 231	MODE 152
TOTAlnum 230	VALue 152
SET		I2C	
LABel 228, 296	ADDRess	
SINGLE 117	DIRection 143
Socket server		MODE 142
function check 8	TYPe 142
Socket server		VALue 143
interface 7	CONDition 141
STOP 117	DATA	
SYSTEM		SIZE 144
ERRor 164	VALue 144
LOCK 164	LIN	
TEMPLATE		CONDition 155
MAXimum 243	DATA	
MINimum 243	QUALifier 156
		SIZE 157
		VALue 157
		ERRTYPe 158, 159, 160, 161, 162
		IdentifiEr	
		VALue 159
		SPI	

CONDition.....	148	HOLDoff.....	126
DATa		LEVel.....	127
MISO		LLEVel.....	128
VALue.....	149	MODE.....	126
MOSI		NREJ.....	126
VALue.....	150	PULSe	
SIZe.....	149	TIME.....	136
UART		WHEn.....	135
CONDition.....	145	PULSEWidth	
RX		POLarity.....	130
DATa		RISEFall	
SIZe.....	146	SLOP.....	132
VALue.....	146	TIME.....	133
TX		WHEn.....	132
DATa		RUNT	
SIZe.....	147	POLarity.....	131
VALue.....	147	TIME.....	132
THReshold		WHEn.....	131
CH.....	140	SOURce.....	125
TYPe.....	140	STATe.....	138
COUPLE.....	125	TIMEOut	
DELay		TIMER.....	137
EVENT.....	130	WHEn.....	136
LEVel.....	130	TYPe.....	124
SLOP.....	128	VIDeo	
TIME.....	129	FIELD.....	134
TYPE.....	129	LINE.....	135
EDGE		POLarity.....	135
SLOP.....	128	TYPe.....	134
EXTERnal		USB	
PRObe		function check.....	4
RATio.....	140	remote control interface.....	3
TYPe.....	138		
FREQuency.....	124		
HLEVel.....	127		