

Programmable DC Power Supply

PSU Series

USER MANUAL



ISO-9001 CERTIFIED MANUFACTURER

GW INSTEK

This manual contains proprietary information, which is protected by copyright. All rights are reserved. No part of this manual may be photocopied, reproduced or translated to another language without prior written consent of Good Will company.

The information in this manual was correct at the time of printing. However, Good Will continues to improve products and reserves the rights to change specification, equipment, and maintenance procedures at any time without notice.

Good Will Instrument Co., Ltd.
No. 7-1, Jhongsing Rd., Tucheng Dist., New Taipei City 236, Taiwan.

Table of Contents

SAFETY INSTRUCTIONS	5
GETTING STARTED.....	9
PSU Series Overview.....	10
Appearance.....	15
Theory of Operation.....	23
OPERATION	35
Set Up.....	37
Basic Operation	53
Parallel / Series Operation.....	71
Test Scripts	88
CONFIGURATION.....	96
Configuration Overview	97
ANALOG CONTROL.....	121
Analog Remote Control Overview.....	122
Remote Monitoring.....	141
Isolated Analog Control Option	149
COMMUNICATION INTERFACE	165
Interface Configuration	166
FAQ.....	195
APPENDIX.....	197
PSU Factory Default Settings	197
Error Messages & Messages	200
LED ASCII Table Character Set.....	201
PSU Specifications.....	202







PSU Dimensions 210
Declaration of Conformity..... 211
INDEX.....212

S SAFETY INSTRUCTIONS

This chapter contains important safety instructions that you must follow during operation and storage. Read the following before any operation to insure your safety and to keep the instrument in the best possible condition.

Safety Symbols

These safety symbols may appear in this manual or on the instrument.

	WARNING	Warning: Identifies conditions or practices that could result in injury or loss of life.
	CAUTION	Caution: Identifies conditions or practices that could result in damage to the PSU or to other properties.
		DANGER High Voltage
		Attention Refer to the Manual
		Protective Conductor Terminal
		Earth (ground) Terminal



Do not dispose electronic equipment as unsorted municipal waste. Please use a separate collection facility or contact the supplier from which this instrument was purchased.

Safety Guidelines

General Guideline



CAUTION

- Do not place any heavy object on the PSU.
- Avoid severe impact or rough handling that leads to damaging the PSU.
- Do not discharge static electricity to the PSU.
- Use only mating connectors, not bare wires, for the terminals.
- Do not block the cooling fan opening.
- Do not disassemble the PSU unless you are qualified.

(Measurement categories) EN61010-1:2010 and EN61010-2-030 specifies the measurement categories and their requirements as follows. The PSU falls under category II.

- Measurement category IV is for measurement performed at the source of low-voltage installation.
- Measurement category III is for measurement performed in the building installation.
- Measurement category II is for measurement performed on the circuits directly connected to the low voltage installation.
- 0 is for measurements performed on circuits not directly connected to Mains.

Power Supply



WARNING

- AC Input voltage range: 85Vac~265Vac
 - Frequency: 47Hz to 63Hz
 - To avoid electrical shock connect the protective grounding conductor of the AC power cord to an earth ground.
-

- Cleaning the PSU
- Disconnect the power cord before cleaning.
 - Use a soft cloth dampened in a solution of mild detergent and water. Do not spray any liquid.
 - Do not use chemicals containing harsh material such as benzene, toluene, xylene, and acetone.
-

- Operation Environment
- Location: Indoor, no direct sunlight, dust free, almost non-conductive pollution (Note below)
 - Relative Humidity: 20%~ 85% (no condensation)
 - Altitude: < 2000m
 - Temperature: 0°C to 50°C

(Pollution Degree) EN61010-1:2010 and EN61010-2-030 specifies the pollution degrees and their requirements as follows. The PSU falls under degree 2.

Pollution refers to “addition of foreign matter, solid, liquid, or gaseous (ionized gases), that may produce a reduction of dielectric strength or surface resistivity”.

- Pollution degree 1: No pollution or only dry, non-conductive pollution occurs. The pollution has no influence.
 - Pollution degree 2: Normally only non-conductive pollution occurs. Occasionally, however, a temporary conductivity caused by condensation must be expected.
 - Pollution degree 3: Conductive pollution occurs, or dry, non-conductive pollution occurs which becomes conductive due to condensation which is expected. In such conditions, equipment is normally protected against exposure to direct sunlight, precipitation, and full wind pressure, but neither temperature nor humidity is controlled.
-

- Storage environment
- Location: Indoor
 - Temperature: -25°C to 70°C
 - Relative Humidity: ≤90%(no condensation)
-

Disposal



Do not dispose this instrument as unsorted municipal waste. Please use a separate collection facility or contact the supplier from which this instrument was purchased. Please make sure discarded electrical waste is properly recycled to reduce environmental impact.

Power cord for the United Kingdom

When using the power supply in the United Kingdom, make sure the power cord meets the following safety instructions.

NOTE: This lead/appliance must only be wired by competent persons



WARNING: THIS APPLIANCE MUST BE EARTHED

IMPORTANT: The wires in this lead are coloured in accordance with the following code:

Green/ Yellow:	Earth
Blue:	Neutral
Brown:	Live (Phase)



As the colours of the wires in main leads may not correspond with the coloured marking identified in your plug/appliance, proceed as follows:

The wire which is coloured Green & Yellow must be connected to the Earth terminal marked with either the letter E, the earth symbol \oplus or coloured Green/Green & Yellow.

The wire which is coloured Blue must be connected to the terminal which is marked with the letter N or coloured Blue or Black.

The wire which is coloured Brown must be connected to the terminal marked with the letter L or P or coloured Brown or Red.

If in doubt, consult the instructions provided with the equipment or contact the supplier.

This cable/appliance should be protected by a suitably rated and approved HBC mains fuse: refer to the rating information on the equipment and/or user instructions for details. As a guide, a cable of 0.75mm² should be protected by a 3A or 5A fuse. Larger conductors would normally require 13A types, depending on the connection method used.

Any exposed wiring from a cable, plug or connection that is engaged in a live socket is extremely hazardous. If a cable or plug is deemed hazardous, turn off the mains power and remove the cable, any fuses and fuse assemblies. All hazardous wiring must be immediately destroyed and replaced in accordance to the above standard.

G E T T I N G S T A R T E D

This chapter describes the power supply in a nutshell, including its main features and front / rear panel introduction. After going through the overview, please read the theory of operation to become familiar with the operating modes, protection modes and other safety considerations.



PSU Series Overview.....	10
Series lineup	10
Main Features	11
Accessories	12
Appearance.....	15
PSU Series Front Panel.....	15
PSU Series Display and Operation Panel	18
Rear Panel.....	20
Theory of Operation	23
Operating Area Description.....	23
CC and CV Mode	24
Slew Rate	26
Bleeder Control	26
Internal Resistance	27
Alarms	28
Considerations	30
Grounding.....	33

PSU Series Overview

Series lineup

The PSU series consists of 10 models, covering a number of different current, voltage and power capacities:

Model name	Voltage Rating ¹	Current Rating ²	Power
PSU 6-200	6V	200A	1200W
PSU 12.5-120	12.5V	120A	1500W
PSU 20-76	20V	76A	1520W
PSU 40-38	40V	38A	1520W
PSU 60-25	60V	25A	1500W
PSU 100-15	100V	15A	1500W
PSU 150-10	150V	10A	1500W
PSU 300-5	300V	5A	1500W
PSU 400-3.8	400V	3.8A	1520W
PSU 600-2.6	600V	2.6A	1560W

¹Minimum voltage guaranteed to 0.2% of rating voltage.

²Minimum current guaranteed to 0.4% of rating current.

Main Features

- Performance
- High power density: 1500W in 1U
 - Universal input voltage 85~265Vac, continuous operation.
 - Output voltage up to 600V, current up to 200A.
-

- Features
- Active power factor correction.
 - Parallel master/slave operation with active current sharing.
 - Remote sensing to compensate for voltage drop in load leads.
 - 19" rack mounted ATE applications.
 - A built-in Web server.
 - OVP, OCP and OHP protection.
 - Preset memory function.
 - Adjustable voltage and current slew rates.
 - Bleeder circuit ON/OFF setting.
 - CV, CC priority start function. (Prevents overshoot with output ON)
 - Supports test scripts.
-

- Interface
- Built-in RS-232/485, LAN and USB interface.
 - Analog output programming and monitoring.
 - Optional interfaces: GPIB, Isolated Voltage (0-5V/0-10V) and Isolated Current (4-20mA) programming and monitoring interface. (Factory options)

Accessories

Before using the PSU power supply unit, check the package contents to make sure all the standard accessories are included.

Standard Accessories	Part number	Description	Qty.
		Output terminal cover	1
		Analog connector plug kit	1
		Output terminal M8 bolt set (6V~60V model)	1
		Input terminal cover	1
		Power Cord	1
	82GW1SAFE0M*1	Safety Guide	1
	62SB-8K0HD1*1	1U Handle, ROHS	2
	62SB-8K0HP1*1	1U BRACKET (LEFT), RoHS	1
	62SB-8K0HP2*1	1U BRACKET (RIGHT), RoHS	1
	CD-ROM	User manual, Programming manual	1 set
	82SU-PSU00K*1	Packing list	
	82GW-00000C*1	* CTC GW/INSTEK JAPAN USE ,RoHS	1

Factory Installed Options	Part number	Description
	PSU-GPIB	GPIB interface
	PSU-ISO-V	Voltage programming isolated analog interface
	PSU-ISO-I	Current programming isolated analog interface
	PSU-001	Front Panel Filter Kit (Operation Temperature is guaranteed to 40° C)

Optional Accessories	Part number	Description
	PSU-01C	Cable for 2 units of PSU-Series in parallel mode connection
	PSU-01B	Bus Bar for 2 units of PSU-Series in parallel mode connection
	PSU-01A	Joins a vertical stack of 2 PSU units together. 2U-sized handles x2, joining plates x2.
	PSU-02C	Cable for 3 units of PSU-Series in parallel mode connection
	PSU-02B	Bus Bar for 3 units of PSU-Series in parallel mode connection
	PSU-02A	Joins a vertical stack of 3 PSU units together. 3U-sized handles x2, joining plates x2.
	PSU-03C	Cable for 4 units of PSU-Series in parallel mode connection
	PSU-03B	Bus Bar for 4 units of PSU-Series in parallel mode connection
	PSU-03A	Joins a vertical stack of 4 PSU units together. 4U-sized handles x2, joining plates x2.
	PSU-232	RS232 cable with DB9 connector kit. It Includes RS232 cable with DB9 connector, RS485 used master cable (gray plug), slave cable (black plug) and end plug terminal.
	PSU-485	RS485 cable with DB9 connector kit. It Includes RS485 cable with DB9 connector, RS485 used master cable (gray plug), slave cable (black plug) and end plug terminal.
	GRM-001	Rack-mount slides (General Devices P/N: C-300-S-116-RH-LH)

GTL-246	USB Cable 2.0-A-B Type, Approx. 1.2M
GPW-001	Power Cord SJT 12AWG/3C, 3m MAX Length, 105 °C, RNB5-5*3P UL/CSA type
GPW-002	Power Cord H05W-F 1.5mm ² /3C, 3m MAX Length, 105 °C, RNB5-5*3P VDE type
GPW-003	Power Cord VCTF 3.5mm ² /3C, 3m MAX Length, 105 °C, RNB5-5*3P PSE type

Download	Name	Description
	psu_cdc.inf	PSU USB driver
Other	Name	Description
	Certificate of traceable calibration	

Appearance

PSU Series Front Panel

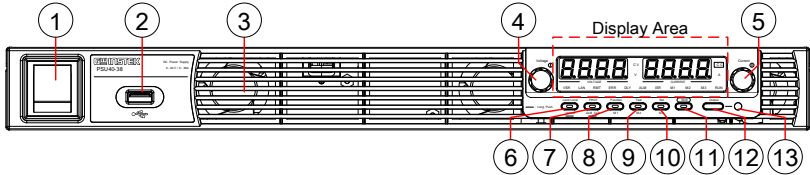

1. Power Switch

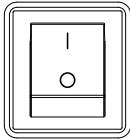

Used to turn the power on/off.

2. USB A Port



USB A port for data transfer, loading test scripts etc.

3. Air Inlet

Air inlet for cooling the inside of the PSU series.

4. Voltage Knob

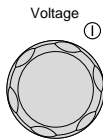



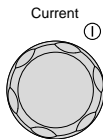

Used to set the voltage value or select a parameter number in the Function settings.

Display Area The display area shows setting values, output values and parameter settings. The function LEDs below show the current status and mode of the power supply. See page 18 for details.

5. Current Knob



Used to set the current value or change the value of a Function parameter.

- | | | |
|-----------------------------|---|--|
| <p>6. Lock/Local Button</p> | <p>Lock/Local</p>  | <p>Used to lock all front panel buttons other than the Output Button or it switches to local mode.</p> |
| <p>Unlock Button</p> | | <p>(Long push) Used to unlock the front panel buttons.</p> |
| <p>7. PROT Button</p> | <p>PROT</p>  | <p>Used to set and display OVP, OCP and UVL.</p> |
| <p>ALM_CLR Button</p> | | <p>(Long push) Used to release protection functions that have been activated.</p> |
| <p>8. Function Button</p> | <p>Function</p>  | <p>Used to configure the various functions.</p> |
| <p>M1 Button</p> | | <p>(+Shift) Used to recall the M1 setup.
(+Shift and hold) Used to save the current setup to M1.</p> |
| <p>9. Test Button</p> | <p>TEST</p>  | <p>Used to run customized scripts for testing.</p> |
| <p>M2 Button</p> | | <p>(+Shift) Used to recall the M2 setup.
(+Shift and hold) Used to save the current setup to M2.</p> |
| <p>10. Set Button</p> | <p>SET</p>  | <p>Used to set and confirm the output voltage and output current.</p> |
| <p>M3 Button</p> | | <p>(+Shift) Used to recall the M3 setup.
(+Shift and hold) Used to save the current setup to M3.</p> |

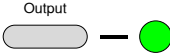
11. Shift Button  Used to enable the functions that are written in blue characters below certain buttons.
12. Output Button  Used to turn the output on or off.
13. Output ON LED Lights in green when the output is on.

PSU Series Display and Operation Panel

Display Area

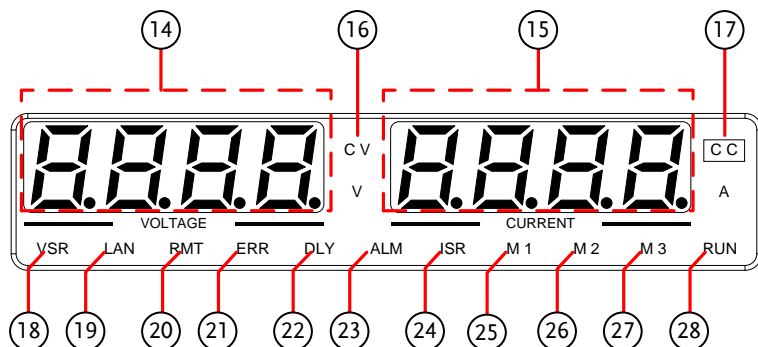

- | | |
|-------------------|---|
| 14. Voltage Meter | Displays the voltage or the parameter number of a Function parameter. |
| 15. Current Meter | Displays the current or the value of a Function parameter. |
| 16. CV LED | Lights in green during constant voltage mode. |
| 17. CC LED | Lights in green during constant current mode. |
| 18. VSR LED | Lights up when CV Slew Rate Priority is enabled. |
| 19. LAN LED | Lights up when the LAN interface is connected. |
| 20. RMT LED | Lights in green during remote control. |
| 21. ERR LED | Lights in red when an error has occurred. |
| 22. DLY LED | The Output On/Off Delay indicator LED. |
| 23. ALM LED | Lights in red when a protection function has been activated. |

- 24. ISR LED Lights up when CC Slew Rate Priority is enabled.
- 25. M1 LED Lights in green when the memory value are being recalled or saved.
- 26. M2 LED Lights in green when the memory value are being recalled or saved.
- 27. M3 LED Lights in green when the memory value are being recalled or saved.
- 28. RUN LED Lights up when a Test Script has been activated.



Note

Only the ERR and ALM LED's are red. All the others are green.

Rear Panel

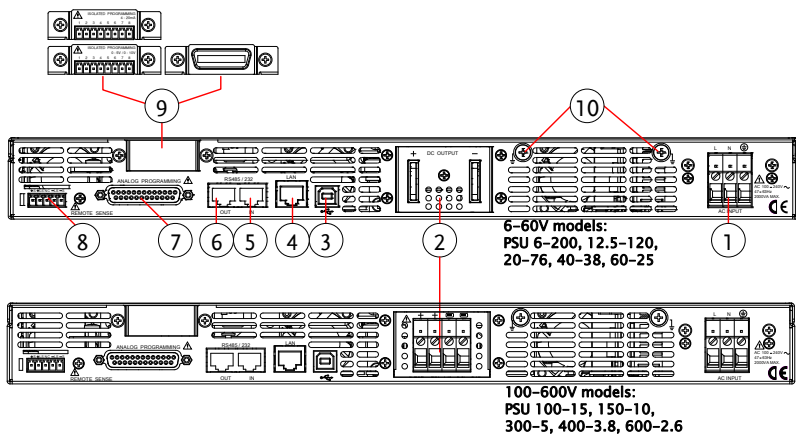

1. AC Input

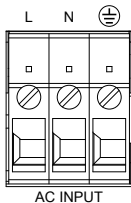

Wire clamp connector.

2. DC Output

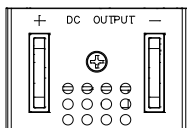

Output terminals for 6V to 60V models.

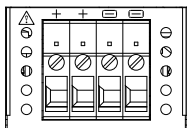

Output terminals for 100V to 600V models.

3. USB

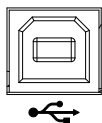

USB port for controlling the PSU remotely.

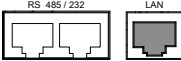
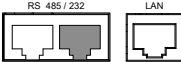
- 4. LAN  Ethernet port for controlling the PSU remotely.
- 5. Remote-IN  Two different types of cables can be used for RS232 or RS485-based remote control.

PSU-232: RS232 cable with DB9 connector kit.

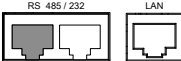
PSU-485: RS485 cable with DB9 connector kit.
- 6. Remote-OUT  RJ-45 connector that is used to daisy chain power supplies with the Remote-IN port to form a communication bus.

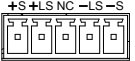
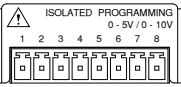
PSU-485S: Serial link cable with RJ-45 shielded connector.
- 7. Analog Control  External analog control connector.
- 8. Remote Sense  Compensation of load wire drop.
- 9. Option Slot  Blank sub-plate for standard units.
Isolated Analog connector for units equipped with Isolated Current and Voltage Programming and Monitoring option.
GPIB connector for units equipped with IEEE programming option.

10. Ground Screw

Connectors for grounding the output (two positions, shown in red).

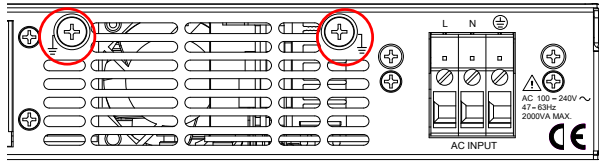

Theory of Operation

The theory of operation chapter describes the basic principles of operation, protection modes and important considerations that must be taken into account before use.

Operating Area Description

Background

The PSU power supplies are regulated DC power supplies with a high voltage and current output. These operate in CC or CV mode within a wide operating range limited only by the voltage or current output.

The operating area of each power supply is determined by the rated output power as well as the voltage and current rating.

Below is a comparison of the operating areas of each power supply.

PSU Series Operating Area (6-60V models)

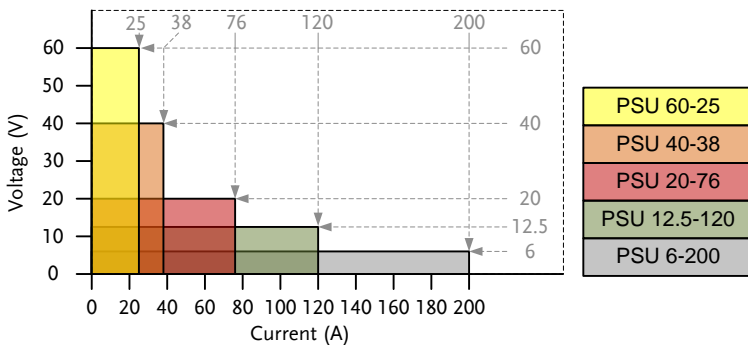

PSU Series Operating Area (100-600V models)

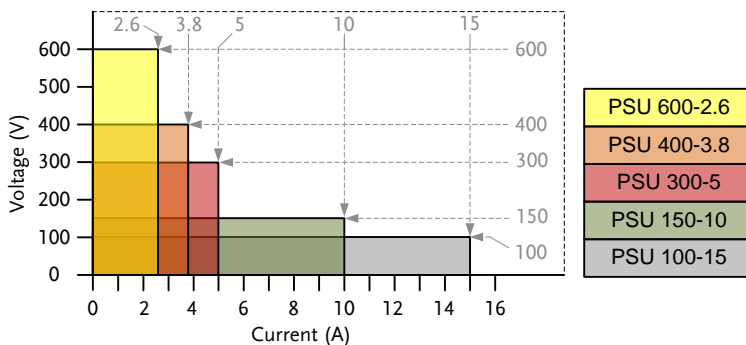

CC and CV Mode

CC and CV mode Description

When the power supply is operating in constant current mode (CC) a constant current will be supplied to the load. When in constant current mode the voltage output can vary, whilst the current remains constant. When the load resistance increases to the point where the set current limit (I_{SET}) can no longer be sustained the power supply switches to CV mode. The point where the power supply switches modes is the crossover point.

When the power supply is operating in CV mode, a constant voltage will be supplied to the load, whilst the current will vary as the load varies. At the point that the load resistance is too low to maintain a constant voltage, the power supply will switch to CC mode and maintain the set current limit.

The conditions that determine whether the power supply operates in CC or CV mode depends on the set current (I_{SET}), the set voltage

(V_{SET}), the load resistance (R_L) and the critical resistance (R_C). The critical resistance is determined by V_{SET}/I_{SET} . The power supply will operate in CV mode when the load resistance is greater than the critical resistance. This means that the voltage output will be equal to the V_{SET} voltage but the current will be less than I_{SET} . If the load resistance is reduced to the point that the current output reaches the I_{SET} level, the power supply switches to CC mode.

Conversely the power supply will operate in CC mode when the load resistance is less than the critical resistance. In CC mode the current output is equal to I_{SET} and the voltage output is less than V_{SET} .

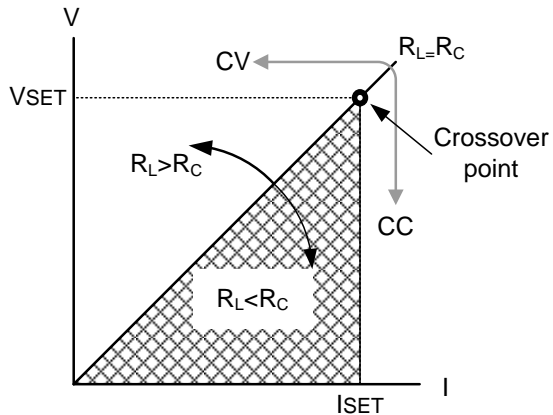

For loads that generate a transient surge voltage, V_{SET} must be set so that the surge voltage does not reach the voltage limit.

For loads in which transient peak current flows, I_{SET} must be set so that the peak value does not reach the current limit.

Slew Rate

Theory

The PSU has selectable slew rates for CC and CV mode. This gives the PSU power supply the ability to limit the current/voltage draw of the power supply. Slew rate settings are divided into High Speed Priority and Slew Rate Priority. High speed priority mode will use the fastest slew rate for the instrument. Slew Rate Priority mode allows for user adjustable slew rates for CC or CV mode. The rising and falling slew rate can be set independently.

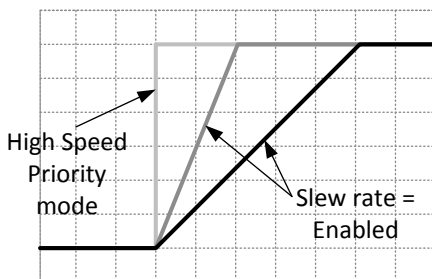

Bleeder Control

Background

The PSU DC power supplies employ a bleed resistor in parallel with the output terminals.

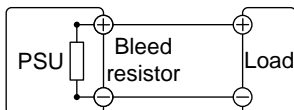

Bleed resistors are designed to dissipate the power from the power supply filter capacitors when power is turned off and the load is disconnected. Without a bleed resistor, power may remain charged on the filter capacitors for

some time and be potentially hazardous.

In addition, bleed resistors also allow for smoother voltage regulation of the power supply as the bleed resistor acts as a minimum voltage load.

The bleed resistance can be turned on or off using the configuration settings.



Note

By default the bleed resistance is on. For battery charging applications, be sure to turn the bleed resistance off as the bleed resistor can discharge the connected battery when the unit is off.

Internal Resistance

Background

On the PSU, the internal resistance of the power supply can be user-defined in software. (Internal Resistance Setting, see the Normal Function Settings on page 104.) When the internal resistance is set it can be seen as a resistance in series with the positive output terminal. This allows the power supply to simulate power sources that have internal resistances such as lead acid batteries.

By default the internal resistance is 0Ω .

Internal Resistance Range

Unit Model	Internal Resistance Range
PSU 6-200	0.000 ~ 0.030 Ω
PSU 12.5-120	0.000 ~ 0.104 Ω
PSU 20-76	0.000 ~ 0.263 Ω
PSU 40-38	0.000 ~ 1.053 Ω
PSU 60-25	0.000 ~ 2.400 Ω
PSU 100-15	0.000 ~ 6.667 Ω
PSU 150-10	0.00 ~ 15.00 Ω
PSU 300-5	0.00 ~ 60.00 Ω
PSU 400-3.8	0.0 ~ 105.3 Ω
PSU 600-2.6	0.0 ~ 230.8 Ω

Alarms

The PSU power supplies have a number of protection features. When one of the protection alarms is tripped, the ALM icon on the display will be lit and the type of alarm that has been tripped will be shown on the display. When an alarm has been tripped the output will be automatically turned off. For details on how to clear an alarm or to set the protection modes, please see page 53.

OVP	Over voltage protection (OVP) prevents a high voltage from damaging the load. This alarm can be set by the user.
OCP	Over current protection prevents high current from damaging the load. This alarm can be set by the user.
UVL	Under voltage limit. This function sets a minimum voltage setting level for the output. It can be set by the user.
OHP	Over temperature protection for slave and master board. OHP is a hardware protection function. Only when the unit has cooled can the over temperature protection alarms be cleared.
OH1	Master board over temperature protection.
OH2	Slave board over temperature protection.
ALM SENS	Sense alarm. This alarm will detect if the sense wires have been connected to the wrong polarity.
HW OVP	Hardware over voltage protection. This is a hardware OVP that is fixed at approximately 120% of the rated voltage output.

AC	AC Fail. This alarm function is activated when a low AC input is detected.
FAN FAIL	Fan failure. This alarm function is activated when the fan RPMs drop to an abnormally low level.
Shutdown	Force Shutdown is not activated as a result of the PSU series detecting an error. It is a function that is used to turn the output off through the application of a signal from the rear-panel analog control connector when an abnormal condition occurs.
Alarm output	Alarms are output via the analog control connector. The alarm output is an isolated open-collector photo coupler output.

Considerations

The following situations should be taken into consideration when using the power supply.

Inrush current	When the power supply switch is first turned on, an inrush current is generated. Ensure there is enough power available for the power supply when first turned on, especially if a number of units are turned on at the same time.
----------------	--

Pulsed or Peaked loads	When the load has current peaks or is pulsed, it is possible for the maximum current to exceed the mean current value. The PSU power supply ammeter only indicates mean current values, which means for pulsed current loads, the actual current can exceed the indicated value. For pulsed loads, the current limit must be increased, or a power supply with a greater capacity must be chosen. As shown below, a pulsed load may exceed the current limit and the indicated current on the power supply ammeter.
------------------------	---

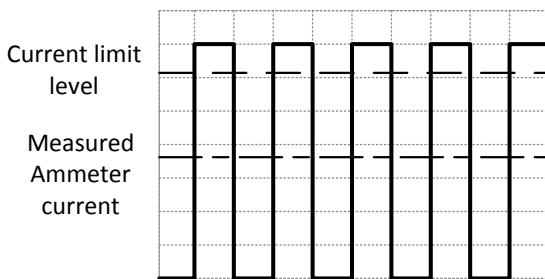

Reverse Current:
Regenerative load

When the power supply is connected to a regenerative load such as a transformer or inverter, reverse current will feed back to the power supply. The PSU power supply cannot absorb reverse current. For loads that create reverse current, connect a resistor in parallel to the power supply to bypass the reverse current. This description only applies when the bleed resistance is off.

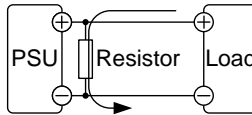

Reverse current



The current output will decrease by the amount of current absorbed by the resistor.

Ensure the resistor used can withstand the power capacity of the power supply/load.

Reverse Current:
Accumulative energy.

When the power supply is connected to a load such as a battery, reverse current may flow back to the power supply. To prevent damage to the power supply, use a reverse-current-protection diode in series between the power supply and load.

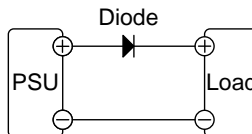

**CAUTION**

Ensure the reverse withstand voltage of the diode is able to withstand 2 times the rated output voltage of the power supply and the forward current capacity can withstand 3 to 10 times the rated output current of the power supply.

Ensure the diode is able to withstand the heat generated in the following scenarios.

When the diode is used to limit reverse voltage, remote sensing cannot be used.

Grounding

The output terminals of the PSU power supplies are isolated with respect to the protective grounding terminal. The insulation capacity of the load, the load cables and other connected devices must be taken into consideration when connected to the protective ground or when floating.

Floating

As the output terminals are floating, the load and all load cables must have an insulation capacity that is greater than the isolation voltage of the power supply.

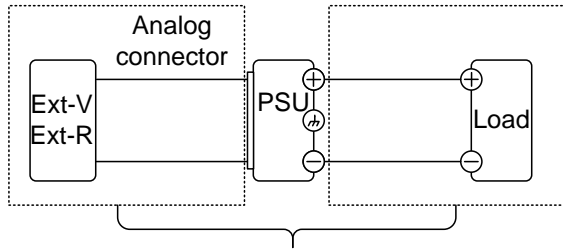

(-----) Insulation capacity \geq isolation voltage of power supply



WARNING

If the insulation capacity of the load and load cables are not greater than the isolation voltage of the power supply, electric shock may occur.

Grounded output terminal

If the positive or negative terminal is connected to the protective ground terminal, the insulation capacity needed for the load and load cables is greatly reduced. The insulation capacity only needs to be greater than the maximum output voltage of the power supply with respect to ground.

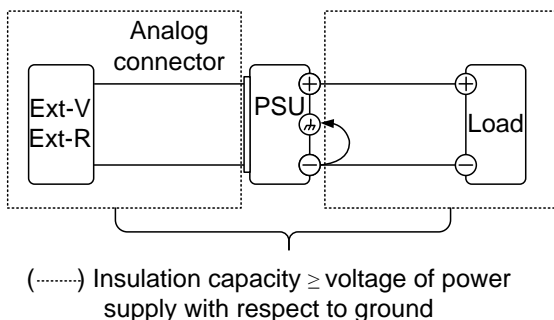

CAUTION

If using external voltage control, do not ground the external voltage terminal as this will create a short circuit.

Example of grounded output terminals:

PSU 6-200, 12.5-120, 20-76, 40-38, 60-25

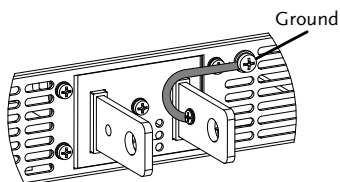

PSU 100-15, 150-10, 300-5, 400-3.8, 600-2.6

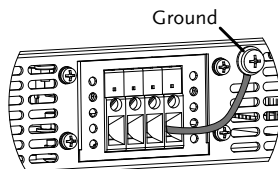

O PERATION

Set Up	37
Line Voltage Connection.....	37
Power Up	39
Wire Gauge Considerations	40
Output Terminals	42
Using the Output Terminal Cover.....	44
Using the Rack Mount Kit	45
How to Use the Instrument	46
Reset to Factory Default Settings	48
View System Version and Build Date	49
Basic Operation	53
Setting OVP/OCP/UVL Levels.....	53
Set to C.V. Priority Mode	57
Set to C.C. Priority Mode	60
Panel Lock.....	63
Save Setup	63
Recall Setup.....	64
Voltage Sense.....	65
Remote Sense Connector	65
Remote Sense Cover	66
Local Sense	67
Remote Sense	67
Parallel / Series Operation	71
Master-Slave Parallel Overview	72
Master-Slave Parallel Connection	75
Master-Slave Parallel Operation	78
Master-Slave Parallel Calibration.....	80
Master-Slave Series Overview.....	82
Series Connection	84
Series Operation.....	86
Test Scripts	88
Test Script File Format	89
Test Script Settings	89
Setting the Test Script Settings.....	90

Load Test Script from USB.....	91
Run Test Script.....	92
Export Test Script to USB	93
Remove Test Script.....	94

Set Up

Line Voltage Connection

Background The PSU power supplies use a universal power input that can be used with 100 and 240 Vac systems. To connect or replace the power cord (user supplied, specification below), use the procedure below:



The following procedure should only be attempted by competent persons.

Ensure the AC power cord is not connected to power. Always allow the power supply to fully discharge before disconnecting the AC power cord.

Recommended Power Cord Specifications 25A 250V, 3x12 AWG, outer diameter: 9-11 mm, rated 60 °C min., 3m maximum length and approved by the national safety standards for the country of use.



There are two type power cord protective sheaths in the standard accessories. One is black color and it is used for outer diameter:8~13.5mm power cord.

The other is gray color and it is used for outer diameter:5.5~11.2mm power cord.

The PSU has a number of power cord options available. Please see the optional accessories on page 12 for details.

Removal

1. Turn off the power switch and unplug the power from the socket.

2. Unscrew the power cord protective sheath.
3. Remove the 2 screws holding the power cord cover and remove.
4. Remove the AC power cord wires with a flat head screwdriver.

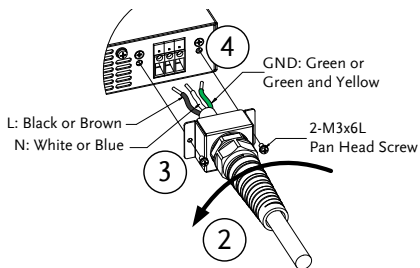

Installation

1. Connect the AC power cord wires to the AC input terminals.

- Black/Brown → Line (L)
- White/Blue → Neutral (N)
- Green /Green & Yellow → Ground (⊥)

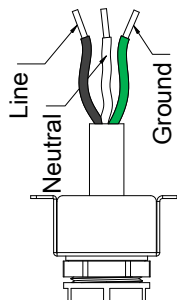
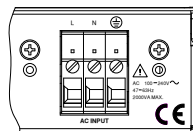

2. Make sure the sheath is tightened to the lock nut.
3. Re-install the power cord cover.

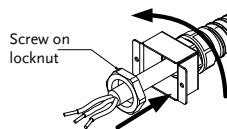

Power Up

- | | | |
|-------|---|---|
| Steps | 1. Connect the power cord to the universal power input. | Page 37 |
| | 2. Press the POWER switch on. |  |
| | 3. The power supply will show the Power On settings (Pon) at start up. If no Power On settings are configured, the PSU will recover the state right before the power was last turned OFF. If used for the first time, the default settings will appear on the display.
For default configuration settings, see page 197. | |

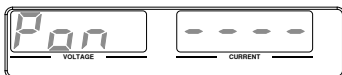

You may also configure how the PSU will behave on startup by altering the Power On Configuration settings, see page 112.

Power Down

To turn the PSU power supply off, press the power switch again (0 position). It may take a few seconds for the power supply to fully turn off.



The power supply takes around 8 seconds to fully turn on or shutdown.

Do not turn the power on and off quickly. Please wait for the display to fully turn off.

Wire Gauge Considerations

Background Before connecting the output terminals to a load, the wire gauge of the cables should be considered.

It is essential that the current capacity of the load cables is adequate. The rating of the cables must equal or exceed the maximum current rated output of the instrument.

Recommended wire gauge	Wire Gauge	Nominal Cross Section	Maximum Current
	20	0.5	9
	18	0.75	11
	18	1	13
	16	1.5	18
	14	2.5	24
	12	4	34
	10	6	45
	8	10	64
	6	16	88
	4	25	120
	2	32	145
	1	50	190
	00	70	240
	000	95	290
	0000	120	340

The maximum temperature rise can only be 60 degrees above the ambient temperature. The ambient temperature must be less than 30 degrees.

To minimize noise pickup or radiation, the load wires and remote sense wires should be twisted-pairs of the shortest possible length. Shielding of the sense leads may be necessary

in high noise environments. Where shielding is used, connect the shield to the chassis via the rear panel ground screw. Even if noise is not a concern, the load and remote sense wires should be twisted-pairs to reduce coupling, which might impact the stability of the power supply. The sense leads should be separated from the power leads.

Output Terminals

- Background** Before connecting the output terminals to the load, first consider whether voltage sense will be used, the gauge of the cable wiring and the withstand voltage of the cables and load.
- The output terminals are of two types:
- two solid bars equipped with M8 sized bolt and nuts for low voltage models (PSU 6-200, 12.5-120, 20-76, 40-38, 60-25),
 - clamp block terminals for medium and high voltage models (PSU 100-15, 150-10, 300-5, 400-3.8, 600-2.6).
-



Dangerous voltages. Ensure that the power to the instrument is disabled before handling the power supply output terminals. Failing to do so may lead to electric shock.

Steps

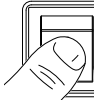
1. Turn the power switch off. 
2. Remove the output terminal cover. Page 44
3. If necessary, connect the chassis ground terminal to either the positive or negative terminal. See the grounding chapter for details. Page 33
4. Choose a suitable wire gauge and crimping terminal for the load cables. Page 40

5. Connect the positive load cable to the positive output terminal and the negative cable to the negative output terminal.
6. Reattach the output terminal cover. Page 44

Connection

Example

(PSU 6-200, 12.5-120, 20-76, 40-38, 60-25)

Use the included M8-sized bolt set to connect the load cables to the output terminals. Make sure that the connections are tight and that washers and spring washers are used to ensure a good connection.

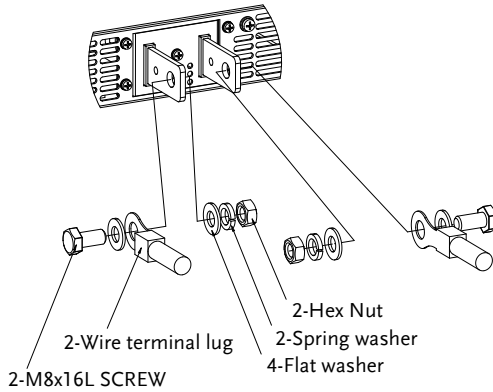

(PSU 100-15, 150-10, 300-5, 400-3.8, 600-2.6) Simply secure the stripped connectors inside each terminal.

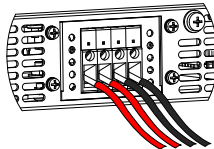

Using the Output Terminal Cover

Steps

1. Partially unscrew the 2 screws beside the terminals.
2. Line-up the notches in the cover with the 2 screws.
3. Tighten the screws to secure the cover over the terminals.

(PSU 6-200, 12.5-120, 20-76, 40-38, 60-25)

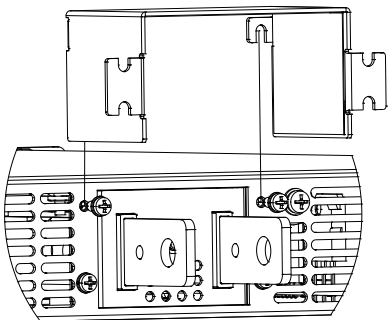

(PSU 100-15, 150-10, 300-5, 400-3.8, 600-2.6)

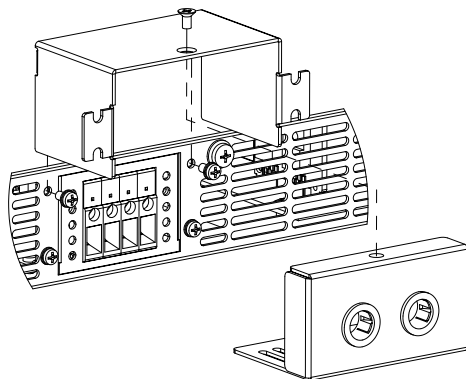

Removal

Reverse the procedure to remove the terminal covers.

Using the Rack Mount Kit

Background

The PSU series are designed to be directly mounted into 19 inch 1U rack mounts.

The PSU can be installed using the sliding mounts (GW Part number: GRM-001). See the GRM-001 manual for installation instructions.

Rack mount diagram: Sliding mounts

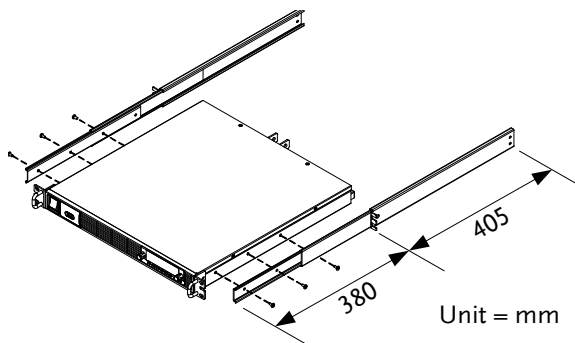

The following diagram shows the approximate dimensions of the GRM-001 sliding mounts. These sliding mounts should only be used within racks with a depth of 500mm.

How to Use the Instrument

Background The PSU power supplies use a novel method of configuring parameter values only using the voltage or current knobs. The knobs are used to quickly edit parameter values at 0.01, 0.1 or 1 unit steps at a time.

When the user manual says to set a value or parameter, use the steps below.

Example Use the Voltage knob to set a voltage of 10.05 volts.

1. Repeatedly press the Voltage knob until the least significant digit is highlighted. This will allow the voltage to be edited in 0.01 volt steps.

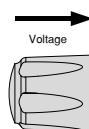

2. Turn the Voltage knob till 0.05 volts is shown on the voltage display.

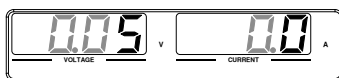
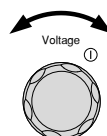

3. Repeatedly press the Voltage knob until the most significant digit is highlighted. This will allow the voltage to be edited in 1 volt steps.
4. Turn the Voltage knob until 10.05 is shown.

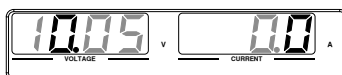



Note

Notice the Set key becomes illuminated when setting the current or voltage.

If the voltage or current knobs are unresponsive, press the Set key first.

Reset to Factory Default Settings

Background The F-88 configuration setting allows the PSU to be reset back to the factory default settings. See page 197 for the default factory settings.

Steps

1. Press the Function key. The Function key will light up. 
2. The display should show F-01 on the top and the configuration setting for F-01 on the bottom.

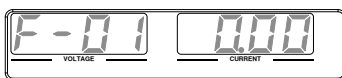

3. Rotate the Voltage knob to change the F setting to F-88 (Factory Set Value).

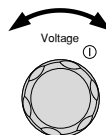

4. Use the Current knob to set the F-88 setting to 1 (Return to factory default settings).

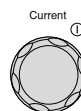

5. Press the Voltage knob to confirm. Conf will be displayed when it is configuring.

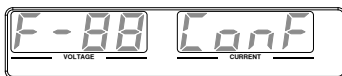
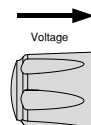

6. Press the Function key again to exit. The Function key light will turn off. 

View System Version and Build Date

Background The F-89 configuration setting allows you to view the PSU version number, build date, keyboard version, analog-control version, kernel build, test command version and test command build date.

Steps

1. Press the Function key. The Function key will light up.



2. The display should show F-01 on the top and the configuration setting for F-01 on the bottom.

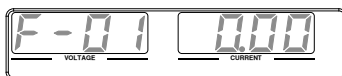

3. Rotate the Voltage knob to change the F setting to F-89 (Show Version).

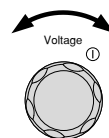

4. Rotate the Current knob to view the version and build date for the various items.

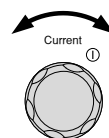

- F-89 0-XX: Version (1/2)
- 1-XX: Version (2/2)
- 2-XX: Build On-Year. (1/2)
- 3-XX: Build On-Year. (2/2)
- 4-XX: Build On-Month.
- 5-XX: Build On-Day.
- 6-XX: Keyboard CPLD. (1/2)
- 7-XX: Keyboard CPLD. (2/2)
- 8-XX: Analog Board CPLD. (1/2)
- 9-XX: Analog Board CPLD. (2/2)
- A-XX: Analog Board FPGA (1/2)
- B-XX: Analog Board FPGA. (1/2)
- C-XX: Kernel Build On-Year. (1/2)
- D-XX: Kernel Build On-Year. (2/2)
- E-XX: Kernel Build On-Month.
- F-XX: Kernel Build On-Day.
- G-XX: Test Command Version. (1/2)
- H-XX: Test Command Version. (2/2)
- I-XX: Test Command Build On-Year. (1/2)
- J-XX: Test Command Build On-Year. (2/2)
- K-XX: Test Command Build On-Month.
- L-XX: Test Command Build On-Day.
- M-XX: Reserved. (1/2)
- N-XX: Reserved. (2/2)
- O-XX: Option version. (1/2)
- P-XX: Option version. (2/2)

5. Press the Function key again to exit. The Function key light will turn off.



Example

Main Program Version: V01.00, 2013/06-01

- 0-01: Version
- 1-00: Version
- 2-20: Build On-Year.
- 3-13: Build On-Year.
- 4-06: Build On-Month.
- 5-01: Build On-Day.

Example	Keyboard CPLD Version: 0x030C 6-03: Keyboard CPLD Version. 7-0C: Keyboard CPLD Version.
Example	Analog CPLD Version: 0x0421 8-04: Analog CPLD Version. 9-21: Analog CPLD Version.
Example	Analog Board FPGA: 0x0241 A-02: Analog FPGA Version. B-41: Analog FPGA Version.
Example	Kernel Version: 2013/01/22 C-20: Kernel Build On-Year. D-13: Kernel Build On-Year. E-01: Kernel Build On-Month. F-22: Kernel Build On-Day.
Example	Test Command Version: V01:00, 2013/06/01 G-01: Test Command Version. H-00: Test Command Version. I-20: Test Command Build On-Year. J-13: Test Command Build On-Year. K-06: Test Command Build On-Month. L-01: Test Command Build On-Day.
Example	Reserved: M-XX: Reserved. N-XX: Reserved.

Example

Option version

O-XX: Option version. (1/2)

P-XX: Option version. (2/2)

Basic Operation

This section describes the basic operations required to operate the power supply.

- Setting OVP/OCP/UVL → from page 53
- C.V. priority mode → from page 57
- C.C. priority mode → from page 60
- Panel lock → page 63
- Save/Recall setups → from page 63/64
- Voltage Sense → from page 65

Before operating the power supply, please see the Getting Started chapter, page 9.

Setting OVP/OCP/UVL Levels

The OVP level and OCP level has a selectable range that is based on the output voltage and output current, respectively. The OVP and OCP level is set to the highest level by default. The actual selectable OVP and OCP range depends on the PSU model.

When one of the protection measures are on, ALM indicator is lit red on the front panel and the type of alarm is also shown on the display. The ALM_CLR button can be used to clear any protection functions that have been tripped. By default, the output will turn off when the OVP or OCP protection levels are tripped.

The UVL will prevent you from setting a voltage that is less than the UVL setting. The UVL setting range is from 0% ~ 105% of the rated output voltage.

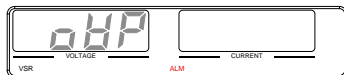

Example: OVP alarm

Before setting the protection settings:

- Ensure the load is not connected.
- Ensure the output is turned off.



Note

You can use the Function settings (F-13 and F-14) to apply limits to the voltage and current settings, respectively. You can set limitations so that the values do not exceed the set OVP and the set OCP level, and so that the values are not lower than the set UVL trip point.

By using this feature, you can avoid turning the output off by mistakenly setting the voltage or current to a value that exceeds the set OVP or OCP level or to a value that is lower than the set UVL trip point.

If you have selected to limit the voltage setting (F-14), you will no longer be able to set the output voltage to a value that is above about 95% of the OVP trip point or to a value that is lower than the UVL trip point.

If you have selected to limit the current setting (F-13), you will no longer be able to set the output current to a value that is above about 95% of the OCP trip point.

Steps

1. Press the PROT key. The PROT key lights up.



- The OVP protection function will be displayed on the voltage display and the setting will be displayed on the current display.

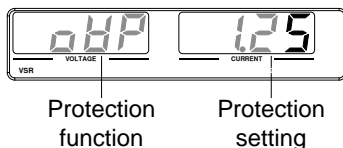

Choose a Protection Function

- Use the Voltage knob to select a protection function.

Range OVP, OCP, UVL

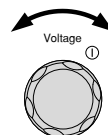

Setting the Protection Level

- Use the Current knob to set the protection level for the selected function.

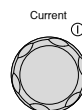

PSU Model	Setting Range		
	OCP	OVP	UVL
6-200	5~220	0.6~6.6	0~6.3
12.5-120	5~132	1.25~13.75	0~13.12
20-76	5~83.6	2~22	0~21
40-38	3.8~41.8	4~44	0~42
60-25	2.5~27.5	5~66	0~63
100-15	1.5~16.5	5~110	0~105
150-10	1~11	5~165	0~157.5
300-5	0.5~5.5	5~330	0~315
400-3.8	0.38~4.18	5~440	0~420
600-2.6	0.26~2.86	5~660	0~630

- Press PROT again to exit. The PROT key light will turn off.



Clear
OVP/OCP/UVL
protection

The OVP, OCP or UVL protection
can be cleared after it has been
tripped by holding the ALM_CLR
button for 3 seconds.

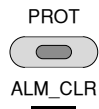

Set to C.V. Priority Mode

When setting the power supply to constant voltage mode, a current limit must also be set to determine the crossover point. When the current exceeds the crossover point, the mode switches to C.C. mode. For details about C.V. operation, see page 24. C.C. and C.V. mode have two selectable slew rates: High Speed Priority and Slew Rate Priority. High Speed Priority will use the fastest slew rate for the instrument while Slew Rate Priority will use a user-configured slew rate.

Background Before setting the power supply to C.V. mode, ensure:

- The output is off.
- The load is connected.

Steps

1. Press the Function key. The Function key will light up. 
2. The display will show the function (F-01) on the voltage display and the setting for the function in the current display.

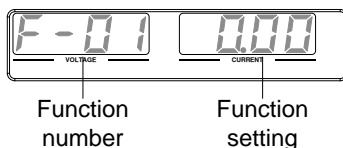

3. Rotate the Voltage knob to change the F setting to F-03 (V-I Mode Slew Rate Select).

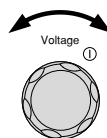

- Use the Current knob to set the F-03 setting.



Set F-03 to 0 (CV High Speed Priority) or 2 (CV Slew Rate Priority).

F-03 0 = CV High Speed Priority
 2 = CV Slew Rate Priority

- Press the Voltage knob to save the configuration setting. ConF will be displayed when it is configuring.

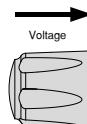

VSR indicator for CV Slew Rate Priority (F-03=2)

- If CV Slew Rate Priority was chosen as the operating mode, set F-04 (Voltage Slew Rate Up) and the F-05 (Voltage Slew Rate Down) and save.

F-04 / F-05 0.001V~0.06V/msec (PSU 6-200)
 0.001V~0.125V/msec (PSU 12.5-120)
 0.001V~0.2V/msec (PSU 20-76)
 0.001V~0.4V/msec (PSU 40-38)
 0.001V~0.6V/msec (PSU 60-25)
 0.001V~1.000V/msec (PSU 100-15)
 0.001V~1.500V/msec (PSU 150-10)
 0.001V~1.500V/msec (PSU 300-5)
 0.001V~2.000V/msec (PSU 400-3.8)
 0.001V~2.400V/msec (PSU 600-2.6)

7. Press the Function key again to exit the configuration settings. The function key light will turn off.



8. Use the Current knob to set the current limit (crossover point).

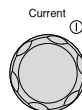

9. Use the Voltage knob to set the voltage.

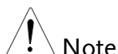
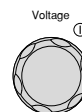

Note

Notice the Set key becomes illuminated when setting the current or voltage. If the Voltage or Current knobs are unresponsive, press the Set key first.

10. Press the Output key. The Output ON LED becomes lit.

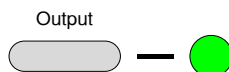

CV will become illuminated (center)

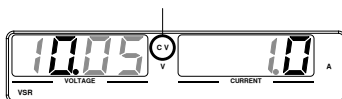

Note

Only the voltage level can be altered when the output is on. The current level can only be changed by pressing the Set key.

For more information on the Normal Function Settings, see page 104.

Set to C.C. Priority Mode

When setting the power supply to constant current mode, a voltage limit must also be set to determine the crossover point. When the voltage exceeds the crossover point, the mode switches to C.V. mode. For details about C.C. operation, see page 24. C.C. and C.V. mode have two selectable slew rates: High Speed Priority and Slew Rate Priority. High Speed Priority will use the fastest slew rate for the instrument while Slew Rate Priority will use a user-configured slew rate.

Background Before setting the power supply to C.C. mode, ensure:

- The output is off.
- The load is connected.

Steps

1. Press the Function key. The Function key will light up.



2. The display will show the function (F-01) on the voltage display and the setting for the function in the current display.

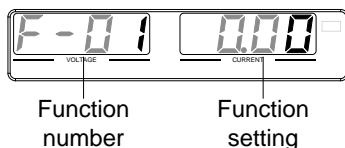

3. Rotate the Voltage knob to change the F setting to F-03 (V-I Mode Slew Rate Select).

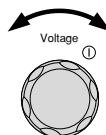

4. Use the Current knob to set the F-03 setting.

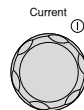

Set F-03 to 1 (CC High Speed Priority) or 3 (CC Slew Rate Priority) and save.

F-03 1 = CC High Speed Priority
 3 = CC Slew Rate Priority

5. Press the Voltage knob to save the configuration setting. ConF will be displayed when it is configuring.

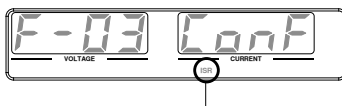
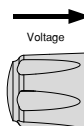

ISR indicator for CC Slew Rate Priority (F-03=3)

6. If CC Slew Rate Priority was chosen as the operating mode, set F-06 (Current Slew Rate Up) and F-07 (Current Slew Rate Down) and save.

F-06 / F-07 0.001A~2A / msec (PSU 6-200)
 0.001A~1.2A / msec (PSU 12.5-120)
 0.001A~0.76A / msec (PSU 20-76)
 0.001A~0.38A / msec (PSU 40-38)
 0.001A~0.25A / msec (PSU 60-25)
 0.001A~0.150A / msec (PSU 100-15)
 0.001A~0.100A / msec (PSU 150-10)
 0.001A~0.025A / msec (PSU 300-5)
 0.001A~0.008A / msec (PSU 400-3.8)
 0.001A~0.006A / msec (PSU 600-2.6)

7. Press the Function key again to exit the configuration settings. The Function key light will turn off.



8. Use the Voltage knob to set the voltage limit (crossover point).

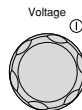

9. Use the Current knob to set the current.



Note

Notice the Set key becomes illuminated when setting the current or voltage. If the Voltage or Current knobs are unresponsive, press the Set key first.

10. Press the Output key. The Output key becomes illuminated.

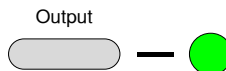

CC will become illuminated (right)

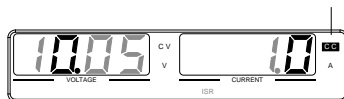

Note

Only the current level can be altered when the output is on. The voltage level can only be changed by pressing the Set key.



For more information on the Normal Function Settings, see page 104.

Panel Lock

The panel lock feature prevents settings from being changed accidentally. When activated, the Lock/Local key will become illuminated and all keys and knobs except the Lock/Local key and Output key (if active) will be disabled.



If the instrument is remotely controlled via the USB/LAN interface, the panel lock is automatically enabled.

Activate the panel lock	Press the Lock/Local key to activate the panel lock. The key will become illuminated.	Lock/Local 
-------------------------	---	---

Disable the panel lock	Hold the Lock/Local key for ~3 seconds to disable the panel lock. The key's light will turn off.	Lock/Local  Unlock 
------------------------	--	--

Save Setup

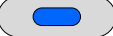
The PSU has 3 dedicated keys (M1, M2, M3) to save the set current, set voltage, OVP, OCP and ULV settings.

Save Setup	1. Press the SHIFT key. The shift key will light blue. 2. Hold the desired memory key for >3 seconds (M1, M2, M3).	  Function  M1 (hold)
------------	---	--

- When the setup is saved the unit will beep, the setup will be saved and the memory number will be shown on the display.

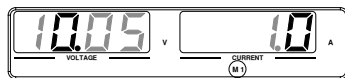

Saved setup

Recall Setup

The PSU has 3 dedicated keys (M1, M2, M3) to recall setups.

Recall Setup

- Press the SHIFT key. The shift key will light blue.
- Press the desired memory key to recall the desired setup (M1, M2, M3).

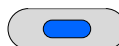

Function

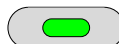

M1

- When the setup is recalled the setup will be loaded and the memory number will be shown on the display.

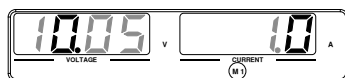

Recalled setup



Note

The F-15 function setting will determine whether the saved contents of the recalled memory setting are displayed or not.

Voltage Sense

The PSU power supplies can be operated using local or remote voltage sense. By default the PSU ships configured for local sense.

Remote Sense Connector

The Remote Sense connector includes a detachable plug to facilitate making the sense connections. The remote sense connector also has a safety cover.



WARNING

Ensure the output is off before handling the remote sense connector.

Use sense cables with a voltage rating exceeding the isolation voltage of the power supply.

Never connect sensing cables when the output is on. Electric shock or damage to the power supply could result.

Remote Sense Connector Overview

When using the remote sense connector make sure the wires that are used follow the following guidelines:

Wire gauge: AWC 28 to AWC 16

Strip length: 5mm // 0.2 in.

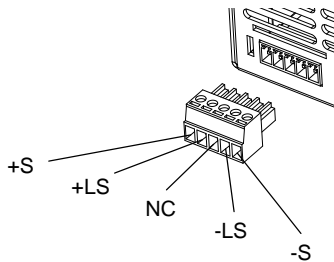

- +S: Remote(+) sense
- +LS: Local (+) sense
- NC: Not connected
- LS: Local (-) sense
- S: Remote (-) sense

Remote Sense Cover



Ensure the output is off before handling the remote sense connector.

Use sense cables with a voltage rating exceeding the isolation voltage of the power supply.

Never connect sensing cables when the output is on. Electric shock or damage to the power supply could result.

Always operate the PSU with the remote sense cover.

Connector

1. Place the cover over the remote sense connector.
2. Secure the cover with the provided screw.

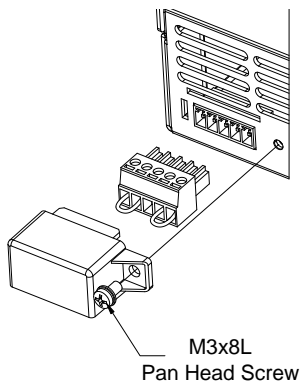

Local Sense

When using local sense, the sensing terminals are connected to the local sense terminals (via the local sense connections) and thus do not compensate for any possible voltage drop that is seen on the load cables. Local sense is only recommended when the voltage drop is of no consequence or for load-current applications. By default, the sense plug is already configured to local sensing.

Local Sense Connection

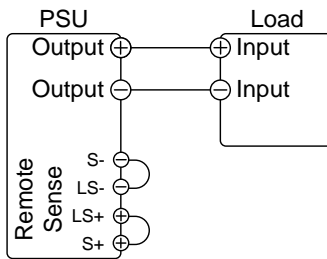

Remote Sense

Remote sense is used to compensate for the voltage drop seen across load cables due to the resistance inherent in the load cables. The remote sense terminals are connected to the load terminals of the DUT to determine the voltage drop across the load cables.

Remote sense can compensate up to 1 volt (PSU 6-200/12.5-120/20-76), 2 volts (PSU 40-38), 3 volts (PSU 60-25) or 5 volts (PSU 100-15/150-10/300-5/400-3.8/600-2.6) (compensation voltage, single line). Load cables should be chosen with a voltage drop less than the compensation voltage.

Although you can use remote sense to compensate up to 5V for a single line, it is recommended that the voltage drop is minimized to a maximum of 1V to prevent excessive output power consumption from the power supply and poor dynamic response to load changes.



WARNING

Ensure the output is off before connecting any sense cables.

Use sense cables with a voltage rating exceeding the isolation voltage of the power supply.

Never connect sensing cables when the output is on. Electric shock or damage to the power supply could result.



Note

Be sure to remove the sense jumpers from the remote sense connector so the unit is not using local sensing.

Single Load

1. Connect the S+ terminal to the positive potential of the load. Connect the S- terminal to the negative potential of the load.

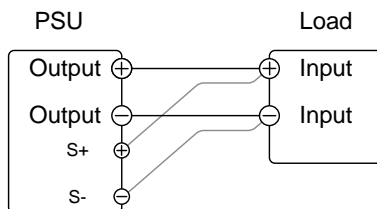

Page 65

2. Operate the instrument as normal. See the Basic Operation chapter for details.

Parallel PSU Units

1. Connect the S+ terminals to the positive potential of the load. Connect the S- terminals to the negative potential of the load.

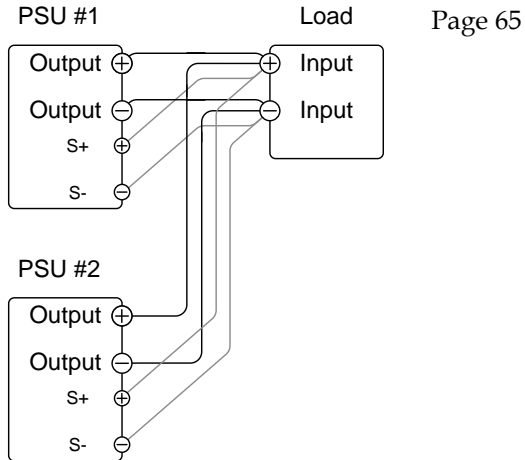

2. Operate the instrument as normal. Page 72
See the Parallel Operation chapter for details.

Serial PSU Units

1. a. Connect the 1st S+ terminal to the positive potential of the load.

b. Connect the 1st S- terminal to the positive output terminal of the second PSU unit.

c. Connect the 2nd S+ terminal to the positive terminal of the second PSU unit.

d. Connect the 2nd S- terminal to negative terminal of the load.

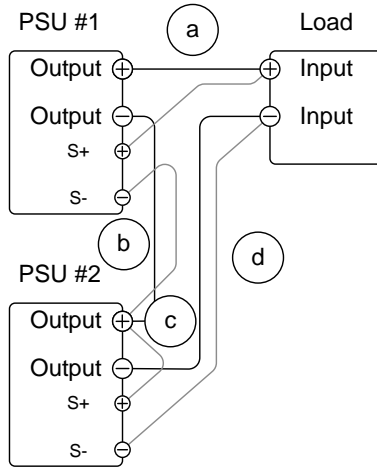

- 2. Operate the instrument as normal. Page 80
See the Serial Operation chapter for details.

Wire Shielding and Load line impedance

To help to minimize the oscillation due to the inductance and capacitance of the load cables, use an electrolytic capacitor in parallel with the load terminals.

To minimize the effect of load line impedance use twisted wire pairing.

Shield the sense wires and connect the shield to the chassis ground.

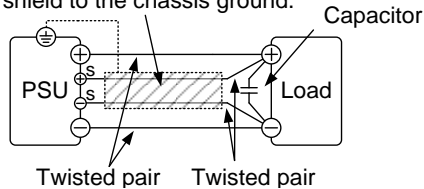

Parallel / Series Operation

This section describes the basic operations required to operate the power supply in series or parallel. Operating the PSU series in parallel increases the total current output of the power supply units. When used in series, the total output voltage of the power supplies can be increased.

When the units are used in parallel or in series, a number of precautions and limitations apply. Please read the following sections before operating the power supplies in parallel or series.

- Master-slave parallel overview → from page 72
- Parallel connection → from page 75
- Parallel operation → from page 78
- Master-slave parallel calibration → from page 80
- Master-slave Series overview → page 82
- Series connection → page 84
- Series operation → from page 86

Master-Slave Parallel Overview

Background

When connecting the PSU power supplies in parallel, up to 4 units can be used in parallel and all units must be of the same model with similar output settings.

To use the power supplies in parallel, units must be used in a “master-slave” configuration. In the master-slave configuration a “master” power supply controls any other connected “slave” power supplies. In order for the master unit to control the slave units, the master unit must use the analog control connector to control the slave units.

When using the Analog Control Connector, the connector must be wired correctly between the master and each of the slave units. For the complete connector pin assignment, see page 123, or alternatively, the PSU-01C, PSU-02C and the PSU-03C cables can be used to connect a master to unit to 1, 2 or 3 slave units, respectively.

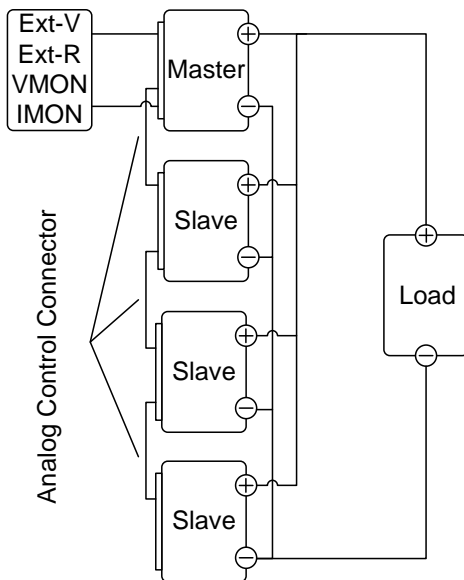

Limitations

Display

- Only the master unit will display the voltage and current.

OVP/ OCP/UVL

- Slave units follow the settings of the master when OVP/OCP/UVL is tripped on the master unit.

Remote monitoring

- Voltage monitoring (VMON) and current monitoring (IMON) are only supported on the master unit.
- The IMON current represents the total current of the all the parallelized units.

Remote Sense

- Please see the remote sense chapter for details, page 67.

Parallel Calibration

- The parallel calibration function can be used to offset cables losses.

External Voltage and Resistance Control

- Voltage/Resistance controlled remote control can only be used with the master unit.
- The full scale current (in parallel) is equivalent to the maximum external voltage or resistance.

Internal Resistance

- For 2 units in parallel, the internal resistance is actually half of the setting value.
- For 3 units in parallel, the internal resistance is actually a third of the setting value.
- For 4 units in parallel, the internal resistance is actually a fourth of the setting value.
- See function setting F-08 for internal resistance settings, page 106.

Bleeder Control

- The Master unit is used to control the bleeder settings. The bleeder resistors in all the slave units are always turned off when in parallel mode.

	Model	1 unit	2 units	3 units	4 units
Output Voltage/ Output Current	PSU 6-200	6V	6V	6V	6V
		200A	400A	600A	800A
	PSU 12.5-120	12.5V	12.5V	12.5V	12.5V
		120A	240A	360A	480A
	PSU 20-76	20V	20V	20V	20V
		76A	152A	228A	304A
	PSU 40-38	40V	40V	40V	40V
		38A	76A	114A	152A
	PSU 60-25	60V	60V	60V	60V
		25A	50A	75A	100A

PSU 100-15	100V	100V	100V	100V
	15A	30A	45A	60A
PSU 150-10	150V	150V	150V	150V
	10A	20A	30A	40A
PSU 300-5	300V	300V	300V	300V
	5A	10A	15A	20A
PSU 400-3.8	400V	400V	400V	400V
	3.8A	7.6A	11.4A	15.2A
PSU 600-2.6	600V	600V	600V	600V
	2.6A	5.2A	7.8A	10.4A

Master-Slave Parallel Connection

Analog Control Connection

To operate the power supplies in parallel with the analog connectors, connect the analog connectors on the master and slave units as shown in the diagrams below. Alternatively, preconfigured cables can be used:

PSU-01C: 1 master with 1 slave

PSU-02C: 1 master with 2 slaves

PSU-03C: 1 master with 3 slaves

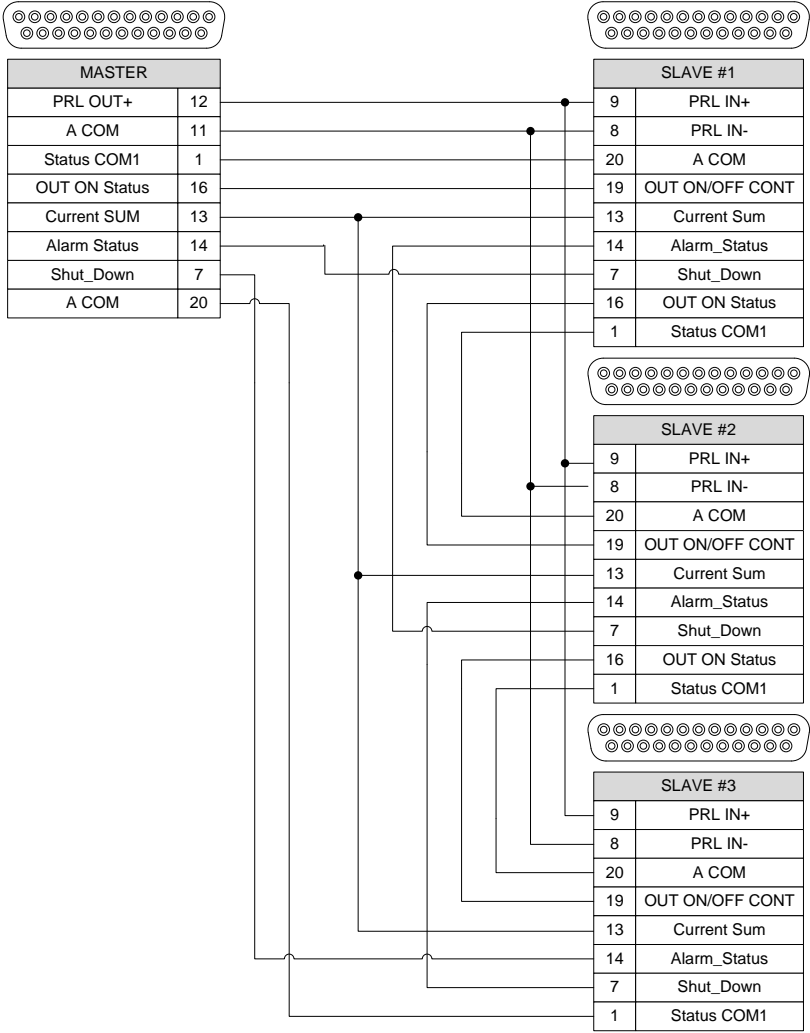

Parallel Output Connection

If grounding the positive or negative terminals to the reference ground, be sure to ground the appropriate terminal on each unit (either positive or negative).

Example with negative terminal connected to ground

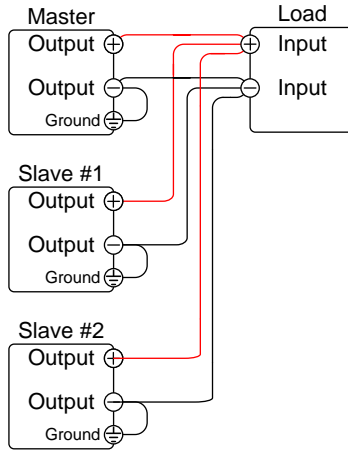

Steps

1. Ensure the power is off on all power supplies.
2. Choose a master and a slave unit(s).
3. Connect the analog connectors for the master and slave units as shown above.
4. Remove the Output Terminal covers. Page 44
5. Connect the master and slave unit in parallel as shown above.
6. Reattach the terminal covers. Page 44

 **Note**

Ensure the load cables have sufficient Page 40 current capacity.

The load wires and remote sense wires should use twisted-paired wiring of the shortest possible length.

Master-Slave Parallel Operation

Master-Slave Configuration Before using the power supplies in parallel, the master and slave units need to be configured.

- Steps**
1. Configure the OVP, OCP and ULV Page 53 settings for the master unit.
 2. For each unit, hold the Function key while turning the power on to enter the power on configuration settings.

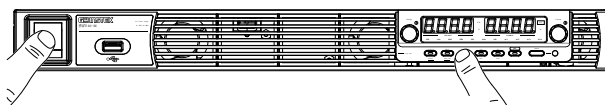

3. Configure F-93 (Master/Slave) Page 119 setting for each master/slave unit.

Unit	F-93
Independent (default setting)	0
Master unit with 1 slave in parallel	1
Master unit with 2 slaves in parallel	2
Master unit with 3 slaves in parallel	3
Slave (parallel)	4

4. Cycle the power on the units (reset the power).



Note

Configuration settings can be checked on both the master and slave units by pressing the Function key and checking F-93.

Only the Master OVP, OCP and UVL settings are used for protection. Slave protection levels are disregarded.

OHP works independently for each unit.

Master-Slave
Operation

Only operate the power supplies in parallel if the units are configured correctly.

Steps

1. Turn on the master and slave units. The slave unit(s) will show a blank display.

Master unit

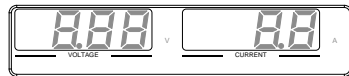

Slave units

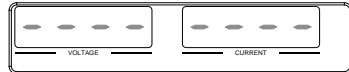

2. Operation of all units is controlled via the master unit. Operation of the master unit is the same as for a single unit. See the Basic Operation chapter. Page 53.

3. Press the Output key to begin. The output LED will become lit.

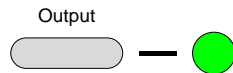

Caution

Only operate the power supplies in parallel if using units of the same model number.



Note

The panel controls are disabled on slave units, including the output key. On slave units, only the Function key can be used to view the current settings.

Master-Slave Parallel Calibration

Master-Slave Configuration

The F-16 function setting can be used to calibrate the output of PSU units connected in parallel.

If you feel the accuracy is not good enough when you measure the accuracy in parallel mode, the parallel calibration can be used to get better measurement accuracy.

Steps

1. Short all the terminals together. This is best accomplished by connecting the master and all the slave units in parallel and then shorting the output terminals.

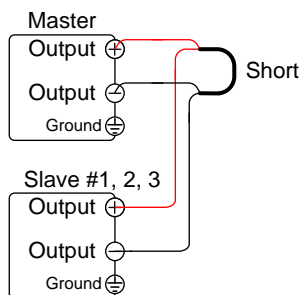

2. Connect the slave units to the master unit using the analog control connectors as described previously. Page 75
3. Configure F-93 (Master/Slave) setting for each master/slave unit, as described previously. Page 78
4. Cycle the power on the units (reset the power).

5. On the master unit, set F-16 (Auto Calibration Parallel Control) to 2 to turn on the parallel calibration. Calibration will begin immediately.
6. Whilst calibration is being performed, *WAIT* will be displayed on the master screen. Calibration will take a few moments.

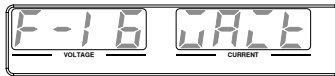

7. When the calibration has finished, *OK* will be displayed on the master screen.



8. Remove the shorts from the terminals, and proceed with parallel operation.



Note

When performing parallel calibration, make sure the terminals are connected with cables or bus bars that are able to withstand the combined current capacity of all the units in parallel.

Master-Slave Series Overview

Background

When connecting PSU power supplies in series, up to 2 units can be used in series and all units must be of the same model. When operated in series, the power supplies can be used to increase the voltage output or setup the power supplies to output both positive and negative polarities. Unlike with the parallel operation, the series operation does not require any special configuration as each power supply is operated and controlled individually.

When the units are used in series, a number of precautions and limitations apply. Please read this overview before operating the power supplies in series.

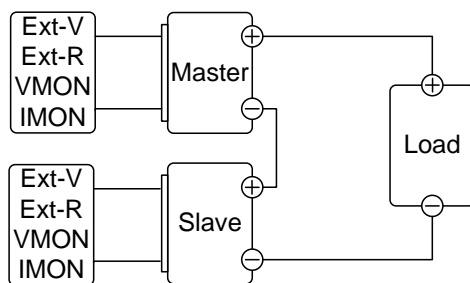

Limitations

Display

- Master and slave units display both the current and the voltage. The total voltage is the sum of the units.

OVP/OCP/UVL

- OVP, OCP and UVL level for each unit must be set separately.
- The OVP and OCP protections are tripped independently on the master and slave.

Remote monitoring

- Voltage monitoring (VMON) and current monitoring (IMON) should be performed on both units.
- The VMON voltage represents the voltage of that particular unit.

Remote Sense

- Please see the voltage sense chapter for details, page 65.

External Voltage and Resistance Control

- Voltage/Resistance controlled remote control should be used on both units separately.
- The full scale voltage (in series) is equivalent to the maximum external voltage or resistance.

Slew Rate

- The slave rate should be set for both units.

Internal Resistance

- The internal resistance should be set for both units.

Bleeder Control

- The bleeder resistor setting should be set equally on both units.

**CAUTION**

When using analog control connector to program or measure with PSU power supplies connected in series, make sure that each unit is separated and floating from each other.

**WARNING**

When PSU power supplies are connected in series and the load or one of the output terminals is grounded, no point on the output shall be more than $\pm 600\text{VDC}$ above or below chassis ground.

Series Connection

If using the PSU in series, please be aware that each unit acts independently and thus there are no special communication buses for serial connections.

Series Connection
to increase
Voltage Output

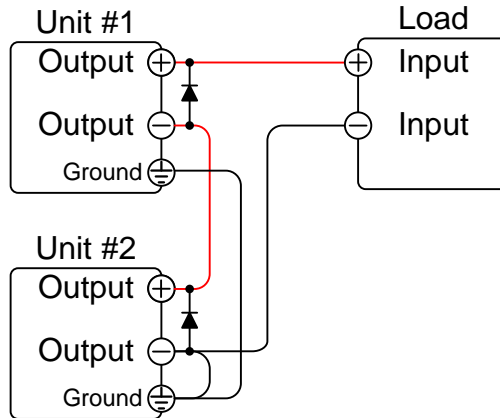

Series Connection
to Output
Positive and
Negative Polarity

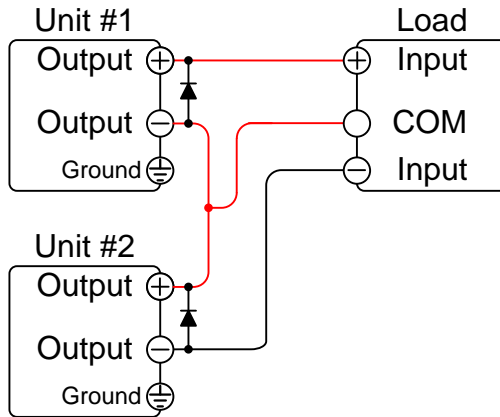

Note: The output reference ground (COMMON) can be grounded at the power supply side instead of the load, depending on the requirements. Local sensing should be used in this configuration.



Caution

When connecting the units in series, diodes should be connected across each output to prevent reverse voltage.

Steps

1. Ensure the power is off on both power supplies.
2. Connect the master and slave unit in series as shown above to either increase the voltage output or to create a positive and negative output. Remember that how the units are grounded depends on the configuration of the series connection.
3. Use diodes across the output terminals to prevent reverse voltage at startup or if one of the units unexpectedly shuts down. Ensure the diodes are rated to withstand the voltage and current output of the power supply.
4. Reattach the terminal cover.



Note

Ensure load cables have sufficient current capacity. Page 40

Series Operation

Series Configuration Before using the power supplies in series, the master and slave units need to be configured.

1. Configure the OVP, OCP and UVL settings for each unit. Page 53
2. For each unit, hold the Function key while turning the power on to enter the power on configuration settings.



3. Make sure each unit is set to Independent (F-93 = 0). When using the power supplies in series, each unit is operated individually, and thus no unit is considered the master or slave. Page 119

Unit	F-93
Independent	0

4. Cycle the power on the units (reset the power).
-



Note

Configuration settings can be checked for both the master and slave units by pressing the Function key.

Series Operation Only operate the power supplies in series if the units are configured correctly.

1. Turn on both units. When connected in series unit will only show the voltage and current of their own unit.

Unit #1

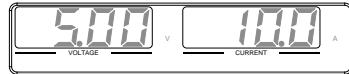

Unit #2

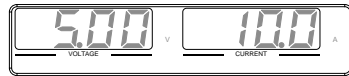

2. Operation of both units is the same Page 53 as for a single unit. Each unit will only draw as much power as is programmed. Please see the basic operation chapter for details.

3. Press the Output key on each unit to begin. The output LED will become lit.

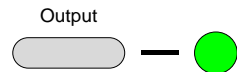

Only operate the power supplies in series if using units of the same model number.

Only a maximum of 2 units can be used in series.



Ensure that the insulation capacity of the wiring is sufficient when connected in series. See page 33 for insulation capacity and grounding details.

Test Scripts

This section describes how to use the Test function to run, load and save test scripts for automated testing. The Test function is useful if you want to perform a number of tests automatically. The PSU test function can store ten test scripts in memory.

Each test script is programmed in a scripting language. For more information on how to create test scripts, please contact GW Instek.

- Test script file format → from page 89
- Test script settings → from page 89
- Setting the test script settings → from page 90
- Load test script → from page 91
- Run test script → from page 92
- Export test script → from page 93
- Remove test script → from page 94

Test Script File Format

Background	The test files are saved in *.tst file format. Each file is saved as tXXX.tst, where XXX is the save file number 001~010.
------------	--

Test Script Settings

Test Run	Runs the chosen test script from the internal memory. A script must first be loaded into the internal memory before it can be run. See the test function Test Save, below. The script will run as soon as the test function is started.
	T-01 1~10
Test Copy	Copies a test script from the USB drive to the designated save slot in memory. A script must first be copied into internal memory before it can be run.
	T-02 1~10 (USB→PSU)
Test Export	Exports a script from the designated memory save slot to the USB drive.
	T-03 1~10 (PSU→USB)
Test Remove	Deletes the chosen test file from the PSU internal memory.
	T-04 1~10
Available Test Memory	Shows the amount of space left in memory for tests.
	T-05 Displays the available memory in bytes.

Setting the Test Script Settings

Steps The test script settings (T-01~T-10) are set with the Test key.

1. Press the Test key. The Test key will light up.



2. The display will show T-01 on the left and the memory no. for T-01 on the right.

The middle of the display will indicate if the desired file is available in memory or not. Y indicates Yes, N indicates No.

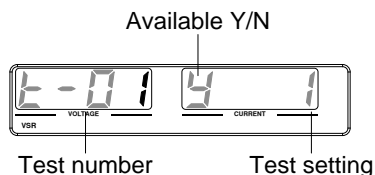

3. Rotate the Voltage knob to change the T setting (Test setting).

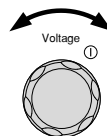

Test Run	T-01
Test Copy	T-02
Test Export	T-03
Test Remove	T-04

4. Rotate the Current knob to choose a memory number. (Excluding T-05)

Range 1~10

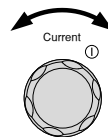

5. Press the Voltage knob to complete the setting.

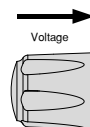

Exit

Press the Test key again to exit the Test settings. The Test key light will turn off.

TEST



Load Test Script from USB

Overview

Before a test script can be run, it must first be loaded into a one of the 10 memory save slots. Before loading a test script into memory:

- Ensure the script file is placed in the root directory.
- Ensure the file name number corresponds to the memory number that you wish to save to. For example t001.tst can only be loaded into memory number #01, t002.tst into memory number #02, and so on.
- Use the T-05 setting to see how much memory is available in internal memory.

Steps

1. Insert a USB flash drive into the front panel USB-A slot. Ensure the flash drive contains a test script in the root directory.

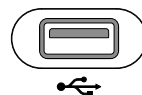

2. Turn on the power. MS ON (Mass Storage) will be displayed on the screen after a few seconds if the USB drive is recognized. Conversely, MS OFF will be displayed if removed.

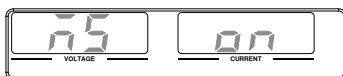

Note

If the USB drive is not recognized, check to see that the function settings for F-20 = 1 (page 107). If not, reinsert the USB flash drive.

3. Configure T-02 (Test Copy) to 1~10 Page 90 (save memory slot)
T-02 range 1~10
4. OK will be displayed when completed.
5. The script will now be available in the memory slot the script was saved to.



Note

Error messages: If you load a file that is not present on the USB drive “Err 002” will be displayed on the display.

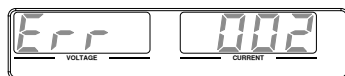

Run Test Script

Overview

A test script can be run from one of ten memory slots.

Steps

1. Before a test script can be run, it must first be loaded into one of the 10 memory save slots.

Page 91

2. Configure T-01 (Run Test) to 1~10 Page 90
(save memory slot no. to run)

T-01 range 1~10

3. The test script will automatically start to run.



Note

Error messages: If you try to run a test script from an empty memory location “Err 003” will be displayed on the display.

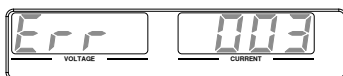

Stop a Test

To stop (abort) a running test at any time, press the Test key. TEST STOP will be displayed and the unit will return to normal operation after a few moments.

TEST



Export Test Script to USB

Overview

The Export Test function saves a test file to the root directory of a USB flash drive.

- Files will be saved as tXXX.tst where XXX is the memory number 001~010 from which the test script was exported from.
- Files of the same name on the USB flash drive will be written over.

Steps

1. Insert a USB flash drive into the front panel USB-A slot.

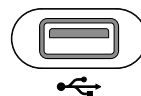

- Turn on the power. MS (Mass Storage) will be displayed on the screen after a few seconds if the USB drive is recognized.

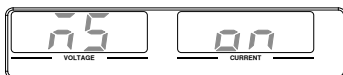

Note

If the USB drive is not recognized, check to see that the function settings for F-20 = 1 (page 106). If not, reinsert the USB flash drive.

- Configure T-03 (Test Export) to Page 90
1~10 (save memory slot)
T-03 range 1~10
- The script will now be copied to the USB flash drive.

OK will be displayed when completed.



Note

Error messages: If you try to export a test script from an empty memory location "Err 002" will be displayed on the display.

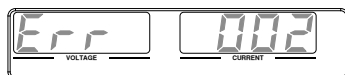

Remove Test Script

Overview

The Remove Test function will delete a test script from the internal memory.

Steps

- Select T-04 (Test Remove) and Page 90
choose which test script to remove from the internal memory.
T-04 range 1~10

2. The test script will be removed from the internal memory.

OK will be displayed when completed.



Error messages: If you try to remove a test script from an empty memory location “Err 003” will be displayed on the display.

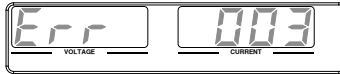

C ONFIGURATION

Configuration Overview	97
Configuration Table.....	97
Normal Function Settings	104
Interface Configuration Settings	107
USB / GPIB Settings	107
LAN Settings	108
UART Settings	110
System Settings	111
Power On Configuration Settings.....	112
Trigger Input and Output Configuration Settings	115
Special Function	117
Setting Normal Function Settings.....	117
Setting Power On Configuration Settings	119

Configuration Overview

Configuration of the PSU power supplies is divided into five different configuration settings: Normal Function, USB/GPIB, LAN, UART, System Configuration Settings, Power ON Configuration, Trigger Input/Output Configuration Settings and Special Function Settings. Power ON Configuration differs from the other settings in that the settings used with Power ON Configuration settings can only be set during power up. The other configuration settings can be changed when the unit is already on. This prevents some important configuration parameters from being changed inadvertently. Power On Configuration settings are numbered F-90 to F-98 and the other configuration settings are numbered F-00 to F-61, F-70 to F-78, F-88 to F-89 and F100 to F122. The Special Function Settings are used for calibration, firmware updated and other special functions; these functions are not supported for end-user use.

Configuration Table

Please use the configuration settings listed below when applying the configuration settings.

Normal Function Settings		
Settings	Setting	Setting Range
Output ON delay time	F-01	0.00s~99.99s
Output OFF delay time	F-02	0.00s~99.99s
V-I mode slew rate select	F-03	0 = CV high speed priority (CVHS) 1 = CC high speed priority (CCHS) 2 = CV slew rate priority (CVLS) 3 = CC slew rate priority (CVLS)

Rising voltage slew rate	F-04	0.001~0.06V/msec (PSU 6-200)
		0.001~0.125V/msec (PSU 12.5-120)
		0.001~0.2V/msec (PSU 20-76)
		0.001~0.4V/msec (PSU 40-38)
		0.001~0.6V/msec (PSU 60-25)
		0.001~1.000V/msec (PSU 100-15)
		0.001~1.500V/msec (PSU 150-10)
		0.001~1.500V/msec (PSU 300-5)
		0.001~2.000V/msec (PSU 400-3.8)
		0.001~2.400V/msec (PSU 600-2.6)

Falling voltage slew rate	F-05	0.001~0.06V/msec (PSU 6-200)
		0.001~0.125V/msec (PSU 12.5-120)
		0.001~0.2V/msec (PSU 20-76)
		0.001~0.4V/msec (PSU 40-38)
		0.001~0.6V/msec (PSU 60-25)
		0.001~1.000V/msec (PSU 100-15)
		0.001~1.500V/msec (PSU 150-10)
		0.001~1.500V/msec (PSU 300-5)
		0.001~2.000V/msec (PSU 400-3.8)
		0.001~2.400V/msec (PSU 600-2.6)

Rising current slew rate	F-06	0.001~2A/msec (PSU 6-200)
		0.001~1.2A/msec (PSU 12.5-120)
		0.001~0.76A/msec (PSU 20-76)
		0.001~0.38A/msec (PSU 40-38)
		0.001~0.25A/msec (PSU 60-25)
		0.001~0.150A/msec (PSU 100-15)
		0.001~0.100A/msec (PSU 150-10)
		0.001~0.025A/msec (PSU 300-5)
		0.001~0.008A/msec (PSU 400-3.8)
		0.001~0.006A/msec (PSU 600-2.6)

Falling current slew rate	F-07	0.001~2A/msec (PSU 6-200)
		0.001~1.2A/msec (PSU 12.5-120)
		0.001~0.76A/msec (PSU 20-76)
		0.001~0.38A/msec (PSU 40-38)
		0.001~0.25A/msec (PSU 60-25)
		0.001~0.150A/msec (PSU 100-15)
		0.001~0.100A/msec (PSU 150-10)
		0.001~0.025A/msec (PSU 300-5)
		0.001~0.008A/msec (PSU 400-3.8)
0.001~0.006A/msec (PSU 600-2.6)		
Internal resistance setting	F-08	0~0.03Ω (PSU 6-200)
		0~0.104Ω (PSU 12.5-120)
		0~0.263Ω (PSU 20-76)
		0~1.053Ω (PSU 40-38)
		0~2.4Ω (PSU 60-25)
		0~6.667Ω (PSU 100-15)
		0~15.00Ω (PSU 150-10)
		0~60.00Ω (PSU 300-5)
0~105.3Ω (PSU 400-3.8)		
0~230.8Ω (PSU 600-2.6)		
Bleeder circuit control	F-09	0 = OFF, 1 = ON, 2 = AUTO
Buzzer ON/OFF control	F-10	0 = OFF, 1 = ON
OCF Delay Time	F-12	0.1 ~ 2.0 sec
Current Setting Limit (I-Limit)	F-13	0 = OFF, 1 = ON
Voltage Setting Limit (V-Limit)	F-14	0 = OFF, 1 = ON
Display memory parameter when recalling (M1, M2, M3)	F-15	0 = OFF, 1 = ON
Auto Calibration Parallel Control	F-16	0 = Disable, 1 = Enable, 2 = Execute Parallel Calibration and set to Enable. Note: Must be a short between each unit before starting.
Measurement Average Setting	F-17	0 = Low, 1 = Middle, 2 = High
Alarm Recovery and Output Status	F-18	0 = Safe Mode, 1 = Force Mode
Lock Mode	F-19	0:Lock Panel, Allow Output OFF 1:Lock Panel, Allow Output ON/OFF

USB/GPIB Settings		
Show front panel USB status	F-20	0 = None, 1 = Mass Storage
Show rear panel USB status	F-21	0 = None, 1 = Linking to PC
Setup rear USB Speed	F-22	0 = Disable USB, 1 = Full Speed, 2 = Auto Detect Speed
GPIB Address	F-23	0 ~ 30
GPIB Enable/Disable	F-24	0 = Disable GPIB, 1 = Enable GPIB
Show GPIB available status	F-25	0 = No GPIB, 1 = GPIB is available
SCPI Emulation	F-26	0 = GW Instek, 1 = TDK GEN, 2 = Agilent 5700, 3 = Kikusui PWX
LAN Settings		
Show MAC Address-1	F-30	0x00~0xFF
Show MAC Address-2	F-31	0x00~0xFF
Show MAC Address-3	F-32	0x00~0xFF
Show MAC Address-4	F-33	0x00~0xFF
Show MAC Address-5	F-34	0x00~0xFF
Show MAC Address-6	F-35	0x00~0xFF
LAN Enable	F-36	0 = OFF, 1 = ON
DHCP	F-37	0 = OFF, 1 = ON
IP Address-1	F-39	0~255
IP Address-2	F-40	0~255
IP Address-3	F-41	0~255
IP Address-4	F-42	0~255
Subnet Mask-1	F-43	0~255
Subnet Mask-2	F-44	0~255
Subnet Mask-3	F-45	0~255
Subnet Mask-4	F-46	0~255
Gateway-1	F-47	0~255
Gateway-2	F-48	0~255
Gateway-3	F-49	0~255
Gateway-4	F-50	0~255
DNS address -1	F-51	0~255
DNS address -2	F-52	0~255
DNS address-3	F-53	0~255
DNS address-4	F-54	0~255
Socket Server Enable/Disable	F-57	0 = Disable, 1 = Enable

Show Socket Server Port	F-58	No setting
Web Server Enable/Disable	F-59	0 = Disable, 1 = Enable
Web Password Enable/Disable	F-60	0 = Disable, 1 = Enable
Web Enter Password	F-61	0000~9999
UART Settings		
UART Mode	F-70	0 = Disable UART, 1 = RS232, 2 = RS485
UART Baud Rate	F-71	0 = 1200, 1 = 2400, 2 = 4800, 3 = 9600, 4 = 19200, 5 = 38400, 6 = 57600, 7 = 115200
UART Data Bits	F-72	0 = 7 bits, 1 = 8 bits
UART Parity	F-73	0 = None, 1 = Odd, 2 = Even
UART Stop Bit	F-74	0 = 1 bit, 1 = 2 bits
UART TCP	F-75	0 = SCPI, 1 = TDK (emulation mode)
UART Address (For multi-unit remote control)	F-76	00 ~ 30
UART Multi-Drop control	F-77	0 = Disable, 1 = Master, 2 = Slave, 3 = Display information
UART Multi-Drop status	F-78	Displayed parameter: AA-S AA: 00~30 (Address), S: 0~1 (Off-line/On-line status).
System Settings		
Factory Set Value	F-88	0 = None 1 = Return to factory default settings
Show Version	F-89	0, 1 = Version 2, 3, 4, 5 = Build date (YYYYMMDD) 6, 7 = Keyboard CPLD 8, 9 = Analog Board CPLD A, B = Analog Board FPGA C, D, E, F = Kernel Build (YYYYMMDD) G, H = Test Command Version I, J, K, L = Test Command Build (YYYYMMDD) M, N = Reserved O, P = Option module

Power On Configuration Settings*

CV Control	F-90	0 = Control by Local 1 = Control by External Voltage 2 = Control by External Resistor - Rising <input type="checkbox"/> 3 = Control by External Resistor - Falling <input type="checkbox"/> 4 = Control by Isolated Board
CC Control	F-91	0 = Control by Local 1 = Control by External Voltage 2 = Control by External Resistor - Rising <input type="checkbox"/> 3 = Control by External Resistor - Falling <input type="checkbox"/> 4 = Control by Isolated Board
Output Status when Power ON	F-92	0 = Safe Mode (Always OFF), 1 = Force Mode (Always ON), 2 = Auto Mode (Status before last time power OFF)
Master/Slave Configuration	F-93	0 = Independent 1 = Master with 1 slave in parallel 2 = Master with 2 slaves in parallel 3 = Master with 3 slaves in parallel 4 = Slave (parallel)
External Output Logic	F-94	0 = High ON, 1 = Low ON
Monitor Voltage Select	F-96	0 = 5V , 1 = 10V
Control Range	F-97	0 = 5V [5kΩ], 1 = 10V [10kΩ]
External Output Control Function	F-98	0 = OFF, 1 = ON

Trigger Input and Output Configuration Settings

Trigger Input Pulse Width	F100	0~60ms. 0 = trigger controlled by trigger level.
Trigger Input Action	F102	0 = None 1 = Output ON/OFF (refer to F103) 2 = Setting (refer to F104 & F105) 3 = Memory (refer to F106)
Output State When Receiving Trigger	F103	0 = OFF 1 = ON
Apply Voltage Setting on Trigger	F104	0 ~ rated voltage (only applicable when F102 =2)

Apply Current Setting on Trigger	F105	0 ~ rated current (only applicable when F102 =2)
Recall memory number	F106	1 ~ 3 (M1 ~ M3)
Trigger Output Pulse Width	F120	0 ~ 60ms. 0 = trigger output is set to the active level, not pulse width.
Trigger Output Level	F121	0 = LOW, 1 = HIGH (If F120 = 0)
Trigger Source	F122	0 = None
		1 = Switching the output on or off
		2 = Changing a setting
3 = Recalling a memory		
Special Function Settings*		
Calibration	F-00	0000 ~ 9999



*Note

Power On Configuration settings can only be set during power up. They can, however, be viewed under normal operation.

Normal Function Settings

Output ON Delay Time

Delays turning the output on for a designated amount of time. The Delay indicator will light when the Delay time is not 0.

Note: The Output ON Delay Time setting has a maximum deviation (error) of 20ms.

The Output ON Delay Time setting is disabled when the output is set to external control.



F-01 0.00s~99.99s

Output OFF Delay Time

Delays turning the output off for a designated amount of time. The Delay indicator will light when the Delay time is not 0.

Note: The Output OFF Delay Time setting has a maximum deviation (error) of 20ms.

The Output OFF Delay Time setting is disabled when the output is set to external control.



F-02 0.00s~99.99s

V-I Mode Selects High Speed Priority or Slew Rate Priority for CV or CC mode. The voltage or current slew rate can only be edited if CC/CV Slew Rate Priority is selected. The ISR indicator will be lit for CC Slew Rate Priority and the VSR indicator will be lit for CV Slew Rate Priority.

Note: CC and CV Slew Rate Priority mode are disabled when voltage/current output is set to external control.

CC Slew Rate priority

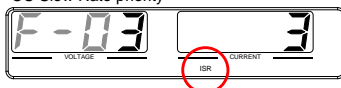

CV Slew Rate Priority



- F-03
- 0 = CV high speed priority
 - 1 = CC high speed priority
 - 2 = CV slew rate priority
 - 3 = CC slew rate priority

Rising Voltage Slew Rate Sets the rising voltage slew rate. Only applicable if V-I Mode is set to CV Slew Rate Priority.

F-04 0.001 ~ max. V/msec

Falling Voltage Slew Rate Sets the falling voltage slew rate. Only applicable if V-I Mode is set to CV Slew Rate Priority.

F-05 0.001 ~ max. V/msec

Rising Current Slew Rate Sets the rising current slew rate. Only applicable if V-I Mode is set to CC Slew Rate Priority.

F-06 0.001 ~ max. A/msec

Falling Current Slew Rate	<p>Sets the falling current slew rate. Only applicable if V-I Mode is set to CC Slew Rate Priority.</p> <p>F-07 0.001 ~ max. A/msec</p>
Internal Resistance Settings	<p>Sets the internal resistance of the power supply.</p> <p>F-08 0.000Ω ~ X.XXXΩ (Where X.XXX = Rating Voltage / Rating Current)</p>
Bleeder Control	<p>Bleeder control turns ON/OFF the bleeder resistor. Bleeder resistors discharge the filter capacitors after power is turned off as a safety measure.</p> <p>F-09 0 = OFF, 1 = ON, 2 = AUTO</p>
Buzzer ON/OFF	<p>Turns the buzzer sound on or off. The buzzer is associated with alarm sounds and keypad entry sounds.</p> <p>F-10 0 = OFF, 1 = ON</p>
OCP Delay Time	<p>Sets the OCP delay time. This parameter will delay the amount of time it takes to trigger the over current protection. This function can be useful to prevent current overshoot from triggering OCP.</p> <p>F-12 0.1 ~ 2.0 sec</p>
Current Setting Limit (I-limit)	<p>Turns the current setting limit (I-limit) on or off. Turning this function on will prevent you from accidentally setting the current limit above the set OCP level.</p> <p>F-13 0 = OFF, 1 = ON</p>
Voltage Setting Limit	<p>Turns the voltage setting limit (V-limit) on or off. Turning this function on will prevent you from accidentally setting the voltage limit above the OVP level.</p>

	F-14	0 = OFF 1 = ON
Display Memory Parameter	Displays which memory setting is recalled (M1, M2 or M3) when recalling a setup.	
	F-15	0 = OFF, 1 = ON
Auto Calibration Parallel Control	This function performs offset calibration for parallel control. There must be a short between each unit before starting the calibration. See page 80 for details.	
	F-16	0 = Disable, 1 = Enable, 2 = Execute Parallel Calibration and set to Enable
Measurement Average Setting	Determines the level of smoothing for the average setting.	
	F-17	0 = Low, 1 = Middle, 2 = High
Alarm Recovery and Output Status	Set the output status when OHP, FAN and AC-Fail alarm be cleared.	
	F-18	0 = Safe Mode, 1 = Force Mode
Lock Mode	When the front panel is locked, the Lock Mode function determines the behavior of the Output key.	
	F-19	0: Lock Panel, Allow Output OFF 1: Lock Panel, Allow Output ON/OFF

Interface Configuration Settings

USB / GPIB Settings

Show Front Panel USB Status	Displays the front panel USB-A port state. This setting is not configurable.	
	F-20	0 = None, 1 = Mass Storage

Show Rear Panel USB Status	Displays the rear panel USB-B port state. This setting is not configurable. F-21 0 = None, 1 = Linking to PC
Setup Rear USB Speed	Sets the rear panel USB speed or turns the rear USB port off. F-22 0 = Disable USB, 1 = Full Speed, 2 = Auto Detect Speed
GPIB Address	Sets the GPIB address. F-23 0 ~ 30
GPIB Disable/Enable	Enable or disables the GPIB port. F-24 0 = Disable GPIB, 1 = Enable GPIB
Show GPIB available Status	Shows the status of the GPIB option port. F-25 0 = No GPIB, 1 = GPIB is available
SCPI Emulation	Sets the SCPI emulation mode. The emulation modes allow you to emulate the remote commands of legacy equipment that is used in a test environment. Parameter 2 and 3 are only supported as stand alone use. F-26 0 = GW INSTEK, 1 = TDK GEN, 2 = Agilent N5700, 3 = Kikusui PWX

LAN Settings

Show MAC Address-1~6	Displays the MAC address in 6 parts. This setting is not configurable. F-30~F-35 0x00~0xFF
LAN	Turns LAN on or off. F-36 0 = OFF, 1 = ON

DHCP	Turns DHCP on or off. F-37 0 = OFF, 1 = ON
IP Address-1~4	Sets the default IP address. IP address 1~4 splits the IP address into four sections. (F-39 : F-40 : F-41 : F-42) (0~255 : 0~255 : 0~255 : 0~255)
Subnet Mask 1~4	Sets the subnet mask. The subnet mask is split into four parts. (F-43 : F-44 : F-45: F-46) (0~255 : 0~255 : 0~255 : 0~255)
Gateway 1~4	Sets the gateway address. The gateway address is split into 4 parts. (F-47 : F-48 : F-49 : F-50) (0~255 : 0~255 : 0~255 : 0~255)
DNS Address 1~4	Sets the DNS address. The DNS address is split into 4 parts. (F-51 : F-52 : F-53 : F-54) (0~255 : 0~255 : 0~255 : 0~255)
Socket Server Enable/Disable	Enables web socket connections. F-57 0 = Disable, 1 = Enable
Show Socket Server	Shows the socket server port. F-58 No setting
Web Server Enable/Disable	Turns web server control on/off. F-59 0 = Disable, 1 = Enable
Web Password Enable/Disable	Turns a web password on/off. F-60 0 = Disable, 1 = Enable

Web Password	Sets the web password.
F-61	0000 ~ 9999

UART Settings

UART Mode	Sets the UART mode or disables UART.
F-70	0 = Disable UART, 1 = RS232, 2 = RS485

UART Baud Rate	Sets the UART baud rate.
F-71	0 = 1200, 1 = 2400, 2 = 4800, 3 = 9600, 4 = 19200, 5 = 38400, 6 = 57600, 7 = 115200

UART Data Bits	Sets the number of data bits.
F-72	0 = 7 bits, 1 = 8 bits

UART Parity	Sets the parity.
F-73	0 = None, 1 = Odd, 2 = Even

UART Stop Bit	Sets the number of stop bits.
F-74	0 = 1 bit, 1 = 2 bits

UART TCP	UART transmission control protocol TCP settings. This is used primarily for multi-unit remote control, see page 177.
----------	--

Note: Please refer to the TDK Genesys Series user manual for the TDK control commands.

F-75	0 = SCPI, 1 = TDK (emulation mode)
------	------------------------------------

UART Address (For multi-unit remote control)	UART Address: this is used to set the address of a unit when using multi-unit remote control, see page 177 for details.
F-76	0 ~ 30

UART Multi-Drop control	<p>Sets the master/slave/display-information parameters of a unit when using Multi-Drop remote control, see page 177 for details.</p> <p>F-77 0 = Disable, 1 = Master, 2 = Slave, 3 = Display Information</p>
UART Multi-Drop status	<p>Displays the Multi-Drop status on the master unit for each slave unit belonging to the Multi-Drop bus, see page 177 for details.</p> <p>F-78 Displayed parameter: AA-S AA: 00~30 (Address), S: 0~1 (Off-line/On-line status).</p>

System Settings

Factory Default Configuration	<p>Returns the PSU to the factory default settings. See page 197 for a list of the default settings.</p> <p>F-88 0 = None, 1 = Factory Default.</p>
Show Version	<p>Displays the PSU version number, build date, keyboard CPLD, analog board CPLD, analog board FPGA, kernel build date, test command version and test command build date.</p> <p>0-XX = Version (1/2) 1-XX = Version (2/2) 2-XX = Build year (1/2) 3-XX = Build year (2/2) 4-XX = Build month 5-XX = Build day 6-XX = Keyboard CPLD (1/2) 7-XX = Keyboard CPLD (2/2) 8-XX = Analog board CPLD (1/2) 9-XX = Analog board CPLD (2/2) A-XX = Analog board FPGA (1/2) B-XX = Analog board FPGA (2/2) C-XX = Kernel build year (1/2) D-XX = Kernel build year (2/2)</p> <p>F-89</p>

E-XX = Kernel build month
F-XX = Kernel build day
G-XX = Test command version (1/2)
H-XX = Test command version (2/2)
I-XX = Test command build year
(1/2)
J-XX = Test command build year
(2/2)
K-XX = Test command build month
L-XX = Test command build day
M-XX = Reserved (1/2)
N-XX = Reserved (2/2)
O-XX = Option module (1/2)
P-XX = Option module (2/2)

Power On Configuration Settings

CV Control Sets the constant voltage (CV) control mode between local and external voltage/resistance control. For external voltage control, see page 126 (External Voltage Control of Voltage Output) and page 131 (External Resistance Control of Voltage Output). For Isolated control, see page 149 for details.

F-90 0= Control by local
 1 = Control by external
 voltage
 2 = Control by external
 resistor - rising
 3 = Control by external
 resistor- falling
 4 = Control by isolated board

CC Control	Sets the constant current (CC) control mode between local and external voltage/resistance control. For details on external voltage control, see page 129 (External Voltage Control of Current Output) and 133 (External Resistance Control of Current Output). For Isolated control, see page 149 for details.
F-91	0 = Control by local 1 = Control by external voltage 2 = Control by external resistor - rising <input type="checkbox"/> 3 = Control by external resistor- falling <input type="checkbox"/> 4 = Control by isolated board
Output Status when Power-ON Output	Sets the power supply to turn the output on or off at power up.
F-92	0 = Safe Mode (Always OFF), 1 = Force Mode (Always ON), 2 = Auto Mode (Status before last time Power OFF)
Master/Slave Configuration	Sets the power supply as master or slave. See the parallel/series operation for details, page 71.
F-93	0 = Independent 1 = Master with 1 slave in parallel 2 = Master with 2 slaves in parallel 3 = Master with 3 slaves in parallel 4 = Slave (parallel)
External Output Logic	Sets the external logic as active high or low for analog control pin 19.

	F-94	0= High ON, 1 = Low ON
Monitor Voltage Select		Selects the voltage monitor output range.
	F-96	0 = 5V, 1 = 10V
Control Range		Selects the external control range for external voltage or resistance control.
	F-97	0 = 5V [5kΩ], 1 = 10V [10kΩ]
External Output Control Function		Set external output control on or off.
	F-98	0 = OFF, 1 = ON

Trigger Input and Output Configuration Settings

Trigger Input Width	<p>Sets the trigger input width in milliseconds. If the width is set to 0 then the input trigger is controlled by the input active level.</p> <p>F100 0 ~ 60ms. 0 = trigger controlled by trigger level.</p>
Trigger Input Action	<p>Determines what actions are performed when a trigger is received.</p> <p>F102 0 = None 1 = Output ON/OFF (refer to F103) 2 = Setting (refer to F104 & F105) 3 = Memory (refer to F106)</p>
Output State When Receiving Trigger	<p>Applies the output state when receiving a trigger.</p> <p>F103 0 = OFF 1 = ON</p>
Apply Voltage Setting on Trigger	<p>Applies the setting voltage when a trigger is received. Only applicable when F102 = 2.</p> <p>F104 0 ~ the rated voltage</p>
Apply Current Setting on Trigger	<p>Applies the setting current when a trigger is received. Only applicable when F102 = 2.</p> <p>F105 0 ~ the rated current</p>
Recall memory number	<p>Recalls the selected memory when a trigger is received.</p> <p>F106 1 = M1 2 = M2 3 = M3</p>

Trigger Output Pulse Width	Trigger output pulse width. A setting of 0 will output the active level.
----------------------------	--

F120	0 ~ 60ms. 0 = output active level
------	-----------------------------------

Trigger Output Level	Sets the active level of the output trigger if the trigger output pulse width (F120) = 0.
----------------------	---

F121	0 = LOW 1 = HIGH
------	---------------------

Trigger Source	Sets the trigger source.
----------------	--------------------------

F122	0 = None 1 = Switching the output on/off 2 = Changing a setting 3 = Recalling a memory
------	---

Special Function

Special Function	<p>The special function setting is used to access calibration, firmware updates and other special functions. The special function setting has a password that is used to access the special function menu. The password used determines which function is accessed. Please see your distributor for details.</p> <p>F-00 0000 ~ 9999</p>
------------------	---

Setting Normal Function Settings

The Normal Function settings, F-01~F-61, F-70~F-78, F-88~F-89 and F100~F122 can be easily configured with the Function key.

- Ensure the load is not connected.
- Ensure the output is off.
- Function settings F-90~98 can only be viewed.



Note

Function setting F-89 (Show Version) can only be viewed, not edited.

Configuration settings F-90~ F-98 cannot be edited in the Normal Function settings. Use the Power On Configuration settings. See page 119 for details.

Steps

1. Press the Function key. The function key will light up.



2. The display will show F-01 on the left and the configuration setting for F-01 on the right.



3. Rotate the Voltage knob to change the F setting.

Range F-00~F-61, F-70~F-78,
F-88~F-98, F100~F122

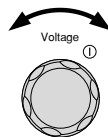

4. Use the Current knob to set the parameter for the chosen F setting.

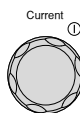

Press the Voltage knob to save the configuration setting. ConF will be displayed when it is configuring.

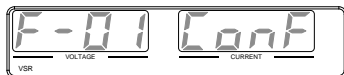
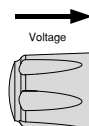

Exit

Press the Function key again to exit the configuration settings. The Function key light will turn off.



Setting Power On Configuration Settings

Background The Power On Configuration settings can only be changed during power up to prevent the configuration settings being inadvertently changed.

- Ensure the load is not connected.
- Ensure the power supply is off.

Steps

1. Hold the Function key whilst turning the power on.

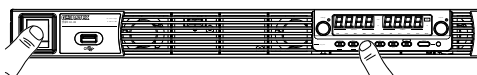

2. The display will show F-90 on the left and the configuration setting for F-90 on the right.

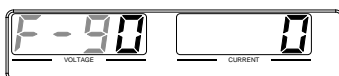

3. Rotate the Voltage knob to change the F setting.

Range F-90 ~ F-98

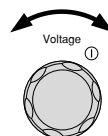

4. Use the Current knob to set the parameter for the chosen F setting.

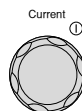

Press the Voltage knob to save the configuration setting. ConF will be displayed when it is configuring.

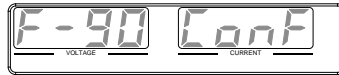
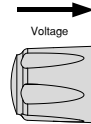

Exit

Cycle the power to save and exit the configuration settings.

A ANALOG CONTROL

The Analog Control chapter describes how to control the voltage or current output using an external voltage or resistance, monitor the voltage or current output as well as remotely turning off the output or shutting down the power supply.

Analog Remote Control Overview	122
Analog Control Connector Overview	123
External Voltage Control of Voltage Output	126
External Voltage Control of Current Output	129
External Resistance Control of Voltage Output	131
External Resistance Control of Current Output	133
External Control of Output	136
External control of Shutdown	139
Remote Monitoring.....	141
External Voltage and Current Monitoring	141
External Operation and Status Monitoring.....	144
External Trigger In/Out.....	147
Isolated Analog Control Option	149
Isolated Analog Control Option Specifications	150
0~5V / 0~10V Option (PSU-ISO-V)	150
4~20mA Option (PSU-ISO-I)	150
Isolated Analog Control Option Overview	151
Isolated External Voltage Control of Voltage Output.....	152
Isolated External Voltage Control of Current Output.....	155
Isolated External Current Control of Voltage Output.....	157
Isolated External Current Control of Current Output	160
Isolated External Voltage and Current Monitoring.....	162

Analog Remote Control Overview

The PSU power supply series have a number of analog control options. The Analog Control connectors are used to control output voltage and current using external voltage or resistance. The power supply output can also be controlled using external switches.

There is also an isolated analog control option. The Isolated analog connector is used to control the output voltage and current using an isolated external voltage or current source. Like the analog connector, it can also be used to monitor the current and voltage output as well. Use GW Instek part number PSU-ISO-V for voltage control and monitoring, and use PSU-ISO-I for current control and monitoring.

- Analog control connector overview → from page 123
- External voltage control of voltage output → from page 126
- External voltage control of current output → from page 129
- External resistance control of voltage output → from page 131
- External resistance control of current output → from page 133
- External control of output → from page 136
- External control of the shutdown → from page 139

Analog Control Connector Overview

Overview The Analog Control Connector is a 25 pin connector that can be used with the ARC (analog remote control) kit for wiring connections. The connector is used for all analog remote control. The pins used determine what remote control mode is used.

Pin Assignment

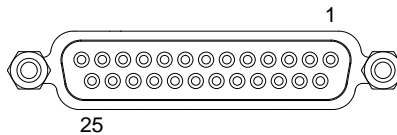

Pin name	Pin number	Description
Status COM1	1	This is the common line for the status signal pins 2 to 3 and 14 to 16.
CV Status	2	This line is on when the PSU is in CV mode (photocoupler open collector output) ¹ .
CC Status	3	This line is on when the PSU is in CC mode (photocoupler open collector output) ¹ .
TRIG IN	4	Trigger signal input line (for test script only).
Status COM2	5	This is the common line for status signal pins 4 and 17.
N.C.	6	Not connected.
Shutdown	7	Output shutdown control line. The output is turned off when a low level TTL signal is applied.
PRL IN-	8	Negative input line for master-slave parallel operation.
PRL IN+	9	Positive input line for master-slave parallel operation.

Alarm Clear	10 Alarm clear line. Alarms are cleared when a low level TTL signal is applied.
A COM	11 This is the common line for the external signal pins 7 to 10, 12, 13, 19, 21, 22, 24, and 25. It is connected internally to the negative output.
PRL OUT+	12 Positive output line for master-slave parallel operation.
Current Sum	13 Current signal line for master-slave parallel operation.
Alarm Status	14 On when a protection function (OVP, HW OVP, OCP, OHP, FAN or SEN) has been activated or when an output shutdown signal is being applied (open-collector photocoupler output). ¹
PWR ON Status	15 Outputs a low level signal when power is turned on. (open-collector photocoupler output). ¹
OUT ON Status	16 On when the output is on (open-collector photocoupler output). ¹
TRIG OUT	17 Trigger signal output line (for test script only).
N.C.	18 Not connected.
OUT ON/OFF CONT	19 Output on/off line. On when set to a low level TTL signal, Off when set to a high level TTL signal. (F-94: 1) On when set to a high level TTL signal, Off when set to a low level TTL signal. (F-94: 0)
A COM	20 This is the common line for the external signal pins 7 to 10, 12, 13, 19, 21, 22, 24, and 25. It is connected internally to the negative output.
EXT-V/R CC CONT	21 This line uses an external voltage or resistance to control the output current. External voltage control (F-91: 1); External resistor control (F-91: 2, F-91: 3). 0 to 5V or 0 to 5k Ω ; 0 % to 100 % of the rated output current (F-97: 0). 0 to 10V or 0 to 10k Ω ; 0 % to 100 % of the rated output current (F-97: 1).

EXT-V/R CV CONT	22 This line uses an external voltage or resistance to control the output voltage. External voltage control (F-90: 1); External resistor control (F-90: 2, F-90: 3). 0 to 5V or 0 to 5k Ω ; 0 % to 100 % of the rated output voltage (F-97: 0). 0 to 10V or 0 to 10k Ω ; 0 % to 100 % of the rated output voltage (F-97: 1).
A COM	23 This the common line for the external signal pins 7 to 10, 12, 13, 19, 21, 22, 24, and 25. It is connected internally to the negative output.
I MON	24 Output current monitor. 0 % to 100 % of the rated output current is generated as a voltage between 0V and 5V (F-96: 0) or a voltage between 0V and 10V (F-96: 1).
V MON	25 Output voltage monitor. 0 % to 100 % of the rated output voltage is generated as a voltage between 0V and 5V (F-96: 0) or a voltage between 0V and 10V (F-96: 1).

1. Open collector output: 30V max, 8mA max.

The common line for the status pins is floating (isolated voltage of 60 V or less). It is isolated from the control circuit.

External Voltage Control of Voltage Output

Background

External voltage control of the voltage output is accomplished using the analog control connector on the rear panel. There are two external voltage control ranges, 0~5V and 0~10V, depending on the F-97 configuration. See page 114 for details.

For 0~10V:

Output voltage = full scale voltage x (external voltage/10)

For 0~5V:

Output voltage = full scale voltage x (external voltage/5)

Connection

When connecting the external voltage source to the analog connector, use shielded or twisted paired wiring.

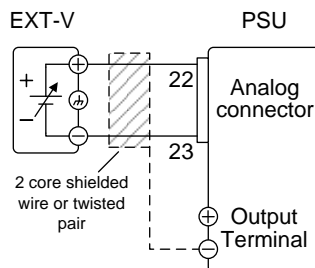

- Pin23 → EXT-V (-)
- Pin22 → EXT-V (+)
- Wire shield → negative (-) output terminal

Connection- alt. shielding

If the wire shield needs to be grounded at the voltage source (EXT-V), then the shield cannot also be grounded at the negative (-) terminal output of the PSU power supply. This would short the output.

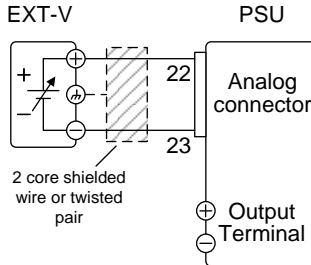

- Pin23 → EXT-V(-)
- Pin22 → EXT-V(+)
- Wire shield → EXT-V ground (GND)

Panel operation

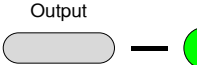
1. Connect the external voltage according to the connection diagrams above.
2. Set the F-90 power on configuration setting to 1 (CV control - Ext voltage). Page 119
 - Be sure to cycle the power after the power on configuration has been set.
3. Press the Function key and confirm the new configuration settings (F-90=1). Function 
4. Press the Output key. The voltage can now be controlled with the External voltage. Output 

**Note**

The input impedance for external voltage control is 1M Ω .

Use a stable voltage supply for the external voltage control.

**Note**

CV and CC Slew Rate Priority are disabled for V-I mode (F-03) when using external voltage control. See the normal function settings on page 104.

**CAUTION**

Ensure no more than 10.5V (F-97 = 1) or 5.25 (F-97 = 0) volts are input into the external voltage input.

Ensure the voltage polarity is correct when connecting the external voltage.

External Voltage Control of Current Output

Background

External voltage control of the current output is accomplished using the analog control connector on the rear panel. There are two external voltage control ranges, 0~5V and 0~10V, depending on the F-97 configuration. See page 114 for details.

For 0~10V:

Output current = full scale current \times (external voltage/10)

For 0~5V:

Output current = full scale current \times (external voltage/5)

Connection

When connecting the external voltage source to the connectors, use shielded or twisted paired wiring.

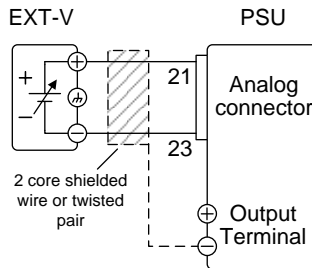

- Pin23 → EXT-V (-)
- Pin21 → EXT-V (+)
- Wire shield → negative (-) output terminal

Connection- alt. shielding

If the wire shield needs to be grounded at the voltage source (EXT-V), then the shield cannot also be grounded at the negative (-) terminal output of the PSU power supply. This would short the output.

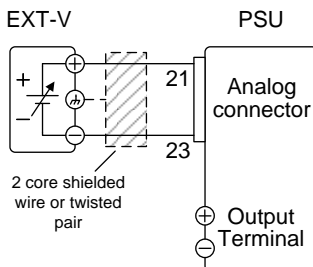

- Pin23 → EXT-V (-)
- Pin21 → EXT-V (+)
- Wire shield → EXT-V ground (GND)

Steps

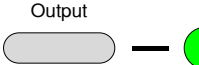
1. Connect the external voltage according to the connection diagrams above.
2. Set the F-91 power on configuration setting to 1 (CC control - Ext voltage). Page 119
 - Be sure to cycle the power after the power on configuration has been set.
3. Press the Function key and confirm the new configuration settings (F-91=1). Function 
4. Press the Output key. The current can now be controlled with the External voltage. Output 



Note

The input impedance for external voltage control is $1\text{M}\Omega$.

Use a stable voltage supply for the external voltage control.



Note

CV and CC Slew Rate Priority are disabled for V-I mode (F-03) when using external voltage control. See the normal function settings on page 104.



CAUTION

Ensure the voltage polarity is correct when connecting the external voltage.

Ensure no more than 10.5V (F-97 = 1) or 5.25 (F-97 = 0) volts are input into the external voltage input.

External Resistance Control of Voltage Output

Background

External resistance control of the voltage output is accomplished using the analog control connector on the rear panel.

There are two external resistance control ranges, $0\sim 5\text{k}\Omega$ and $0\sim 10\text{k}\Omega$, depending on the F-97 configuration. See page 114 for details.

The output voltage (0 to full scale) can be controlled with the external resistance rising $0\text{k}\Omega\sim 5\text{k}\Omega/0\text{k}\Omega\sim 10\text{k}\Omega$ or falling $5\text{k}\Omega\sim 0\text{k}\Omega/10\text{k}\Omega\sim 0\text{k}\Omega$.

Rising:

For $0\text{k}\Omega\sim 10\text{k}\Omega$: Output voltage = full scale voltage \times (external resistance/10)

For $0\text{k}\Omega\sim 5\text{k}\Omega$: Output voltage = full scale voltage \times (external resistance/5)

Falling:

For 10kΩ~0kΩ: Output voltage = full scale voltage × ([10-external resistance]/10)

For 5kΩ~0kΩ: Output voltage = full scale voltage × ([5-external resistance]/5)



Note

The falling resistance configuration is recommended for safety reasons. In the event that the cables become accidentally disconnected (high Ω), the voltage output will drop to zero. Under similar circumstances using the rising resistance configuration, an unexpectedly high voltage would be output.

If switches are used to switch between fixed resistances, use switches that avoid creating open circuits. Use short-circuit or continuous resistance switches.

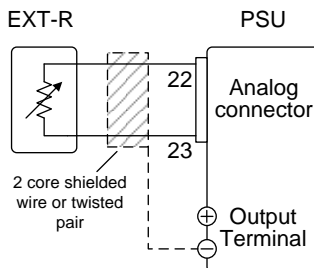

Connection



- Pin22 → EXT-R
- Pin23 → EXT-R
- Wire shield → negative (-) output terminal

Steps

1. Connect the external resistance according to the connection diagrams above.
2. Set the F-90 (CV Control) configuration settings to 2 for Ext-R rising or 3 for Ext-R falling.

- Be sure to cycle the power after the power on configuration has been set.
3. Press the Function key and confirm the new configuration settings (F-90=2 or 3). 
 4. Press the Output key. The voltage can now be controlled with the External resistance. 



Note

Ensure the resistor(s) and cables used exceed the isolation voltage of the power supply. For example: insulation tubes with a withstand voltage higher than the power supply can be used.

When choosing an external resistor ensure the resistor can withstand a high degree of heat.



Note

CV and CC Slew Rate Priority are disabled for V-I mode (F-03) when using external resistance control. See the normal function settings on page 104.

External Resistance Control of Current Output

Background

External resistance control of the current output is accomplished using the analog connector on the rear panel.

There are two external resistance control ranges, 0~5k Ω and 0~10k Ω , depending on the F-97 configuration. See page 114 for details.

The output current (0 to full scale) can be controlled with the external resistance rising 0k Ω ~5k Ω /0k Ω ~10k Ω or falling

$5\text{k}\Omega \sim 0\text{k}\Omega / 10\text{k}\Omega \sim 0\text{k}\Omega$.

Rising:

For $0\text{k}\Omega \sim 10\text{k}\Omega$: Output current = full scale current \times (external resistance/10)

For $0\text{k}\Omega \sim 5\text{k}\Omega$: Output current = full scale current \times (external resistance/5)

Falling:

For $10\text{k}\Omega \sim 0\text{k}\Omega$: Output current = full scale current \times [(10-external resistance)/10]

For $5\text{k}\Omega \sim 0\text{k}\Omega$: Output current = full scale current \times [(5-external resistance)/5]



Note

The falling resistance configuration is recommended for safety reasons. In the event that the cables become accidentally disconnected, the current output will drop to zero (high Ω). Under similar circumstances using the rising configuration, an unexpectedly high current would be output.

If switches are used to switch between fixed resistances, use switches that avoid creating open circuits. Use short-circuit or continuous resistance switches.

Connection

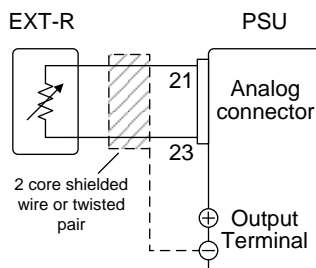

- Pin21 → EXT-R
- Pin23 → EXT-R
- Wire shield → negative (-) output terminal

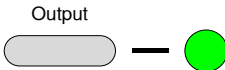
- Steps
1. Connect the external resistance according to the connection diagrams above.
 2. Set the F-91 (CC Control) configuration settings to 2 for external resistor rising or to 3 for external resistor falling. Page 119
 - Be sure to cycle the power after the power on configuration has been set.
 3. Press the Function key and confirm the new configuration settings (F-91 = 2 or 3). 
 4. Press the Output key. The current can now be controlled with the External resistance. 



Ensure the resistor(s) and cables used exceed the isolation voltage of the power supply. For example: insulation tubes with a withstand voltage higher than the power supply can be used.

When choosing an external resistor ensure the resistor can withstand a high degree of heat.



CV and CC Slew Rate Priority are disabled for V-I mode (F-03) when using external resistance control. See the normal function settings on page 104.

External Control of Output

Background

The output can be turned on or off externally using a switch. The analog control connector can be set to turn the output on from a high or low signal. The voltage across pins 19 and 20 are internally pulled up to $+5V \pm 5\%$ @ $500\mu A$ with $10k\Omega$ pull-up resistor. A short (closed switch) produces a low signal.

When set to High = On, the output is turned on when the pins 19-20 are open.

When Low = On, the output is turned on when pins 19-20 are shorted.

Connection

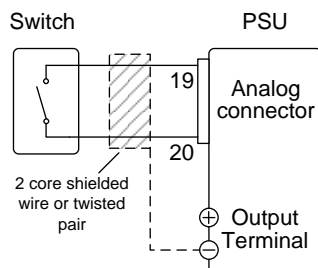

- Pin19 → Switch
- Pin20 → Switch
- Wire shield → negative (-) output terminal

Steps

1. Connect the external switch according to the connection diagrams above.

Set F-94 (External output logic) in Page 119 the power on configuration settings to 0 (High = On) or 1 (Low = On) and set F-98 (External output control function) to 1(On).

- Be sure to cycle the power after setting the power on configuration settings.
2. Press the Function key and confirm the new configuration settings (F-94 = 0 or 1 and F-98=1). 
 3. The switch is now ready to set the output on or off.



Note

When using a switch over long distances, please use a switch relay to extend the line from the coil side of the relay.

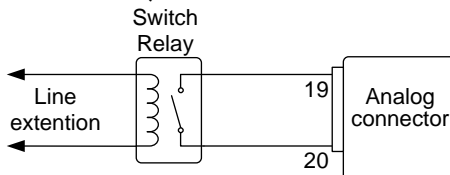

If a single switch control is to be used for multiple units, please isolate each instrument. This can be achieved by using a relay.



Warning

Ensure the cables used and the switch exceed the isolation voltage of the power supply. For example: insulation tubes with a withstand voltage higher than the power supply can be used.

**Note**

Messages: If F-94 = 0 (High = on) and pin 19 is low (0) “MSG 001” will be displayed on the display.

If F-94 = 1 (Low = on) and pin 19 is high (1) “MSG 002” will be displayed on the display.

Output off (High=on)

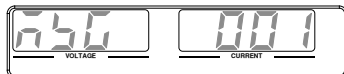

Output off (Low=on)

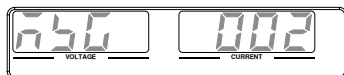
**Note**

Output ON/OFF Delay Time (F-01, F-02) are disabled when the output is set to external control. See the normal function settings on 104 for details.

External control of Shutdown

Background The output of the power supplies can be configured to shut down via an external switch. The voltage across pins 7 and 20 are internally pulled to +5V \pm 5% @ 500uA with 10k Ω pull-up resistor. The output is turned off when a low TTL level signal is applied.

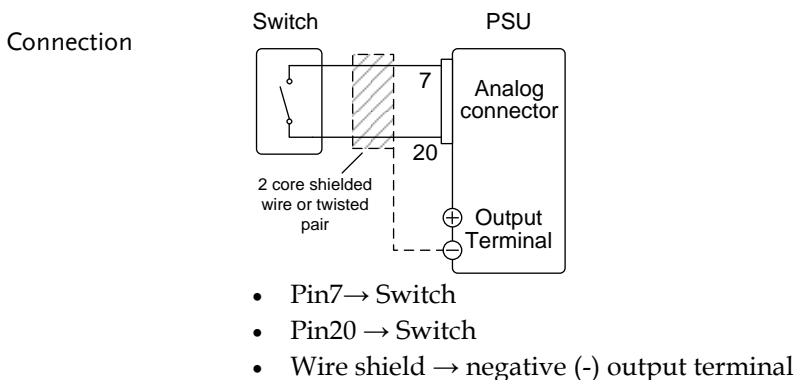

- Steps**
1. Connect the external switches according to the connection diagrams above.
 2. The switch will now shut down the power supply when shorted.
-



Note

When using a switch over long distances, please use a switch relay to extend the line from the coil side of the relay.

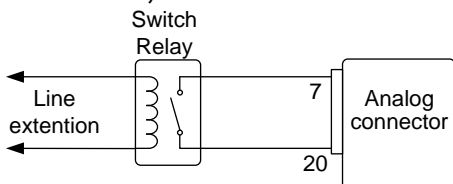

If a single switch control is to be used for multiple units, please isolate each instrument. This can be achieved by using a relay.



Warning

Ensure the cables and switch used exceed the isolation voltage of the power supply. For example: insulation tubes with a withstand voltage higher than the power supply can be used.

Remote Monitoring

The PSU power supplies have remote monitoring support for current and voltage output. They also support monitoring of operation and alarm status.

- External monitoring of output voltage and current → from page 141
- External monitoring of operation mode and alarm status → from page 144
- External Trigger In/Out → from page 147

External Voltage and Current Monitoring

Background

The analog connector is used to monitor the current (IMON) or voltage (VMON) output.

An output of 0~10V or 0~5V (depending on the configuration) represents the voltage or current output of 0~ rated current/voltage output.

- $IMON = (\text{current output} / \text{full scale}) \times 10 \text{ or } 5.$
 - $VMON = (\text{voltage output} / \text{full scale}) \times 10 \text{ or } 5.$
-

Configuration

The PSU doesn't need to be configured to use external voltage or current monitoring, however the voltage or current output range does need to be configured. The monitor output voltage can be configured as either 0~10V or 0~5V.

Set F-96 (Monitor Voltage Select) Page 119 in the power on configuration settings to 0 (5V) or 1 (10V).

- Be sure to cycle the power after setting the power on configuration settings.

3. Press the Function key and confirm the new configuration settings (F-96 = 0 or 1).



4. An external DMM can now be used to monitor the voltage or current output.

VMON Connection

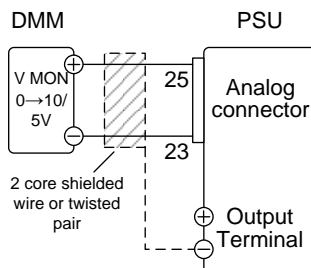

- Pin25 → Pos (+)
- Pin23 → Neg (-)

IMON Connection

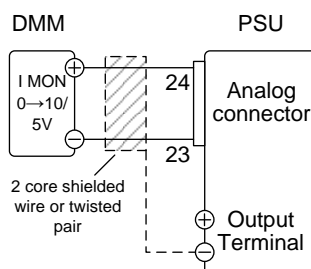

- Pin24 → Pos (+)
- Pin23 → Neg (-)

**Note**

Maximum current is 5mA. Ensure the sensing circuit has an input impedance greater than 1M Ω .

The monitor outputs are strictly DC and should not be used to monitor analog components such as transient voltage response or ripple etc.

**CAUTION**

Ensure IMON (pin 24) and VMON (pin 25) are not shorted together. This may cause damage to the unit.

External Operation and Status Monitoring

Background The analog control connector can also be used to monitor the status operation and alarm status of the instrument.

The pins are isolated from the power supply internal circuitry by photo couplers. Status Com1 (Pin 1) and Status Com2 (Pin 5) are photo coupler emitter outputs, whilst pins 2~3, 14~17 are photo coupler collector outputs.

A maximum of 30V and 8mA can be applied to each pin. The Status Com pin is floating with an isolation voltage of 60V.

Pinout	Name and Pin	Description
	STATUS COM1 1	Common (photo coupler emitter) for status signals 2, 3, 14, 15 and 16.
	CV STATUS 2	Low when CV mode is active.
	CC STATUS 3	Low when CC mode is active.
	ALM STATUS 14	Low when any of the protection modes are tripped (OVP, OCP, Sense_ALM, OTP_M, AC Fail, OTP_S, Fan_Fail, HW_OVP, and Shutdown). Active low.
	PWR ON STATUS 15	Active low.
	OUT ON STATUS 16	Low when the output is on.

Schematic

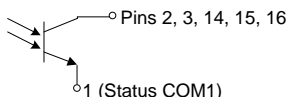

Timing diagrams Below are 4 example timing diagrams covering a number of scenarios. Note that pins 14~16 are all active low.

CV MODE:
Output turned on The diagram below shows the timing diagram when the output is turned on when the PSU is set to CV mode.

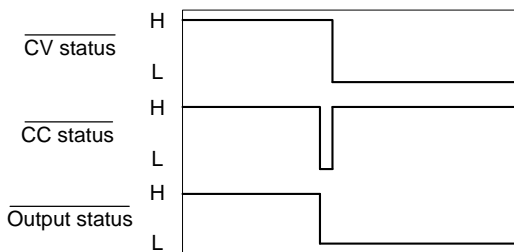

CV MODE:
Output turned off The diagram below shows the output status lines when the output is turned off in CV mode.

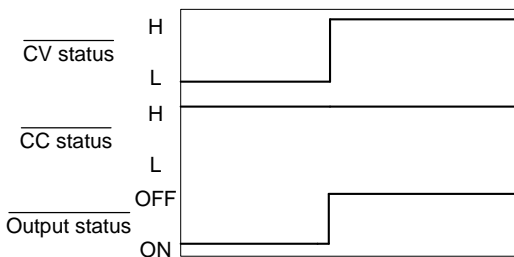

CC MODE:
Output turned on

The diagram below shows the timing diagram when the output is turned on when the PSU is set to CC mode.

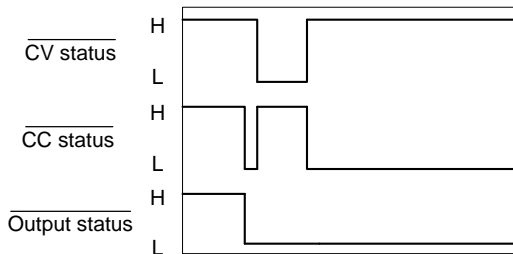

CC MODE:
Output turned off

The diagram below shows the output status lines when the output is turned off in CC mode.

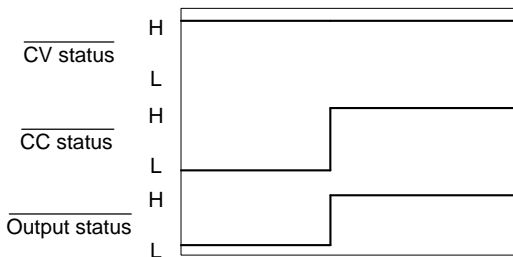

External Trigger In/Out

Background

Pin 4 is used for the external trigger input and pin 17 is used as the trigger output. Pin 5 is the common for both pins.

The trigger input can be configured to perform an action such as toggling the output on/off, load a memory setting or apply a voltage/current setting when a trigger is received. The trigger input pulse width can also be configured.

The trigger output can be configured to be active when the output is turned on/off, a setting is changed or when a memory setting has been recalled. The trigger output pulse width or level polarity can also be configured.

See page 115 for details on the trigger input and trigger output configuration settings.

Pinout	Name and Pin	Description
	STATUS COM2	5 Common (photo coupler emitter) for trigger pins 4, 17.
	TRIG IN	4 External trigger input
	TRIG OUT	17 The TRIG OUT signal is held high by an internal 330Ω resistor. The trigger output is pulsed or held high/low for each trigger (depending on the trigger configuration).

Schematic

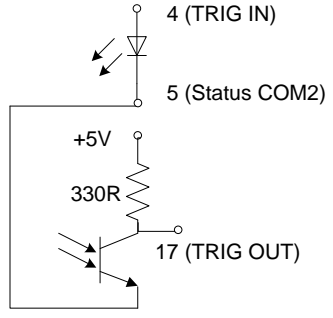

Isolated Analog Control Option

The PSU power supplies can use the isolated analog connector for external control and remote monitoring.

- Isolated analog control option specifications → 150
- Isolated analog control option overview → 151
- Isolated external voltage control of voltage output → 152
- Isolated external voltage control of current output → 155
- Isolated external current control of voltage output → 157
- Isolated external current control of current output → 160
- Isolated external voltage and current monitoring → 162

Isolated Analog Control Option Specifications

0~5V / 0~10V Option (PSU-ISO-V)

External voltage control output voltage	%	Accuracy and linearity: $\pm 1\%$ of rated output voltage
External voltage control output current	%	Accuracy and linearity: $\pm 1\%$ of rated output current
Temperature coefficient	ppm/ $^{\circ}\text{C}$	100ppm/ $^{\circ}\text{C}$ of rated voltage or current, after a 30 minute warm-up
Programming input impedance	Ohm	1M
Absolute maximum voltage	V	0~10.5V
Output voltage monitor	%	Accuracy: $\pm 1.5\%$
Output current monitor	%	Accuracy: $\pm 1.5\%$
Monitor output impedance	Ohm	100

4~20mA Option (PSU-ISO-I)

External current control output voltage	%	Accuracy and linearity: $\pm 1\%$ of rated output voltage
External current control output current	%	Accuracy and linearity: $\pm 1\%$ of rated output current
Temperature coefficient	ppm/ $^{\circ}\text{C}$	200ppm/ $^{\circ}\text{C}$ of rated voltage or current, after a 30 minute warm-up.
Programming input impedance	Ohm	50
absolute maximum voltage	mA	4~21mA
Output voltage monitor	%	Accuracy: $\pm 1.5\%$
Output current monitor	%	Accuracy: $\pm 1.5\%$

Isolated Analog Control Option Overview

Overview The Isolated Analog Connectors are 8 pin sockets that are optically isolated from the power supply, allowing inputs with ground references that differ to the power supply. The isolated options include either an isolated voltage (0~5V/0~10V) interface or an isolated current (4~20mA) interface. Only one type of isolated interface can be used at any one time. The pins used determine what remote control mode is used.

 **Note** The GPIB Option (PSU-GPIB), the isolated voltage option (PSU-ISO-V) and the isolated current option (PSU-ISO-I) all use the same option slot, meaning that only one of the three options can be used at any one time.

Pin Assignment Isolated Voltage Connector

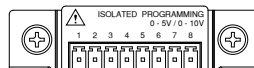

Isolated Current Connector

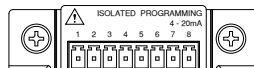

Pin name	Pin number	Description
SHIELD	1	Shield, connected internally to the chassis of the power supply.
+VPROG_ISO	2	Output Voltage programming input.
+IPROG_ISO	3	Output Current programming input.
GND_ISO	4	Ground for programming signals.
GND_ISO	5	Ground for programming signals.
+VMON_ISO	6	Output Voltage monitoring output.
+IMON_ISO	7	Output Current monitoring output.
Shield	8	Shield, connected internally to the chassis of the power supply.

Isolated External Voltage Control of Voltage Output

Background Voltage control of the voltage output uses the isolated voltage option (PSU-ISO-V). A voltage of 0~5V or 0~10V is used to control the full scale voltage of the instrument, where:

For 0~5V: Output voltage = full scale voltage × (external voltage/5)

For 0~10V: Output voltage = full scale voltage × (external voltage/10)

Connection When connecting the external voltage source to the isolated voltage option, use shielded or twisted paired wiring.

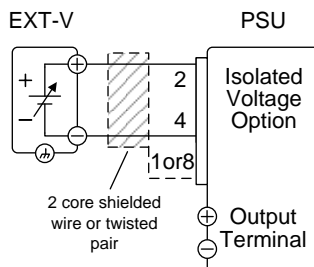

- Pin4(GND_ISO) → EXT-V (-)
- Pin2(+VPROG_ISO) → EXT-V (+)
- Pin 1 or 8 (Shield) → Wire shield

Connection- alt. shielding

If the wire shield needs to be grounded at the voltage source (EXT-V), then it can be connected as shown below.

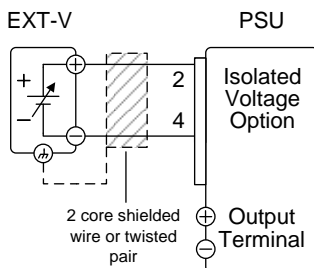

- Pin4(GND_ISO) → EXT-V (-)
- Pin2(+VPROG_ISO) → EXT-V (+)
- EXT-V ground (GND) → Wire shield

Panel operation

1. Connect the external voltage according to the connection diagrams above.
2. Set the F-90 power on configuration setting to 4 (Control by Isolated Board). Page 119
3. Set the F-97 power on configuration setting to 0 (0~5V control range) or to 1 (0~10V control range). Page 119
 - Be sure to cycle the power after the power on configuration has been set.
4. Press the Function key and confirm the new configuration settings (F-90=4, F-97=0 or 1). Function 

5. Press the Output key. The voltage can now be controlled with the isolated external voltage control.

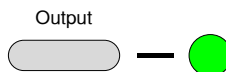

Note

The input impedance for isolated external voltage control is 1M Ω .

Use a stable voltage supply for the external voltage control.



Note

CV and CC Slew Rate Priority are disabled for V-I mode (F-03) when using external voltage control. See the normal function settings on page 104.



CAUTION

Ensure the voltage polarity is correct when connecting the external voltage.

Ensure no more than 10.5V (for the 0~10V setting) or 5.25V (for the 0~5V setting) are to be input into the isolated voltage input.

Isolated External Voltage Control of Current Output

Background Voltage control of the current output uses the isolated voltage option (PSU-ISO-V). A voltage of 0~5V or 0~10V is used to control the full scale current of the instrument, where:

For 0~5V: Output current = full scale current × (external voltage/5)

For 0~10V: Output current = full scale current × (external voltage/10)

Connection When connecting the external voltage source to the isolated voltage option, use shielded or twisted paired wiring.

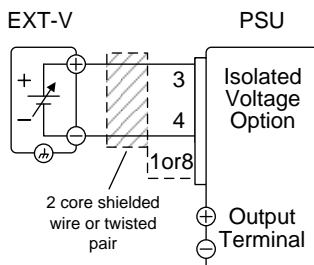

- Pin4(GND_ISO) → EXT-V (-)
- Pin3(+IPROG_ISO) → EXT-V (+)
- EXT-V ground (Shield) → Wire shield

Connection- alt. shielding

If the wire shield needs to be grounded at the voltage source (EXT-V), then it can be connected as shown below.

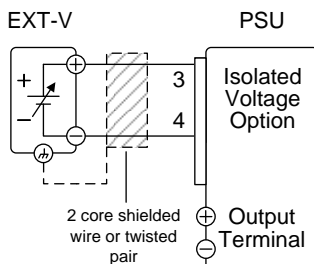

- Pin4(GND_ISO) → EXT-V (-)
- Pin3(+IPROG_ISO) → EXT-V (+)
- Wire shield → EXT-V ground (GND)

Steps

1. Connect the external voltage according to the connection diagrams above.
2. Set the F-91 power on Page 119
configuration setting to 4 (Control by Isolated Board).
3. Set the F-97 power on Page 119
configuration setting to 0 (0~5V control range) or 1 (0~10V control range).
 - Be sure to cycle the power after the power on configuration has been set.
4. Press the Function key and confirm the new configuration settings (F-91=4, F-97=0 or 1). Function 

5. Press the Output key. The current can now be controlled with the isolated external voltage control.

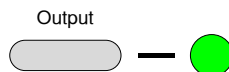

Note

The input impedance of isolated external voltage control is 1MΩ.

Use a stable voltage supply for the external voltage control.



Note

CV and CC Slew Rate Priority are disabled for V-I mode (F-03) when using external voltage control. See the normal function settings on page 104.



CAUTION

Ensure the voltage polarity is correct when connecting the external voltage.

Ensure no more than 10.5V (for the 0~10V setting) or 5.25V (for the 0~5V setting) are input into the external voltage input.

Isolated External Current Control of Voltage Output

Background

Current control of the voltage output uses the isolated current option (PSU-ISO-I). A current of 4~20mA is used to control the full scale voltage of the instrument, where:

Output voltage = full scale voltage × ((external current-4mA)/16mA)

Connection When connecting the external current source to the isolated analog option, use shielded or twisted paired wiring.

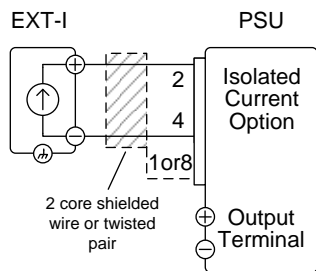

- Pin4(GND_ISO) → EXT-I (-)
- Pin2(+VPROG_ISO) → EXT-I (+)
- Pin 1 or 8 (Shield) → Wire shield

Connection- alt. shielding If the wire shield needs to be grounded at the current source (EXT-I), then it can be connected as shown below.

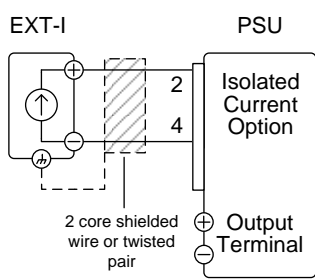

- Pin4(GND_ISO) → EXT-I (-)
- Pin2(+VPROG_ISO) → EXT-I (+)
- EXT-I ground (GND) → Wire shield

Panel operation 1. Connect the external current source according to the connection diagrams above.

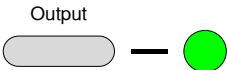
2. Set the F-90 power on configuration setting to 4 (Control by Isolated Board). Page 119
3. Set the F-96 power on configuration setting to 1.
4. Set the F-97 power on configuration setting to 1.
- Be sure to cycle the power after the power on configuration has been set.
5. Press the Function key and confirm the new configuration settings (F-90=4, F-96=1, F-97=1). 
6. Press the Output key. The voltage can now be controlled with the isolated external current control. 



Note

Use a stable current supply for the external voltage control.



Note

CV and CC Slew Rate Priority are disabled for V-I mode (F-03) when using external current control. See the normal function settings on page 104.



CAUTION

Ensure the polarity is correct when connecting the external current.

Ensure no more than 21mA are input into the external isolated current input.

Isolated External Current Control of Current Output

Background Current control of the current output uses the isolated current option (PSU-ISO-I). A current of 4~20mA is used to control the full scale current of the instrument, where:

$$\text{Output current} = \text{full scale current} \times ((\text{external current} - 4\text{mA}) / 16\text{mA})$$

Connection When connecting the external current source to the isolated current option, use shielded or twisted paired wiring.

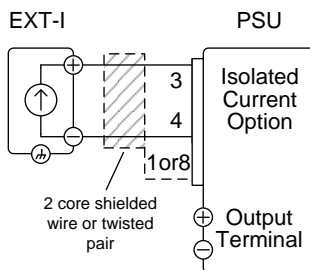

- Pin4(GND_ISO) → EXT-I (-)
- Pin3(+IPROG_ISO) → EXT-I (+)
- Pin 1 or 8 (Shield) → Wire shield

Connection- alt. shielding

If the wire shield needs to be grounded at the current source (EXT-I) , then it can be connected as shown below.

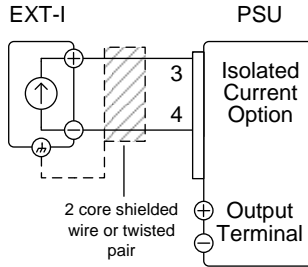

- Pin4(GND_ISO) → EXT-I (-)
- Pin3(+IPROG_ISO) → EXT-I (+)
- Wire shield → EXT-I ground (GND)

Steps

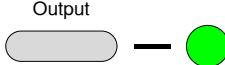
1. Connect the external current according to the connection diagrams above.
2. Set the F-91 power on configuration setting to 4 (Control by Isolated Board). Page 119
3. Set the F-96 power on configuration setting to 1.
4. Set the F-97 power on configuration setting to 1.
 - Be sure to cycle the power after the power on configuration has been set.
5. Press the Function key and confirm the new configuration settings (F-91=4, F-96=1, F-97=1). Function 
6. Press the Output key. The current can now be controlled with the External current. Output 



Note

Use a stable current source for the external current control.



Note

CV and CC Slew Rate Priority are disabled for V-I mode (F-03) when using external voltage control. See the normal function settings on page 104.



CAUTION

Ensure the polarity is correct when connecting the external voltage.

Ensure no more than 21mA are input into the external current input.

Isolated External Voltage and Current Monitoring

Background

The isolated analog connector can also be used to monitor the current (IMON) or voltage (VMON).

For the isolated voltage option, an output of 0~5V or 0~10V represents the voltage or current output of 0~ rated current/voltage output.

- $IMON = (\text{current output}/\text{full scale}) \times (5 \text{ or } 10)$
- $VMON = (\text{voltage output}/\text{full scale}) \times (5 \text{ or } 10)$

For the isolated current option, an output of 4~20mA represents the voltage or current output of 0~ rated current/voltage output.

- $IMON = ((\text{current output}/\text{full scale}) \times 16\text{mA}) + 4\text{mA}$
 - $VMON = ((\text{voltage output}/\text{full scale}) \times 16\text{mA}) + 4\text{mA}$
-

VMON
Connection

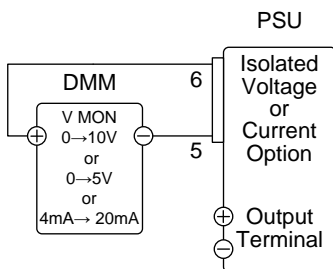

- Pin6 (+VMON_ISO) → Pos (+)
- Pin5 (GND_ISO) → Neg (-)

IMON
Connection

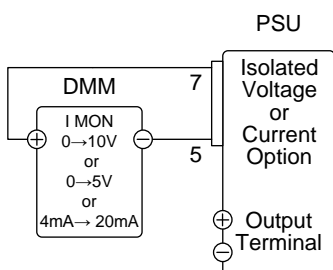

- Pin7(+IMON_ISO) → Pos (+)
- Pin5(GND_ISO) → Neg (-)

Steps

1. Connect the external voltage or external current source to the isolated voltage or current option according to the connection diagrams above.
2. If using the isolated voltage option, Page 119 set the F-96 settings to 0 (0~5V) or 1 (0~10V) to choose the VMON or IMON output range.
3. If using the isolated current option, Page 119 set the F-96 power on configuration setting to 1 to set the VMON and IMON output to 4mA ~ 20mA.
 - Be sure to cycle the power after the power on configuration has been set.

4. Press the Function key and confirm the new configuration settings (F-96=0 or 1). 
 5. The current or voltage output can now be monitored using the isolated voltage or current option.
-



Note

The monitor outputs are strictly DC and should not be used to monitor analog components such as transient voltage response or ripple etc.

C

COMMUNICATION

INTERFACE

This chapter describes basic configuration of IEEE488.2 based remote control. For a command list, refer to the programming manual, downloadable from GW Instek website, www.gwinstek.com

Interface Configuration	166
USB Remote Interface	166
Configuration.....	166
Function Check.....	167
GPIB Remote Interface.....	168
Configuration.....	168
GPIB Function Check	169
UART Remote Interface	173
Configure UART	173
UART Function Check.....	176
Multiple Unit Connection	177
Legacy Multi-Drop mode.....	177
Multi-Drop mode	179
Multiple units Function Check.....	182
Configure Ethernet Connection.....	186
Web Server Configuration	186
Web Server Remote Control Function Check.....	187
Sockets Server Configuration	189
Socket Server Function Check	190

Interface Configuration

USB Remote Interface

Configuration

USB Configuration	PC side connector	Type A, host
	PSU side connector	Rear panel Type B, slave
	Speed	1.1/2.0 (full speed/high speed)
	USB Class	CDC (communications device class)

Steps

1. Connect the USB cable to the rear panel USB B port.

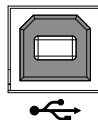

2. Change the Rear panel-USB (F-22) setting to 2 (Auto Detect Speed) or 1 (USB Full Speed).



Note

If you are not using the rear panel USB device port, set F-22 to 0 (Disable USB).

Page 117

3. The RMT indicator will turn on when a remote connection has been established.

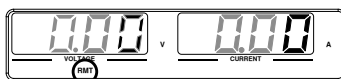

RMT indicator

Function Check

Functionality check

Invoke a terminal application such as Realterm.

To check the COM port No., see the Device Manager in the PC. For WinXP; Control panel → System → Hardware tab.

Run this query command via the terminal application after the instrument has been configured for USB remote control (page 166).

```
*idn?
```

This should return the Manufacturer, Model number, Serial number, and Firmware version in the following format.

```
GW-INSTEK,PSU40-38,TW123456,T0.01.12345678
```

```
Manufacturer: GW-INSTEK
```

```
Model number : PSU40-38
```

```
Serial number : TW123456
```

```
Firmware version : T0.01.12345678
```



Note

For further details, please see the programming manual, available on the GW Instek web site @ www.gwinstek.com.

GPIB Remote Interface

Configuration

To use GPIB, the optional GPIB option (GW Instek part number: PSU-GPIB) must be installed. This is a factory installed option and cannot be installed by the end-user. Only one GPIB address can be used at a time.

- Configure GPIB
1. Ensure the PSU is off before proceeding.
 2. Connect a GPIB cable from a GPIB controller to the GPIB port on the PSU.
 3. Turn the PSU on.
 4. Press the Function key to enter the [Page 117](#) Normal configuration settings.
 5. Set the following GPIB settings.

F-24 = 1	Enable the GPIB port
F-23 = 0~30	Set the GPIB address (0~30)
 6. Check to see that the GPIB option is detected by the PSU. The F-25 setting indicates the GPIB port status.

F-25 = 1	Indicates that the GPIB port is available.
F-25 = 0	Indicates that the GPIB port is not detected.

7. The RMT indicator will turn on when a remote connection has been established.

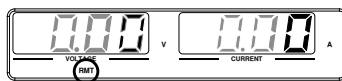

RMT indicator

-
- GPIB constraints
- Maximum 15 devices altogether, 20m cable length, 2m between each device
 - Unique address assigned to each device
 - At least 2/3 of the devices turned On
 - No loop or parallel connection

GPIB Function Check

Background To test the GPIB functionality, National Instruments Measurement and Automation Explorer can be used. This program is available on the NI website, www.ni.com, via a search for the VISA Run-time Engine page, or “downloads” at the following URL, <http://www.ni.com/visa/>

Requirements Operating System: Windows XP, 7, 8

Functionality check

1. Start the NI Measurement and Automation Explorer (MAX) program. Using Windows, press:

Start>All Programs>National Instruments>Measurement & Automation

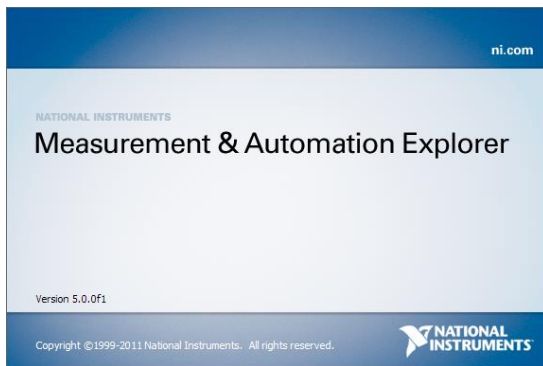

2. From the Configuration panel access;
My System>Devices and Interfaces>GPIB
3. Press *Scan for Instruments*.

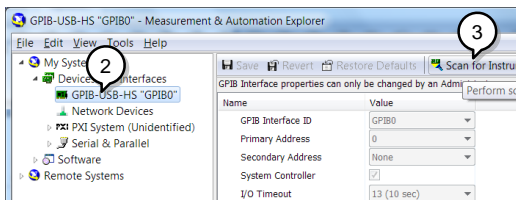

4. Select the device (GPIB address of PSU) that now appears in the *System>Devices and Interfaces > GPIB-USB-HS "GPIBX"* node.
5. Click on the *VISA Properties* tab on the bottom.
6. Click *Open Visa Test Panel*.

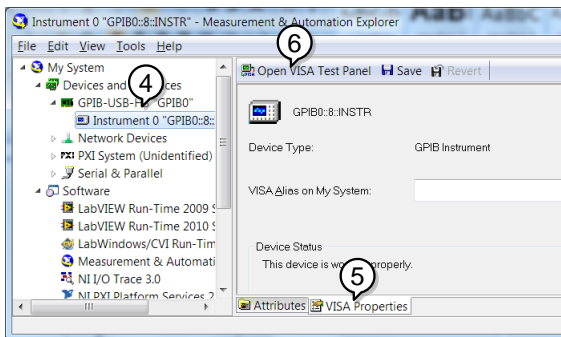

7. Click on *Configuration*.
8. Click on the *GPIB Settings* tab and confirm that the GPIB settings are correct.

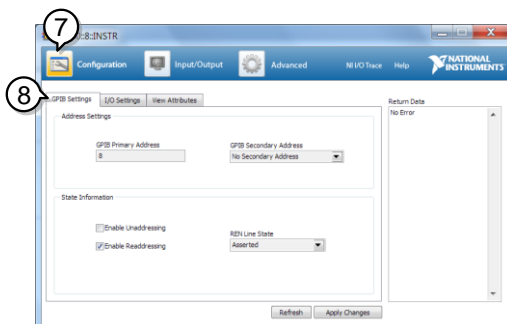

9. Click on the *I/O Settings* tab.
10. Make sure the *Enable Termination Character*

check box is checked, and the terminal character is \n (Value: xA).

11. Click *Apply Changes*.

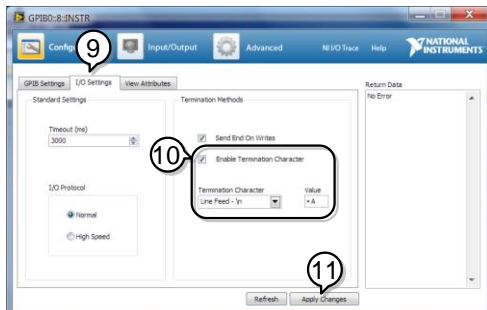

12. Click on *Input/Output*.

13. Click on the *Basic/IO* tab.

14. Enter *IDN? in the *Select or Enter Command* drop down box.

15. Click *Query*.

16. The *IDN? query will return the Manufacturer, model name, serial number and firmware version in the dialog box.

GW-INSTEK,PSU40-38,
TW123456,T0.02.20131205

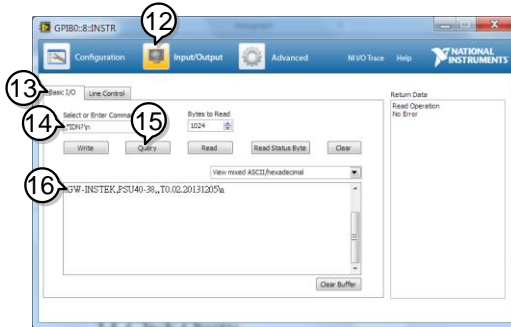

Note

For further details, please see the programming manual, available on the GW Instek web site @ www.gwinstek.com.

UART Remote Interface

Configure UART

Overview

The PSU uses the IN & OUT ports for UART communication coupled with RS232 (GW Part number PSU-232) or RS485 adapters (GW part number PSU-485).

The pin outs for the adapters are shown below.

PSU-232 RS232 cable with DB9 connector	DB-9 Connector		Remote IN Port		Remarks	
	Pin No.	Name	Pin No.	Name		
	Housing	Shield	Housing	Shield		
	2	RX	7	TX		Twisted pair
	3	TX	8	RX		
	5	SG	1	SG		

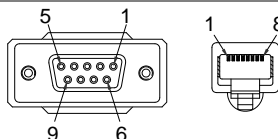

PSU-485 RS485 cable with DB9 connector

DB-9 Connector		Remote IN Port		Remarks
Pin No.	Name	Pin No.	Name	
Housing	Shield	Housing	Shield	
9	TXD -	6	RXD -	Twisted pair
8	TXD +	3	RXD +	
1	SG	1	SG	
5	RXD -	5	TXD -	Twisted pair
4	RXD +	4	TXD +	

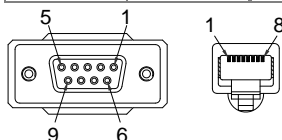

Steps

1. Connect the RS232 serial cable (include in the PSU-232 connection kit) or RS485 serial cable (include in the PSU-485 connection kit) to the Remote IN port on the real panel.

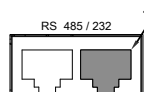

Connect the other end of the cable to the PC.

2. Press the Function key to enter the Normal configuration settings. Page 117

Set the following UART settings:

F-70 = 1 or 2	Interface: 0= Disable UART, 1= RS232 or 2 = RS485
F-71 = 0 ~ 7	Set the baud rate: 0=1200, 1=2400, 2=4800, 3=9600, 4=19200, 5=38400, 6=57600, 7=115200
F-72 = 0 or 1	Data bits: 0=7 or 1=8

F-73 = 0 ~3	Parity: 0 = none, 1 = odd, 2 = even
F-74 = 0 or 1	Stop bits: 0 = 1, 1 = 2
F-75 = 0 or 1	TCP: 0 = SCPI, 1 = TDK (emulation mode)
F-76 = 00~30	UART address for multi-unit remote connection.
F-77 = 0~3	Multi-Drop control 0 = Disable, 1 = Master, 2 = Slave, 3 = Display Information
F-78 = 00~30	Multi-Drop status display Displayed parameter: AA-S AA: 00~30 (Address), S: 0~1 (Off-line/On-line status).

- The RMT indicator will turn on when a remote connection has been established.

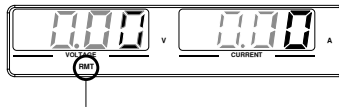

RMT indicator



If TDK (emulation mode) is selected for F-75, the TDK GENESYS legacy commands should be used for remote commands. See the TDK Genesys user manual for details.

UART Function Check

Functionality
check

Invoke a terminal application such as Realterm.

To check the COM port No, see the Device Manager in the PC. For WinXP; Control panel → System → Hardware tab.

Run this query command via the terminal application after the instrument has been configured for either RS232 or RS485 remote control (page 173).

*idn?

This should return the Manufacturer, Model number, Serial number, and Firmware version in the following format:

GW-INSTEK,PSU40-38,TW123456,T0.01.12345678

Manufacturer: GW-INSTEK

Model number : PSU40-38

Serial number : TW123456

Firmware version : T0.01.12345678



Note

For further details, please see the programming manual, available on the GW Instek web site @ www.gwinstek.com.

Multiple Unit Connection

The PSU power supplies can have up to 31 units daisy-chained together using the 8 pin connectors (IN OUT ports) on the rear panel. The first unit (master) in the chain is remotely connected to a PC using RS232 or RS485 (Legacy Multi-Drop mode), or USB, GPIB or LAN (Multi-Drop mode). Each subsequent unit (slave) is daisy-chained to the next using a RS485 local bus. The OUT port on the last terminal must be terminated by the end terminal connector.

There are two modes for controlling multiple units. The first mode only allows the user to enter TDK GENESYS legacy commands (Legacy Multi-Drop mode). All UART parameters have to be configured in this mode. The second mode allows the user to enter the SCPI commands developed for the instrument (Multi-Drop mode). In this mode, only the Multi-Drop parameters have to be specified. For both modes, each unit is assigned a unique address and can then be individually controlled from the host PC.

Legacy Multi-Drop mode

- Operation
1. Check the F-89 (System version and build date) settings first on all units (see page 111). The two parameters O and P (Option Module) must be the same on all units before any multiple unit connection can be established.

Example: F-89 O:00, P:01.

2. Connect the first unit's IN port to a PC via RS232 or RS485 serial cable.
 - Use the serial cables supplied in the PSU-232 or PSU-485 connection kit.
3. Connect the OUT port on the first unit to the IN port of the second unit using the slave serial link cable (black plug) supplied in the PSU-232 or PSU-485 connection kit.

4. Connect all the remaining units in the same fashion until all the units have been daisy-chained together.

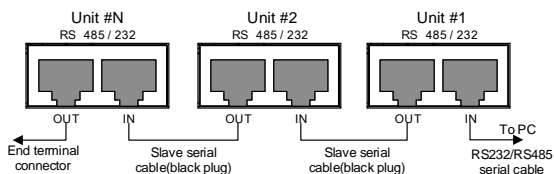

5. Terminate the OUT port of the last unit with the end terminal connector included in the PSU-232 or PSU-485 connection kit.
6. Press the Function key to enter the Page 117 Normal configuration settings for the master unit.

Set the following settings:

F-70 = 1 or 2	Configure the master unit as you normally would for RS232 or RS485 remote control, see page 173.
F-71 = 0~7	Set the baud rate (set all units the same). See page 173.
F-72 = 1	Set to 8 data bits.
F-73 = 0	Parity to none.
F-74 = 0	1 Stop bit.
F-75 = 1	Set the UART TCP to TDK (emulation mode).
F-76 = 00~30	Set the address of the master unit. It must be a unique address identifier.

7. Press the Function key to enter the Page 117 Normal configuration settings for the slave(s).

Set the following settings:

- F-70 = 2 Set the slave unit to RS485.
- F-71 = 0~7 Set the baud rate (make all units, including the master, the same baud). See page 173.
- F-72 = 1 Set to 8 data bits.
- F-73 = 0 Parity to none.
- F-74 = 0 1 Stop bit.
- F-75 = 1 Set the UART TCP to TDK (emulation mode).
- F-76 = 00~30 Set the address of each slave to a unique address identifier

8. Multiple units can now be operated at the same time. Only TDK GENESYS legacy commands can be used in this mode. See the programming manual or see the function check below for usage details.

Slave serial link cable with RJ-45 shielded connectors from PSU-232 or PSU-485 connection kit	RS-485 slave serial link pin assignment			
	8 Pin Connector (IN)		8 Pin Connector (OUT)	
	Pin No.	Name	Pin No.	Name
	Housing	Shield	Housing	Shield
	1	SG	1	SG
	6	TXD -	6	TXD -
	3	TXD +	3	TXD +
	5	RXD -	5	RXD -
	4	RXD +	4	RXD +

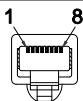

Multi-Drop mode

Operation

1. Check the F-89 (System version and build date) settings first on all units (see page 111). The two parameters O and P (Option Module) must be the same on all units before any multiple unit connection can be established.

Example: F-89 O:00, P:01.

2. All units must be powered down before starting the Multi-Drop mode configuration
3. Connect the first unit's LAN, USB or GPIB port to a PC.
4. Connect the OUT port on the first unit to the IN port of the second unit using the master serial link cable (gray plug) supplied in the PSU-232 or PSU-485 connection kit.
5. Connect all the remaining units between the OUT port and the IN port with the slave serial link cable (black plug) supplied in the PSU-232 or PSU-485 connection kit until all the desired units have been daisy-chained together.

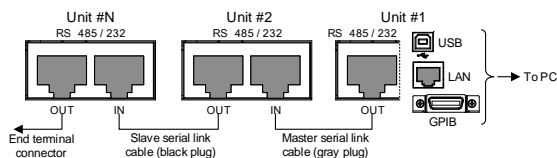

6. Terminate the OUT port of the last unit with the end terminal connector included in the PSU-232 or PSU-485 connection kit.
7. Power up all slave units.

8. Set the addresses of all slave units using the F-76 parameter.
F-76 = 00~30 Set the address of the unit. It must be a unique address identifier.
9. Set the Multi-Drop setting parameter (F-77) to Slave for all slave units.
F-77 = 2 Set the Multi-Drop setting to slave.
10. Power up the master unit.
11. Set the address of the master unit using the F-76 parameter.
F-76 = 00~30 Set the address of the unit. It must be a unique address identifier.
12. You can check the slaves' addresses by using the F-77 parameter on the master unit.
F-77 = 3 Display on each slave units the configured address. This can show if identical addresses have been assigned individually to each slave units.
13. Set the Multi-Drop setting parameter (F-77) to Master.
F-77 = 1 Set the Multi-Drop setting to master.
14. You can display the status of each slave unit by using the F-78 parameter.

F-78 = 0~30

Displayed parameter: AA-S
 AA: 00~30 (Address),
 S: 0~1 (Off-line/On-line status).

15. Multiple units can now be operated using SCPI commands. See the programming manual or see the function check below for usage details.

Slave serial link cable with RJ-45 shielded connectors from PSU-232 or PSU-485 connection kit	RS-485 slave serial link pin assignment			
	8 Pin Connector (IN)		8 Pin Connector (OUT)	
	Pin No.	Name	Pin No.	Name
	Housing	Shield	Housing	Shield
	1	SG	1	SG
	6	TXD -	6	TXD -
	3	TXD +	3	TXD +
Master serial link cable with RJ-45 shielded connectors from PSU-232 or PSU-485 connection kit	RS-485 master serial link pin assignment			
	8 Pin Connector (IN)		8 Pin Connector (OUT)	
	Pin No.	Name	Pin No.	Name
	Housing	Shield	Housing	Shield
	1	SG	1	SG
	6	TXD -	5	RXD -
	3	TXD +	4	RXD +
5	RXD -	6	TXD -	
4	RXD +	3	TXD +	

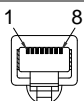

Multiple units Function Check

Functionality
check

Invoke a terminal application such as Realterm.

To check the COM port No, see the Device Manager in the PC. For WinXP; Control panel → System → Hardware tab.

Below shows examples using the Legacy Multi-Drop mode and the Multi-Drop mode.

Legacy Multi-Drop mode

When using the TDK GENESYS legacy commands, each unit can be individually controlled using the unique address identifiers. For this function check, we will assume that the master unit is assigned to address 8, while a slave is assigned address 11.

Run this query command via the terminal application after the instruments have been configured for multi-unit control with Legacy Multi-Drop mode. See page 177.

ADR 8
IDN?

The identity string for the Master unit will be returned:

GW-INSTEK,PSU40-38,,T0.01.12345678

Type the following:

ADR 11
IDN?

The identity string for the slave with address 11 will be returned:

GW-INSTEK,PSU40-38,,T0.01.12345678

Note: TDK commands do not use LF (line feed) codes to terminate commands. See the TDK GENESYS user manual for further information.

Multi-Drop mode

When using the Multi-Drop mode, the entire SCPI command list developed for the PSU can be used. Each unit can be individually controlled after a slave unit has been selected. For this function check, we will assume that the master unit is assigned to address 0, while a slave is assigned address 5.

Run this query command via the terminal application after the instruments have been configured for multi-unit control with Multi-Drop mode. See page 177.

INST:SEL 0

*IDN?

GW-INSTEK,PSU100-15,,T0.01.12345678

Selects the unit with address 0 and returns its identity string.

INST:SEL 5

*IDN?

GW-INSTEK,PSU150-10,,T0.01.12345678

Selects the unit with address 5 and returns its identity string.

INST:SEL 6

Selects the unit with address 6 (not configured in our example). An error is displayed on the master front panel.

INST:SEL 0

SYST:ERR?

Settings conflict

Query the system errors. "Settings conflict" is returned.

INST:STAT?
33,0

Returns the active units and master unit in the bus.

33=0b100001

The units at address 0 and address 5 are on-line.

0

Master device's address is 0.



Note

For further details, please see the programming manual, available on the GW Instek web site @ www.gwinstek.com.

Configure Ethernet Connection

The Ethernet interface can be configured for a number of different applications. Ethernet can be configured for basic remote control or monitoring using a web server or it can be configured as a socket server.

The PSU series supports both DHCP connections so the instrument can be automatically connected to an existing network or alternatively, network settings can be manually configured.

Ethernet configuration Parameters	For details on how to configure the Ethernet settings, please see the configuration chapter on page 108.
	MAC Address (display only) LAN Enable/Disable
	DHCP Enable/Disable IP Address
	Subnet Mask Gateway
	DNS Address Sockets Server Enable/Disable
	Web Server Enable/Disable Web Password Enable/Disable
	Web Enter Password

Web Server Configuration

Configuration This configuration example will configure the PSU as a web server and use DHCP to automatically assign an IP address to the PSU.

1. Connect an Ethernet cable from the network to the rear panel Ethernet port.

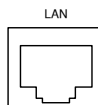

2. Press the Function key to enter the Page 117 Normal configuration settings.

Set the following LAN settings:

F-36 = 1	Turn LAN on
F-37 = 1	Enable DHCP
F-59 = 1	Turn the web server on
F-60 = 0 or 1	Set to 0 to disable web password, set to 1 to enable web password
F-61 = 0000 ~9999	Set the web password

3. The LAN indicator will turn on when a network cable is plugged in.

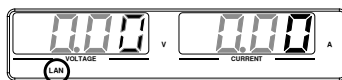

LAN indicator



Note

It may be necessary to cycle the power or refresh the web browser to connect to a network.

Web Server Remote Control Function Check

Functionality check

Enter the IP address of the power supply in a web browser after the instrument has been configured as a web server (page 186).

The web server allows you to monitor the function settings of the PSU.

You can check the IP address by checking F-39 to F-42.

F-39 = AAA	IP Address part 1 of 4
F-40 = BBB	IP Address part 2 of 4

F-41 = CCC IP Address part 3 of 4
 F-42 = DDD IP Address part 4 of 4

http:// AAA.BBB.CCC.DDD

The web browser interface appears.



[Visit Our Site](#)

[Support](#) | [Contact Us](#)

Welcome Page

Network Configuration

Analog Control

Figure of Dimensions

Operating Area

**PSU Series
Web Control Pages**

Thanks For Your Using.
Use the left menu to select the features you need.

More How-to
Please refer to user manual.



System Information

Manufacturer :	GW-INSTEK
Serial Number :	
Description :	GW-INSTEK.PSU12.5-120
Firmware Version :	T1.13.20170310
Hostname :	P-
IP Address :	172.16.23.146
Subnet Mask :	255.255.128.0
Gateway :	172.16.0.254
DNS :	172.16.1.252
MAC Address :	02:80:ad:20:31:b2
DHCP State :	ON
VISA TCP/IP Connect String :	TCPIP0:172.16.23.146:2268:SOCKET

Copyright 2011 © Good Will Instrument Co., Ltd. All Rights Reserved.

The web browser interface allows you to access the following:

- Network configuration settings
- Analog control pinouts & usage
- PSU dimensions
- Operating area diagram



Note

For further details, please see the programming manual, available on the GW Instek web site @ www.gwinstek.com.

Sockets Server Configuration

Configuration This configuration example will configure the PSU socket server.

The following configuration settings will manually assign the PSU an IP address and enable the socket server. The socket server port number is fixed at 2268.

1. Connect an Ethernet cable from the network to the rear panel Ethernet port.

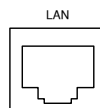

2. Press the Function key to enter the Normal configuration settings. Page 117

Set the following LAN settings:

F-36 = 1	Enable LAN
F-37 = 0	Disable DHCP
F-39 = 172	IP Address part 1 of 4
F-40 = 16	IP Address part 2 of 4
F-41 = 5	IP Address part 3 of 4
F-42 = 133	IP Address part 4 of 4
F-43 = 255	Subnet Mask part 1 of 4
F-44 = 255	Subnet Mask part 2 of 4
F-45 = 128	Subnet Mask part 3 of 4
F-46 = 0	Subnet Mask part 4 of 4
F-47 = 172	Gateway part 1 of 4
F-48 = 16	Gateway part 2 of 4
F-49 = 21	Gateway part 3 of 4
F-50 = 101	Gateway part 4 of 4
F-57 = 1	Enable Sockets

Socket Server Function Check

Background To test the socket server functionality, National Instruments Measurement and Automation Explorer can be used. This program is available on the NI website, www.ni.com, via a search for the VISA Run-time Engine page, or “downloads” at the following URL, <http://www.ni.com/visa/>

Requirements Operating System: Windows XP, 7, 8

Functionality check

1. Start the NI Measurement and Automation Explorer (MAX) program. Using Windows, press:

Start>All Programs>National Instruments>Measurement & Automation



2. From the Configuration panel access;

My System>Devices and Interfaces>Network Devices

3. Press *Add New Network Device>Visa TCP/IP Resource...*

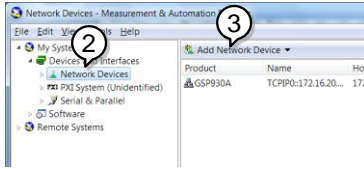

4. Select *Manual Entry of Raw Socket* from the popup window.

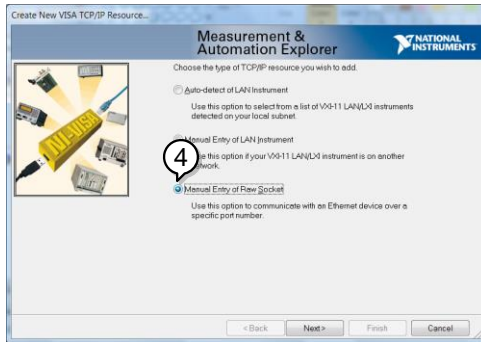

5. Enter the IP address and the port number of the PSU. The port number is fixed at 2268.
6. Click the Validate button.
7. A popup will appear if a connection is successfully established.
8. Click Next.

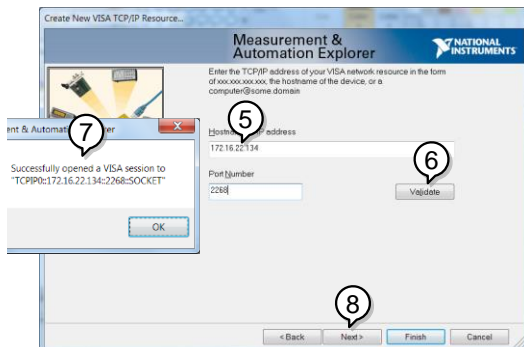

9. Next configure the Alias (name) of the PSU connection. In this example the Alias is: PSU_DC1

10. Click finish.

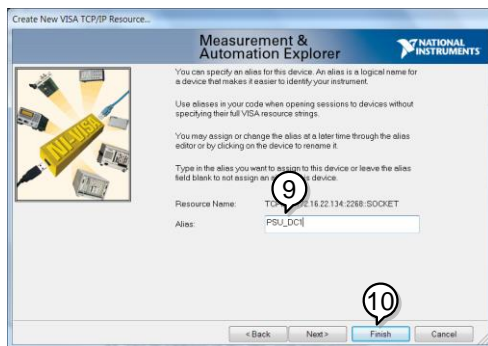

11. The IP address of the PSU will now appear under Network Devices in the configuration panel. Select this icon now.

12. Click *Open VISA Test Panel*.

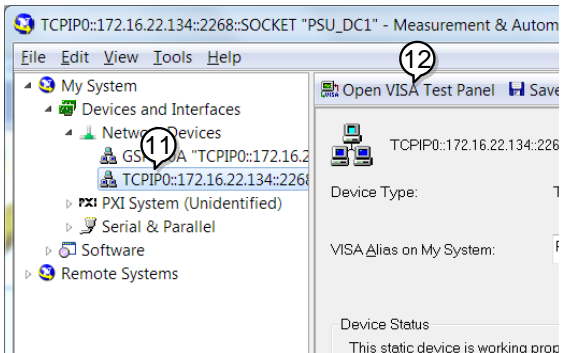

13. Click the *Configuration* icon,

14. Click on *I/O Settings*.

15. Make sure the *Enable Termination Character* check box is checked, and the terminal character is \n (Value: xA).

16. Click *Apply Changes*.

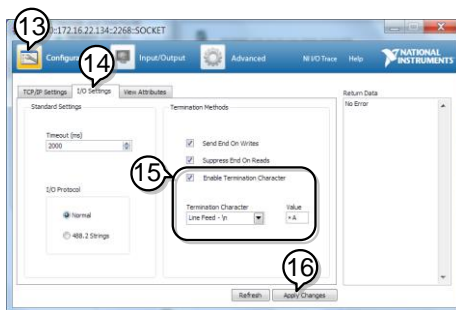

17. Click the *Input/Output* icon.

18. Enter *IDN? in the *Select or Enter Command* dialog box if it is not already.

19. Click the *Query* button.

- 20. The *IDN? query will return the Manufacturer, model name, serial number and firmware version in the dialog box.

GW-INSTEK,PSU40-38,TW123456,T0.02.20131205

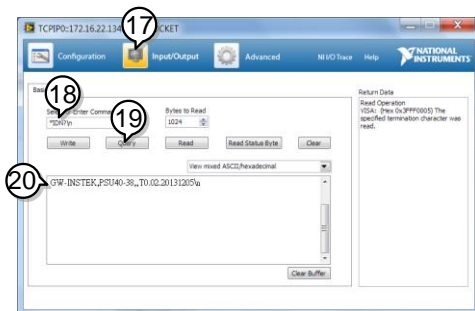

 Note

For further details, please see the programming manual, available on the GW Instek web site @ www.gwinstek.com.

F AQ

-
- How often should the power supply be calibrated?
 - The OVP voltage is triggered earlier than expected.
 - Can I combine more than 1 cable together for the output wiring?
 - The accuracy does not match the specification.

How often should the power supply be calibrated?

The PSU should be calibrated by an authorized service center at least every 2 years. For details regarding calibration, see your local dealer or GWInstek at www.gwinstek.com / marketing@goodwill.com.tw.

The OVP voltage is triggered earlier than expected.

When setting the OVP voltage, take into account the voltage drop from the load cables. As the OVP level is set from the output terminals and not the load terminals, the voltage at the load terminals may be slightly lower.

Can I combine more than 1 cable together for the output wiring?

Yes. Cables can be used together (in parallel) if the current capacity of a single cable is insufficient. However the withstand voltage should also be taken into account. Ensure the cables are twisted together and are the same length.

The accuracy does not match the specification.

Make sure the device is powered On for at least 30 minutes, within +20°C~+30°C. This is necessary to stabilize the unit to match the specification.

For more information, contact your local dealer or GWInstek at www.gwinstek.com / marketing@goodwill.com.tw.

A PPENDIX

PSU Factory Default Settings

The following default settings are the factory configuration settings for the power supply.

For details on how to return to the factory default settings, see page 48.

Initial Settings	Default Setting	
Output	Off	
LOCK	0 (Disabled)	
Voltage	0V	
Current	0A	
OVP	1.1 X Vrate	
OCP	1.1 X Irate	
Normal Function Settings	Setting	Default Setting
Output ON delay time	F-01	0.00s
Output OFF delay time	F-02	0.00s
V-I mode slew rate select	F-03	0 = CV high speed priority (CVHS)
Internal resistance setting	F-08	0.000Ω
Bleeder circuit control	F-09	1 = ON
Buzzer ON/OFF control	F-10	1 = ON
OCP Delay Time	F-12	0.1 sec
Current Setting Limit	F-13	0 = OFF
Voltage Setting Limit	F-14	0 = OFF
Display Memory parameter when recalling	F-15	0 = OFF
Auto Calibration Parallel Control	F-16	0 = Disable
Measurement Average Setting	F-17	0 = Low

Alarm Recovery and Output Status	F-18	0 = Safe Mode
Lock Mode	F-19	0:Lock Panel, Allow Output OFF
USB / GPIB setting	Setting	Default Setting
Setup Rear USB Speed	F-22	2 = Auto Detect Speed
GPIB address	F-23	8
GPIB Enable/Disable	F-24	1 = Enable GPIB
SCPI Emulation	F-26	0 = GW Instek
LAN setting	Setting	Default Setting
LAN Enable	F-36	1 = ON
DHCP	F-37	1 = ON
Socket Server Enable/Disable	F-57	1 = Enable
Web Server Enable/Disable	F-59	1 = Enable
Web Password Enable/Disable	F-60	1 = Enable
UART setting	Setting	Default Setting
UART Mode	F-70	1 = RS232
UART Baudrate	F-71	7 = 115200
UART Data Bits	F-72	1 = 8 bits
UART Parity	F-73	0 = None
UART Stop Bit	F-74	0 = 1 bit
UART TCP	F-75	0 = SCPI
UART Address	F-76	30
UART Multi-Drop control	F-77	0 = Disable
Power On Configuration setting	Setting	Default Setting
CV Control	F-90	0 = Power On Configuration
CC Control	F-91	0 = Control by local
Output Status when Power ON	F-92	0 = Safe Mode (Always OFF)
Master/Slave Configuration	F-93	0 = Independent
External Output Logic	F-94	0 = High ON
Monitor Voltage Select	F-96	0 = 5V
Control Range	F-97	0 = 5V[5kΩ]
External Output Control Function	F-98	0 = OFF

Trigger Input and Output Configuration Settings	Setting	Default Setting
Trigger Input Pulse Width	F100	0 = trigger controlled by trigger level.
Trigger Input Action	F102	0 = None
Output State When Receiving Trigger	F103	0 = OFF
Apply Voltage Setting on Trigger	F104	0 = 0V
Apply Current Setting on Trigger	F105	0 = 0A
Recall memory number	F106	1 = M1
Trigger Output Pulse Width	F120	0ms
Trigger Output Level	F121	0 = LOW
Trigger Source	F122	0 = None

Error Messages & Messages

The following error messages or messages may appear on the PSU screen during operation.

Error Messages	Description
OHP	Master & slave board over temperature protection in PSU
OHP1	Master board over temperature protection in PSU
OHP2	Slave board over temperature protection in PSU
ALM SENS	Sense Alarm
HW OVP	Hardware over voltage protection
AC	AC fail
OVP	Over voltage protection
OCP	Over current protection
FAN FAIL	Fan failure
SHUT DOWN	Force shutdown
Err 001	USB mass storage is not present
Err 002	No (such) file in USB mass storage
Err 003	Empty memory location
Err 004	File access error
Err 007	Slave occurs Off-line (Multi-Drop mode)

Normal Messages	Description
MSG 001	External control of output. Output off (F-94=0, High=on)
MSG 002	External control of output. Output off (F-94=1, Low=on)

Communication Interface Messages	Description
USB ON	Rear USB port connected to PC
USB OFF	Rear USB port disconnected from PC
MS ON	Mass storage plugged into front USB port
MS OFF	Mass storage removed from front USB port

LED ASCII Table Character Set

Use the following table to read the LED display messages.

0	1	2	3	4	5	6	7	8	9	A	B	C	D
0	1	2	3	4	5	6	7	8	9	A	b	C	d
E	F	G	H	I	J	K	L	M	N	O	P	Q	R
E	F	G	H	I	J	K	L	M	N	O	P	Q	R
S	T	U	V	W	X	Y	Z	()	+	-	,		
S	T	U	V	W	X	Y	Z	()	+	-	,		

PSU Specifications

The specifications apply when the PSU is powered on for at least 30 minutes.

Output

Model	PSU	6-200	12.5-120	20-76	40-38	60-25
Rated Output Voltage (*1)	V	6	12.5	20	40	60
Rated Output Current (*2)	A	200	120	76	38	25
Rated Output Power	W	1200	1500	1520	1520	1500

Model	PSU	100-15	150-10	300-5	400-3.8	600-2.6
Rated Output Voltage (*1)	V	100	150	300	400	600
Rated Output Current (*2)	A	15	10	5	3.8	2.6
Rated Output Power	W	1500	1500	1500	1520	1560

Constant Voltage Mode

Model	PSU	6-200	12.5-120	20-76	40-38	60-25
Line regulation (*3)	mV	2.6	3.25	4	6	8
Load regulation (*4)	mV	2.6	3.25	4	6	8
Ripple and noise (*5)	p-p (*6) mV	60	60	60	60	60
	r.m.s. (*7) mV	8	8	8	8	8
Temperature coefficient	ppm/ °C	100ppm/°C of rated output voltage, after a 30 minute warm-up.				
Remote sense compensation voltage (single wire)	V	1	1	1	2	3
Rise time (*8)	Rated load ms	80	80	80	80	80
	No load ms	80	80	80	80	80

Fall time (*9)	Rated load	ms	10	50	50	80	80
	No load	ms	500	700	800	1000	1100
Transient response time (*10)		ms	1.5	1	1	1	1

Model		PSU	100-15	150-10	300-5	400-3.8	600-2.6
Line regulation (*3)		mV	12	17	32	42	62
Load regulation (*4)		mV	12	17	32	42	62
Ripple and noise (*5)	p-p (*6)	mV	80	100	150	200	300
	r.m.s. (*7)	mV	8	10	25	40	60
Temperature coefficient		ppm/°C	100 ppm/°C of rated output voltage, after a 30 minute warm-up.				
Remote sense compensation voltage (single wire)		V	5	5	5	5	5
Rise time (*8)	Rated load	ms	150	150	150	200	250
	No load	ms	150	150	150	200	250
Fall time (*9)	Rated load	ms	150	150	150	200	250
	No load	ms	1500	2000	2500	3000	4000
Transient response time (*10)		ms	1	2	2	2	2

Constant Current Mode

Model		PSU	6-200	12.5-120	20-76	40-38	60-25
Line regulation (*3)		mA	22	14	9.6	5.8	4.5
Load regulation (*11)		mA	45	29	20.2	12.6	10
Ripple and noise (*12)	r.m.s.	mA	400	240	152	95	75
Temperature coefficient		ppm/°C	100ppm/°C of rated output current, after a 30 minute warm-up.				

Model	PSU	100-15	150-10	300-5	400-3.8	600-2.6
Line regulation (*3)	mA	3.5	3	2.5	2.38	2.26
Load regulation (*11)	mA	8	7	6	5.76	5.52
Ripple and noise (*12)	r.m.s. mA	45	35	25	17	12
Temperature coefficient	ppm/ °C	100 ppm/°C of rated output current, after a 30 minute warm-up.				

Protection Function

Model	PSU	6-200	12.5-120	20-76	40-38	60-25	
Over voltage protection (OVP)	Setting range	V	0.6 - 6.6	1.25 - 13.75	2 - 22	4 - 44	5 - 66
	Setting accuracy	V	0.06	0.125	0.2	0.4	0.6
Over current protection (OCP)	Setting range	A	5 - 220	5 - 132	5 - 83.6	3.8 - 41.8	2.5 - 27.5
	Setting accuracy	A	4	2.4	1.52	0.76	0.5
Under voltage limit (UVL)	Setting range		0 - 6.3	0 - 13.12	0 - 21	0 - 42	0 - 63

Model	PSU	100-15	150-10	300-5	400-3.8	600-2.6	
Over voltage protection (OVP)	Setting range	V	5 - 110	5 - 165	5 - 330	5 - 440	5 - 660
	Setting accuracy	V	1	1.5	3	4	6
Over current protection (OCP)	Setting range	A	1.5 - 16.5	1 - 11	0.5 - 5.5	0.38 - 4.18	0.26 - 2.86
	Setting accuracy	A	0.3	0.2	0.1	0.076	0.052
Under voltage limit (UVL)	Setting range		0 - 105	0 - 157.5	0 - 315	0 - 420	0 - 630

Model	PSU	All models
Over temperature protection (OHP)	Operation	Turn the output off.

Incorrect sensing connection protection (SENSE)	Operation	Turn the output off.
Low AC input protection (AC-FAIL)	Operation	Turn the output off.
Shutdown (SD)	Operation	Turn the output off.
Power limit (POWER LIMIT)	Operation	Over power limit.
	Value (fixed)	Approx. 105% of rated output power

Analog Programming and Monitoring

Model	PSU	All models
External voltage control output voltage		Accuracy and linearity: $\pm 0.5\%$ of rated output voltage.
External voltage control output current		Accuracy and linearity: $\pm 1\%$ of rated output current.
External resistor control output voltage		Accuracy and linearity: $\pm 1\%$ of rated output voltage.
External resistor control output current		Accuracy and linearity: $\pm 1.5\%$ of rated output current.
Output voltage monitor		Accuracy: $\pm 1\%$
Output current monitor		Accuracy: $\pm 1\%$
Shutdown control		Turns the output off with a LOW (0V to 0.5V) or short-circuit.
Output on/off control		Possible logic selections: Turn the output on using a LOW (0V to 0.5V) or short-circuit, turn the output off using a HIGH (4.5V to 5V) or open-circuit. Turn the output on using a HIGH (4.5V to 5V) or open-circuit, turn the output off using a LOW (0V to 0.5V) or short-circuit.
Alarm clear control		Clear alarms with a LOW (0V to 0.5V) or short-circuit.
CV/CC/ALM/PWR ON/OUT ON indicator		Photocoupler open collector output; Maximum voltage 30V, maximum sink current 8mA.
Trigger out		Maximum low level output = 0.8V; minimum high level output = 2V; Maximum source current = 8mA.
Trigger in		Maximum low level input voltage = 0.8V; minimum high level input voltage = 2.0V, Maximum sink current = 8mA.

Front Panel

Model		PSU	6-200	12.5-120	20-76	40-38	60-25
-------	--	-----	-------	----------	-------	-------	-------

Display, 4 digits

Voltage accuracy 0.1% + mV 12 25 40 80 120

Current accuracy 0.2% + mA 600 360 228 114 75

Model		PSU	100-15	150-10	300-5	400-3.8	600-2.6
-------	--	-----	--------	--------	-------	---------	---------

Display, 4 digits

Voltage accuracy 0.1% + mV 200 300 600 800 1200

Current accuracy 0.2% + mA 45 30 15 11.4 7.8

Model		PSU	All models				
-------	--	-----	------------	--	--	--	--

Indications

GREEN LED's: CV, CC, V, A, VSR, ISR, DLY, RMT, LAN, M1, M2, M3, RUN, Output ON

RED LED's: ALM, ERR

Buttons

Lock/Local(Unlock),
PROT(ALM_CLR), Function(M1),
Test(M2), Set(M3), Shift, Output

Knobs

Voltage, Current

USB port

Type A USB connector

Programming and Measurement (RS-232/485, USB, LAN, GPIB)

Model		PSU	6-200	12.5-120	20-76	40-38	60-25
-------	--	-----	-------	----------	-------	-------	-------

Output voltage programming accuracy 0.05% + mV 3 6.25 10 20 30

Output current programming accuracy 0.2% + mA 200 120 76 38 25

Output voltage programming resolution mV 0.2 0.4 0.7 1.3 2

Output current programming resolution mA 6 4 2.5 1.2 0.8

Output voltage measurement accuracy 0.1% + mV 6 12.5 20 40 60

Output current measurement accuracy	0.2% +	mA	400	240	152	76	50
Output voltage measurement resolution		mV	0.2	0.4	0.7	1.3	2
Output current measurement resolution		mA	6	4	2.5	1.2	0.8

Model		PSU	100-15	150-10	300-5	400-3.8	600-2.6
Output voltage programming accuracy	0.05% +	mV	50	75	150	200	300
Output current programming accuracy	0.2% +	mA	15	10	5	3.8	2.6
Output voltage programming resolution		mV	3.4	5.2	10.2	13.6	20.4
Output current programming resolution		mA	0.5	0.34	0.19	0.13	0.09
Output voltage measurement accuracy	0.1% +	mV	100	150	300	400	600
Output current measurement accuracy	0.2% +	mA	30	20	10	7.6	5.2
Output voltage measurement resolution		mV	3.4	5.2	10.2	13.6	20.4
Output current measurement resolution		mA	0.5	0.34	0.19	0.13	0.09

Input Characteristics

Model	PSU	All models
Norminal input rating		100Vac to 240Vac, 50Hz to 60Hz, single phase
Input voltage range		85Vac ~ 265Vac
Input frequency range		47Hz ~ 63Hz
Maximum input current	100Vac	A 21
	200Vac	A 11

Inrush current		Less than 50A.
Maximum input power	VA	2000
Power factor	100Vac	0.99
	200Vac	0.98

Model		PSU	6-200	12.5-120	20-76	40-38	60-25
Efficiency (*13)	100Vac	%	77	82	83	84	84
	200Vac	%	79	85	86	87	87

Model		PSU	100-15	150-10	300-5	400-3.8	600-2.6
Efficiency (*13)	100Vac	%	84	84	84	84	84
	200Vac	%	87	87	87	87	87

Model		PSU	All models
Hold-up time			20ms or greater

Interface Capabilities

Model		PSU	All models
USB			TypeA: Host, TypeB: Slave, Speed: 1.1/2.0, USB Class: CDC(Communications Device Class)
LAN			MAC Address, DNS IP Address, User Password, Gateway IP Address, Instrument IP Address, Subnet Mask
GPIB			SCPI - 1993, IEEE 488.2 compliant interface
RS-232/RS-485			Complies with EIA232D / EIA485 Specifications

Environment Conditions

Model		PSU	All models
Operating temperature			0°C to 50°C (*14)
Storage temperature			-25°C to 70°C
Operating humidity			20% to 85% RH; No condensation
Storage humidity			90% RH or less; No condensation
Altitude			Maximum 2000m

General Specifications

Model	PSU	All models
Weight	main unit only kg	Less than 8.7kg
Dimensions	(W×H×D) mm ³	423×43.6×447.2
Cooling		Forced air cooling by internal fan.
EMC		Complies with the European EMC directive 2004/108/EC for Class A test and measurement products.
Safety		Complies with the European Low Voltage Directive 2006/95/EC and carries the CE-marking.
Withstand voltage		AC to Chassis: 1500Vac/1min AC to Output terminal: 3000Vac/1min Output terminal to Chassis: Vout≤150V: 1000Vdc/1min 150V<Vout≤600V: 1500Vdc/1min
		Chassis and output terminal; chassis and AC input; AC input and output terminal: 100MΩ or more (DC 1000V)

Notes:

(*1) Minimum voltage is guaranteed to maximum 0.2% of the rated output voltage.

(*2) Minimum current is guaranteed to maximum 0.4% of the rated output current.

(*3) At 85 ~ 132Vac or 170 ~ 265Vac, constant load.

(*4) From No-load to Full-load, constant input voltage. Measured at the sensing point in Remote Sense.

(*5) Measure with JEITA RC-9131B (1:1) probe

(*6) Measurement frequency bandwidth is 10Hz to 20MHz.

(*7) Measurement frequency bandwidth is 5Hz to 1MHz.

(*8) From 10% to 90% of rated output voltage, with rated resistive load.

(*9) From 90% to 10% of rated output voltage, with rated resistive load.

(*10) Time for output voltage to recover within 0.5% of its rated output for a load change from 10 to 90% of its rated output current. Voltage set point from 10% to 100% of rated output.

(*11) For load voltage change, equal to the unit voltage rating, constant input voltage.

(*12) For 6V model the ripple is measured at 2 ~ 6V output voltage and full output current. For other models, the ripple is measured at 10 ~ 100% output voltage and full output current.

(*13) At rated output power.

(*14) If install the front panel filter kit, the temperature is guaranteed to 40°C.

PSU Dimensions

PSU 6-200, PSU 12.5-120, PSU 20-76, PSU 40-38, PSU 60-25

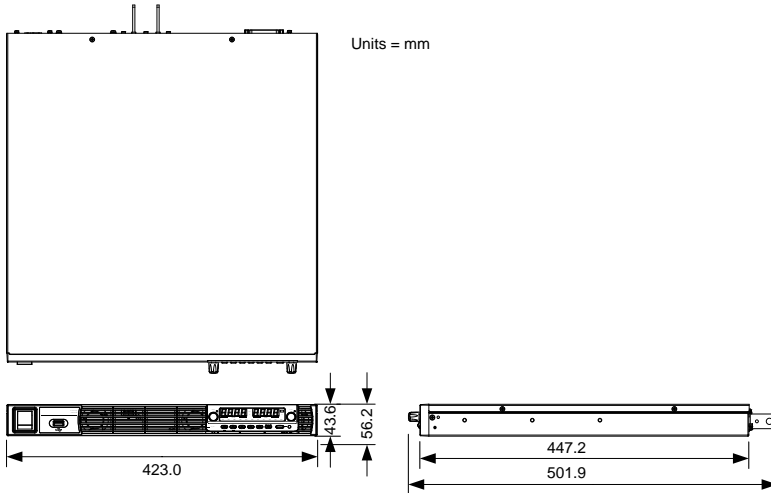

PSU 100-15, PSU 150-10, PSU 300-5, PSU 400-3.8, PSU 600-2.6

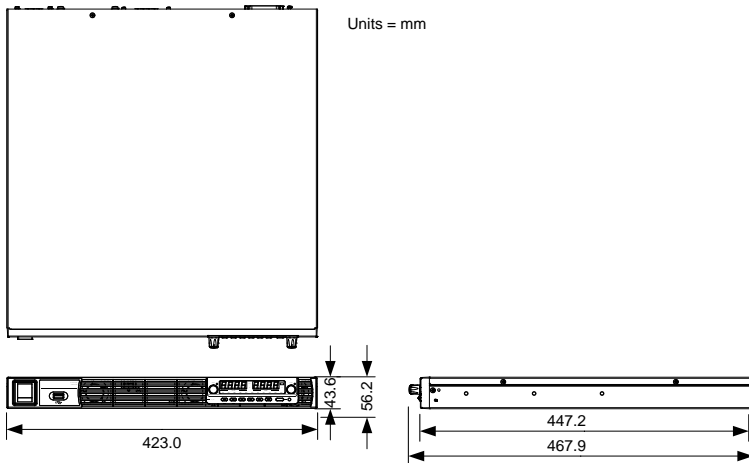

Declaration of Conformity

We

GOOD WILL INSTRUMENT CO., LTD.

declare that the below mentioned product

Type of Product: Programmable DC Power Supply

Model Number: PSU 6-200, PSU 12.5-120, PSU 20-76, PSU 40-38, PSU 60-25, PSU 100-15, PSU 150-10, PSU 300-5, PSU 400-3.8, PSU 600-2.6

are herewith confirmed to comply with the requirements set out in the Council Directive on the Approximation of the Law of Member States relating to EMC (2014/30/EU), LVD (2014/35/EU), WEEE (2012/19/EU) and RoHS (2011/65/EU).

For the evaluation regarding the Electromagnetic Compatibility and Low Voltage Directive, the following standards were applied:

© EMC	
EN 61326-1 : EN 61326-2-1:	Electrical equipment for measurement, control and laboratory use — EMC requirements (2013)
Conducted and Radiated Emissions EN 55011:2009+A1:2010	Electrical Fast Transients EN 61000-4-4:2012
Current Harmonic EN 61000-3-2:2014	Surge Immunity EN 61000-4-5: 2014
Voltage Fluctuation EN 61000-3-3:2013	Conducted Susceptibility EN 61000-4-6: 2014
Electrostatic Discharge EN 61000-4-2: 2009	Power Frequency Magnetic Field EN 61000-4-8:2010
Radiated Immunity EN 61000-4-3:2006+A1:2008+A2:2010	Voltage Dips/ Interrupts EN 61000-4-11: 2004
Low Voltage Equipment Directive 2014/35/EU	
Safety Requirements	EN 61010-1:2010 (Third Edition) EN 61010-2-030:2010 (First Edition)

GOODWILL INSTRUMENT CO., LTD.

No. 7-1, Jhongsing Road, Tucheng District, New Taipei City 236, Taiwan

Tel: [+886-2-2268-0389](tel:+886-2-2268-0389)

Fax: [+886-2-2268-0639](tel:+886-2-2268-0639)

Web: <http://www.gwinstek.com>

Email: marketing@goodwill.com.tw

GOODWILL INSTRUMENT (SUZHOU) CO., LTD.

No. 521, Zhujiang Road, Snd, Suzhou Jiangsu 215011, China

Tel: [+86-512-6661-7177](tel:+86-512-6661-7177)

Fax: [+86-512-6661-7277](tel:+86-512-6661-7277)

Web: <http://www.instek.com.cn>

Email: marketing@instek.com.cn

GOODWILL INSTRUMENT EURO B.V.

De Run 5427A, 5504DG Veldhoven, The Netherlands

Tel: [+31-\(0\)40-2557790](tel:+31-(0)40-2557790)

Fax: [+31-\(0\)40-2541194](tel:+31-(0)40-2541194)

Email: sales@gw-instek.eu

INDEX

Accessories	12	USB/GPIB settings	107
Alarm		Conventions	46
description	28	CV mode	
operation	28	operation.....	57
Analog connector		Declaration of conformity.....	211
pin assignment	123	Default settings	197
Analog control		reset	48
output control.....	136	Display diagram	18
overview.....	121	Display format	201
remote monitoring	141	Disposal instructions.....	7
resistance control - current		EN61010	
output	133	measurement category.....	6
resistance control - voltage		pollution degree.....	7
output	131	Environment	
shutdown control	139	safety instruction	7
status monitoring	144, 147	Error messages.....	200
voltage control - current output	129	Ethernet	
voltage control - voltage output	126	interface.....	186
ASCII table character set	201	sockets	189
Bleeder control		web server	186
description	26	FAQ	195
Build date		Front panel diagram.....	15
view	49	Ground	
Caution symbol	5	symbol.....	5
CC and CV mode		Grounding	33
description	24	How to use the instrument.....	46
CC mode		Internal resistance	
operation	60	description.....	27
Cleaning the instrument.....	7	Isolated analog control option	
Configuration		current control - current output	160
LAN settings.....	108	current control - voltage output	157
Normal function settings.....	104	current monitoring	162
normal function settings		overview	149
operation	117	pinout.....	151
overview.....	97	specifications	150
power on configuration operation	119	voltage control - current output	155
power on configuration settings.	112	voltage control - voltage output	152
script test settings.....	89	voltage monitoring	162
special function settings.	117	Line voltage connection	37
System settings	111	List of features.....	11
table.....	97		
test function settings	90		
UART settings.....	110		

Marketing	
contact.....	196
Messages.....	200
Model differences.....	10
OCP level.....	53
Operating area description.....	23
Operation considerations.....	30
floating output.....	33
inrush current.....	30
pulsed loads.....	30
reverse current.....	31
Optional accessories.....	12
Output terminal.....	42
cover.....	44
grounding.....	34
load cables.....	43
OVP level.....	53
Package contents.....	12
Panel lock.....	63
Parallel calibration.....	80
Parallel mode	
connection.....	75
operation.....	78
overview.....	72
Parallel operation.....	71
Power on/off	
safety instruction.....	6
Power sequence.....	39
Rack mount	
description.....	45
Rear panel diagram.....	20
Recall setup.....	64
Remote control.....	165
Ethernet configuration.....	186
Ethernet function check.....	187
GPIB configuration.....	168
GPIB function check.....	169
interface configuration.....	166
local bus configuration.....	177, 180
multi-unit configuration.....	177, 180
multi-unit function check.....	183
sockets configuration.....	189
sockets function check.....	190
UART configuration.....	173
UART function check.....	176
USB configuration.....	166
USB function check.....	167
Remote sense	
operation.....	67
Remote sense connector.....	65
Remote sense cover.....	66
Save setup.....	63
Series mode	
Operation.....	86
overview.....	82
Series operation.....	71
Service operation	
about disassembly.....	6
contact.....	196
Slew rate	
description.....	26
Socket server function check.....	190
Specifications.....	202
System version	
view.....	49
Test script	
Export.....	93
Load.....	91
overview.....	89
remove/delete test.....	94
Run.....	92
UK power cord.....	8
UVL level.....	53
Voltage sense	
operation.....	67
Warning symbol.....	5
Web server function check.....	187
Wire gauge chart.....	40