

JBC

www.jbctools.com

INSTRUCTION MANUAL



JNAU

High-Precision Hot Air Control Unit

This manual corresponds to the following references:

JNAU-9A (100V)

JNAU-1A (120V)

JNAU-2A (230V)

Packing List

The following items are included:



JNAU Control Unit (85V - 265V)1 unit

Power Cord 1 unit

Ref. 0024092 (100V)

0023715 (120V)

0023714 (230V)

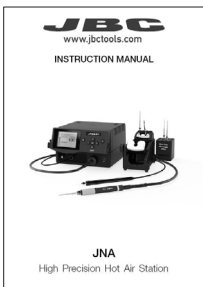

Manual1 unit

Ref. 0027994

Features and Connections

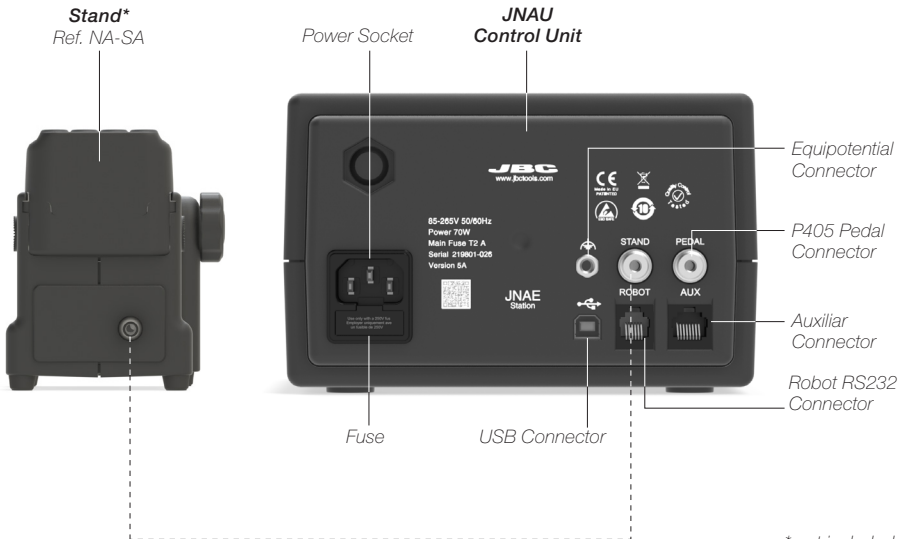
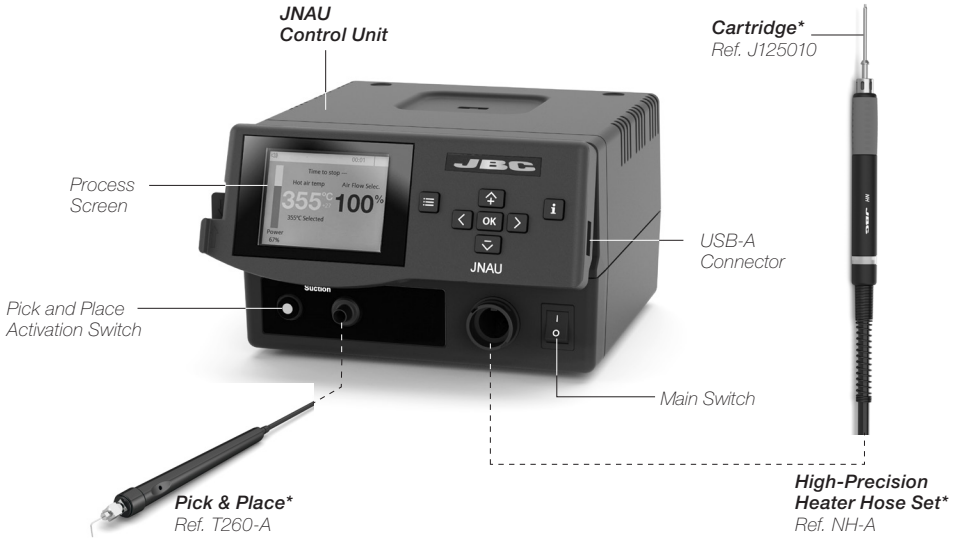

* not included

JNA Work Screen

JNA offers an **intuitive user interface** which provides **quick access** to station parameters. **Default PIN: 0105**

Menu Options



Set the station parameters

Station



Set the tool parameters

Tools



Display the hours worked in each cycle

Counters



It is possible to choose the language from a list.

Language



Allows you to carry out an overall station reset restoring all the parameters to their default values.

Reset

Troubleshooting

Station troubleshooting available on the product page at www.jbctools.com

Station Update



Update

Station Update

Download the JBC Update File from www.jbctools.com/software.html. Insert the USB flash drive with the downloaded file into the station.

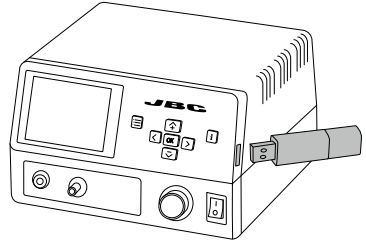

System Notifications

The following icons will be displayed on the screen's status bar.



USB flash drive is connected.



Station is controlled by a PC.



Station is controlled by a robot.



Station software update.
Press INFO to start the process.



Warning.
Press INFO for failure description.



Error.
Press INFO for failure description, the type of error and how to proceed.

Adjustable Stand* (Ref. NA-SA)

Adjust the tool holder angle to suit your work position.

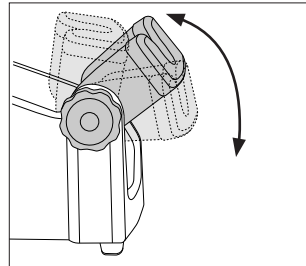

Operation

The tool starts/stops blowing when lifted/returned to the stand.

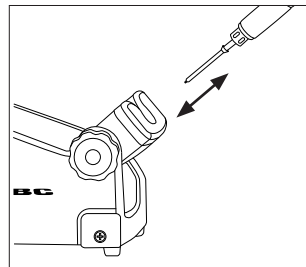

*not included

Changing Cartridge*

Save time and change the cartridge safely without switching the station off. **Note:** JBC offers a replacement cartridge Ref. J125010 with outlet diameters of 1mm.

1. Removing

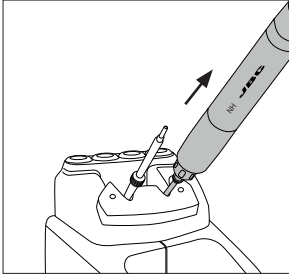

Place the cartridge in the extractor and pull the handle to remove it.

2. Inserting

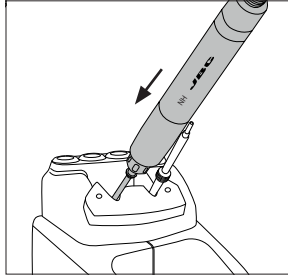

Place the handpiece on top of the new cartridge and press down slightly.

3. Fixing

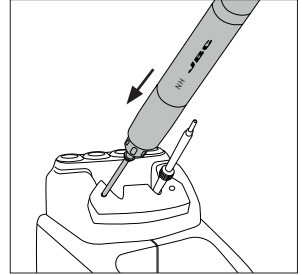

Use the holes to fix the cartridge.

*Important

It is essential to insert the cartridge as far as the mark for a proper connection.



Compatible Accessories*

Grips for NH High Precision Heater Hose Set (Grip Ref. 0024473)

Soft foam grips ensure a better manual control of the tool and greater comfort when working. Easily replace the grips for NH Heater Hose Set using the slip-on tabs.

1. Inserting Tabs

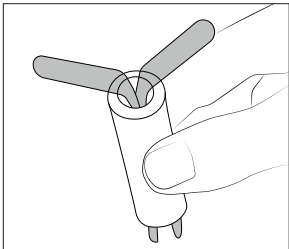

Insert the slide-on tabs into the new grip.

2. Inserting Handle

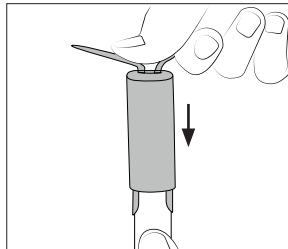

Push the grip with the tabs onto the handle.

3. Removing Tabs

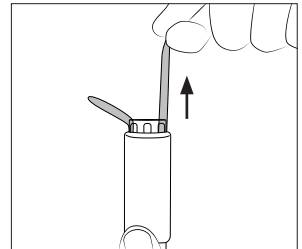

Hold the grip and pull them out. Use a pliers if necessary.

**not included*

Pick & Place*

This tool helps you place and remove SMDs of any size easily thanks to the suction pump.

Pick & Place
Ref. T260-A



Metallic Needles & Cup Set
Ref. 0026490

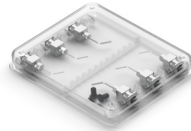

Set includes the following needles and cups (2 units of each reference):

- Ref. 0026637: 20G, 60°, Ø0.60 mm/0,0236 in
- Ref. 0026639: 30G, 60°, Ø0.159 mm/0.00626 in
- Ref. 0026638: 25G, 60°, Ø0.26 mm/0.01023 in
- Cup Ref. 0940112, used with needle Ref. 0026637

Operation

Choose the needle that best fits the component and the suction cup if needed and start as follows:

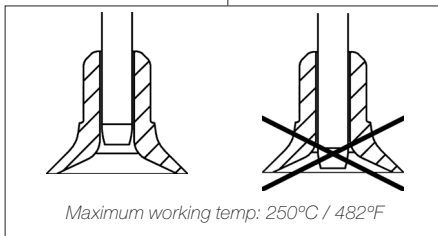
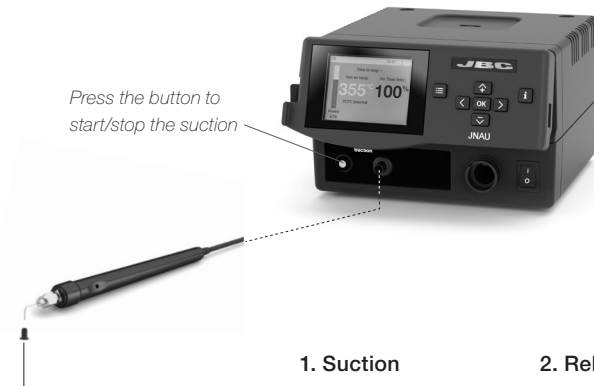

Insert the needle with the cup for a correct suction process.

Make sure the needle does not protrude from the cup.

1. Suction

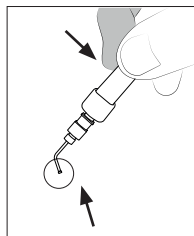

Once the suction is activated, cover the pen hole with your finger and lift off the component.

2. Release

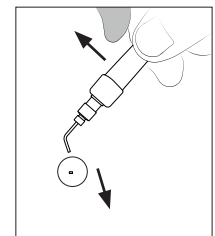

Lift your finger to release the component.

**not included*

Pedal* (Ref. P-405)

By means of the pedal connection NH Heater Hose Set (Ref. NH-A) for hot air function and the Pick & Place Tool (Ref. T260-A) for suction function could be activated and deactivated.

The pedal should be plugged in at the rear of the station into its connector, which is marked with "Pedal", to use the Pedal functionality.

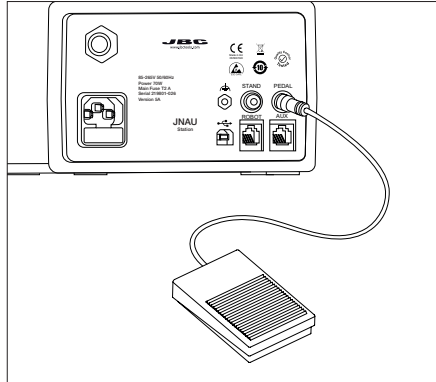

Pedal and Tool Settings

Start Mode

Select menu . Then by pressing  select "TOOL" and confirm with .

Select "PEDAL FUNCTION" and confirm with OK button. Then choose between "HOT AIR" and "SUCTION". Confirm again with OK button.

Pedal Activation Mode

In both applications, HOT AIR and SUCTION, are 2 different pedal activation modes available.

One Touch Mode

Press the pedal once to activate the function. Press again to stop the function.

Pressed Mode

Start the function by pressing the pedal continuously and stop the function by lifting the pedal. The function is active as long as the pedal is kept pressed.

Select "PEDAL" confirm with OK button and choose between "PRESS ONCE" and "PRESS CONT". Confirm again with OK button.

**not included*

Recommended

For rework jobs the use of the preheaters* is highly recommended. Find the preheater that best suits your soldering needs in www.jbctools.com.



Applying high temperatures (350 °C - 450 °C / 660 °F - 840° F) with a hot air tool for a long time can damage both, the printed circuit and the electronic components.

In addition, significant temperature differences between two points on a printed circuit board can damage the printed circuit and the electronic components due to the stresses generated by the different expansion of the material.

Preheating is a process that minimizes thermal stress and allows the soldering process to take no longer than it should.

For most rework processes JBC recommends a preheat temperature between 90 and 130 °C / 195 and 265 °F and not exceed a heating rate of 4 °C/s.

With the use of JBC preheaters, a homogeneous and controlled heating is achieved within the recommended parameters.

**not included*

Maintenance

Before carrying out maintenance, always switch the station off and disconnect it from the mains. Allow the equipment to cool down.

- Clean the station screen with a glass cleaner or a damp cloth.
- Use a damp cloth to clean the casing and the tool. Alcohol can only be used to clean the metal parts.
- Periodically check that the metal parts of the tool and stand are clean so that the station can detect the tool status.
- Periodically check all cables and tubes.
- Replace a blown fuse as follows:

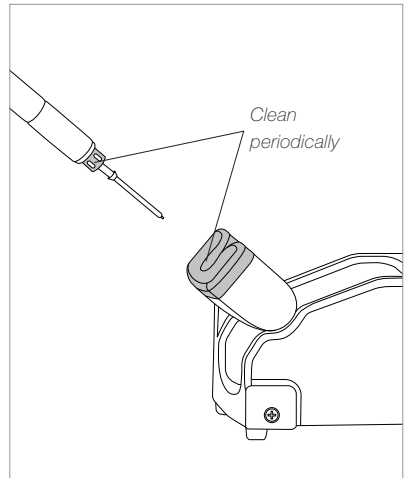

1. Pull off the fuse holder and remove the fuse. If necessary use a tool to lever it off.

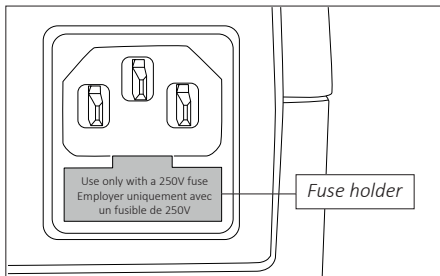

2. Insert the new fuse into the fuse holder and return it to the station.

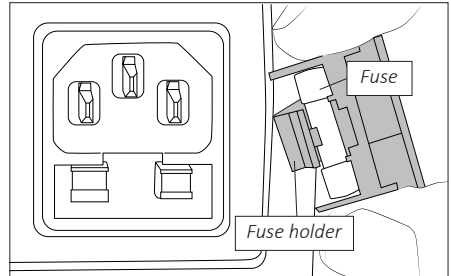

- Replace any defective or damaged pieces. Use original JBC spare parts only.
- Repairs should only be performed by a JBC authorized technical service.

Safety



It is imperative to follow safety guidelines to prevent electric shock, injury, fire or explosion.

- Do not use the units for any purpose other than soldering or rework. Incorrect use may cause fire.
- The power cord must be plugged into approved bases. Make sure that it is properly grounded before use. When unplugging it, hold the plug, not the wire.
- Do not work on electrically live parts.
- The tool should be placed in the stand when not in use to turn off the hot air.
- The soldering tip, the metal part of the tool and the stand may still be hot even when the station is turned off. Handle with care, including during the stand position adjustment.
- Do not leave the appliance unattended when it is on.
- Do not cover the ventilation grills. Heat can cause inflammable products to ignite.
- Avoid the contact of flux with skin or eyes to prevent irritation
- Be careful with the fumes produced when soldering.
- Keep your workplace clean and tidy. Wear appropriate protection glasses and gloves when working to avoid personal harm.
- Utmost care must be taken with liquid tin waste which can cause burns.
- This appliance can be used by children over the age of eight and also persons with reduced physical, sensory or mental capabilities or lack of experience provided that they have been given adequate supervision or instruction concerning use of the appliance and understand the hazards involved. Children must not play with the appliance.
- Maintenance must not be carried out by children unless supervised.

Specifications

JNAU

High-Precision Hot Air Control Unit

Ref.: **JNAU-9A** 100V 50/60Hz. Main fuse: T2A. Rated current 0.85A

Ref.: **JNAU-1A** 120V 50/60Hz. Main fuse: T2A. Rated current 0.85A

Ref.: **JNAU-2A** 230V 50/60Hz. Main fuse: T2A. Rated current 0.85A

- Temperature Selection: Room temp. / 150 - 450 °C / 300 - 840 °F
- Nominal Power: 70W
- Cool Mode: "Temp. off" is used to blow air at room temperature
- Ambient Operating Temp.: 10 - 50 °C / 50 - 122 °F
- Air Flow Regulation: 0.15 - 2.5 SLPM
- Vacuum: 53% / 397 mmHg / 15.6 inHg
- Connectors: USB-A / USB-B
RJ12 for RS232
Pedal / Stand
- Control Unit Dimensions/Weight: 180 x 170 x 110 mm / 2825 g
(L x W x H) 7.1 x 6.7 x 4.3 in / 2.96 lb
- Total Package Dimensions/Weight: 370 x 370 x 200 mm / 4200 g
(L x W x H) 14.6 x 14.6 x 7.9 in / 8.95 lb

Complies with CE standards.

ESD protected.

JBC

Warranty

JBC's 2 year warranty covers this equipment against all manufacturing defects, including the replacement of defective parts and labour.

Warranty does not cover product wear or misuse.

In order for the warranty to be valid, equipment must be returned, postage paid, to the dealer where it was purchased.

Get 1 extra year JBC warranty by registering here:
<https://www.jbctools.com/productregistration/>
within 30 days of purchase.



This product should not be thrown in the garbage.

In accordance with the European directive 2012/19/EU, electronic equipment at the end of its life must be collected and returned to an authorized recycling facility.



www.jbctools.com