

JBC

www.jbctools.com

INSTRUCTION MANUAL

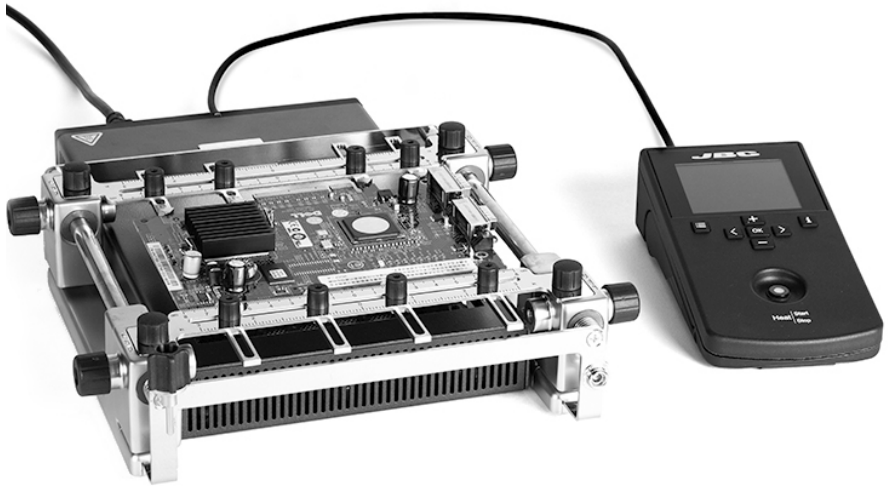

IR Preheater Set

Ref. PHSE-KA

Packing List

The following items should be included:

IR Preheater 1 unit
 Ref. PHSE-1A (120V)
 PHSE-2A (230V)
 PHSE-9A (100V)

RJ45 Cable 1 unit
 Ref. 0019914

Heater Unit

Console



IR Preheater Support 1 unit
 Ref. PHS-SA

Power Cord 1 unit
 Ref. 0009417 (100V/120V)
 0009401 (230V)

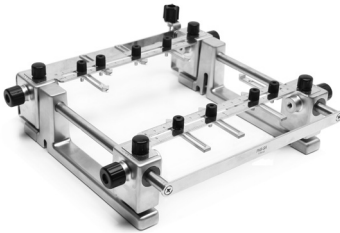

Kapton Tape 1 unit
 Ref. PH217

Thermocouple 1 unit
 Ref. PH218

Manual 1 unit
 Ref. 0021330

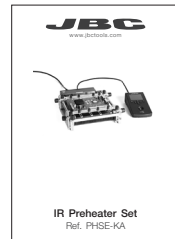

Features

Heater Unit

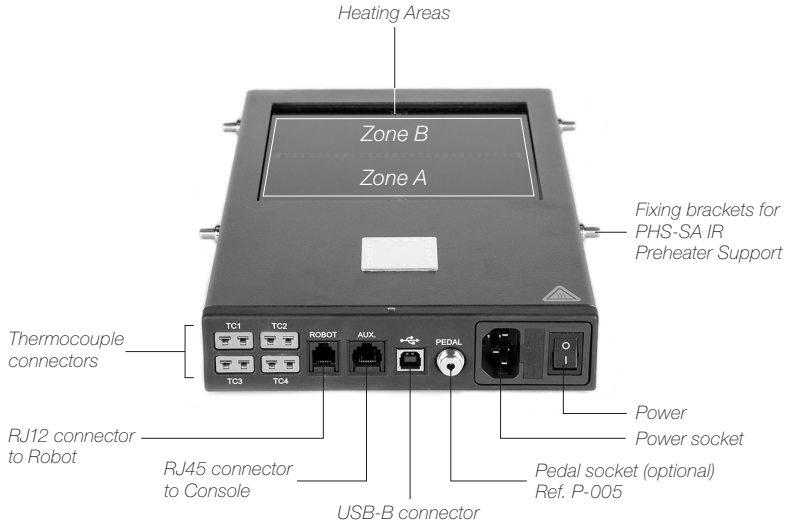

Console



PHS-SA Features

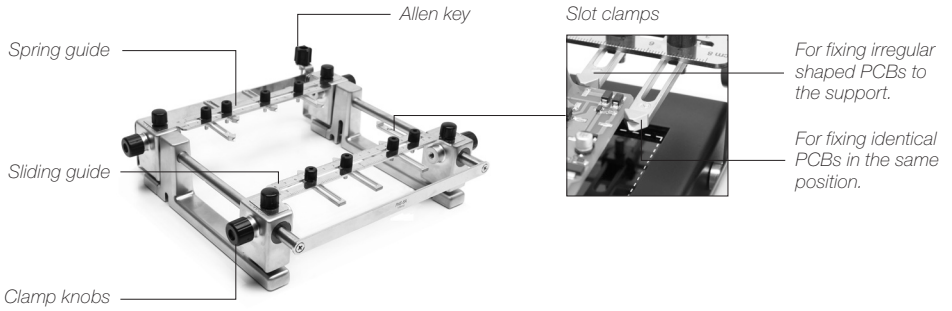

Height Adjustment

It allows adjustment for **3 heights** between the PCB and the Heating Area of the PHSE-A Heater Unit.

Remove these knobs for the low level if necessary

Low level
28mm

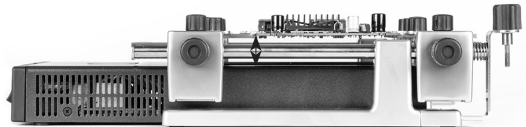

Medium level
50mm

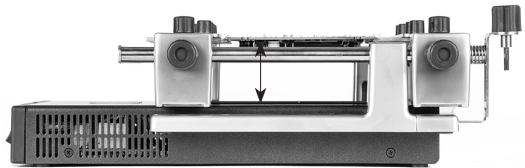

High level
70mm

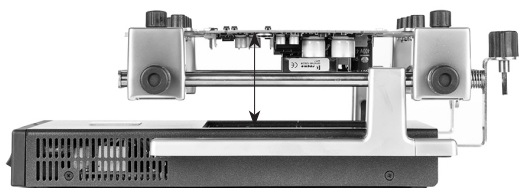

Changing PCBs of the same batch

The support lets you place PCBs of the same batch so as to always heat the same area. Use the sliding guides to change the PCBs.

Removing the PCB

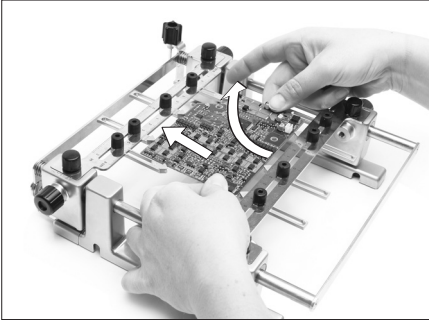

After loosening the SP guide knobs, push the PCB against the SP guide and lift out.

Placing another PCB

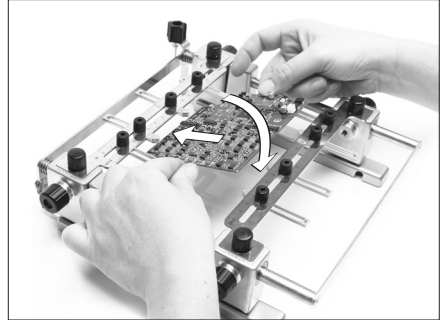

Push the PCB against the SP guide, position it and tighten the SP guide knobs.

Reworking large PCBs

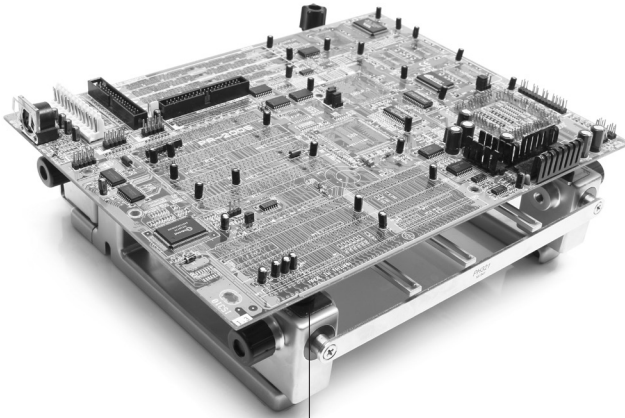

Place large PCBs on the 4 rubber caps



Temperature mode

Select *Temp. mode* from the *Work mode* menu. In this mode the heater unit maintains the selected temperature for the TC1 thermocouple as long as the other TCs do not reach the control/protection temperature limit.

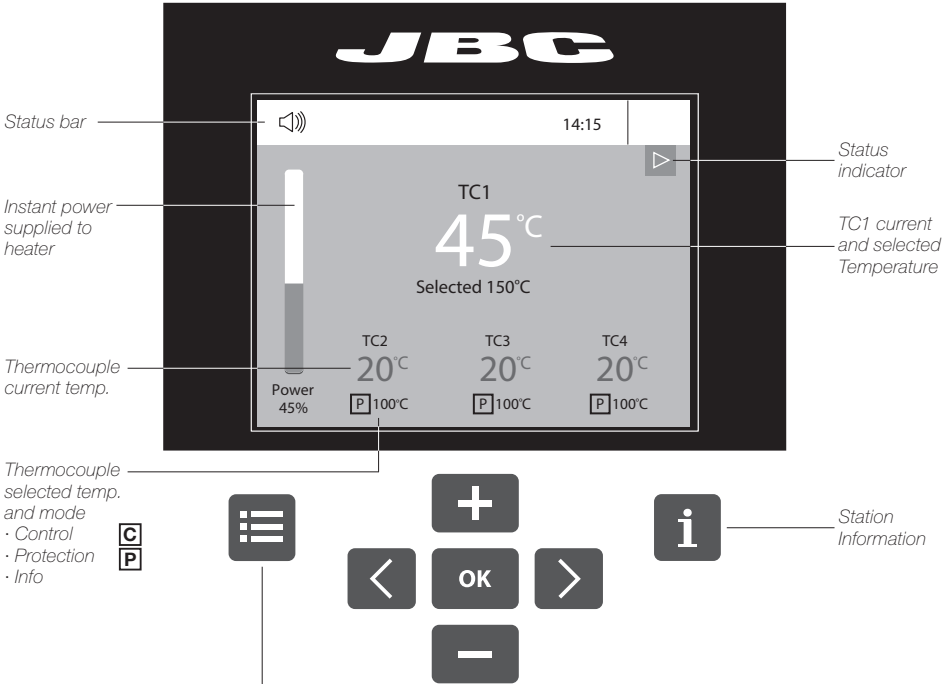

Menu Options

Press INFO for each parameter description.



General



Work mode



Profile editor



Graphics



Files



Reset

Available languages: English, Spanish, German, French, Italian, Portuguese, Japanese, Chinese, Russian and Korean.

***Original PIN: 0105**

System notifications (Status Bar)



USB flash drive is connected.



Station is controlled by a PC.



Station is controlled by a robot.



Station software update.
Press INFO to start the process.



Warning.
Press INFO for failure description.



Error. Press INFO for failure description, the type of error and how to proceed.

Power mode

Select *Power mode* from the *Work mode* menu. In this mode the heater unit maintains the selected power as long as the thermocouples do not reach the control/protection temperature limit.

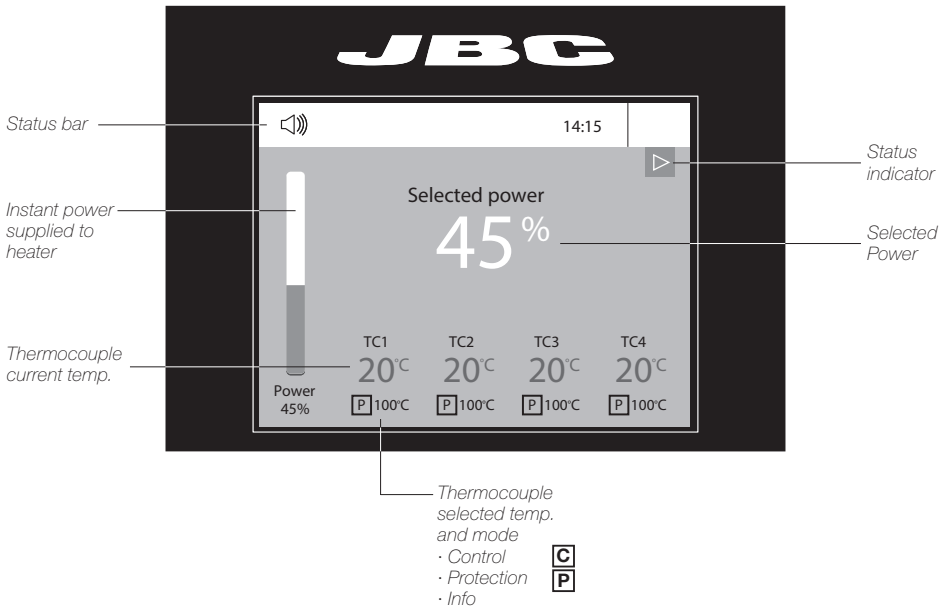

Thermocouples

Select *Thermocouples* from the *Work mode* menu to set them up. The thermocouples (TC) can work in three different ways depending on what is needed.

- Control: the unit maintains the selected temperature.
- Protection: the Heater Unit stops if the TC reaches the selected temperature.
- Info: the TC temperature is shown in the work screen.

The TC1 is always working in Control mode for the *Temperature* mode as well as for *Profiles* mode.

The temperature of each TC can also be selected from the work screen.

Profiles mode

Select *Profile mode* from the *Work mode* menu. In this mode the heater unit regulates the temperature of the TC1 thermocouple according to the selected profile as long as the other TCs do not reach the control/protection temperature limit.

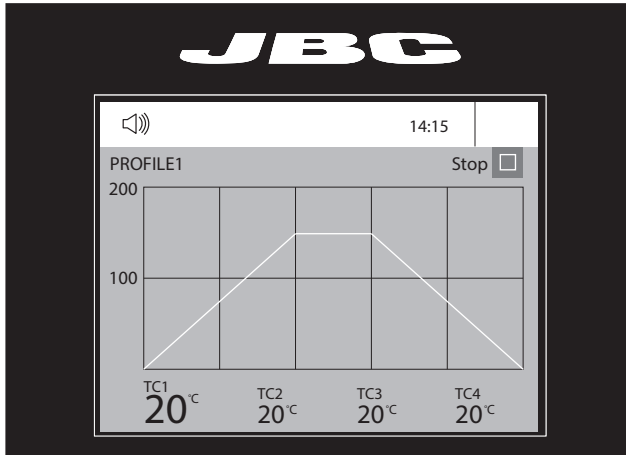

Teach profile

For repetitive jobs **we recommend** running profiles without the Thermocouple (TC). In order to do so, the *Teach profile* mode has to be executed before running any profile. It can be executed from the *Work mode* menu if the *Profiles mode* is selected. Once the profile has been run to the end, the system has all the process data which you can save.

Once it is saved, you can run this profile without connecting the Thermocouple (TC). The heating process will be the same as long as the same working conditions are respected.

The profiles which already have the data from the *Teach profile* are marked with this symbol 

These profiles can be run either with or without the Thermocouples. It can be chosen from the *Profiles mode* work screen:



Profile editor



The *Profile editor* can be opened from the main menu or from the *Profiles* mode work screen by pressing the 'OK' button.

In this mode you can **edit** as many as 25 profiles of temperature.

Profile editor

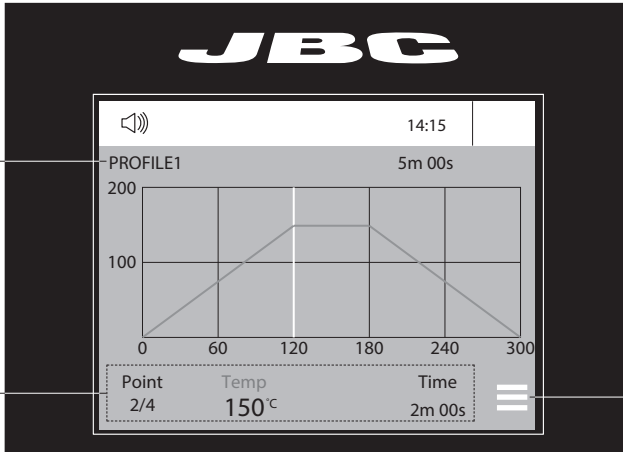

Profile name

Data for these points

Menu Options

- Add point
- Delete point
- Load profile
- Save profile
- Exit

JBC set profiles

There are 3 profiles predefined by JBC: A, B and C. The difference between them is the number of steps: 2, 3 or 4. The thicker your PCB is and the more layers it contains, the more steps are needed to obtain a gradual warming.

These profiles are not modifiable but can be used as a template to create your own profiles.

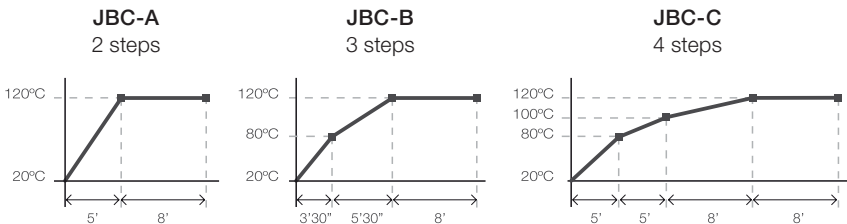

PCB reference specifications: FR4 1,6mm thick and 2 layers.

FR4 1,6mm thick and 6 layers.

FR4 2,2mm thick and 6 layers.

Profiles set using the low position of the PHS-SA Support (28 mm in height between the PCB and the heating area).

Process analysis



By pressing **Graphics** in the main MENU, temperature of TC1 thermocouple and power figures in real time are displayed.

Graphics

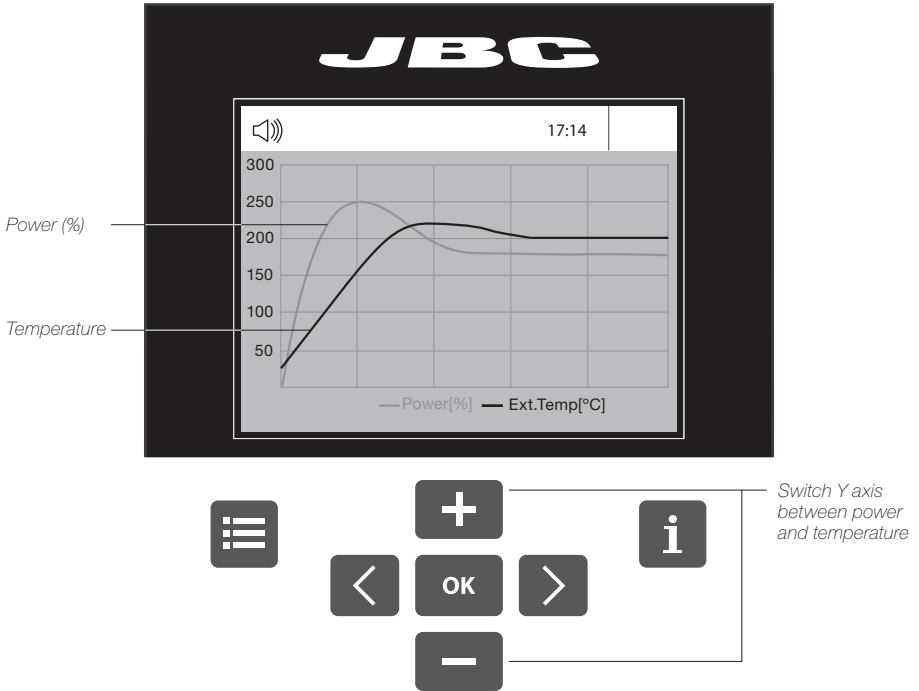

Files



Files

Export graphics

Insert a USB flash drive into the USB-A connector to save your soldering process in csv format.

Export / Import profiles

Insert a USB flash drive into the USB-A connector to export / import profiles.



Update the station software

1. Download the JBC Update File from www.jbctools.com/software.html and save it on a USB flash drive. (Preferably one with no other files).

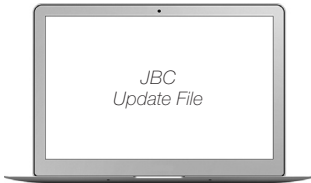

2. Insert the USB flash drive to the station. The icon  is displayed while updating.



Recommended Guidelines

1. Place the Thermocouple (TC) as near as possible to the component being worked on.

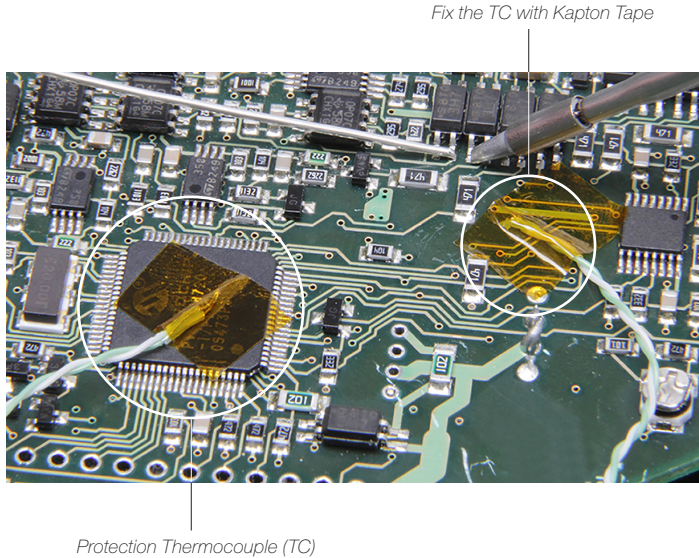

2. If there are any sensitive components, use a Thermocouple as protection.
You can select the protection temperature in the *Thermocouples* menu. If the selected temperature is reached, the Heater Unit will stop the process and a warning message will be shown.

3. IPC* does not recommend exceeding ramp-up rates over 3 - 4 °C / sec (5 - 7 °F / sec) so as to reduce the risk of thermal stress on the PCB.

** IPC was founded in the U.S. in 1957 as the Institute for Printed Circuits and is committed to becoming the most recognized international industry association for the electronics manufacturing industry.*

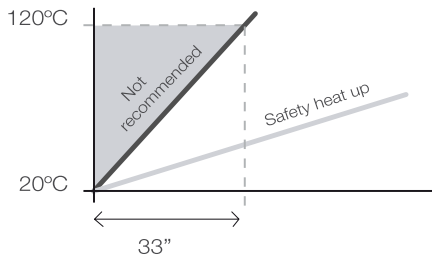

Maintenance

Before carrying out maintenance or storage, always allow the equipment and the support to cool.

- Check periodically that the PHSE-KA is clean.
- Use a damp cloth when cleaning. Alcohol can only be used to clean the metal parts.
- Only if it is absolutely necessary and if cleaning with isopropyl alcohol (IPA) is not enough, it is recommended to use a scraper to remove dirt in the glass area.
- Replace any defective or damaged parts. Use original JBC spare parts only.
- Repairs should only be performed by a JBC authorized technical service.



Clean periodically

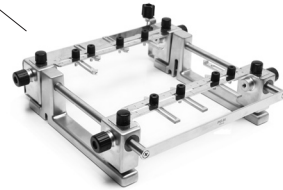

Safety



It is imperative to follow safety guidelines to protect health and prevent electric shock, injury, fire or explosions.

- Do not use the units for any purpose other than PCB preheating. Incorrect use may cause fire.
- The mains cable must be plugged into approved bases. Make sure that it is properly grounded before use. When unplugging it, hold the plug, not the wire.
- The temperature of accessible surfaces may remain high after the unit is turned off. Handle with care.
- Do not leave the appliance unattended when it is on.
- Do not cover the ventilation grills. Heat can cause inflammable products to ignite.
- Heat can cause inflammable products to ignite even when out of sight.
- Be careful with the remains of liquid tin. In contact with skin, it can cause burns.
- Avoid flux coming into contact with skin or eyes to prevent irritation.
- Be careful with the smoke produced when soldering.
- Keep your workplace clean and tidy. Wear appropriate protection glasses and gloves when working to avoid personal harm.
- This appliance can be used by children over the age of eight as well as persons with reduced physical, sensory or mental capabilities or lacking experience provided that they have been given adequate supervision or instruction concerning use of the appliance and understand the hazards involved. Children must not play with the appliance.
- Maintenance must not be carried out by children unless supervised.

Specifications

IR Preheater Set

PHSE-1KA / PHSE-2KA / PHSE-9KA

- Total weight: 4,8 kg (10.6 lb)
- Ambient operating temperature: 10 - 40 °C (50 - 104 °F)

PHSE-1A 120V. Input 120V 50/60Hz Fuse 8A

PHSE-2A 230V. Input 230V 50/60Hz Fuse 4A

PHSE-9A 100V. Input 100V 50/60Hz Fuse 8A

- Weight: 2,8 kg (6.2 lb)
- Dimensions (Heater Unit): 195 x 288 x 41,5 mm (7.68 x 11.34 x 1.63 in)
- Maximum Power: 500W
- Heating Area: 65 x 135 mm (2.56 x 5.31 in - 1 zone)
130 x 135 mm (5.12 x 5.31 in - 2 zones)
- Temperature Range: 50 - 250 °C (120 - 482 °F)
- Temperature Measurement: Thermocouple type K
- JBC set temperature profiles: 3 profiles (2, 3 or 4 steps)
- User Profiles: 20 (up to 6 steps for each)
- Maximum work time: 600 min or indefinite

PHS-SA

- Weight: 2 kg (4.4 lb)
- Dimensions (Low Position): 267 x 259 x 75 mm (10.5 x 10.2 x 3 in)
- Dimensions (High Position): 267 x 259 x 96 mm (10.5 x 10.2 x 3.8 in)

Complies with CE standards.
ESD protected housing.

Exploded View

PHSE-1KA 120V
PHSE-2KA 230V
PHSE-9KA 100V
IR PREHEATER SET

0020818 ()
0021209 ()
0021210 ()



PH217



PH218



0019914

230V)
(120 V)
(100 V)

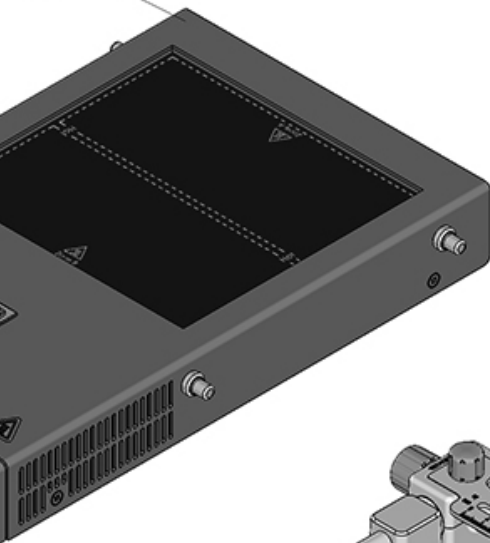
**SPARE PARTS****HEATER UNIT:**

-CIRCUIT (230V):	0021106
-CIRCUIT (120V):	0021110
-CIRCUIT (100V):	0021111
-LAMP (230V):	0016585
-LAMP (100V, 120V):	0016586
-GLASS:	0016609
-ENCLOSURES:	
· TOP	0021152
· BOTTOM	0022242

PHSE-1KA 120V FUSE T-8A
PHSE-2KA 230V FUSE T-4A
PHSE-9KA 100V FUSE T-8A

0013754

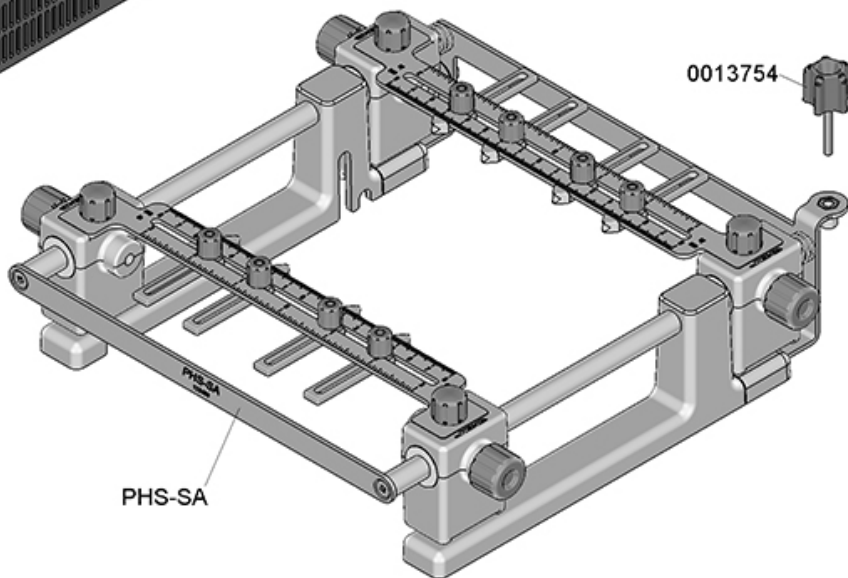

PHS-SA



Warranty

JBC's 2 year warranty covers this equipment against all manufacturing defects, including the replacement of defective parts and labour. Warranty does not cover product wear or misuse. In order for the warranty to be valid, equipment must be returned, postage paid, to the dealer where it was purchased. Please register your product warranty within 30 days of purchase in www.jbctools.com/productregistration.



This product should not be thrown in the garbage. In accordance with the European directive 2002/96/EC, electronic equipment at the end of its life must be collected and returned to an authorized recycling facility.



Manuals in other languages are available on our website

www.jbctools.com