

JBC

www.jbctools.com

INSTRUCTION MANUAL

	Page
English	2
Español	10



Desoldering Iron

Ref. DR560-A

Packing List

The following items should be included:

Desoldering Iron 1 unit
 Ref. DR560-A
C560003 already inserted



Tips 3 units
 Ref. C560005* (x1)
 Ref. C560013* (x1)
 Ref. C560004* (x1)



Union flanges 1 unidad
 Ref. 0011356



Tip cleaning set 1 unit
 Ref. 0965970*



Internal gasket 1 u.
 Ref. 0019208*
It contains 2 gaskets



Filter box 1 u.
 Ref. 0780840
It contains 10 filters



Spanner 1 unit
 Ref. 0780550*



Spiral Filter 1 u.
 Ref. 0812330*



Long tip cleaning set 1 u.
 Ref. 0965760*



Cleaning stick 1 u.
 Ref. 0786640



Metal Solder Collector 1 u.
 Ref. 0812630*



Glass Solder Collector 1 u.
 Ref. 0812620*



Manual 1 u.
 Ref. 0008867



*DR560-A Desoldering Iron accessories included in the Ref. 0010261

Connection

Desoldering Iron
Ref. DR560-A

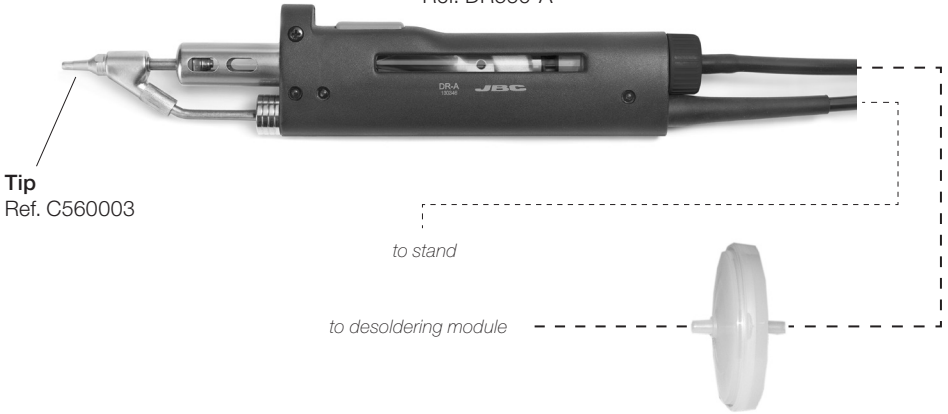

Suction Filter

Ref. 0821830

Supplied with desoldering module

Desoldering process

Use a tip with a larger diameter than the pad to achieve maximum aspiration and thermal efficiency.

1. Placing

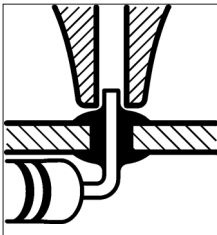

Place the tip with the component terminal in the hole.

2. Rotating

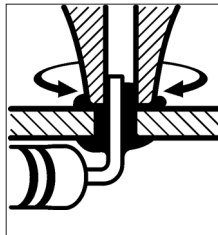

When the solder liquefies, gently rotate the tip so that the component terminal can be lifted off.

3. Aspirating

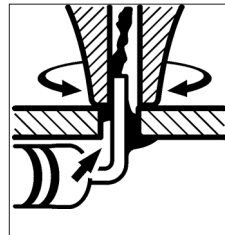

Press the vacuum pump button long enough to remove the solder.

After pressing the desoldering key there is a slight delay until the self-contained vacuum pump stops. This makes sure that the vacuum circuit is completely empty. If any solder remains on a terminal after desoldering it, resolder it with fresh solder and repeat the desoldering operation.

Changing Tips

This operation should be done while the tip is hot and at a minimum temperature of 250°C, so that any tin left inside is still molten.

1. Removing

Use the special spanner to unscrew the tip.

2. Inserting

Fit the new tip and tighten with the spanner to make sure it is air tight.

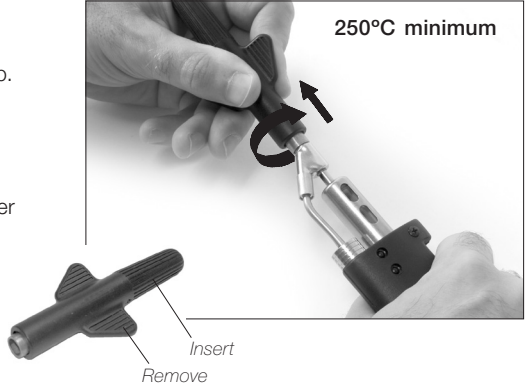

Compatible Tips

The DR560 uses C560 tips.

Find the model that best suits your soldering needs in www.jbctools.com

Here are some C560 tips in real size:

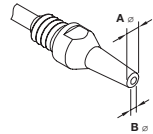

C560-001 A=1,4 B=0,6 max. pin=0,4 mm
(A=0.05 B= 0.02 max. pin= 0.01 in)

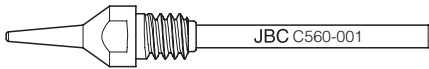

C560-002 A=1,8 B=0,8 max. pin=0,6 mm
(A=0.07 B= 0.03 max. pin= 0.02 in)

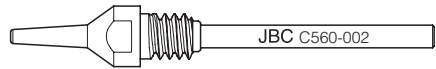

C560-014 A=2,5 B=0,8 max. pin=0,6 mm
(A=0.09 B= 0.03 max. pin= 0.02 in)



C560-003 A=2,7 B=1 max. pin=0,8 mm
(A=0.1 B= 0.04 max. pin= 0.03 in)

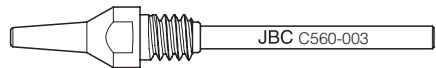

C560-004 A=3,2 B=1,3 max. pin=1,1 mm
(A=0.12 B= 0.05 max. pin= 0.04 in)

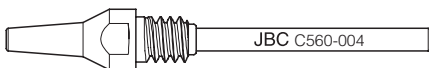

C560-009 A=5 B=1,3 max. pin=1,1 mm
(A=0.19 B= 0.05 max. pin= 0.04 in)

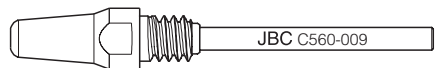

Changing the heating element (Ref. DSV-DR)

For this operation, turn off the station or disconnect the tool and wait until the tool temperature drops to room temperature.

1. Removing

Loosen the deposit lid (a), remove the screw (b) and withdraw the heating element (c).

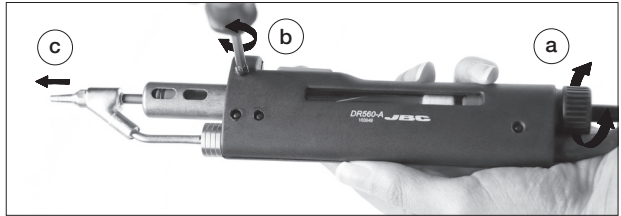

2. Placing

Insert the new Heating Element (a), tighten the screw (b) and then the lid (c).

⚠ Before placing, make sure to insert the internal gasket into the Glass Solder Collector.

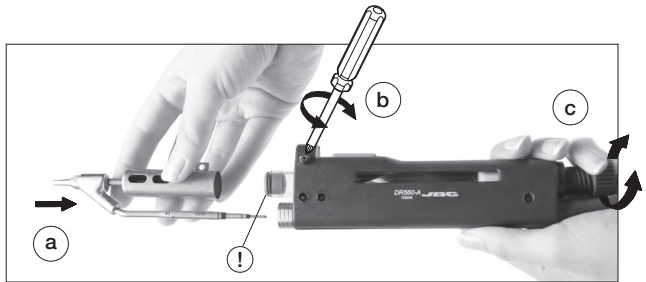

Important

For a proper connection it is essential to insert the cartridge by lining it up to the mark ▶▶.

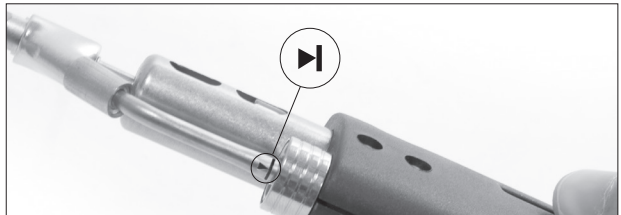

Compatibility

The DSV-DR also works with the previous version DR5600 Desoldering Iron (Ref. 5600010). In this case, you must take out the washer with a pliers.

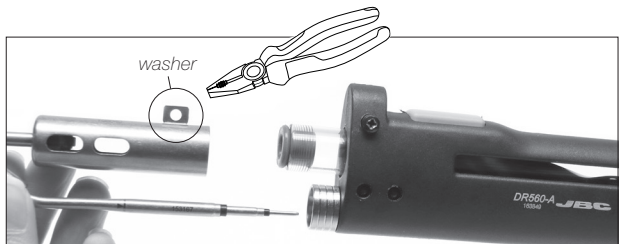

Glass Solder Collector Cleaning

1. Removing the lid



The lid must be unscrewed with the DR560 in a vertical position.

2. Cleaning

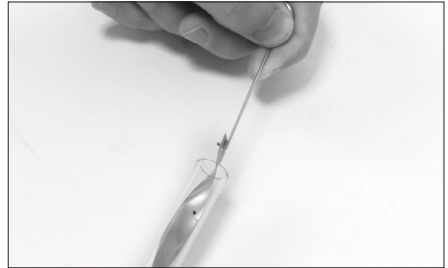

Remove the coil and clean the inside of the glass solder collector with the cleaning stick.

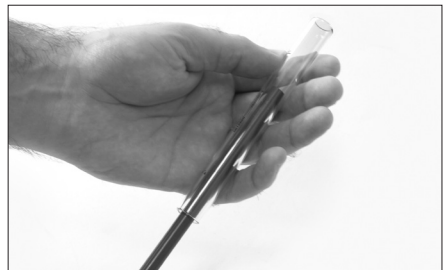

Check the filter and replace it if it is dirty or damaged.

3. Inserting the glass solder collector

The glass solder collector must be inserted with coil filter in place, positioned between the 2 lines marked.

Then the whole unit must be closed by screwing the lid.

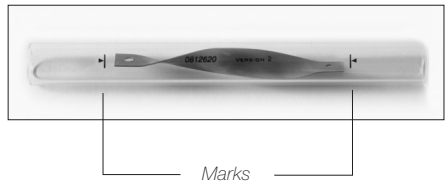

Tip Care

The intake tube should be periodically cleaned by the largest rod.

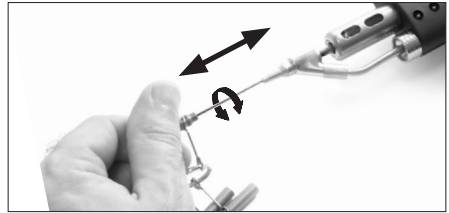
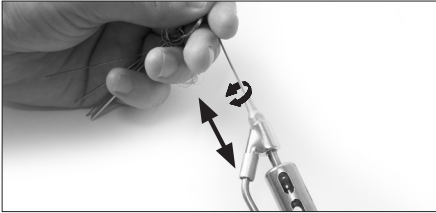

Important

DO NOT press the vacuum pump button while tinning the desoldering tip, as the fumes given off by the flux would quickly block the ducts and the air filter.

Maintenance

Before carrying out maintenance or storage, always unplug the tool.

- Check periodically that the metal parts are clean to ensure it is detected when on the stand.
Always use a damp cloth or alcohol.
- Periodically check all cables and tubes connections.
- Replace any defective or damaged pieces. Use original JBC spare parts only.
- Repairs should only be performed by a JBC authorized technical service.

Safety



It is imperative to follow safety guidelines to protect health and prevent electric shock, injury, fire or explosions.

- Do not use the tool for any purpose other than soldering or rework. Incorrect use may cause fire.
- The mains cable must be plugged into approved bases. Make sure that it is properly grounded before use. When unplugging it, hold the plug, not the wire.
- The temperature of accessible surfaces may remain high after the unit is turned off. Handle with care.
- Do not leave the appliance unattended when it is on.
- It is necessary to turn the station off before changing tips.
- Heat can cause inflammable products to ignite even when out of sight.
- Be careful with the remains of liquid tin. In contact with skin, it can cause burns.
- Avoid flux coming into contact with skin or eyes to prevent irritation.
- Be careful with the fumes produced when soldering.
- Keep your workplace clean and tidy. Wear appropriate protection glasses and gloves when working to avoid personal harm.
- This appliance can be used by children over the age of eight as well as persons with reduced physical, sensory or mental capabilities or lacking of experience provided that they have been given adequate supervision or instruction concerning use of the appliance and understand the hazards involved. Children must not play with the appliance.
- Maintenance must not be carried out by children unless supervised.

Specifications

- Weight: 413 g (0.91 lb)

Complies with CE standards.
ESD protected.

Composición

Los siguientes artículos deben estar incluidos:

Desoldering Iron

Desoldador 1 unidad
 Ref. DR560-A
Punta C560003 incluida



Tips

Puntas 3 unidades
 Ref. C560005* (x1)
 Ref. C560013* (x1)
 Ref. C560004* (x1)



Union flanges

Bridas de unión 1 unidad
 Ref. 0011356



Tip cleaning set

Juego de limpieza de puntas 1 unidad
 Ref. 0965970*



Internal gasket

Junta interna 1 u.
 Ref. 0019208*
Contiene 2 juntas



Filter box

Caja de filtros 1 u.
 Ref. 0780840
Contiene 10 filtros



Spanner

Llave para puntas .. 1 u.
 Ref. 0780550*



Spiral Filter

Filtro en espiral 1 u.
 Ref. 0812330*



Long tip cleaning set

Juego de limpieza de puntas 1 u.
 Ref. 0965760*



Cleaning stick

Bastoncillo de limpieza del depósito 1 u.
 Ref. 0786640



Metal Solder Collector

Depósito metálico de estaño 1 u.
 Ref. 0812630*



Glass Solder Collector

Depósito de estaño 1 u.
 Ref. 0812620*



Manual

Manual 1 u.
 Ref. 0008867



*Accesorios del desoldador DR560-A incluidos en la Ref. 0010261

Conexiones

Desoldador
Ref. DR560-A



Punta
Ref. C560003

al soporte

al módulo desoldador



Suction Filter

Ref. 0821830

Incluido en el módulo desoldador

Proceso de desoldar

Use un modelo de punta con un diámetro mayor que el pin a desoldar, a fin de lograr la máxima aspiración y eficiencia térmica.

1. Colocar

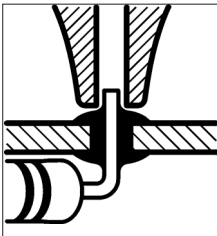

Apoye la punta de modo que el terminal penetre dentro del orificio de la punta.

2. Rotar

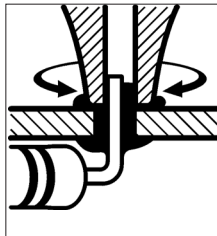

Cuando la soldadura se licúe, gire la punta hasta que la terminal del componente se pueda desprender de los lados.

3. Aspirar

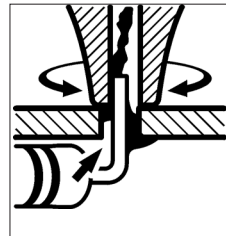

Presione el pulsador de la bomba de vacío el tiempo suficiente para aspirar la soldadura.

Después de cada pulsación del botón del desoldador hay un ligero retraso hasta que la bomba de vacío se detiene, esto es para asegurar que el circuito de aspiración se vacíe completamente. Si algún terminal ha quedado con restos de soldadura después de intentar desoldarlo, suéldelo de nuevo y repita la operación.

Cambio de puntas

Esta operación debe realizarse mientras que la punta está caliente, a una temperatura mínima de 250°C, para que los residuos de estaño que hayan quedado en el interior estén fundidos.

1. Remover

Desenrosque la punta a sustituir, con la ayuda de la llave suministrada.

2. Insertar

Coloque la nueva punta, y apriete con la llave para lograr una buena estanqueidad.

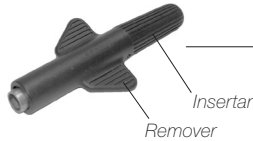

Puntas compatibles

El DR560-A funciona con puntas C560. Encuentre el modelo que mejor se adapte a sus necesidades en www.jbctools.com
 Vea algunas de ellas a escala real:

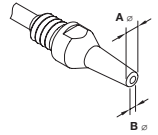

C560-001 A=1,4 B=0,6 max. pin=0,4 mm
 (A=0.05 B= 0.02 max. pin= 0.01 in)

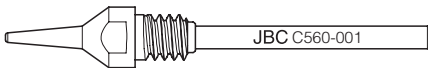

C560-002 A=1,8 B=0,8 max. pin=0,6 mm
 (A=0.07 B= 0.03 max. pin= 0.02 in)

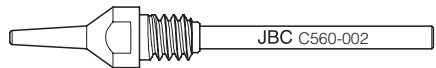

C560-014 A=2,5 B=0,8 max. pin=0,6 mm
 (A=0.09 B= 0.03 max. pin= 0.02 in)

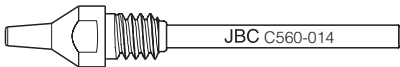

C560-003 A=2,7 B=1 max. pin=0,8 mm
 (A=0.1 B= 0.04 max. pin= 0.03 in)

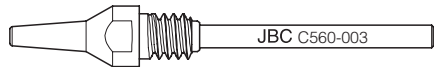

C560-004 A=3,2 B=1,3 max. pin=1,1 mm
 (A=0.12 B= 0.05 max. pin= 0.04 in)

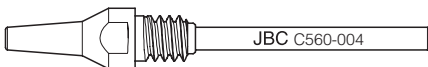

C560-009 A=5 B=1,3 max. pin=1,1 mm
 (A=0.19 B= 0.05 max. pin= 0.04 in)

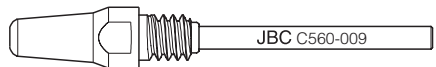

Cambio del elemento calefactor (Ref. DSV-DR)

Para realizar esta operación debe apagar la estación o desconectar la herramienta y esperar que la punta esté a temperatura ambiente.

1. Retirar

Desenrosque el tapón del depósito (a), retire el tornillo (b) y extraiga el elemento calefactor (c).



2. Colocar

Desenrosque el tapón del depósito (a), retire el tornillo (b) y extraiga el elemento calefactor (c).

⚠ Antes de colocar el depósito, asegúrese que la junta interna esté colocada.

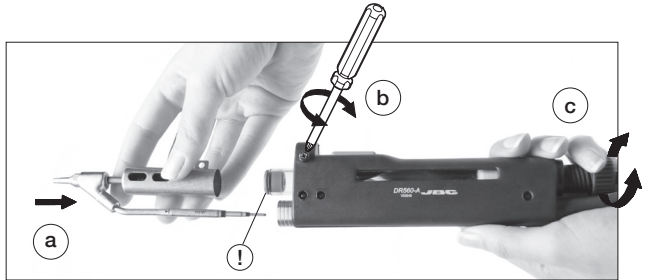

Importante

Para una buena conexión, es imprescindible introducir el cartucho hasta la marca ►.

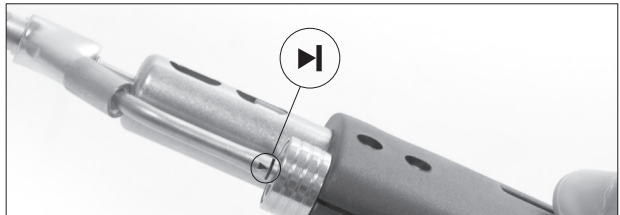

Compatibility

El DSV-DR también es compatible con el desoldador DR5600 (Ref. 5600010). En este caso debe retirar la pestaña con la ayuda de unos alicates.

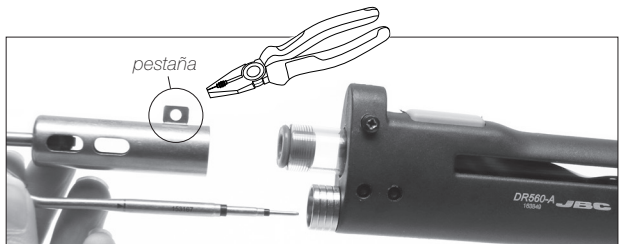

Limpieza del depósito de estaño

1. Retirar la tapa



Desenrosque el tapón y retire el depósito con el desoldador en posición vertical.

2. Limpiar

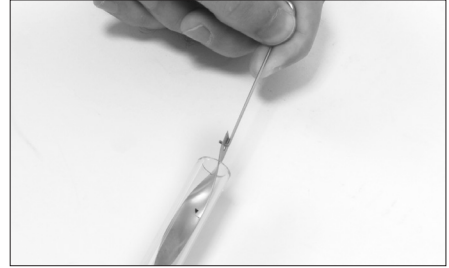

Extraiga el filtro y la espiral, limpie el interior con una baqueta.



En caso de que el filtro estuviera dañado, sucio o degradado, debe cambiarlo.

3. Insertar el depósito

Vuelva a poner en el depósito el filtro y la espiral. Para el correcto funcionamiento del desoldador, debe posicionar la espiral entre las dos líneas marcadas en el depósito.

Finalmente, cierre el conjunto enroscando el tapón.

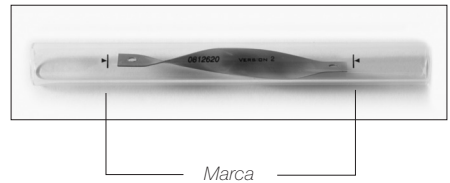

Cuidado de las puntas

Introducir periódicamente la baqueta más larga con el fin de limpiar el tubo de aspiración.

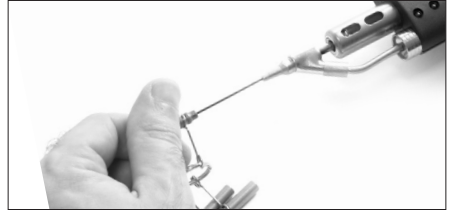
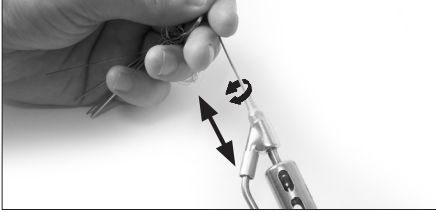

Importante: NO presione el botón de la herramienta mientras se estaña la punta, ya que los gases producidos podrían manchar rápidamente los conductos y el filtro.

Mantenimiento

Antes de almacenar o de su mantenimiento, desconecte siempre la herramienta.

- Compruebe periódicamente que las partes metálicas de la herramienta estén limpias de modo que la estación pueda detectar su estado y activar los modos de Sleep o Hibernation.
- Revise la conexión de cables y/o tubos.
- Cambie cualquier pieza defectuosa o dañada. Utilice solamente recambios originales de JBC.
- Cualquier reparación sólo podrá ser realizada por un servicio técnico oficial JBC.

Seguridad



Es necesario cumplir estas normas de seguridad para prevenir cualquier choque eléctrico, heridas, fuego o explosiones.

- No utilice el equipo para otros fines que no sea la soldadura o reparación. Un uso incorrecto podría causar fuego.
- Es posible que la temperatura de las zonas accesibles se mantenga alta después de apagar la unidad de control. Maneje con precaución.
- No deje el aparato desatendido cuando esté en funcionamiento.
- Es necesario apagar la estación antes de realizar un cambio de punta.
- El calor puede provocar que incluso los productos inflamables fuera de vista se prendan.
- Tenga cuidado con los restos de estaño líquido.
En contacto con la piel, pueden causar quemaduras.
- Evite el contacto del Flux con la piel o los ojos para prevenir la irritación.
- Tenga precaución con el humo producido al trabajar.
- Mantenga su lugar de trabajo limpio y ordenado. Use gafas y guantes de protección adecuados. Así evitará cualquier daño.
- Este aparato puede ser utilizado por personas a partir de 8 años y también por aquellas personas con movilidad reducida o capacidades físicas, sensoriales o mentales limitadas o con falta de experiencia y conocimientos siempre y cuando reciban supervisión o instrucciones relativas al uso del aparato de una manera segura y entiendan los riesgos que implica. Los niños no deben jugar con el aparato.
- Los niños no deberán realizar tareas de mantenimiento sin supervisión.

Especificaciones

- Peso: 413 g (0.91 lb)

Cumple con las normativas CE.
Seguridad ESD.

Exploded View · Despiece

Ref: **DR560-A** **Desoldering Iron**

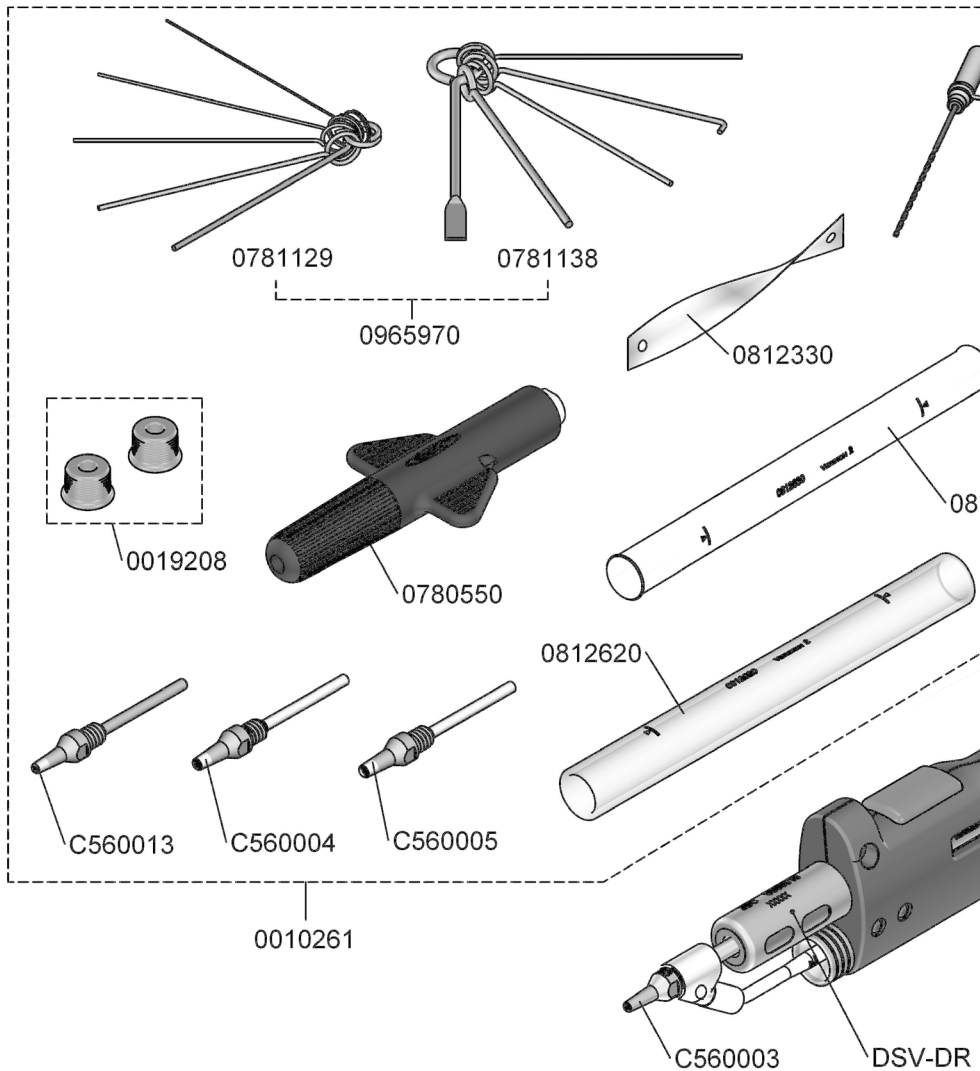

SPARE PARTS

DR560-A:

-TIP	C560003
-HEATING ELEMENT	DSV-DR
-FILTER BOX	0780840
-CLEANING STICK	0786640
-FLANGES	0011356
-ACCESSORIES	0010261
·TIP	C560013
·TIP	C560004
·TIP	C560005
·TIP CLEANING SET	0965970
·INTERNAL GASKET	0019208
·SPANNER	0780550
·LONG TIP CLEANING SET	0965760
·METAL TIN DIPOSIT	0812630
·TIN DIPOSIT	0812620
·SPIRAL FILTER	0812330

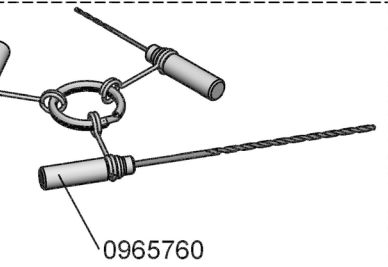

12630

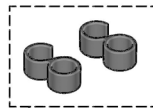
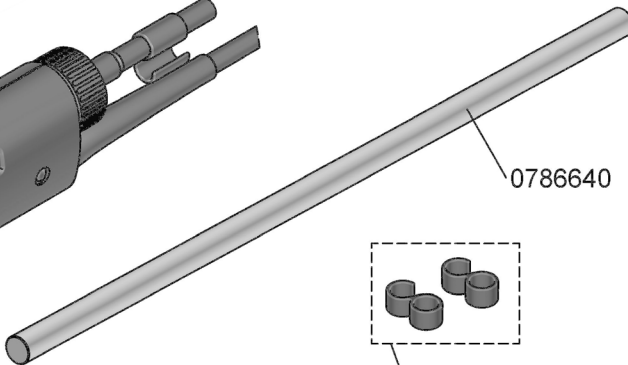
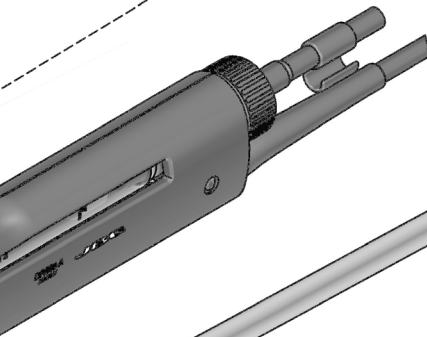

Warranty

JBC's 2 year warranty covers this equipment against all manufacturing defects, including the replacement of defective parts and labour. Warranty does not cover product wear or misuse. In order for the warranty to be valid, equipment must be returned, postage paid, to the dealer where it was purchased. Please register your warranty within 30 days of purchase in www.jbctools.com/productregistration.

Garantía

Esta garantía de 2 años cubre este equipo contra cualquier defecto de fabricación, incluyendo la sustitución de partes defectuosas y mano de obra. La garantía no cubre el desgaste del producto por uso o mal uso. Para que esta garantía sea válida, el equipo debe ser devuelto, a portes pagados, al distribuidor donde se compró. Registre la garantía de su producto dentro de los 30 días de la compra en www.jbctools.com/productregistration.



This product should not be thrown in the garbage.
In accordance with the European directive 2012/19/EU, electronic equipment at the end of their life must be collected and returned to an authorized recycling facility.

Este producto no debe desecharse en la basura.
De acuerdo a la directiva europea 2012/19/UE, los equipos electrónicos al final de su vida se deberán recoger y trasladar a una planta de reciclaje autorizada.