



**C560 Tips** range  
for **DR560** Desoldering Iron

Ref.	Cartridge & Tip description	Image	Suggested components	Tip dimensions	Connectables
<b>C560-001</b>	Desoldering Tip Ø0,6 HT		Through hole Desoldering	Ø0,6	Control Units: DI, DDE, DME Tool: DR560 Modules: MVE / MSE (Pump)
<b>C560-002</b>	Desoldering Tip Ø0,8 HT		Through hole Desoldering	Ø0,8	Control Units: DI, DDE, DME Tool: DR560 Modules: MVE / MSE (Pump)
<b>C560-014</b>	Desoldering Tip Ø0,8		Through hole Desoldering	Ø0,8	Control Units: DI, DDE, DME Tool: DR560 Modules: MVE / MSE (Pump)
<b>C560-003</b>	Desoldering Tip Ø1		Through hole Desoldering	Ø1	Control Units: DI, DDE, DME Tool: DR560 Modules: MVE / MSE (Pump)
<b>C560-017</b>	Desoldering Tip Ø1,1		Through hole Desoldering	Ø1,1	Control Units: DI, DDE, DME Tool: DR560 Modules: MVE / MSE (Pump)
<b>C560-004</b>	Desoldering Tip Ø1,3		Through hole Desoldering	Ø1,3	Control Units: DI, DDE, DME Tool: DR560 Modules: MVE / MSE (Pump)

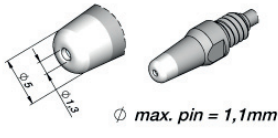
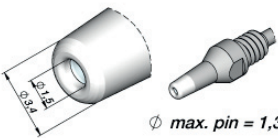
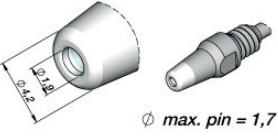
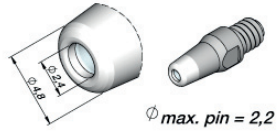
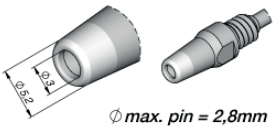
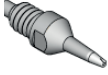
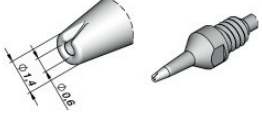
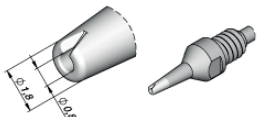

**C560** Tips for **DR560** Desoldering Iron

	Ref.	Cartridge & Tip description	Image	Suggested components	Tip dimensions	Connectables
	<b>C560-009</b>	Desoldering Tip Ø1,3	 Ø max. pin = 1,1mm	Through hole Desoldering	Ø1,3	Control Units: DI, DDE, DME Tool: DR560 Modules: MVE / MSE (Pump)
	<b>C560-005</b>	Desoldering Tip Ø1,5	 Ø max. pin = 1,3	Through hole Desoldering	Ø1,5	Control Units: DI, DDE, DME Tool: DR560 Modules: MVE / MSE (Pump)
	<b>C560-006</b>	Desoldering Tip Ø1,9	 Ø max. pin = 1,7	Through hole Desoldering	Ø1,9	Control Units: DI, DDE, DME Tool: DR560 Modules: MVE / MSE (Pump)
	<b>C560-007</b>	Desoldering Tip Ø2,4	 Ø max. pin = 2,2	Through hole Desoldering	Ø2,4	Control Units: DI, DDE, DME Tool: DR560 Modules: MVE / MSE (Pump)
	<b>C560-015</b>	Desoldering Tip Ø3	 Ø max. pin = 2,8mm	Through hole Desoldering	Ø3	Control Units: DI, DDE, DME Tool: DR560 Modules: MVE / MSE (Pump)
	<b>C560-011</b>	Desoldering Tip Ø0,6 HT PADS		Pad desoldering	Ø0,6	Control Units: DI, DDE, DME Tool: DR560 Modules: MVE / MSE (Pump)
	<b>C560-012</b>	Desoldering Tip Ø0,8 HT PADS		Pad desoldering	Ø0,8	Control Units: DI, DDE, DME Tool: DR560 Modules: MVE / MSE (Pump)

**C560** Tips for **DR560** Desoldering Iron

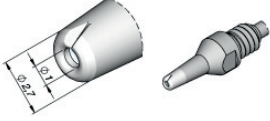
	Ref.	Cartridge & Tip description	Image	Suggested components	Tip dimensions	Connectables
	<b>C560-013</b>	Desoldering Tip Ø1 PADS		Pad desoldering	Ø1	Control Units: DI, DDE, DME Tool: DR560 Modules: MVE / MSE (Pump)