

JBC

www.jbctools.com

INSTRUCTION MANUAL



DDP

2 Tool DDU Precision Rework Station

This manual corresponds to the following references:

DDPE-9QB (100 V)

DDPE-1QB (120 V)

DDPE-2QB (230 V)

Packing List

The following items are included:



Control Unit 1 unit



Stand 1 unit
Ref. AD-SE



Stand 1 unit
Ref. AM-SA



Precision Handle 1 unit
Ref. T210-A



Adjustable Micro Tweezer..... 1 unit
Ref. AM120-A



Cartridge holder 1 unit
Ref. 0021083



Manual Tip Cleaner 1 unit
Ref. CL8499



Sponge 1 unit
Ref. S0354



Brass Wool1 unit
Ref. CL6210



Stand Cable 2 units
Ref. 0024227



Power Cord 1 unit
Ref. 0024077 (100V)
0023717 (120V)
0024080 (230V)



Manual 1 unit
Ref. 0027231

Connections

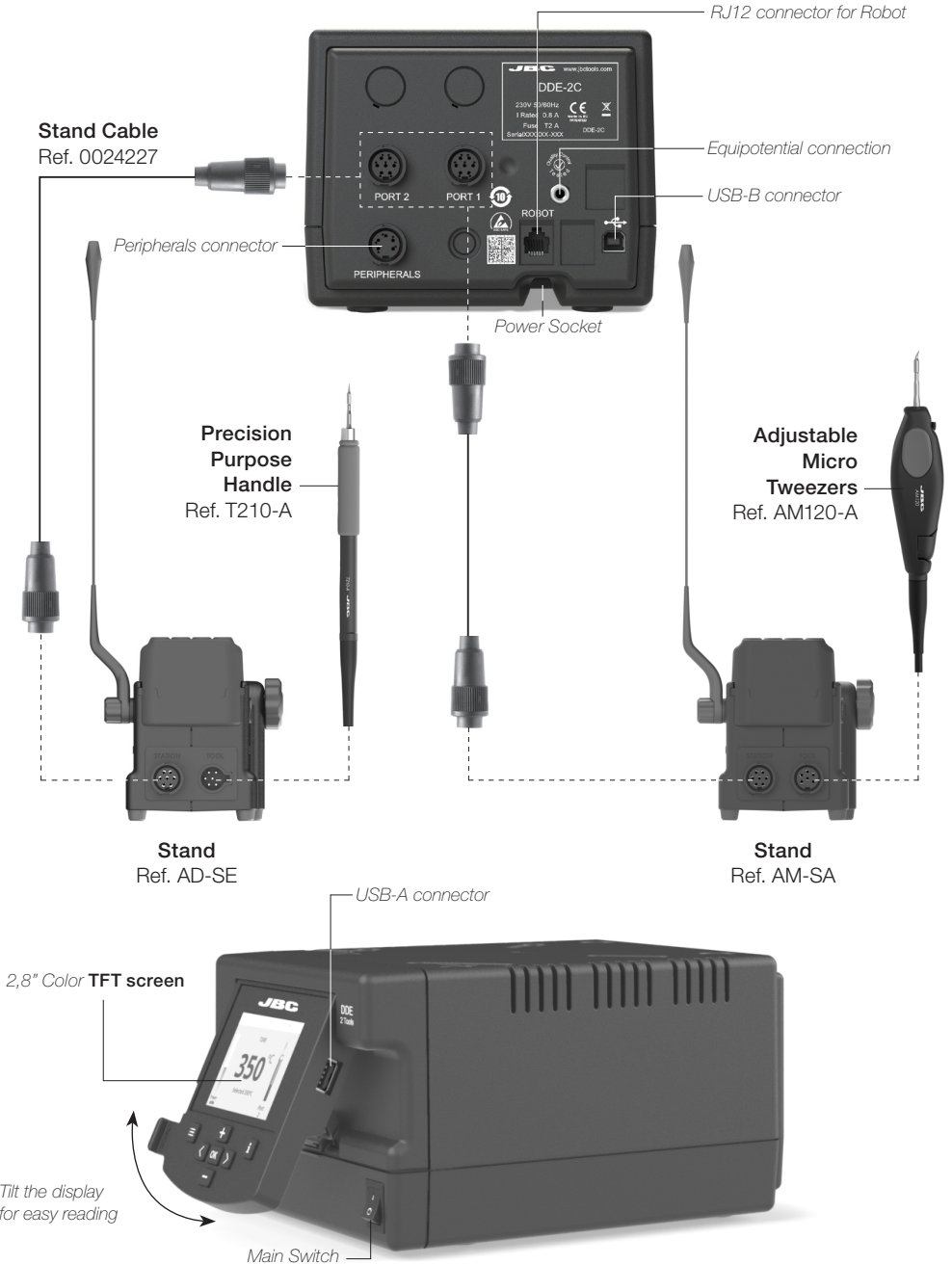

DDU Work Screen

The DDU offers an intuitive user interface which provides quick access to station parameters.
Default PIN: 0105

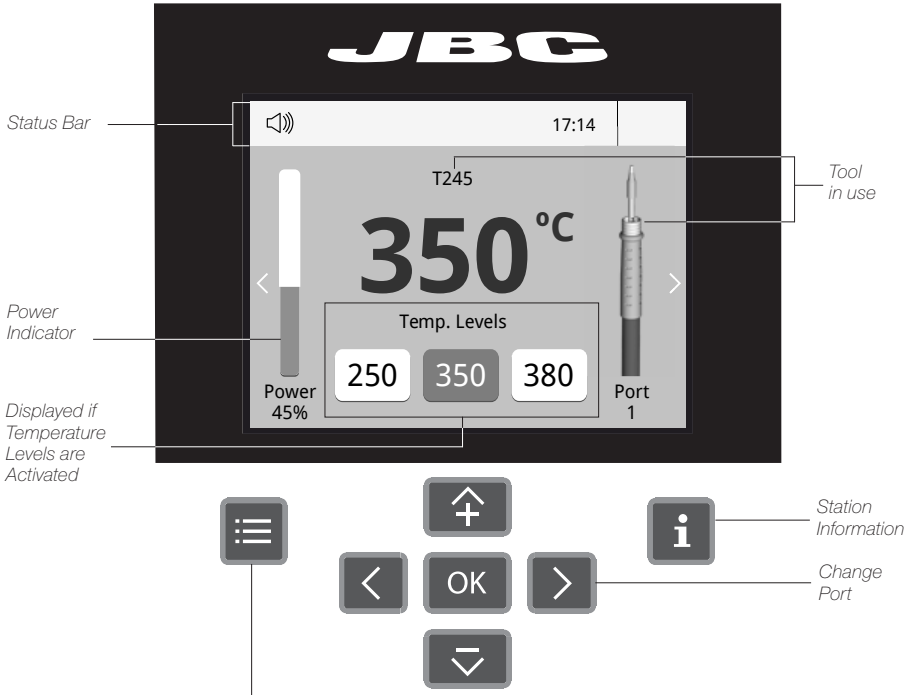

Menu Options



Set the station parameters

Station

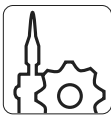

Set the tool parameters

Tools



Display the hours worked in each cycle

Counters



Consult / modify the links of the peripherals connected to the station with the port they are connected to.

Peripherals



It is possible to choose the language from a list.

Language



Allows you to carry out an overall station reset restoring all the parameters to their default values.

Reset

Troubleshooting

Station troubleshooting available on the product page at www.jbctools.com

Advanced Functionalities



Graphics

It provides detailed graphics of tip temperature and power delivery in real time during solder joint formation for analysis purposes. This helps you decide how to adjust your process or which tip to use to obtain the best quality soldering.



Profiles

Designed to avoid thermal shock when soldering Ceramic Chip components like MLCC, this new and unique feature allows controlling the heating ramp up rate of the tool to gradually increase the temperature of the component through all the phases of the soldering process. Up to 25 fully configurable soldering profiles can be stored.



JBC Net

Get greater quality and control in your production. Manage your whole soldering process remotely in real time. For more information see www.jbctools.com/webmanager.html.

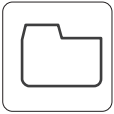

Files

Export graphics
Insert a USB flash drive into the USB-A connector to save your soldering process in csv format.



Update

Station update
Download the JBC Update File from www.jbctools.com/software.html
Insert the USB flash drive with the file downloaded to the station.

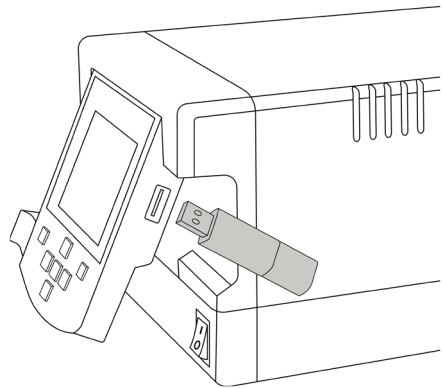

System notifications

The following icons will be displayed on the screen's status bar.



USB flash drive is connected.



Station is controlled by a PC.



Station is controlled by a robot.



Station software update.
Press INFO to start the process.



Warning.
Press INFO for failure description.



Error.
Press INFO for failure description, the type of error and how to proceed.

MSE/MVE Initial Set up (Ref. MSE-A / Ref. MVE-A)*

1. After connecting the module, enter the Peripherals Menu and select the port which you want to join with the module.
2. Select the module from the list of peripheral connections. Remember your first connection is denoted as "a", the second being "b", etc. (e.g. MS_a, MS_b,...).
3. Press Menu or Back to save changes.

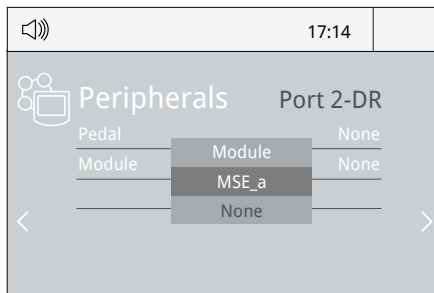

Pedal Initial Set up (Ref. P-005)*

1. Enter the **Peripherals** Menu and **select the port** which you want to join to the pedal.

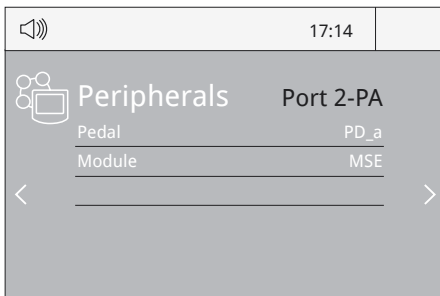

2. Select the pedal from the list (*Note that your first connection is denoted as "a", the second being "b", etc. (e.g. PD_a, PD_b,...).*)

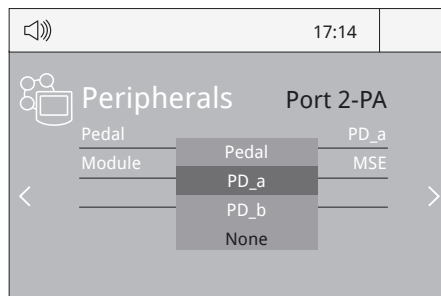

3. Set the pedal function according to your work needs:

Select how the pedal acts: as **Sleep**, **Extractor** (hibernation) or as a **module** switch.

Select the activating mode of the pedal (**pressed/released**)

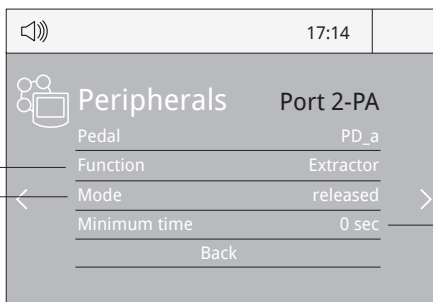

Set the duration of the activation time when pressing the pedal once**. For continuous functioning keep the pedal pressed.

* These references are not included

**NB: The same can be applied inversely when continually pressing the pedal and releasing to activate.

Operation

The JBC Most Efficient Soldering System

Our revolutionary technology is able to recover tip temperature extremely quickly. It means the user can work at a lower temperature and improve the quality of soldering. The tip temperature is further reduced thanks to the Sleep and Hibernation modes which increase up to 5 times the life of the tip.

1. Work

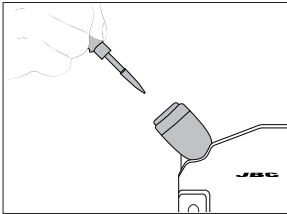

When the tool is lifted from the stand the tip will heat up to the selected temperature.

2. Sleep

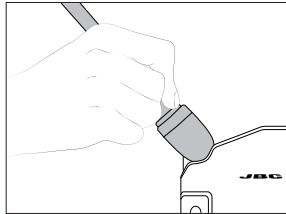

When the tool is in the stand, the temperature falls to the preset Sleep temperature.

3. Hibernation

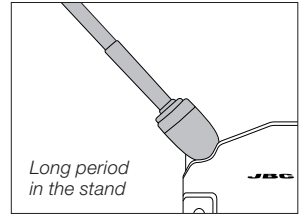

After longer periods of inactivity, the power is cut off and the tool cools down to room temperature.

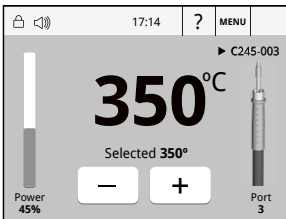

Tools Menu:

- Adjust temperature limits and cartridge.
- Set temperature levels.

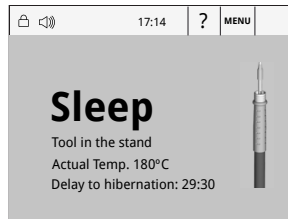

Tools Menu:

- Set Sleep temperature.
- Set Sleep delay. (from 0 to 9 min or no Sleep)

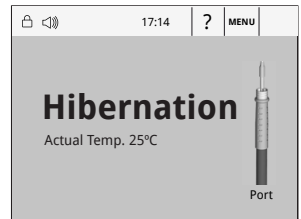

Tools Menu:

- Set Hibernation delay. (from 0 to 60 min or no hibernation)

Changing the Grips

Replace the grips easily using the slip-on tabs. **Note:** Choose the correct grip depending on your handle model.

Handle ref.: T245-A / T245-C / T245-GA	T210-A / T210-NA	T245-PA	T210-PA
Grip ref.: 0016057 (green)	0018658 (green)	0021528 (blue)	0023310 (blue)

1. Inserting Tabs

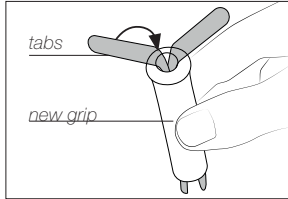

Put the slide-on tabs into the new grip.

2. Inserting Handle

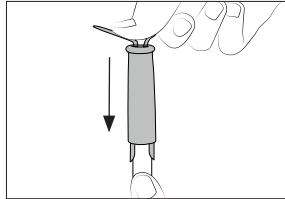

Push the grip with the tabs onto the handle.

3. Removing Tabs

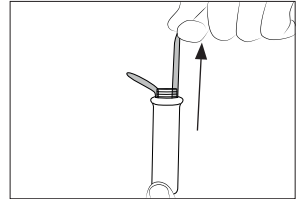

Hold the grip and pull the tab. Use pliers if necessary.

Sealing Plug Replacement

The sealing plug prevents undesirable flux vapors or particles from entering inside the tool. Its usage is highly recommended for intensive applications when soldering is exposed to FOD environments or for applications where the soldering iron works close to vertical position. **Note:** Choose the correct sealing plug depending on your handle model.

Handle ref: T245 / T470	T210
Sealing plug ref.: OB2000	OB1000

 Before replacing the sealing plug, unplug the power supply and make sure the device is not hot.

1. Removing Sealing Plug

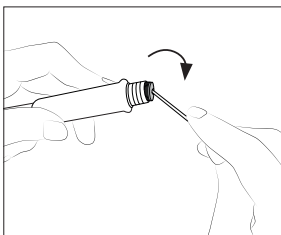

Enter, not deeper than 8mm, a small shaft or screwdriver, lift and pull the sealing plug. Never use a cartridge to do this operation.

2. Mounting Position

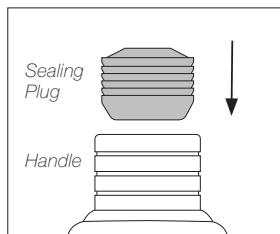

Note: The chamfered side has to be positioned towards the handle.

3. Inserting Sealing Plug

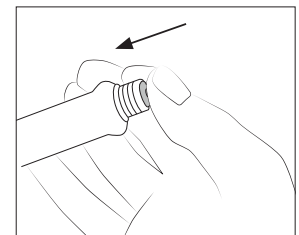

Push the sealing plug inside the handle until the sealing plug and handle edges are aligned.

Quick Tip Changer

Save time and change cartridges safely without switching the station off. Be careful, the cartridges may be hot, when placing them in the storage rack.

1. Removing

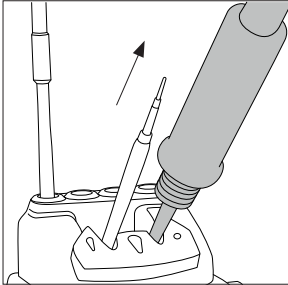

Place the cartridge in the extractor and pull the handle to remove it.

2. Inserting

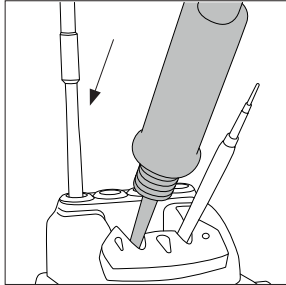

Place the handle on top of the new cartridge and press down.

3. Fixing

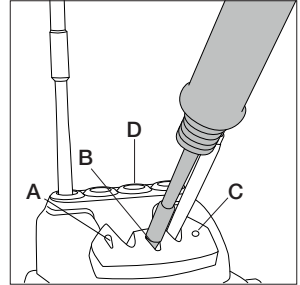

Use the holes to fix the cartridge as follows:

- A.** For curved C210
- B.** For C245
- C.** For straight C210
- D.** cartridge Storage rack

Important: It is essential to insert the cartridge as far as the mark for a proper connection.



AM120 Changing cartridges

1. Removing

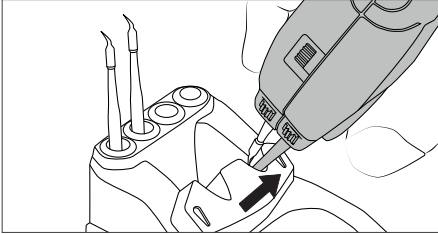

Place the cartridges in the extractor and pull the tweezers to remove them.

3. Inserting

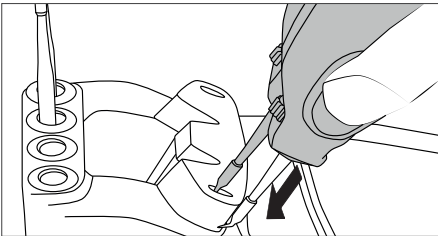

Use the grooves to insert the cartridges as far as the mark*.

2. Positioning

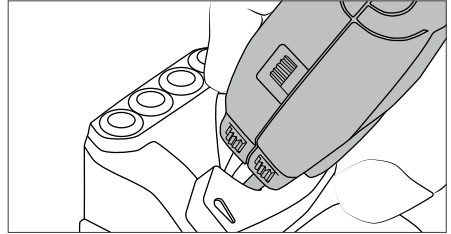

Place the tweezers on top of the new cartridge and slightly press down.

*Important

It is essential to insert the cartridges as far as the mark for a proper connection.

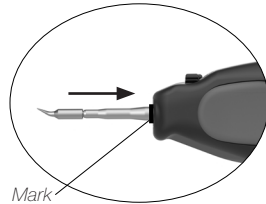

4. Rotational Cartridge Alignment

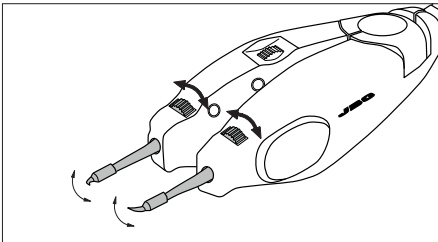

Slightly turn the wheels to align the cartridges as required.

5. Vertical Cartridge Alignment

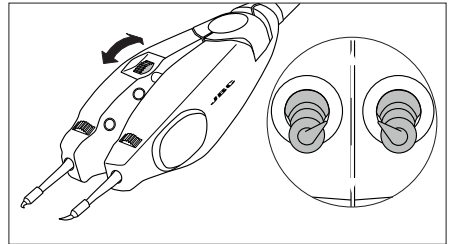

The rear wheel allows the cartridges to be equally aligned when you close the tweezers.

CLM Features

Improve thermal transfer by cleaning the tip after each solder joint.

Brass wool

Ref. CL6210

Very effective cleaning method. It leaves a small layer of solder on the tip to prevent oxidation between cleaning and reflowing.

Splashguard

Ref. 0017576

It prevents splashing of solder particles when using the brass wool.

Antisplash Membrane

Ref. 0017574

Prevents splashing to maintain the work area clean.

ESD Tip Wiper

Ref. CL0240

A temperature resistant receptacle lets the operator remove excess solder by gentle tapping or wiping.

Sponge

Ref. S0354

The least harmful cleaning method. Keep the sponge damp with distilled water when working to avoid tip wear.

Non-slip base

No need to hold the base while cleaning tips.



Tapping:

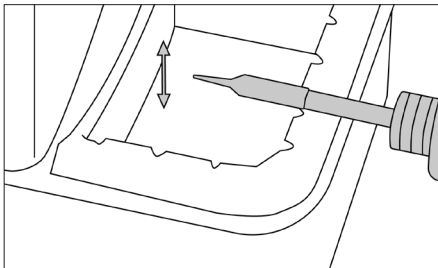

Tap to remove excess solder.

Wiping:

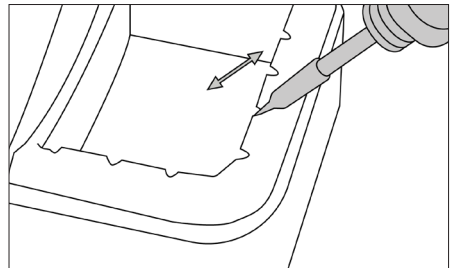

Use the slots to remove remaining particles.

DDU Compatibility

Basic working system				Peripherals			
Control Unit	Stand	Tool	Cartridge Range	MSE	MNE	FAE1 / FAE2	P305
DDU	ADS	T210	C210			●	●
		T245	C245			●	●
	DNS	T210N*	C210		●	●	●
		T245N*	C245				
	APS	AP250	C250			●	●
	AMS	PA120	C120			●	●
	HTS	HT420	C420			●	●
	DSS	DS360	C360	●		●	●
DRS	DR560	C560	●		●	●	

* The MNE Nitrogen Flow Regulator is required.

Maintenance

Before carrying out maintenance or storage, always allow the equipment to cool.

- Clean the station screen with a glass cleaner or a damp cloth.
- Use a damp cloth to clean the casing and the tool. Alcohol can only be used to clean the metal parts.
- Periodically check that the metal parts of the tool and stand are clean so that the station can detect the tool status.
- Maintain tip surface clean and tinned prior to storage in order to avoid tip oxidation. Rusty and dirty surfaces reduce heat transfer to the solder joint.
- Periodically check all cables and tubes.
- Replace a blown fuse as follows:

Clean periodically

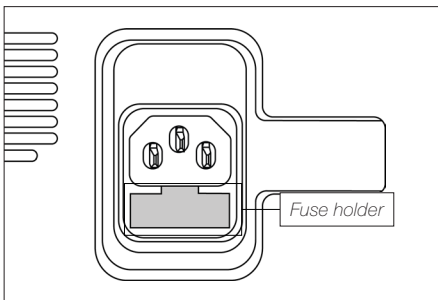
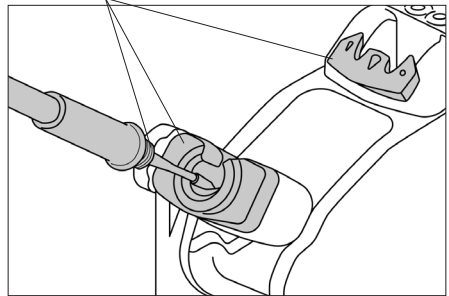

1. Pull off the fuse holder and remove the fuse. If necessary use a tool to lever it off.

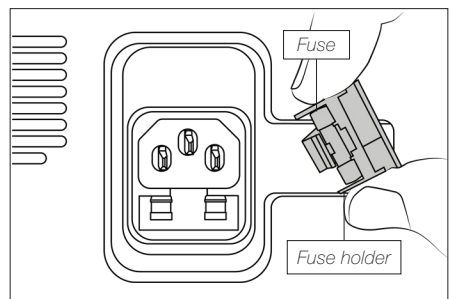

2. Press the new fuse into the fuse holder and replace it in the station.

- Replace any defective or damaged pieces. Use original JBC spare parts only.
- Repairs should only be performed by a JBC authorized technical service.

Safety



It is imperative to follow safety guidelines to prevent electric shock, injury, fire or explosion.

- Do not use the units for any purpose other than soldering or rework. Incorrect use may cause fire.
- The power cord must be plugged into approved bases. Be sure that it is properly grounded before use. When unplugging it, hold the plug, not the wire.
- Do not work on electrically live parts.
- The tool should be placed in the stand when not in use in order to activate the sleep mode. The soldering tip, the metal part of the tool and the stand may still be hot even when the station is turned off. Handle with care, including when adjusting the stand position.
- Do not leave the appliance unattended when it is on.
- Do not cover the ventilation grills. Heat can cause inflammable products to ignite.
- Avoid flux coming into contact with skin or eyes to prevent irritation.
- Be careful with the fumes produced when soldering.
- Keep your workplace clean and tidy. Wear appropriate protective glasses and gloves when working to avoid personal harm.
- Utmost care must be taken with liquid tin waste which can cause burns.
- This appliance can be used by children over the age of eight and also persons with reduced physical, sensory or mental capabilities or lack of experience provided that they have been given adequate supervision or instruction concerning use of the appliance and understand the hazards involved. Children must not play with the appliance.
- Maintenance must not be carried out by children unless supervised.

有害物质含量表

产品中有害物质的名称及含量

部件名称	有害物质					
	铅(Pb)	汞(Hg)	镉(Cd)	六价铬 (Cr(VI))	多溴联苯 (PBB)	多溴二苯醚 (PBDE)
烙铁头	○	○	○	○	○	○
手柄	○	○	○	○	○	○
电源线	○	○	○	○	○	○
主机	○	○	○	○	○	○
电源插座	○	○	○	○	○	○
保险丝	○	○	○	○	○	○
主开关	○	○	○	○	○	○
电位连接	X	○	○	○	○	○
变压器	○	○	○	○	○	○
线路板	X	○	○	○	○	○

○ 表示该有害物质在该部件所有均质材料中的含量均在GB/T 26572 规定的限量要求以下。
X 表示该有害物质至少在该部件的某一均质材料中的含量超出GB/T 26572 规定的限量要求。

Specifications

DDP

2-Tools DDU Precision Station

Ref.: **DDPE-9QB** / **DDPE-1QB** / **DDPE-2QB**

DDU

2-Tool Control Unit

Ref.: **DDE-9C** 100V 50/60Hz. Input fuse: T5A. Output: 23.5V
Ref.: **DDE-1C** 120V 50/60Hz. Input fuse: T4A. Output: 23.5V
Ref.: **DDE-2C** 230V 50/60Hz. Input fuse: T2A. Output: 23.5V

- Output Peak Power: 150W per tool
- Temperature Range: 90 - 450 °C / 190 - 840 °F
- Idle Temp. Stability (still air): $\pm 1.5^{\circ}\text{C}$ / $\pm 3^{\circ}\text{F}$ / Meets and exceed IPC J-STD-001F
- Temp Accuracy: $\pm 3\%$ (using reference cartridge)
- Temp Adjustment: $\pm 50^{\circ}\text{C}$ / $\pm 90^{\circ}\text{F}$ Through station menu setting
- Tip to Ground Voltage/Resistance: Meets and exceed
ANSI/ESD S20.20-2014 IPC J-STD-001F
- Ambient Operating Temp: 10 - 50 °C / 50 - 122 °F
- Connections: USB-A / USB-B / Peripherals connectors
RJ12 connector for Robot
- Control Unit Dimensions/Weight: 148 x 232 x 120 mm / 3.82 kg
(L x W x H) 5.8 x 9.1 x 4.7 in / 8.41 lb

DDP

- Total Net Weight: 7.78 kg / 17.15 lb
- Total Package Dimensions/Weight: 368 x 474 x 195 mm / 8.79 kg
(L x W x H) 14.5 x 18.7 x 7.7 in / 19.37 lb

Complies with CE standards.
ESD protected.

JBC

Warranty

JBC's 2 year warranty covers this equipment against all manufacturing defects, including the replacement of defective parts and labour.

Warranty does not cover product wear or misuse.

In order for the warranty to be valid, equipment must be returned, postage paid, to the dealer where it was purchased.

Get 1 extra year JBC warranty by registering here:
<https://www.jbctools.com/productregistration/>
within 30 days of purchase.



This product should not be thrown in the garbage.

In accordance with the European directive 2012/19/EU, electronic equipment at the end of its life must be collected and returned to an authorized recycling facility.



www.jbctools.com