

GSFR XX V LL







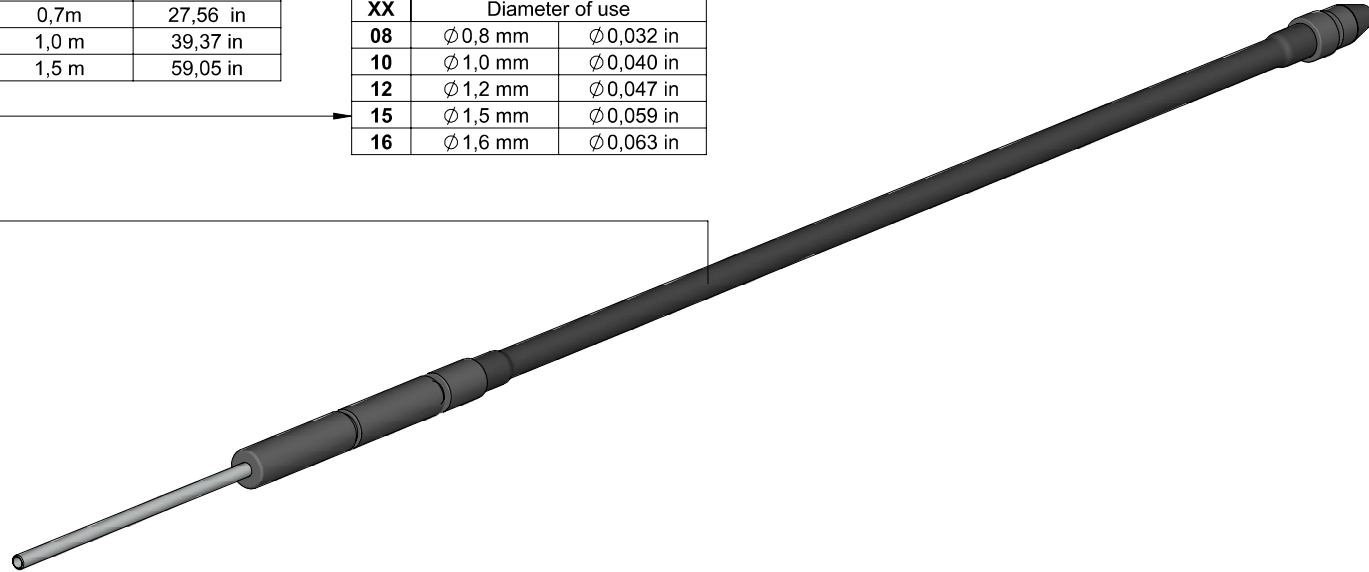

WITH SOLDER WIRE PERFORATION

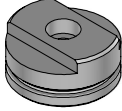
Tube length		
LL	Length	
03	0,3 m	11,81 in
04	0,4 m	15,75 in
05	0,5 m	19,69 in
07	0,7m	27,56 in
10	1,0 m	39,37 in
15	1,5 m	59,05 in

Wire diameter		
XX	Diameter of use	
08	Ø 0,8 mm	Ø 0,032 in
10	Ø 1,0 mm	Ø 0,040 in
12	Ø 1,2 mm	Ø 0,047 in
15	Ø 1,5 mm	Ø 0,059 in
16	Ø 1,6 mm	Ø 0,063 in

Guide kit Ref.	Guide tube Ref.
GSFR08X03	0025344
GSFR08X05	0025311
GSFR08X07	0025345
GSFR08X10	0025346
GSFR10X03	0025347
GSFR10X10	0025348
GSFR12X03	0025349
GSFR12X10	0025350
GSFR15X03	0025351
GSFR15X04	0025352
GSFR15X05	0025353
GSFR15X10	0025354
GSFR16X03	0025355
GSFR16X04	0025776



	Outlet nozzle Ref.	Guide wheel Ref.	Blade Ref.	Blade clamp Ref.	Inlet nozzle Ref. (for SFR-A)	Intern. nozzle Ref.	Inlet nozzle Ref. (for SFR-B)	Counter wheel Ref.	Screws Ref.	Threaded stud Ref.
<i>Tube length</i>										
<i>Wire Ø</i>										
GSFR08VLL	0025270	0021696	0021555	0018638	0023740	0024955	0024876	0026693 (Provide with SFR)	0026695 (x2)	0026696 (x3)
GSFR10VLL	0021560	0021699			0023741	0024956	0024877			
GSFR12VLL	0025272	0023738			0023736	0024957	0024878			
GSFR15VLL	0025274	0025285			0023855	0024958	0026698			
GSFR16VLL	0025276	0025922			-	0024959	0026697			